

**ELECTROMAGNETIC EMISSIONS COMPLIANCE REPORT
INTENTIONAL RADIATOR CERTIFICATION TO
FCC PART 15 SUBPART C REQUIREMENT**

OF

Keychain speaker

Model No.: P328.012, SL175

Trademark: N/A

FCC ID: 2ABHA0047

Report No.: ES180926035E

Issue Date: September 29, 2018

Prepared for

**Ningbo Cstar Imp & Exp CO., LTD
Floor 4, Building E, No. 655-90, Qiming Road, Yinzhou Investment
& Innovation Center, Ningbo, China**

Prepared by

EMTEK(SHENZHEN) CO., LTD.

**Bldg 69, Majialong Industry Zone, Nanshan District, Shenzhen,
Guangdong, China.**

TEL: 86-755-26954280

FAX: 86-755-26954282

**This report shall not be reproduced, except in full, without the written approval of
EMTEK(SHENZHEN) CO., LTD.**

VERIFICATION OF COMPLIANCE

| | |
|----------------------|-------------------------------------------------------------------------------------------------------------------------------------|
| Applicant: | Ningbo Cstar Imp & Exp CO., LTD Floor 4,Building E, No. 655-90,Qiming Road, Yinzhou Investment &Innovation Center, Ningbo, China |
| Manufacturer: | Ningbo Cstar Imp & Exp CO., LTD Floor 4,Building E, No. 655-90,Qiming Road, Yinzhou Investment &Innovation Center, Ningbo, China |
| Product Description: | Keychain speaker |
| Trade Mark: | N/A |
| Model Number: | P328.012, SL175 (Note: These models are same except model number and appearance, here model:SL175 was selected for full test.) |

We hereby certify that:

The above equipment was tested by EMTEK(SHENZHEN) CO., LTD. The test data, data evaluation, test procedures, and equipment configurations shown in this report were made in accordance with the procedures given in ANSI C63.10-2013 and the energy emitted by the sample EUT tested as described in this report is in compliance with conducted and radiated emission limits of FCC Rules Part 15.247(2017).

Date of Test : September 26, 2018 to September 29, 2018



Prepared by : _____
Yaping Shen/Editor



Reviewer : _____
Joe Xia/Supervisor



Approved & Authorized Signer : _____
Lisa Wang/Manager

Modified Information

| Version | Summary | Revision Date | Report No. |
|---------|-----------------|---------------|--------------|
| Ver.1.0 | Original Report | / | ES180926035E |
| | | | |
| | | | |
| | | | |
| | | | |
| | | | |
| | | | |
| | | | |

Table of Contents

| | |
|-------------------------------------------------------|-----------|
| 1. GENERAL INFORMATION..... | 6 |
| 1.1 PRODUCT DESCRIPTION..... | 6 |
| 1.2 EST FACILITY | 7 |
| 2. SYSTEM TEST CONFIGURATION..... | 8 |
| 2.1 EUT CONFIGURATION..... | 8 |
| 2.2 EUT EXERCISE | 8 |
| 2.3 TEST PROCEDURE | 8 |
| 2.4 CONFIGURATION OF TESTED SYSTEM..... | 9 |
| 3. SUMMARY OF TEST RESULTS..... | 10 |
| 4. DESCRIPTION OF TEST MODES..... | 11 |
| 5. TEST SYSTEM UNCERTAINTY..... | 13 |
| 6. CONDUCTED EMISSIONS TEST..... | 14 |
| 6.1 MEASUREMENT PROCEDURE:..... | 14 |
| 6.2 TEST SET-UP (BLOCK DIAGRAM OF CONFIGURATION)..... | 14 |
| 6.3 MEASUREMENT EQUIPMENT USED:..... | 14 |
| 6.4 MEASUREMENT RESULT:..... | 14 |
| 6.5 CONDUCTED MEASUREMENT PHOTOS:..... | 17 |
| 7. RADIATED EMISSION TEST..... | 18 |
| 7.1 MEASUREMENT PROCEDURE..... | 18 |
| 7.2 TEST SET-UP (BLOCK DIAGRAM OF CONFIGURATION)..... | 20 |
| 7.3 MEASUREMENT EQUIPMENT USED:..... | 21 |
| 7.4 RADIATED EMISSION LIMIT..... | 22 |
| 7.5 MEASUREMENT RESULT..... | 23 |
| 7.5 RADIATED MEASUREMENT PHOTOS:..... | 29 |
| 8. CHANNEL SEPARATION TEST..... | 30 |
| 8.1 MEASUREMENT PROCEDURE..... | 30 |
| 8.2 TEST SET-UP (BLOCK DIAGRAM OF CONFIGURATION)..... | 30 |
| 8.3 MEASUREMENT EQUIPMENT USED:..... | 30 |
| 8.4 MEASUREMENT RESULTS:..... | 30 |
| 9. 20DB BANDWIDTH TEST..... | 35 |
| 9.1 MEASUREMENT PROCEDURE..... | 35 |
| 9.2 TEST SET-UP (BLOCK DIAGRAM OF CONFIGURATION)..... | 35 |
| 9.3 MEASUREMENT EQUIPMENT USED:..... | 35 |
| 9.4 MEASUREMENT RESULTS:..... | 35 |
| 10. QUANTITY OF HOPPING CHANNEL TEST..... | 40 |

10.1 MEASUREMENT PROCEDURE 40

10.2 TEST SET-UP (BLOCK DIAGRAM OF CONFIGURATION)..... 40

10.3 MEASUREMENT EQUIPMENT USED: 40

10.4 MEASUREMENT RESULTS:..... 40

11. TIME OF OCCUPANCY (DWELL TIME) TEST 41

11.1 TEST DESCRIPTION 41

11.2 TEST SET-UP (BLOCK DIAGRAM OF CONFIGURATION)..... 41

11.3 MEASUREMENT EQUIPMENT USED:..... 41

11.4 TEST REQUIREMENTS / LIMITS 41

11.5 TEST RESULT..... 42

12. MAXIMUM PEAK OUTPUT POWER TEST 44

12.1 MEASUREMENT PROCEDURE 44

12.2 TEST SET-UP (BLOCK DIAGRAM OF CONFIGURATION)..... 44

12.3 MEASUREMENT EQUIPMENT USED:..... 44

12.4 MEASUREMENT RESULTS:..... 45

13. BAND EDGE TEST 49

13.1 MEASUREMENT PROCEDURE 49

13.2 TEST SET-UP (BLOCK DIAGRAM OF CONFIGURATION)..... 50

13.3 MEASUREMENT EQUIPMENT USED:..... 50

13.4 MEASUREMENT RESULTS:..... 51

14. ANTENNA APPLICATION 65

14.1 ANTENNA REQUIREMENT 65

14.2 RESULT..... 65

Appendix I (Photos of EUT) (3 pages)

1. GENERAL INFORMATION

1.1 Product Description

| Characteristics | Description |
|---------------------------|-------------------------------------------|
| Product Name | Keychain speaker |
| Model number | SL175 |
| Input rating | DC 5V from adapter or DC 3.7V battery |
| Power Supply | AC 120V/60Hz for adapter, DC 3.7V Battery |
| Kind of Device | Bluetooth Ver 4.2 |
| Modulation | GFSK, $\pi/4$ -DQPSK |
| Operating Frequency Range | 2402-2480MHz |
| Number of Channels | 79 |
| Transmit Power Max(PK) | 3.16dBm(0.002070W) |
| Antenna Type | Internal PCB antenna |
| Antenna Gain | -0.58dBi |

1.2 Test Facility

Site Description

- EMC Lab. : Accredited by CNAS, 2016.10.24
The certificate is valid until 2022.10.28
The Laboratory has been assessed and proved to be in compliance with CNAS-CL01:2006 (identical to ISO/IEC 17025:2005)
The Certificate Registration Number is L2291.
- Accredited by TUV Rheinland Shenzhen 2016.5.19
The Laboratory has been assessed according to the requirements ISO/IEC 17025.
- Accredited by FCC, August 03, 2017
Designation Number: CN1204
Test Firm Registration Number: 882943
- Accredited by Industry Canada, November 24, 2015
The Certificate Registration Number is 4480A.
- Accredited by A2LA, July 31, 2017
The Certificate Number is 4321.01.
- Name of Firm : EMTEK(SHENZHEN) CO., LTD.
- Site Location : Bldg 69, Majialong Industry Zone, Nanshan District, Shenzhen, Guangdong, China.

2. System Test Configuration

2.1 EUT Configuration

The EUT configuration for testing is installed on RF field strength measurement to meet the Commissions requirement and operating in a manner which intends to maximize its emission characteristics in a continuous normal application.

2.2 EUT Exercise

The Transmitter was operated in the normal operating mode. The Tx frequency was fixed which was for the purpose of the measurements.

2.3 Test Procedure

2.3.1 Conducted Emissions

The EUT is placed on a turn table which is 0.8 m above ground plane. According to the requirements in Section 13.1.4.1 of ANSI C63.10-2013. Conducted emissions from the EUT measured in the frequency range between 0.15 MHz and 30MHz using CISPR Quasi-Peak and average detector mode.

2.3.2 Radiated Emissions

Below 1000MHz, The EUT was placed on a turn table which is 0.8m above ground plane. And above 1000MHz, The EUT was placed on a styrofoam table which is 1.5m above ground plane. The turn table shall rotate 360 degrees to determine the position of maximum emission level. EUT is set 3m away from the receiving antenna which varied from 1m to 4m to find out the highest emission. And also, each emission was to be maximized by changing the polarization of receiving antenna both horizontal and vertical. In order to find out the max. emission, the relative positions of EUT was rotated according to the requirements in Section 13.1.4.1 of ANSI C63.10-2013.

2.4 Configuration of Tested System

Fig. 2-1 Configuration of Tested System

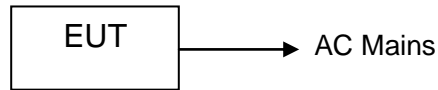

Table 2-1 Equipment Used in Tested System

| Item | Equipment | Trade Mark | Model No. | FCC ID | Note |
|------|------------------|------------|--------------|-----------|---------------------------------|
| 1. | Keychain speaker | N/A | SL175 | 2ABHA0047 | <i>EUT</i> |
| 2 | Adapter | N/A | YSV6-0501000 | N/A | <i>Support Equipment</i> |

Note:

- (1) Unless otherwise denoted as EUT in 『Remark』 column , device(s) used in tested system is a support equipment.

3. Summary of Test Results

| FCC Rules | Description Of Test | Result |
|--------------------|-------------------------------|---------------|
| §15.207 | AC Power Conducted Emission | Compliant |
| §15.247(d),§15.209 | Radiated Emission | Compliant |
| §15.247(a)(1) | Channel Separation test | Compliant |
| §15.247(a)(1) | 20dB Bandwidth | Compliant |
| §15.247(a)(1)(iii) | Quantity of Hopping Channel | Compliant |
| §15.247(a)(1)(iii) | Time of Occupancy(Dwell Time) | Compliant |
| §15.247(b) | Max Peak output Power test | Compliant |
| §15.247(d) | Band edge test | Compliant |
| §15.203 | Antenna Requirement | Compliant |

4. Description of test modes

The EUT has been tested under its typical operating condition. Pre-defined engineering program for regulatory testing used to control the EUT for staying in continuous transmitting. Only the worst case data were reported.

The EUT has been associated with peripherals pursuant to ANSI C63.10-2013 and configuration operated in a manner tended to maximize its emission characteristics in a typical application. Frequency range investigated: radiation (9 KHz to the 10th harmonic of the highest fundamental frequency or to 40 GHz, whichever is lower).

The details of test channels and bandwidth were for RF conductive measurement.

Channel List:

| Channel | Frequency (MHz) | Channel | Frequency (MHz) | Channel | Frequency (MHz) |
|-----------|-----------------|-----------|-----------------|-----------|-----------------|
| 01 | 2402 | 28 | 2429 | 55 | 2456 |
| 02 | 2403 | 29 | 2430 | 56 | 2457 |
| 03 | 2404 | 30 | 2431 | 57 | 2458 |
| 04 | 2405 | 31 | 2432 | 58 | 2459 |
| 05 | 2406 | 32 | 2433 | 59 | 2460 |
| 06 | 2407 | 33 | 2434 | 60 | 2461 |
| 07 | 2408 | 34 | 2435 | 61 | 2462 |
| 08 | 2409 | 35 | 2436 | 62 | 2463 |
| 09 | 2410 | 36 | 2437 | 63 | 2464 |
| 10 | 2411 | 37 | 2438 | 64 | 2465 |
| 11 | 2412 | 38 | 2439 | 65 | 2466 |
| 12 | 2413 | 39 | 2440 | 66 | 2467 |
| 13 | 2414 | 40 | 2441 | 67 | 2468 |
| 14 | 2415 | 41 | 2442 | 68 | 2469 |
| 15 | 2416 | 42 | 2443 | 69 | 2470 |
| 16 | 2417 | 43 | 2444 | 70 | 2471 |
| 17 | 2418 | 44 | 2445 | 71 | 2472 |
| 18 | 2419 | 45 | 2446 | 72 | 2473 |
| 19 | 2420 | 46 | 2447 | 73 | 2474 |
| 20 | 2421 | 47 | 2448 | 74 | 2475 |
| 21 | 2422 | 48 | 2449 | 75 | 2476 |
| 22 | 2423 | 49 | 2450 | 76 | 2477 |
| 23 | 2424 | 50 | 2451 | 77 | 2478 |
| 24 | 2425 | 51 | 2452 | 78 | 2479 |
| 25 | 2426 | 52 | 2453 | 79 | 2480 |
| 26 | 2427 | 53 | 2454 | | |
| 27 | 2428 | 54 | 2455 | | |

Note:

Test of channel was included the lowest 2402MHz, middle 2441MHz and highest frequency 2480MHz in highest data rate and to perform the test, then record on this report.

5. TEST SYSTEM UNCERTAINTY

The following measurement uncertainty levels have been estimated for tests performed on the apparatus:

| Parameter | Uncertainty |
|--------------------------------|-------------------------|
| Radio Frequency | $\pm 1 \times 10^{-5}$ |
| Maximum Peak Output Power Test | $\pm 1.0\text{dB}$ |
| Conducted Emissions Test | $\pm 2.0\text{dB}$ |
| Radiated Emission Test | $\pm 2.0\text{dB}$ |
| Power Density | $\pm 2.0\text{dB}$ |
| Occupied Bandwidth Test | $\pm 1.0\text{dB}$ |
| Band Edge Test | $\pm 3\text{dB}$ |
| All emission, radiated | $\pm 3\text{dB}$ |
| Antenna Port Emission | $\pm 3\text{dB}$ |
| Temperature | $\pm 0.5^\circ\text{C}$ |
| Humidity | $\pm 3\%$ |

Remark: The coverage Factor ($k=2$), and measurement Uncertainty for a level of Confidence of 95%

6. Conducted Emissions Test

6.1 Measurement Procedure:

1. The EUT was placed on a table, which is 0.8m above ground plane.
2. Maximum procedure was performed on the six highest emissions to ensure EUT compliance.
3. Repeat above procedures until all frequency measured was complete.

6.2 Test SET-UP (Block Diagram of Configuration)

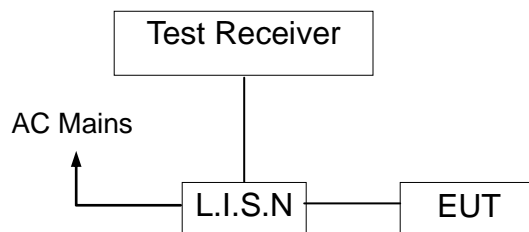

6.3 Measurement Equipment Used:

| Conducted Emission Test Site | | | | | | |
|------------------------------|-----------------|--------------|---------------|-----------------|------------|------------|
| EQUIPMENT TYPE | MFR | MODEL NUMBER | SERIAL NUMBER | Characteristics | Last Cal. | Due date |
| Test Receiver | Rohde & Schwarz | ESCS30 | 100018 | 9kHz~3GHz | 05/16/2018 | 05/15/2019 |
| L.I.S.N | Rohde & Schwarz | ENV216 | 100017 | 9KHz-300MHz | 05/16/2018 | 05/15/2019 |
| RF Switching Unit | CDS | RSU-M2 | 38401 | 9KHz-300MHz | 05/16/2018 | 05/15/2019 |
| Coaxial Cable | CDS | 79254 | 46107086 | 9kHz~3GHz | 05/16/2018 | 05/15/2019 |

6.4 Measurement Result:

Pass.

All the modulation modes were tested the data of the worst mode ($\Pi/4$ -DQPSK TX 2402MHz) are recorded in the following pages and the others modulation methods do not exceed the limits.

Please refer to the following data.

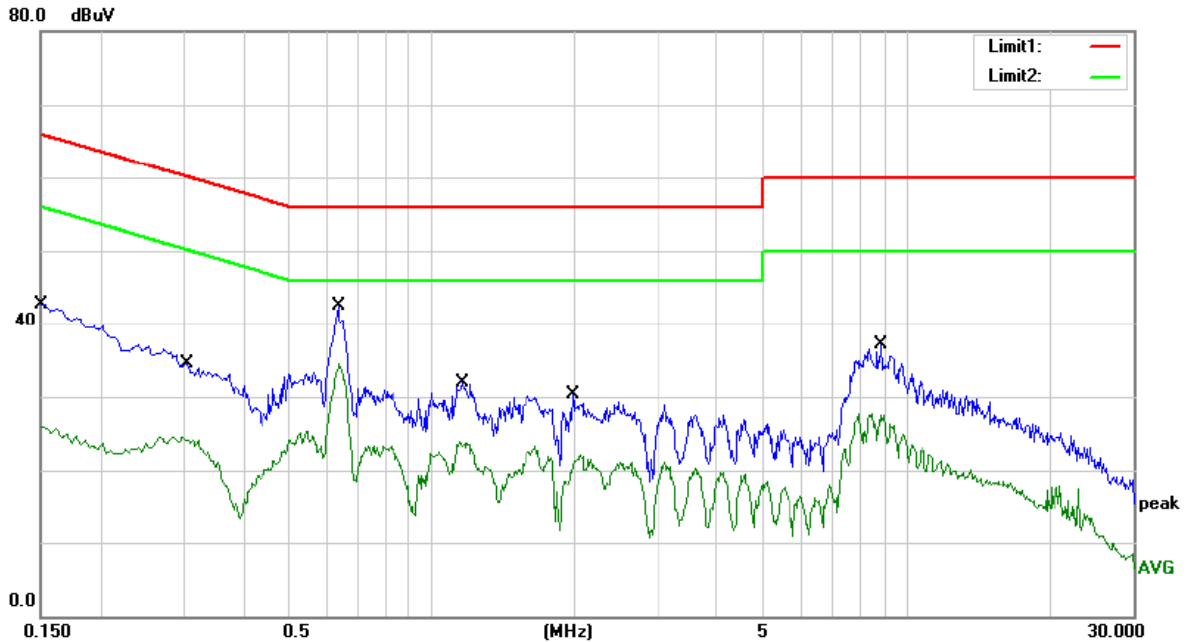

Site site #1 Phase: **N** Temperature: 25
 Limit: (CE)FCC PART 15 C_QP Power: AC 120V/60Hz Humidity: 55 %
 Mode: TX2402
 Note:

| No. | Mk. | Freq. | Reading Level | Correct Factor | Measurement | Limit | Over | Detector | Comment |
|-----|-----|--------|---------------|----------------|-------------|-------|--------|----------|---------|
| | | MHz | dBuV | dB | dBuV | dBuV | dB | | |
| 1 | | 0.1500 | 31.50 | 9.78 | 41.28 | 66.00 | -24.72 | QP | |
| 2 | | 0.1500 | 16.17 | 9.78 | 25.95 | 56.00 | -30.05 | AVG | |
| 3 | | 0.3060 | 22.77 | 9.81 | 32.58 | 60.08 | -27.50 | QP | |
| 4 | | 0.3060 | 14.66 | 9.81 | 24.47 | 50.08 | -25.61 | AVG | |
| 5 | | 0.6340 | 30.35 | 9.84 | 40.19 | 56.00 | -15.81 | QP | |
| 6 | * | 0.6340 | 24.72 | 9.84 | 34.56 | 46.00 | -11.44 | AVG | |
| 7 | | 1.1620 | 20.14 | 9.84 | 29.98 | 56.00 | -26.02 | QP | |
| 8 | | 1.1620 | 14.06 | 9.84 | 23.90 | 46.00 | -22.10 | AVG | |
| 9 | | 1.9900 | 18.84 | 9.84 | 28.68 | 56.00 | -27.32 | QP | |
| 10 | | 1.9900 | 12.30 | 9.84 | 22.14 | 46.00 | -23.86 | AVG | |
| 11 | | 8.8380 | 25.69 | 9.95 | 35.64 | 60.00 | -24.36 | QP | |
| 12 | | 8.8380 | 17.64 | 9.95 | 27.59 | 50.00 | -22.41 | AVG | |

:Maximum data x:Over limit !:over margin Comment: Factor build in receiver. Operator: wu

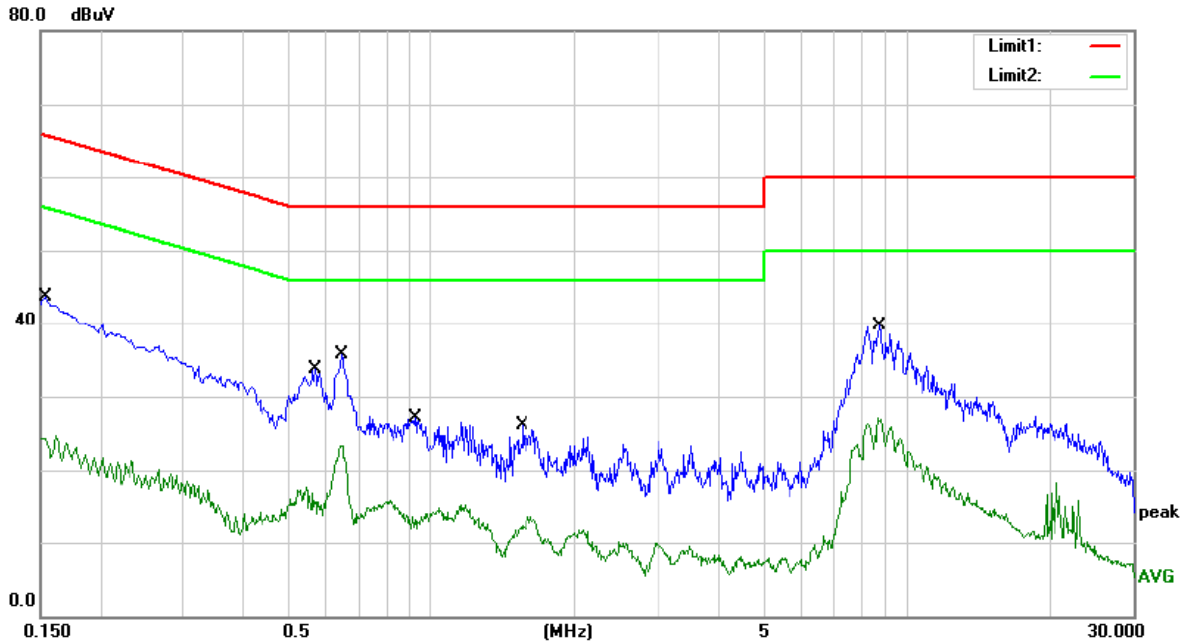

Site site #1 Phase: **L1** Temperature: 25
 Limit: (CE)FCC PART 15 C_QP Power: AC 120V/60Hz Humidity: 55 %
 Mode: TX2402
 Note:

| No. | Mk. | Freq. MHz | Reading Level dBuV | Correct Factor dB | Measure- ment dBuV | Limit dBuV | Over dB | Detector | Comment |
|-----|-----|--------------|--------------------------|-------------------------|--------------------------|---------------|------------|----------|---------|
| 1 | | 0.1540 | 32.37 | 9.78 | 42.15 | 65.78 | -23.63 | QP | |
| 2 | | 0.1540 | 14.95 | 9.78 | 24.73 | 55.78 | -31.05 | AVG | |
| 3 | | 0.5700 | 22.31 | 9.84 | 32.15 | 56.00 | -23.85 | QP | |
| 4 | | 0.5700 | 7.57 | 9.84 | 17.41 | 46.00 | -28.59 | AVG | |
| 5 | * | 0.6460 | 24.74 | 9.84 | 34.58 | 56.00 | -21.42 | QP | |
| 6 | | 0.6460 | 13.53 | 9.84 | 23.37 | 46.00 | -22.63 | AVG | |
| 7 | | 0.9260 | 16.50 | 9.84 | 26.34 | 56.00 | -29.66 | QP | |
| 8 | | 0.9260 | 5.31 | 9.84 | 15.15 | 46.00 | -30.85 | AVG | |
| 9 | | 1.5580 | 15.53 | 9.84 | 25.37 | 56.00 | -30.63 | QP | |
| 10 | | 1.5580 | 3.62 | 9.84 | 13.46 | 46.00 | -32.54 | AVG | |
| 11 | | 8.7380 | 27.94 | 9.95 | 37.89 | 60.00 | -22.11 | QP | |
| 12 | | 8.7380 | 17.17 | 9.95 | 27.12 | 50.00 | -22.88 | AVG | |

*:Maximum data x:Over limit !:over margin Comment: Factor build in receiver. Operator: wu

6.5 Conducted Measurement Photos:



7. Radiated Emission Test

7.1 Measurement Procedure

1. The testing follows the guidelines in Spurious Radiated Emissions of ANSI C63.10-2013.
2. Below 1000MHz, The EUT was placed on a turn table which is 0.8m above ground plane. And above 1000MHz, The EUT was placed on a Styrofoam table which is 1.5m above ground plane.
3. The EUT was set 3 meters from the interference receiving antenna, which was mounted on the top of a variable height antenna tower.
4. For each suspected emission, the EUT was arranged to its worst case and then tune the Antenna tower (From 1m to 4m) and turntable (from 0 degree to 360 degree) to find the maximum reading. A pre-amp and a high pass filter are used for the test in order to get better signal level to comply with the guidelines.
5. Set to the maximum power setting and enable the EUT transmit continuously.
6. Final measurement (Above 1GHz): The frequency range will be divided into different sub ranges depending of the frequency range of the used horn antenna. The EMI Receiver set to peak and average mode and a resolution bandwidth of 1MHz. The measurement will be performed in horizontal and vertical polarization of the measuring antenna and while rotating the EUT in its vertical axis in the range of 0 degree to 360 degree in order to have the antenna inside the cone of radiation.
7. Test Procedure of measurement (For Above 1GHz):
 - 1) Monitor the frequency range at horizontal polarization and move the antenna over all sides of the EUT(if necessary move the EUT to another orthogonal axis).
 - 2) Change the antenna polarization and repeat 1) with vertical polarization.
 - 3) Make a hardcopy of the spectrum.
 - 4) Measure the frequency of the detected emissions with a lower span and resolution bandwidth to increase the accuracy and note the frequency value.
 - 5) Change the analyser mode to Clear/ Write and found the cone of emission.
 - 6) Rotate and move the EUT, so that the measuring distance can be enlarged to 3m and the antenna will be still inside the cone of emission.
 - 7) Measure the level of the detected frequency with the correct resolution bandwidth, with the antenna polarization and azimuth and the peak and average detector, which causes the maximum emission.
 - 8) Repeat steps 1) to 7) for the next antenna spot if the EUT is larger than the antenna beamwidth.

Use the following spectrum analyzer settings:

When spectrum scanned from 30MHz to 1GHz setting resolution bandwidth 120KHz and video bandwidth 300KHz:

| EMI Test Receiver | Setting |
|-------------------|----------|
| Attenuation | Auto |
| RB | 120KHz |
| VB | 300KHz |
| Detector | QP |
| Trace | Max hold |

When spectrum scanned above 1GHz setting resolution bandwidth 1MHz, video bandwidth 3MHz:

| EMI Test Receiver | Setting |
|-------------------|----------|
| Attenuation | Auto |
| RB | 1MHz |
| VB | 3MHz |
| Detector | Peak |
| Trace | Max hold |

When spectrum scanned above 1GHz setting resolution bandwidth 1MHz, video bandwidth 10Hz:

| EMI Test Receiver | Setting |
|-------------------|----------|
| Attenuation | Auto |
| RB | 1MHz |
| VB | 10Hz |
| Detector | Peak |
| Trace | Max hold |

7.2 Test SET-UP (Block Diagram of Configuration)

(A) Radiated Emission Test Set-Up, Frequency Below 30MHz

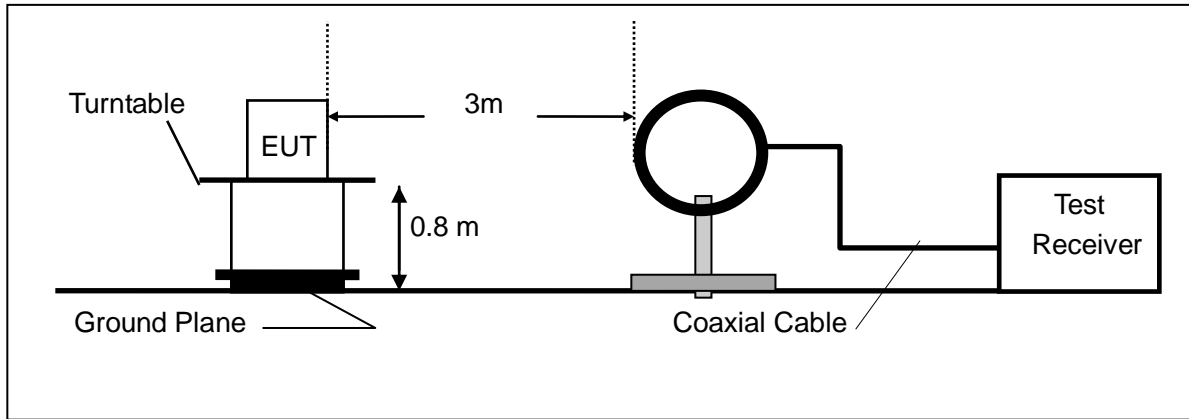

(B) Radiated Emission Test Set-Up, Frequency Below 1000MHz

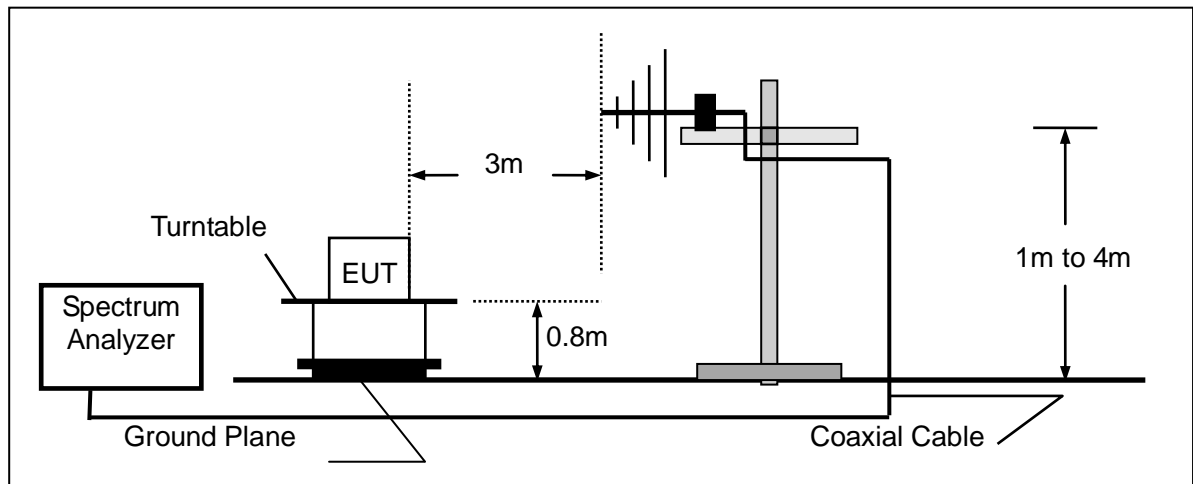

(C) Radiated Emission Test Set-Up, Frequency above 1000MHz

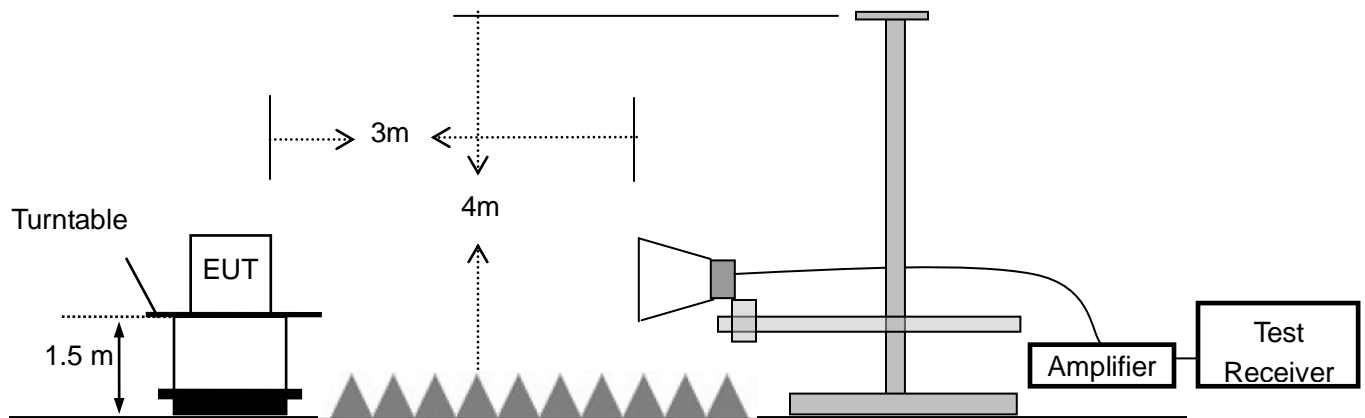

7.3 Measurement Equipment Used:

| Item | Equipment | Manufacturer | Model No. | Serial No. | Characteristics | Last Cal. | Cal. Interval |
|------|--------------------------------|-----------------|----------------|------------------|-----------------|------------|---------------|
| 1. | Test Receiver | Rohde & Schwarz | ESCI | 1166.5950.0 3 | 9KHz-3GHz | 05/16/2018 | 1 Year |
| 2. | Loop Antenna | Schwarzbeck | FMZB 1519 | 012 | 9 KHz -30MHz | 05/16/2018 | 1 Year |
| 3. | Bilog Antenna | Schwarzbeck | VULB9163 | 000141 | 25MHz-2GHz | 05/16/2018 | 1 Year |
| 4. | Power Amplifier | CDS | RSU-M352 | 818 | 1MHz-1GHz | 05/16/2018 | 1 Year |
| 5. | Power Amplifier | HP | 8447F | OPT H64 | 1GHz-26.5GHz | 05/16/2018 | 1 Year |
| 6. | Color Monitor | SUNSPO | SP-140A | N/A | -- | 05/16/2018 | 1 Year |
| 7. | Single Line Filter | JIANLI | XL-3 | N/A | -- | 05/16/2018 | 1 Year |
| 8. | Single Phase Power Line Filter | JIANLI | DL-2X100B | N/A | -- | 05/16/2018 | 1 Year |
| 9. | 3 Phase Power Line Filter | JIANLI | DL-4X100B | N/A | -- | 05/16/2018 | 1 Year |
| 10. | DC Power Filter | JIANLI | DL-2X50B | N/A | -- | 05/16/2018 | 1 Year |
| 11. | Cable | Schwarzbeck | PLF-100 | 549489 | 9KHz-3GHz | 05/16/2018 | 1 Year |
| 12. | Cable | Rosenberger | CIL02 | A0783566 | 9KHz-3GHz | 05/16/2018 | 1 Year |
| 13. | Cable | Rosenberger | RG 233/U | 525178 | 9KHz-3GHz | 05/16/2018 | 1 Year |
| 14. | Signal Analyzer | Rohde & Schwarz | FSV30 | 103040 | 9KHz-40GHz | 05/16/2018 | 1 Year |
| 15. | Horn Antenna | Schwarzbeck | BBHA9120D | 9120D-1272 | 1GHz-18GHz | 05/16/2018 | 1 Year |
| 16. | Horn Antenna | Schwarzbeck | BBHA 9170 | BBHA91703 99 | 14GHz -26.5GHz | 05/16/2018 | 1 Year |
| 17. | Power Amplifier | LUNAR EM | LNA1G18-4 0 | J101000000 81 | 1GHz-26.5GHz | 05/16/2018 | 1 Year |
| 18. | Cable | H+S | CBL-26 | N/A | 1GHz-26.5GHz | 05/16/2018 | 1 Year |
| 19. | Cable | H+S | CBL-26 | N/A | 1GHz-26.5GHz | 05/16/2018 | 1 Year |
| 20. | Cable | H+S | CBL-26 | N/A | 1GHz-26.5GHz | 05/16/2018 | 1 Year |

7.4 Radiated Emission Limit

The emissions from an intentional radiator shall not exceed the field strength levels specified in the following table 15.209(a):

| Frequencies (MHz) | Field Strength (microvolts/meter) | Measurement Distance (meters) |
|-------------------|-----------------------------------|-------------------------------|
| 0.009~0.490 | 2400/F(KHz) | 300 |
| 0.490~1.705 | 24000/F(KHz) | 30 |
| 1.705~30.0 | 30 | 30 |
| 30~88 | 100 | 3 |
| 88~216 | 150 | 3 |
| 216~960 | 200 | 3 |
| Above 960 | 500 | 3 |

15.205 Restricted bands of operation

| MHz | MHz | MHz | GHz |
|----------------------------|-----------------------|-----------------|------------------|
| 0.090 - 0.110 | 16.42 - 16.423 | 399.9 - 410 | 4.5 - 5.15 |
| ¹ 0.495 - 0.505 | 16.69475 - 16.69525 | 608 - 614 | 5.35 - 5.46 |
| 2.1735 - 2.1905 | 16.80425 - 16.80475 | 960 - 1240 | 7.25 - 7.75 |
| 4.125 - 4.128 | 25.5 - 25.67 | 1300 - 1427 | 8.025 - 8.5 |
| 4.17725 - 4.17775 | 37.5 - 38.25 | 1435 - 1626.5 | 9.0 - 9.2 |
| 4.20725 - 4.20775 | 73 - 74.6 | 1645.5 - 1646.5 | 9.3 - 9.5 |
| 6.215 - 6.218 | 74.8 - 75.2 | 1660 - 1710 | 10.6 - 12.7 |
| 6.26775 - 6.26825 | 108 - 121.94 | 1718.8 - 1722.2 | 13.25 - 13.4 |
| 6.31175 - 6.31225 | 123 - 138 | 2200 - 2300 | 14.47 - 14.5 |
| 8.291 - 8.294 | 149.9 - 150.05 | 2310 - 2390 | 15.35 - 16.2 |
| 8.362 - 8.366 | 156.52475 - 156.52525 | 2483.5 - 2500 | 17.7 - 21.4 |
| 8.37625 - 8.38675 | 156.7 - 156.9 | 2690 - 2900 | 22.01 - 23.12 |
| 8.41425 - 8.41475 | 162.0125 - 167.17 | 3260 - 3267 | 23.6 - 24.0 |
| 12.29 - 12.293 | 167.72 - 173.2 | 3332 - 3339 | 31.2 - 31.8 |
| 12.51975 - 12.52025 | 240 - 285 | 3345.8 - 3358 | 36.43 - 36.5 |
| 12.57675 - 12.57725 | 322 - 335.4 | 3600 - 4400 | (²) |

- Remark 1. Emission level in dBuV/m=20 log (uV/m)
 : 2. Measurement was performed at an antenna to the closed point of EUT distance of meters.
 3. Only spurious frequency is permitted to locate within the Restricted Bands specified in provision of § 15.205, and the emissions located in restricted bands also comply with 15.209 limit.

7.5 Measurement Result

Below 30MHz:

| | | | |
|--------------------|------------|---------------|--------------------|
| Operation Mode: | TX | Test Date : | September 26, 2018 |
| Frequency Range: | 9KHz~30MHz | Temperature : | 28°C |
| Test Result: | PASS | Humidity : | 65 % |
| Measured Distance: | 3m | Test By: | Andy |

| Freq. (MHz) | Ant.Pol. H/V | Emission Level (dBuV/m) | Limit 3m (dBuV/m) | Over (dB) |
|----------------|-----------------|-------------------------------|----------------------|--------------|
| -- | -- | -- | -- | -- |

Note: the amplitude of spurious emission that is attenuated by more than 20dB below the permissible limit has no need to be reported.

Below 1000MHz:

Pass.

All the modulation modes were tested the data of the worst mode (Π/4-DQPSK TX 2480MHz) are recorded in the following pages and the others modulation methods do not exceed the limits.

Please refer to the following data.

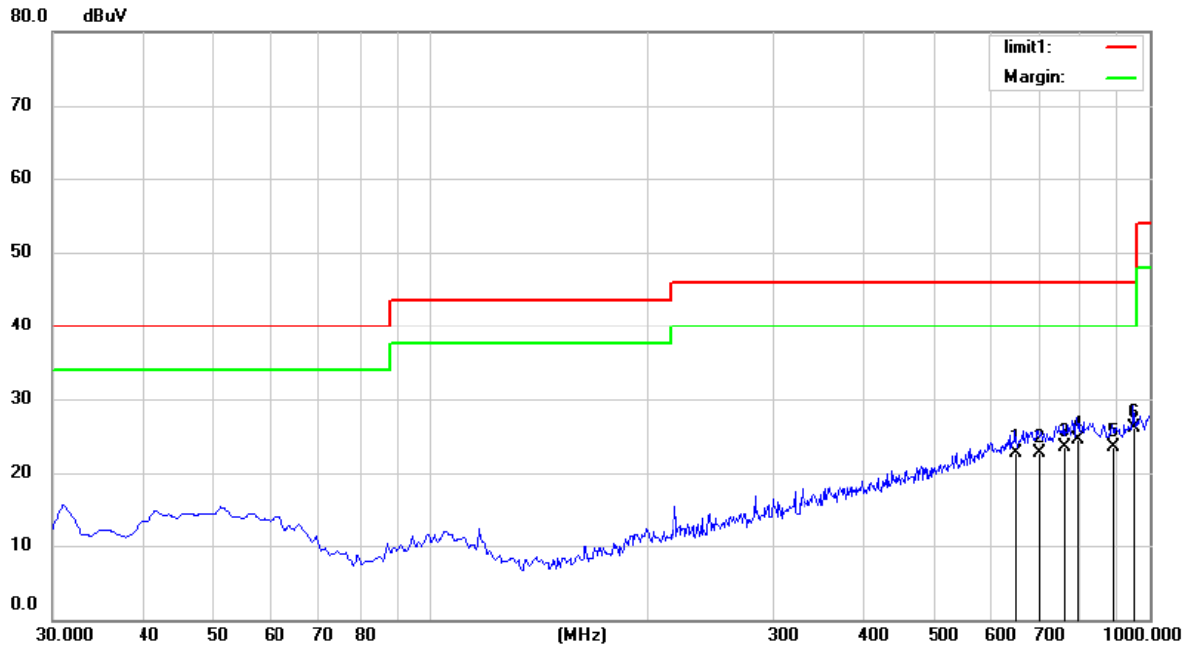

Site Chamber #1 Polarization: **Horizontal** Temperature: 26
 Limit: (RE)FCC PART 15 C 3m Power: Battery 3.7V Humidity: 55 %
 Mode: TX2480
 Note:

| No. | Mk. | Freq. | Reading Level | Correct Factor | Measurement | Limit | Over | Antenna Height | Table Degree |
|-----|-----|----------|---------------|----------------|-------------|-------|--------|----------------|--------------|
| | | MHz | dBuV | dB | dBuV | dBuV | dB | cm | degree |
| 1 | | 651.7700 | 27.82 | -5.15 | 22.67 | 46.00 | -23.33 | QP | |
| 2 | | 700.2700 | 26.90 | -4.20 | 22.70 | 46.00 | -23.30 | QP | |
| 3 | | 759.4400 | 27.04 | -3.54 | 23.50 | 46.00 | -22.50 | QP | |
| 4 | | 794.3600 | 27.91 | -3.36 | 24.55 | 46.00 | -21.45 | QP | |
| 5 | | 888.4500 | 27.19 | -3.64 | 23.55 | 46.00 | -22.45 | QP | |
| 6 | * | 951.5000 | 28.15 | -1.99 | 26.16 | 46.00 | -19.84 | QP | |

*:Maximum data x:Over limit !:over margin

Operator: Lin

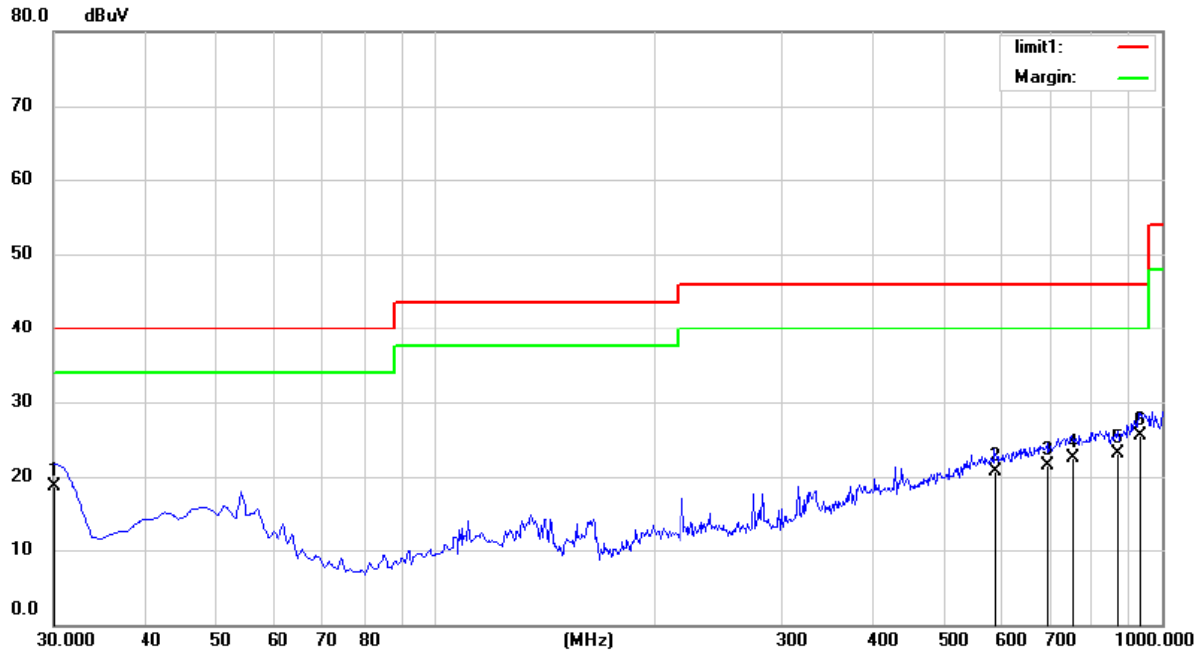

Site Chamber #1 Polarization: **Vertical** Temperature: 26
 Limit: (RE)FCC PART 15 C 3m Power: Battery 3.7V Humidity: 55 %
 Mode: TX2480
 Note:

| No. | Mk. | Freq. | Reading Level | Correct Factor | Measurement | Limit | Over | Antenna Height | Table Degree | |
|-----|-----|----------|---------------|----------------|-------------|-------|--------|----------------|--------------|---------|
| | | MHz | dBuV | dB | dBuV | dBuV | dB | cm | degree | Comment |
| 1 | | 30.0000 | 37.56 | -18.76 | 18.80 | 40.00 | -21.20 | QP | | |
| 2 | | 590.6600 | 28.24 | -7.50 | 20.74 | 46.00 | -25.26 | QP | | |
| 3 | | 694.4500 | 27.46 | -5.92 | 21.54 | 46.00 | -24.46 | QP | | |
| 4 | | 751.6800 | 27.34 | -4.75 | 22.59 | 46.00 | -23.41 | QP | | |
| 5 | | 870.9900 | 27.20 | -4.05 | 23.15 | 46.00 | -22.85 | QP | | |
| 6 | * | 931.1300 | 27.75 | -2.28 | 25.47 | 46.00 | -20.53 | QP | | |

*:Maximum data x:Over limit !:over margin

Operator: Lin

Above 1000MHz

Please refer to the following data.

Operation Mode: GFSK (CH1: 2402MHz) Test Date : September 26, 2018

| Freq. (MHz) | Ant. Pol. H/V | Emission Level(dBuV/m) | | Limit 3m(dBuV/m) | | Margin(dB) | |
|----------------|------------------|------------------------|-------|------------------|----|------------|--------|
| | | PK | AV | PK | AV | PK | AV |
| 4804 | V | 63.8 | 46.3 | 74 | 54 | -10.2 | -7.7 |
| 7206 | V | 58.36 | 41.36 | 74 | 54 | -15.64 | -12.64 |
| 9608 | V | 55.63 | 40.63 | 74 | 54 | -18.37 | -13.37 |
| 12010 | V | 55.33 | 40.36 | 74 | 54 | -18.67 | -13.64 |
| 14412 | V | 55.31 | 39.6 | 74 | 54 | -18.69 | -14.4 |
| 16814 | V | 54.32 | 39.36 | 74 | 54 | -19.68 | -14.64 |
| 4804 | H | 63.05 | 45.69 | 74 | 54 | -10.95 | -8.31 |
| 7206 | H | 58.32 | 41.3 | 74 | 54 | -15.68 | -12.7 |
| 9608 | H | 55.46 | 40.02 | 74 | 54 | -18.54 | -13.98 |
| 12010 | H | 55.47 | 39.85 | 74 | 54 | -18.53 | -14.15 |
| 14412 | H | 54.36 | 39.14 | 74 | 54 | -19.64 | -14.86 |
| 16814 | H | 53.78 | 38.66 | 74 | 54 | -20.22 | -15.34 |

Operation Mode: GFSK (CH40: 2441MHz) Test Date : September 26, 2018

| Freq. (MHz) | Ant. Pol. H/V | Emission Level(dBuV/m) | | Limit 3m(dBuV/m) | | Margin(dB) | |
|----------------|------------------|------------------------|-------|------------------|----|------------|--------|
| | | PK | AV | PK | AV | PK | AV |
| 4882 | V | 63.12 | 43.54 | 74 | 54 | -10.88 | -10.46 |
| 7323 | V | 58.63 | 40.25 | 74 | 54 | -15.37 | -13.75 |
| 9764 | V | 55.63 | 39.58 | 74 | 54 | -18.37 | -14.42 |
| 12205 | V | 54.6 | 39.4 | 74 | 54 | -19.4 | -14.6 |
| 14646 | V | 54.36 | 39.13 | 74 | 54 | -19.64 | -14.87 |
| 17087 | V | 54.23 | 39 | 74 | 54 | -19.77 | -15 |
| 4882 | H | 63.02 | 43.58 | 74 | 54 | -10.98 | -10.42 |
| 7323 | H | 58.36 | 40.02 | 74 | 54 | -15.64 | -13.98 |
| 9764 | H | 55.4 | 39.57 | 74 | 54 | -18.6 | -14.43 |
| 12205 | H | 54.2 | 39.7 | 74 | 54 | -19.8 | -14.3 |
| 14646 | H | 53.22 | 38.65 | 74 | 54 | -20.78 | -15.35 |
| 17087 | H | 53.17 | 38.7 | 74 | 54 | -20.83 | -15.3 |

Operation Mode: GFSK (CH79: 2480MHz) Test Date : September 26, 2018

| Freq. (MHz) | Ant. Pol. H/V | Emission Level(dBuV/m) | | Limit 3m(dBuV/m) | | Margin(dB) | |
|----------------|------------------|------------------------|-------|------------------|----|------------|--------|
| | | PK | AV | PK | AV | PK | AV |
| 4960 | V | 64.32 | 44.69 | 74 | 54 | -9.68 | -9.31 |
| 7440 | V | 60.53 | 41.02 | 74 | 54 | -13.47 | -12.98 |
| 9920 | V | 56.35 | 39.32 | 74 | 54 | -17.65 | -14.68 |
| 12400 | V | 55.32 | 38.88 | 74 | 54 | -18.68 | -15.12 |
| 14880 | V | 54.35 | 38.12 | 74 | 54 | -19.65 | -15.88 |
| 17360 | V | 54.23 | 37.69 | 74 | 54 | -19.77 | -16.31 |
| 4960 | H | 63.58 | 44.68 | 74 | 54 | -10.42 | -9.32 |
| 7440 | H | 60.47 | 41.02 | 74 | 54 | -13.53 | -12.98 |
| 9920 | H | 56.84 | 39.25 | 74 | 54 | -17.16 | -14.75 |
| 12400 | H | 55.12 | 38.46 | 74 | 54 | -18.88 | -15.54 |
| 14880 | H | 54.36 | 38.14 | 74 | 54 | -19.64 | -15.86 |
| 17360 | H | 54.2 | 38.2 | 74 | 54 | -19.8 | -15.8 |

Operation Mode: Pi/4-DQPSK (CH1: 2402MHz) Test Date : September 26, 2018

| Freq. (MHz) | Ant. Pol. H/V | Emission Level(dBuV/m) | | Limit 3m(dBuV/m) | | Over(dB) | |
|----------------|------------------|------------------------|-------|------------------|----|----------|--------|
| | | PK | AV | PK | AV | PK | AV |
| 4804 | V | 65.68 | 46.32 | 74 | 54 | -8.32 | -7.68 |
| 7206 | V | 60.32 | 41.96 | 74 | 54 | -13.68 | -12.04 |
| 9608 | V | 58.32 | 40.32 | 74 | 54 | -15.68 | -13.68 |
| 12010 | V | 55.69 | 38.32 | 74 | 54 | -18.31 | -15.68 |
| 14412 | V | 55.14 | 38.02 | 74 | 54 | -18.86 | -15.98 |
| 16814 | V | 54.69 | 37.85 | 74 | 54 | -19.31 | -16.15 |
| 4804 | H | 64.02 | 45.88 | 74 | 54 | -9.98 | -8.12 |
| 7206 | H | 60.3 | 42.12 | 74 | 54 | -13.7 | -11.88 |
| 9608 | H | 57.99 | 40.6 | 74 | 54 | -16.01 | -13.4 |
| 12010 | H | 55.6 | 39.65 | 74 | 54 | -18.4 | -14.35 |
| 14412 | H | 55.44 | 38.47 | 74 | 54 | -18.56 | -15.53 |
| 16814 | H | 54.19 | 38.15 | 74 | 54 | -19.81 | -15.85 |

Operation Mode: Pi/4-DQPSK (CH40: 2441MHz) Test Date : September 26, 2018

| Freq. (MHz) | Ant. Pol. H/V | Emission Level(dBuV/m) | | Limit 3m(dBuV/m) | | Over(dB) | |
|----------------|------------------|------------------------|-------|------------------|----|----------|--------|
| | | PK | AV | PK | AV | PK | AV |
| 4882 | V | 64.54 | 46.7 | 74 | 54 | -9.46 | -7.3 |
| 7323 | V | 60.52 | 42.69 | 74 | 54 | -13.48 | -11.31 |
| 9764 | V | 58.36 | 40.58 | 74 | 54 | -15.64 | -13.42 |
| 12205 | V | 55.3 | 39.47 | 74 | 54 | -18.7 | -14.53 |
| 14646 | V | 54.28 | 38.45 | 74 | 54 | -19.72 | -15.55 |
| 17087 | V | 54.69 | 38.13 | 74 | 54 | -19.31 | -15.87 |
| 4882 | H | 63.74 | 43.01 | 74 | 54 | -10.26 | -10.99 |
| 7323 | H | 60.47 | 47 | 74 | 54 | -13.53 | -7 |
| 9764 | H | 58.69 | 42.47 | 74 | 54 | -15.31 | -11.53 |
| 12205 | H | 55.69 | 40.21 | 74 | 54 | -18.31 | -13.79 |
| 14646 | H | 55.13 | 39.64 | 74 | 54 | -18.87 | -14.36 |
| 17087 | H | 54.87 | 38.23 | 74 | 54 | -19.13 | -15.77 |

Operation Mode: Pi/4-DQPSK (CH79: 2480MHz) Test Date : September 26, 2018

| Freq. (MHz) | Ant. Pol. H/V | Emission Level(dBuV/m) | | Limit 3m(dBuV/m) | | Over(dB) | |
|----------------|------------------|------------------------|-------|------------------|----|----------|--------|
| | | PK | AV | PK | AV | PK | AV |
| 4960 | V | 65.41 | 47.65 | 74 | 54 | -8.59 | -6.35 |
| 7440 | V | 61.36 | 42.35 | 74 | 54 | -12.64 | -11.65 |
| 9920 | V | 57.36 | 40.32 | 74 | 54 | -16.64 | -13.68 |
| 12400 | V | 55.47 | 38.47 | 74 | 54 | -18.53 | -15.53 |
| 14880 | V | 55.69 | 37.58 | 74 | 54 | -18.31 | -16.42 |
| 17360 | V | 54.13 | 37.45 | 74 | 54 | -19.87 | -16.55 |
| 4960 | H | 64.97 | 47.23 | 74 | 54 | -9.03 | -6.77 |
| 7440 | H | 61.29 | 42.03 | 74 | 54 | -12.71 | -11.97 |
| 9920 | H | 57.62 | 40.15 | 74 | 54 | -16.38 | -13.85 |
| 12400 | H | 55.14 | 38.47 | 74 | 54 | -18.86 | -15.53 |
| 14880 | H | 54.32 | 37.69 | 74 | 54 | -19.68 | -16.31 |
| 17360 | H | 53.02 | 37.23 | 74 | 54 | -20.98 | -16.77 |

Other harmonics emissions are lower than 20dB below the allowable limit.

- Note:**
- (1) All Readings are Peak Value and AV.
 - (2) Emission Level= Reading Level+ Probe Factor +Cable Loss.
 - (3) The average measurement was not performed when the peak measured data under the limit of average detection.
 - (4) Measuring frequencies from 1GHz to 25GHz.

7.5 Radiated Measurement Photos:

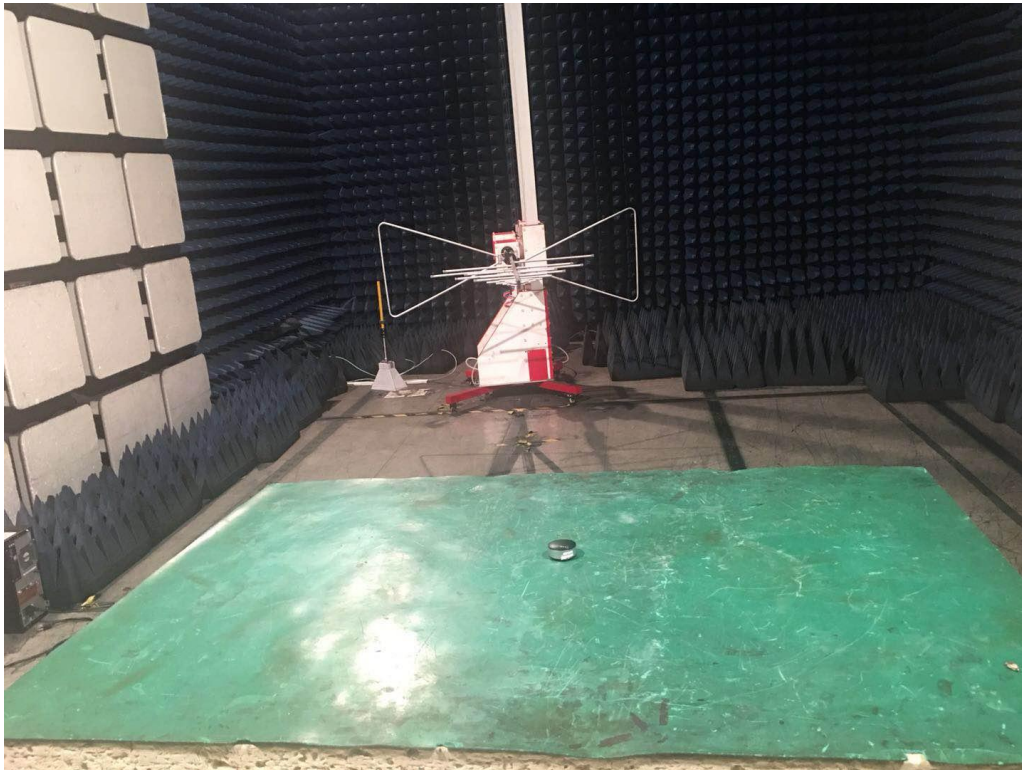

8. Channel Separation test

8.1 Measurement Procedure

The EUT was operating in hopping mode or could be controlled its channel. Printed out the test result from the spectrum by hard copy function.

8.2 Test SET-UP (Block Diagram of Configuration)

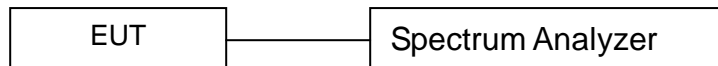

8.3 Measurement Equipment Used:

| EQUIPMENT TYPE | MFR | MODEL NUMBER | SERIAL NUMBER | Characteristics | LAST CAL. | CAL DUE. |
|-------------------|-----------------|--------------|---------------|-----------------|------------|------------|
| Spectrum Analyzer | Rohde & Schwarz | FSV30 | 1321.3008K | 10Hz-30GHz | 05/16/2018 | 05/15/2019 |
| Coaxial Cable | CDS | 79254 | 46107086 | 10Hz-30GHz | 05/16/2018 | 05/15/2019 |
| Antenna Connector | ARTHUR-YANG | 2244-N1TG1 | N/A | 10Hz-30GHz | 05/16/2018 | 05/15/2019 |

Remark: The temporary antenna connector is soldered on the PCB board in order to perform conducted tests and this temporary antenna connector is listed in the equipment list.

8.4 Measurement Results:

Refer to attached data chart.

| | | | |
|--------------------|------|---------------|--------------------|
| Spectrum Detector: | PK | Test Date : | September 28, 2018 |
| Test By: | Andy | Temperature : | 25 °C |
| Test Result: | PASS | Humidity : | 50 % |
| Modulation: | GFSK | | |

| Channel number | Channel frequency (MHz) | Separation Read Value (kHz) | Separation Limit 2/3 20dB Down BW(kHz) |
|----------------|-------------------------|-----------------------------|----------------------------------------|
| 1 | 2402 | 1003 | >753 |
| 40 | 2441 | 1003 | >744 |
| 79 | 2480 | 1003 | >753 |

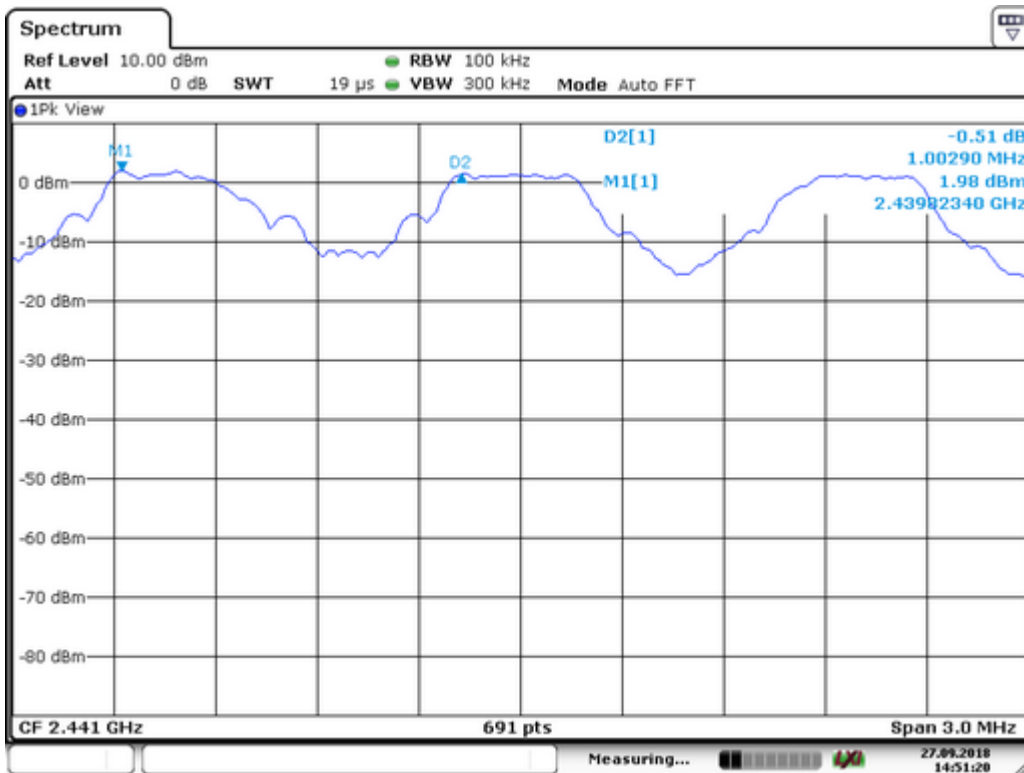
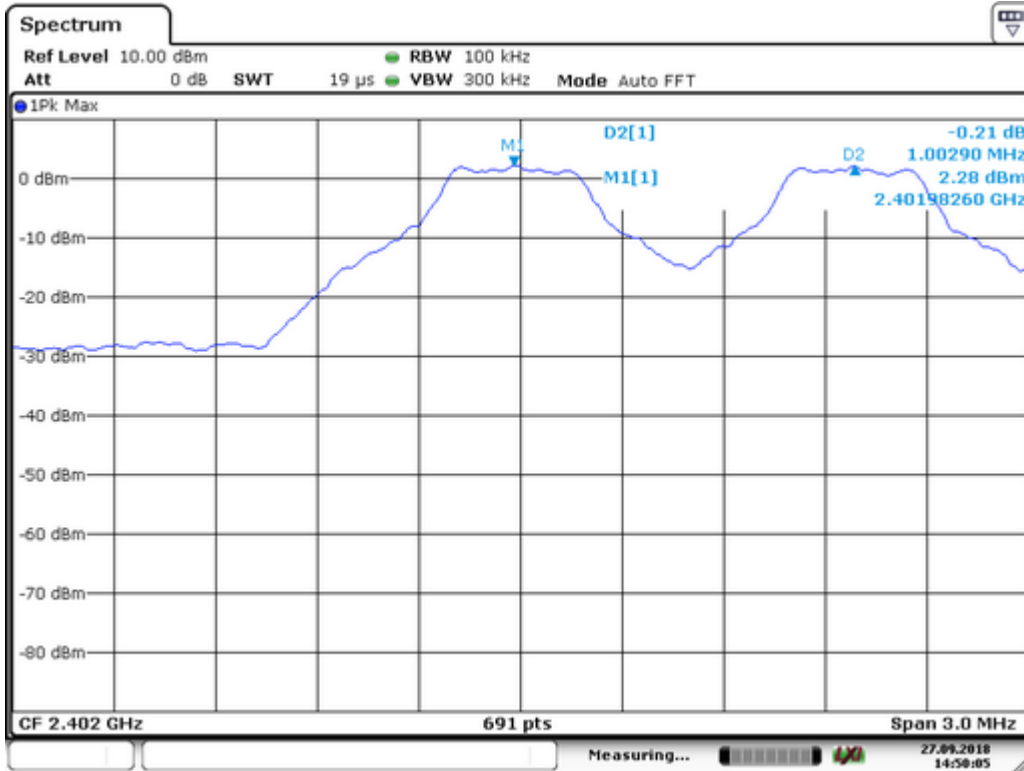



| | | | |
|--------------------|-----------|---------------|--------------------|
| Spectrum Detector: | PK | Test Date : | September 28, 2018 |
| Test By: | Andy | Temperature : | 24°C |
| Test Result: | PASS | Humidity : | 53 % |
| Modulation: | Π/4-DQPSK | | |

| Channel number | Channel frequency (MHz) | Separation Read Value (kHz) | Separation Limit 2/3 20dB Down BW(kHz) |
|----------------|-------------------------|-----------------------------|----------------------------------------|
| 1 | 2402 | 1003 | >981 |
| 40 | 2441 | 1003 | >952 |
| 79 | 2480 | 1003 | >984 |

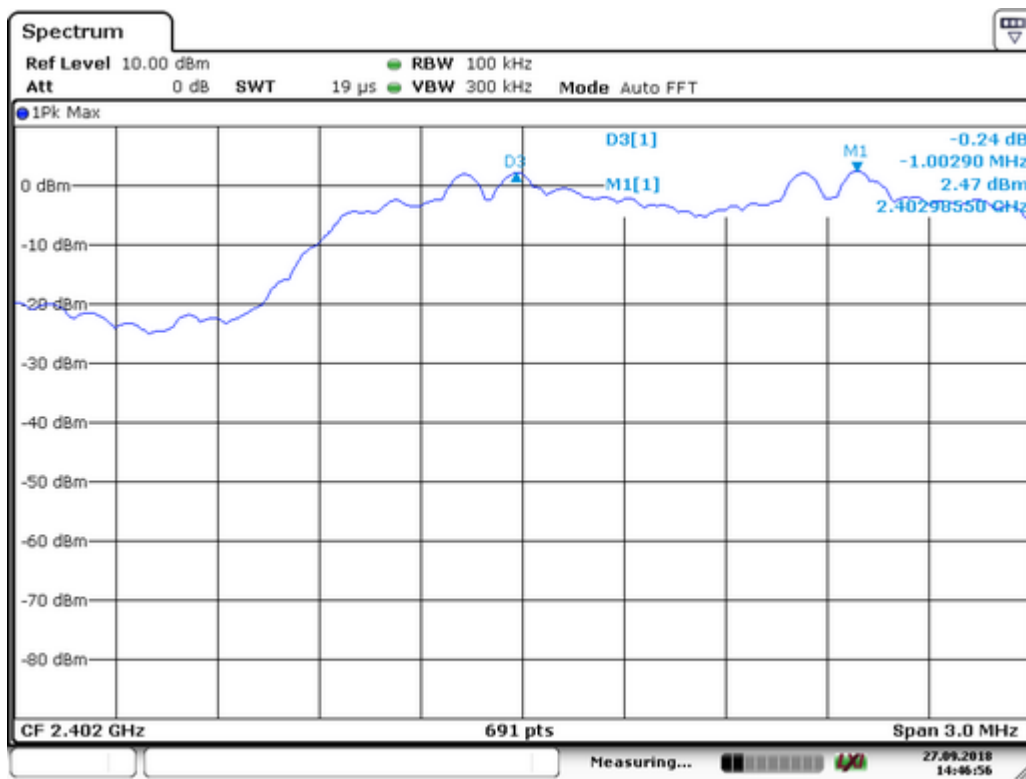

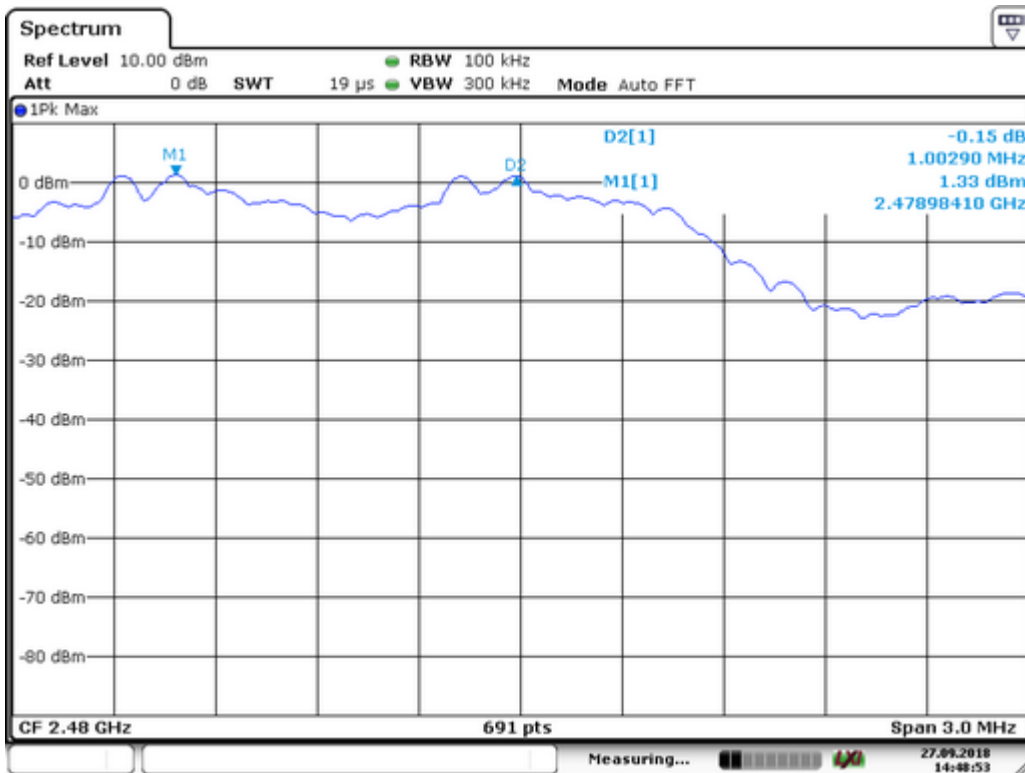
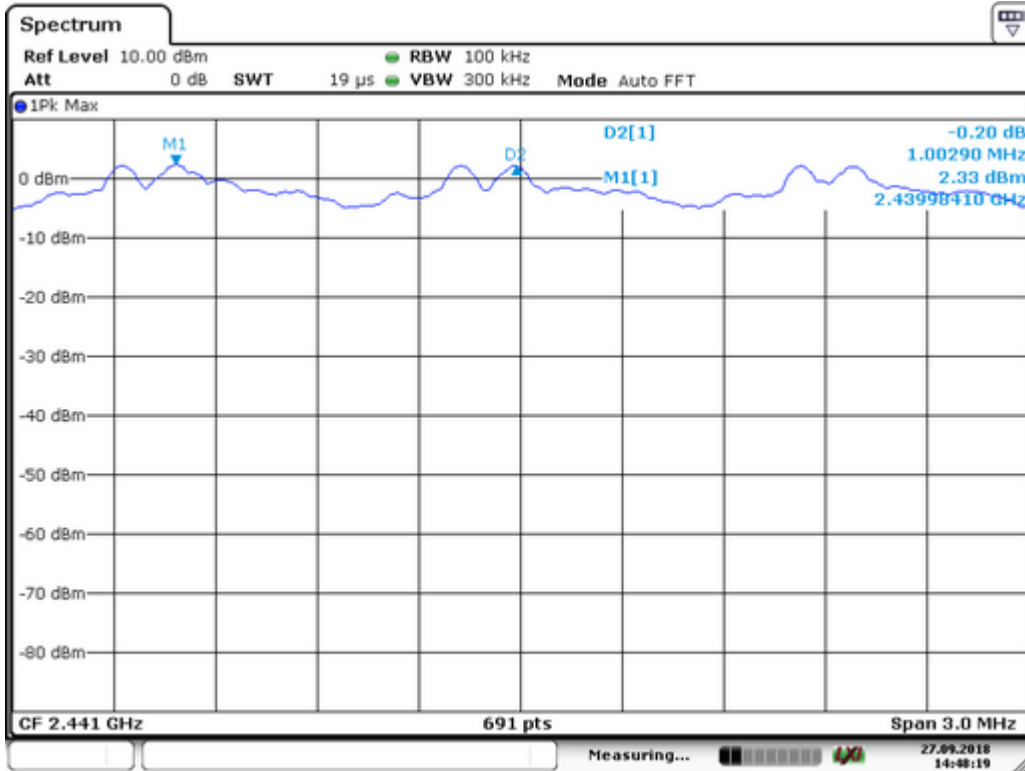

9. 20dB Bandwidth test

9.1 Measurement Procedure

The EUT was operating in hopping mode or could be controlled its channel. Printed out the test result from the spectrum by hard copy function.

9.2 Test SET-UP (Block Diagram of Configuration)

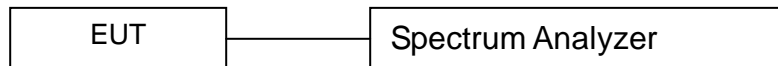

9.3 Measurement Equipment Used:

| EQUIPMENT TYPE | MFR | MODEL NUMBER | SERIAL NUMBER | Characteristics | LAST CAL. | CAL DUE. |
|-------------------|-----------------|--------------|---------------|-----------------|------------|------------|
| Spectrum Analyzer | Rohde & Schwarz | FSV30 | 1321.3008K | 10Hz-30GHz | 05/16/2018 | 05/15/2019 |
| Coaxial Cable | CDS | 79254 | 46107086 | 10Hz-30GHz | 05/16/2018 | 05/15/2019 |
| Antenna Connector | ARTHUR-YANG | 2244-N1TG1 | N/A | 10Hz-30GHz | 05/16/2018 | 05/15/2019 |

Remark: The temporary antenna connector is soldered on the PCB board in order to perform conducted tests and this temporary antenna connector is listed in the equipment list.

9.4 Measurement Results:

Refer to attached data chart.

| | | | |
|--------------------|------|---------------|--------------------|
| Spectrum Detector: | PK | Test Date : | September 28, 2018 |
| Test By: | Andy | Temperature : | 24°C |
| Test Result: | PASS | Humidity : | 53 % |
| Modulation: | GFSK | | |

| Channel number | Channel frequency (MHz) | 20dB Down BW(kHz) |
|----------------|-------------------------|-------------------|
| 1 | 2402 | 1129 |
| 40 | 2441 | 1116 |
| 79 | 2480 | 1129 |

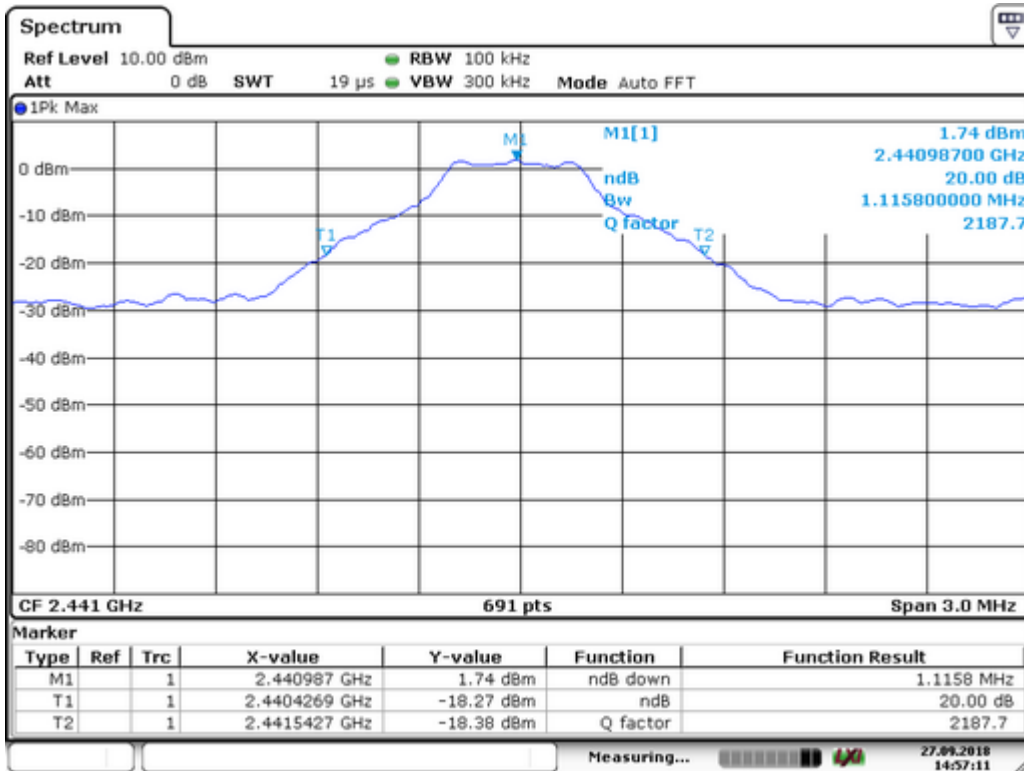
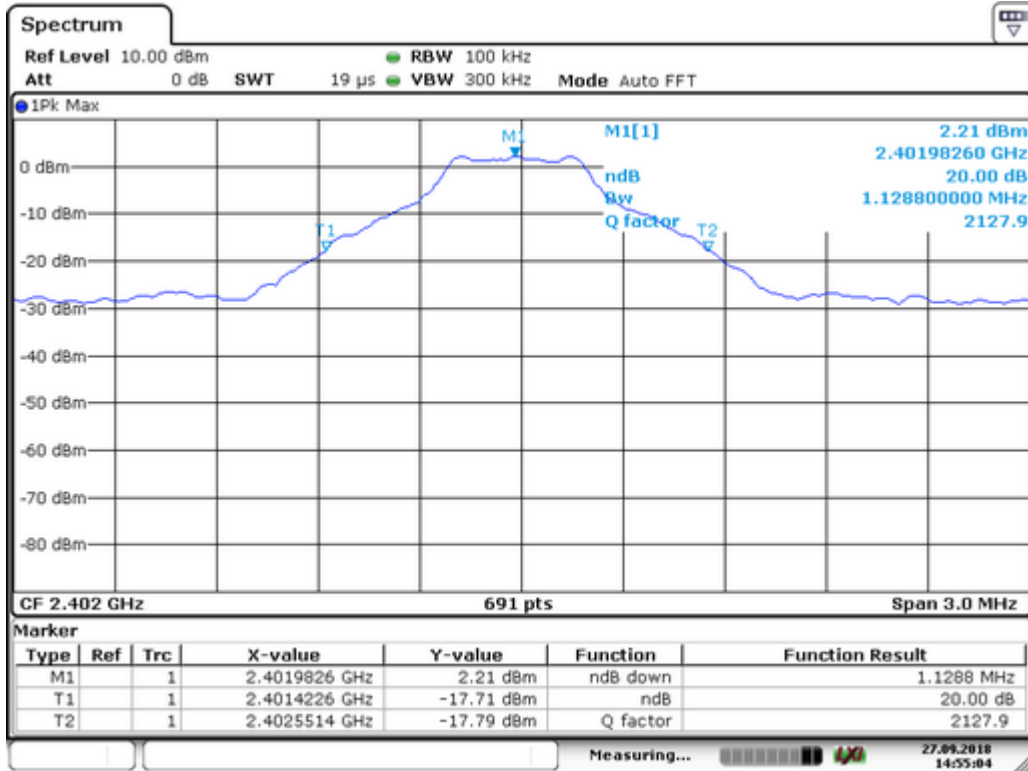

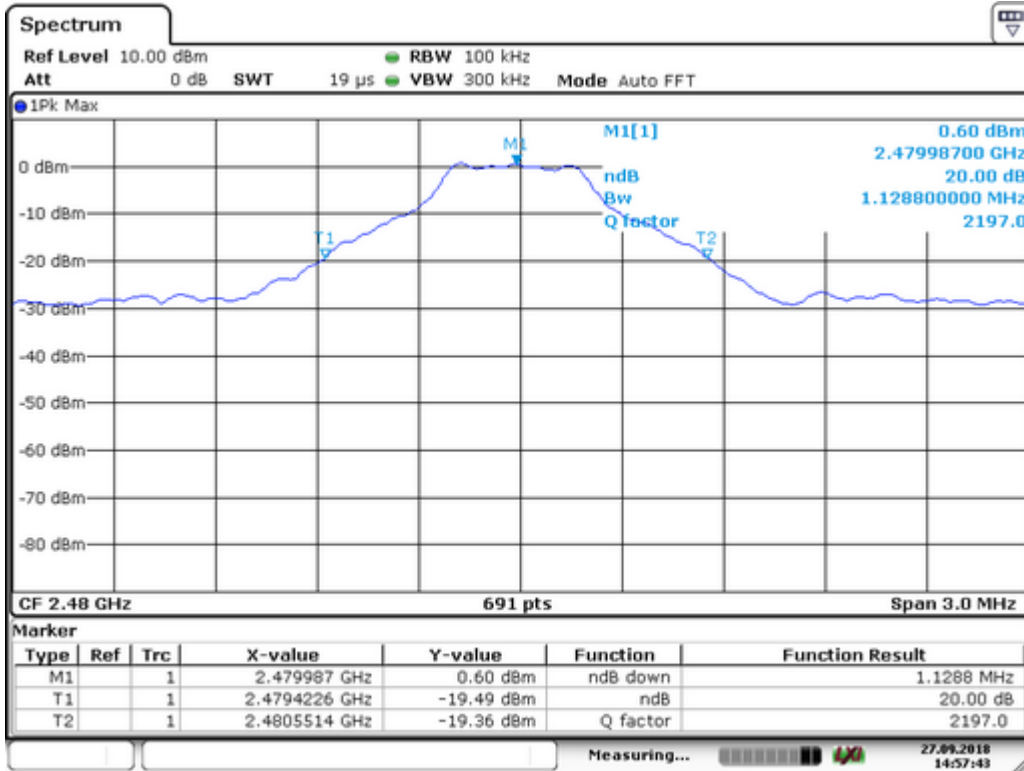

Spectrum Detector: PK Test Date : September 28, 2018
 Test By: Andy Temperature : 24°C
 Test Result: PASS Humidity : 53 %
 Modulation: $\pi/4$ -DQPSK

| Channel number | Channel frequency (MHz) | 20dB Down BW(kHz) |
|----------------|-------------------------|-------------------|
| 1 | 2402 | 1472 |
| 40 | 2441 | 1428 |
| 79 | 2480 | 1476 |

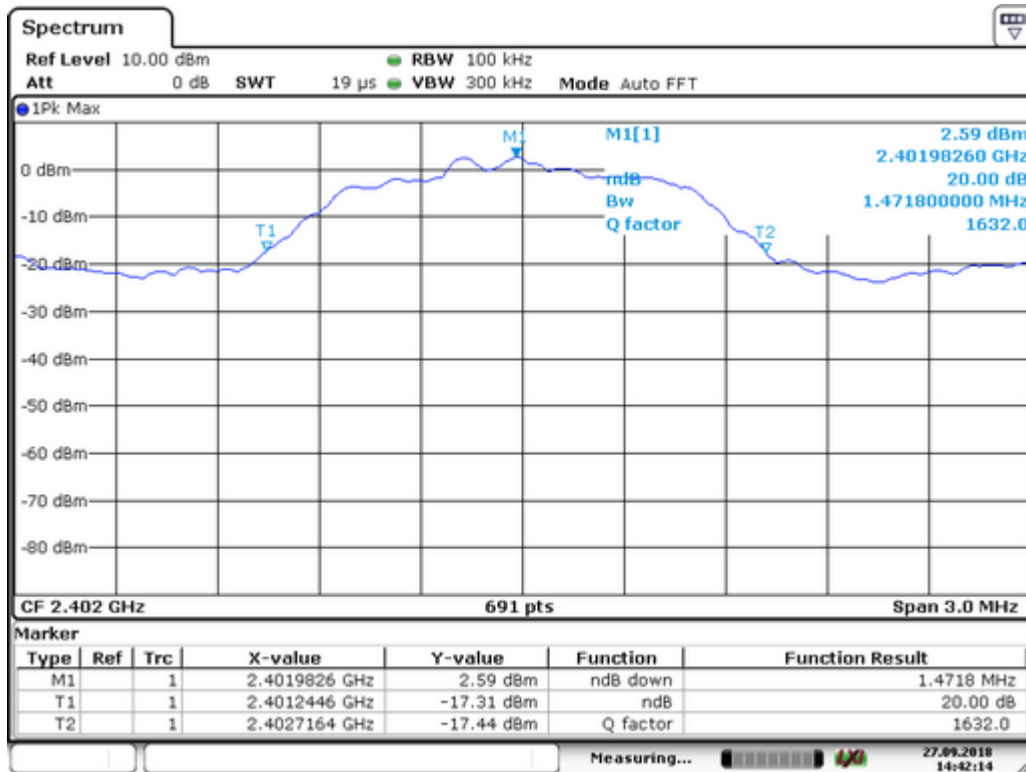

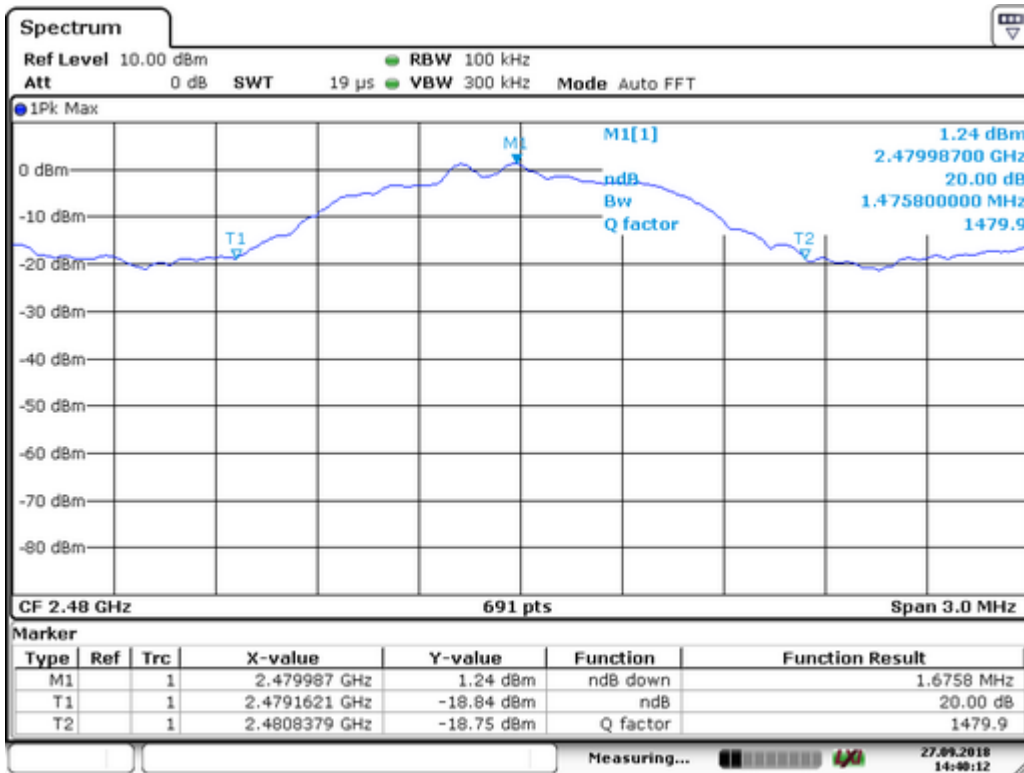
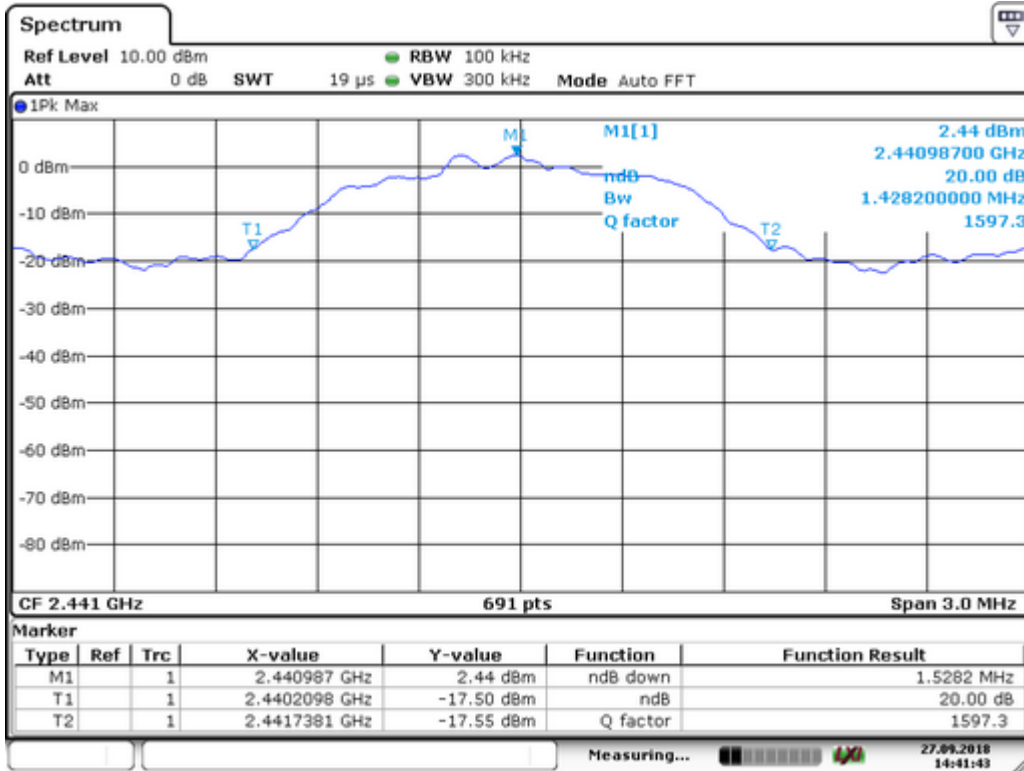

10. Quantity of Hopping Channel Test

10.1 Measurement Procedure

The EUT was operating in hopping mode or could be controlled its channel. Printed out the test result from the spectrum by hard copy function.

10.2 Test SET-UP (Block Diagram of Configuration)

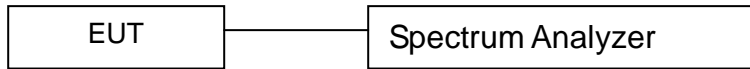

10.3 Measurement Equipment Used:

| EQUIPMENT TYPE | MFR | MODEL NUMBER | SERIAL NUMBER | Characteristics | LAST CAL. | CAL DUE. |
|-------------------|-----------------|--------------|---------------|-----------------|------------|------------|
| Spectrum Analyzer | Rohde & Schwarz | FSV30 | 1321.3008K | 10Hz-30GHz | 05/16/2018 | 05/15/2019 |
| Coaxial Cable | CDS | 79254 | 46107086 | 10Hz-30GHz | 05/16/2018 | 05/15/2019 |
| Antenna Connector | ARTHUR-YANG | 2244-N1TG1 | N/A | 10Hz-30GHz | 05/16/2018 | 05/15/2019 |

Remark: The temporary antenna connector is soldered on the PCB board in order to perform conducted tests and this temporary antenna connector is listed in the equipment list.

10.4 Measurement Results:

Refer to attached data chart.

Worst Test Mode GFSK Test Date : September 28, 2018
 Test By: Andy Temperature : 25 °C
 Test Result: PASS Humidity : 50 %

| Hopping Channel Frequency Range | Quantity of Hopping Channel | Quantity of Hopping Channel |
|---------------------------------|-----------------------------|-----------------------------|
| 2402-2480 | 79 | > 15 |

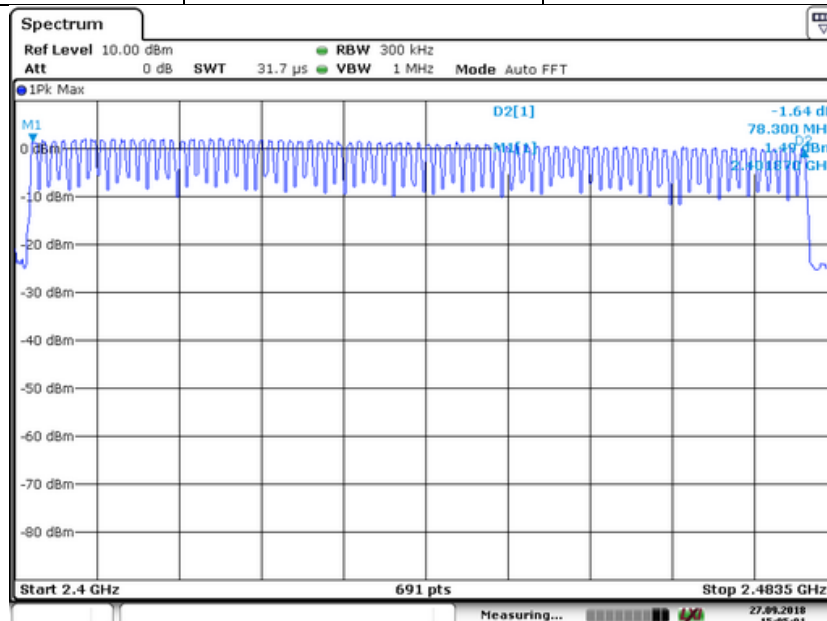

11. Time of Occupancy (Dwell Time) test

11.1 Test Description

The Equipment Under Test (EUT) was set up to perform the dwell time measurements. The EUT was connected to the spectrum analyzer via a short coax cable. The dwell time is calculated by:

$$\text{Dwell time} = \text{time slot length} * \text{hop rate} / \text{number of hopping channels} * 31.6\text{s}$$

with:

- hop rate = $1600 * 1/\text{s}$ for DH1 packets = 1600 s^{-1}
- hop rate = $1600/3 * 1/\text{s}$ for DH3 packets = 533.33 s^{-1}
- number of hopping channels = 79
- $31.6 \text{ s} = 0.4 \text{ seconds multiplied by the number of hopping channels} = 0.4 \text{ s} * 79$

The highest value of the dwell time is reported.

11.2 Test SET-UP (Block Diagram of Configuration)

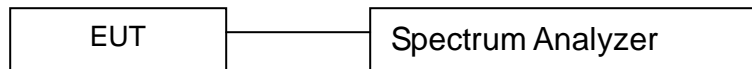

11.3 Measurement Equipment Used:

| EQUIPMENT TYPE | MFR | MODEL NUMBER | SERIAL NUMBER | Characteristics | LAST CAL. | CAL DUE. |
|-------------------|-----------------|--------------|---------------|-----------------|------------|------------|
| Spectrum Analyzer | Rohde & Schwarz | FSV30 | 1321.3008K | 10Hz-30GHz | 05/16/2018 | 05/15/2019 |
| Coaxial Cable | CDS | 79254 | 46107086 | 10Hz-30GHz | 05/16/2018 | 05/15/2019 |
| Antenna Connector | ARTHUR-YANG | 2244-N1TG1 | N/A | 10Hz-30GHz | 05/16/2018 | 05/15/2019 |

Remark: The temporary antenna connector is soldered on the PCB board in order to perform conducted tests and this temporary antenna connector is listed in the equipment list.

11.4 Test Requirements / Limits

FCC Part 15, Subpart C, §15.247 (a) (1) (iii)

Frequency hopping systems in the 2400-2483.5 MHz band shall use at least 15 channels. The average time of occupancy on any channel shall not be greater than 0.4 seconds within a period of 0.4 seconds multiplied by the number of hopping channels employed. Since the Bluetooth technology uses 79 channels this period is calculated to be 31.6seconds. Refer to attached data chart.

11.5 Test result

GFSK:

| Mode | Number of transmission in a 31.6(79 Hopping*0.4) | Length of transmissions time(msec) | Result (msec) | Limit (msec) |
|------|---------------------------------------------------|------------------------------------|---------------|--------------|
| DH1 | $1600/(2*79) \times 31.6 = 320$ | 0.407 | 130.2 | 400 |
| DH3 | $1600/(4*79) \times 31.6 = 160$ | 1.669 | 267.0 | 400 |
| DH5 | $1600/(6*79) \times 31.6 = 106.67$ | 2.913 | 310.7 | 400 |

Remark: The results of worst cased was recorded.

DH1:

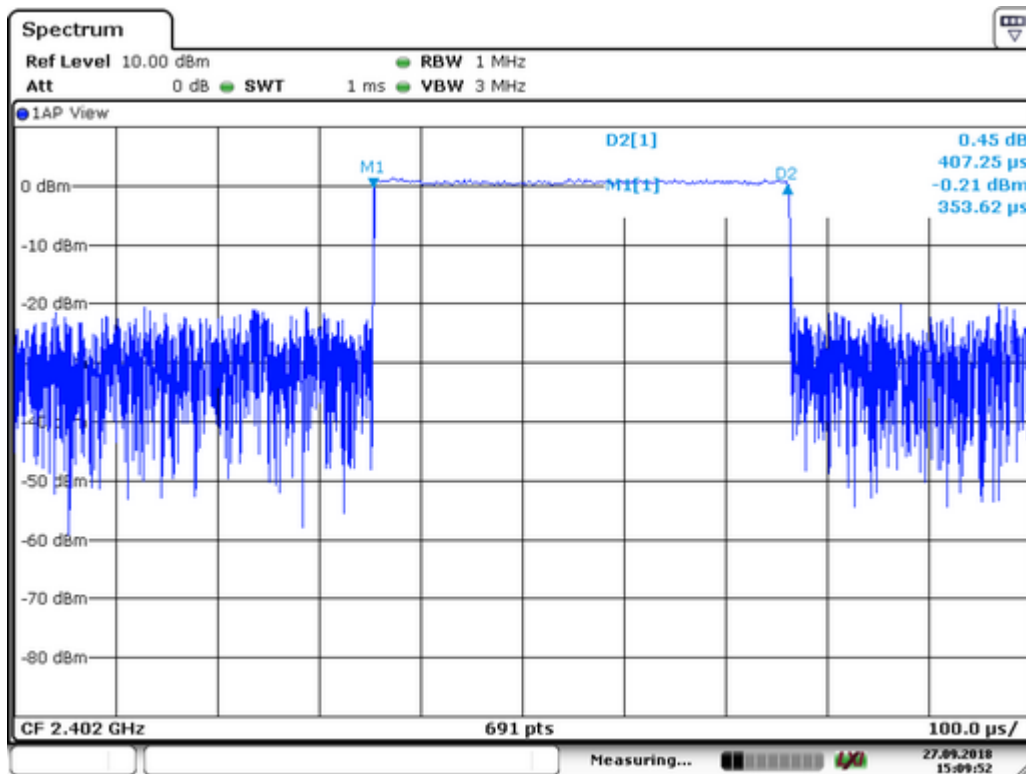

DH3:

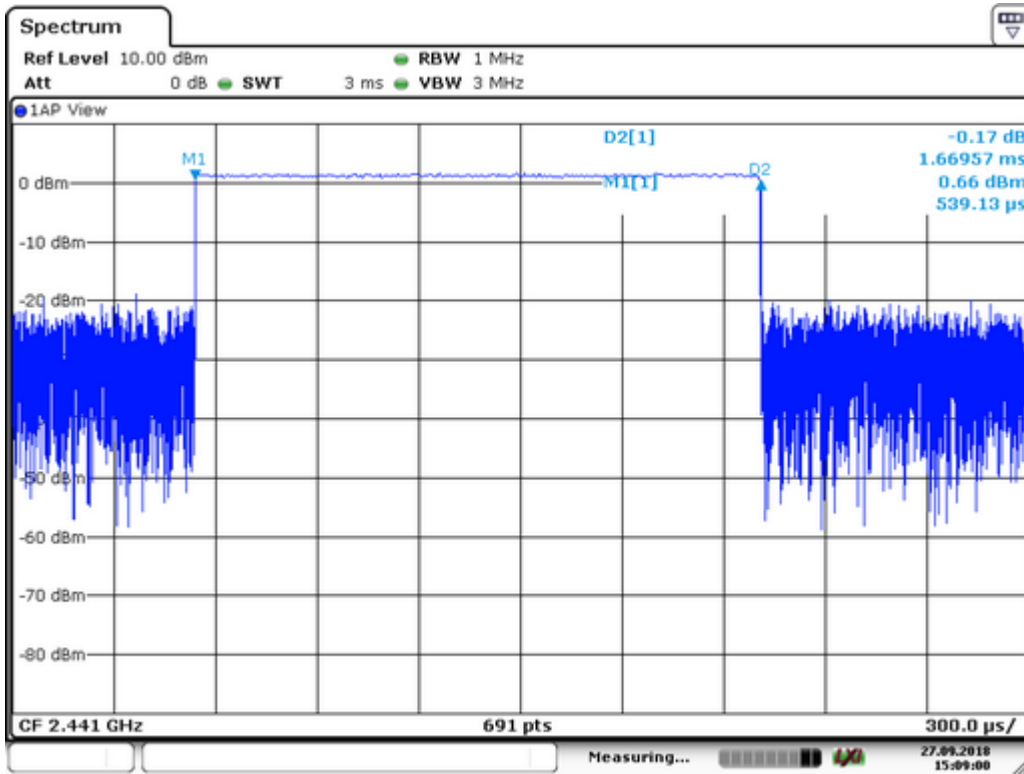

DH5:

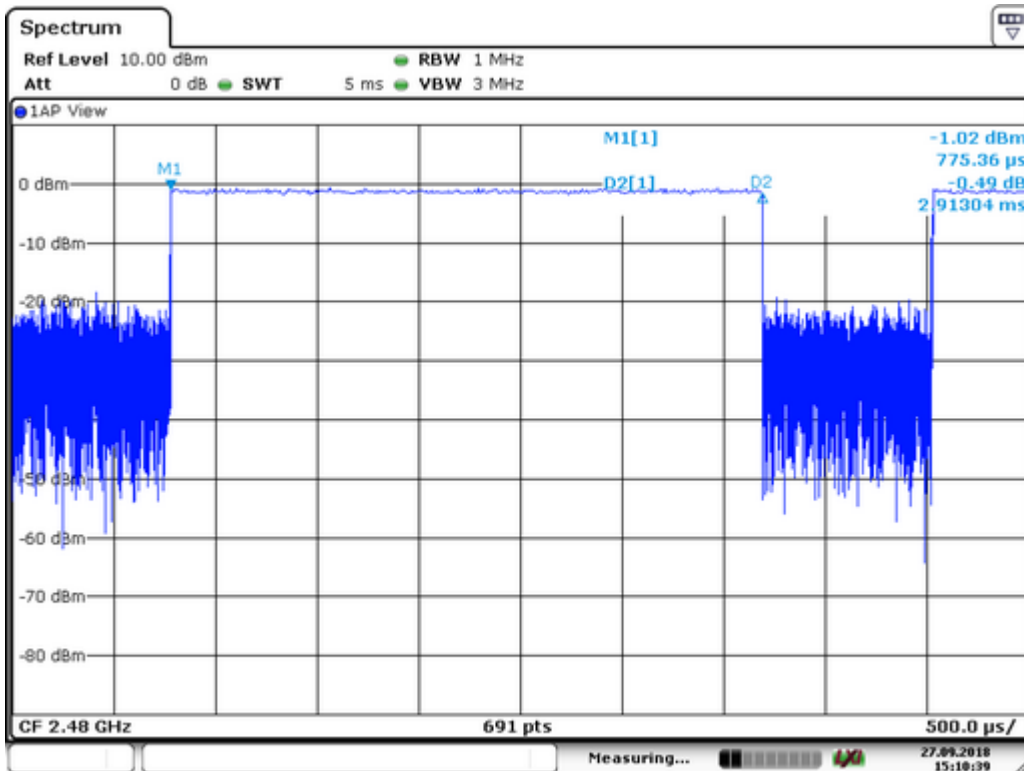

12. MAXIMUM PEAK OUTPUT POWER TEST

12.1 Measurement Procedure

- a. Check the calibration of the measuring instrument(SA) using either an internal calibrator or a known signal from an external generator.
- b. Turn on the EUT and connect it to measurement instrument. Then set it to any one convenient frequency within its operating range. Set a reference level on the measuring instrument equal to the highest peak value.
- c. The center frequency of the spectrum analyzer is set to the fundamental frequency and using proper RBW and VBW setting.
- d. Measure the captured power within the band and recording the plot.
- e. Repeat above procedures until all frequencies required were complete.

12.2 Test SET-UP (Block Diagram of Configuration)

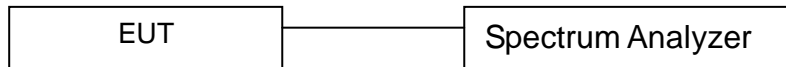

12.3 Measurement Equipment Used:

| EQUIPMENT TYPE | MFR | MODEL NUMBER | SERIAL NUMBER | Characteristics | LAST CAL. | CAL DUE. |
|-------------------|-----------------|--------------|---------------|-----------------|------------|------------|
| Spectrum Analyzer | Rohde & Schwarz | FSV30 | 1321.3008K | 10Hz-30GHz | 05/16/2018 | 05/15/2019 |
| Coaxial Cable | CDS | 79254 | 46107086 | 10Hz-30GHz | 05/16/2018 | 05/15/2019 |
| Antenna Connector | ARTHUR-YANG | 2244-N1TG1 | N/A | 10Hz-30GHz | 05/16/2018 | 05/15/2019 |

Remark: The temporary antenna connector is soldered on the PCB board in order to perform conducted tests and this temporary antenna connector is listed in the equipment list.

12.4 Measurement Results:

Refer to attached data chart.

| | | | |
|--------------------|------|---------------|--------------------|
| Spectrum Detector: | PK | Test Date : | September 28, 2018 |
| Test By: | Leon | Temperature : | 25 °C |
| Test Result: | PASS | Humidity : | 50 % |
| Modulation: | GFSK | | |

| Channel number | Channel Frequency (MHz) | Peak Power output(dBm) | Peak Power output(mW) | Peak Power Limit(mW) | Pass/Fail |
|----------------|-------------------------|------------------------|-----------------------|----------------------|-----------|
| 01 | 2402 | 2.79 | 1.901 | 125 | PASS |
| 40 | 2441 | 2.01 | 1.589 | 125 | PASS |
| 79 | 2480 | 1.55 | 1.429 | 125 | PASS |

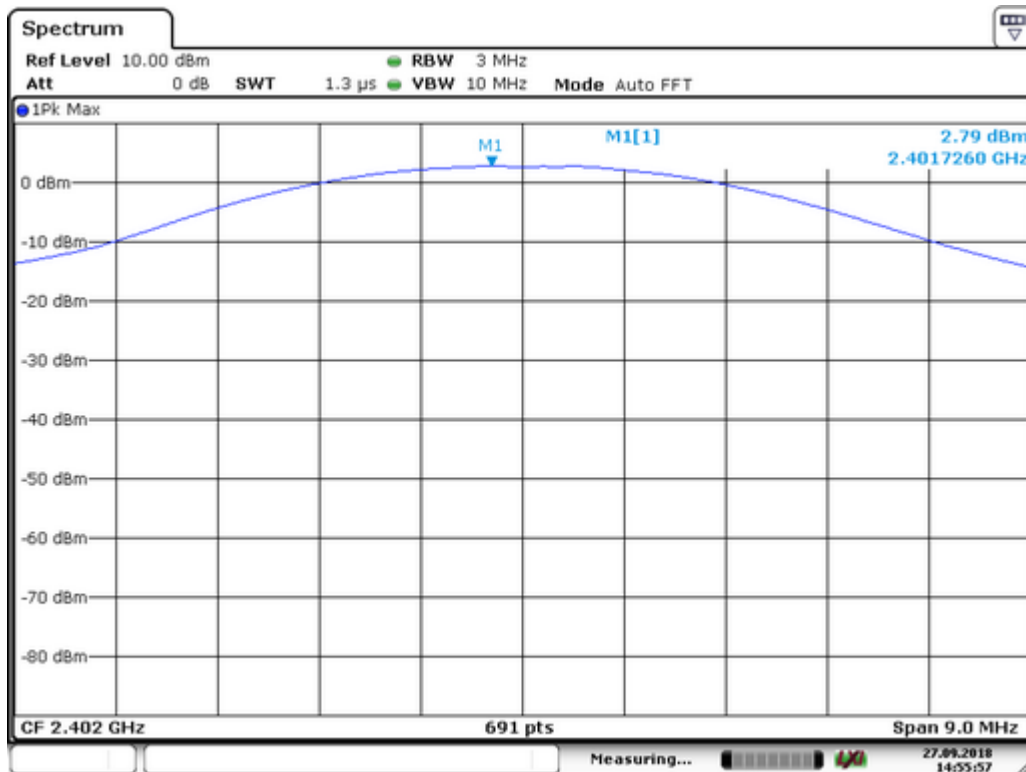

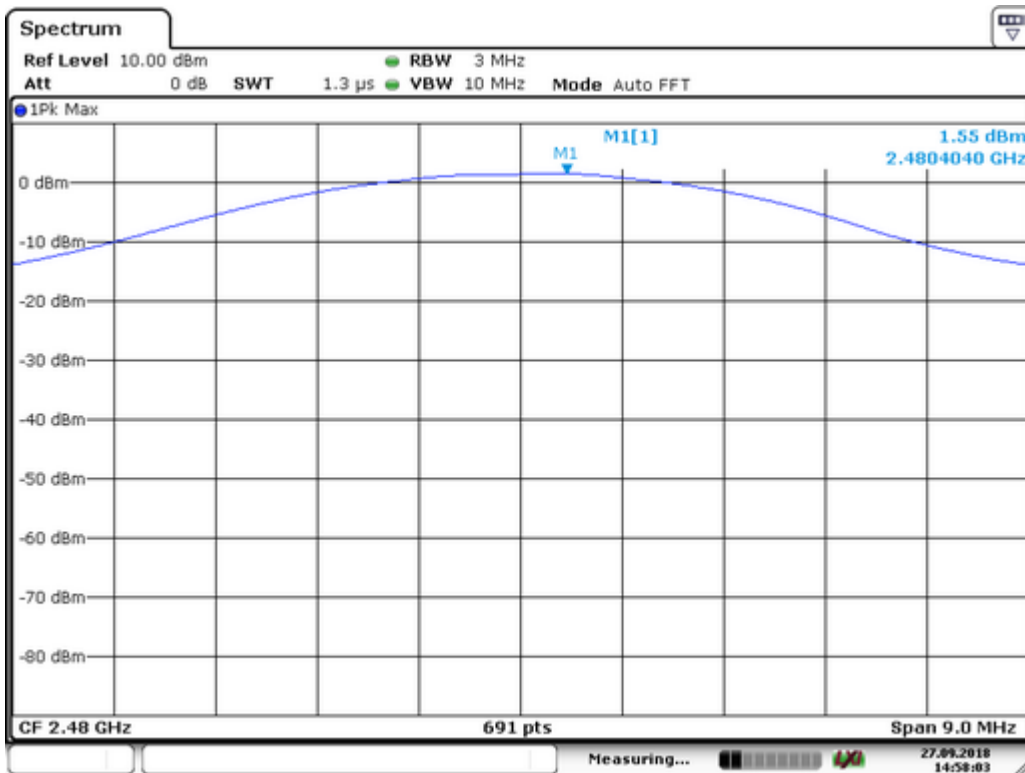
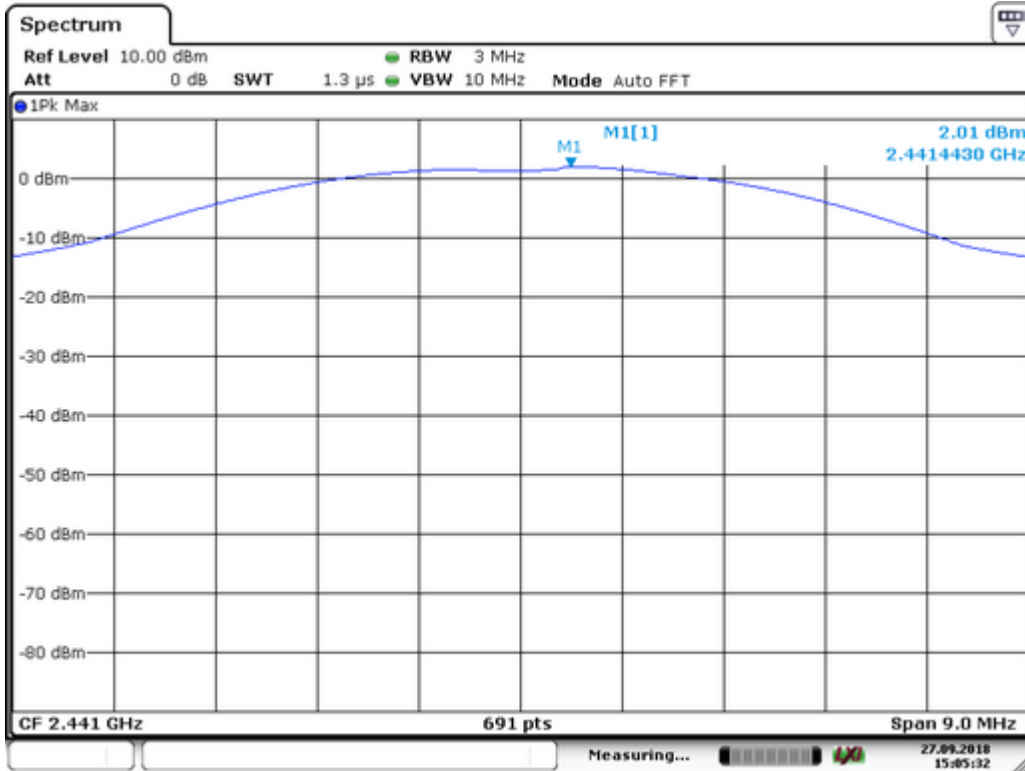

Spectrum Detector: PK Test Date : September 28, 2018
 Test By: Andy Temperature : 25 °C
 Test Result: PASS Humidity : 50 %
 Modulation: Π/4-DQPSK

| Channel number | Channel Frequency (MHz) | Peak Power output(dBm) | Peak Power output(mW) | Peak Power Limit(mW) | Pass/Fail |
|----------------|-------------------------|------------------------|-----------------------|----------------------|-----------|
| 01 | 2402 | 3.16 | 2.070 | 125 | PASS |
| 40 | 2441 | 3.00 | 1.995 | 125 | PASS |
| 79 | 2480 | 1.71 | 1.483 | 125 | PASS |

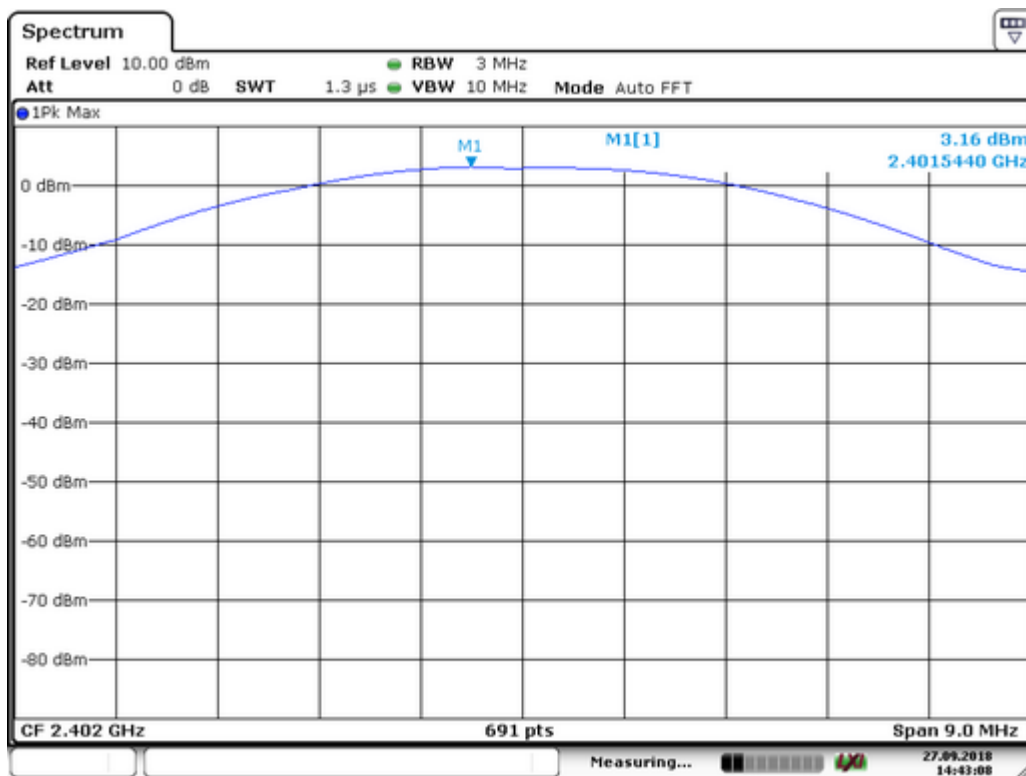

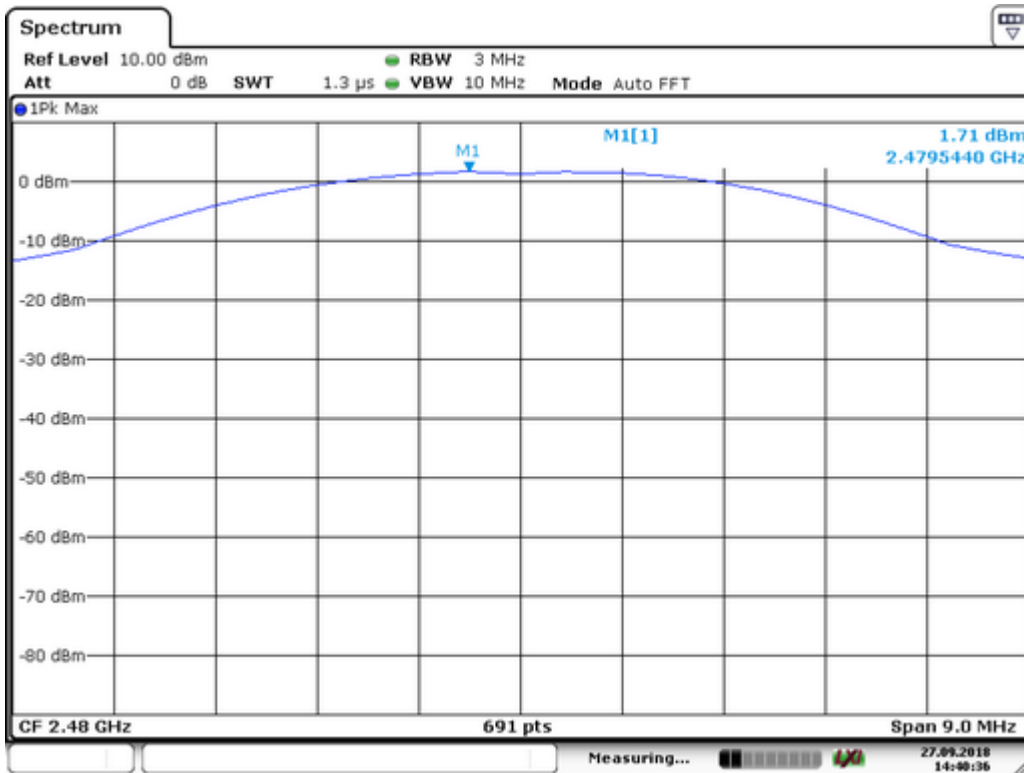
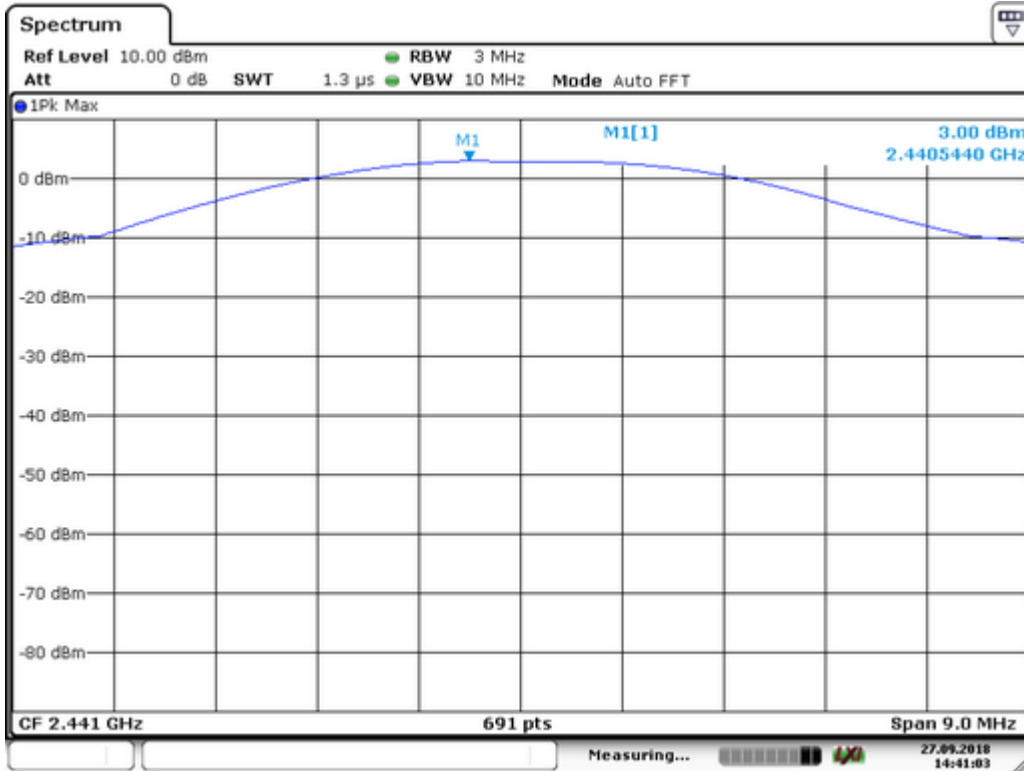

13. Band EDGE test

13.1 Measurement Procedure

For Conducted Test

1. The transmitter output is connected to a spectrum analyzer. The resolution bandwidth is set to 100KHz. The video bandwidth is set to 300KHz.
2. The spectrum from 30MHz to 26 GHz is investigated with the transmitter set to the lowest, middle, and highest channels.

| EMI Test Receiver | Setting |
|-------------------|----------|
| Attenuation | Auto |
| RBW | 100KHz |
| VBW | 300KHz |
| Detector | Peak |
| Trace | Max hold |

For Radiated emission Test

The EUT was placed on a styrofoam table which is 1.5m above ground plane.

The measurement procedure at the ban edges was simplified by performing the measurement in just one plot. Both, the in-band-emission and the unwanted emission were be encompassed by the span. After trace stabilization, the maximum peak was be determined by a peak detector and the value was marked by an appropriate limit line. The second limit line, which is 20dB below the first, marks the limit for the emissions in the unrestricted band. A maximum-peak-detector marks the highest emission in the unrestricted band next to the band edge.

The measurements were performed at the lower end of the 2.4GHz band.

Use the following spectrum analyzer settings:

For Restricted Band, When spectrum scanned above 1GHz setting resolution bandwidth 1MHz, video bandwidth 3MHz:

| EMI Test Receiver | Setting |
|-------------------|----------|
| Attenuation | Auto |
| RBW | 1MHz |
| VBW | 3MHz |
| Detector | Peak |
| Trace | Max hold |

For Non-Restricted Band, When spectrum scanned above 1GHz setting resolution bandwidth 100KHz, video bandwidth 300KHz:

| EMI Test Receiver | Setting |
|-------------------|----------|
| Attenuation | Auto |
| RBW | 100KHz |
| VBW | 300KHz |
| Detector | Peak |
| Trace | Max hold |

13.2 Test SET-UP (Block Diagram of Configuration)

For Conducted Test

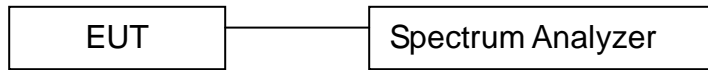

For Radiated emission Test

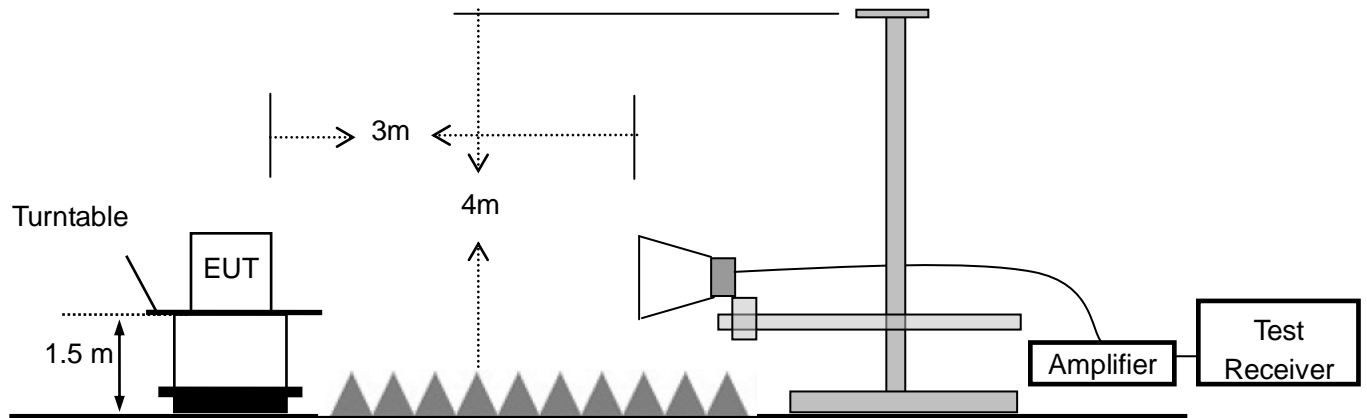

13.3 Measurement Equipment Used:

For Conducted Test

| EQUIPMENT TYPE | MFR | MODEL NUMBER | SERIAL NUMBER | Characteristics | LAST CAL. | CAL DUE. |
|-------------------|-----------------|--------------|---------------|-----------------|------------|------------|
| Spectrum Analyzer | Rohde & Schwarz | FSV30 | 1321.3008K | 10Hz-30GHz | 05/16/2018 | 05/15/2019 |
| Coaxial Cable | CDS | 79254 | 46107086 | 10Hz-30GHz | 05/16/2018 | 05/15/2019 |
| Antenna Connector | ARTHUR-YANG | 2244-N1TG1 | N/A | 10Hz-30GHz | 05/16/2018 | 05/15/2019 |

Remark: The temporary antenna connector is soldered on the PCB board in order to perform conducted tests and this temporary antenna connector is listed in the equipment list.

For Radiated emission Test

| Item | Equipment | Manufacturer | Model No. | Serial No. | Characteristics | Last Cal. | Cal. Interval |
|------|-----------------|-----------------|------------|------------------|-----------------|------------|---------------|
| 1 | Signal Analyzer | Rohde & Schwarz | FSV30 | 103040 | 9KHz-40GHz | 05/16/2018 | 1 Year |
| 2 | Horn Antenna | Schwarzbeck | BBHA9120D | 9120D-12 72 | 1GHz-18GHz | 05/16/2018 | 1 Year |
| 3 | Power Amplifier | LUNAR EM | LNA1G18-40 | J1010000 0081 | 1GHz-26.5GHz | 05/16/2018 | 1 Year |
| 4 | Cable | H+S | CBL-26 | N/A | 1GHz-26.5GHz | 05/16/2018 | 1 Year |
| 5 | Cable | H+S | CBL-26 | N/A | 1GHz-26.5GHz | 05/16/2018 | 1 Year |
| 6 | Cable | H+S | CBL-26 | N/A | 1GHz-26.5GHz | 05/16/2018 | 1 Year |

13.4 Measurement Results:

Refer to attached data chart.

| | | | |
|--------------------|------|---------------|--------------------|
| Spectrum Detector: | PK | Test Date : | September 29, 2018 |
| Test By: | Andy | Temperature : | 25 °C |
| Test Result: | PASS | Humidity : | 50 % |

1. Conducted Test

For Non-Hopping Mode:

| Frequency (MHz) | Modulation | Peak Power Output(dBm) | Result of Band edge(dBc) | Band edge Limit(dBc) |
|-----------------|------------|------------------------|--------------------------|----------------------|
| 2399.75 | GFSK | 2.29 | 28.94 | >20dBc |
| 2399.65 | pi/4-DQPSK | 2.5 | 29.63 | >20dBc |
| 2484.46 | GFSK | 0.73 | 27.2 | >20dBc |
| 2484.7 | pi/4-DQPSK | 0.92 | 28.15 | >20dBc |

Test plots of GFSK

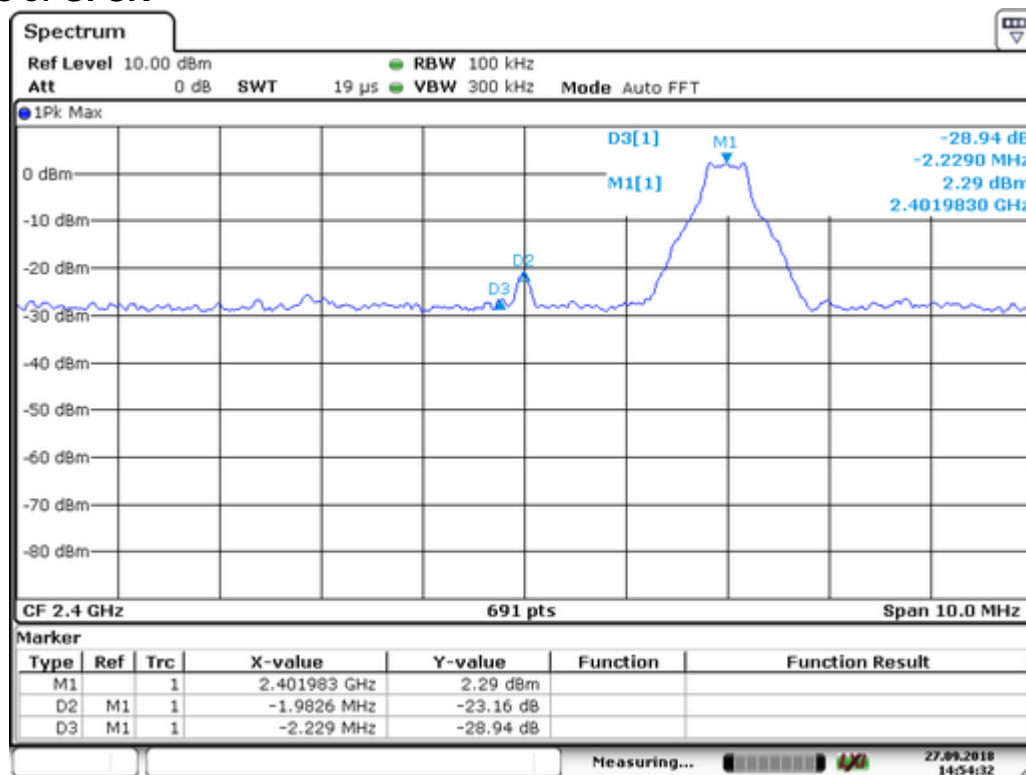

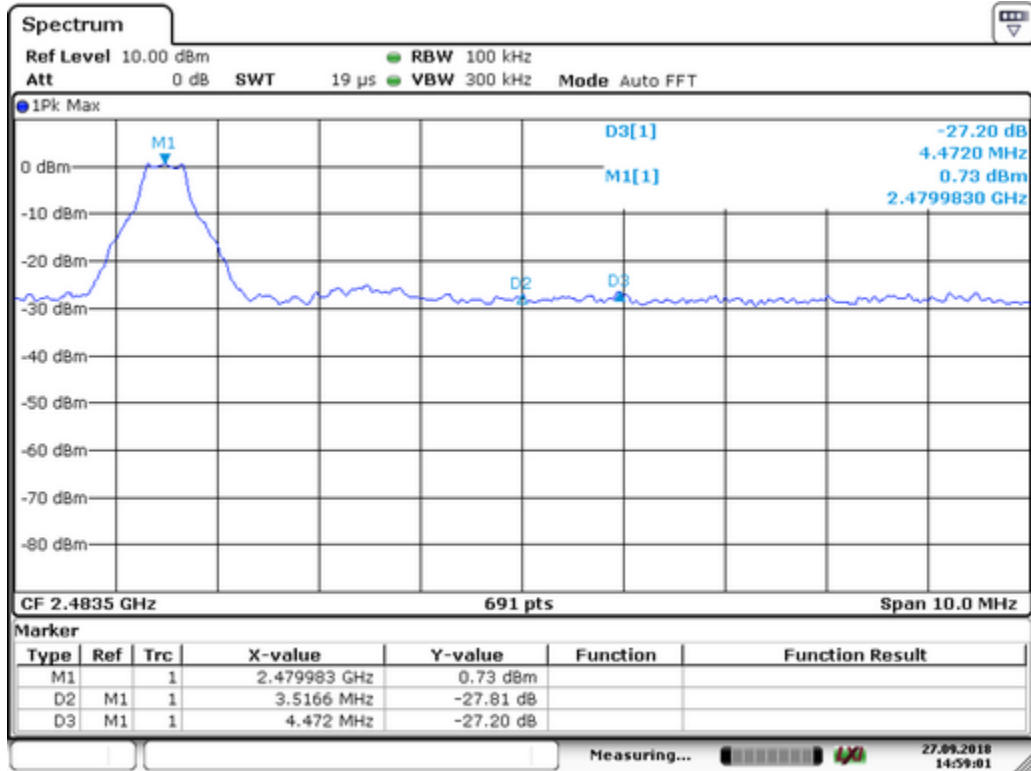

Test plots of pi/4-DQPSK

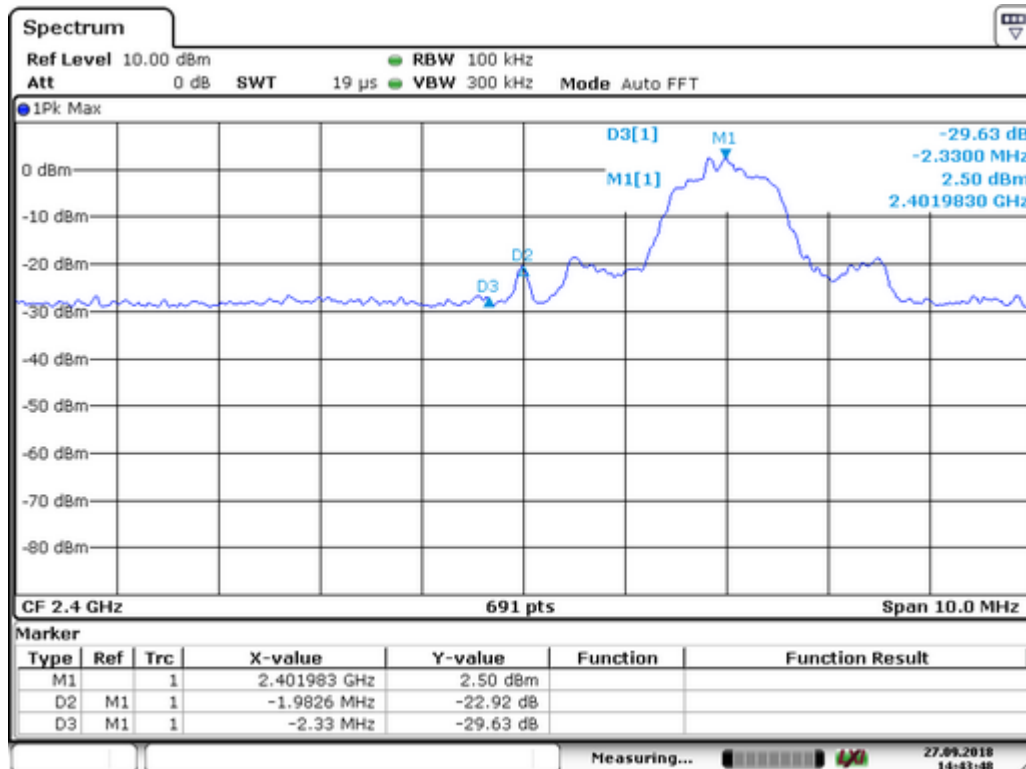

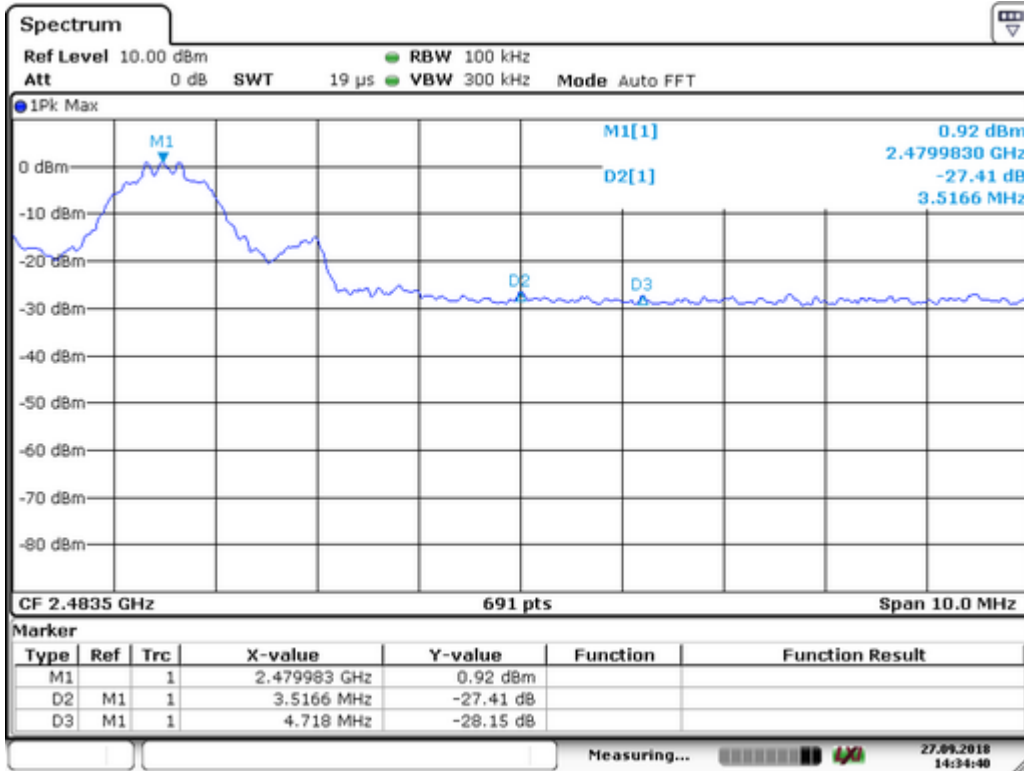

For Hopping Mode:

| Frequency (MHz) | Modulation | Peak Power Output(dBm) | Result of Band edge(dBc) | Band edge Limit(dBc) |
|-----------------|------------|------------------------|--------------------------|----------------------|
| 2399.7 | GFSK | 2.29 | 29.2 | >20dBc |
| 2399.05 | pi/4-DQPSK | 2.57 | 28.78 | >20dBc |
| 2485.24 | GFSK | 1.20 | 27.36 | >20dBc |
| 2484.2 | pi/4-DQPSK | 1.39 | 27.87 | >20dBc |

Test plots of GFSK

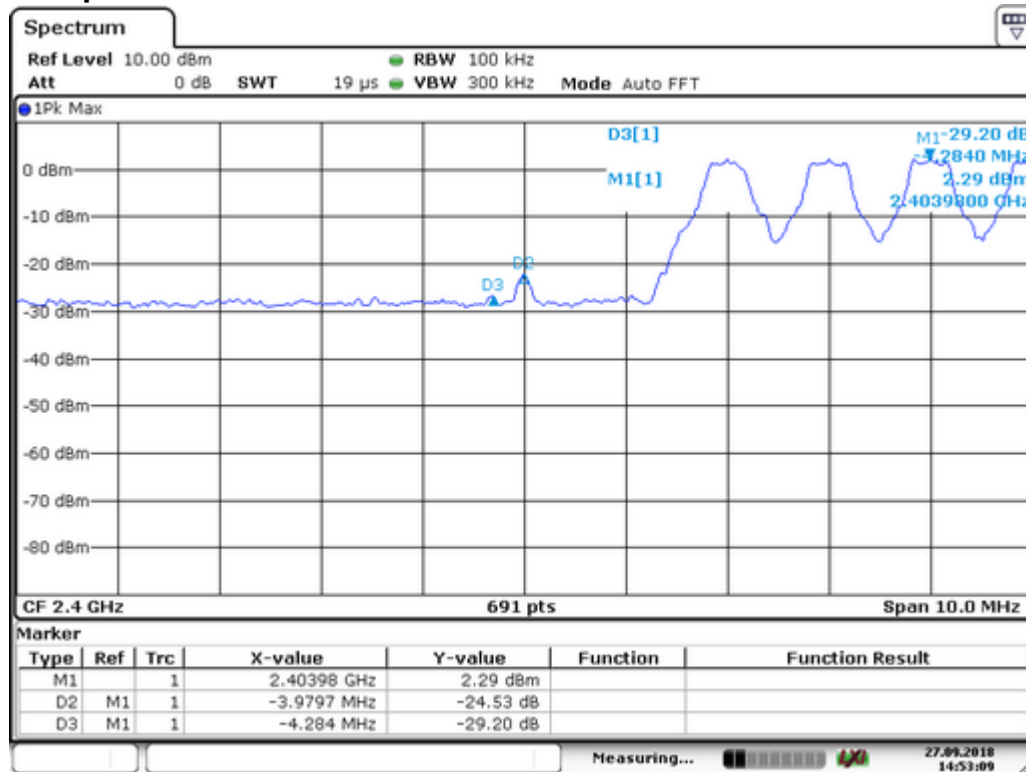

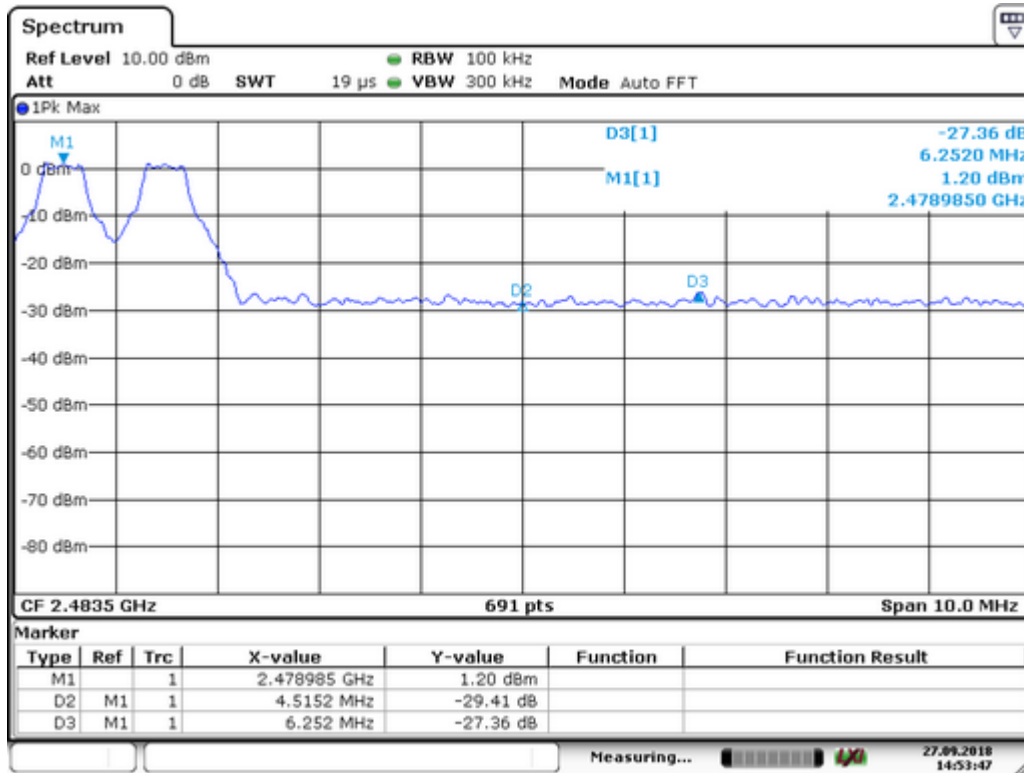

Test plots of pi/4-DQPSK

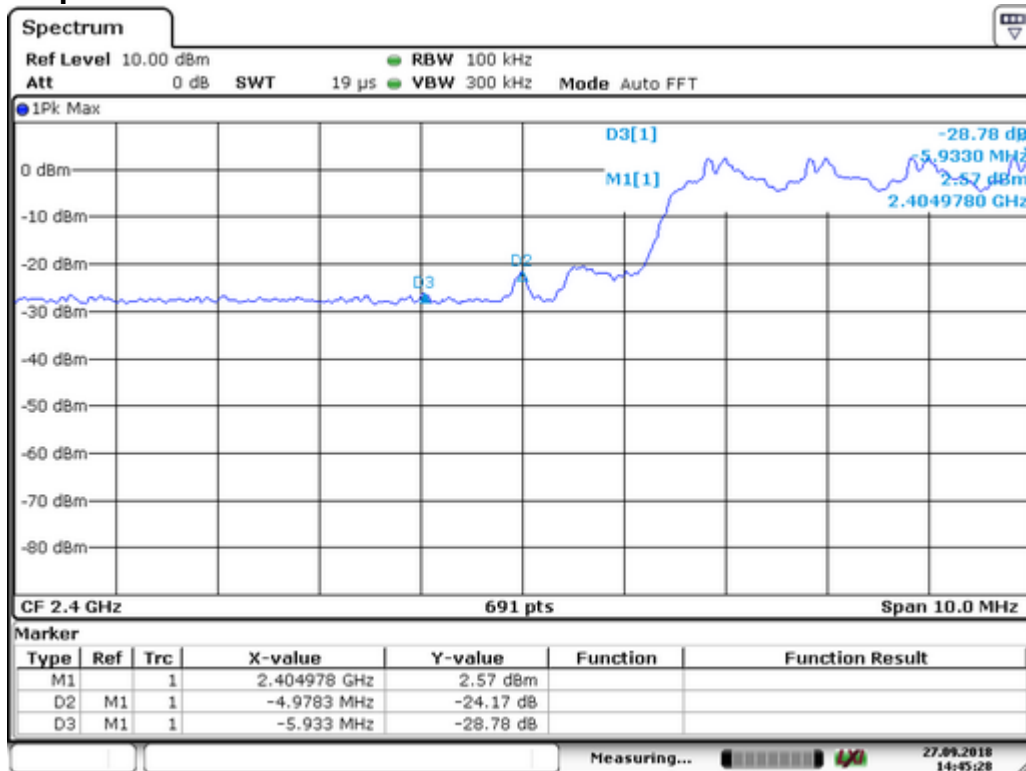

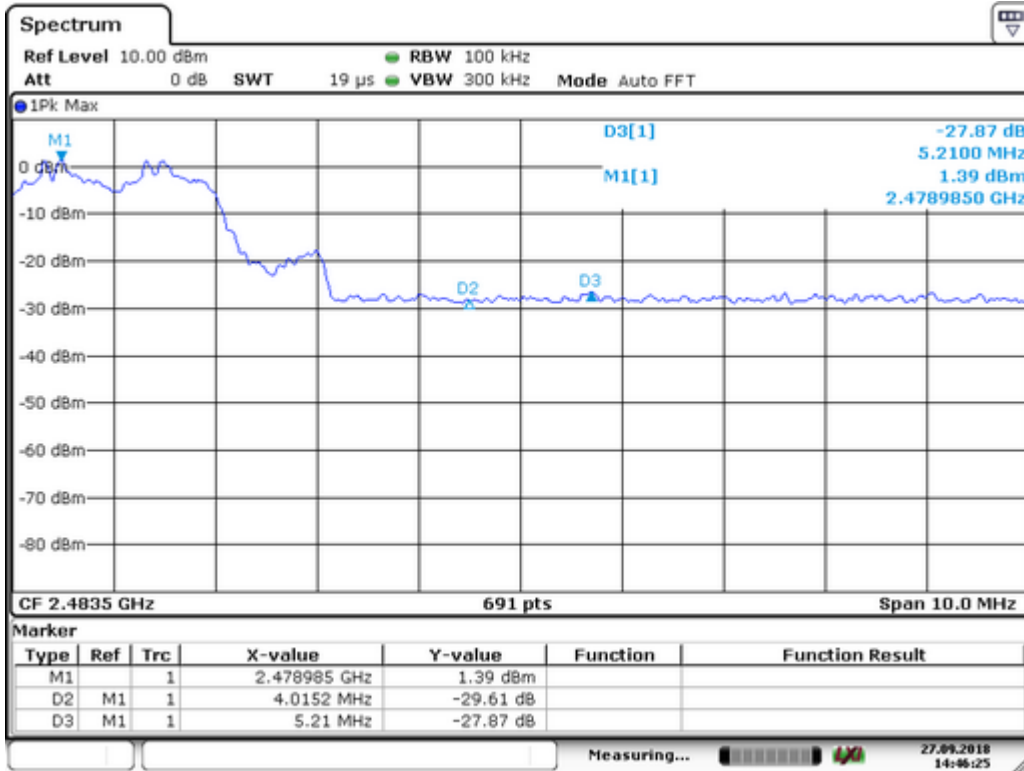

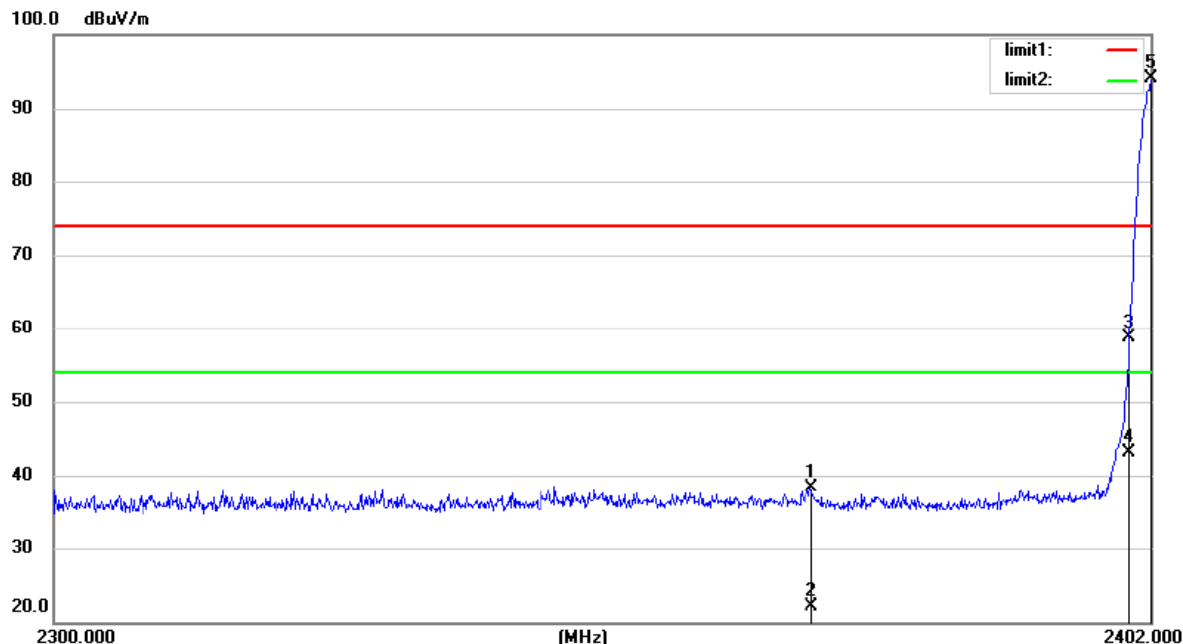

Site Chamber #1 Polarization: **Vertical** Temperature: 26
 Limit: (RE)FCC PART 15 C 3m PEAK Power: Battery 3.7V Humidity: 55 %
 Mode: TX2402
 Note:

| No. | Mk. | Freq. MHz | Reading Level dBuV | Correct Factor dB | Measure- ment dBuV/m | Limit dBuV/m | Over dB | Detector | Antenna Height cm | Table Degree | Comment |
|-----|-----|--------------|--------------------------|-------------------------|----------------------------|-----------------|------------|----------|-------------------------|-----------------|---------|
| 1 | | 2369.972 | 57.02 | -18.68 | 38.34 | 74.00 | -35.66 | peak | | 0 | |
| 2 | | 2369.972 | 40.70 | -18.68 | 22.02 | 54.00 | -31.98 | AVG | | 0 | |
| 3 | | 2400.000 | 77.14 | -18.50 | 58.64 | 74.00 | -15.36 | peak | | 0 | |
| 4 | | 2400.000 | 61.56 | -18.50 | 43.06 | 54.00 | -10.94 | AVG | | 0 | |
| 5 | * | 2402.000 | 112.65 | -18.49 | 94.16 | 74.00 | 20.16 | peak | | 0 | |

*:Maximum data x:Over limit !:over margin

Operator: Washington

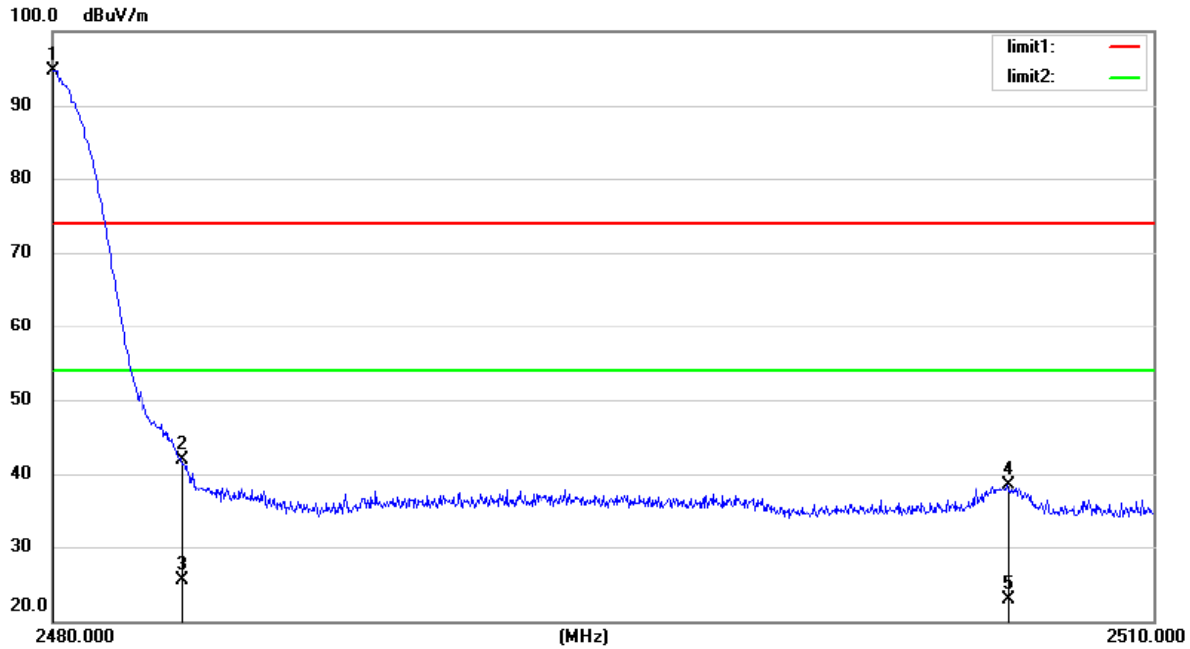

Site Chamber #1 Polarization: **Horizontal** Temperature: 26
 Limit: (RE)FCC PART 15 C 3m PEAK Power: Battery 3.7V Humidity: 55 %
 Mode: TX2480
 Note:

| No. | Mk. | Freq. | Reading Level | Correct Factor | Measurement | Limit | Over | Antenna Height | Table Degree | Comment |
|-----|-----|----------|---------------|----------------|-------------|--------|--------|----------------|--------------|---------|
| | | MHz | dBuV | dB | dBuV/m | dBuV/m | dB | cm | degree | |
| 1 | * | 2480.000 | 112.77 | -18.03 | 94.74 | 74.00 | 20.74 | peak | 0 | |
| 2 | | 2483.500 | 59.99 | -18.01 | 41.98 | 74.00 | -32.02 | peak | 0 | |
| 3 | | 2483.500 | 43.60 | -18.01 | 25.59 | 54.00 | -28.41 | AVG | 0 | |
| 4 | | 2506.010 | 56.37 | -17.89 | 38.48 | 74.00 | -35.52 | peak | 0 | |
| 5 | | 2506.010 | 40.87 | -17.89 | 22.98 | 54.00 | -31.02 | AVG | 0 | |

*:Maximum data x:Over limit !:over margin

Operator: Washington

For Hopping Mode:

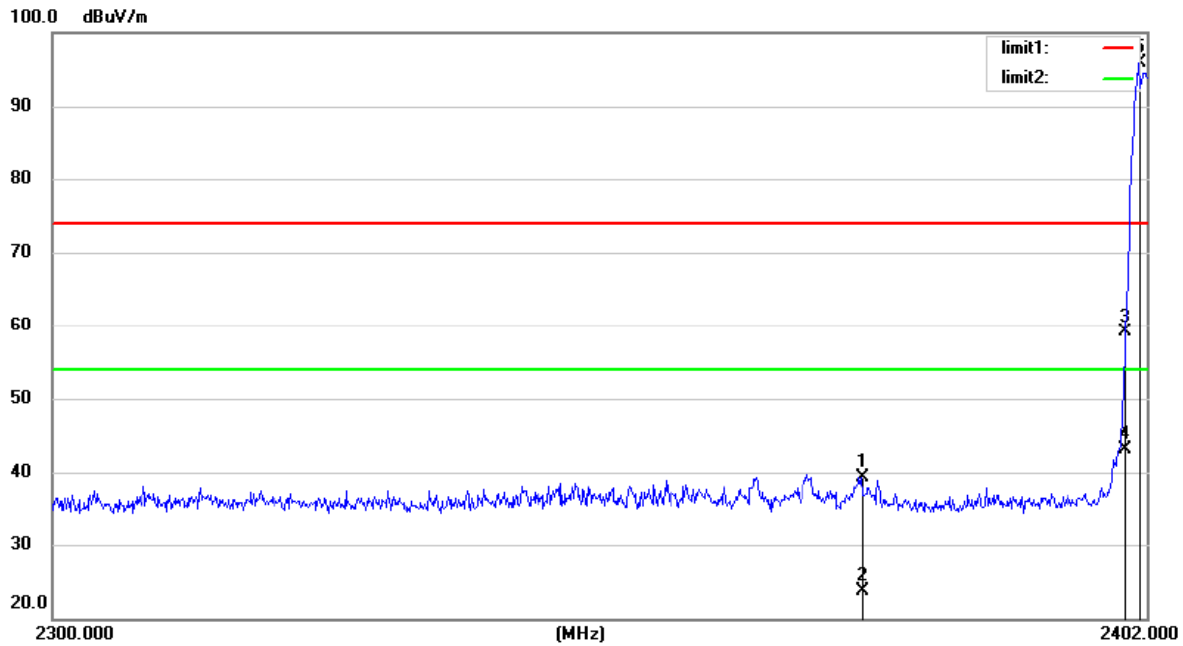

Site Chamber #1 Polarization: **Horizontal** Temperature: 26
 Limit: (RE)FCC PART 15 C 3m_PEAK Power: Battery 3.7V Humidity: 55 %
 Mode:Hopping
 Note:

| No. | Mk. | Freq. | Reading Level | Correct Factor | Measurement | Limit | Over | Antenna Height | Table Degree | |
|-----|-----|----------|---------------|----------------|-------------|--------|--------|----------------|--------------|---------|
| | | MHz | dBuV | dB | dBuV/m | dBuV/m | dB | cm | degree | Comment |
| 1 | | 2374.970 | 57.90 | -18.64 | 39.26 | 74.00 | -34.74 | peak | 0 | |
| 2 | | 2374.970 | 42.30 | -18.64 | 23.66 | 54.00 | -30.34 | AVG | 0 | |
| 3 | | 2400.000 | 77.70 | -18.50 | 59.20 | 74.00 | -14.80 | peak | 0 | |
| 4 | | 2400.000 | 61.69 | -18.50 | 43.19 | 54.00 | -10.81 | AVG | 0 | |
| 5 | * | 2401.286 | 114.45 | -18.49 | 95.96 | 74.00 | 21.96 | peak | 0 | |

*:Maximum data x:Over limit !:over margin

Operator: Washington

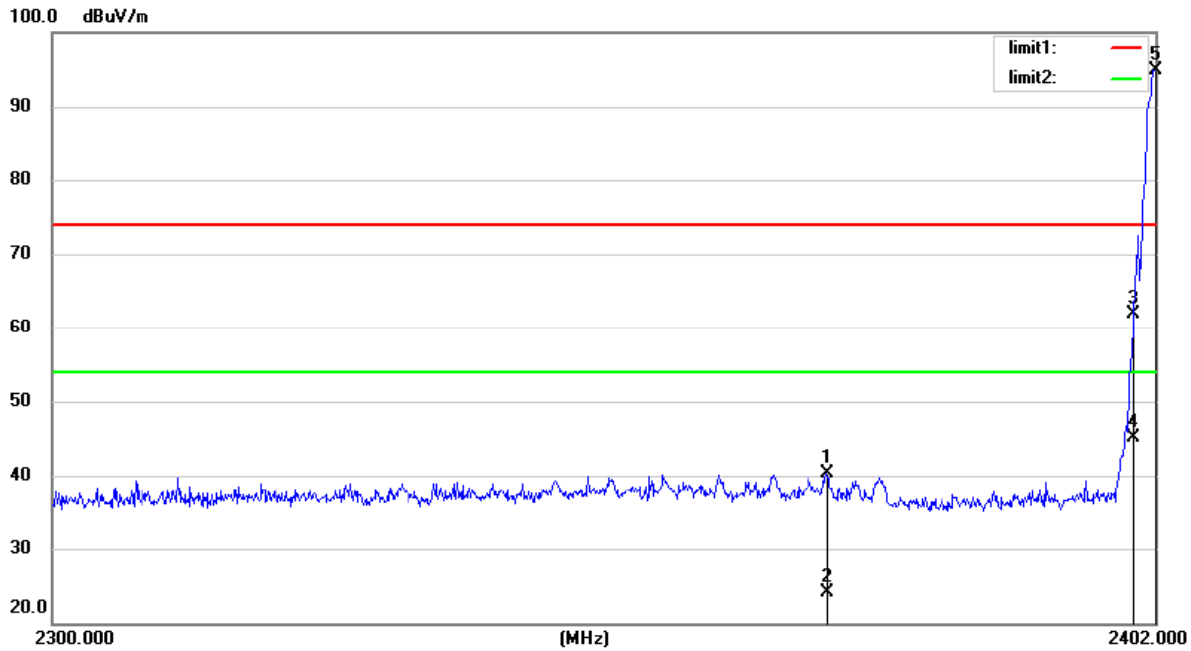

Site Chamber #1 Polarization: **Vertical** Temperature: 26
 Limit: (RE)FCC PART 15 C 3m_PEAK Power: Battery 3.7V Humidity: 55 %
 Mode:Hopping
 Note:

| No. | Mk. | Freq. | Reading Level | Correct Factor | Measurement | Limit | Over | Antenna Height | Table Degree | |
|-----|-----|----------|---------------|----------------|-------------|--------|--------|----------------|--------------|---------|
| | | MHz | dBuV | dB | dBuV/m | dBuV/m | dB | cm | degree | Comment |
| 1 | | 2371.196 | 58.96 | -18.67 | 40.29 | 74.00 | -33.71 | peak | 0 | |
| 2 | | 2371.196 | 42.69 | -18.67 | 24.02 | 54.00 | -29.98 | AVG | 0 | |
| 3 | | 2400.000 | 80.42 | -18.50 | 61.92 | 74.00 | -12.08 | peak | 0 | |
| 4 | | 2400.000 | 63.58 | -18.50 | 45.08 | 54.00 | -8.92 | AVG | 0 | |
| 5 | * | 2402.000 | 113.41 | -18.49 | 94.92 | 74.00 | 20.92 | peak | 0 | |

*:Maximum data x:Over limit !:over margin

Operator: Washington

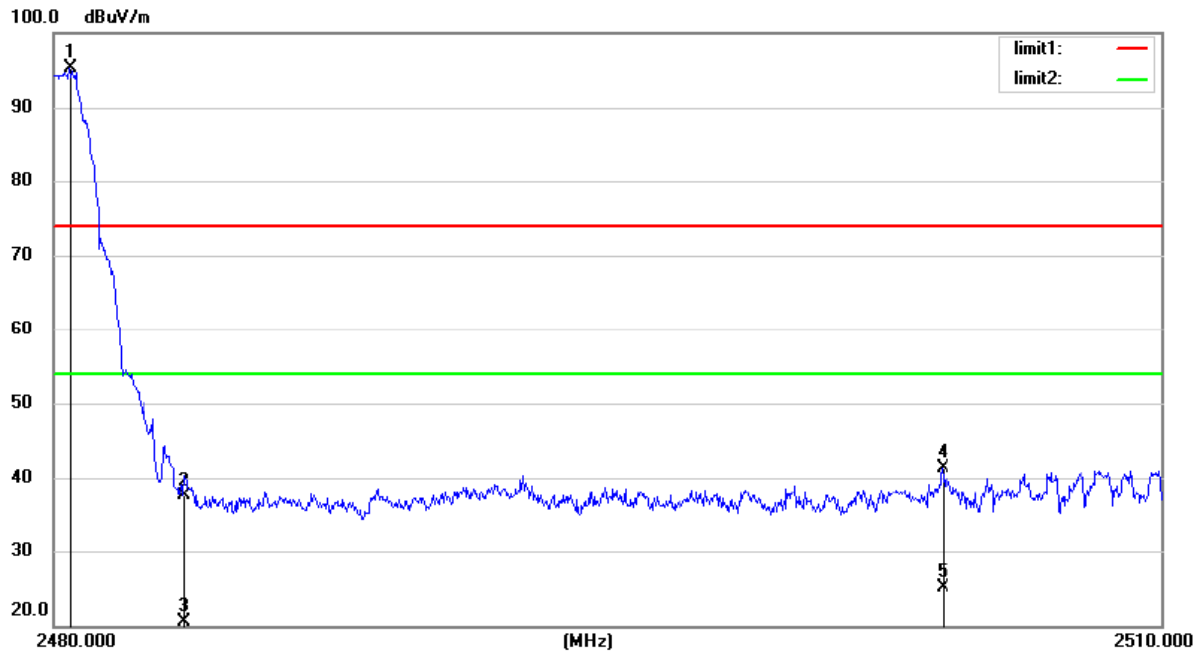

Site Chamber #1 Polarization: **Vertical** Temperature: 26
 Limit: (RE)FCC PART 15 C 3m PEAK Power: Battery 3.7V Humidity: 55 %
 Mode:Hopping
 Note:

| No. | Mk. | Freq. | Reading Level | Correct Factor | Measurement | Limit | Over | Antenna Height | Table Degree | |
|-----|-----|----------|---------------|----------------|-------------|--------|--------|----------------|--------------|---------|
| | | MHz | dBuV | dB | dBuV/m | dBuV/m | dB | cm | degree | Comment |
| 1 | * | 2480.420 | 113.31 | -18.03 | 95.28 | 74.00 | 21.28 | | | peak |
| 2 | | 2483.500 | 55.55 | -18.01 | 37.54 | 74.00 | -36.46 | | | peak |
| 3 | | 2483.500 | 38.50 | -18.01 | 20.49 | 54.00 | -33.51 | | | AVG |
| 4 | | 2504.060 | 59.17 | -17.90 | 41.27 | 74.00 | -32.73 | | | peak |
| 5 | | 2504.060 | 42.96 | -17.90 | 25.06 | 54.00 | -28.94 | | | AVG |

*:Maximum data x:Over limit !:over margin

Operator: Washington

14. Antenna Application

14.1 Antenna requirement

The EUT'S antenna is met the requirement of FCC part 15C section 15.203 and 15.247.

FCC part 15C section 15.247 requirements:

Systems operating in the 2402-2480MHz band that are used exclusively for fixed, point-to-point operations may employ transmitting antennas with directional gain greater than 6dBi provided the maximum peak output power of the intentional radiator is reduced by 1dB for every 3dB that the directional gain of the antenna exceeds 6dBi.

14.2 Result

The EUT's antenna, permanent attached antenna, used a PCB antenna and integrated on PCB, The antenna's gain is -0.58dBi and meets the requirement.

APPENDIX I (Photos of EUT)





