

FCC Radio Test Report

FCC ID: 2ABHA0010

Original Grant

Report No. : TB-FCC148899
Applicant : NINGBO CSTAR IMP&EXP CO., LTD.
Equipment Under Test (EUT)
EUT Name : Bluetooth Speaker with LED Lights
Model No. : RM89627
Series Model No. : N/A
Brand Name : Cstar
Receipt Date : 2016-07-08
Test Date : 2016-07-09 to 2016-07-27
Issue Date : 2016-07-28
Standards : FCC Part 15: 2015, Subpart C(15.247)
Test Method : ANSI C63.10: 2013
Conclusions : **PASS**

In the configuration tested, the EUT complied with the standards specified above,
The EUT technically complies with the FCC requirements

Test/Witness Engineer :

WANG SU

Approved & Authorized :

Ray Shi



This report details the results of the testing carried out on one sample. The results contained in this test report do not relate to other samples of the same product. The manufacturer should ensure that all products in series production are in conformity with the product sample detailed in the report.

Contents

CONTENTS	2
1. GENERAL INFORMATION ABOUT EUT	4
1.1 Client Information.....	4
1.2 General Description of EUT (Equipment Under Test)	4
1.3 Block Diagram Showing the Configuration of System Tested.....	5
1.4 Description of Support Units	6
1.5 Description of Test Mode.....	6
1.6 Description of Test Software Setting	7
1.7 Measurement Uncertainty	7
1.8 Test Facility.....	8
2. TEST SUMMARY	9
3. TEST EQUIPMENT	10
4. CONDUCTED EMISSION TEST	11
4.1 Test Standard and Limit.....	11
4.2 Test Setup.....	11
4.3 Test Procedure.....	11
4.4 EUT Operating Mode	12
4.5 Test Data.....	12
5. RADIATED EMISSION TEST	17
5.1 Test Standard and Limit.....	17
5.2 Test Setup.....	18
5.3 Test Procedure.....	19
5.4 EUT Operating Condition	19
6. RESTRICTED BANDS REQUIREMENT	36
6.1 Test Standard and Limit.....	36
6.2 Test Setup.....	36
6.3 Test Procedure.....	36
6.4 EUT Operating Condition	37
6.4 Test Data.....	37
7. NUMBER OF HOPPING CHANNEL	50
7.1 Test Standard and Limit.....	50
7.2 Test Setup.....	50
7.3 Test Procedure.....	50
7.4 EUT Operating Condition	50
7.5 Test Data.....	50
8. AVERAGE TIME OF OCCUPANCY	52
8.1 Test Standard and Limit.....	52
8.2 Test Setup.....	52
8.3 Test Procedure.....	52

8.4 EUT Operating Condition	52
8.5 Test Data.....	53
9. CHANNEL SEPARATION AND BANDWIDTH TEST	65
9.1 Test Standard and Limit.....	65
9.2 Test Setup.....	65
9.3 Test Procedure.....	65
9.4 EUT Operating Condition	65
9.5 Test Data.....	66
10. PEAK OUTPUT POWER TEST.....	74
10.1 Test Standard and Limit	74
10.2 Test Setup.....	74
10.3 Test Procedure.....	74
10.4 EUT Operating Condition	74
10.5 Test Data.....	75
11. ANTENNA REQUIREMENT.....	79
11.1 Standard Requirement.....	79
11.2 Antenna Connected Construction.....	79

1. General Information about EUT

1.1 Client Information

Applicant : NINGBO CSTAR IMP&EXP CO., LTD.
Address : Floor 4, Building E, No. 655-90, Qiming Road, Yinzhou Investment & Innovation Center, China
Manufacturer : ShenZhen C-Star Electronic Tech. co., Ltd
Address : 2, 3/F, Building B, No. 2 Bada Industrial Park, Yongfu Road, Heping Community, Fuyong Town, Baoan District, Shenzhen, China

1.2 General Description of EUT (Equipment Under Test)

EUT Name	:	Bluetooth Speaker with LED Lights			
Models No.	:	RM89627			
Model Difference	:	N/A			
Product Description	:	Operation Frequency: Bluetooth 2.1+EDR: 2402~2480MHz			
	:	Number of Channel:	Bluetooth:79 Channels See Note 2		
	:	Max Peak Output Power:	Bluetooth: 2.256 dBm(π /4-DQPSK)		
	:	Antenna Gain:	0 dBi PCB Antenna		
	:	Modulation Type:	GFSK 1Mbps(1 Mbps) π /4-DQPSK(2 Mbps)		
Power Supply	:	DC Voltage supplied from Host System by USB cable. DC power by Li-ion Battery.			
Power Rating	:	DC 5.0V by USB cable. DC 3.7V by 450mAh Li-ion Battery.			
Connecting I/O Port(S)	:	Please refer to the User's Manual			

Note:

- (1) For a more detailed features description, please refer to the manufacturer's specifications or the User's Manual.
- (2) Channel List:

Bluetooth Channel List					
Channel	Frequency (MHz)	Channel	Frequency (MHz)	Channel	Frequency (MHz)
00	2402	27	2429	54	2456
01	2403	28	2430	55	2457
02	2404	29	2431	56	2458
03	2405	30	2432	57	2459
04	2406	31	2433	58	2460

05	2407	32	2434	59	2461
06	2408	33	2435	60	2462
07	2409	34	2436	61	2463
08	2410	35	2437	62	2464
09	2411	36	2438	63	2465
10	2412	37	2439	64	2466
11	2413	38	2440	65	2467
12	2414	39	2441	66	2468
13	2415	40	2442	67	2469
14	2416	41	2443	68	2470
15	2417	42	2444	69	2471
16	2418	43	2445	70	2472
17	2419	44	2446	71	2473
18	2420	45	2447	72	2474
19	2421	46	2448	73	2475
20	2422	47	2449	74	2476
21	2423	48	2450	75	2477
22	2424	49	2451	76	2478
23	2425	50	2452	77	2479
24	2426	51	2453	78	2480
25	2427	52	2454		
26	2428	53	2455		

(3) The Antenna information about the equipment is provided by the applicant.

1.3 Block Diagram Showing the Configuration of System Tested

USB Charging with TX Mode

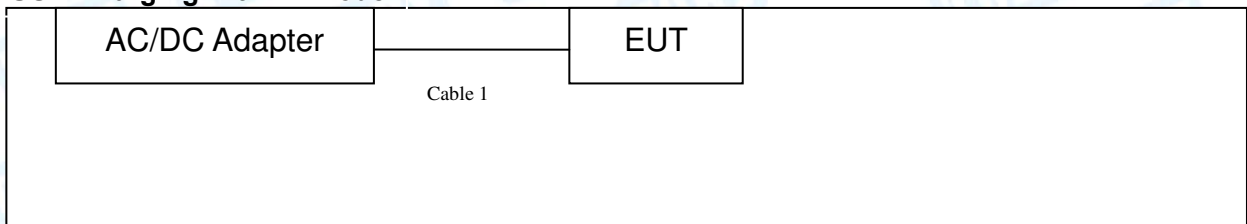

TX Mode

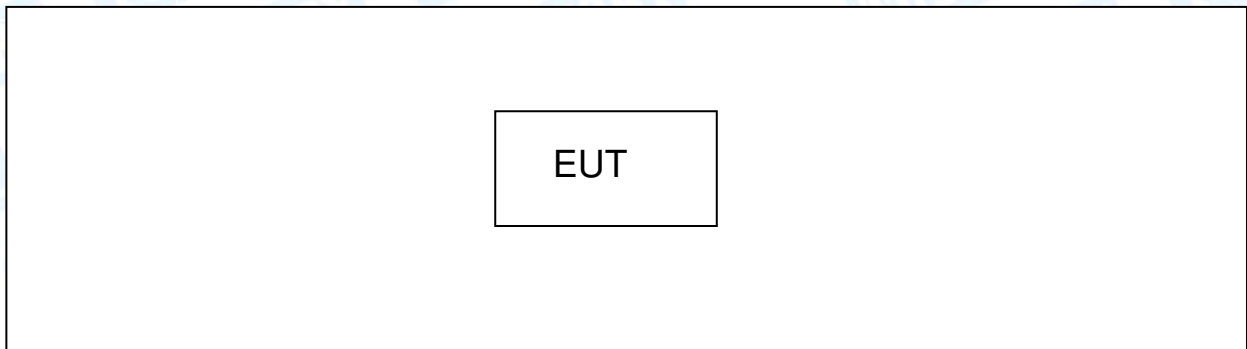

1.4 Description of Support Units

Equipment Information				
Name	Model	FCC ID/DOC	Manufacturer	Used “√”
AC/DC Adapter	TEKA012	----	TEKA	√
Cable Information				
Number	Shielded Type	Ferrite Core	Length	Note
Cable 1	NO	NO	0.8M	Accessorise

1.5 Description of Test Mode

To investigate the maximum EMI emission characteristics generates from EUT, the test system was pre-scanning tested base on the consideration of following EUT operation mode or test configuration mode which possible have effect on EMI emission level. Each of these EUT operation mode(s) or test configuration mode(s) mentioned follow was evaluated respectively.

For Conducted Test	
Final Test Mode	Description
Mode 1	USB Charging with TX GFSK Mode

For Radiated Test	
Final Test Mode	Description
Mode 1	USB Charging with TX GFSK Mode
Mode 2	TX Mode(GFSK) Channel 00/39/78
Mode 3	TX Mode($\pi/4$ -DQPSK) Channel 00/39/78
Mode 4	Hopping Mode(GFSK)
Mode5	Hopping Mode($\pi/4$ -DQPSK)

Note:

- For all test, we have verified the construction and function in typical operation. And all the test modes were carried out with the EUT in transmitting operation in maximum power with all kinds of data rate. We have pretested all the test mode above.
According to ANSI C63.10 standards, the measurements are performed at the highest, middle, lowest available channels, and the worst case data rate as follows:
TX Mode: GFSK (1 Mbps)
TX Mode: $\pi/4$ -DQPSK (2 Mbps)
- The EUT is considered a portable unit; it was pre-tested on the positioned of each 3 axis, X-plane, Y-plane and Z-plane. The worst case was found positioned on X-plane as the normal use. Therefore only the test data of this X-plane was used for radiated emission measurement test.

1.6 Description of Test Software Setting

During testing channel & Power controlling software provided by the customer was used to control the operating channel as well as the output power level. The RF output power selection is for the setting of RF output power expected by the customer and is going to be fixed on the firmware of the final end product power parameters of Bluetooth mode.

Test Software Version	FCC Assist 1.5		
	2402 MHz	2441MHz	2480 MHz
Frequency	2402 MHz	2441MHz	2480 MHz
GFSK	DEF	DEF	DEF
$\pi/4$ -DQPSK	DEF	DEF	DEF

1.7 Measurement Uncertainty

The reported uncertainty of measurement $y \pm U$, where expanded uncertainty U is based on a standard uncertainty multiplied by a coverage factor of $k=2$, providing a level of confidence of approximately 95 %.

Test Item	Parameters	Expanded Uncertainty (U_{Lab})
Conducted Emission	Level Accuracy: 9kHz~150kHz	± 3.42 dB
	150kHz to 30MHz	± 3.42 dB
Radiated Emission	Level Accuracy: 9kHz to 30 MHz	± 4.60 dB
Radiated Emission	Level Accuracy: 30MHz to 1000 MHz	± 4.40 dB
Radiated Emission	Level Accuracy: Above 1000MHz	± 4.20 dB

1.8 Test Facility

The testing report were performed by the Shenzhen Toby Technology Co., Ltd., in their facilities located at 1A/F., Bldg.6, Yusheng Industrial Zone, The National Road No.107 Xixiang Section 467, Xixiang, Bao'an, Shenzhen, Guangdong, China. At the time of testing, the following bodies accredited the Laboratory:

CNAS (L5813)

The Laboratory has been accredited by CNAS to ISO/IEC 17025: 2005 General Requirements for the Competence of Testing and Calibration Laboratories for the competence in the field of testing. And the Registration No.: CNAS L5813.

FCC List No.: (811562)

The Laboratory is listed in the United States of American Federal Communications Commission (FCC), and the registration number is 811562.

IC Registration No.: (11950A-1)

The Laboratory has been registered by Certification and Engineering Bureau of Industry Canada for radio equipment testing. The site registration: Site# 11950A-1.

2. Test Summary

FCC Part 15 Subpart C(15.247)/ RSS 247 Issue 1				
Standard Section		Test Item	Judgment	Remark
FCC	IC			
15.203		Antenna Requirement	PASS	N/A
15.207	RSS-GEN 7.2.2	Conducted Emission	PASS	N/A
15.205	RSS-Gen 7.2.3	Restricted Bands	PASS	N/A
15.247(a)(1)	RSS 247 5.1 (2)	Hopping Channel Separation	PASS	N/A
15.247(a)(1)	RSS 247 5.1 (4)	Dwell Time	PASS	N/A
15.247(b)(1)	RSS 247 5.4 (2)	Peak Output Power	PASS	N/A
15.247(b)(1)	RSS 247 5.1 (4)	Number of Hopping Frequency	PASS	N/A
15.247(c)	RSS 247 5.5	Radiated Spurious Emission	PASS	N/A
15.247(a)	RSS 247 5.1 (1)	99% Occupied Bandwidth & 20dB Bandwidth	PASS	99%OBW GFSK:891.8281kHz π /4-DQPSK: 1194.20kHz

Note: N/A is an abbreviation for Not Applicable.

3. Test Equipment

Conducted Emission Test					
Equipment	Manufacturer	Model No.	Serial No.	Last Cal.	Cal. Due Date
EMI Test Receiver	Rohde & Schwarz	ESCI	100321	Aug. 07, 2015	Aug. 06, 2016
RF Switching Unit	Compliance Direction Systems Inc	RSU-A4	34403	Aug. 07, 2015	Aug. 06, 2016
AMN	SCHWARZBECK	NNBL 8226-2	8226-2/164	Aug. 07, 2015	Aug. 06, 2016
LISN	Rohde & Schwarz	ENV216	101131	Aug. 08, 2015	Aug. 07, 2016
Radiation Emission Test					
Equipment	Manufacturer	Model No.	Serial No.	Last Cal.	Cal. Due Date
Spectrum Analyzer	Agilent	E4407B	MY45106456	Aug. 07, 2015	Aug. 06, 2016
EMI Test Receiver	Rohde & Schwarz	ESCI	100010/007	Aug. 07, 2015	Aug. 06, 2016
Bilog Antenna	ETS-LINDGREN	3142E	00117537	Mar. 26, 2016	Mar. 25, 2017
Bilog Antenna	ETS-LINDGREN	3142E	00117542	Mar. 26, 2016	Mar. 25, 2017
Horn Antenna	ETS-LINDGREN	3117	00143207	Mar. 26, 2016	Mar. 25, 2017
Horn Antenna	ETS-LINDGREN	3117	00143209	Mar. 26, 2016	Mar. 25, 2017
Pre-amplifier	Sonoma	310N	185903	Mar. 26, 2016	Mar. 25, 2017
Pre-amplifier	HP	8447B	3008A00849	Mar. 26, 2016	Mar. 25, 2017
Cable	HUBER+SUHNER	100	SUCOFLEX	Mar. 26, 2016	Mar. 25, 2017
Positioning Controller	ETS-LINDGREN	2090	N/A	N/A	N/A
Antenna Conducted Emission					
Equipment	Manufacturer	Model No.	Serial No.	Last Cal.	Cal. Due Date
Spectrum Analyzer	Agilent	E4407B	MY45106456	Aug. 07, 2015	Aug. 06, 2016
EMI Test Receiver	Rohde & Schwarz	ESCI	100010/007	Aug. 07, 2015	Aug. 06, 2016
Power Meter	Anritsu	ML2495A	25406005	Aug.07, 2015	Aug.06, 2016
Power Sensor	Anritsu	ML2411B	25406005	Aug.07, 2015	Aug.06, 2016

4. Conducted Emission Test

4.1 Test Standard and Limit

4.1.1 Test Standard
FCC Part 15.207

4.1.2 Test Limit

Conducted Emission Test Limit

Frequency	Maximum RF Line Voltage (dB μ V)	
	Quasi-peak Level	Average Level
150kHz~500kHz	66 ~ 56 *	56 ~ 46 *
500kHz~5MHz	56	46
5MHz~30MHz	60	50

Notes:

- (1) *Decreasing linearly with logarithm of the frequency.
- (2) The lower limit shall apply at the transition frequencies.
- (3) The limit decrease in line with the logarithm of the frequency in the range of 0.15 to 0.50MHz.

4.2 Test Setup

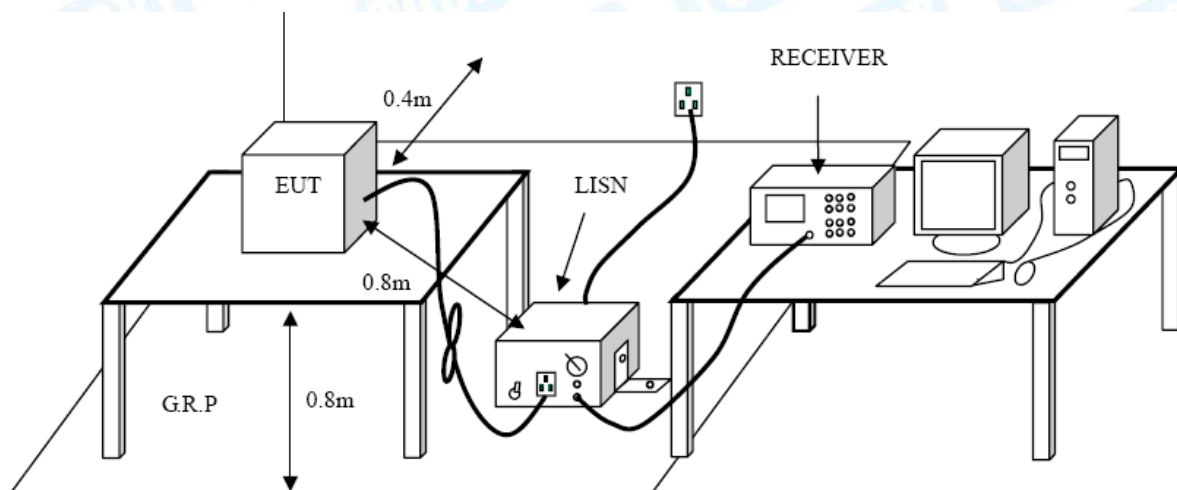

4.3 Test Procedure

The EUT was placed 0.8 meters from the horizontal ground plane with EUT being connected to the power mains through a line impedance stabilization network (LISN). All other support equipments powered from additional LISN(s). The LISN provide 50 Ohm/ 50uH of coupling impedance for the measuring instrument.

Interconnecting cables that hang closer than 40 cm to the ground plane shall be folded back and forth in the center forming a bundle 30 to 40 cm long.

I/O cables that are not connected to a peripheral shall be bundled in the center. The end of the cable may be terminated, if required, using the correct terminating impedance. The overall length shall not exceed 1 m.

LISN at least 80 cm from nearest part of EUT chassis

The bandwidth of EMI test receiver is set at 9kHz, and the test frequency band is from 0.15MHz to 30MHz.

4.4 EUT Operating Mode

Please refer to the description of test mode.

4.5 Test Data

Test data please refer the following pages.

EUT:	Bluetooth Speaker with LED Lights	Model Name :	RM89627
Temperature:	25 °C	Relative Humidity:	55%
Test Voltage:	AC 120V/60 Hz		
Terminal:	Line		
Test Mode:	USB Charging with TX GFSK Mode 2402 MHz		
Remark:	Only worse case is reported		

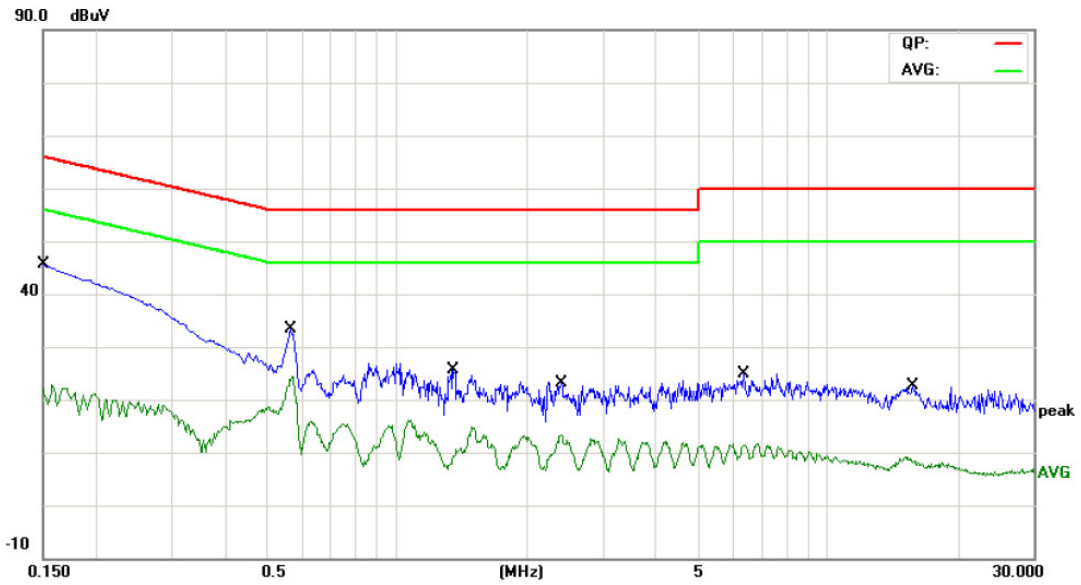

No.	Mk.	Freq.	Reading Level	Correct Factor	Measurement	Limit	Over	Detector
		MHz	dBuV	dB	dBuV	dBuV	dB	
1		0.1500	30.48	10.12	40.60	65.99	-25.39	QP
2		0.1500	10.98	10.12	21.10	55.99	-34.89	AVG
3		0.5660	17.08	10.02	27.10	56.00	-28.90	QP
4	*	0.5660	13.85	10.02	23.87	46.00	-22.13	AVG
5		1.3500	6.70	10.13	16.83	56.00	-39.17	QP
6		1.3500	-1.59	10.13	8.54	46.00	-37.46	AVG
7		2.3980	6.27	10.06	16.33	56.00	-39.67	QP
8		2.3980	2.67	10.06	12.73	46.00	-33.27	AVG
9		6.3820	5.44	10.06	15.50	60.00	-44.50	QP
10		6.3820	1.12	10.06	11.18	50.00	-38.82	AVG
11		15.7380	3.96	10.06	14.02	60.00	-45.98	QP
12		15.7380	-2.67	10.06	7.39	50.00	-42.61	AVG

Emission Level= Read Level+ Correct Factor

EUT:	Bluetooth Speaker with LED Lights	Model Name :	RM89627
Temperature :	25 °C	Relative Humidity:	55%
Test Voltage:	AC 120V/60 Hz		
Terminal:	Neutral		
Test Mode:	USB Charging with TX GFSK Mode 2402 MHz		
Remark:	Only worse case is reported		

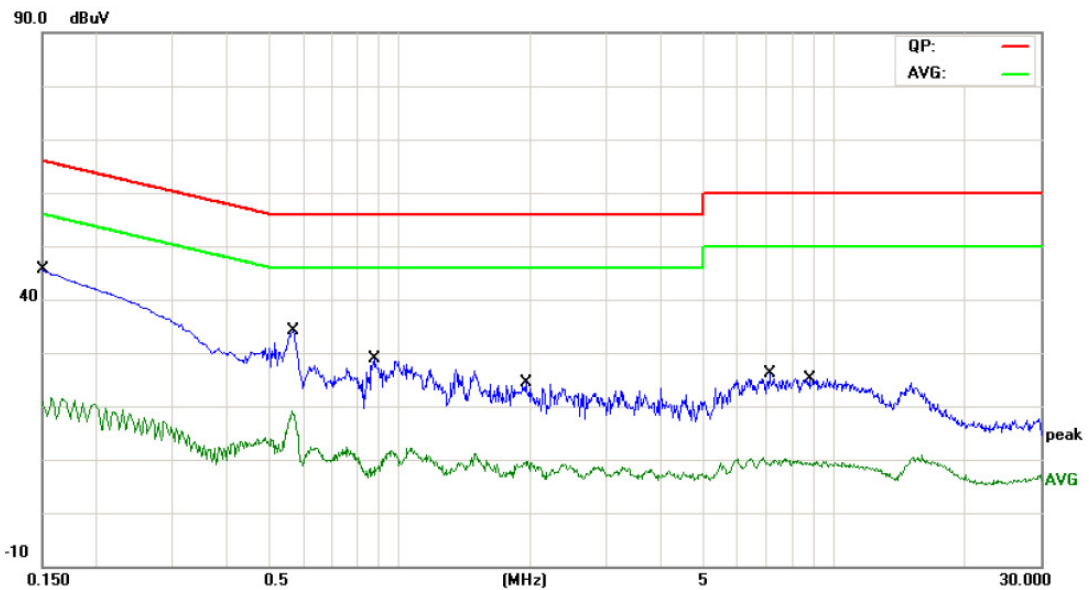

No.	Mk.	Freq. MHz	Reading Level dBuV	Correct Factor dB	Measure- ment dBuV	Limit dBuV	Over dB	Detector
1	*	0.1500	30.53	9.92	40.45	65.99	-25.54	QP
2		0.1500	10.37	9.92	20.29	55.99	-35.70	AVG
3		0.5700	18.51	10.05	28.56	56.00	-27.44	QP
4		0.5700	7.66	10.05	17.71	46.00	-28.29	AVG
5		0.8780	7.90	10.08	17.98	56.00	-38.02	QP
6		0.8780	-2.61	10.08	7.47	46.00	-38.53	AVG
7		1.9540	6.66	10.06	16.72	56.00	-39.28	QP
8		1.9540	-1.53	10.06	8.53	46.00	-37.47	AVG
9		7.1180	6.79	10.06	16.85	60.00	-43.15	QP
10		7.1180	-2.20	10.06	7.86	50.00	-42.14	AVG
11		8.8180	6.61	10.12	16.73	60.00	-43.27	QP
12		8.8180	-2.04	10.12	8.08	50.00	-41.92	AVG

Emission Level= Read Level+ Correct Factor

EUT:	Bluetooth Speaker with LED Lights	Model Name :	RM89627
Temperature:	25 °C	Relative Humidity:	55%
Test Voltage:	AC 240V/60 Hz		
Terminal:	Line		
Test Mode:	USB Charging with TX GFSK Mode 2402 MHz		
Remark:	Only worse case is reported		

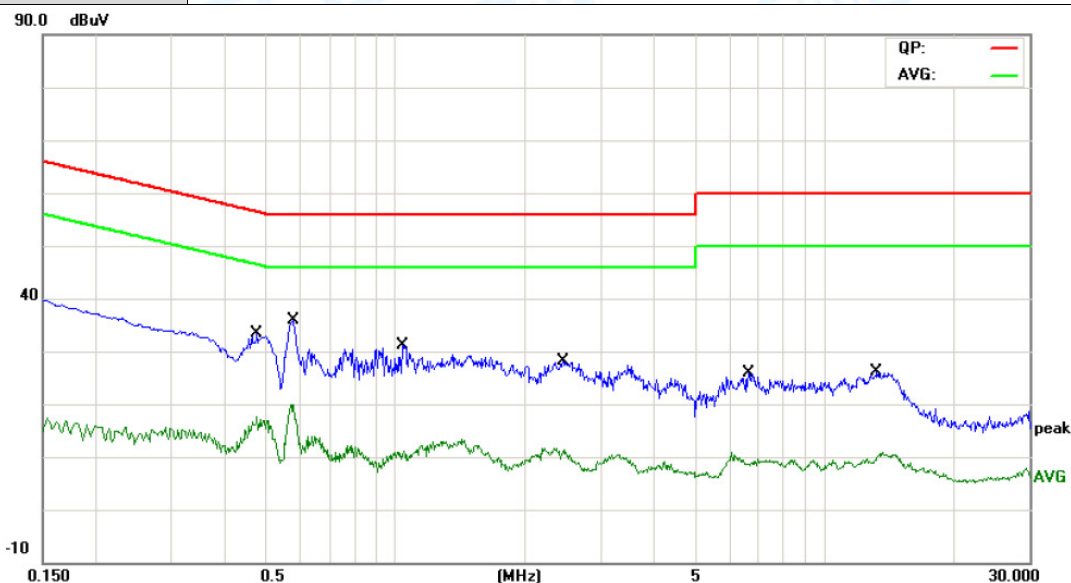

No.	Mk.	Freq. MHz	Reading Level dBuV	Correct Factor dB	Measure- ment dBuV	Limit dBuV	Over dB	Detector
1		0.4740	17.21	10.02	27.23	56.44	-29.21	QP
2		0.4740	5.27	10.02	15.29	46.44	-31.15	AVG
3	*	0.5780	19.96	10.06	30.02	56.00	-25.98	QP
4		0.5780	7.69	10.06	17.75	46.00	-28.25	AVG
5		1.0339	11.08	10.06	21.14	56.00	-34.86	QP
6		1.0339	-0.78	10.06	9.28	46.00	-36.72	AVG
7		2.4580	9.29	10.04	19.33	56.00	-36.67	QP
8		2.4580	-0.41	10.04	9.63	46.00	-36.37	AVG
9		6.6340	5.91	10.04	15.95	60.00	-44.05	QP
10		6.6340	-2.32	10.04	7.72	50.00	-42.28	AVG
11		13.2580	9.18	10.23	19.41	60.00	-40.59	QP
12		13.2580	-1.62	10.23	8.61	50.00	-41.39	AVG

Emission Level= Read Level+ Correct Factor

EUT:	Bluetooth Speaker with LED Lights	Model Name :	RM89627
Temperature:	25 °C	Relative Humidity:	55%
Test Voltage:	AC 240V/60 Hz		
Terminal:	Neutral		
Test Mode:	USB Charging with TX GFSK Mode 2402 MHz		
Remark:	Only worse case is reported		

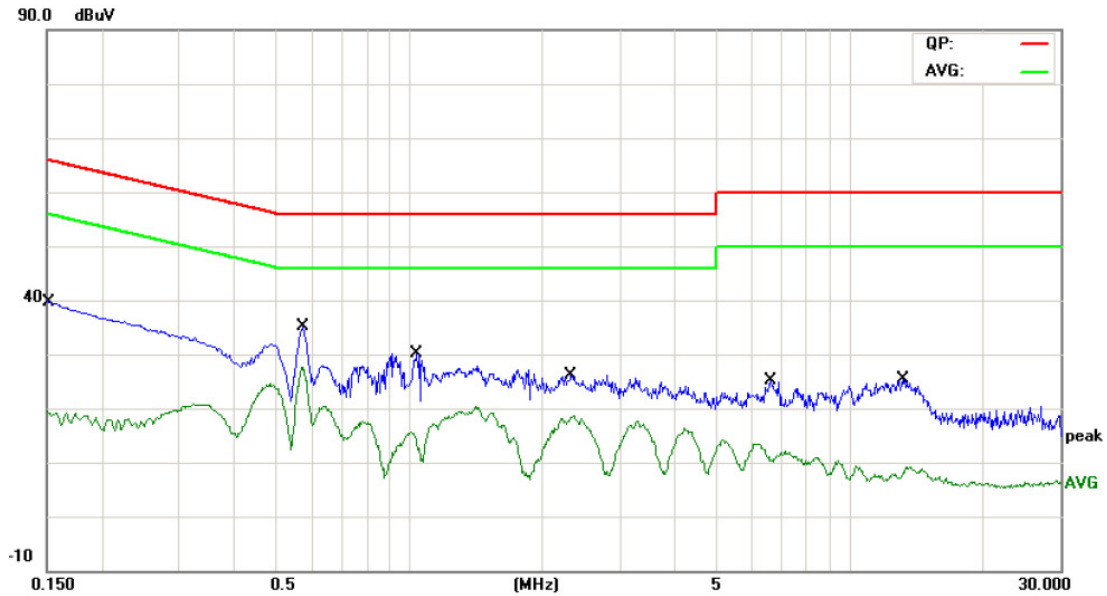

No.	Mk.	Freq. MHz	Reading Level dBuV	Correct Factor dB	Measure- ment dBuV	Limit dBuV	Over dB	Detector
1		0.1539	24.88	9.93	34.81	65.78	-30.97	QP
2		0.1539	8.05	9.93	17.98	55.78	-37.80	AVG
3		0.5740	19.65	10.06	29.71	56.00	-26.29	QP
4	*	0.5740	17.21	10.06	27.27	46.00	-18.73	AVG
5		1.0380	10.69	10.06	20.75	56.00	-35.25	QP
6		1.0380	3.21	10.06	13.27	46.00	-32.73	AVG
7		2.3300	10.34	10.05	20.39	56.00	-35.61	QP
8		2.3300	8.08	10.05	18.13	46.00	-27.87	AVG
9		6.6140	5.01	10.04	15.05	60.00	-44.95	QP
10		6.6140	-0.19	10.04	9.85	50.00	-40.15	AVG
11		13.1940	5.57	10.22	15.79	60.00	-44.21	QP
12		13.1940	-3.24	10.22	6.98	50.00	-43.02	AVG

Emission Level= Read Level+ Correct Factor

5. Radiated Emission Test

5.1 Test Standard and Limit

5.1.1 Test Standard
FCC Part 15.209

5.1.2 Test Limit

Radiated Emission Limit (9 kHz~1000MHz)

Frequency (MHz)	Field Strength (microvolt/meter)	Measurement Distance (meters)
0.009~0.490	2400/F(KHz)	300
0.490~1.705	24000/F(KHz)	30
1.705~30.0	30	30
30~88	100	3
88~216	150	3
216~960	200	3
Above 960	500	3

Radiated Emission Limit (Above 1000MHz)

Frequency (MHz)	Class B (dBuV/m)(at 3m)	
	Peak	Average
Above 1000	74	54

Note:

- (1) The tighter limit applies at the band edges.
- (2) Emission Level (dBuV/m)=20log Emission Level (uV/m)

5.2 Test Setup

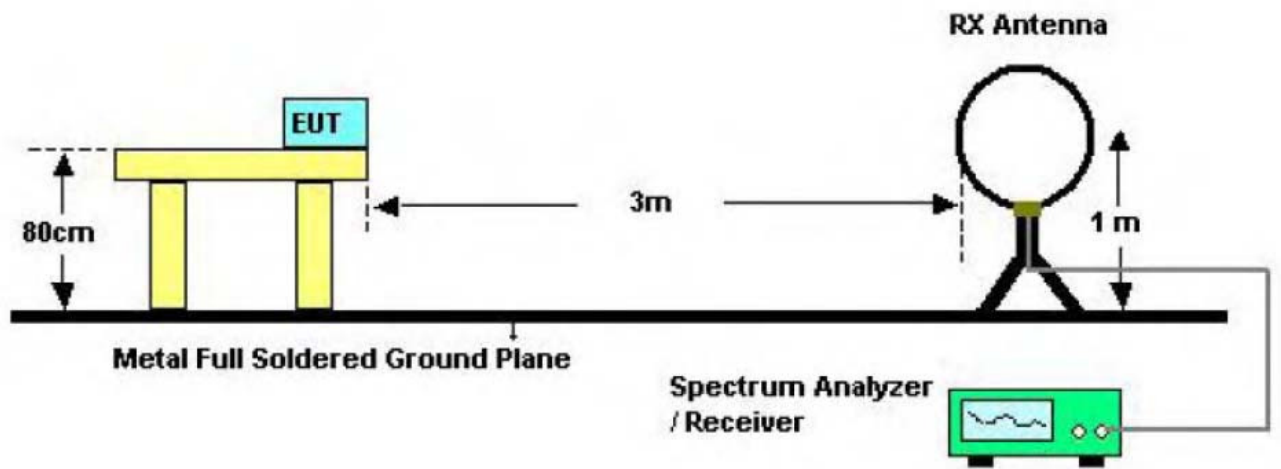

Below 30MHz Test Setup

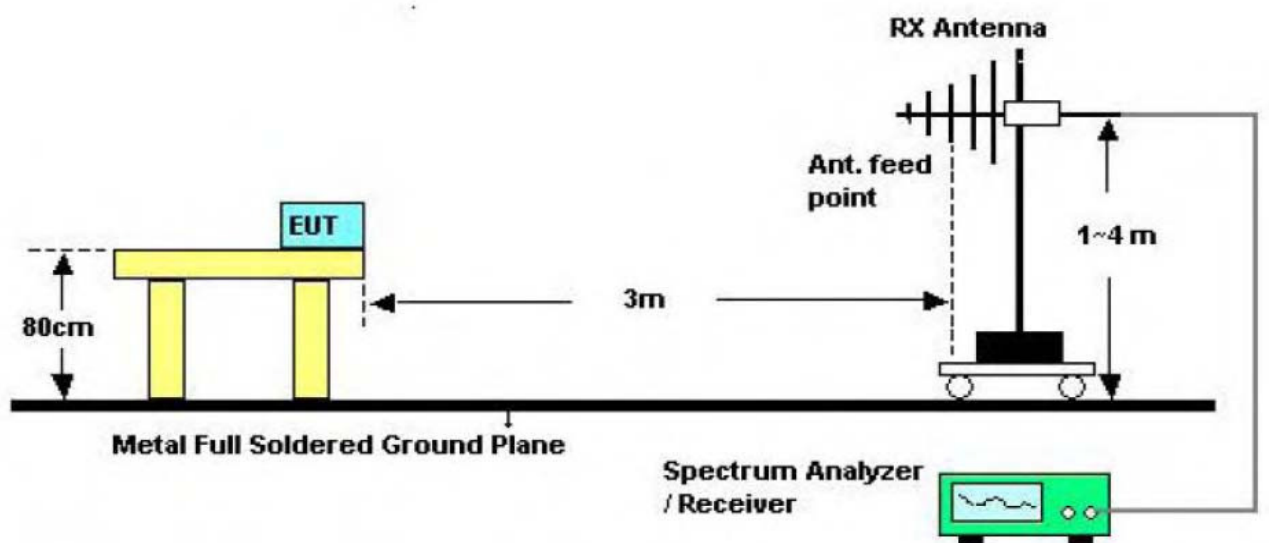

Below 1000MHz Test Setup

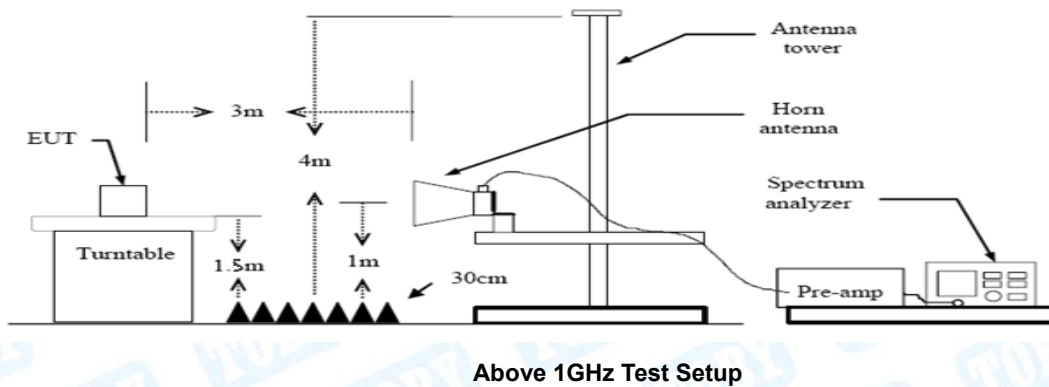

5.3 Test Procedure

- (1) The measuring distance of 3m shall be used for measurements at frequency up to 1GHz and above 1 GHz. The EUT was placed on a rotating 0.8m high above ground, the table was rotated 360 degrees to determine the position of the highest radiation.
- (2) Measurements at frequency above 1GHz. The EUT was placed on a rotating 1.5m high above the ground. RF absorbers covered the ground plane with a minimum area of 3.0m by 3.0m between the EUT and measurement receiver antenna. The RF absorber shall not exceed 30cm in high above the conducting floor. The table was rotated 360 degrees to determine the position of the highest radiation.
- (3) The Test antenna shall vary between 1m and 4m, Both Horizontal and Vertical antenna are set to make measurement.
- (4) The initial step in collecting conducted emission data is a spectrum analyzer peak detector mode pre-scanning the measurement frequency range. Significant peaks are then marked and then Quasi Peak detector mode re-measured.
- (5) If the Peak Mode measured value compliance with and lower than Quasi Peak Mode Limit Bellow 1 GHz, the EUT shall be deemed to meet QP Limits and then no additional QP Mode measurement performed. But the Peak Value and average value both need to comply with applicable limit above 1 GHz.
- (6) Testing frequency range below 1GHz the measuring instrument use VBW=120 kHz with Quasi-peak detection.
- (7) Testing frequency range above 1GHz the measuring instrument use RBW=1 MHz and VBW=3 MHz with Peak Detector for Peak Values, and use RBW=1 MHz and VBW=10 Hz with Peak Detector for Average Values.
- (8) For the actual test configuration, please see the test setup photo.

5.4 EUT Operating Condition

The Equipment Under Test was set to Continual Transmitting in maximum power in TX mode.

5.5 Test Data

Remark: During testing above 1GHz the measuring instrument use RBW=1 MHz and VBW=3 MHz with Peak Detector for Peak Values, and use RBW=1 MHz and VBW=1 kHz with Peak Detector for Average Values.

Test data please refer the following pages.

EUT:	Bluetooth Speaker with LED Lights	Model Name :	RM89627
Temperature:	25 °C	Relative Humidity:	55%
Test Voltage:	DC 3.7V		
Ant. Pol.	Horizontal		
Test Mode:	TX GFSK Mode 2402MHz		
Remark:	Only worse case is reported		

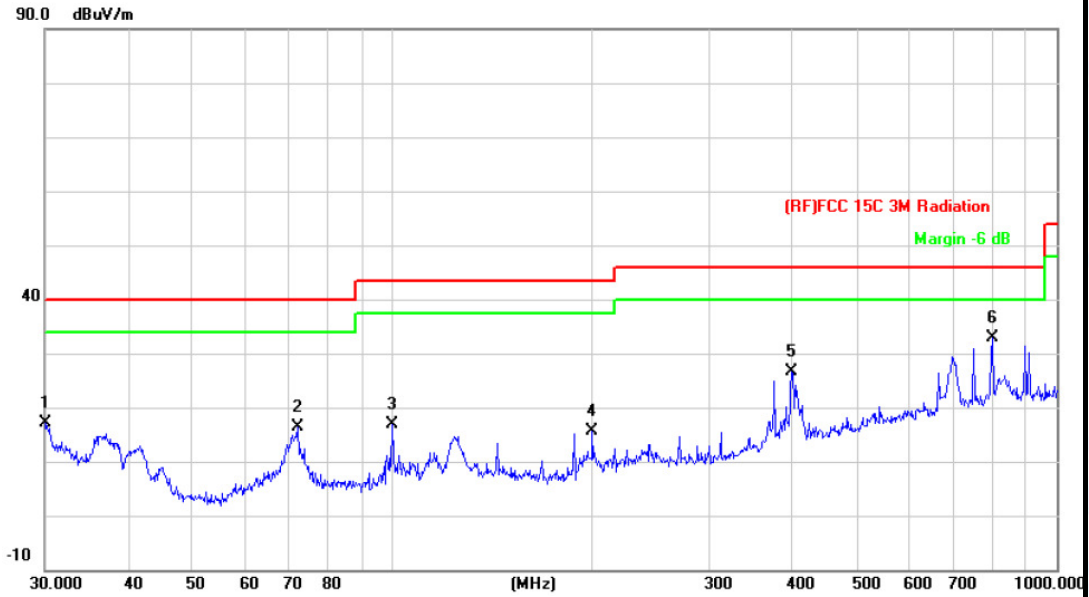

No.	Mk.	Freq. MHz	Reading Level dBuV	Correct Factor dB/m	Measure- ment dBuV/m	Limit dBuV/m	Over dB	Detector
1		30.1054	31.21	-14.03	17.18	40.00	-22.82	peak
2		72.0843	39.98	-23.54	16.44	40.00	-23.56	peak
3		99.8777	38.77	-21.83	16.94	43.50	-26.56	peak
4		199.9856	35.95	-20.39	15.56	43.50	-27.94	peak
5		399.0302	39.48	-12.87	26.61	46.00	-19.39	peak
6	*	801.7863	39.34	-6.49	32.85	46.00	-13.15	peak

*:Maximum data x:Over limit !:over margin

Emission Level= Read Level+ Correct Factor

EUT:	Bluetooth Speaker with LED Lights	Model Name :	RM89627
Temperature:	25 °C	Relative Humidity:	55%
Test Voltage:	DC 3.7V		
Ant. Pol.	Vertical		
Test Mode:	TX GFSK Mode 2402MHz		
Remark:	Only worse case is reported		

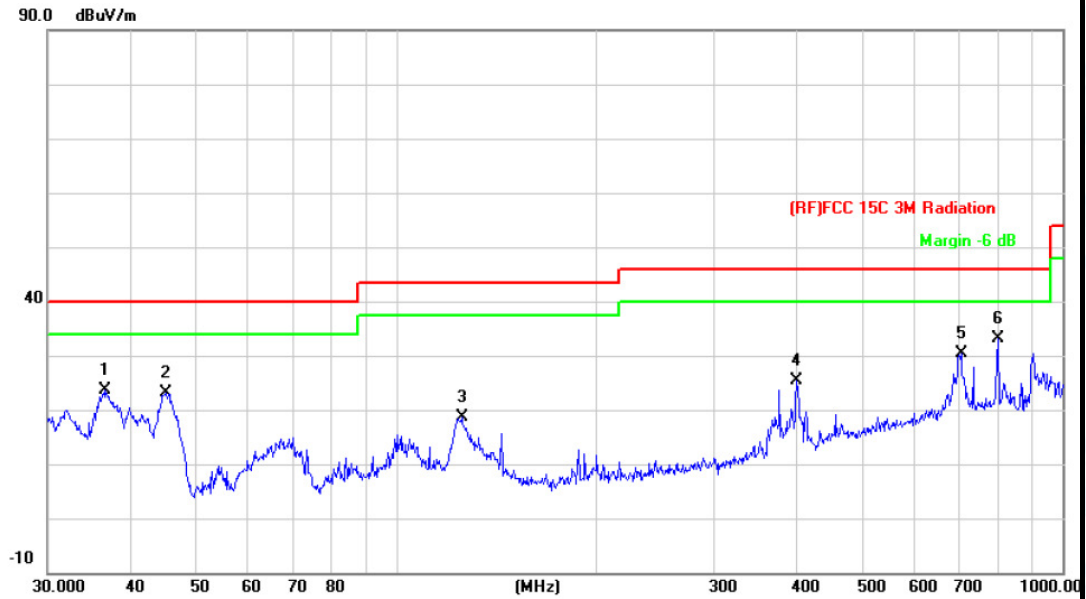

No.	Mk.	Freq.	Reading Level	Correct Factor	Measurement	Limit	Over	Detector
		MHz	dBuV	dB/m	dBuV/m	dBuV/m	dB	
1		36.5092	41.63	-17.99	23.64	40.00	-16.36	peak
2		45.2166	45.55	-22.37	23.18	40.00	-16.82	peak
3		125.4457	40.84	-22.33	18.51	43.50	-24.99	peak
4		399.0302	38.33	-12.87	25.46	46.00	-20.54	peak
5		704.2261	37.35	-6.91	30.44	46.00	-15.56	peak
6	*	798.9797	39.72	-6.52	33.20	46.00	-12.80	peak

*:Maximum data x:Over limit !:over margin

Emission Level= Read Level+ Correct Factor

EUT:	Bluetooth Speaker with LED Lights	Model Name :	RM89627
Temperature:	25 °C	Relative Humidity:	55%
Test Voltage:	DC 3.7V		
Ant. Pol.	Horizontal		
Test Mode:	TX $\pi/4$ -DQPSK Mode 2402MHz		
Remark:	Only worse case is reported		

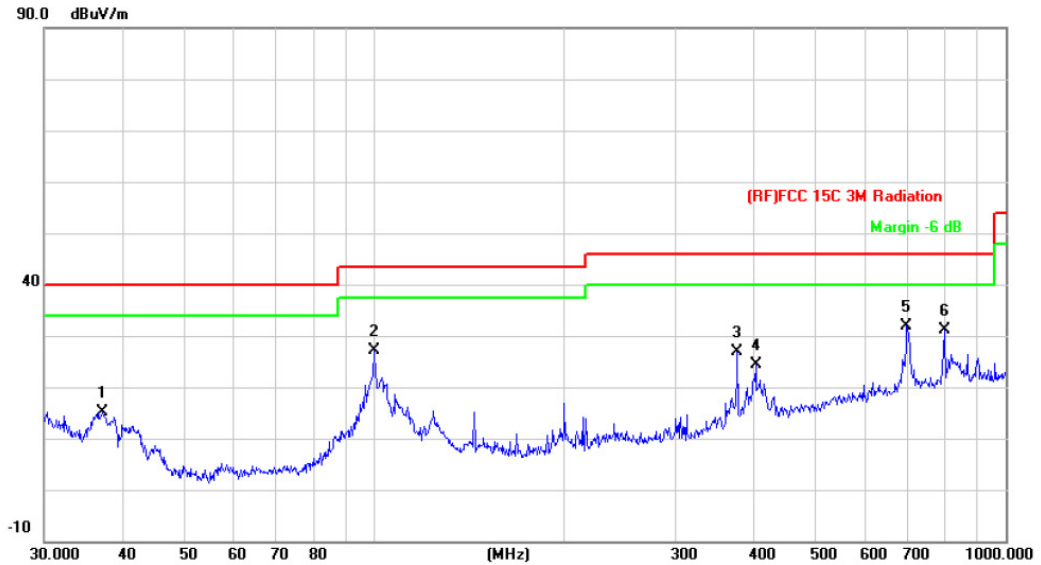

No.	Mk.	Freq.	Reading Level	Correct Factor	Measurement	Limit	Over	
		MHz	dBuV	dB/m	dBuV/m	dBuV/m	dB	Detector
1		37.1550	33.47	-18.39	15.08	40.00	-24.92	peak
2		99.8777	48.96	-21.83	27.13	43.50	-16.37	peak
3		375.9385	41.24	-14.40	26.84	46.00	-19.16	peak
4		401.8385	37.21	-12.81	24.40	46.00	-21.60	peak
5	*	696.8567	38.78	-6.95	31.83	46.00	-14.17	peak
6		798.9797	37.64	-6.52	31.12	46.00	-14.88	peak

*:Maximum data x:Over limit !:over margin

Emission Level= Read Level+ Correct Factor

EUT:	Bluetooth Speaker with LED Lights	Model Name :	RM89627
Temperature:	25 °C	Relative Humidity:	55%
Test Voltage:	DC 3.7V		
Ant. Pol.	Vertical		
Test Mode:	TX π/4-DQPSK Mode 2402MHz		
Remark:	Only worse case is reported		

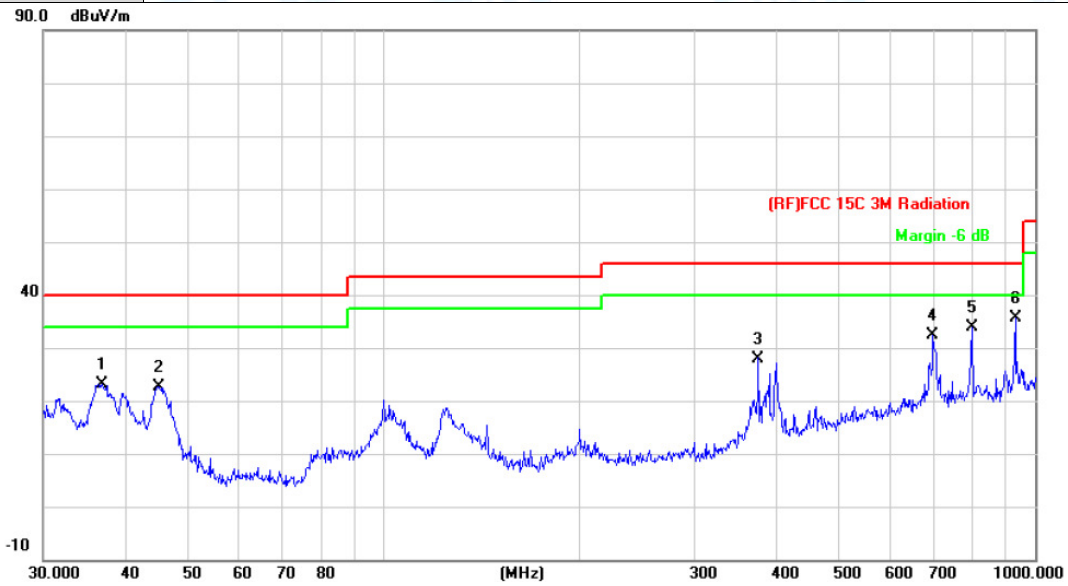

No.	Mk.	Freq. MHz	Reading Level dBuV	Correct Factor dB/m	Measure- ment dBuV/m	Limit dBuV/m	Over dB	Detector
1		36.8953	41.40	-18.23	23.17	40.00	-16.83	peak
2		45.2166	45.06	-22.37	22.69	40.00	-17.31	peak
3		375.9385	42.40	-14.40	28.00	46.00	-18.00	peak
4		696.8567	39.24	-6.95	32.29	46.00	-13.71	peak
5		798.9797	40.36	-6.52	33.84	46.00	-12.16	peak
6	*	932.2715	40.37	-4.82	35.55	46.00	-10.45	peak

*:Maximum data x:Over limit !:over margin

Emission Level= Read Level+ Correct Factor

EUT:	Bluetooth Speaker with LED Lights	Model Name :	RM89627
Temperature:	25 °C	Relative Humidity:	55%
Test Voltage:	DC 3.7V		
Ant. Pol.	Horizontal		
Test Mode:	TX GFSK Mode 2402MHz		
Remark:	No report for the emission which more than 10 dB below the prescribed limit.		

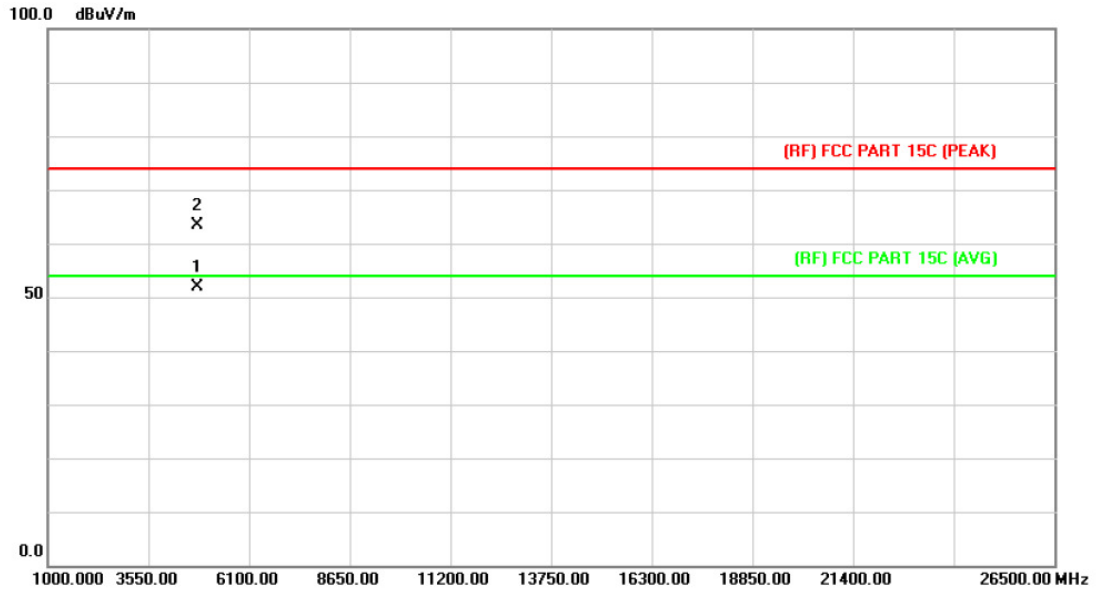

No.	Mk.	Freq.	Reading Level	Correct Factor	Measurement	Limit	Over	Detector
		MHz	dBuV	dB/m	dBuV/m	dBuV/m	dB	
1	*	4804.048	38.51	13.44	51.95	54.00	-2.05	AVG
2		4804.282	49.99	13.44	63.43	74.00	-10.57	peak

Emission Level= Read Level+ Correct Factor

EUT:	Bluetooth Speaker with LED Lights	Model Name :	RM89627
Temperature:	25 °C	Relative Humidity:	55%
Test Voltage:	DC 3.7V		
Ant. Pol.	Vertical		
Test Mode:	TX GFSK Mode 2402MHz		
Remark:	No report for the emission which more than 10 dB below the prescribed limit.		

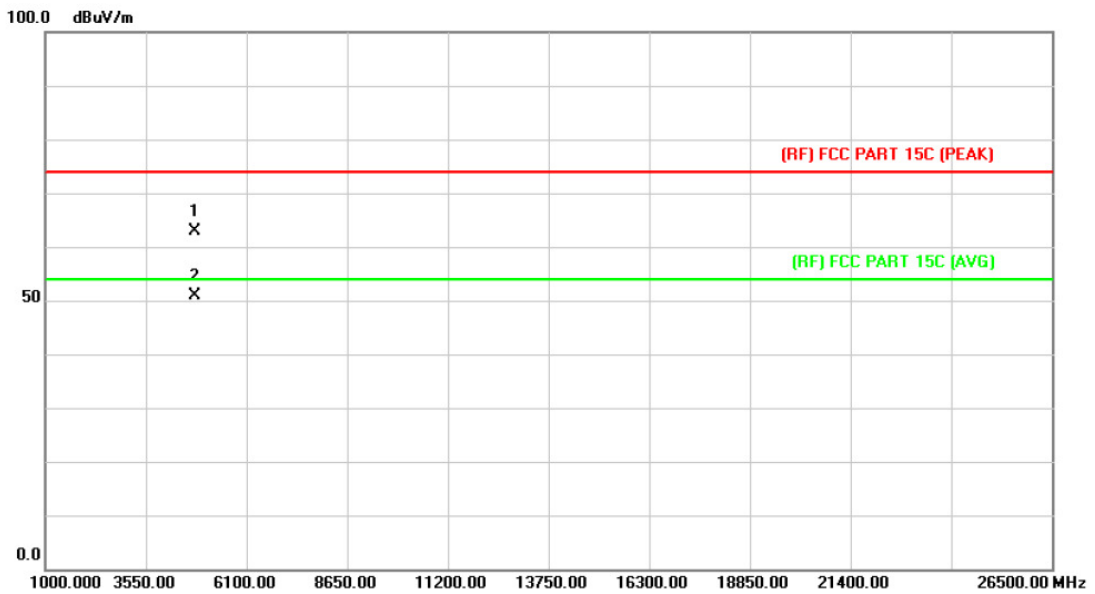

No.	Mk.	Freq. MHz	Reading Level dBuV	Correct Factor dB/m	Measure- ment dBuV/m	Limit dBuV/m	Over dB	Detector
1		4803.682	49.34	13.44	62.78	74.00	-11.22	peak
2	*	4804.093	37.36	13.44	50.80	54.00	-3.20	AVG

Emission Level= Read Level+ Correct Factor

EUT:	Bluetooth Speaker with LED Lights	Model Name :	RM89627
Temperature:	25 °C	Relative Humidity:	55%
Test Voltage:	DC 3.7V		
Ant. Pol.	Horizontal		
Test Mode:	TX GFSK Mode 2441MHz		
Remark:	No report for the emission which more than 10 dB below the prescribed limit.		

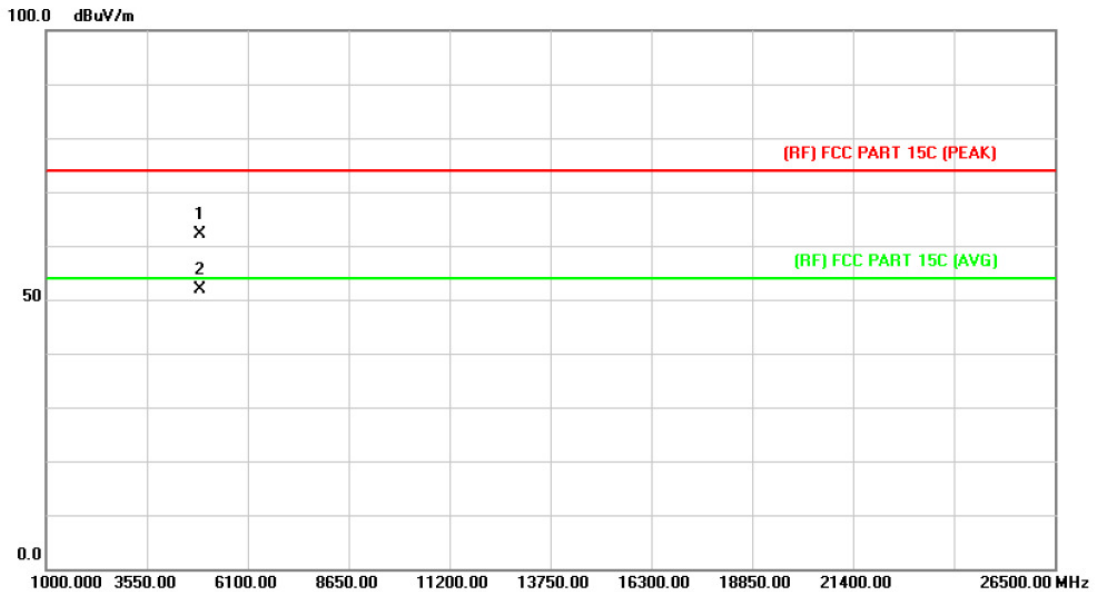

No.	Mk.	Freq.	Reading Level	Correct Factor	Measurement	Limit	Over	Detector
		MHz	dBuV	dB/m	dBuV/m	dBuV/m	dB	
1		4881.808	48.18	13.90	62.08	74.00	-11.92	peak
2	*	4881.961	37.89	13.90	51.79	54.00	-2.21	AVG

Emission Level= Read Level+ Correct Factor

EUT:	Bluetooth Speaker with LED Lights	Model Name :	RM89627
Temperature:	25 °C	Relative Humidity:	55%
Test Voltage:	DC 3.7V		
Ant. Pol.	Vertical		
Test Mode:	TX GFSK Mode 2441MHz		
Remark:	No report for the emission which more than 10 dB below the prescribed limit.		

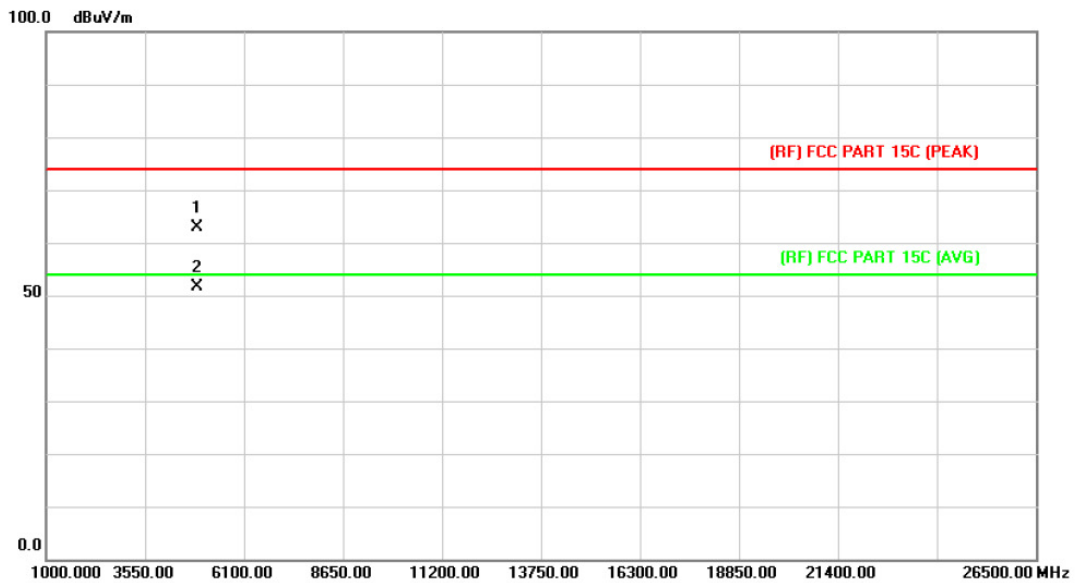

No.	Mk.	Freq.	Reading Level	Correct Factor	Measurement	Limit	Over	Detector
		MHz	dBuV	dB/m	dBuV/m	dBuV/m	dB	
1		4881.214	48.96	13.90	62.86	74.00	-11.14	peak
2	*	4882.099	37.76	13.90	51.66	54.00	-2.34	AVG

Emission Level= Read Level+ Correct Factor

EUT:	Bluetooth Speaker with LED Lights	Model Name :	RM89627
Temperature:	25 °C	Relative Humidity:	55%
Test Voltage:	DC 3.7V		
Ant. Pol.	Horizontal		
Test Mode:	TX GFSK Mode 2480MHz		
Remark:	No report for the emission which more than 10 dB below the prescribed limit.		

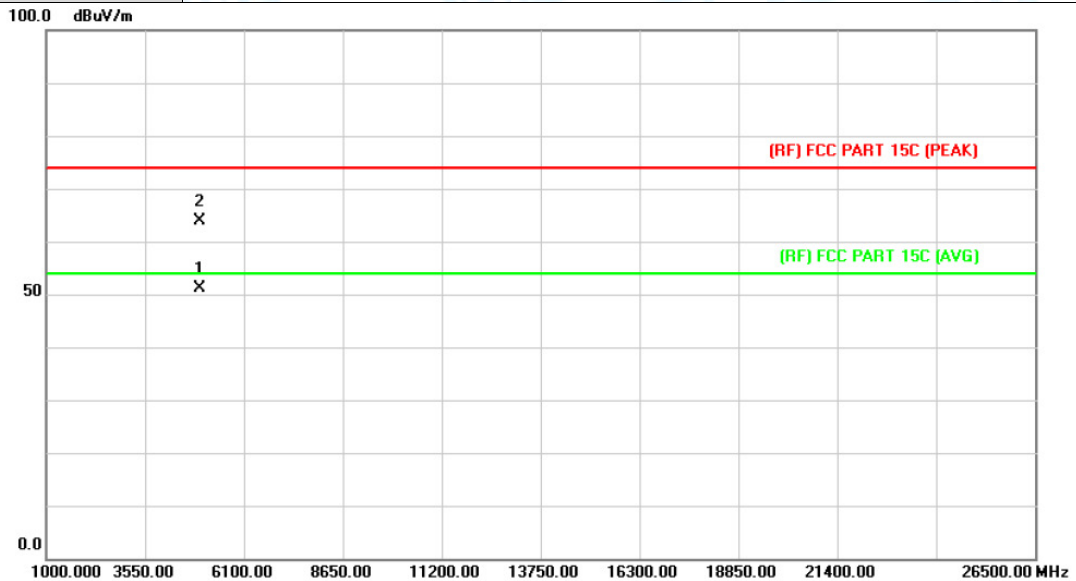

No.	Mk.	Freq.	Reading Level	Correct Factor	Measurement	Limit	Over	Detector
		MHz	dBuV	dB/m	dBuV/m	dBuV/m	dB	
1	*	4960.159	36.87	14.36	51.23	54.00	-2.77	AVG
2		4960.456	49.62	14.36	63.98	74.00	-10.02	peak

Emission Level= Read Level+ Correct Factor

EUT:	Bluetooth Speaker with LED Lights	Model Name :	RM89627
Temperature:	25 °C	Relative Humidity:	55%
Test Voltage:	DC 3.7V		
Ant. Pol.	Vertical		
Test Mode:	TX GFSK Mode 2480MHz		
Remark:	No report for the emission which more than 10 dB below the prescribed limit.		

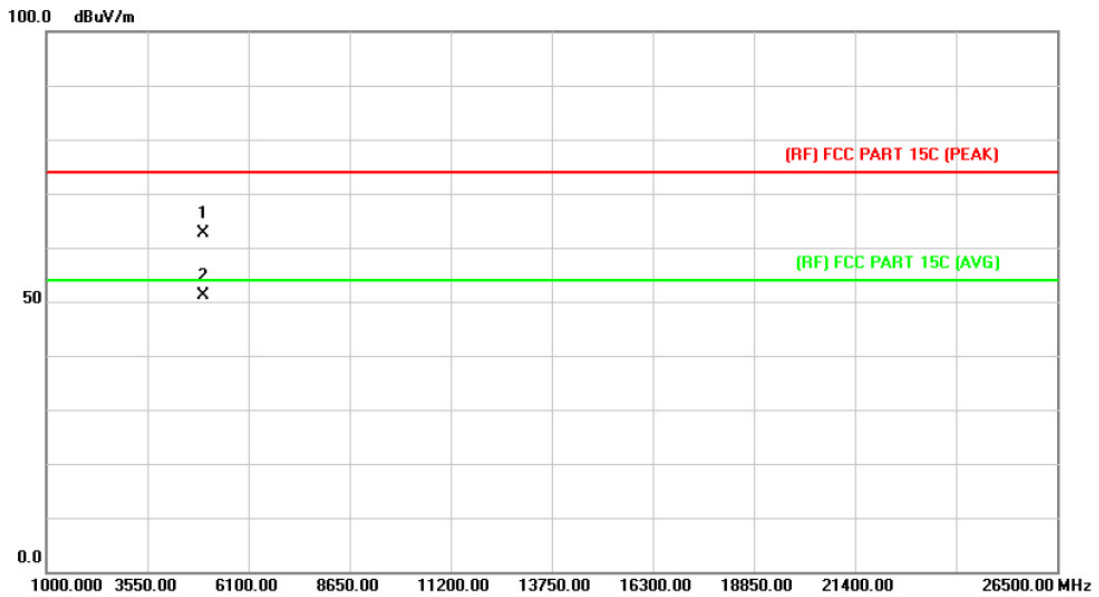

No.	Mk.	Freq. MHz	Reading Level dBuV	Correct Factor dB/m	Measure- ment dBuV/m	Limit dBuV/m	Over dB	Detector
1		4959.850	48.24	14.36	62.60	74.00	-11.40	peak
2	*	4960.009	36.76	14.36	51.12	54.00	-2.88	AVG

Emission Level= Read Level+ Correct Factor

EUT:	Bluetooth Speaker with LED Lights	Model Name :	RM89627
Temperature:	25 °C	Relative Humidity:	55%
Test Voltage:	DC 3.7V		
Ant. Pol.	Horizontal		
Test Mode:	TX π /4-DQPSK Mode 2402MHz		
Remark:	No report for the emission which more than 10 dB below the prescribed limit.		

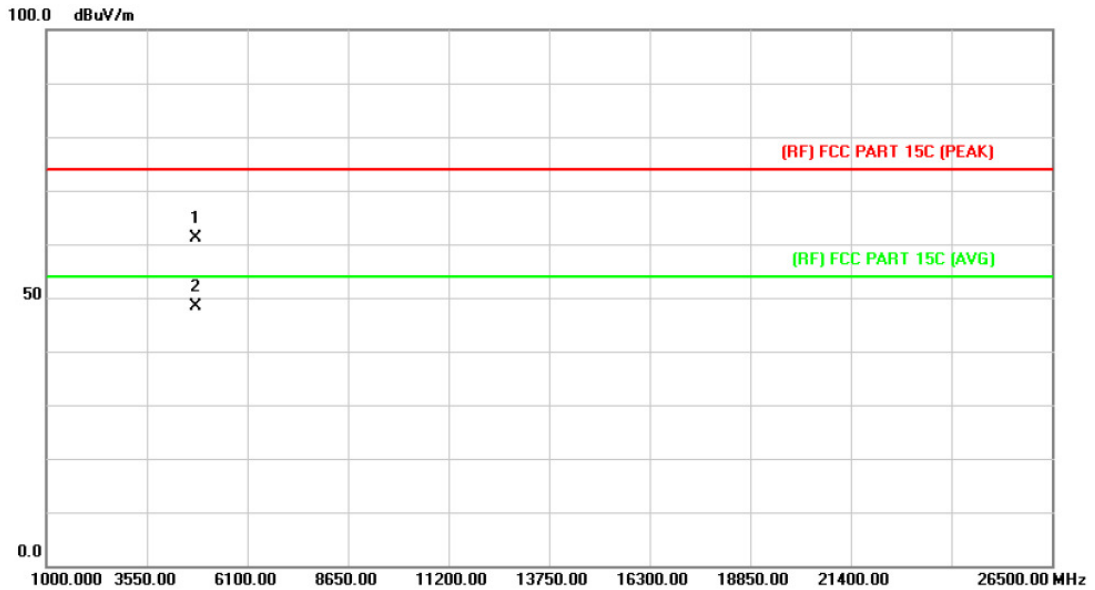

No.	Mk.	Freq.	Reading Level	Correct Factor	Measurement	Limit	Over	Detector
		MHz	dBuV	dB/m	dBuV/m	dBuV/m	dB	
1		4803.643	47.78	13.44	61.22	74.00	-12.78	peak
2	*	4804.915	34.82	13.44	48.26	54.00	-5.74	AVG

Emission Level= Read Level+ Correct Factor

EUT:	Bluetooth Speaker with LED Lights	Model Name :	RM89627
Temperature:	25 °C	Relative Humidity:	55%
Test Voltage:	DC 3.7V		
Ant. Pol.	Vertical		
Test Mode:	TX π /4-DQPSK Mode 2402MHz		
Remark:	No report for the emission which more than 10 dB below the prescribed limit.		

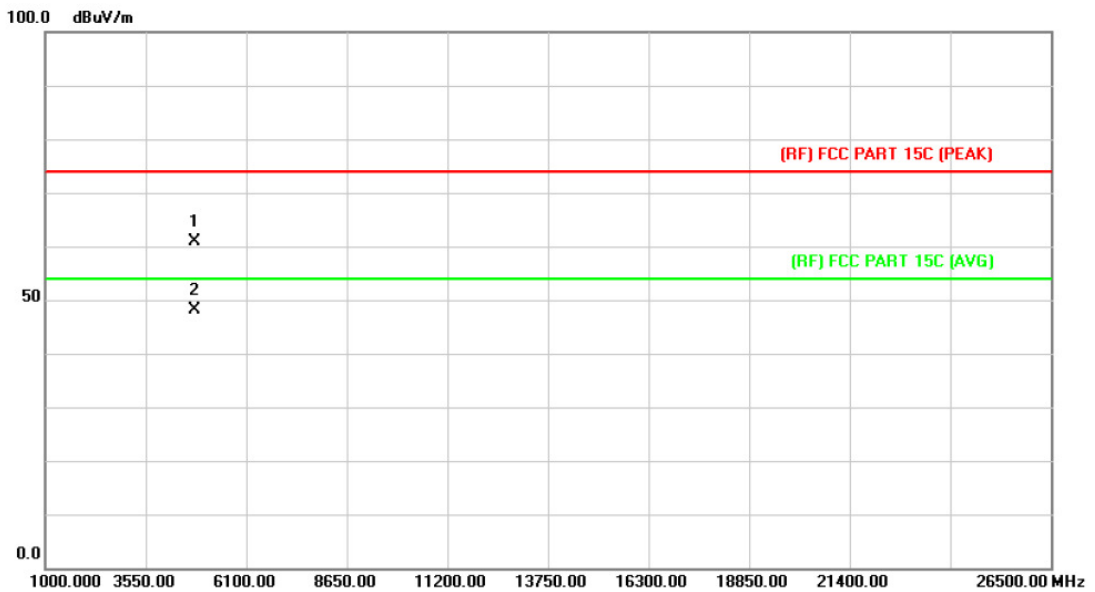

No. Mk.	Freq.	Reading Level	Correct Factor	Measurement	Limit	Over	Detector
	MHz	dBuV	dB/m	dBuV/m	dBuV/m	dB	
1	4803.568	47.41	13.44	60.85	74.00	-13.15	peak
2	* 4804.795	34.64	13.44	48.08	54.00	-5.92	AVG

Emission Level= Read Level+ Correct Factor

EUT:	Bluetooth Speaker with LED Lights	Model Name :	RM89627
Temperature:	25 °C	Relative Humidity:	55%
Test Voltage:	DC 3.7V		
Ant. Pol.	Horizontal		
Test Mode:	TX $\pi/4$ -DQPSK Mode 2441MHz		
Remark:	No report for the emission which more than 10 dB below the prescribed limit.		

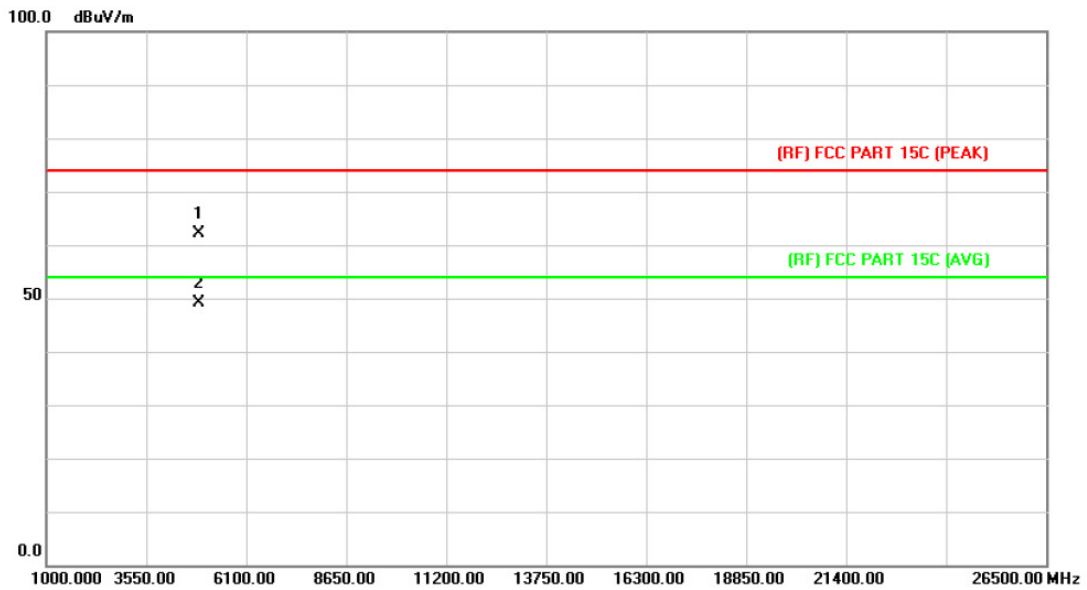

No.	Mk.	Freq.	Reading Level	Correct Factor	Measurement	Limit	Over	
		MHz	dBuV	dB/m	dBuV/m	dBuV/m	dB	Detector
1		4881.298	48.11	13.90	62.01	74.00	-11.99	peak
2	*	4882.966	35.21	13.90	49.11	54.00	-4.89	AVG

Emission Level= Read Level+ Correct Factor

EUT:	Bluetooth Speaker with LED Lights	Model Name :	RM89627
Temperature:	25 °C	Relative Humidity:	55%
Test Voltage:	DC 3.7V		
Ant. Pol.	Vertical		
Test Mode:	TX $\pi/4$ -DQPSK Mode 2441MHz		
Remark:	No report for the emission which more than 10 dB below the prescribed limit.		

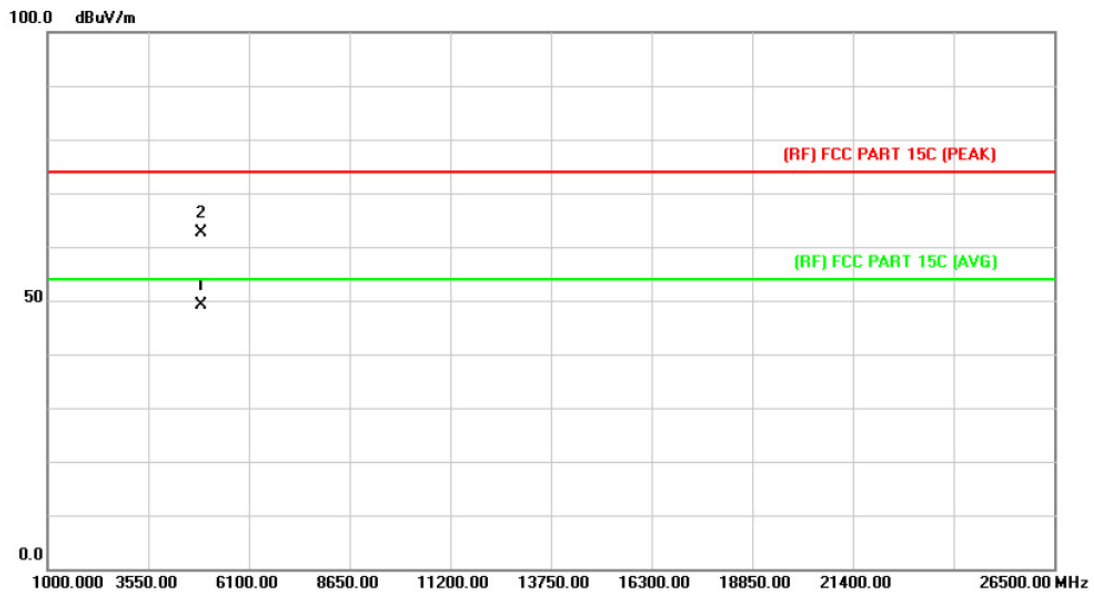

No.	Mk.	Freq. MHz	Reading Level dBuV	Correct Factor dB/m	Measure- ment dBuV/m	Limit dBuV/m	Over dB	Detector
1	*	4881.562	35.18	13.90	49.08	54.00	-4.92	AVG
2		4883.488	48.64	13.92	62.56	74.00	-11.44	peak

Emission Level= Read Level+ Correct Factor

EUT:	Bluetooth Speaker with LED Lights	Model Name :	RM89627
Temperature:	25 °C	Relative Humidity:	55%
Test Voltage:	DC 3.7V		
Ant. Pol.	Horizontal		
Test Mode:	TX $\pi/4$ -DQPSK Mode 2480MHz		
Remark:	No report for the emission which more than 10 dB below the prescribed limit.		

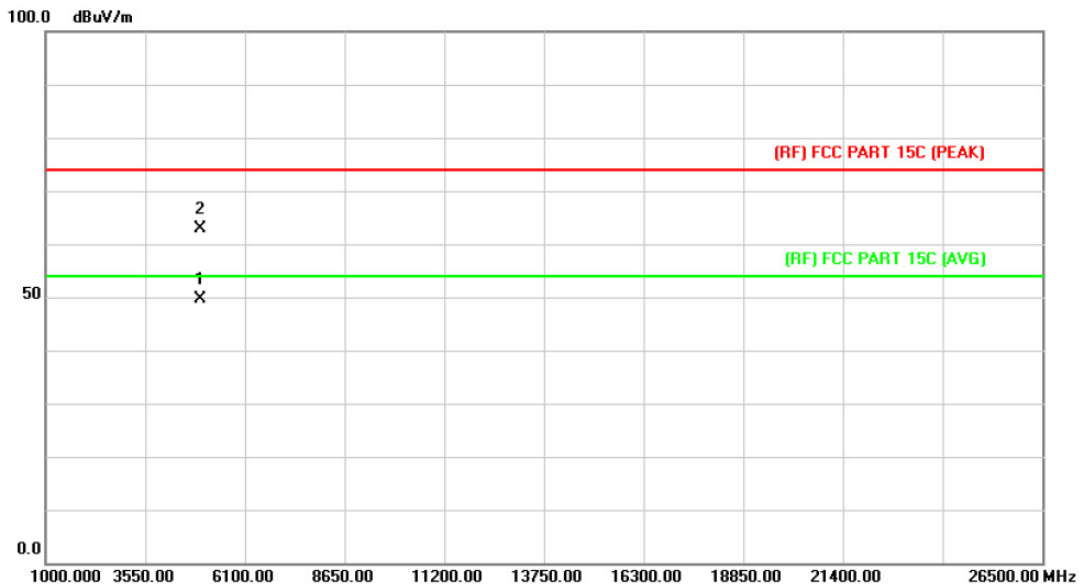

No.	Mk.	Freq.	Reading Level	Correct Factor	Measurement	Limit	Over	Detector
		MHz	dBuV	dB/m	dBuV/m	dBuV/m	dB	
1	*	4960.501	35.19	14.36	49.55	54.00	-4.45	AVG
2		4961.203	48.50	14.38	62.88	74.00	-11.12	peak

Emission Level= Read Level+ Correct Factor

EUT:	Bluetooth Speaker with LED Lights	Model Name :	RM89627
Temperature:	25 °C	Relative Humidity:	55%
Test Voltage:	DC 3.7V		
Ant. Pol.	Vertical		
Test Mode:	TX π /4-DQPSK Mode 2480MHz		
Remark:	No report for the emission which more than 10 dB below the prescribed limit.		

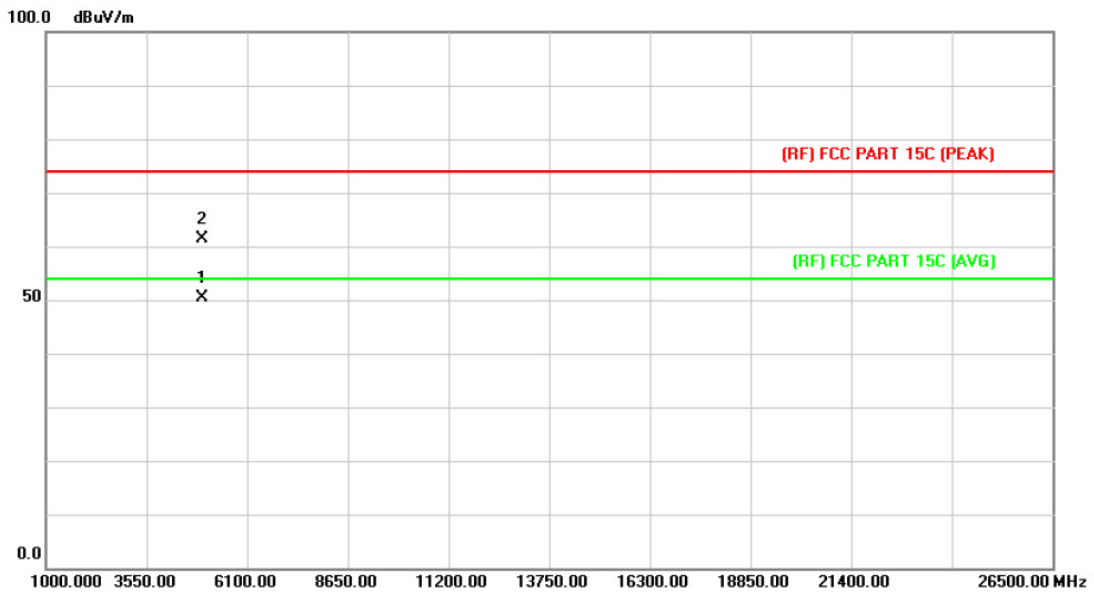

No.	Mk.	Freq. MHz	Reading Level dBuV	Correct Factor dB/m	Measure- ment dBuV/m	Limit dBuV/m	Over dB	Detector
1	*	4959.421	36.10	14.36	50.46	54.00	-3.54	AVG
2		4960.631	47.13	14.36	61.49	74.00	-12.51	peak

Emission Level= Read Level+ Correct Factor

6. Restricted Bands Requirement

6.1 Test Standard and Limit

- 6.1.1 Test Standard
 - FCC Part 15.209
 - FCC Part 15.205
- 6.1.2 Test Limit

Restricted Frequency Band (MHz)	Class B (dBuV/m)(at 3m)	
	Peak	Average
2310 ~2390	74	54
2483.5 ~2500	74	54

Note: All restriction bands have been tested, only the worst case is reported.

6.2 Test Setup

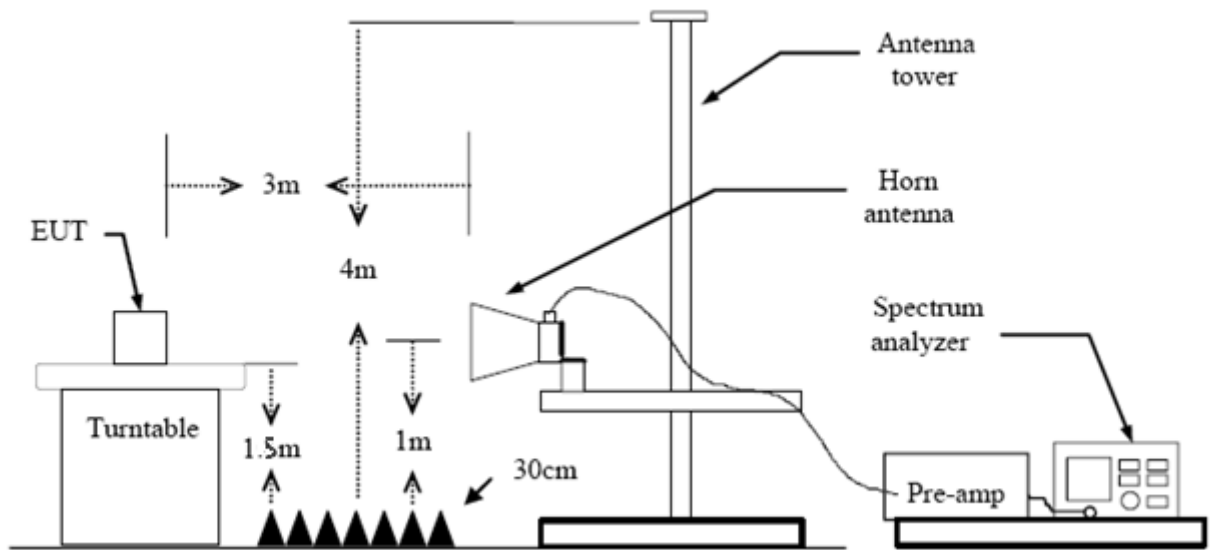

6.3 Test Procedure

- (1) The measuring distance of 3m shall be used for measurements at frequency up to 1GHz and above 1 GHz. The EUT was placed on a rotating 0.8m high above ground, the table was rotated 360 degrees to determine the position of the highest radiation.
- (2) Measurements at frequency above 1GHz. The EUT was placed on a rotating 1.5m high above the ground. RF absorbers covered the ground plane with a minimum area of 3.0m by 3.0m between the EUT and measurement receiver antenna. The RF absorber shall not exceed 30cm in high above the conducting floor. The table was rotated 360 degrees to determine the position of the highest radiation.

- (3) The Test antenna shall vary between 1m and 4m, Both Horizontal and Vertical antenna are set to make measurement.
- (4) The initial step in collecting conducted emission data is a spectrum analyzer peak detector mode pre-scanning the measurement frequency range. Significant peaks are then marked and then Quasi Peak detector mode re-measured.
- (5) If the Peak Mode measured value compliance with and lower than Quasi Peak Mode Limit Bellow 1 GHz, the EUT shall be deemed to meet QP Limits and then no additional QP Mode measurement performed. But the Peak Value and average value both need to comply with applicable limit above 1 GHz.
- (6) Testing frequency range below 1GHz the measuring instrument use VBW=120 kHz with Quasi-peak detection.
- (7) Testing frequency range above 1GHz the measuring instrument use RBW=1 MHz and VBW=3 MHz with Peak Detector for Peak Values, and use RBW=1 MHz and VBW=10 Hz with Peak Detector for Average Values.
- (8) For the actual test configuration, please see the test setup photo.

6.4 EUT Operating Condition

The Equipment Under Test was set to Continual Transmitting in maximum power.

6.4 Test Data

Remark: During testing above 1GHz the measuring instrument use RBW=1 MHz and VBW=3 MHz with Peak Detector for Peak Values, and use RBW=1 MHz and VBW=1 KHz with Peak Detector for Average Values.

All restriction bands have been tested, only the worst case is reported.

(1) Radiation Test

EUT:	Bluetooth Speaker with LED Lights	Model Name :	RM89627
Temperature:	25 °C	Relative Humidity:	55%
Test Voltage:	DC 3.7V		
Ant. Pol.	Horizontal		
Test Mode:	TX GFSK Mode 2402MHz		
Remark:	N/A		

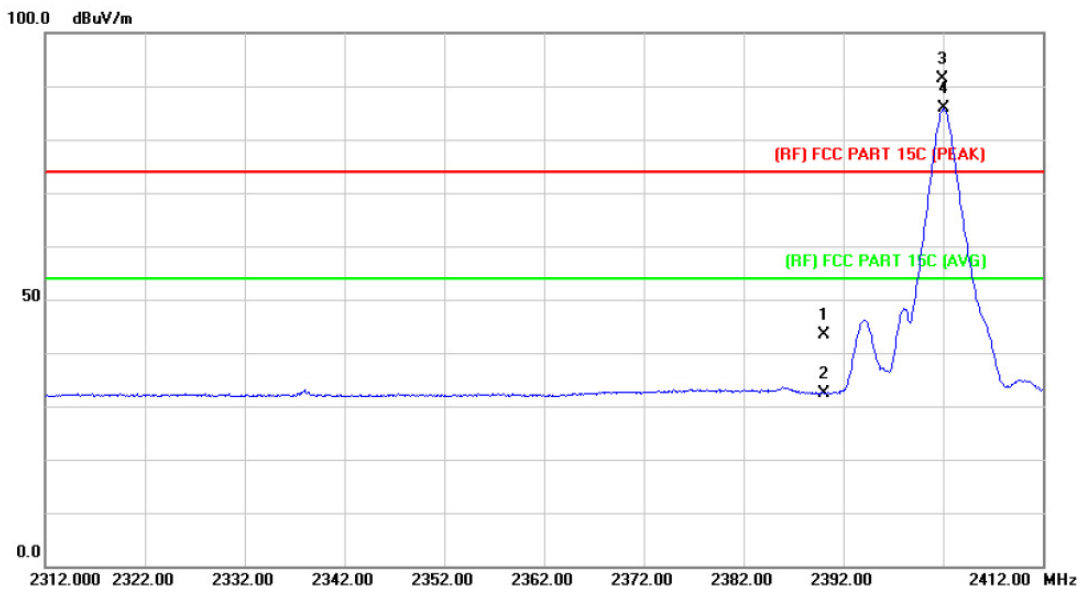

No.	Mk.	Freq.	Reading Level	Correct Factor	Measurement	Limit	Over	
		MHz	dBuV	dB/m	dBuV/m	dBuV/m	dB	Detector
1		2390.000	42.53	0.77	43.30	74.00	-30.70	peak
2		2390.000	31.67	0.77	32.44	54.00	-21.56	AVG
3	X	2401.900	90.66	0.82	91.48			Fundamental Frequency peak
4	*	2402.000	84.94	0.82	85.76			Fundamental Frequency AVG

Emission Level= Read Level+ Correct Factor

EUT:	Bluetooth Speaker with LED Lights	Model Name :	RM89627
Temperature:	25 °C	Relative Humidity:	55%
Test Voltage:	DC 3.7V		
Ant. Pol.	Vertical		
Test Mode:	TX GFSK Mode 2402MHz		
Remark:	N/A		

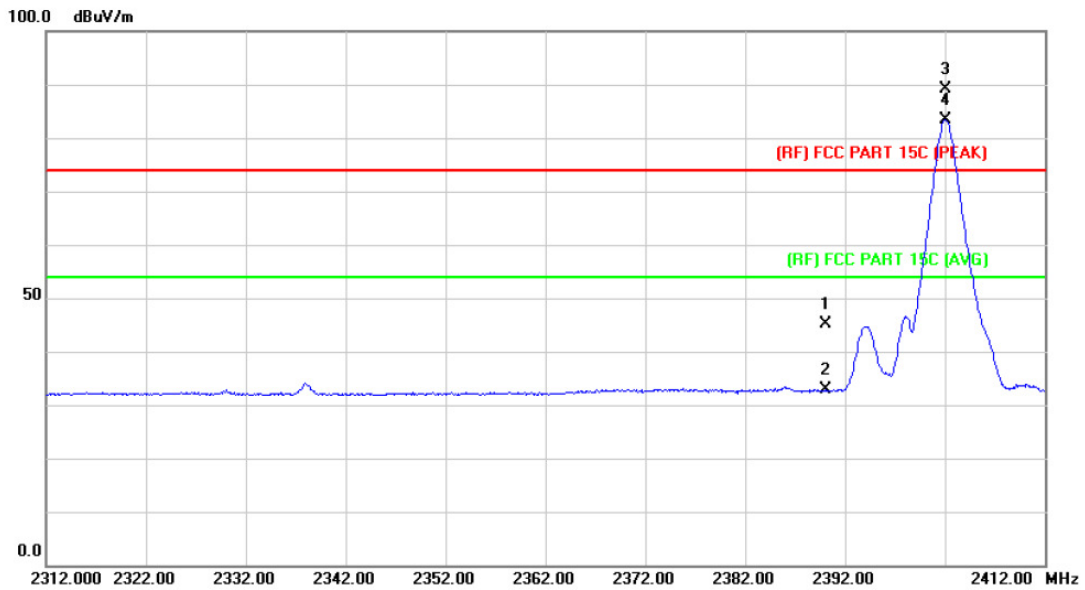

No.	Mk.	Freq. MHz	Reading Level dBuV	Correct Factor dB/m	Measure- ment dBuV/m	Limit dBuV/m	Over dB	Detector
1		2390.000	44.36	0.77	45.13	74.00	-28.87	peak
2		2390.000	31.99	0.77	32.76	54.00	-21.24	AVG
3	X	2402.000	88.26	0.82	89.08	Fundamental Frequency		peak
4	*	2402.000	82.60	0.82	83.42	Fundamental Frequency		AVG

Emission Level= Read Level+ Correct Factor

EUT:	Bluetooth Speaker with LED Lights	Model Name :	RM89627
Temperature:	25 °C	Relative Humidity:	55%
Test Voltage:	DC 3.7V		
Ant. Pol.	Horizontal		
Test Mode:	TX GFSK Mode 2480 MHz		
Remark:	N/A		

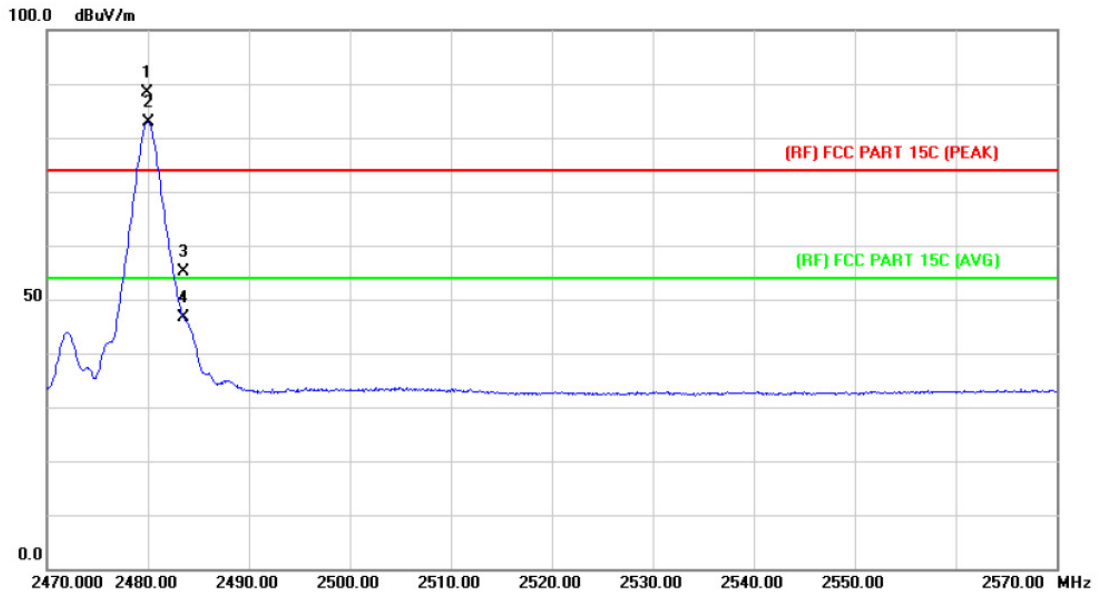

No.	Mk.	Freq. MHz	Reading Level dBuV	Correct Factor dB/m	Measure- ment dBuV/m	Limit dBuV/m	Over dB	Detector
1	X	2479.900	87.17	1.15	88.32	Fundamental Frequency		peak
2	*	2480.000	81.80	1.15	82.95	Fundamental Frequency		AVG
3		2483.500	53.92	1.17	55.09	74.00	-18.91	peak
4		2483.500	45.44	1.17	46.61	54.00	-7.39	AVG

Emission Level= Read Level+ Correct Factor

EUT:	Bluetooth Speaker with LED Lights	Model Name :	RM89627
Temperature:	25 °C	Relative Humidity:	55%
Test Voltage:	DC 3.7V		
Ant. Pol.	Vertical		
Test Mode:	TX GFSK Mode 2480 MHz		
Remark:	N/A		

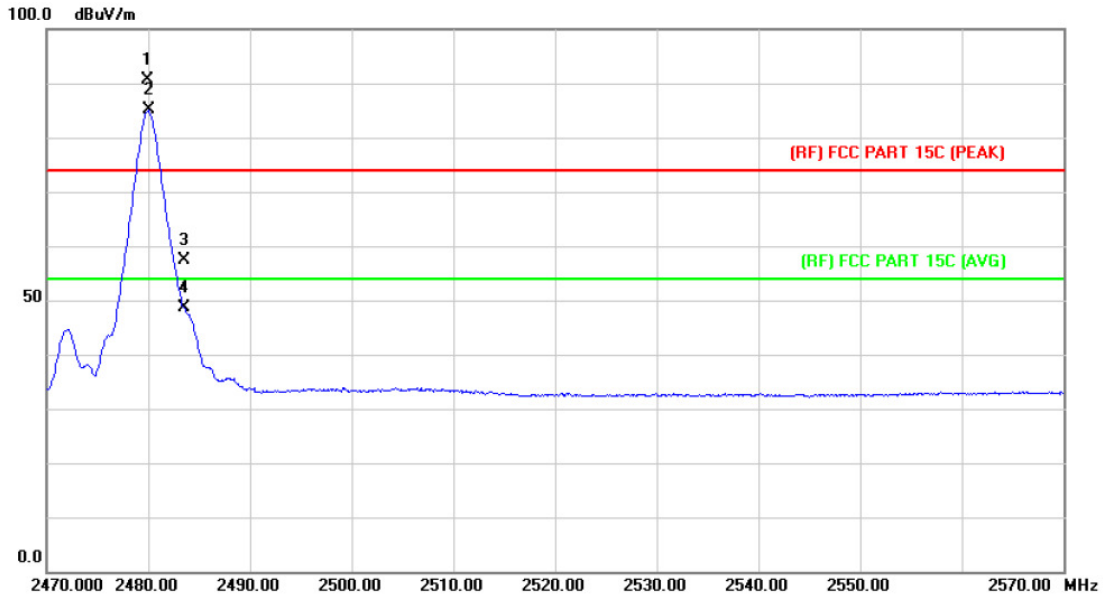

No.	Mk.	Freq. MHz	Reading Level dBuV	Correct Factor dB/m	Measure- ment dBuV/m	Limit dBuV/m	Over dB	Detector
1	X	2479.900	89.50	1.15	90.65	Fundamental Frequency		peak
2	*	2480.000	83.90	1.15	85.05	Fundamental Frequency		AVG
3		2483.500	56.15	1.17	57.32	74.00	-16.68	peak
4		2483.500	47.56	1.17	48.73	54.00	-5.27	AVG

Emission Level= Read Level+ Correct Factor

EUT:	Bluetooth Speaker with LED Lights	Model Name :	RM89627
Temperature:	25 °C	Relative Humidity:	55%
Test Voltage:	DC 3.7V		
Ant. Pol.	Horizontal		
Test Mode:	TX π /4-DQPSK Mode 2402MHz		
Remark:	N/A		

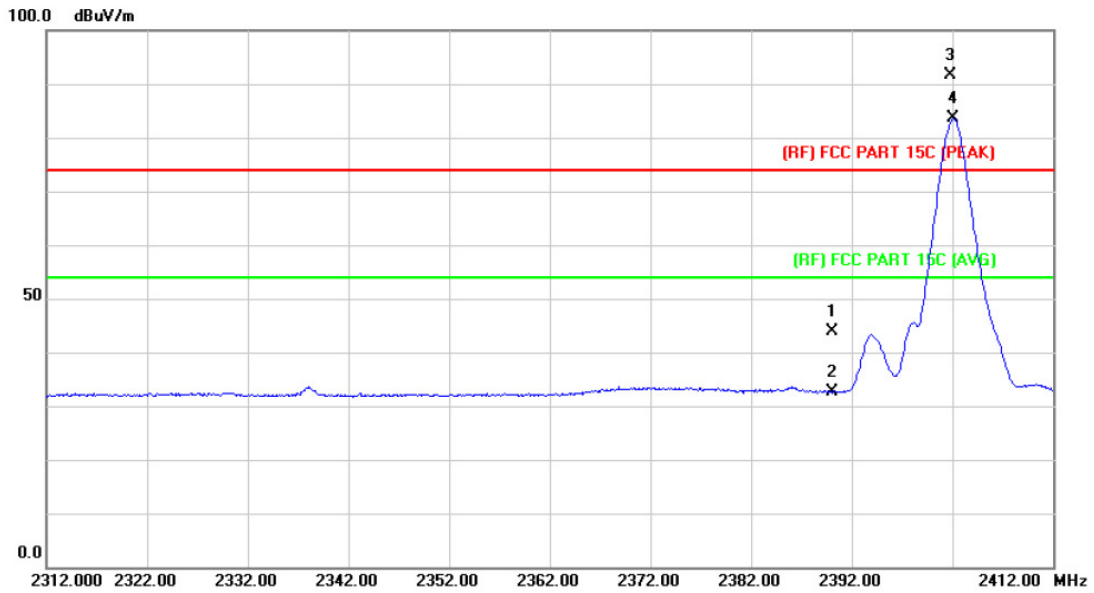

No.	Mk.	Freq.	Reading Level	Correct Factor	Measurement	Limit	Over	Detector
		MHz	dBuV	dB/m	dBuV/m	dBuV/m	dB	
1		2390.000	43.09	0.77	43.86	74.00	-30.14	peak
2		2390.000	31.84	0.77	32.61	54.00	-21.39	AVG
3	X	2401.800	90.79	0.82	91.61			Fundamental Frequency peak
4	*	2402.000	82.76	0.82	83.58			Fundamental Frequency AVG

Emission Level= Read Level+ Correct Factor

EUT:	Bluetooth Speaker with LED Lights	Model Name :	RM89627
Temperature:	25 °C	Relative Humidity:	55%
Test Voltage:	DC 3.7V		
Ant. Pol.	Vertical		
Test Mode:	TX $\pi/4$ -DQPSK Mode 2402MHz		
Remark:	N/A		

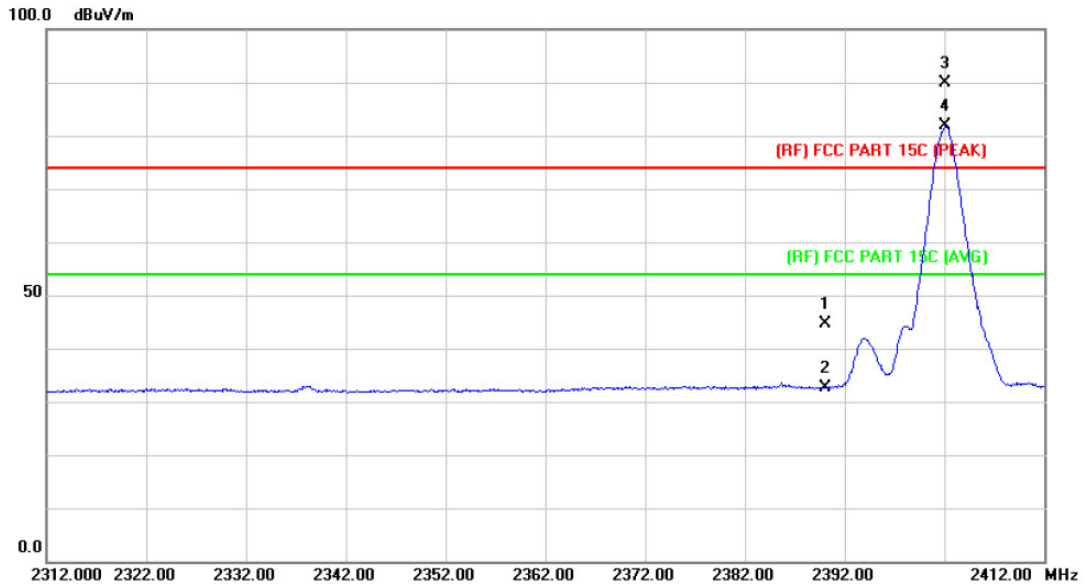

No.	Mk.	Freq. MHz	Reading Level dBuV	Correct Factor dB/m	Measure- ment dBuV/m	Limit dBuV/m	Over dB	Detector
1		2390.000	43.80	0.77	44.57	74.00	-29.43	peak
2		2390.000	31.85	0.77	32.62	54.00	-21.38	AVG
3	X	2402.000	88.95	0.82	89.77	Fundamental Frequency		peak
4	*	2402.100	80.99	0.82	81.81	Fundamental Frequency		AVG

Emission Level= Read Level+ Correct Factor

EUT:	Bluetooth Speaker with LED Lights	Model Name :	RM89627
Temperature:	25 °C	Relative Humidity:	55%
Test Voltage:	DC 3.7V		
Ant. Pol.	Horizontal		
Test Mode:	TX $\pi/4$ -DQPSK Mode 2480MHz		
Remark:	N/A		

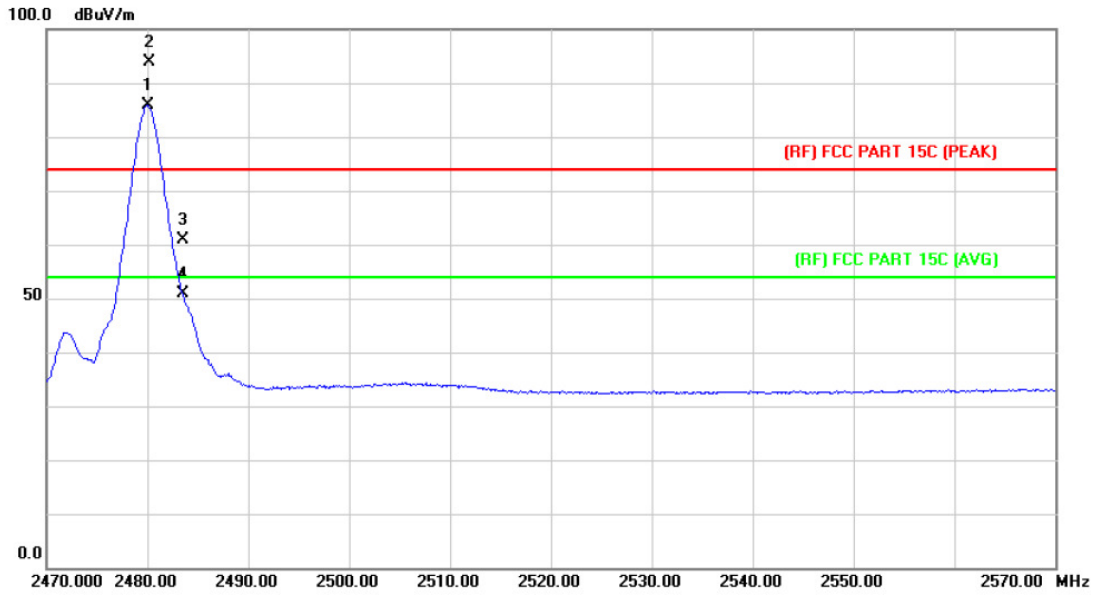

No.	Mk.	Freq. MHz	Reading Level dBuV	Correct Factor dB/m	Measure- ment dBuV/m	Limit dBuV/m	Over dB	Detector
1	*	2480.000	84.75	1.15	85.90	Fundamental Frequency		AVG
2	X	2480.200	92.76	1.15	93.91	Fundamental Frequency		peak
3		2483.500	59.79	1.17	60.96	74.00	-13.04	peak
4		2483.500	49.60	1.17	50.77	54.00	-3.23	AVG

Emission Level= Read Level+ Correct Factor

EUT:	Bluetooth Speaker with LED Lights	Model Name :	RM89627
Temperature:	25 °C	Relative Humidity:	55%
Test Voltage:	DC 3.7V		
Ant. Pol.	Vertical		
Test Mode:	TX $\pi/4$ -DQPSK Mode 2480MHz		
Remark:	N/A		

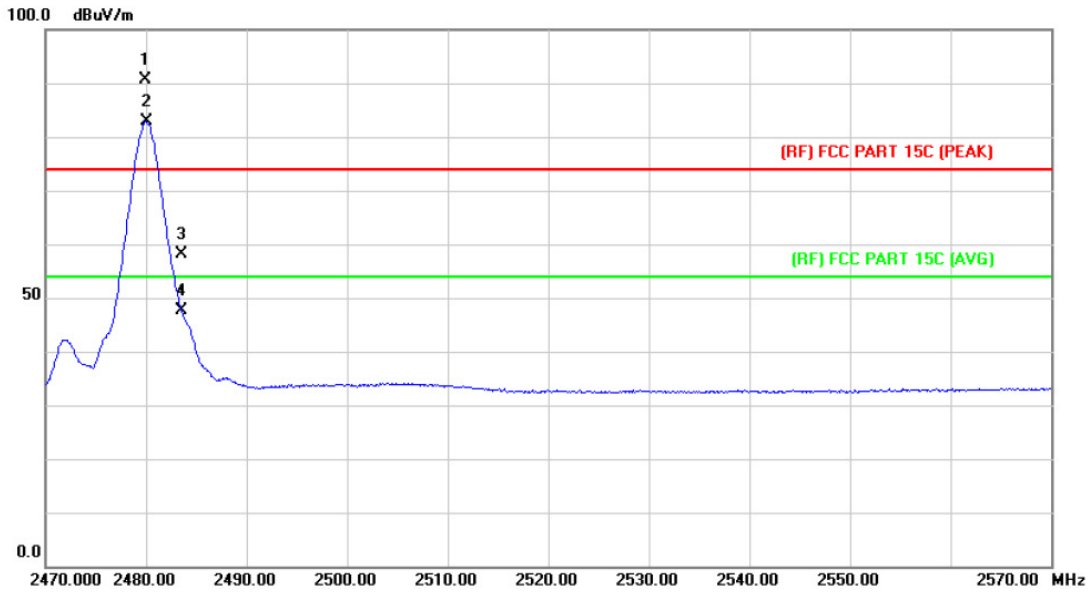

No.	Mk.	Freq. MHz	Reading Level dBuV	Correct Factor dB/m	Measure- ment dBuV/m	Limit dBuV/m	Over dB	Detector
1	X	2479.900	89.54	1.15	90.69	Fundamental Frequency		peak
2	*	2480.000	81.72	1.15	82.87	Fundamental Frequency		AVG
3		2483.500	56.92	1.17	58.09	74.00	-15.91	peak
4		2483.500	46.53	1.17	47.70	54.00	-6.30	AVG

Emission Level= Read Level+ Correct Factor

(2) Conducted Test

EUT:	Bluetooth Speaker with LED Lights	Model Name :	RM89627
Temperature:	25 °C	Relative Humidity:	55%
Test Voltage:	DC 3.7V		
Test Mode:	TX GFSK Mode 2402MHz / 2480 MHz		
Remark:	N/A		

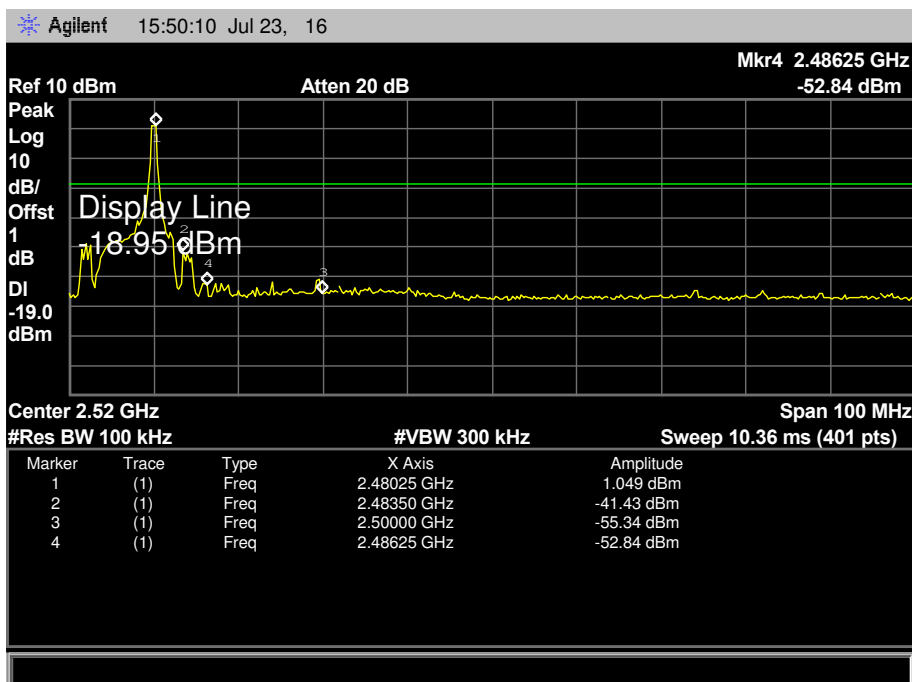
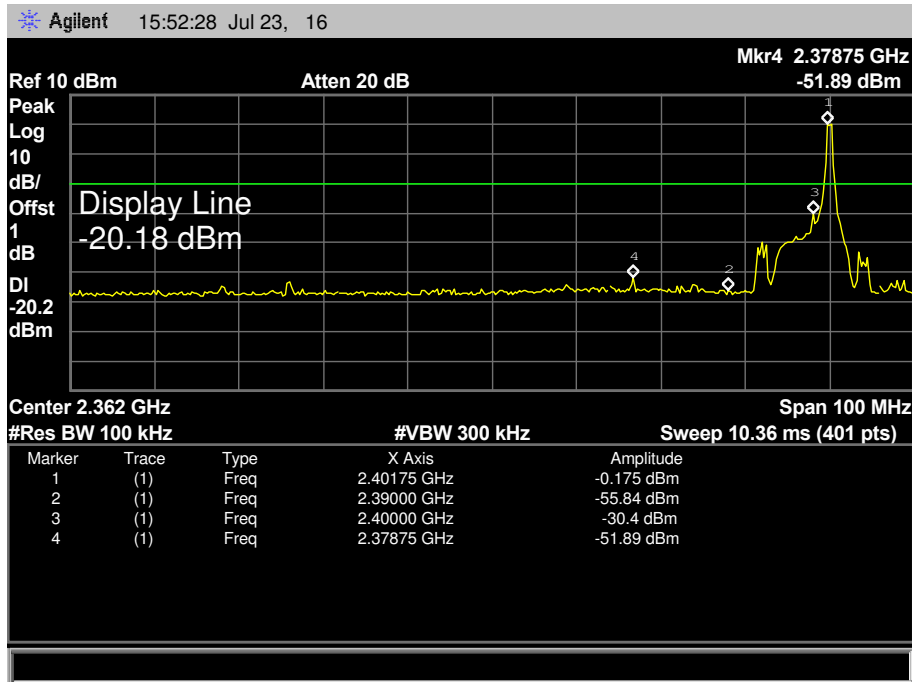

EUT:	Bluetooth Speaker with LED Lights	Model Name :	RM89627
Temperature:	25 °C	Relative Humidity:	55%
Test Voltage:	DC 3.7V		
Test Mode:	GFSK Hopping Mode		
Remark:	N/A		

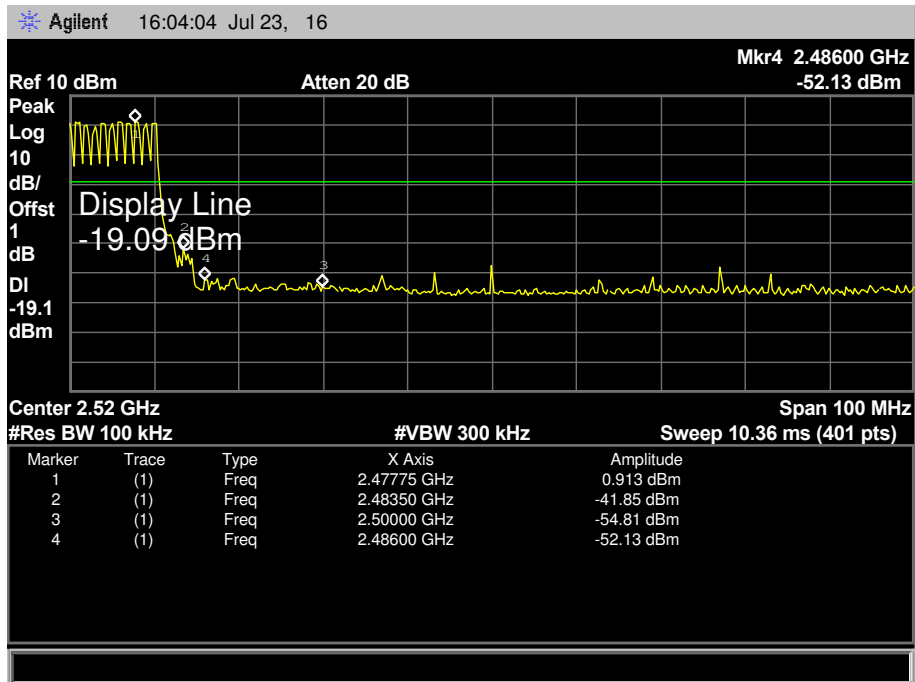
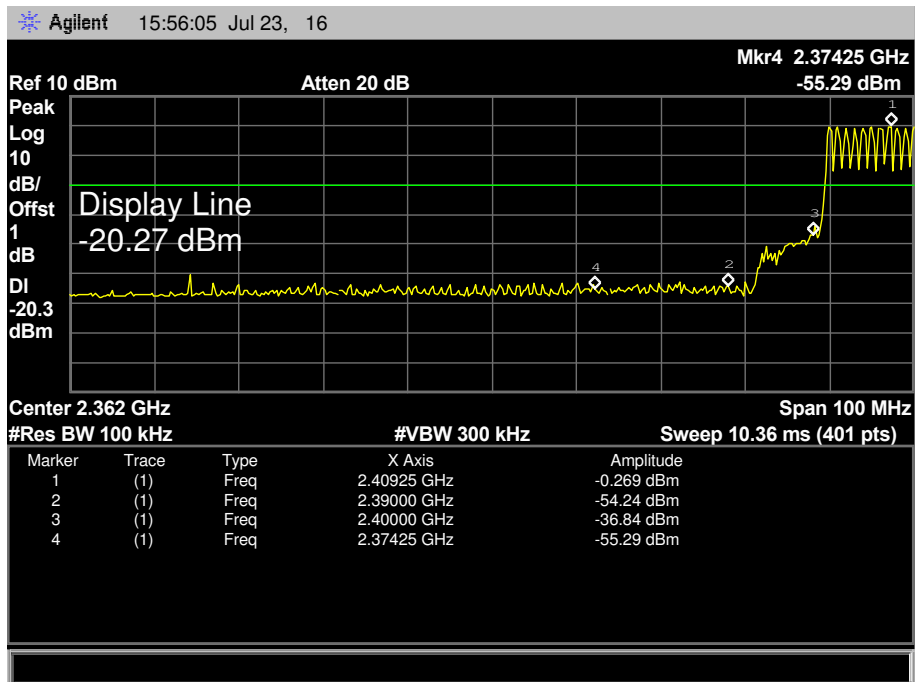

EUT:	Bluetooth Speaker with LED Lights	Model Name :	RM89627
Temperature:	25 °C	Relative Humidity:	55%
Test Voltage:	DC 3.7V		
Test Mode:	TX π /4-DQPSK Mode 2402MHz / 2480 MHz		
Remark:	N/A		

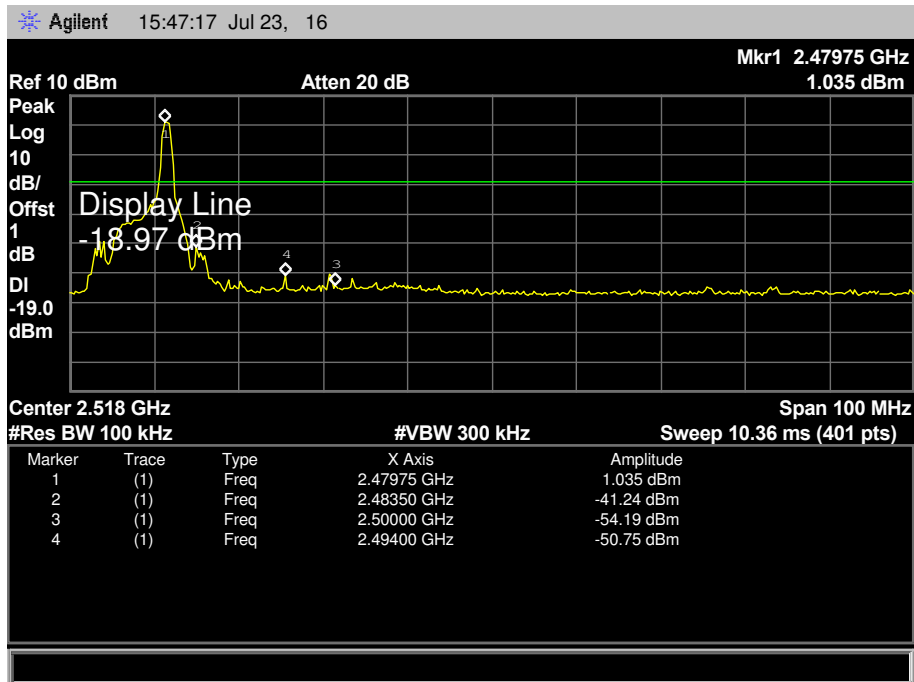
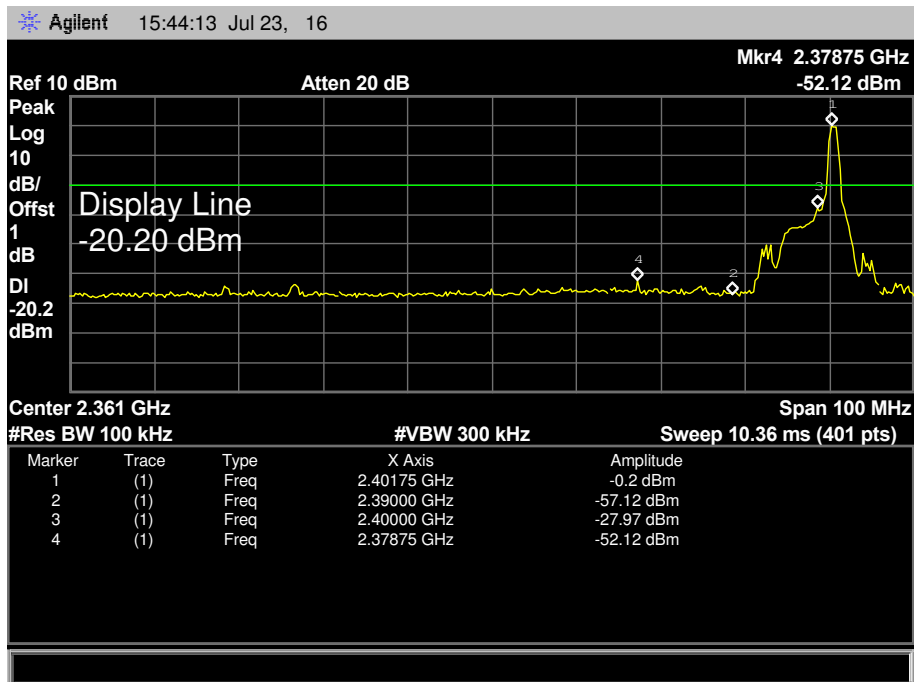

EUT:	Bluetooth Speaker with LED Lights	Model Name :	RM89627
Temperature:	25 °C	Relative Humidity:	55%
Test Voltage:	DC 3.7V		
Test Mode:	π /4-DQPSK Hopping Mode		
Remark:	N/A		

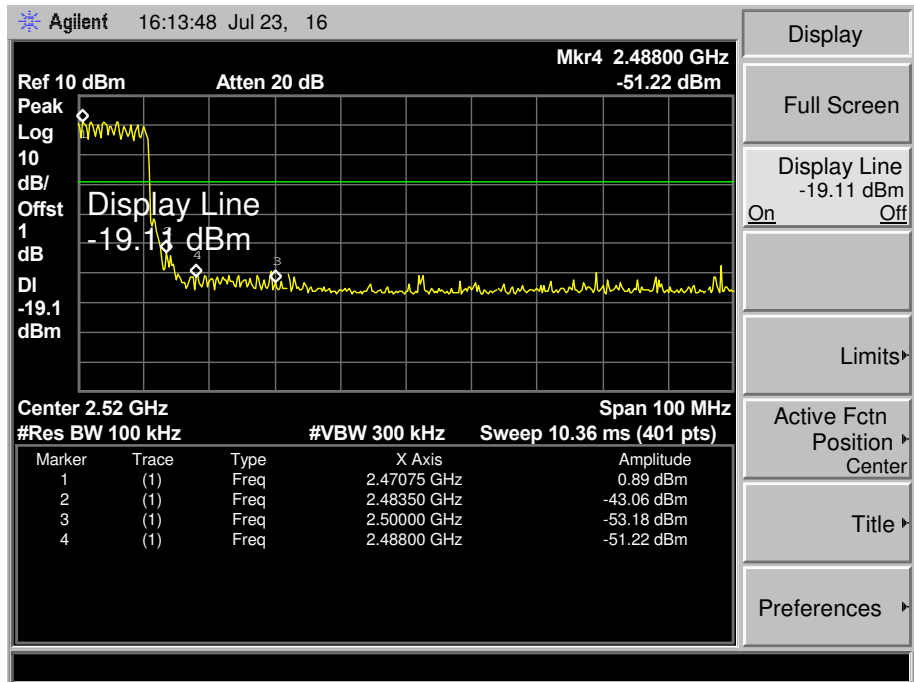
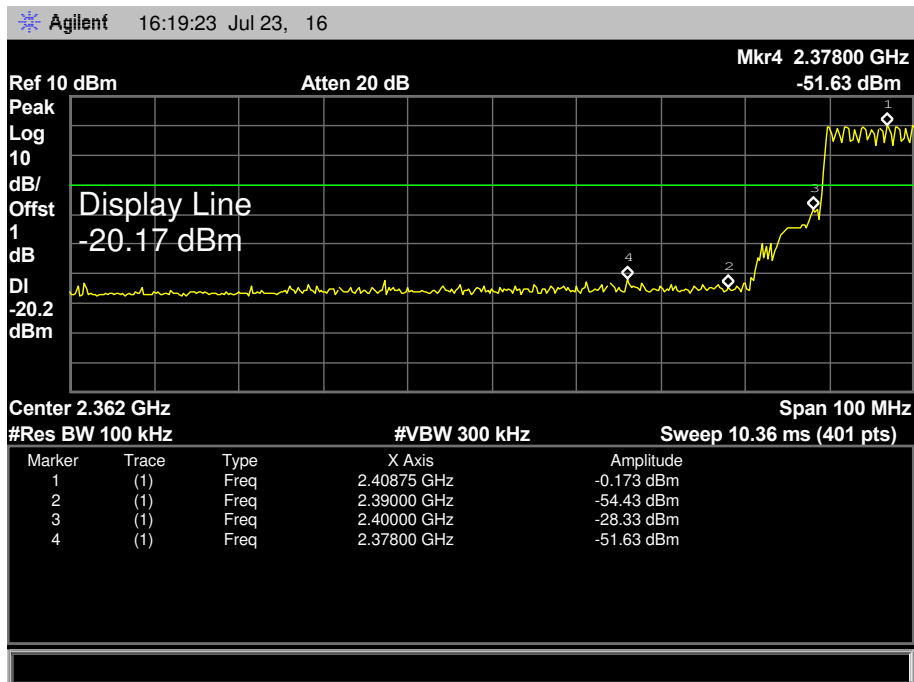

7. Number of Hopping Channel

7.1 Test Standard and Limit

6.1.1 Test Standard

FCC Part 15.247 (a)(1)

6.1.2 Test Limit

Section	Test Item	Limit
15.247	Number of Hopping Channel	>15

7.2 Test Setup

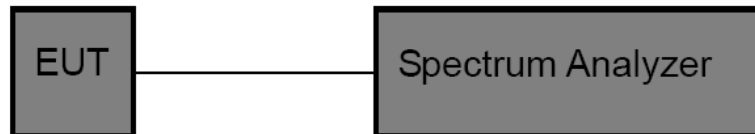

7.3 Test Procedure

- (1) The EUT was directly connected to the spectrum analyzer and antenna output port as show in the block diagram above.
- (2) Spectrum Setting: RBW=100 KHz, VBW=100 KHz, Sweep time= Auto.

7.4 EUT Operating Condition

The EUT was set to the Hopping Mode by the Customer.

7.5 Test Data

EUT:	Bluetooth Speaker with LED Lights	Model Name :	RM89627
Temperature:	25 °C	Relative Humidity:	55%
Test Voltage:	DC 3.7V		
Test Mode:	Hopping Mode (GFSK/ π /4-DQPSK)		
Frequency Range	Quantity of Hopping Channel		Limit
2402MHz~2480MHz	79		>15
	79		

GFSK Mode

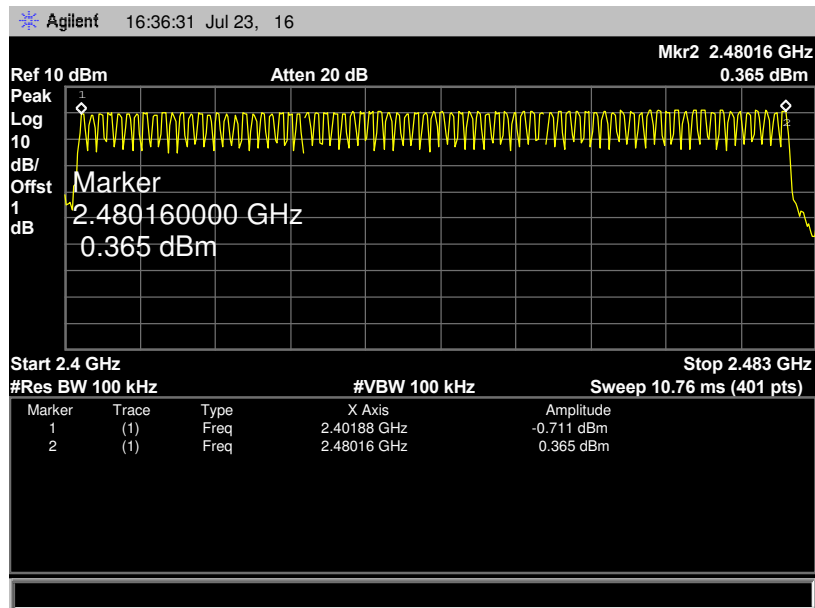

π /4-DQPSK Mode

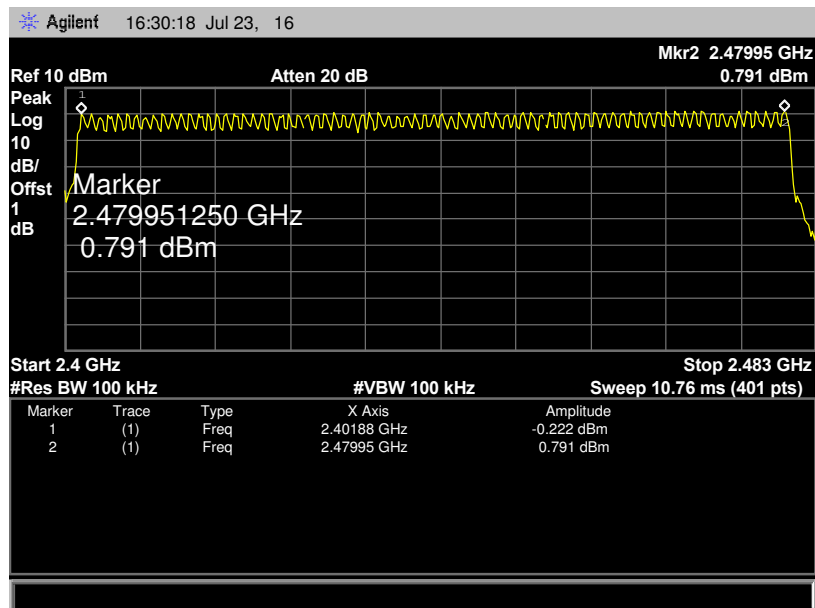

8. Average Time of Occupancy

8.1 Test Standard and Limit

- 8.1.1 Test Standard
FCC Part 15.247 (a)(1)
- 8.1.2 Test Limit

Section	Test Item	Limit
15.247(a)(1)/ RSS-210 Annex 8(A8.1d)	Average Time of Occupancy	0.4 sec

8.2 Test Setup

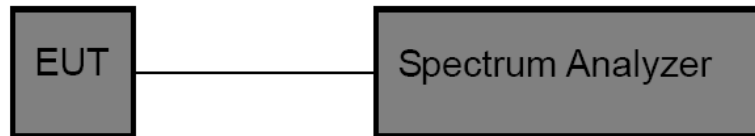

8.3 Test Procedure

- (1) The EUT was directly connected to the spectrum analyzer and antenna output port as show in the block diagram above.
- (2) Spectrum Setting: RBW=1MHz, VBW=1MHz.
- (3) Use video trigger with the trigger level set to enable triggering only on full pulses.
- (4) Sweep Time is more than once pulse time.
- (5) Set the center frequency on any frequency would be measure and set the frequency span to zero.
- (6) Measure the maximum time duration of one single pulse.
- (7) Set the EUT for packet transmitting.
- (8) Measure the maximum time duration of one single pulse.

8.4 EUT Operating Condition

The average time of occupancy on any channel within the Period can be calculated with formulas:

$$\{Total\ of\ Dwell\} = \{Pulse\ Time\} * (1600 / X) / \{Number\ of\ Hopping\ Frequency\} * \{Period\}$$

$$\{Period\} = 0.4s * \{Number\ of\ Hopping\ Frequency\}$$

Note: X=2 or 4 or 6 (1DH1=2, 1DH3=4, 1DH5=6. 2DH1=2, 2DH3=4, 2DH5=6. 3DH1=2,3DH3=4, 3DH5=6)

The lowest, middle and highest channels are selected to perform testing to record the dwell time of each occupation measured in this channel, which is called Pulse Time here.

The EUT was set to the Hopping Mode by the Customer.

8.5 Test Data

EUT:	Bluetooth Speaker with LED Lights	Model Name :	RM89627		
Temperature:	25 °C	Relative Humidity:	55%		
Test Voltage:	DC 3.7V				
Test Mode:	Hopping Mode (GFSK DH1)				
Channel (MHz)	Pulse Time (ms)	Total of Dwell (ms)	Period Time (s)	Limit (ms)	Result
2402	0.390	124.80	31.60	400	PASS
2441	0.390	124.80			
2480	0.390	124.80			

Note: Dwell time=Pulse Time (ms) × (1600 ÷ 2 ÷ 79) ×31.6

GFSK Hopping Mode DH1

2402 MHz

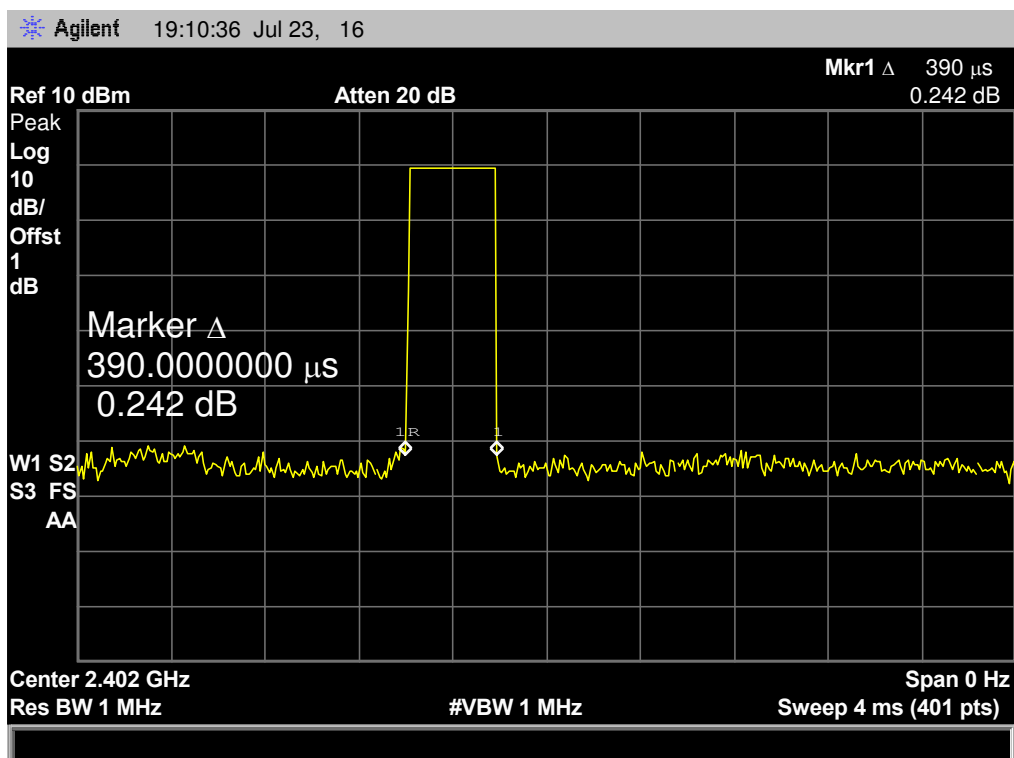

GFSK Hopping Mode DH1

2441 MHz

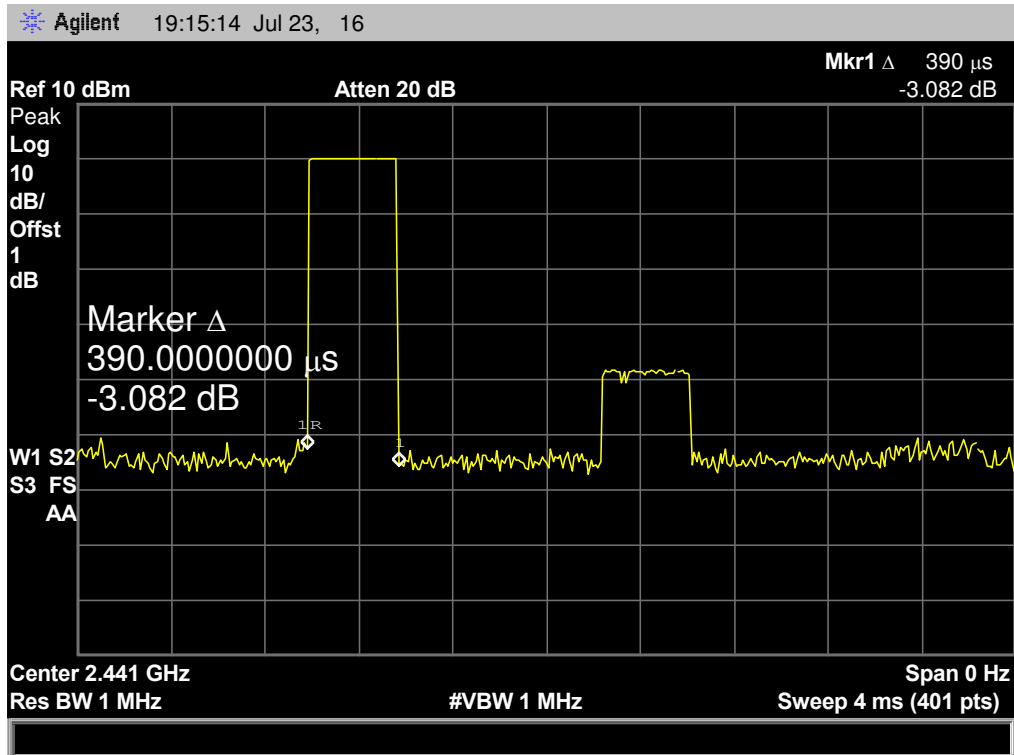

GFSK Hopping Mode DH1

2480 MHz

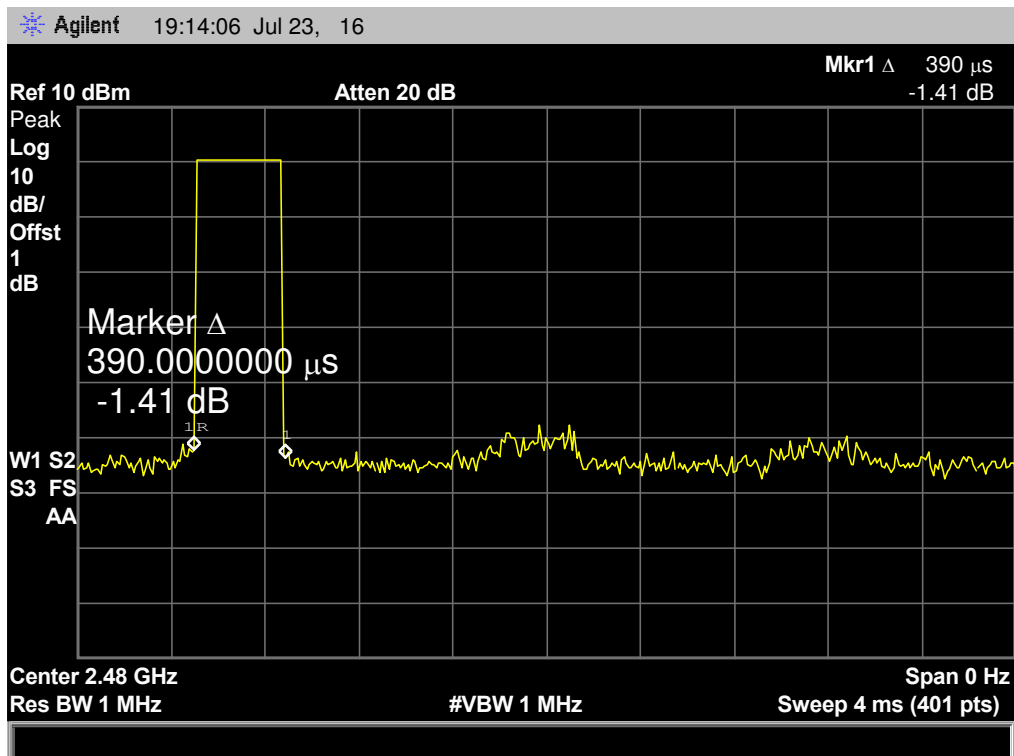

EUT:	Bluetooth Speaker with LED Lights		Model Name :	RM89627	
Temperature:	25 °C		Relative Humidity:	55%	
Test Voltage:	DC 3.7V				
Test Mode:	Hopping Mode (GFSK DH3)				
Channel (MHz)	Pulse Time (ms)	Total of Dwell (ms)	Period Time (s)	Limit (ms)	Result
2402	1.680	268.80	31.60	400	PASS
2441	1.680	268.80			
2480	1.680	268.80			

Note: Dwell time= Pulse Time (ms) × (1600 ÷ 4 ÷ 79) × 31.6

GFSK Hopping Mode DH3

2402 MHz

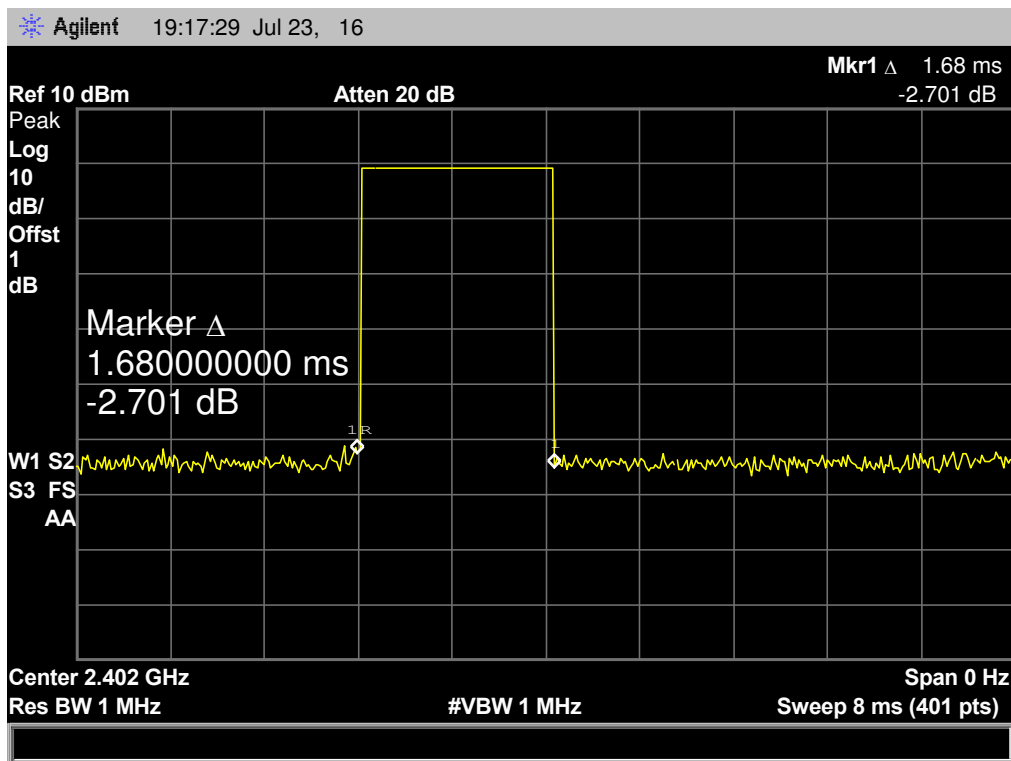

GFSK Hopping Mode DH3

2441 MHz

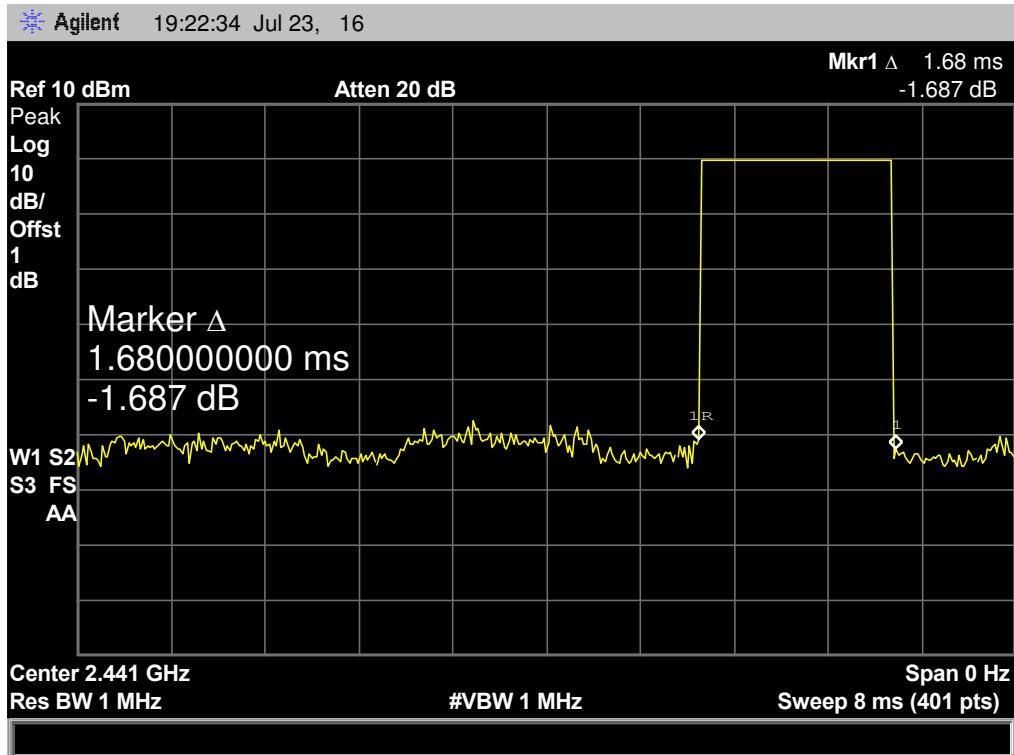

GFSK Hopping Mode DH3

2480 MHz

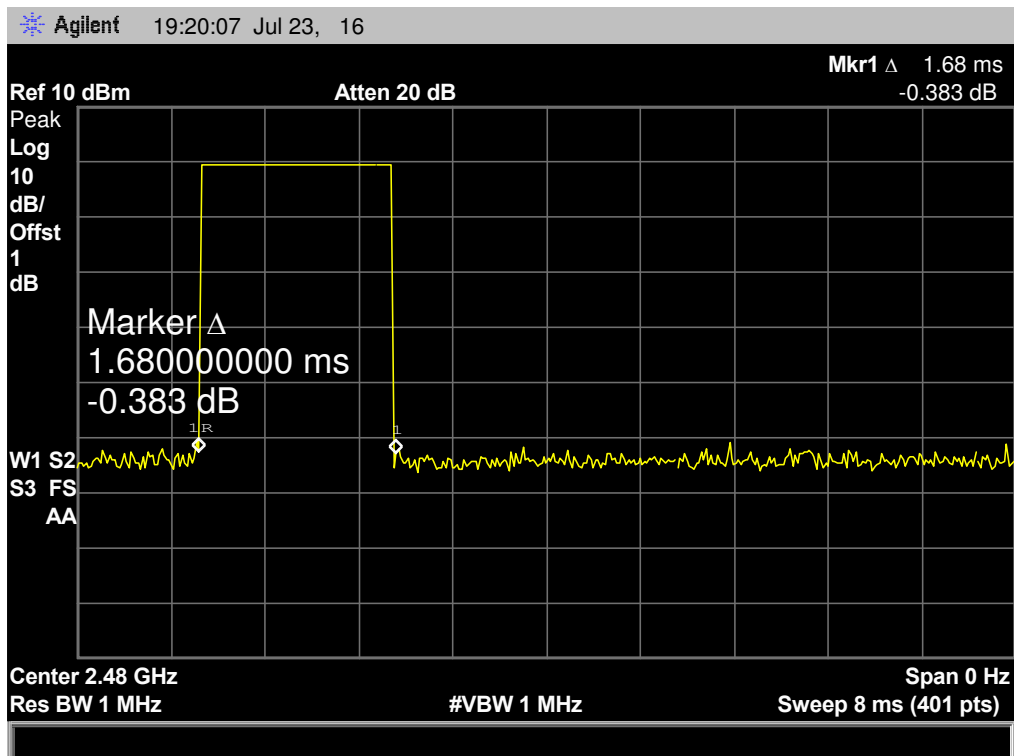

EUT:	Bluetooth Speaker with LED Lights		Model Name :	RM89627	
Temperature:	25 °C		Relative Humidity:	55%	
Test Voltage:	DC 3.7V				
Test Mode:	Hopping Mode (GFSK DH5)				
Channel (MHz)	Pulse Time (ms)	Total of Dwell (ms)	Period Time (s)	Limit (ms)	Result
2402	2.940	313.60	31.60	400	PASS
2441	2.940	313.60			
2480	2.940	313.60			

Note: Dwell time= Pulse Time (ms) × (1600 ÷ 6 ÷ 79) × 31.6

GFSK Hopping Mode DH5

2402 MHz

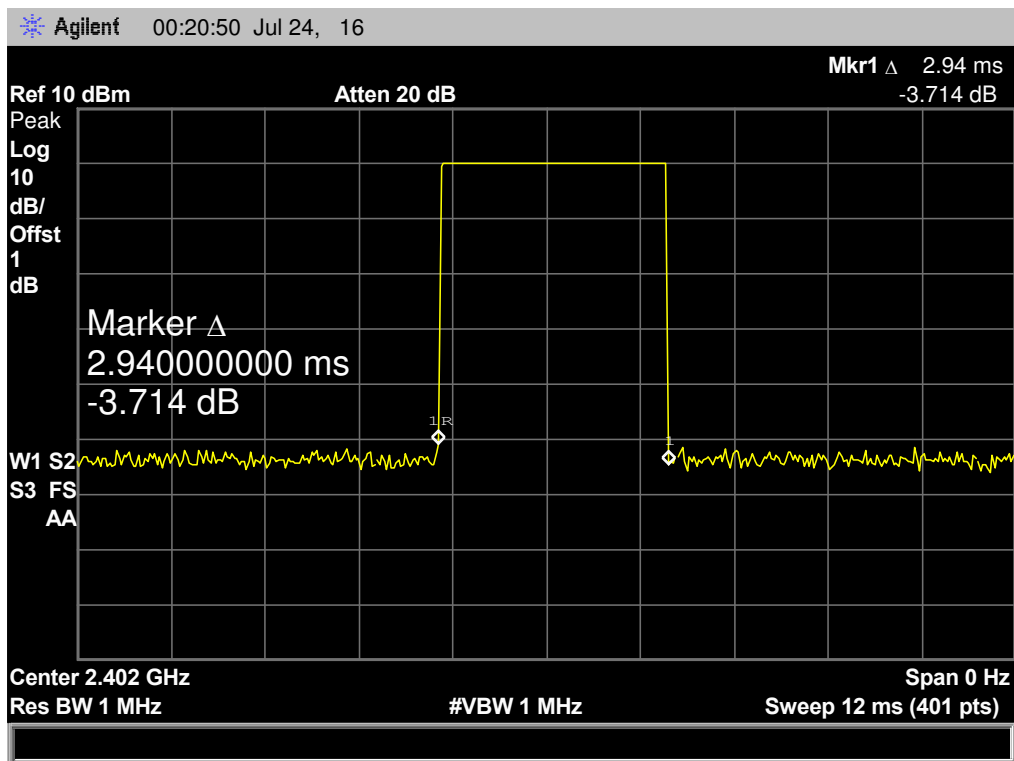

GFSK Hopping Mode DH5

2441 MHz

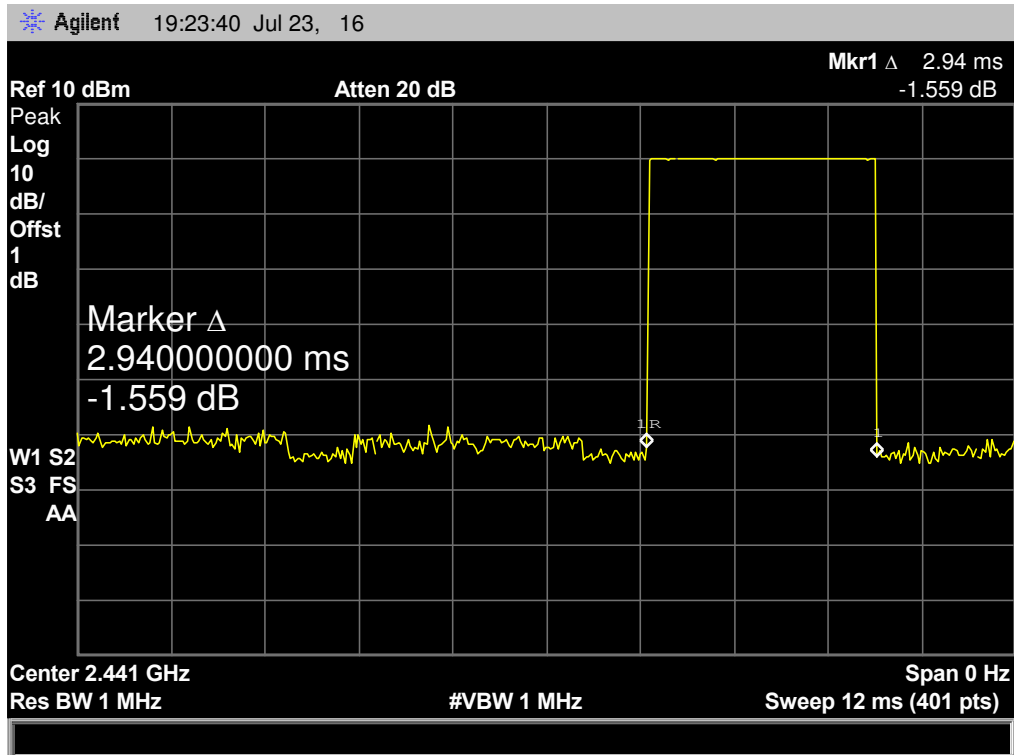

GFSK Hopping Mode DH5

2480 MHz

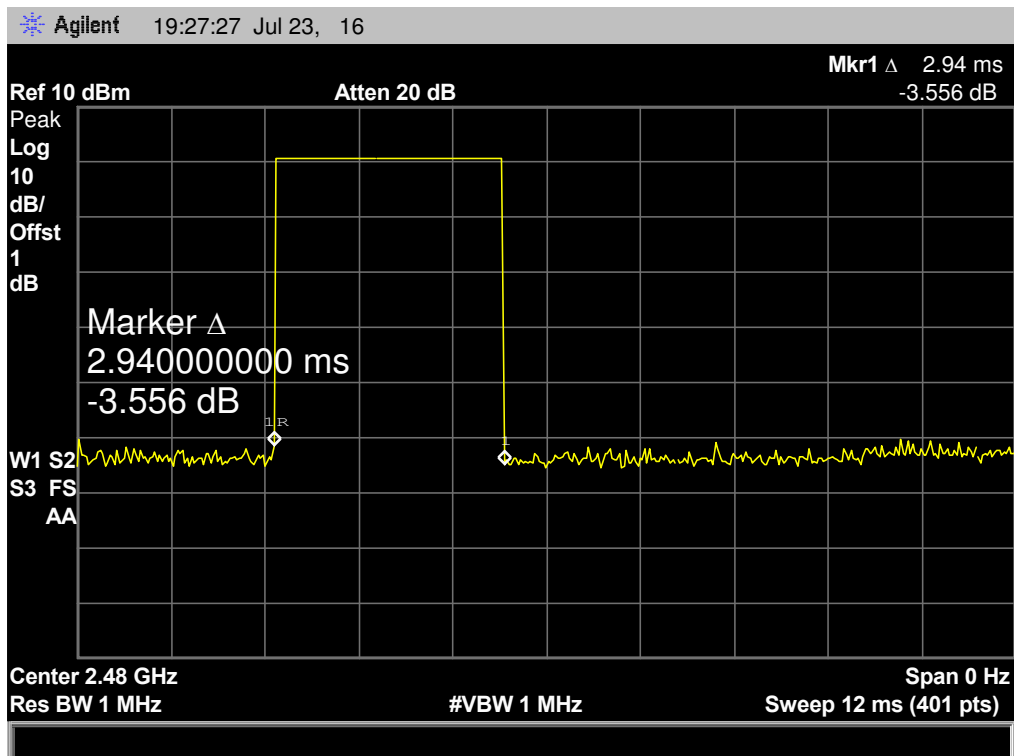

EUT:	Bluetooth Speaker with LED Lights	Model Name :	RM89627		
Temperature:	25 °C	Relative Humidity:	55%		
Test Voltage:	DC 3.7V				
Test Mode:	Hopping Mode ($\pi/4$ -DQPSK DH1)				
Channel (MHz)	Pulse Time (ms)	Total of Dwell (ms)	Period Time (s)	Limit (ms)	Result
2402	0.410	131.20	31.60	400	PASS
2441	0.410	131.20			
2480	0.410	131.20			

Note: Dwell time= Pulse Time (ms) \times (1600 \div 2 \div 79) \times 31.6

$\pi/4$ -DQPSK Hopping Mode DH1

2402 MHz

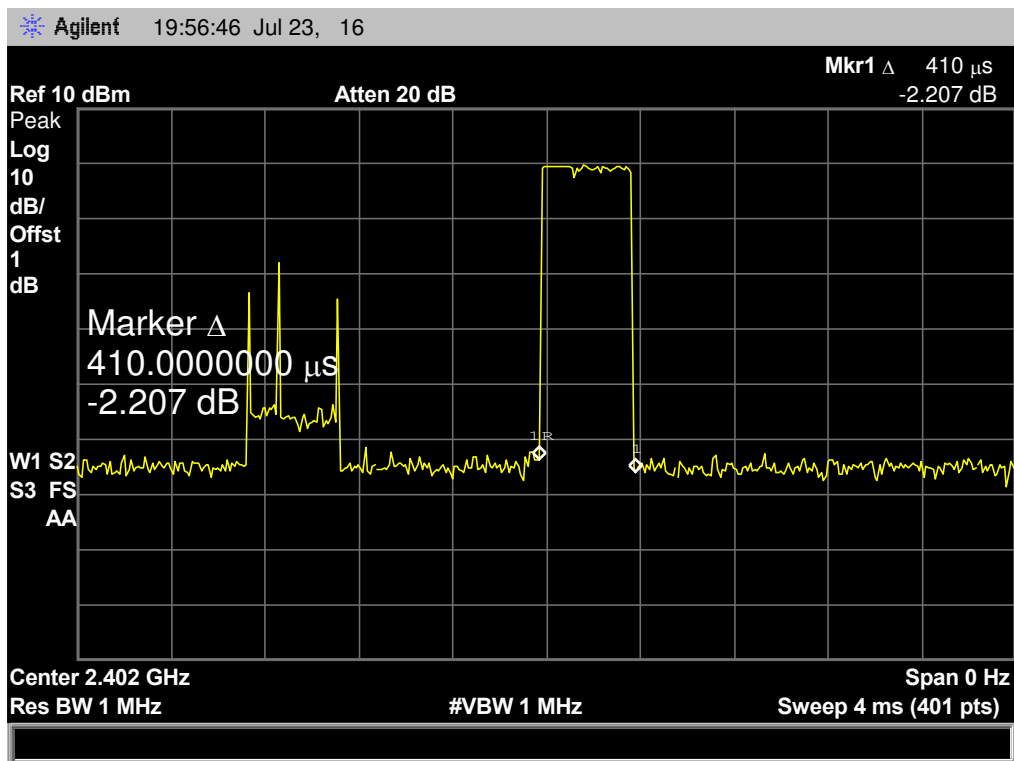

π /4-DQPSK Hopping Mode DH1

2441 MHz

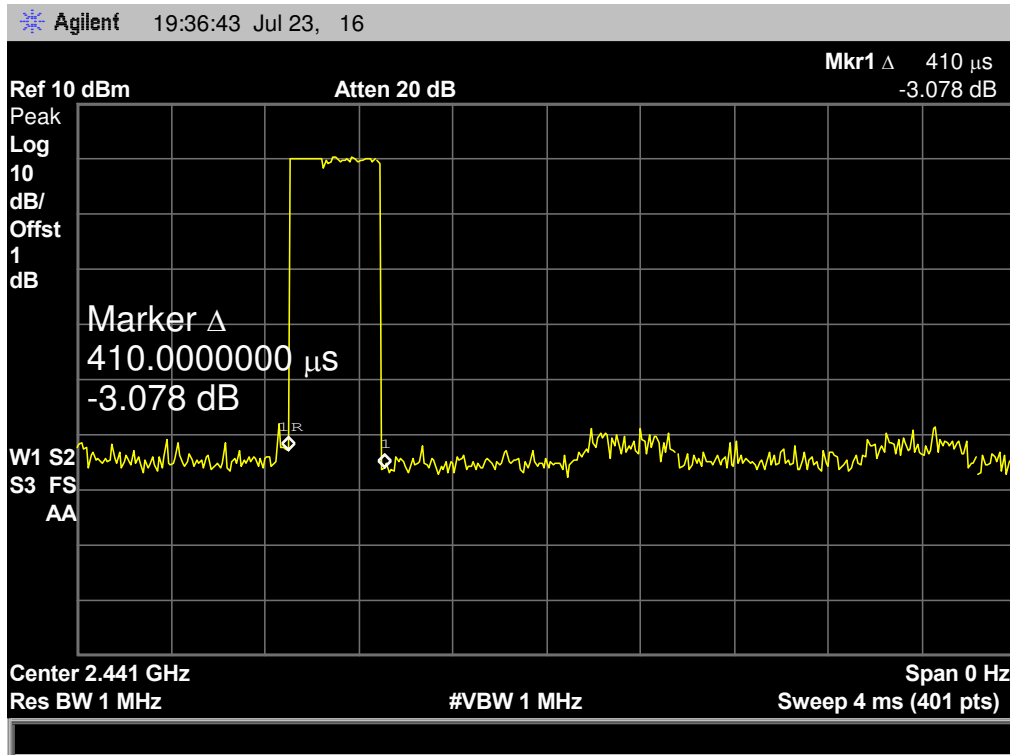

π /4-DQPSK Hopping Mode DH1

2480 MHz

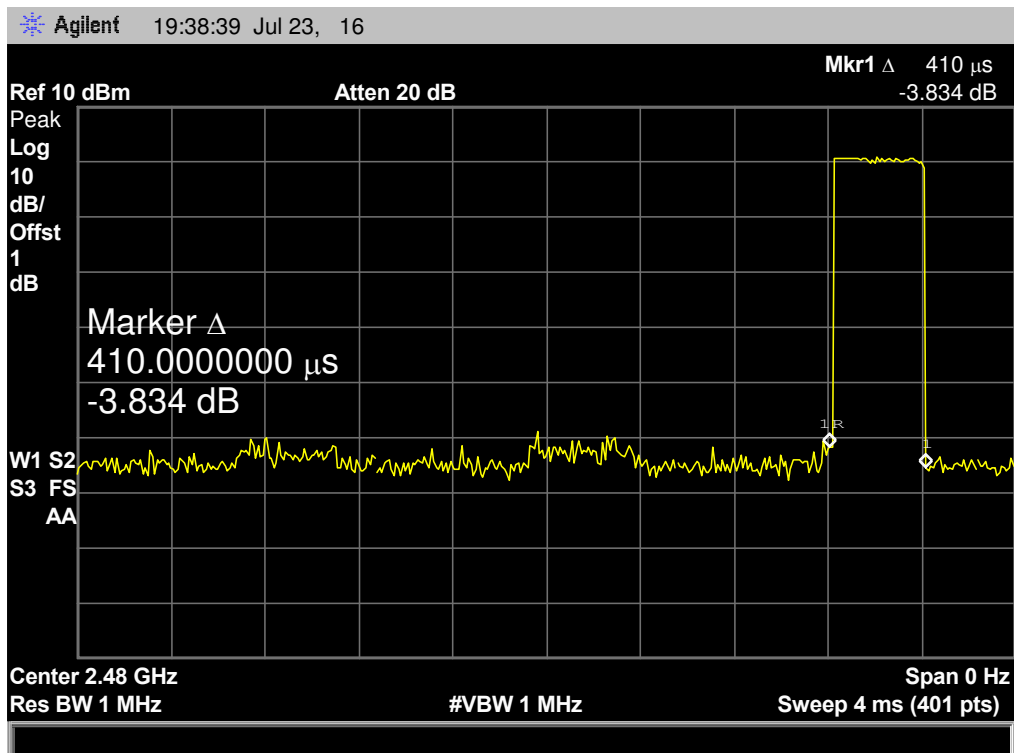

EUT:	Bluetooth Speaker with LED Lights	Model Name :	RM89627		
Temperature:	25 °C	Relative Humidity:	55%		
Test Voltage:	DC 3.7V				
Test Mode:	Hopping Mode (π /4-DQPSK DH3)				
Channel (MHz)	Pulse Time (ms)	Total of Dwell (ms)	Period Time (s)	Limit (ms)	Result
2402	1.680	268.80	31.60	400	PASS
2441	1.680	268.80			
2480	1.680	268.80			

Note: Dwell time= Pulse Time (ms) × (1600 ÷ 4 ÷ 79) × 31.6

π /4-DQPSK Hopping Mode DH3

2402 MHz

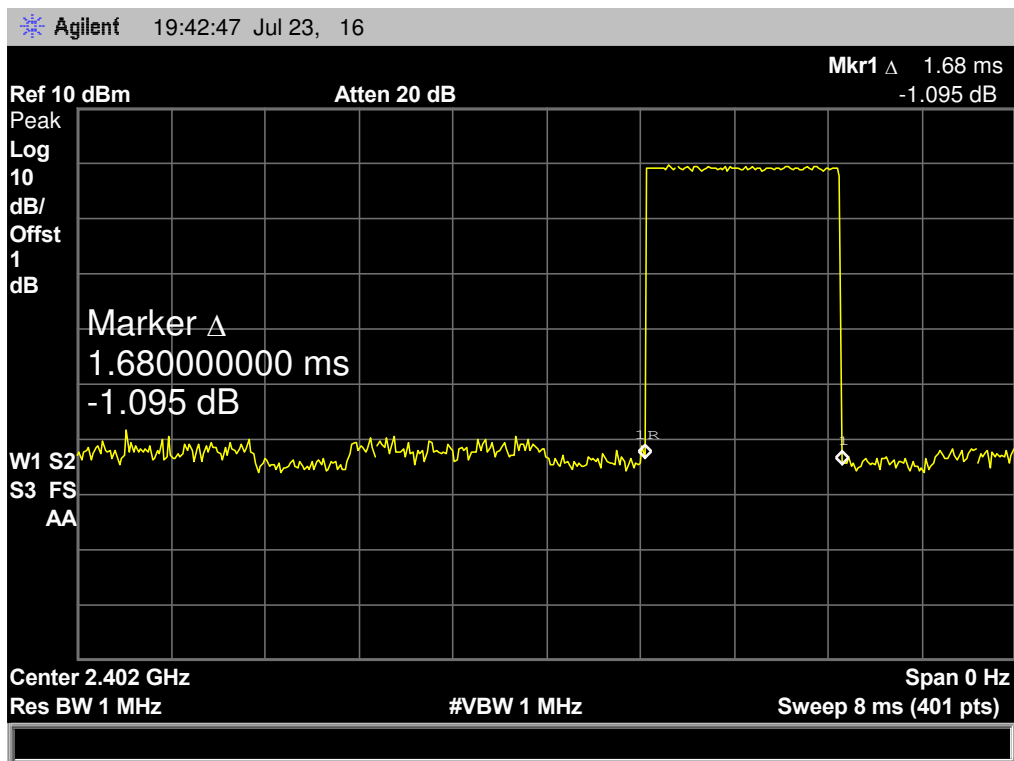

π /4-DQPSK Hopping Mode DH3

2441 MHz

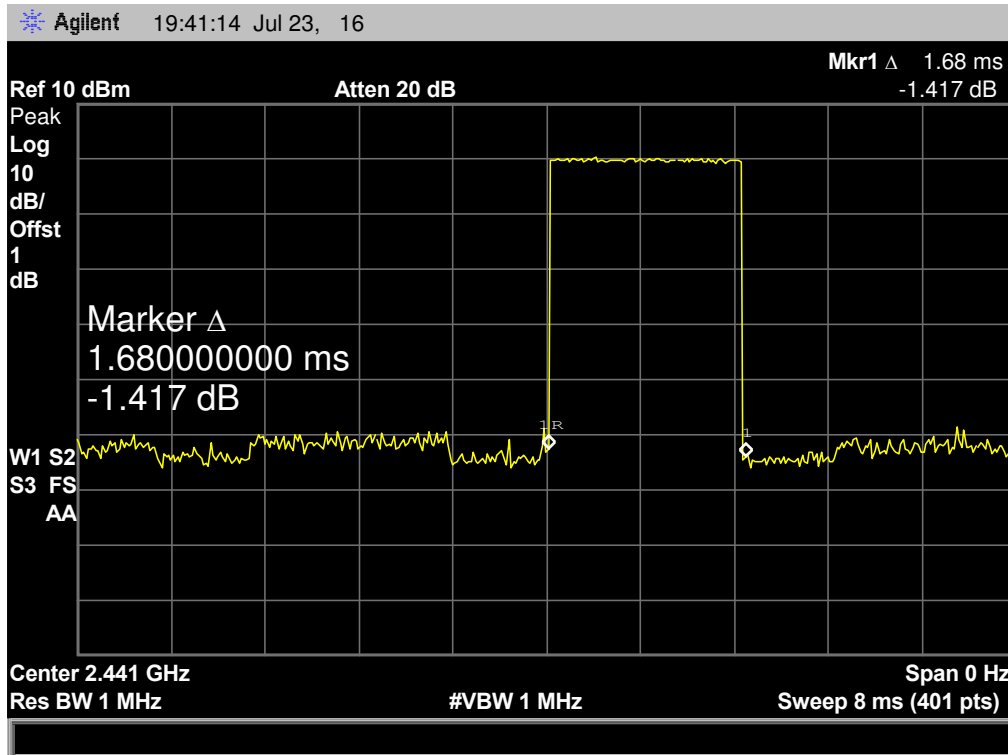

π /4-DQPSK Hopping Mode DH3

2480 MHz

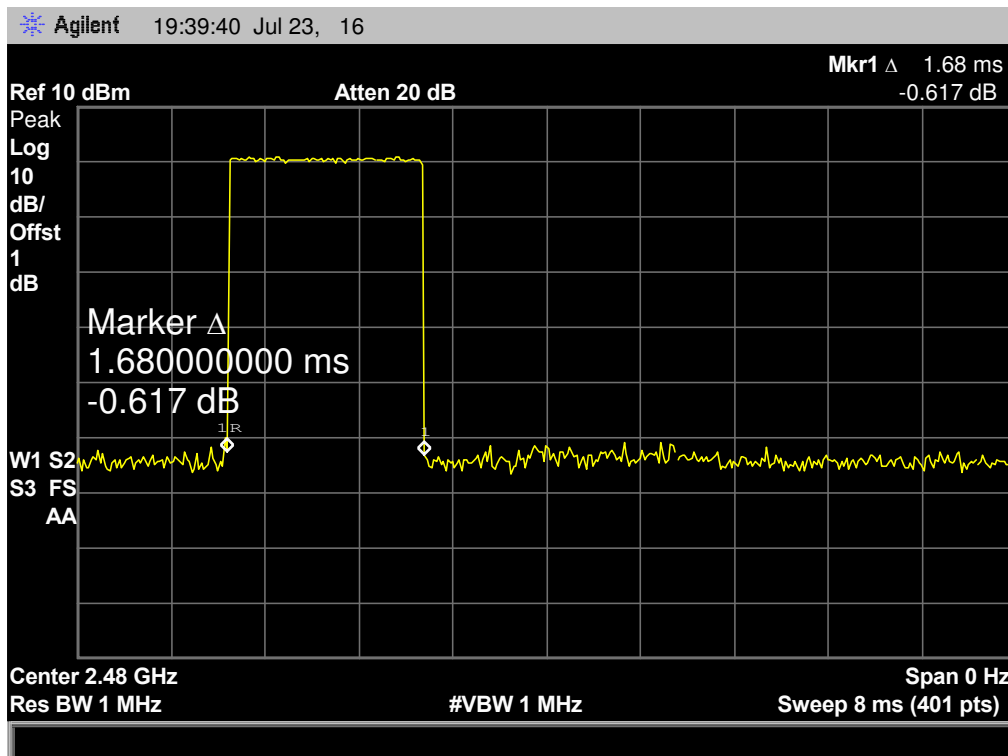

EUT:	Bluetooth Speaker with LED Lights	Model Name :	RM89627		
Temperature:	25 °C	Relative Humidity:	55%		
Test Voltage:	DC 3.7V				
Test Mode:	Hopping Mode (π /4-DQPSK DH5)				
Channel (MHz)	Pulse Time (ms)	Total of Dwell (ms)	Period Time (s)	Limit (ms)	Result
2402	3.000	320.00	31.60	400	PASS
2441	3.000	320.00			
2480	3.000	320.00			

Note: Dwell time= Pulse Time (ms) × (1600 ÷ 6 ÷ 79) × 31.6

π /4-DQPSK Hopping Mode DH5

2402 MHz

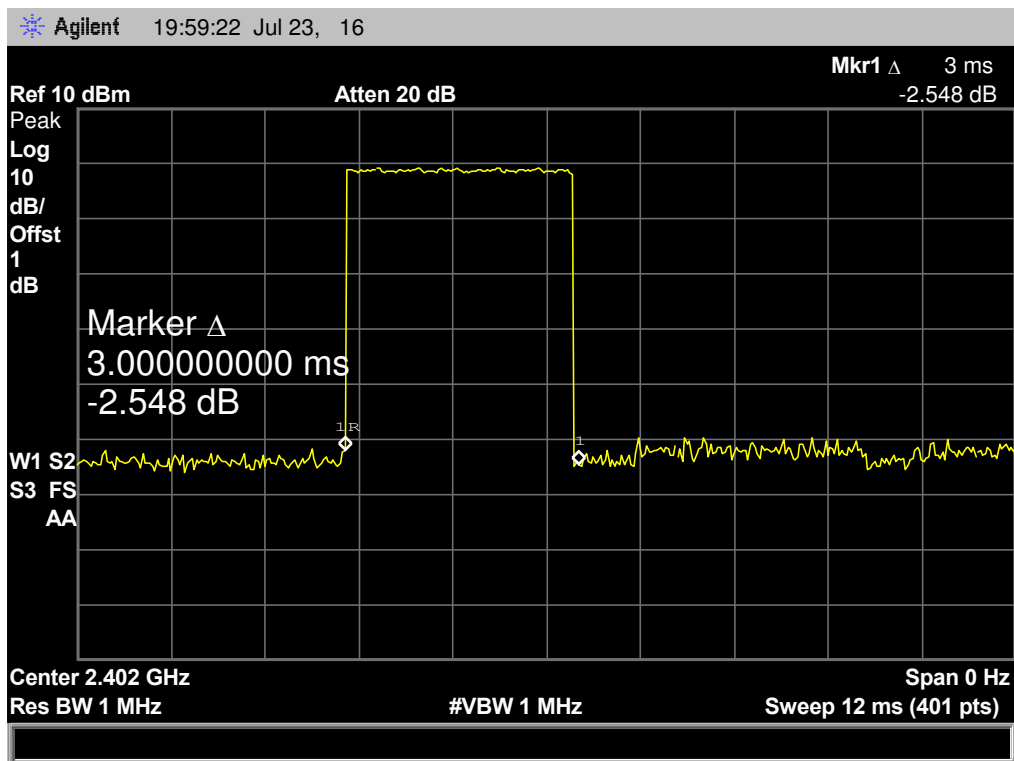

π /4-DQPSK Hopping Mode DH5

2441 MHz

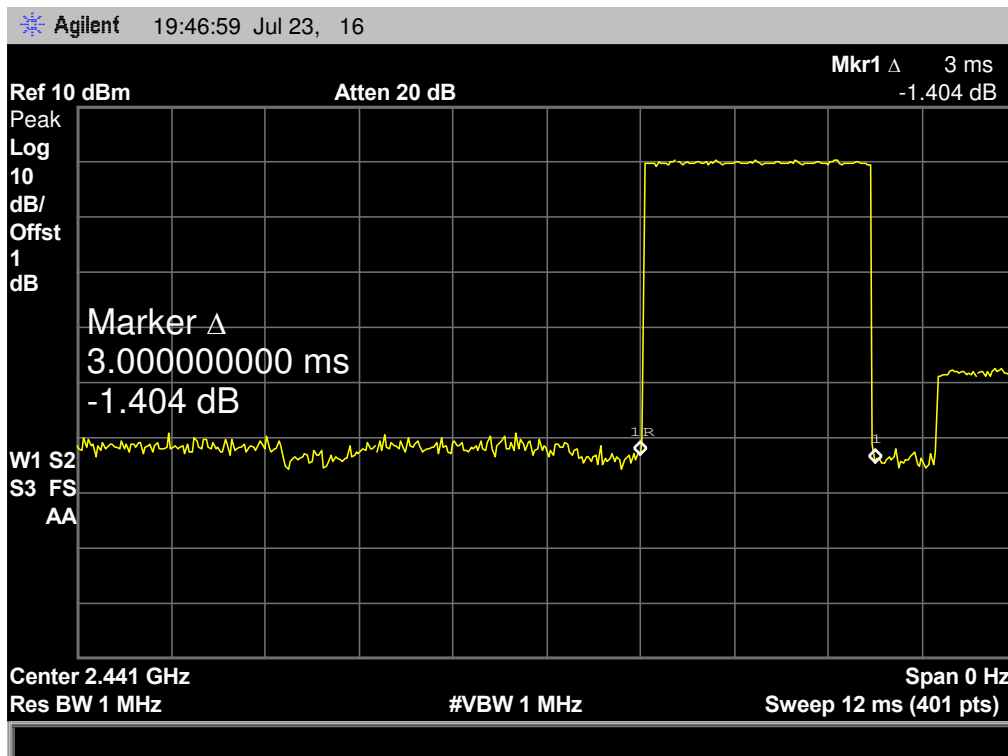

π /4-DQPSK Hopping Mode DH5

2480 MHz

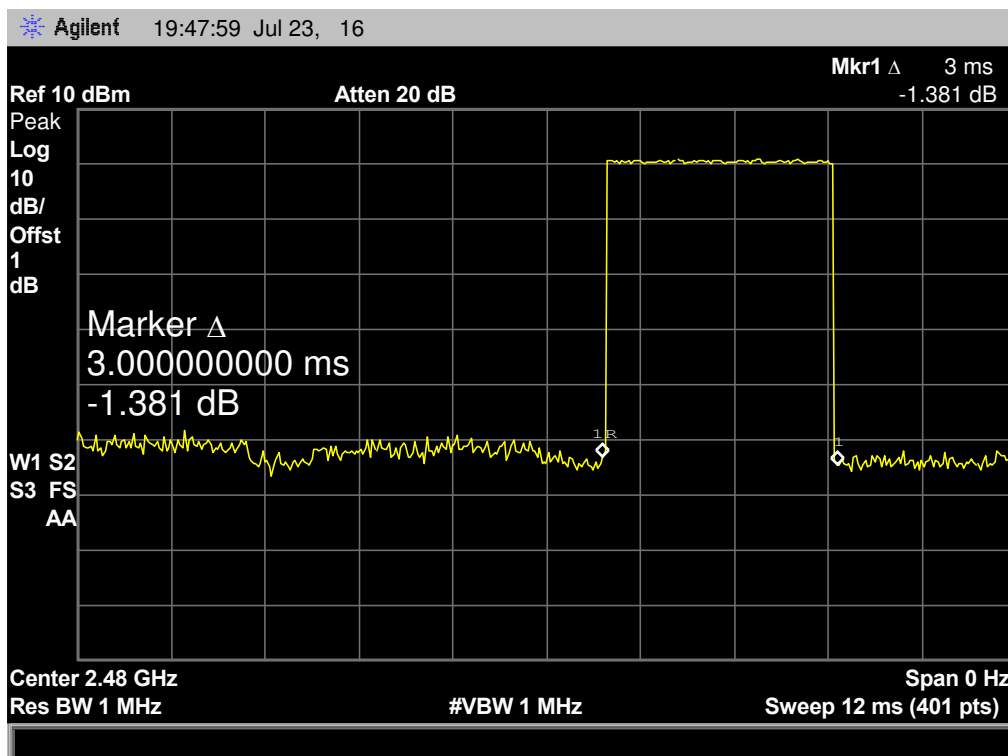

9. Channel Separation and Bandwidth Test

9.1 Test Standard and Limit

- 9.1.1 Test Standard
FCC Part 15.247
- 9.1.2 Test Limit

Test Item	Limit	Frequency Range(MHz)
Bandwidth	≤ 1 MHz (20dB bandwidth)	2400~2483.5
Channel Separation	>25 kHz or $>$ two-thirds of the 20 dB bandwidth Which is greater	2400~2483.5

9.2 Test Setup

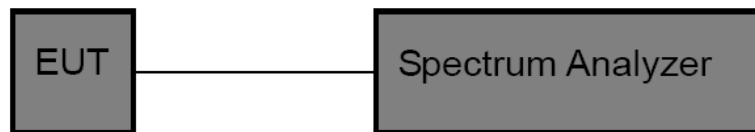

9.3 Test Procedure

- (1) The EUT was directly connected to the spectrum analyzer and antenna output port as show in the block diagram above.
- (2) Spectrum Setting:
Channel Separation: RBW=30 kHz, VBW=100 kHz.
Bandwidth: RBW=30 kHz, VBW=100 kHz.
- (3) The bandwidth is measured at an amplitude level reduced 20dB from the reference level. The reference level is the level of the highest amplitude signal observed from the transmitter at the fundamental frequency. Once the reference level is established, the equipment is conditioned with typical modulating signal to produce the worst –case (i.e the widest) bandwidth.
- (4) Measure the channel separation the spectrum analyzer was set to Resolution Bandwidth:30 kHz, and Video Bandwidth:100 kHz. Sweep Time set auto.

9.4 EUT Operating Condition

The EUT was set to the Hopping Mode for Channel Separation Test and continuously transmitting for the Bandwidth Test.

9.5 Test Data

EUT:	Bluetooth Speaker with LED Lights	Model Name :	RM89627
Temperature:	25 °C	Relative Humidity:	55%
Test Voltage:	DC 3.7V		
Test Mode:	TX Mode (GFSK)		
Channel frequency (MHz)	99% OBW (kHz)	20dB Bandwidth (kHz)	20dB Bandwidth *2/3 (kHz)
2402	891.8281	960.812	
2441	883.1539	952.424	
2480	872.2082	947.546	

GFSK TX Mode

2402 MHz

Agilent 15:17:21 Jul 23, 16

Ref 10 dBm Atten 20 dB

#Peak Log 10 dB/Offst 1 dB

VBW 100.000000 kHz

Center 2.402 GHz Span 3 MHz

#Res BW 30 kHz #VBW 100 kHz Sweep 5 ms (401 pts)

Occupied Bandwidth 891.8281 kHz

Occ BW % Pwr 99.00 %
x dB -20.00 dB

Transmit Freq Error 8.729 kHz
x dB Bandwidth 960.812 kHz

GFSK TX Mode

2441 MHz

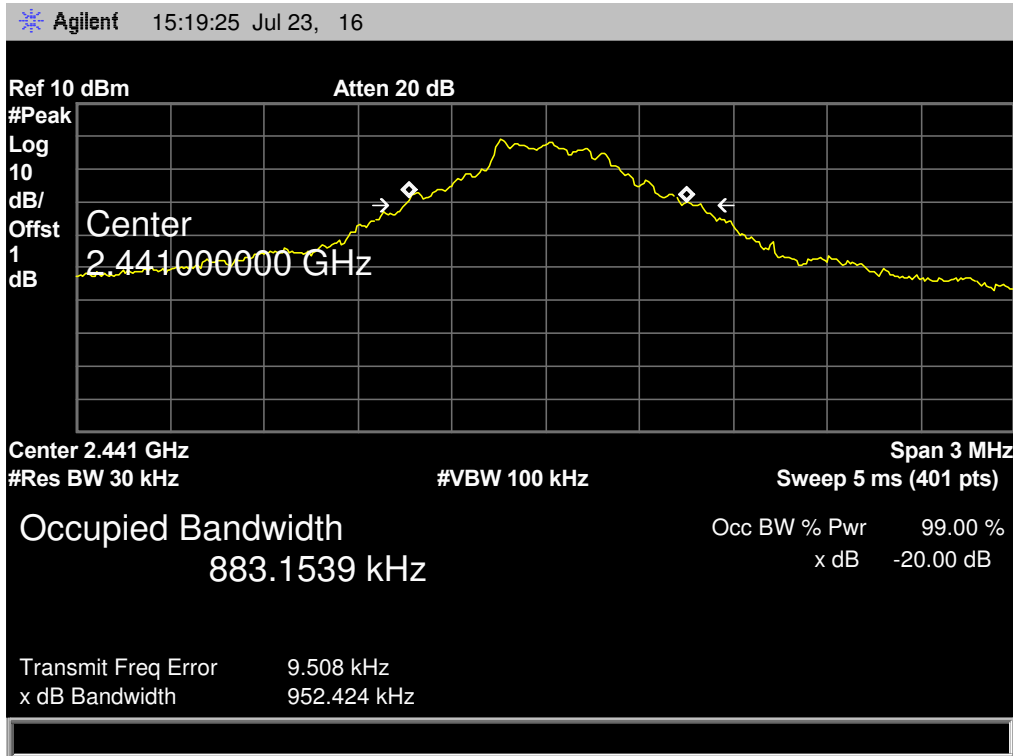

GFSK TX Mode

2480 MHz

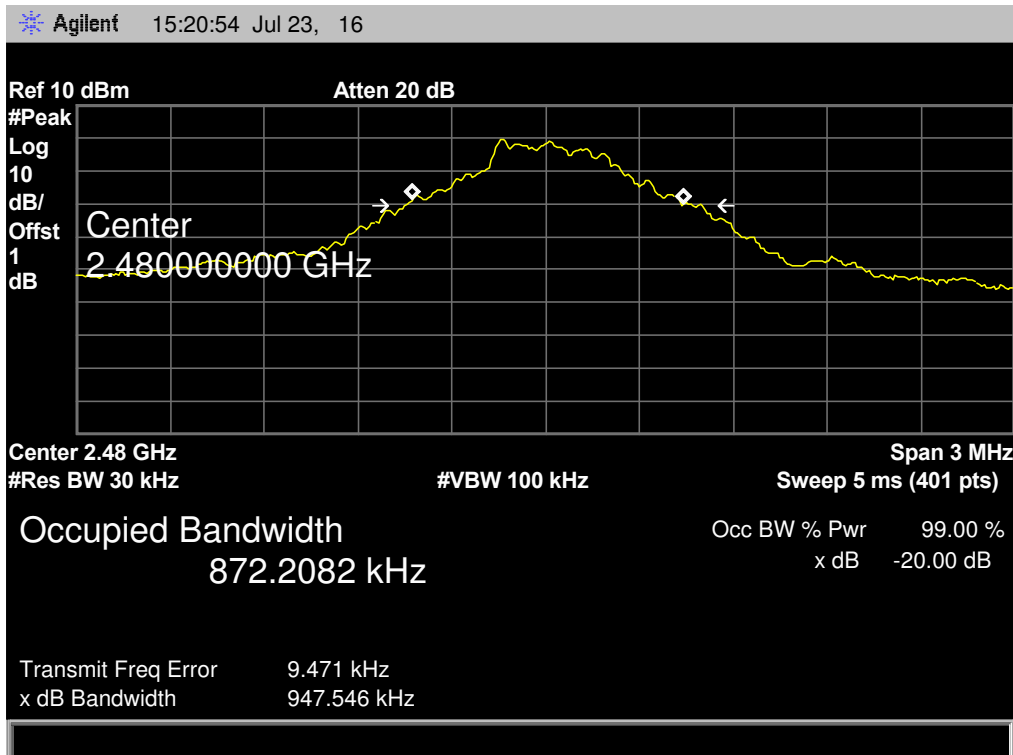

EUT:	Bluetooth Speaker with LED Lights	Model Name :	RM89627
Temperature:	25 °C	Relative Humidity:	55%
Test Voltage:	DC 3.7V		
Test Mode:	TX Mode ($\pi/4$ -DQPSK)		
Channel frequency (MHz)	99% OBW (kHz)	20dB Bandwidth (kHz)	20dB Bandwidth *2/3 (kHz)
2402	1190.20	1271.00	847.33
2441	1194.20	1277.00	851.33
2480	1184.50	1260.00	840.00
$\pi/4$-DQPSK TX Mode			
2402 MHz			
<p>Agilent 15:25:06 Jul 23, 16</p> <p>Ref 10 dBm Atten 20 dB</p> <p>#Peak Log 10 dB/Offst 1 dB</p> <p>Center 2.402000000 GHz</p> <p>Center 2.402 GHz #Res BW 30 kHz #VBW 100 kHz Span 3 MHz Sweep 5 ms (401 pts)</p> <p>Occupied Bandwidth 1.1902 MHz Occ BW % Pwr 99.00 % x dB -20.00 dB</p> <p>Transmit Freq Error 3.573 kHz x dB Bandwidth 1.271 MHz</p>			

$\pi/4$ -DQPSK TX Mode

2441 MHz

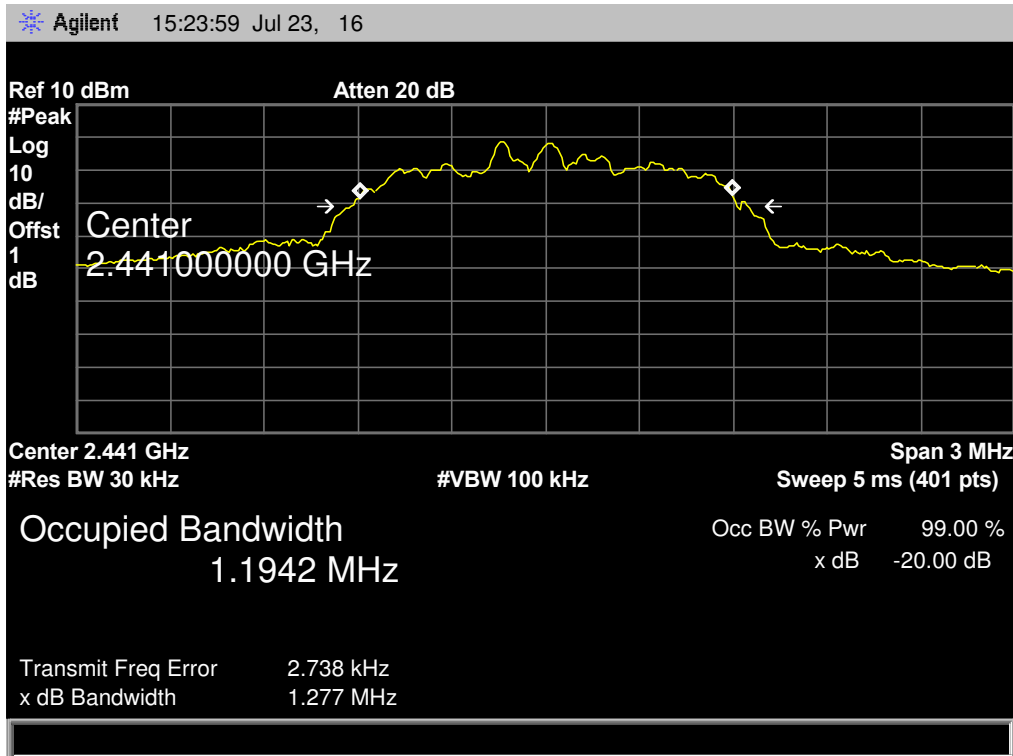

$\pi/4$ -DQPSK TX Mode

2480 MHz

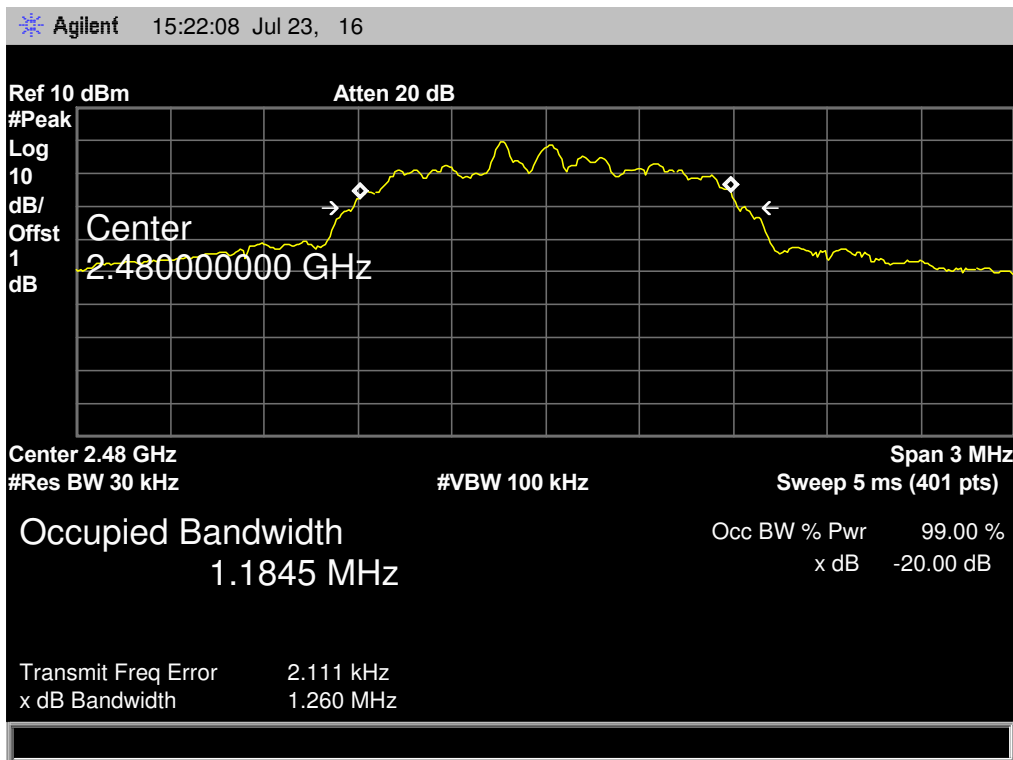

EUT:	Bluetooth Speaker with LED Lights	Model Name :	RM89627															
Temperature:	25 °C	Relative Humidity:	55%															
Test Voltage:	DC 3.7V																	
Test Mode:	Hopping Mode (GFSK)																	
Channel frequency (MHz)	Separation Read Value (kHz)	Separation Limit (kHz)																
2402	997.500	960.812																
2441	997.500	952.424																
2480	997.500	947.546																
GFSK Hopping Mode																		
2402 MHz																		
<p>Agilent 16:44:48 Jul 23, 16</p> <p>Ref 10 dBm Atten 20 dB Mkr1 Δ 997.5 kHz 0.05 dB</p> <p>Peak Log 10 dB/Offst 1 dB</p> <p>Marker Δ 997.500 kHz 0.05 dB</p> <p>Center 2.402 GHz Span 3 MHz</p> <p>#Res BW 30 kHz #VBW 100 kHz Sweep 5 ms (401 pts)</p> <table border="1"> <thead> <tr> <th>Marker</th> <th>Trace</th> <th>Type</th> <th>X Axis</th> <th>Amplitude</th> </tr> </thead> <tbody> <tr> <td>1R</td> <td>(1)</td> <td>Freq</td> <td>2.4018625 GHz</td> <td>-1.645 dBm</td> </tr> <tr> <td>1Δ</td> <td>(1)</td> <td>Freq</td> <td>997.5 kHz</td> <td>0.05 dB</td> </tr> </tbody> </table>				Marker	Trace	Type	X Axis	Amplitude	1R	(1)	Freq	2.4018625 GHz	-1.645 dBm	1Δ	(1)	Freq	997.5 kHz	0.05 dB
Marker	Trace	Type	X Axis	Amplitude														
1R	(1)	Freq	2.4018625 GHz	-1.645 dBm														
1Δ	(1)	Freq	997.5 kHz	0.05 dB														

GFSK Hopping Mode

2441 MHz

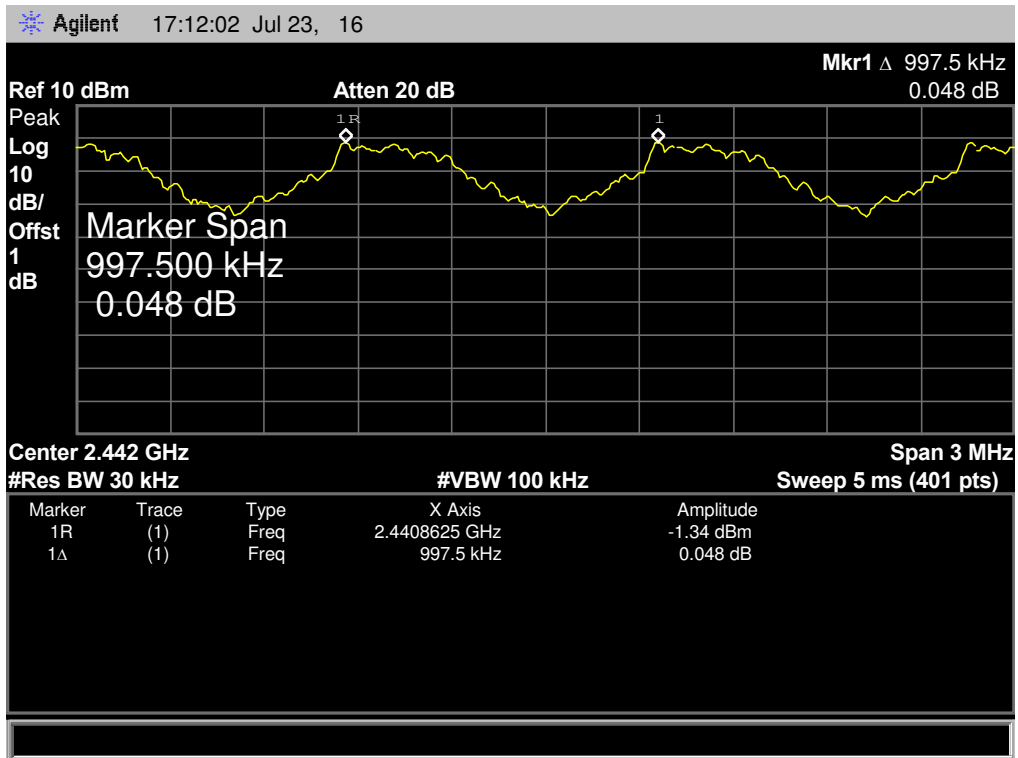

GFSK Hopping Mode

2480 MHz

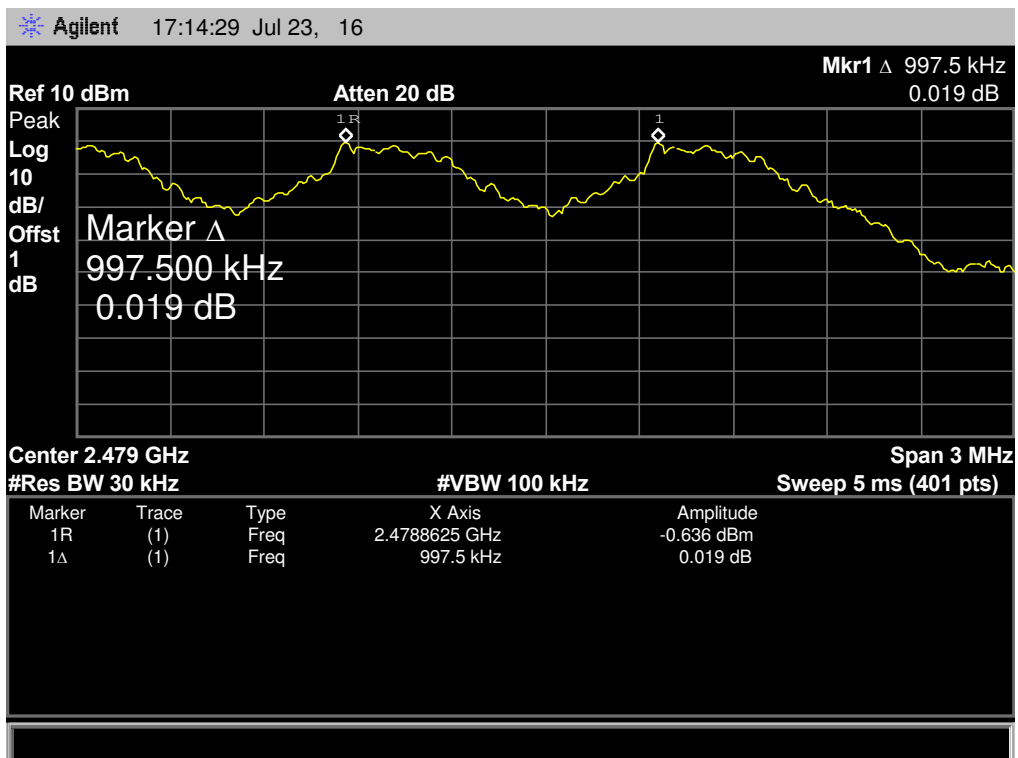

EUT:	Bluetooth Speaker with LED Lights	Model Name :	RM89627															
Temperature:	25 °C	Relative Humidity:	55%															
Test Voltage:	DC 3.7V																	
Test Mode:	Hopping Mode ($\pi/4$ -DQPSK)																	
Channel frequency (MHz)	Separation Read Value (kHz)	Separation Limit (kHz)																
2402	997.500	847.33																
2441	1012.50	851.33																
2480	997.500	840.00																
$\pi/4$-DQPSK Hopping Mode																		
2402 MHz																		
<p>Agilent 17:21:38 Jul 23, 16</p> <p>Ref 10 dBm Atten 20 dB Mkr1 Δ 997.5 kHz -0.001 dB</p> <p>Peak Log 10 dB/Offst 1 dB</p> <p>Marker Δ 997.500 kHz -0.001 dB</p> <p>Center 2.402 GHz Span 3 MHz #Res BW 30 kHz #VBW 100 kHz Sweep 5 ms (401 pts)</p> <table border="1"> <thead> <tr> <th>Marker</th> <th>Trace</th> <th>Type</th> <th>X Axis</th> <th>Amplitude</th> </tr> </thead> <tbody> <tr> <td>1R</td> <td>(1)</td> <td>Freq</td> <td>2.4018625 GHz</td> <td>-1.728 dBm</td> </tr> <tr> <td>1Δ</td> <td>(1)</td> <td>Freq</td> <td>997.5 kHz</td> <td>-0.001 dB</td> </tr> </tbody> </table>				Marker	Trace	Type	X Axis	Amplitude	1R	(1)	Freq	2.4018625 GHz	-1.728 dBm	1 Δ	(1)	Freq	997.5 kHz	-0.001 dB
Marker	Trace	Type	X Axis	Amplitude														
1R	(1)	Freq	2.4018625 GHz	-1.728 dBm														
1 Δ	(1)	Freq	997.5 kHz	-0.001 dB														

$\pi/4$ -DQPSK Hopping Mode

2441 MHz

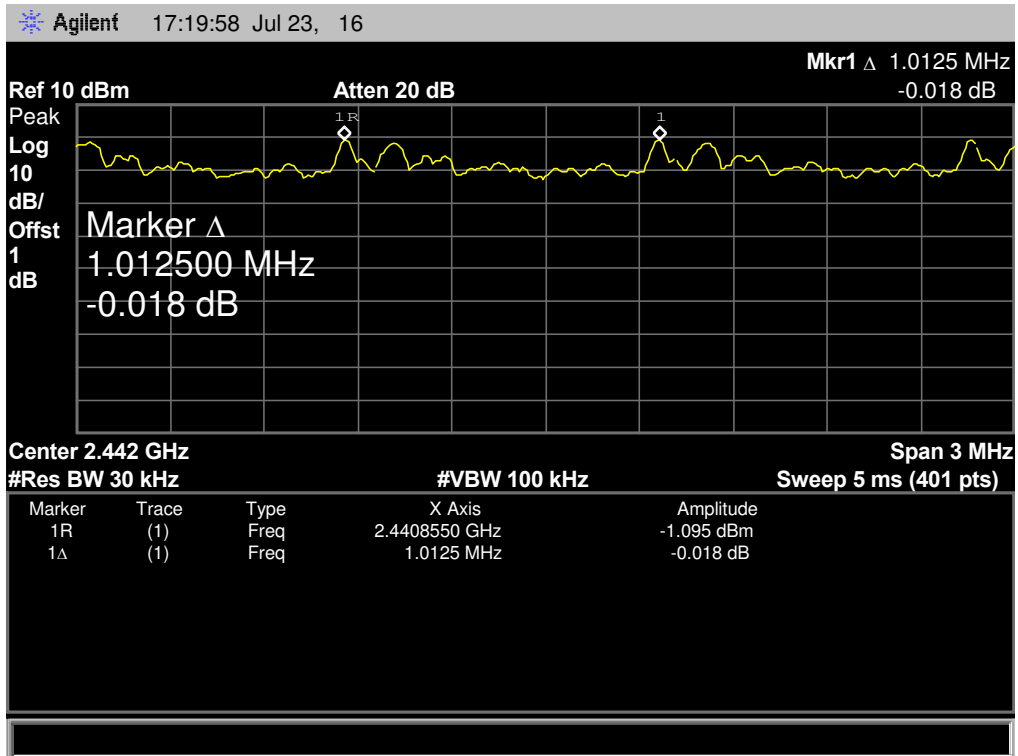

$\pi/4$ -DQPSK Hopping Mode

2480 MHz

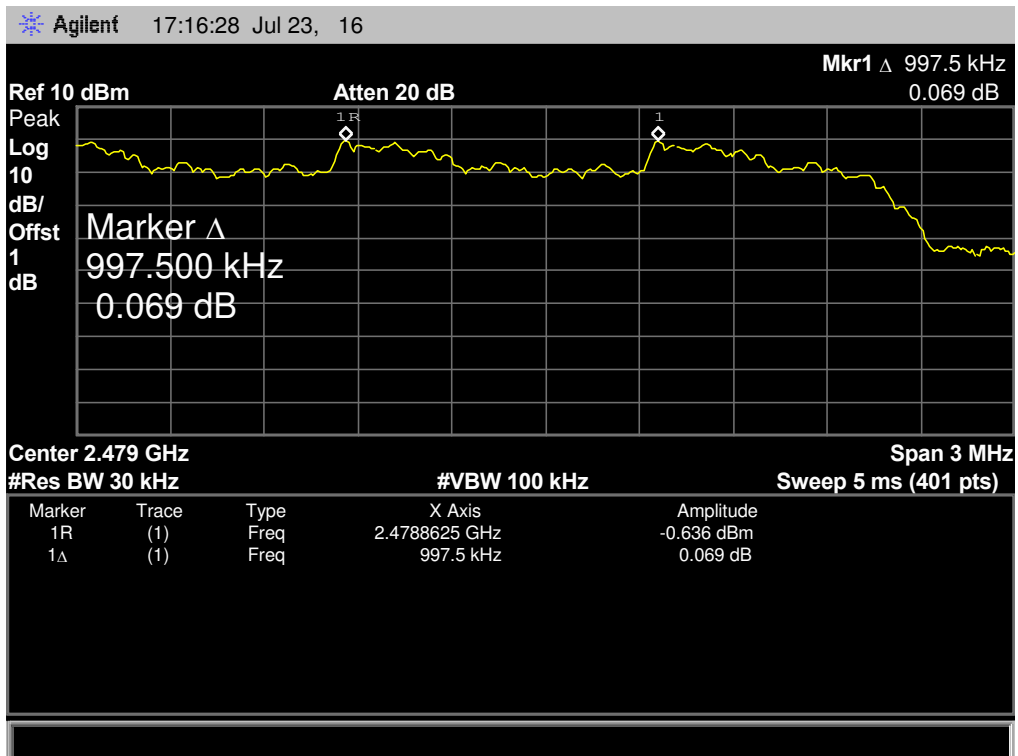

10. Peak Output Power Test

10.1 Test Standard and Limit

10.1.1 Test Standard

FCC Part 15.247 (b) (1)

10.1.2 Test Limit

Test Item	Limit	Frequency Range(MHz)
Peak Output Power	Hopping Channels>75 Power<1W(30dBm) Other <125 mW(21dBm)	2400~2483.5

10.2 Test Setup

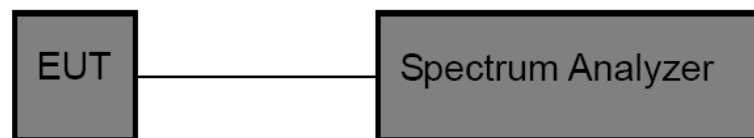

10.3 Test Procedure

- (1) The EUT was directly connected to the spectrum analyzer and antenna output port as show in the block diagram above.
- (2) Spectrum Setting:
Peak Detector: RBW=1 MHz, VBW=3 MHz for bandwidth less than 1MHz.
RBW=3 MHz, VBW=3 MHz for bandwidth more than 1MHz.

10.4 EUT Operating Condition

The EUT was set to continuously transmitting in the max power during the test.

10.5 Test Data

EUT:	Bluetooth Speaker with LED Lights	Model Name :	RM89627
Temperature:	25 °C	Relative Humidity:	55%
Test Voltage:	DC 3.7V		
Test Mode:	TX Mode (GFSK)		
Channel frequency (MHz)	Test Result (dBm)	Limit (dBm)	
2402	-0.138	30	
2441	0.468		
2480	1.118		

GFSK TX Mode

2402 MHz

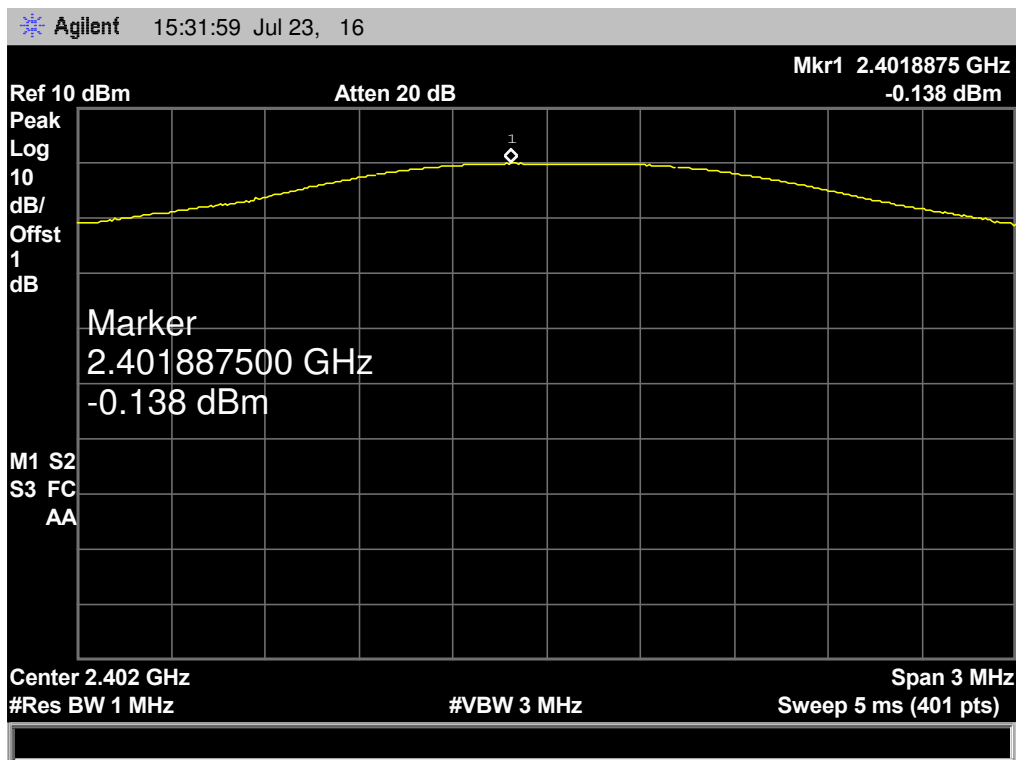

GFSK TX Mode

2441 MHz

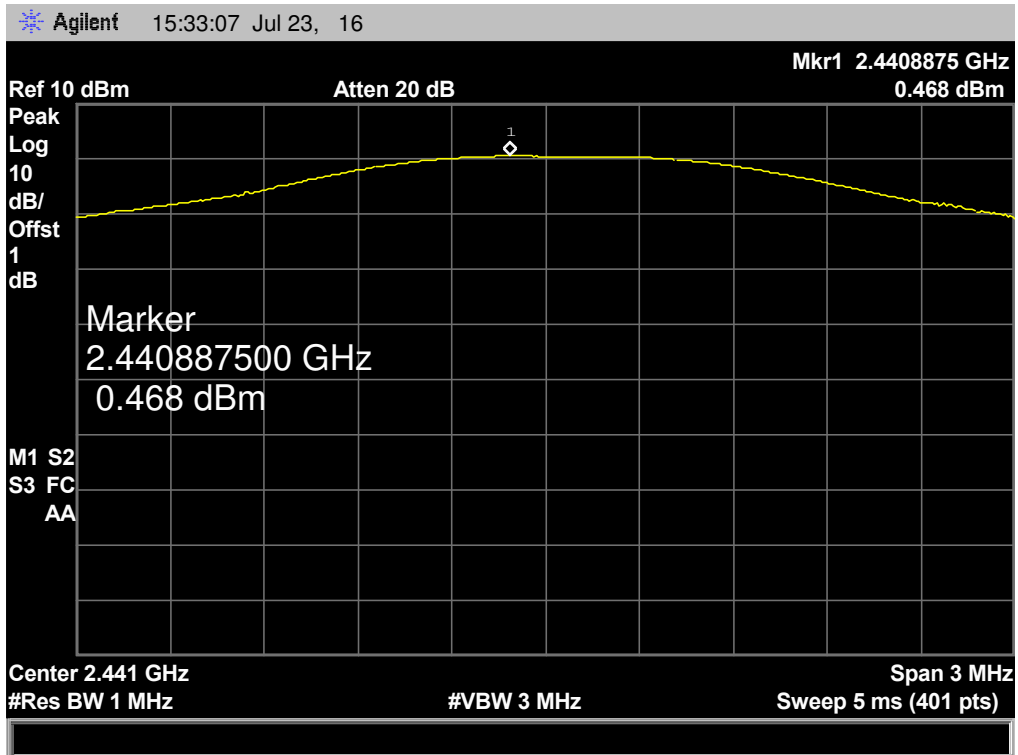

GFSK TX Mode

2480 MHz

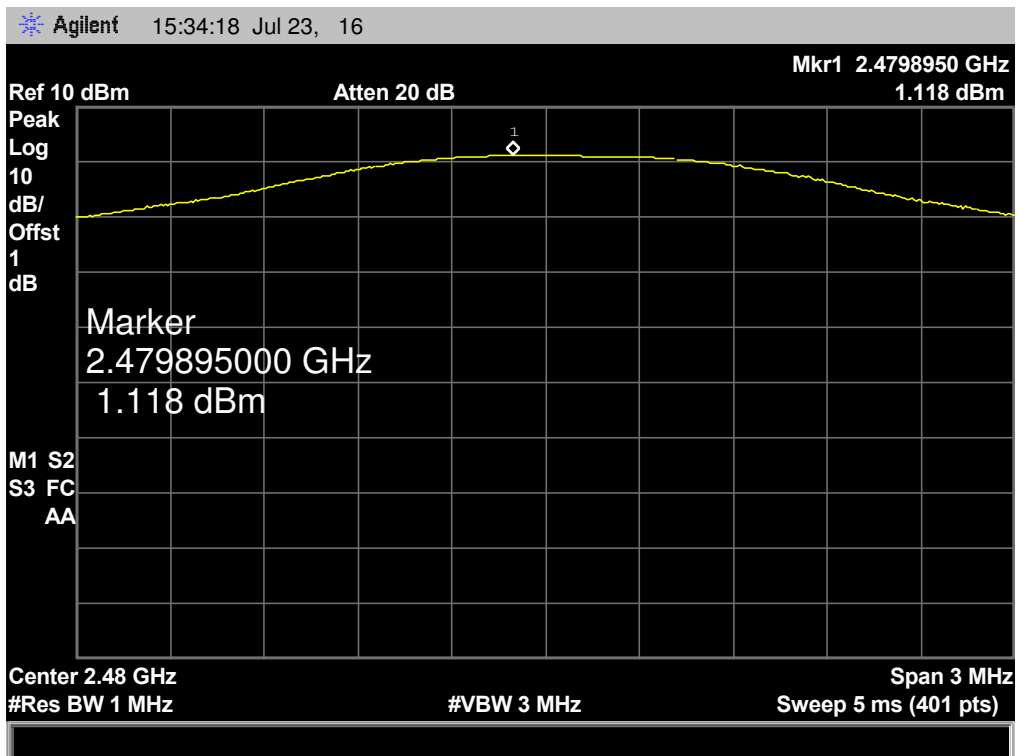

EUT:	Bluetooth Speaker with LED Lights	Model Name :	RM89627
Temperature:	25 °C	Relative Humidity:	55%
Test Voltage:	DC 3.7V		
Test Mode:	TX Mode (π /4-DQPSK)		
Channel frequency (MHz)	Test Result (dBm)	Limit (dBm)	
2402	0.929	21	
2441	1.604		
2480	2.256		

π /4-DQPSK TX Mode

2402 MHz

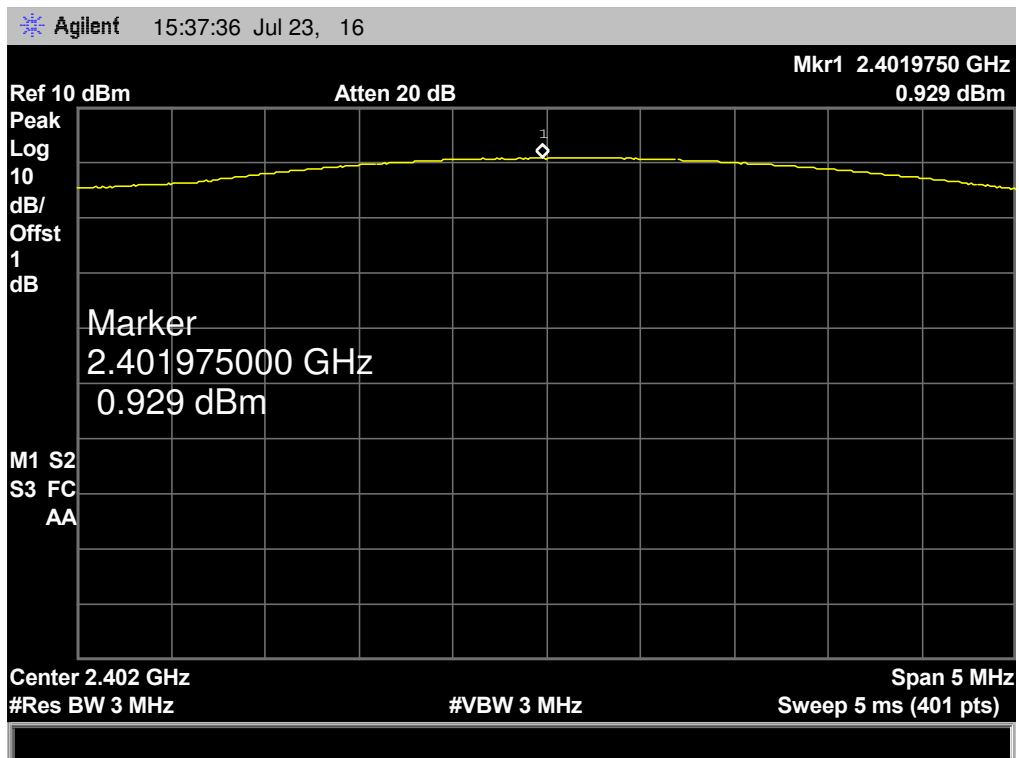

$\pi/4$ -DQPSK TX Mode

2441 MHz

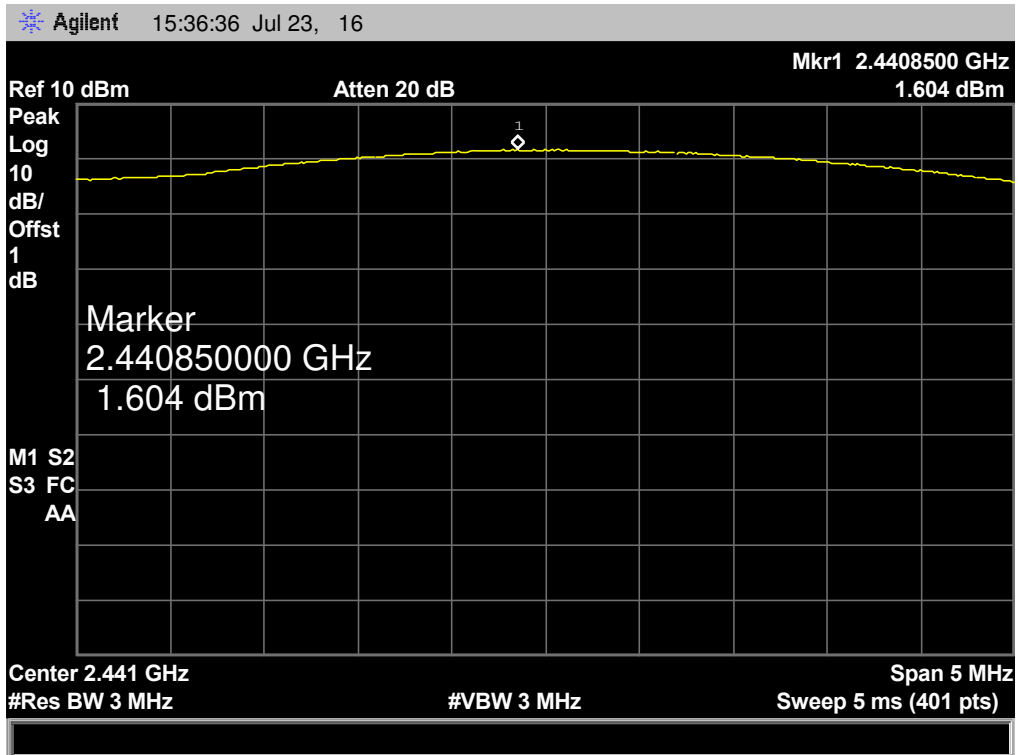

$\pi/4$ -DQPSK TX Mode

2480 MHz

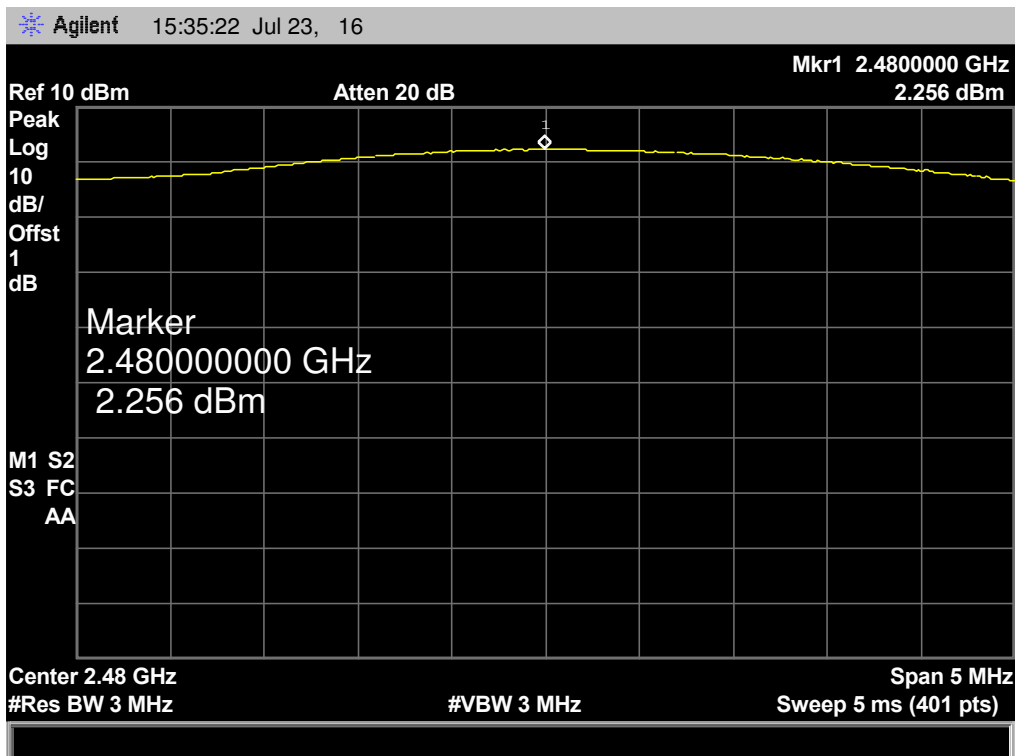

11. Antenna Requirement

11.1 Standard Requirement

11.1.1 Standard

FCC Part 15.203

11.1.2 Requirement

An intentional radiator shall be designed to ensure that no antenna other than that furnished by the responsible party shall be used with the device. The use of a permanently attached antenna or of an antenna that uses a unique coupling to the intentional radiator shall be considered sufficient to comply with the provisions of this Section. The manufacturer may design the unit so that a broken antenna can be replaced by the user, but the use of a standard antenna jack or electrical connector is prohibited.

11.2 Antenna Connected Construction

The directional gains of the antenna used for transmitting is 0 dBi, and the antenna connector is de-signed with permanent attachment and no consideration of replacement. Please see the EUT photo for details.

The EUT antenna is a PCB antenna. It complies with the standard requirement.

Antenna Type
<input checked="" type="checkbox"/> Permanent attached antenna
<input type="checkbox"/> Unique connector antenna
<input type="checkbox"/> Professional installation antenna

-----End of Report-----