

FCC Radio Test Report

FCC ID: 2ABHA-CSBT

Report No. : TB-FCC138998
Applicant : NINGBO CSTAR IMP&EXP CO., LTD
Equipment Under Test (EUT)
EUT Name : Columniform mini bluetooth speaker
Model No. : CSBT1301
Serial No. : CSBT13001
Brand Name : N/A
Receipt Date : 2013-12-02
Test Date : 2013-12-02 to 2013-12-12
Issue Date : 2013-12-17
Standards : FCC Part 15, Subpart C(15.247)
Test Method : ANSI C63.4:2003
Conclusions : **PASS**

In the configuration tested, the EUT complied with the standards specified above,
The EUT technically complies with the FCC requirements

Test/Witness Engineer : *IVAN SU*

Approved& Authorized : *Ray Li.*

This report details the results of the testing carried out on one sample. The results contained in this test report do not relate to other samples of the same product. The manufacturer should ensure that all products in series production are in conformity with the product sample detailed in the report.

Contents

CONTENTS.....	2
1. GENERAL INFORMATION ABOUT EUT	4
1.1 Client Information.....	4
1.2 General Description of EUT (Equipment Under Test)	4
1.3 Block Diagram Showing the Configuration of System Tested.....	6
1.4 Description of Support Units	6
1.5 Description of Test Mode.....	7
1.6 Description of Test Software Setting	8
1.7 Test Facility.....	9
2. TEST SUMMARY	10
3. CONDUCTED EMISSION TEST	11
3.1 Test Standard and Limit.....	11
3.2 Test Setup.....	11
3.3 Test Procedure.....	11
3.4 Test Equipment Used.....	12
3.5 EUT Operating Mode	12
3.6 Test Data.....	12
4. RADIATED EMISSION TEST	15
4.1 Test Standard and Limit.....	15
4.2 Test Setup.....	16
4.3 Test Procedure.....	17
4.4 EUT Operating Condition	17
4.5 Test Equipment.....	17
5. RESTRICTED BANDS REQUIREMENT	29
5.1 Test Standard and Limit.....	29
5.2 Test Setup.....	29
5.3 Test Procedure.....	29
5.4 EUT Operating Condition	30
5.5 Test Equipment.....	30
6. NUMBER OF HOPPING CHANNEL	37
6.1 Test Standard and Limit.....	37
6.2 Test Setup.....	37
6.3 Test Procedure.....	37
6.4 EUT Operating Condition	37
6.5 Test Equipment.....	37
6.6 Test Data.....	37
7. AVERAGE TIME OF OCCUPANCY.....	40
7.1 Test Standard and Limit.....	40
7.2 Test Setup.....	40
7.3 Test Procedure.....	40

7.4 EUT Operating Condition	40
7.5 Test Equipment	40
7.6 Test Data	41
8. CHANNEL SEPARATION AND BANDWIDTH TEST	45
8.1 Test Standard and Limit	45
8.2 Test Setup	45
8.3 Test Procedure	45
8.4 EUT Operating Condition	45
8.5 Test Equipment	46
8.6 Test Data	46
9. PEAK OUTPUT POWER TEST	54
9.1 Test Standard and Limit	54
9.2 Test Setup	54
9.3 Test Procedure	54
9.4 EUT Operating Condition	54
9.5 Test Equipment	54
9.6 Test Data	54
10. ANTENNA CONDUCTED SPURIOUS EMISSION	59
10.1 Test Standard and Limit	59
10.2 Test Setup	59
10.3 Test Procedure	59
10.4 EUT Operating Condition	60
10.5 Test Equipment	60
10.6 Test Data	60
11. ANTENNA REQUIREMENT	67
11.1 Standard Requirement	67
11.2 Antenna Connected Construction	67
11.2 Result	67

1. General Information About EUT

1.1 Client Information

Applicant : NINGBO CSTAR IMP&EXP CO., LTD
Address : 8 Floor, Hengyuan Building, No.568 Tiantong South Rd, Yinzhou, Ningbo, China
Manufacturer : Shenzhen CSTAR Electronics co., Ltd.
Address : Bada Ind. Park, Heping, FuYong Town, Baoan District, Shenzhen, Guangdong, China

1.2 General Description of EUT (Equipment Under Test)

EUT Name	:	Columniform mini bluetooth speaker
Models No.	:	CSBT1301, CSBT13001
Model Difference	:	The different models are identical in schematic, structure and critical component, the only different is the appearance.
Product Description	:	Operation Frequency: Bluetooth:2402~2480MHz
		Number of Channel: Bluetooth:79Channels <i>see note (2)</i>
		Max Peak Output Power: GFSK: -2.46 dBm Conducted Power
		Antenna Gain: 0 dBi PCB Antenna
		Modulation Type: GFSK 1Mbps(1 Mbps) π /4-DQPSK(2 Mbps) 8-DPSK(3 Mbps)
Power Supply	:	DC Voltage supplied from Host System by USB cable DC power by Li-ion Battery
Power Rating	:	DC 5.0V by USB cable DC 3.7V 400 mAh
Connecting I/O Port(S)	:	Please refer to the User's Manual

Note:

- (1) For a more detailed features description, please refer to the manufacturer's specifications or the User's Manual.
- (2) This Test Report is FCC Part 15.247 for Bluetooth, and test procedure in accordance with Public Notice: DA 00-705.
- (3) Channel List:

Channel	Frequency (MHz)	Channel	Frequency (MHz)	Channel	Frequency (MHz)
00	2402	27	2429	54	2456
01	2403	28	2430	55	2457

02	2404	29	2431	56	2458
03	2405	30	2432	57	2459
04	2406	31	2433	58	2460
05	2407	32	2434	59	2461
06	2408	33	2435	60	2462
07	2409	34	2436	61	2463
08	2410	35	2437	62	2464
09	2411	36	2438	63	2465
10	2412	37	2439	64	2466
11	2413	38	2440	65	2467
12	2414	39	2441	66	2468
13	2415	40	2442	67	2469
14	2416	41	2443	68	2470
15	2417	42	2444	69	2471
16	2418	43	2445	70	2472
17	2419	44	2446	71	2473
18	2420	45	2447	72	2474
19	2421	46	2448	73	2475
20	2422	47	2449	74	2476
21	2423	48	2450	75	2477
22	2424	49	2451	76	2478
23	2425	50	2452	77	2479
24	2426	51	2453	78	2480
25	2427	52	2454		
26	2428	53	2455		

(4) The Antenna information about the equipment is provided by the applicant.

1.3 Block Diagram Showing the Configuration of System Tested

USB Charging and Keeping TX Mode

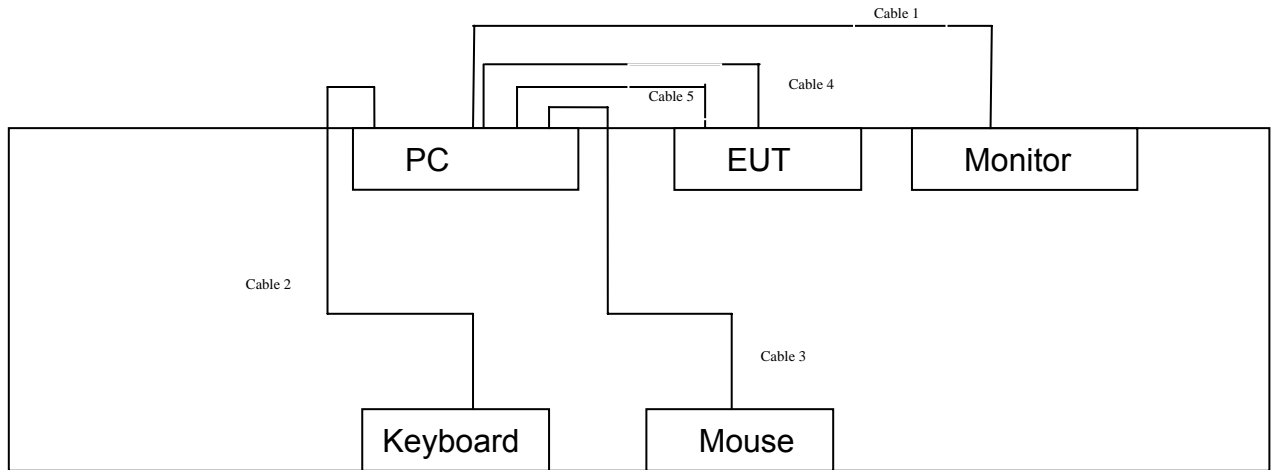

TX Mode

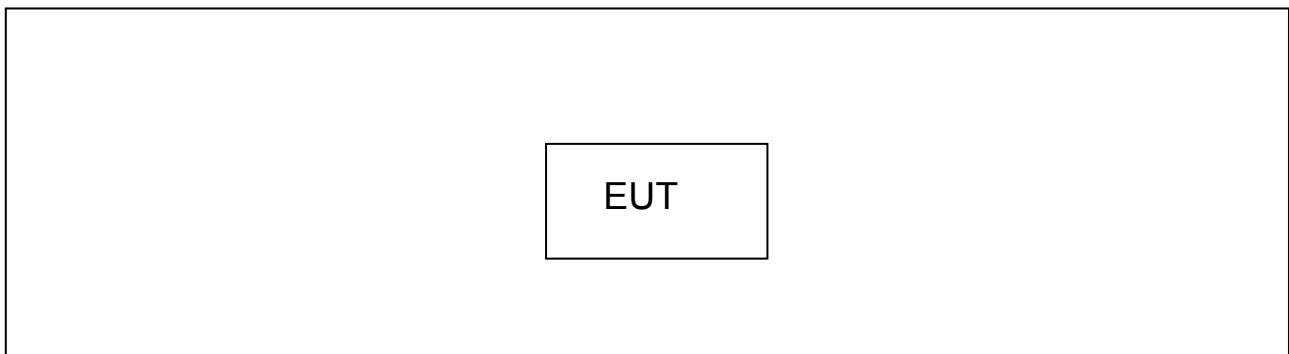

1.4 Description of Support Units

Equipment Information				
Name	Model	FCC ID/DOC	Manufacturer	Used “√”
Printer	HP1505n	DOC	HP	
LCD Monitor	E170Sc	DOC	DELL	√
PC	OPTIPLEX380	DOC	DELL	√
Keyboard	L100	DOC	DELL	√
Mouse	M-UARDEL7	DOC	DELL	√
Cable Information				
Number	Shielded Type	Ferrite Core	Length	Note

Cable 1	YES	YES(2)	1.8M	
Cable 2	YES	NO	1.5M	
Cable 3	YES	NO	1.5M	
Cable 4	NO	NO	1.0M	Accessories
Cable 5	NO	NO	1.0M	Accessories

1.5 Description of Test Mode

To investigate the maximum EMI emission characteristics generates from EUT, the test system was pre-scanning tested base on the consideration of following EUT operation mode or test configuration mode which possible have effect on EMI emission level. Each of these EUT operation mode(s) or test configuration mode(s) mentioned follow was evaluated respectively.

For Conducted Test	
Final Test Mode	Description
Mode 1	TX and Charging Mode

For Radiated Test	
Final Test Mode	Description
Mode 1	TX and Charging Mode
Mode 2	TX Mode(GFSK) Channel 00/39/78
Mode 3	TX Mode($\pi/4$ -DQPSK) Channel 00/39/78
Mode 4	TX Mode(8-DQPSK) Channel 00/39/78
Mode 5	Hopping Mode(GFSK)
Mode 6	Hopping Mode($\pi/4$ -DQPSK)
Mode 7	Hopping Mode(8-DQPSK)

Note:

- (1) For all test, we have verified the construction and function in typical operation. And all the test modes were carried out with the EUT in transmitting operation in maximum power with all kinds of data rate. We have pretested all the test mode above.
According to ANSI C63.4 standards, the measurements are performed at the highest, middle, lowest available channels, and the worst case data rate as follows:
TX Mode: GFSK (1 Mbps)
TX Mode: 8-DPSK (3 Mbps)
- (2) During the testing procedure, the continuously transmitting with the maximum power mode was programmed by the customer.
- (3) The EUT is considered a mobile unit; it was pre-tested on the positioned of each 3 axis, X-plane, Y-plane and Z-plane. The worst case was found positioned on X-plane as the normal use. Therefore only the test data of this X-plane was used for radiated emission

measurement test.

1.6 Description of Test Software Setting

During testing channel & Power controlling software provided by the customer was used to control the operating channel as well as the output power level. The RF output power selection is for the setting of RF output power expected by the customer and is going to be fixed on the firmware of the final end product power parameters of Bluetooth mode.

Test Software Version	Test Program: rdahost.exe		
Frequency	2402 MHz	2441MHz	2480 MHz
1 Mbps	DEF	DEF	DEF
3 Mbps	DEF	DEF	DEF

1.7 Test Facility

The tests were performed at:

Shenzhen Certification Technology Service Co., Ltd

2F, Building B, East Area of Nanchang Second Industrial Zone, Gushu 2nd Road, Bao'an District, Shenzhen, 518126, China

Tel: 86-755-86375552 Fax: 86-755-26736857

At the time of testing, the Laboratory is accredited. It is listed in the United States of American Federal Communications Commission (FCC), and the registration number is 197647.

The test report was fulfilled by Shenzhen Toby Technology Co., Ltd. Shenzhen Toby Technology Co., Ltd. is assumed full responsibility for the accuracy and completeness of these measurements results.

2. Test Summary

FCC Part 15 Subpart C(15.247)			
Standard Section	Test Item	Judgment	Remark
15.203	Antenna Requirement	PASS	N/A
15.207	Conducted Emission	PASS	N/A
15.205	Restricted Bands	PASS	N/A
15.247(a)(1)	Hopping Channel Separation	PASS	N/A
15.247(a)(1)	Dwell Time	PASS	N/A
15.247(b)(1)	Peak Output Power	PASS	N/A
15.247(b)(1)	Number of Hopping Frequency	PASS	N/A
15.247(c)	Radiated Spurious Emission	PASS	N/A
15.247(c)	Antenna Conducted Spurious Emission	PASS	N/A
15.247(a)	20dB Bandwidth	PASS	N/A
Note: N/A is an abbreviation for Not Applicable.			

3. Conducted Emission Test

3.1 Test Standard and Limit

3.1.1 Test Standard
FCC Part 15.207

3.1.2 Test Limit

Conducted Emission Test Limit

Frequency	Maximum RF Line Voltage (dB μ V)	
	Quasi-peak Level	Average Level
150kHz~500kHz	66 ~ 56 *	56 ~ 46 *
500kHz~5MHz	56	46
5MHz~30MHz	60	50

Notes:

- (1) *Decreasing linearly with logarithm of the frequency.
- (2) The lower limit shall apply at the transition frequencies.
- (3) The limit decrease in line with the logarithm of the frequency in the range of 0.15 to 0.50MHz.

3.2 Test Setup

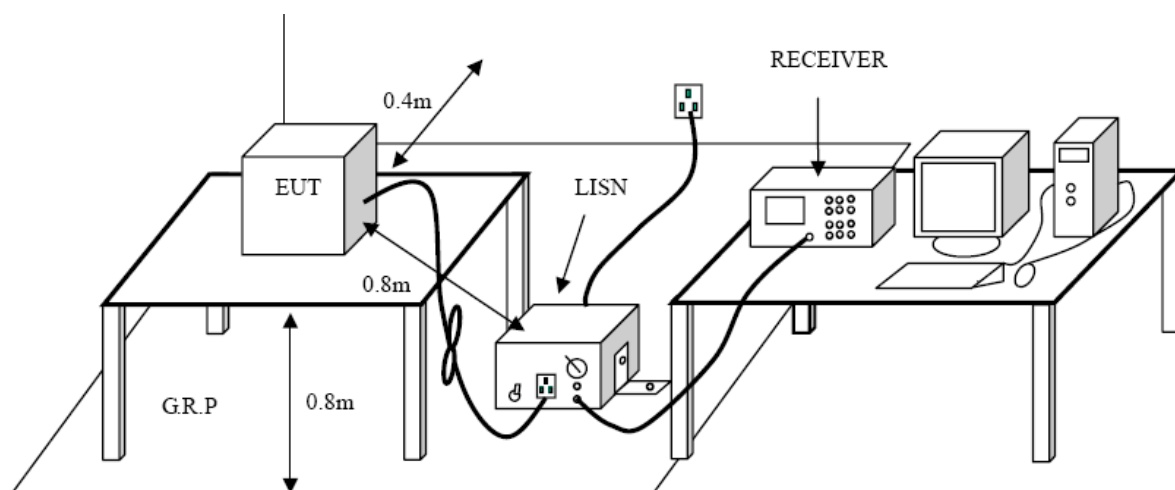

3.3 Test Procedure

The EUT was placed 0.8 meters from the horizontal ground plane with EUT being connected to the power mains through a line impedance stabilization network (LISN). All other support equipments powered from additional LISN(s). The LISN provide 50 Ohm/ 50uH of coupling impedance for the measuring instrument.

Interconnecting cables that hang closer than 40 cm to the ground plane shall be folded back and forth in the center forming a bundle 30 to 40 cm long.

I/O cables that are not connected to a peripheral shall be bundled in the center. The end of the cable may be terminated, if required, using the correct terminating impedance. The overall length shall not exceed 1 m.

LISN at least 80 cm from nearest part of EUT chassis

The bandwidth of EMI test receiver is set at 9kHz, and the test frequency band is from 0.15MHz to 30MHz.

3.4 Test Equipment Used

Description	Manufacturer	Model No.	Serial No.	Cal. Date	Cal. Date
EMI Test Receiver	ROHDE& SCHWARZ	ESCI	100321	2013-08-10	2014-08-09
50ΩCoaxial Switch	Anritsu	MP59B	X10321	2013-08-10	2014-08-09
L.I.S.N	Rohde & Schwarz	ENV216	101131	2013-08-10	2014-08-09
L.I.S.N	SCHWARZBECK	NNBL 8226-2	8226-2/164	2013-08-10	2014-08-09

3.5 EUT Operating Mode

Please refer to the description of test mode.

3.6 Test Data

Please see the next page.

E.U.T :	Columniform mini bluetooth speaker	Model Name :	CSBT1301
Temperature :	25°C	Relative Humidity :	52 %
Terminal	Line		
Test Voltage :	AC 120 V / 60Hz		
Test Mode :	Charging Mode+ BT Mode		

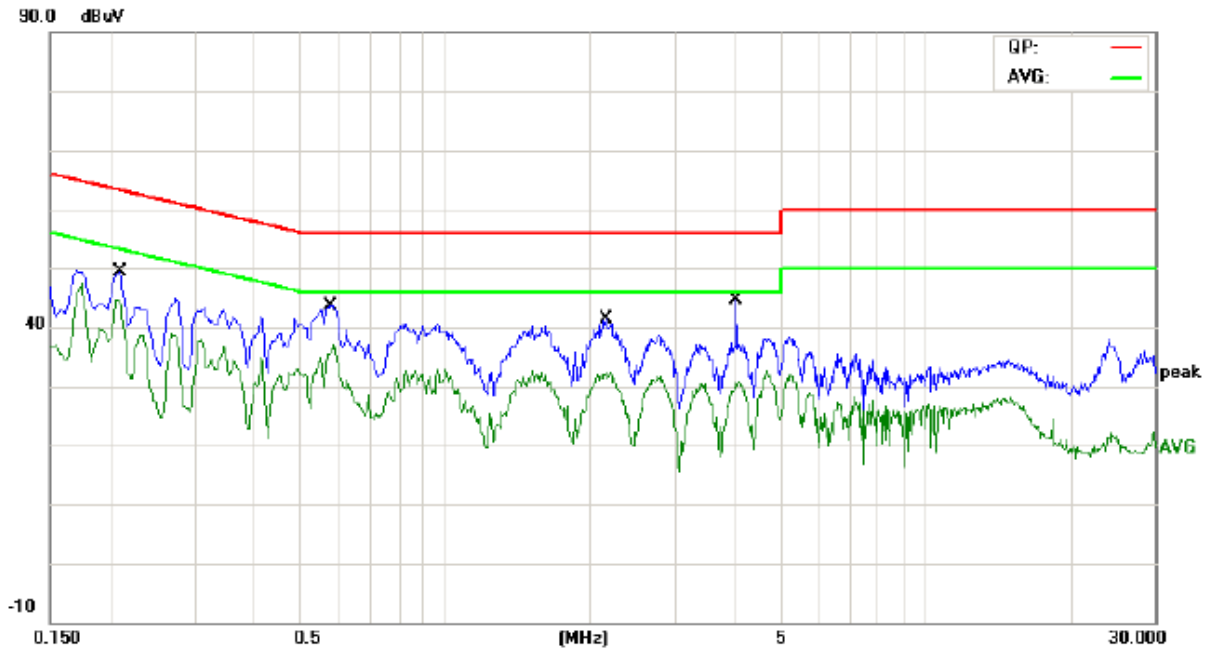

No.	Mk.	Freq.	Reading Level	Correct Factor	Measurement	Limit	Over	Detector	Comment
		MHz	dBuV	dB	dBuV	dBuV	dB		
1		0.2100	37.32	10.02	47.34	63.20	-15.86	QP	
2	*	0.2100	33.79	10.02	43.81	53.20	-9.39	AVG	
3		0.5780	32.93	10.06	42.99	56.00	-13.01	QP	
4		0.5780	25.54	10.06	35.60	46.00	-10.40	AVG	
5		2.1660	25.97	10.05	36.02	56.00	-19.98	QP	
6		2.1660	22.06	10.05	32.11	46.00	-13.89	AVG	
7		4.0460	22.66	9.99	32.65	56.00	-23.35	QP	
8		4.0460	19.29	9.99	29.28	46.00	-16.72	AVG	

E.U.T :	Columniform mini bluetooth speaker	Model Name :	CSBT1301
Temperature :	25°C	Relative Humidity :	52 %
Terminal	Neutral		
Test Voltage :	AC 120 V / 60Hz		
Test Mode :	Charging Mode+ BT Mode		

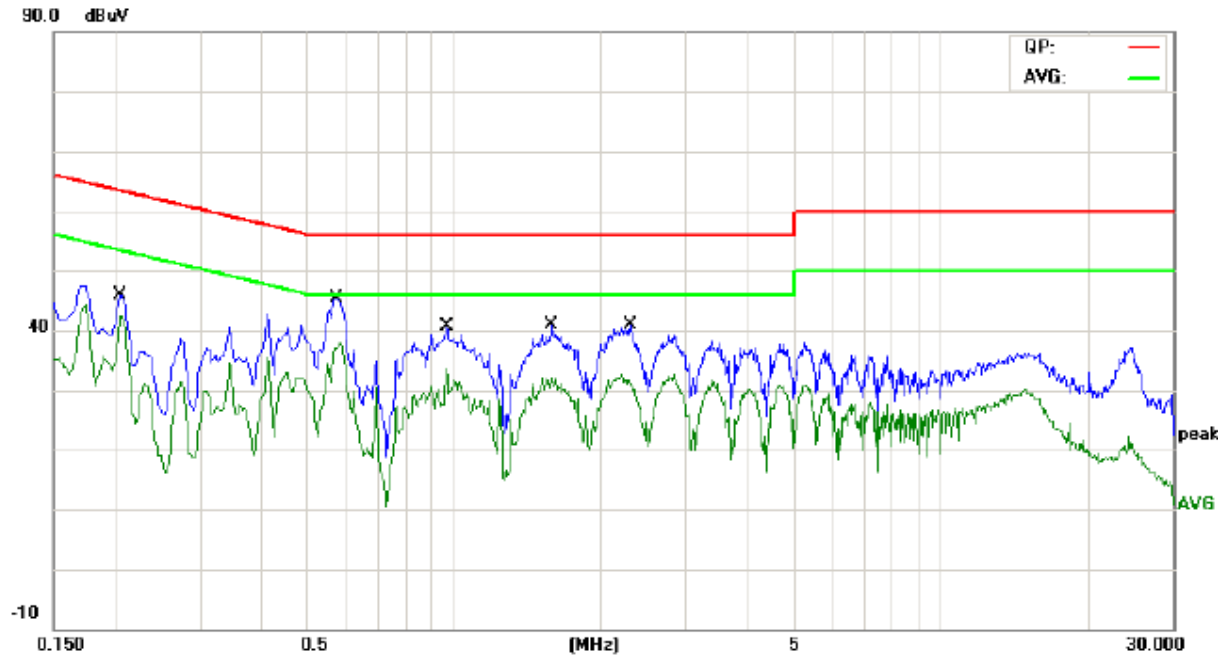

No.	Mk.	Freq. MHz	Reading Level dBuV	Correct Factor dB	Measure- ment dBuV	Limit dBuV	Over dB	Detector	Comment
1		0.2060	34.64	10.02	44.66	63.36	-18.70	QP	
2		0.2060	32.56	10.02	42.58	53.36	-10.78	AVG	
3		0.5740	34.49	10.06	44.55	56.00	-11.45	QP	
4	*	0.5740	27.12	10.06	37.18	46.00	-8.82	AVG	
5		0.9660	28.80	10.07	38.87	56.00	-17.13	QP	
6		0.9660	23.11	10.07	33.18	46.00	-12.82	AVG	
7		1.5859	27.15	10.06	37.21	56.00	-18.79	QP	
8		1.5859	22.16	10.06	32.22	46.00	-13.78	AVG	
9		2.2980	25.21	10.05	35.26	56.00	-20.74	QP	
10		2.2980	20.94	10.05	30.99	46.00	-15.01	AVG	

4. Radiated Emission Test

4.1 Test Standard and Limit

4.1.1 Test Standard

FCC Part 15.209

4.1.2 Test Limit

Radiated Emission Limit (9kHz~1000MHz)

Frequency (MHz)	Field Strength (microvolt/meter)	Measurement Distance (meters)
0.009~0.490	2400/F(KHz)	300
0.490~1.705	24000/F(KHz)	30
1.705~30.0	30	30
30~88	100	3
88~216	150	3
216~960	200	3
Above 960	500	3

Radiated Emission Limit (Above 1000MHz)

Frequency (MHz)	Class B (dBuV/m)(at 3m)	
	Peak	Average
Above 1000	74	54

Note:

- (1) The tighter limit applies at the band edges.
- (2) Emission Level(dBuV/m)=20log Emission Level(uV/m)

4.2 Test Setup

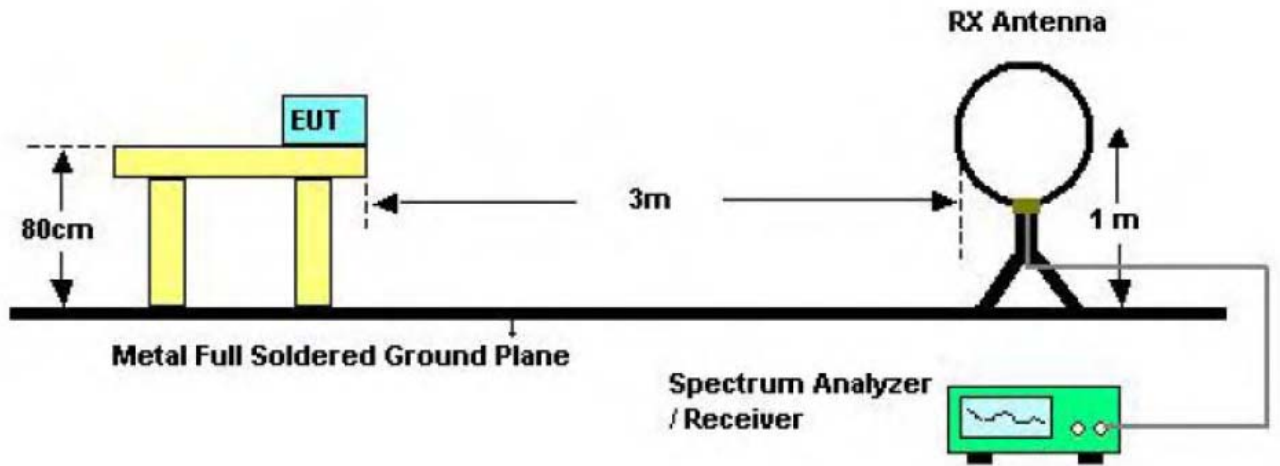

Bellow 30MHz Test Setup

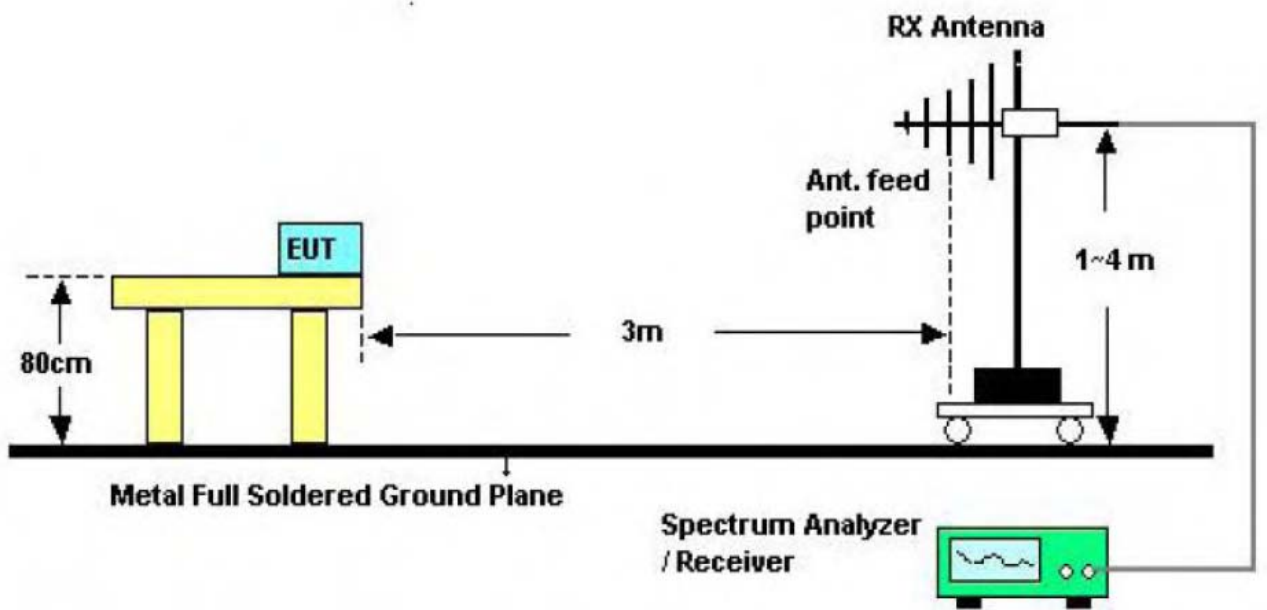

Bellow 1000MHz Test Setup

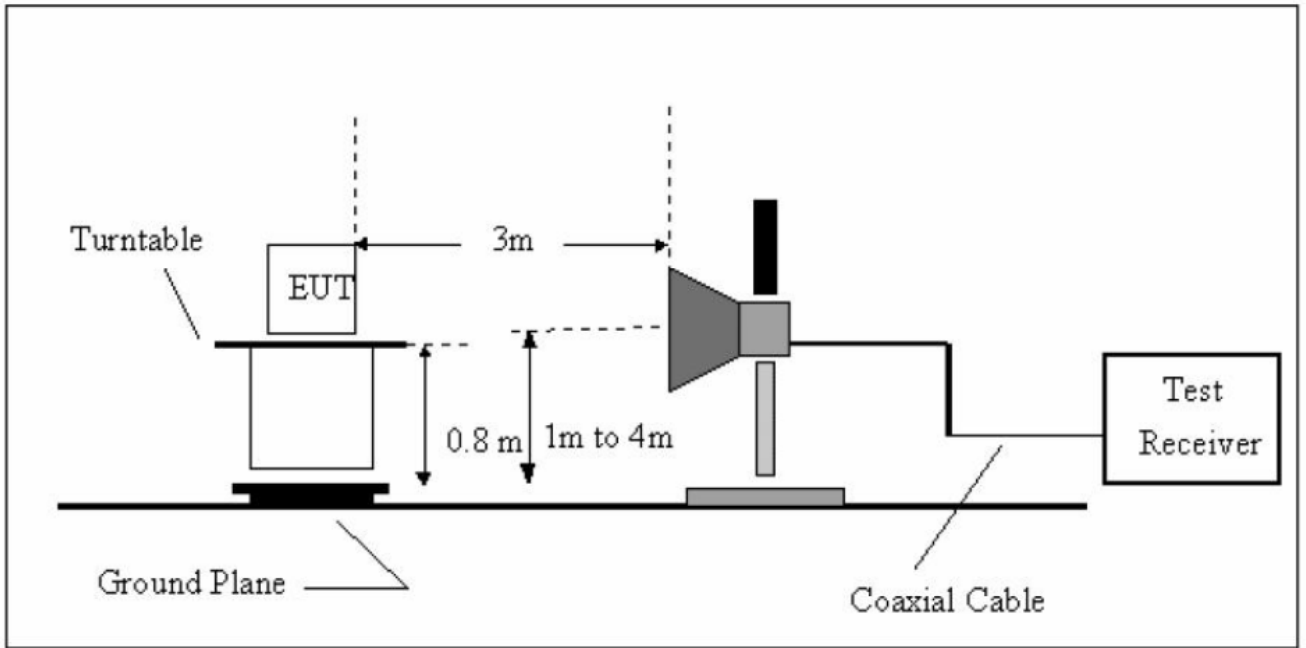

Above 1GHz Test Setup

4.3 Test Procedure

- (1) The measuring distance of 3m shall be used for measurements at frequency up to 1GHz and above 1 GHz. The EUT was placed on a rotating 0.8m high above ground, the table was rotated 360 degrees to determine the position of the highest radiation.
- (2) The Test antenna shall vary between 1m and 4m, Both Horizontal and Vertical antenna are set to make measurement.
- (3) The initial step in collecting conducted emission data is a spectrum analyzer peak detector mode pre-scanning the measurement frequency range. Significant peaks are then marked and then Quasi Peak detector mode re-measured.
- (4) If the Peak Mode measured value compliance with and lower than Quasi Peak Mode Limit Bellow 1 GHz, the EUT shall be deemed to meet QP Limits and then no additional QP Mode measurement performed. But the Peak Value and average value both need to comply with applicable limit above 1 GHz.
- (5) For the actual test configuration, please see the test setup photo.

4.4 EUT Operating Condition

The Equipment Under Test was set to Continual Transmitting in maximum power in TX mode.

4.5 Test Equipment

Description	Manufacturer	Model No.	Serial No.	Cal. Date	Cal. Due Date
Spectrum Analyzer	ROHDE& SCHWARZ	FSP30	DE25181	2012-12-31	2013-12-30

Spectrum Analyzer	Agilent	E4407B	MY49510055	2012-12-31	2013-12-30
EMI Test Receiver	ROHDE& SCHWARZ	ESCI	101165	2012-12-31	2013-12-30
Bilog Antenna	SCHWARZBECK	VULB9168	9168-438	2013-02-12	2014-02-11
Horn Antenna	SCHWARZBECK	BBHA 9120D	BBHA9120D	2013-02-12	2014-02-11
Horn Antenna	SCHWARZBECK	BBHA 9170	BBHA9170D	2013-02-12	2014-02-11
Active Loop Antenna	Beijing Daze	ZN30900A	SEL0097	2013-02-12	2014-02-11
Pre-amplifier	SCHWARZBECK	BBV9743	9743-019	2013-10-28	2014-10-27
Pre-amplifier	Quietek	AP-180C	CHM-0602012	2013-10-28	2014-10-27

4.6 Test Data

Remark: During testing above 1GHz the measuring instrument use RBW=1 MHz and VBW=3 MHz with Peak Detector for Peak Values, and use RBW=1 MHz and VBW=10 Hz with Peak Detector for Average Values.

Test data please refer the following pages.

Operation Mode: USB Charging Mode Test Date : Dec. 05, 2013
 Frequency Range: 30~1000MHz Temperature : 28 °C
 Measured Distance: 3m Humidity : 65 %
 Ant. Pol. Horizontal
 Test Voltage: DC 5V

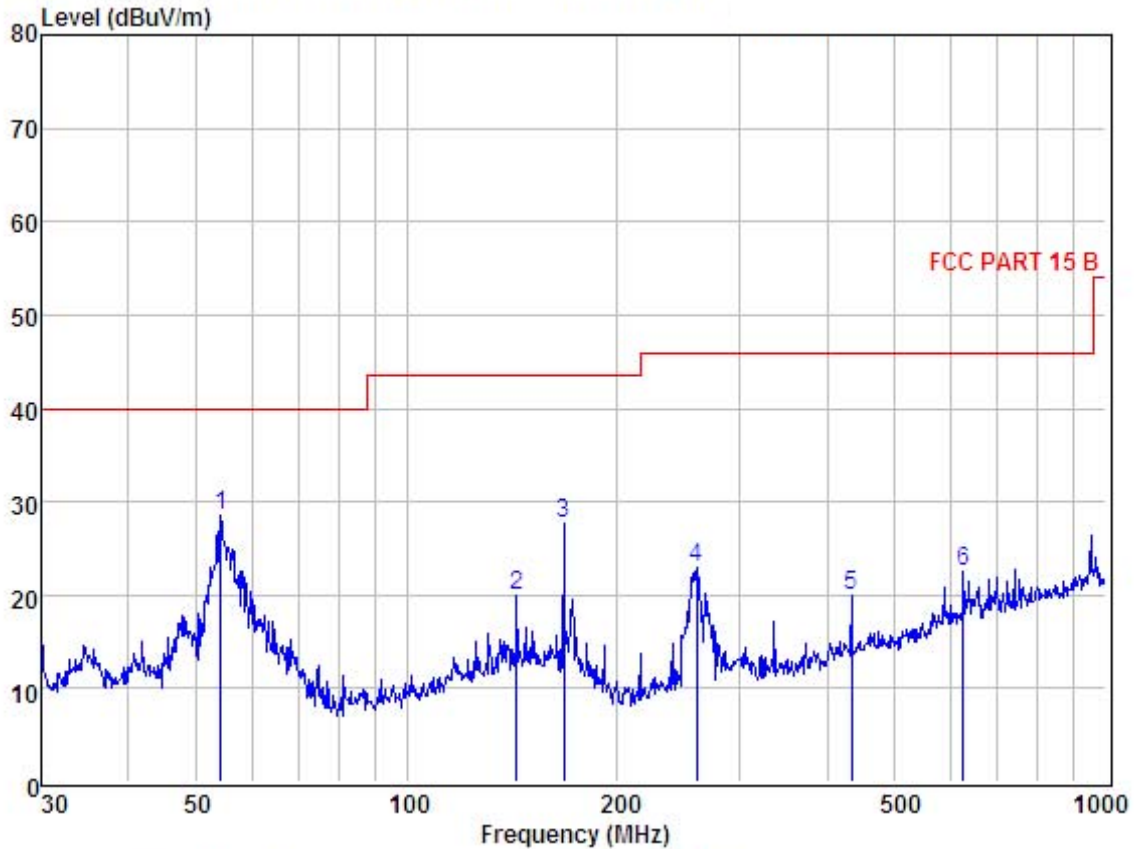

Item	Freq MHz	Read Level dBuV	Antenna Factor dB	Preamp Factor dB	Cable Loss dB	Level dBuV	Limit dBuV	Margin dBuV	Remark
1	54.26	42.93	13.22	27.84	0.21	28.52	40.00	-11.48	Peak
2	143.83	32.71	13.77	26.90	0.38	19.96	43.50	-23.54	Peak
3	167.82	40.79	13.37	26.92	0.42	27.66	43.50	-15.84	Peak
4	260.14	37.79	11.77	27.12	0.57	23.01	46.00	-22.99	Peak
5	432.55	31.03	15.53	27.46	0.74	19.84	46.00	-26.16	Peak
6	625.08	30.43	18.80	27.82	1.11	22.52	46.00	-23.48	Peak

Remark: Level = Read Level + Antenna Factor - Preamp Factor + Cable Loss

Operation Mode: USB Charging Mode Test Date : Dec. 05, 2013
 Frequency Range: 30~1000MHz Temperature : 28 °C
 Measured Distance: 3m Humidity : 65 %
 Ant. Pol. Vertical
 Test Voltage: DC 5V

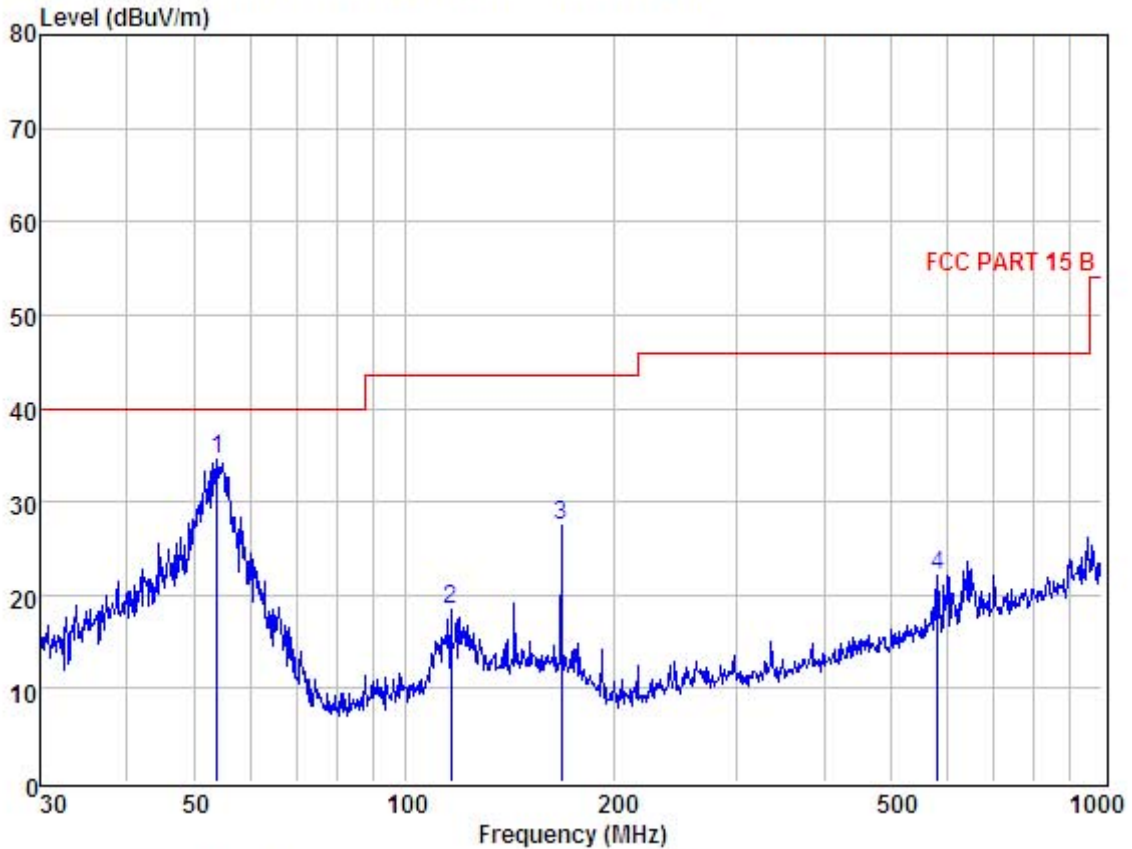

Item	Freq MHz	Read Level dBuV	Antenna Factor dB	Preamp Factor dB	Cable Loss dB	Level dBuV	Limit dBuV	Margin dBuV	Remark
1	53.88	48.89	13.22	27.84	0.21	34.48	40.00	-5.52	Peak
2	116.54	33.08	11.87	26.87	0.37	18.45	43.50	-25.05	Peak
3	167.82	40.61	13.37	26.92	0.42	27.48	43.50	-16.02	Peak
4	580.70	30.96	17.93	27.78	0.90	22.01	46.00	-23.99	Peak

Remark: Level = Read Level + Antenna Factor - Preamp Factor + Cable Loss

Operation Mode: BT TX Mode Test Date : Dec. 05, 2013
 Frequency Range: 30~1000MHz Temperature : 28 °C
 Measured Distance: 3m Humidity : 65 %
 Ant. Pol. Horizontal
 Test Voltage: DC 3.7V

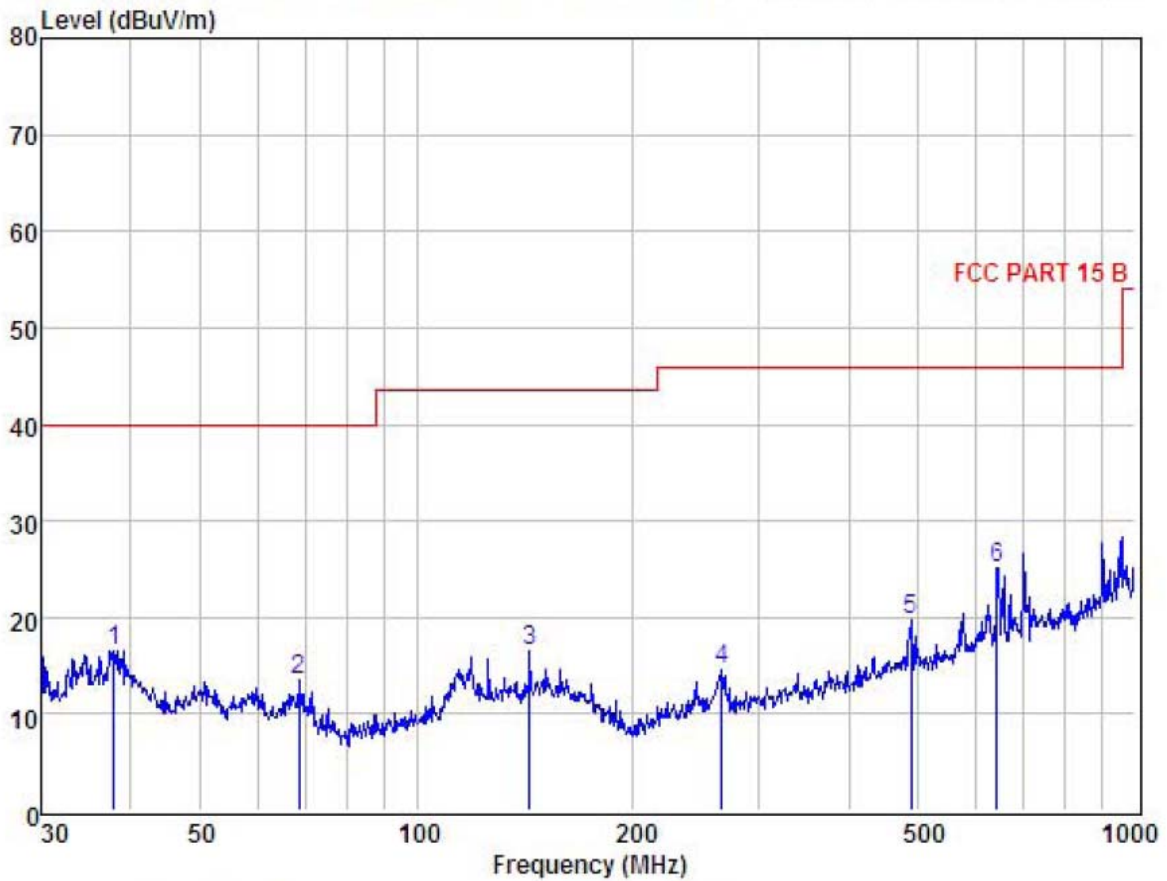

Item	Freq MHz	Read Level dBUV	Antenna Factor dB	Preamp Factor dB	Cable Loss dB	Level dBUV	Limit dBUV	Margin dBUV	Remark
1	37.94	30.53	13.73	27.73	0.08	16.61	40.00	-23.39	Peak
2	68.63	29.08	10.82	26.76	0.30	13.44	40.00	-26.56	Peak
3	143.83	29.21	13.77	26.90	0.38	16.46	43.50	-27.04	Peak
4	265.68	29.23	11.96	27.13	0.61	14.67	46.00	-31.33	Peak
5	487.32	29.92	16.35	27.58	0.94	19.63	46.00	-26.37	Peak
6	642.86	32.63	19.02	27.81	1.24	25.08	46.00	-20.92	Peak

Remark: Level = Read Level + Antenna Factor - Preamp Factor + Cable Loss

Operation Mode:	BT TX Mode	Test Date :	Dec. 05, 2013
Frequency Range:	30~1000MHz	Temperature :	25 °C
Measured Distance:	3m	Humidity :	65 %
Ant. Pol.	Vertical		
Test Voltage:	DC 3.7V		

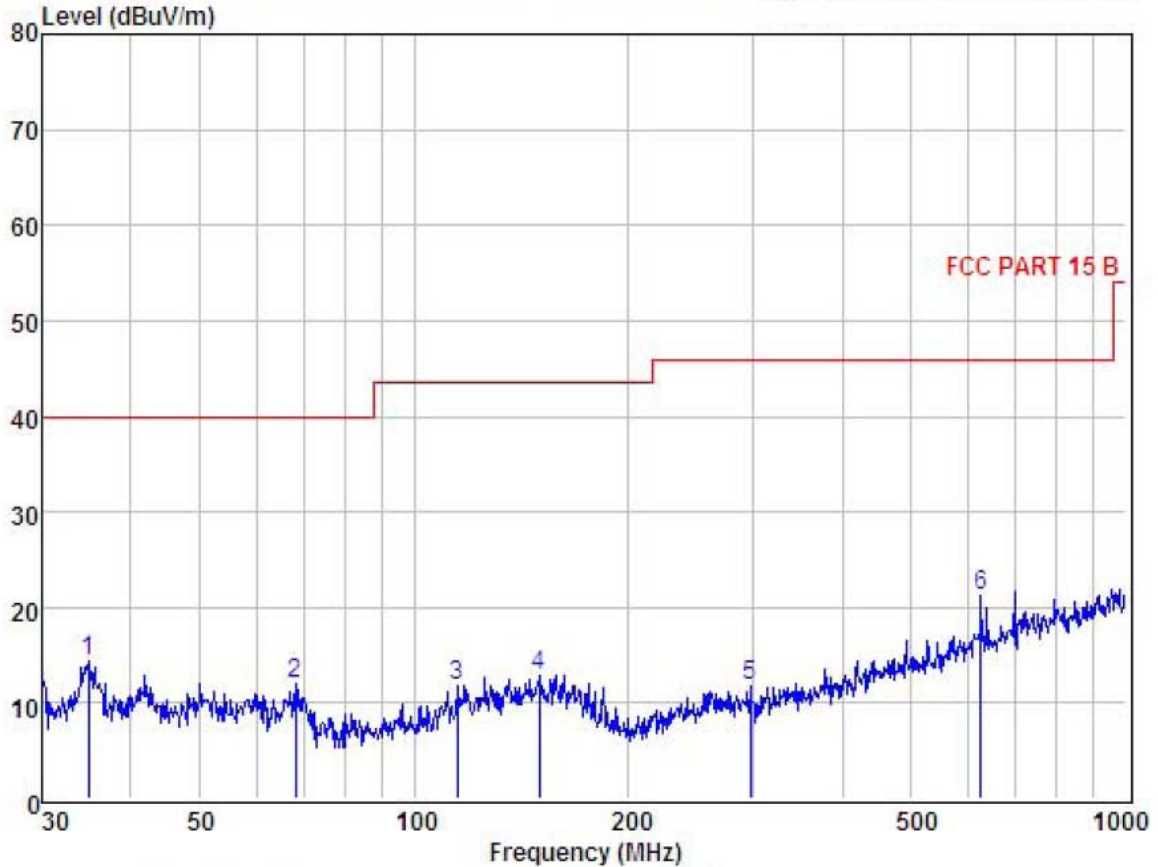

Item	Freq MHz	Read Level dBuV	Antenna Factor dB	Preamp Factor dB	Cable Loss dB	Level dBuV	Limit dBuV	Margin dBuV	Remark
1	34.88	28.44	13.39	27.66	0.13	14.30	40.00	-25.70	Peak
2	68.15	27.50	11.21	26.98	0.29	12.02	40.00	-27.98	Peak
3	114.92	26.61	11.68	26.87	0.38	11.80	43.50	-31.70	Peak
4	150.01	25.25	14.16	26.91	0.39	12.89	43.50	-30.61	Peak
5	297.22	25.28	12.76	27.19	0.94	11.79	46.00	-34.21	Peak
6	625.08	29.25	18.80	27.82	1.11	21.34	46.00	-24.66	Peak

Remark: Level = Read Level + Antenna Factor - Preamp Factor + Cable Loss

Operation Mode:	TX 2402MHz (1Mbps)	Test Date :	Dec. 05, 2013
Frequency Range:	1-25GHz	Temperature :	28 °C
Measured Distance:	3m	Humidity :	65 %
Test Voltage:	DC 3.7V		

Freq. (MHz)	Ant.Pol. H/V	Emission Level (dBUV/m)		Limit3m (dBUV/m)		Margin(dB)	
		PK	AV	PK	AV	PK	AV
4804.080	V	49.74	41.75	74.00	54.00	24.26	12.25
--	V	--	--	74.00	54.00	--	--
--	V	--	--	74.00	54.00	--	--
--	V	--	--	74.00	54.00	--	--
--	V	--	--	74.00	54.00	--	--
4804.080	H	51.62	43.85	74.00	54.00	22.38	10.15
--	H	--	--	74.00	54.00	--	--
--	H	--	--	74.00	54.00	--	--
--	H	--	--	74.00	54.00	--	--
--	H	--	--	74.00	54.00	--	--

Other harmonics emissions are lower than 20dB below the allowable limit.

- Note:**
- (1) All Readings are Peak Value and AV.
 - (2) Emission Level= Reading Level + Probe Factor +Cable Loss
 - (3) Data of measurement within this frequency range shown "--" in the table above means the reading of emissions are attenuated more than 20dB below the permissible limits or the field strength is too small to be measured.

Operation Mode:	TX 2441MHz (1 Mbps)	Test Date :	Dec. 05, 2013
Frequency Range:	1-25GHz	Temperature :	28 °C
Measured Distance:	3m	Humidity :	65 %
Test Voltage:	DC 3.7V		

Freq. (MHz)	Ant.Pol. H/V	Emission Level (dBuV/m)		Limit3m (dBuV/m)		Margin(dB)	
		PK	AV	PK	AV	PK	AV
4882.070	V	49.91	42.05	74.00	54.00	24.09	11.95
--	V	--	--	74.00	54.00	--	--
--	V	--	--	74.00	54.00	--	--
--	V	--	--	74.00	54.00	--	--
--	V	--	--	74.00	54.00	--	--
4882.070	H	52.19	44.28	74.00	54.00	21.81	9.72
--	H	--	--	74.00	54.00	--	--
--	H	--	--	74.00	54.00	--	--
--	H	--	--	74.00	54.00	--	--
--	H	--	--	74.00	54.00	--	--

Other harmonics emissions are lower than 20dB below the allowable limit.

- Note:**
- (1) All Readings are Peak Value and AV.
 - (2) Emission Level= Reading Level + Probe Factor +Cable Loss
 - (3) Data of measurement within this frequency range shown “ -- ” in the table above means the reading of emissions are attenuated more than 20dB below the permissible limits or the field strength is too small to be measured.

Operation Mode:	TX 2480MHz (1 Mbps)	Test Date :	Dec. 05, 2013
Frequency Range:	1-25GHz	Temperature :	28 °C
Measured Distance:	3m	Humidity :	65 %
Test Voltage:	DC 3.7V		

Freq. (MHz)	Ant.Pol. H/V	Emission Level (dBUV/m)		Limit3m (dBUV/m)		Margin(dB)	
		PK	AV	PK	AV	PK	AV
4960.000	V	49.66	41.78	74.00	54.00	24.34	12.22
--	V	--	--	74.00	54.00	--	--
--	V	--	--	74.00	54.00	--	--
--	V	--	--	74.00	54.00	--	--
--	V	--	--	74.00	54.00	--	--
4960.000	H	51.72	43.57	74.00	54.00	22.28	10.43
--	H	--	--	74.00	54.00	--	--
--	H	--	--	74.00	54.00	--	--
--	H	--	--	74.00	54.00	--	--
--	H	--	--	74.00	54.00	--	--

Other harmonics emissions are lower than 20dB below the allowable limit.

- Note:**
- (1) All Readings are Peak Value and AV.
 - (2) Emission Level= Reading Level + Probe Factor +Cable Loss
 - (3) Data of measurement within this frequency range shown “ -- ” in the table above means the reading of emissions are attenuated more than 20dB below the permissible limits or the field strength is too small to be measured.

Operation Mode:	TX 2402MHz (3 Mbps)	Test Date :	Dec. 05, 2013
Frequency Range:	1-25GHz	Temperature :	28 °C
Measured Distance:	3m	Humidity :	65 %
Test Voltage:	DC 3.7V		

Freq. (MHz)	Ant.Pol. H/V	Emission Level (dBuV/m)		Limit3m (dBuV/m)		Margin(dB)	
		PK	AV	PK	AV	PK	AV
4804.100	V	47.44	39.27	74.00	54.00	26.56	14.73
--	V	--	--	74.00	54.00	--	--
--	V	--	--	74.00	54.00	--	--
--	V	--	--	74.00	54.00	--	--
--	V	--	--	74.00	54.00	--	--
4804.100	H	49.38	40.20	74.00	54.00	24.62	13.80
--	H	--	--	74.00	54.00	--	--
--	H	--	--	74.00	54.00	--	--
--	H	--	--	74.00	54.00	--	--
--	H	--	--	74.00	54.00	--	--

Other harmonics emissions are lower than 20dB below the allowable limit.

- Note:**
- (1) All Readings are Peak Value and AV.
 - (2) Emission Level= Reading Level + Probe Factor +Cable Loss
 - (3) Data of measurement within this frequency range shown “ -- ” in the table above means the reading of emissions are attenuated more than 20dB below the permissible limits or the field strength is too small to be measured.

Operation Mode:	TX 2441MHz (3 Mbps)	Test Date :	Dec. 05, 2013
Frequency Range:	1-25GHz	Temperature :	28 °C
Measured Distance:	3m	Humidity :	65 %
Test Voltage:	DC 3.7V		

Freq. (MHz)	Ant.Pol. H/V	Emission Level (dBuV/m)		Limit3m (dBuV/m)		Margin(dB)	
		PK	AV	PK	AV	PK	AV
4882.110	V	47.10	38.52	74.00	54.00	26.90	15.48
--	V	--	--	74.00	54.00	--	--
--	V	--	--	74.00	54.00	--	--
--	V	--	--	74.00	54.00	--	--
--	V	--	--	74.00	54.00	--	--
4882.110	H	48.79	39.08	74.00	54.00	25.21	14.92
--	H	--	--	74.00	54.00	--	--
--	H	--	--	74.00	54.00	--	--
--	H	--	--	74.00	54.00	--	--
--	H	--	--	74.00	54.00	--	--

Other harmonics emissions are lower than 20dB below the allowable limit.

- Note:**
- (1) All Readings are Peak Value and AV.
 - (2) Emission Level= Reading Level + Probe Factor +Cable Loss
 - (3) Data of measurement within this frequency range shown “ -- ” in the table above means the reading of emissions are attenuated more than 20dB below the permissible limits or the field strength is too small to be measured.

Operation Mode:	TX 2480MHz (3 Mbps)	Test Date :	Dec. 05, 2013
Frequency Range:	1-25GHz	Temperature :	28 °C
Measured Distance:	3m	Humidity :	65 %
Test Voltage:	DC 3.7V		

Freq. (MHz)	Ant.Pol. H/V	Emission Level (dBUV/m)		Limit3m (dBUV/m)		Margin(dB)	
		PK	AV	PK	AV	PK	AV
4960.100	V	46.41	37.59	74.00	54.00	27.59	16.41
--	V	--	--	74.00	54.00	--	--
--	V	--	--	74.00	54.00	--	--
--	V	--	--	74.00	54.00	--	--
--	V	--	--	74.00	54.00	--	--
4960.100	H	48.75	39.67	74.00	54.00	25.25	14.33
--	H	--	--	74.00	54.00	--	--
--	H	--	--	74.00	54.00	--	--
--	H	--	--	74.00	54.00	--	--
--	H	--	--	74.00	54.00	--	--

Other harmonics emissions are lower than 20dB below the allowable limit.

- Note:**
- (1) All Readings are Peak Value and AV.
 - (2) Emission Level= Reading Level + Probe Factor +Cable Loss
 - (3) Data of measurement within this frequency range shown “ -- ” in the table above means the reading of emissions are attenuated more than 20dB below the permissible limits or the field strength is too small to be measured.

5. Restricted Bands Requirement

5.1 Test Standard and Limit

5.1.1 Test Standard

FCC Part 15.209

FCC Part 15.205

5.1.2 Test Limit

Restricted Frequency Band (MHz)	Class B (dBuV/m)(at 3m)	
	Peak	Average
2310 ~2390	74	54
2483.5 ~2500	74	54

5.2 Test Setup

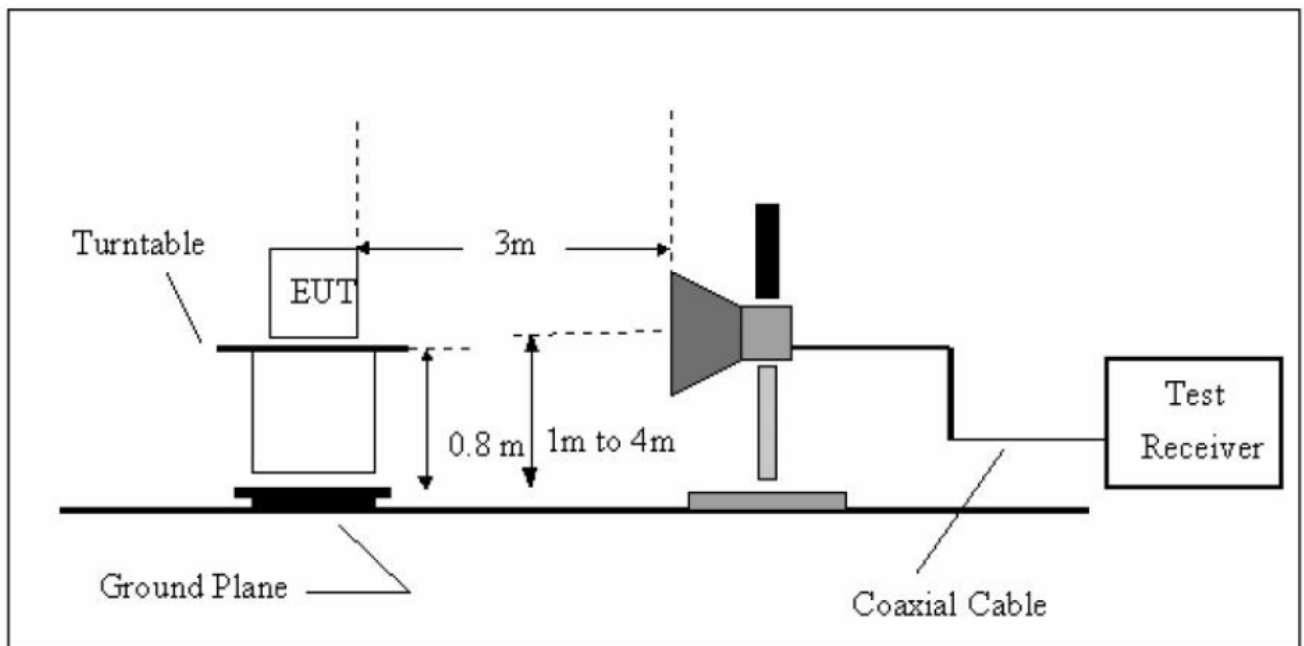

5.3 Test Procedure

- (1) The measuring distance of 3m shall be used for measurements at frequency up to 1GHz and above 1 GHz. The EUT was placed on a rotating 0.8m high above ground, the table was rotated 360 degrees to determine the position of the highest radiation.
- (2) The Test antenna shall vary between 1m and 4m, Both Horizontal and Vertical antenna are set to make measurement.
- (3) The initial step in collecting conducted emission data is a spectrum analyzer peak detector mode pre-scanning the measurement frequency range. Significant peaks are then marked and then Quasi Peak detector mode re-measured.

- (4) If the Peak Mode measured value compliance with and lower than Quasi Peak Mode Limit Bellow 1 GHz, the EUT shall be deemed to meet QP Limits and then no additional QP Mode measurement performed. But the Peak Value and average value both need to comply with applicable limit above 1 GHz.
- (5) For the actual test configuration, please see the test setup photo.

5.4 EUT Operating Condition

The Equipment Under Test was set to Continual Transmitting in maximum power.

5.5 Test Equipment

Description	Manufacturer	Model No.	Serial No.	Cal. Date	Cal. Due Date
Spectrum Analyzer	ROHDE& SCHWARZ	FSP30	DE25181	2012-12-31	2013-12-30
Spectrum Analyzer	Agilent	E4407B	MY49510055	2012-12-31	2013-12-30
EMI Test Receiver	ROHDE& SCHWARZ	ESCI	101165	2012-12-31	2013-12-30
Bilog Antenna	SCHWARZBECK	VULB9168	9168-438	2013-02-12	2014-02-11
Horn Antenna	SCHWARZBECK	BBHA 9120D	BBHA9120D	2013-02-12	2014-02-11
Horn Antenna	SCHWARZBECK	BBHA 9170	BBHA9170D	2013-02-12	2014-02-11
Active Loop Antenna	Beijing Daze	ZN30900A	SEL0097	2013-02-12	2014-02-11
Pre-amplifier	SCHWARZBECK	BBV9743	9743-019	2013-10-28	2014-10-27
Pre-amplifier	Quietek	AP-180C	CHM-0602012	2013-10-28	2014-10-27

5.6 Test Data

Spectrum Detector: PK
Temperature : 28 °C

Test Date : December 09, 2013
Humidity : 65 %

GFSK Mode

1. Radiated Emission test

Test Mode	Frequency (MHz)	Antenna polarization (H/V)	Emission (dBuV/m)		Band edge Limit (dBuV/m)	
			PEAK	AV	PEAK	AV
TX 2402 MHz	2390.0	H	50.85	41.08	74.00	54.00
	2390.0	V	49.42	40.07	74.00	54.00
TX 2480 MHz	2483.5	H	52.57	48.61	74.00	54.00
	2483.5	V	51.55	48.03	74.00	54.00

Note: During testing the measuring instrument use RBW=1 MHz and VBW=3 MHz with Peak Detector for Peak Values, and use RBW=1 MHz and VBW=10 Hz with Peak Detector for Average Values.

GFSK TX 2402MHz Mode

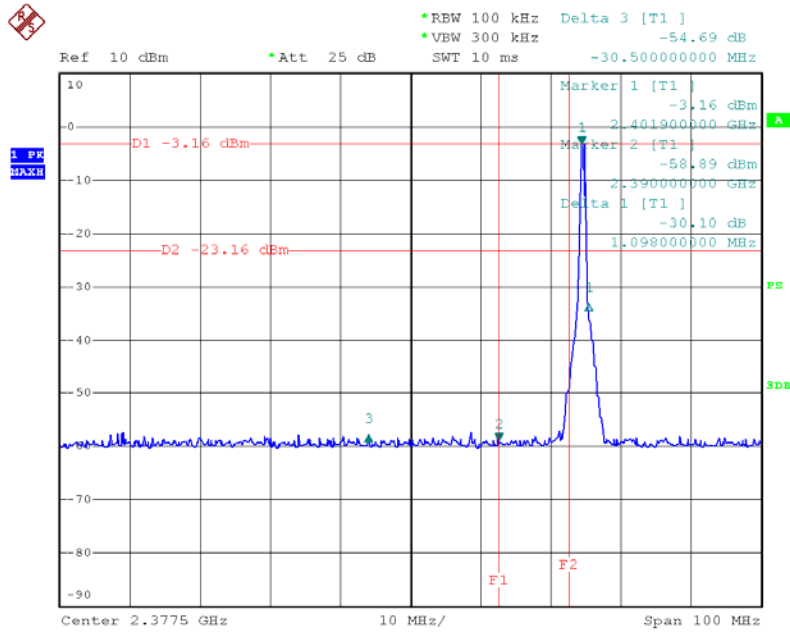

Date: 9.DEC.2013 14:55:23

GFSK TX 2480MHz Mode

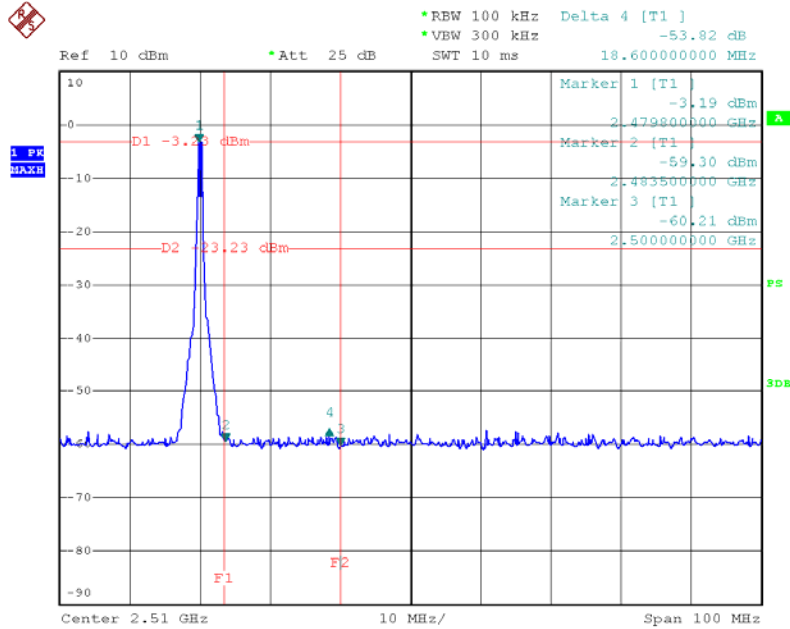

Date: 9.DEC.2013 14:58:53

GFSK Hopping TX Mode

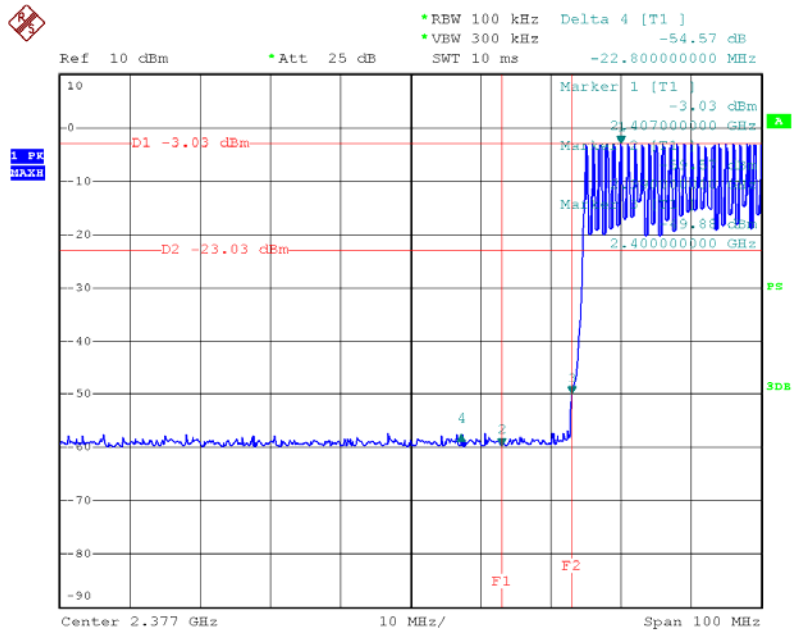

Date: 9.DEC.2013 14:20:55

GFSK Hopping TX Mode

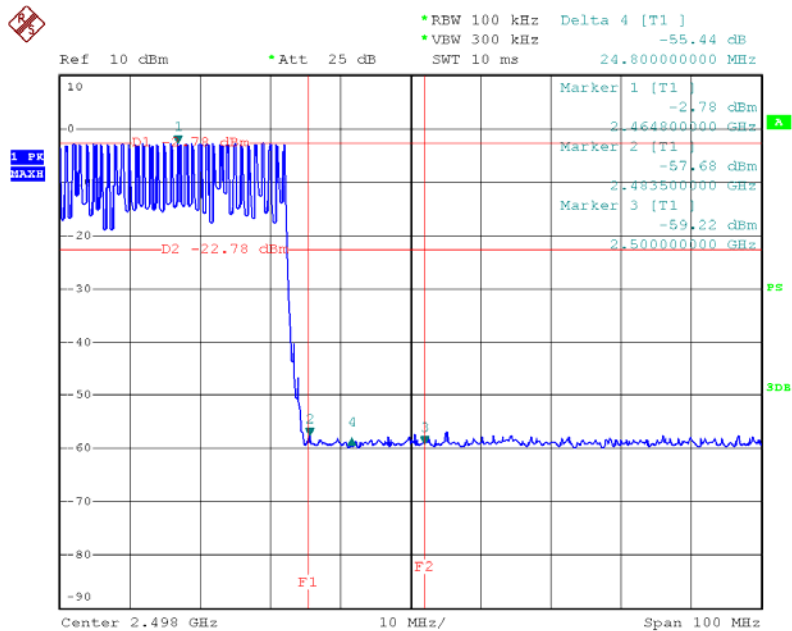

Date: 9.DEC.2013 14:13:46

Spectrum Detector: PK
Temperature : 28 °C

Test Date : December 09, 2013
Humidity : 65 %

8-DPSK Mode

1. Radiated emission test

Test Mode	Frequency (MHz)	Antenna polarization (H/V)	Emission (dBuV/m)		Band edge Limit (dBuV/m)	
			PEAK	AV	PEAK	AV
TX 2402 MHz	2390.0	H	50.60	40.39	74.00	54.00
	2390.0	V	49.11	40.24	74.00	54.00
TX 2480 MHz	2483.5	H	53.74	49.61	74.00	54.00
	2483.5	V	52.38	48.87	74.00	54.00

Note: During testing the measuring instrument use RBW=1 MHz and VBW=3 MHz with Peak Detector for Peak Values, and use RBW=1 MHz and VBW=10 Hz with Peak Detector for Average Values.

8-DPSK TX 2402MHz Mode

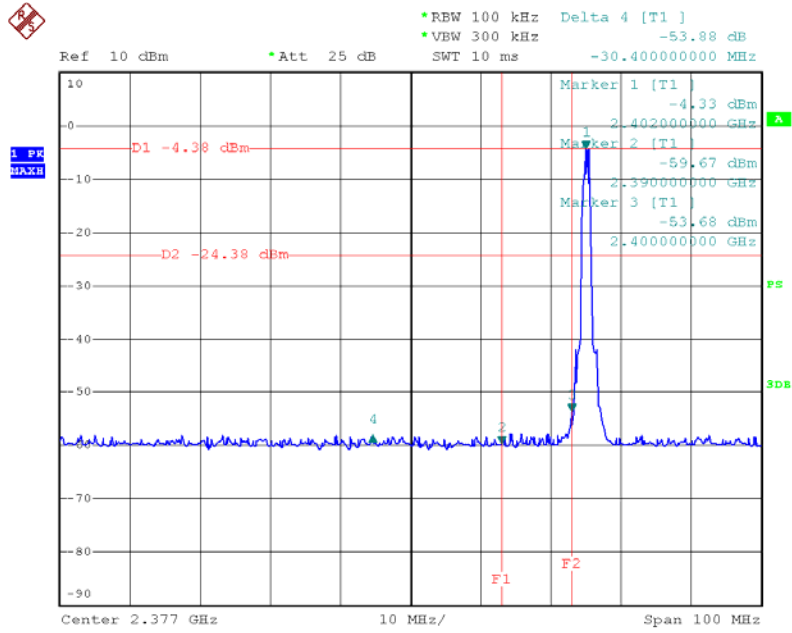

Date: 9.DEC.2013 15:08:03

8-DPSK TX 2480MHz Mode

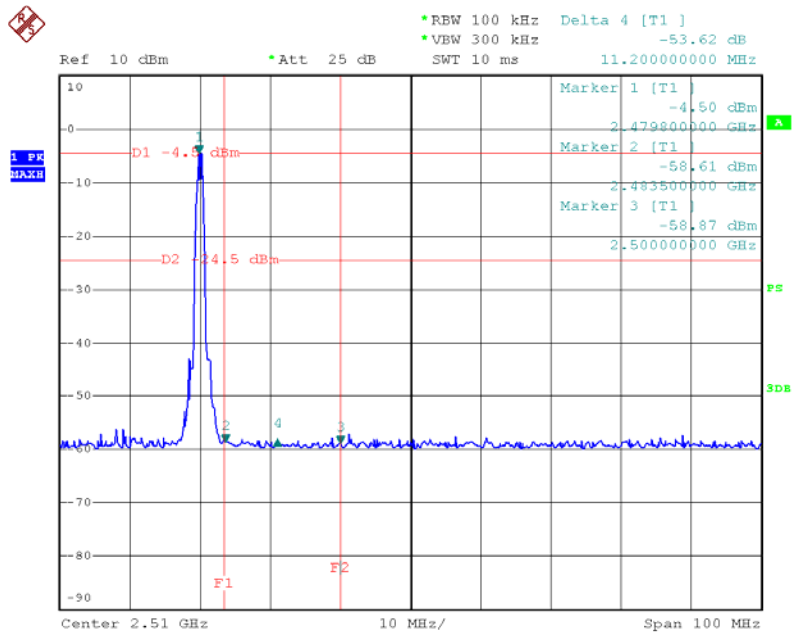

Date: 9.DEC.2013 15:04:14

8-DPSK Hopping TX Mode

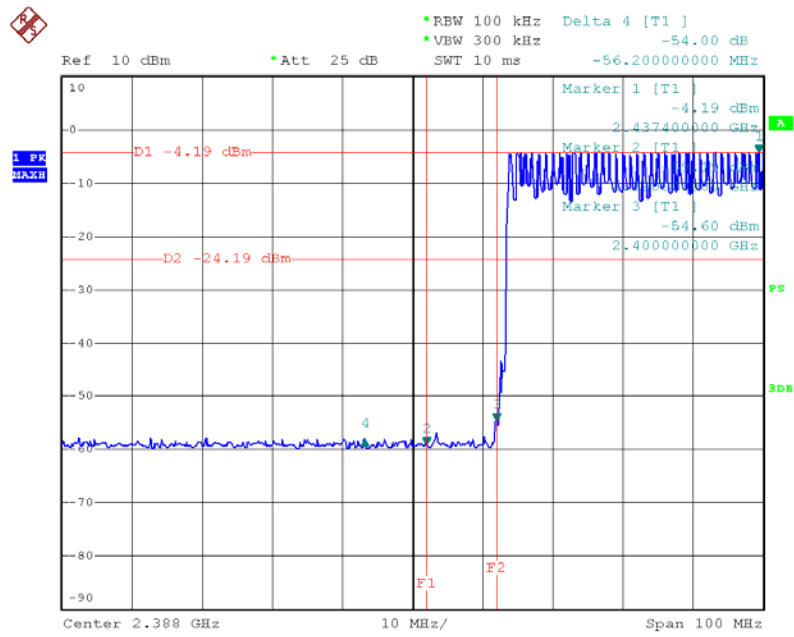

Date: 7.DEC.2013 15:22:42

8-DPSK Hopping TX Mode

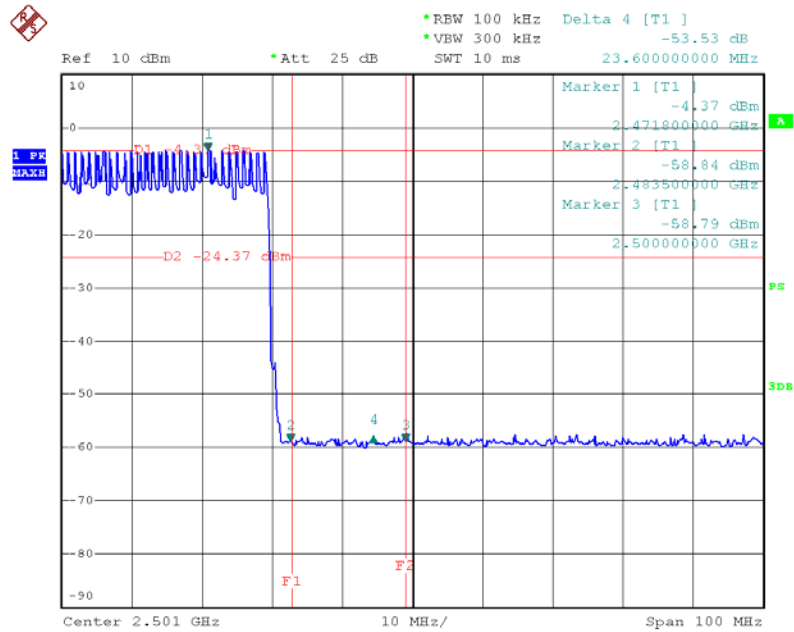

Date: 9.DEC.2013 14:27:37

6. Number of Hopping Channel

6.1 Test Standard and Limit

6.1.1 Test Standard
FCC Part 15.247 (a)(1)

6.1.2 Test Limit

Section	Test Item	Limit
15.247	Number of Hopping Channel	>15

6.2 Test Setup

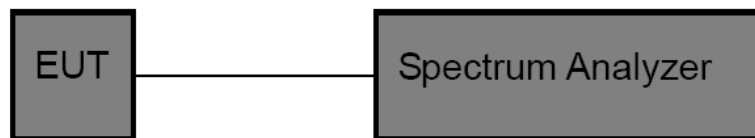

6.3 Test Procedure

- (1) The EUT was directly connected to the spectrum analyzer and antenna output port as show in the block diagram above.
- (2) Spectrum Setting:RBW=100 KHz, VBW=100 KHz, Sweep time= Auto.

6.4 EUT Operating Condition

The EUT was set to the Hopping Mode by the Customer.

6.5 Test Equipment

Description	Manufacturer	Model No.	Serial No.	Cal. Date	Cal. Due Date
Spectrum Analyzer	ROHDE& SCHWARZ	FSP30	DE25181	2012-12-31	2013-12-30

6.6 Test Data

1 Mbps		
Hopping Channel Frequency Range	Quantity of Hopping Channel	Limit
2402~2480	79	>15

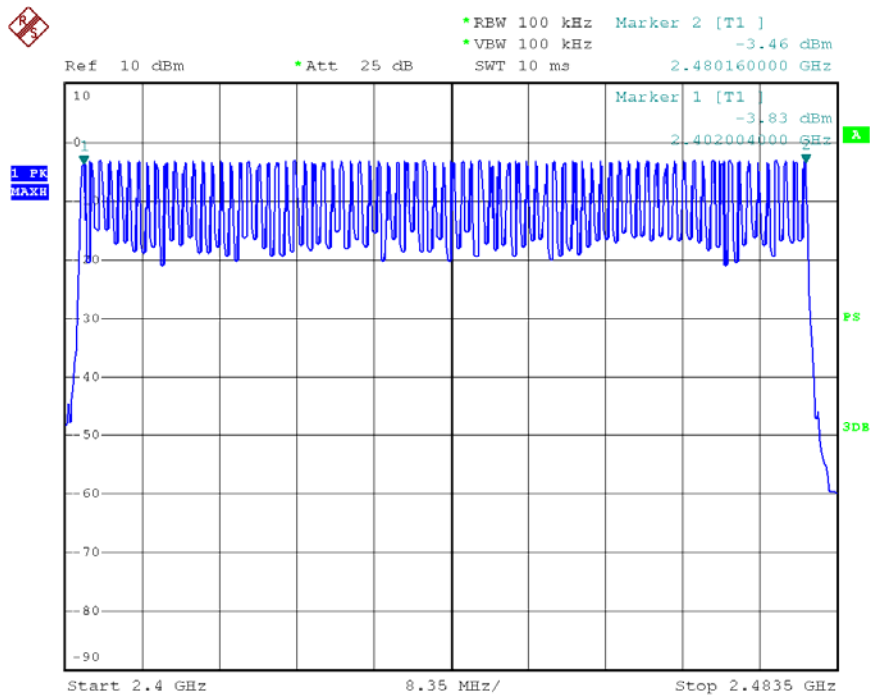

Date: 7.DEC.2013 15:13:09

3 Mbps		
Hopping Channel Frequency Range	Quantity of Hopping Channel	Limit
2402~2480	79	>15

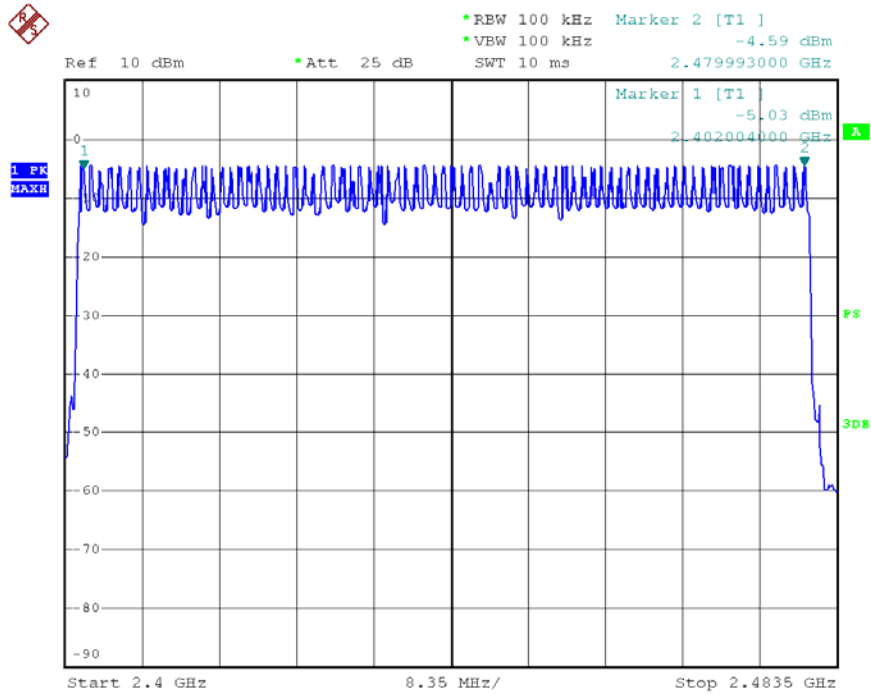

Date: 7.DEC.2013 15:16:22

7. Average Time of Occupancy

7.1 Test Standard and Limit

5.1.1 Test Standard
FCC Part 15.247 (a)(1)

5.1.2 Test Limit

Section	Test Item	Limit
15.247(a)(1)/ RSS-210 Annex 8(A8.1d)	Average Time of Occupancy	0.4 sec

7.2 Test Setup

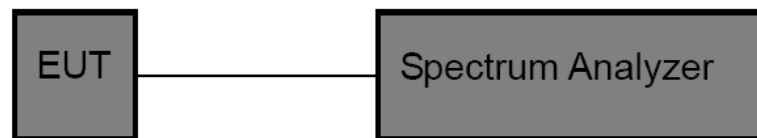

7.3 Test Procedure

- (1) The EUT was directly connected to the spectrum analyzer and antenna output port as show in the block diagram above.
- (2) Spectrum Setting: RBW=1MHz, VBW=1MHz.
- (3) Use video trigger with the trigger level set to enable triggering only on full pulses.
- (4) Sweep Time is more than once pulse time.
- (5) Set the center frequency on any frequency would be measure and set the frequency span to zero.
- (6) Measure the maximum time duration of one single pulse.
- (7) Set the EUT for packet transmitting.
- (8) Measure the maximum time duration of one single pulse.

7.4 EUT Operating Condition

The EUT was set to the Hopping Mode by the Customer.

7.5 Test Equipment

Description	Manufacturer	Model No.	Serial No.	Cal. Date	Cal. Due Date
Spectrum Analyzer	ROHDE& SCHWARZ	FSP30	DE25181	2012-12-31	2013-12-30

7.6 Test Data

Please refer the following test data of the worst mode.

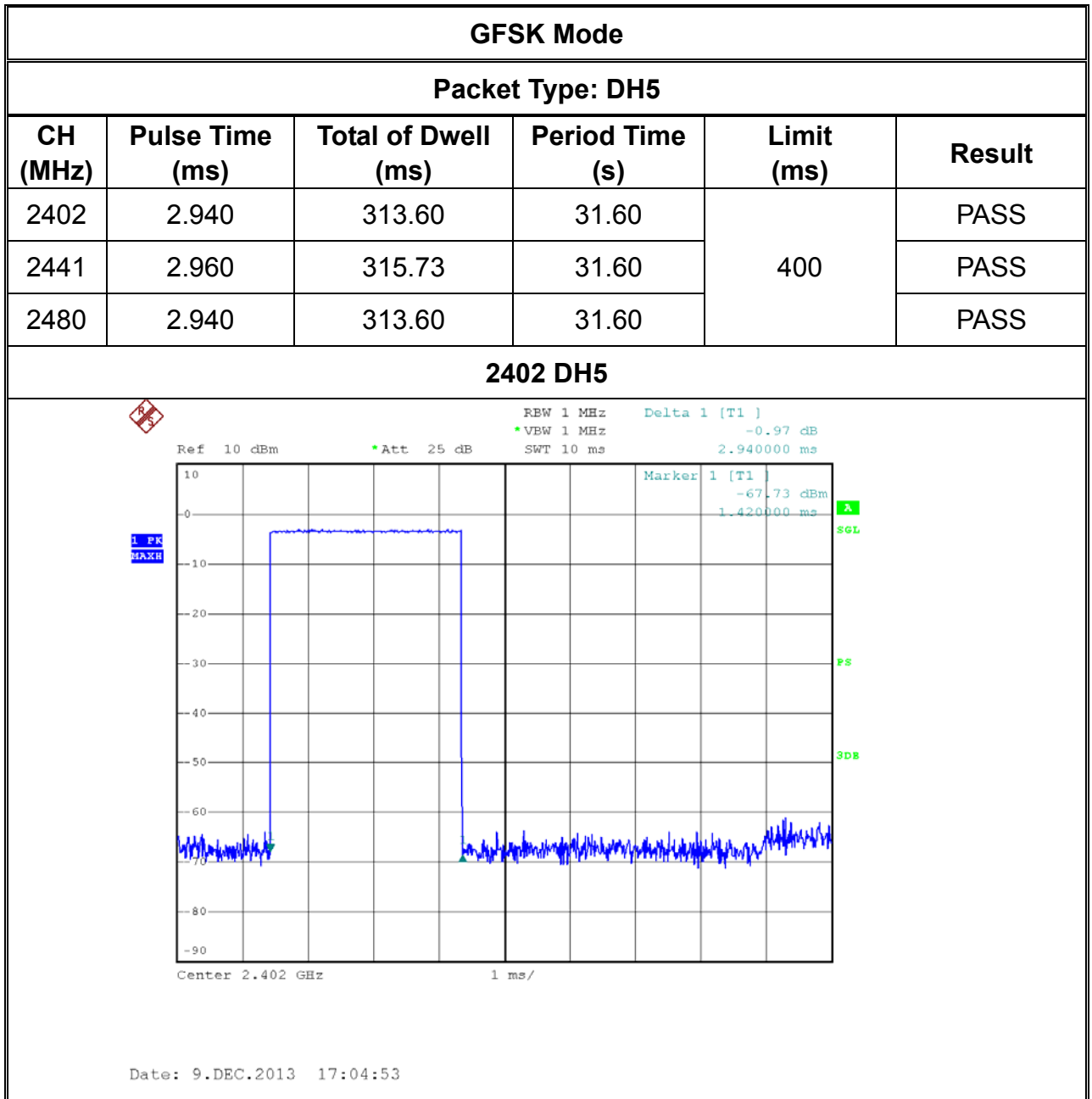

2441 DH5

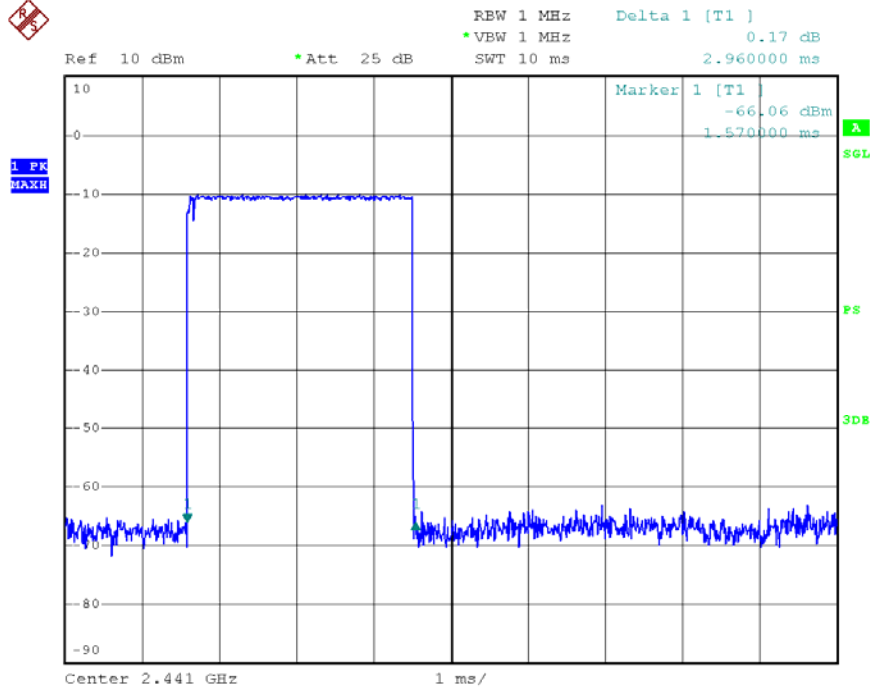

Date: 9.DEC.2013 17:04:05

2480 DH5

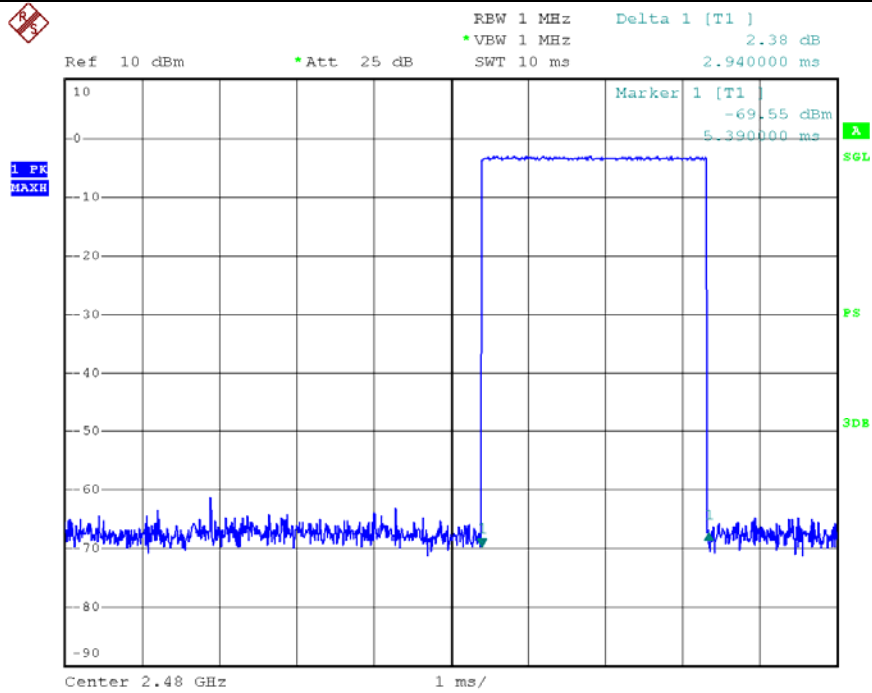

Date: 9.DEC.2013 17:02:53

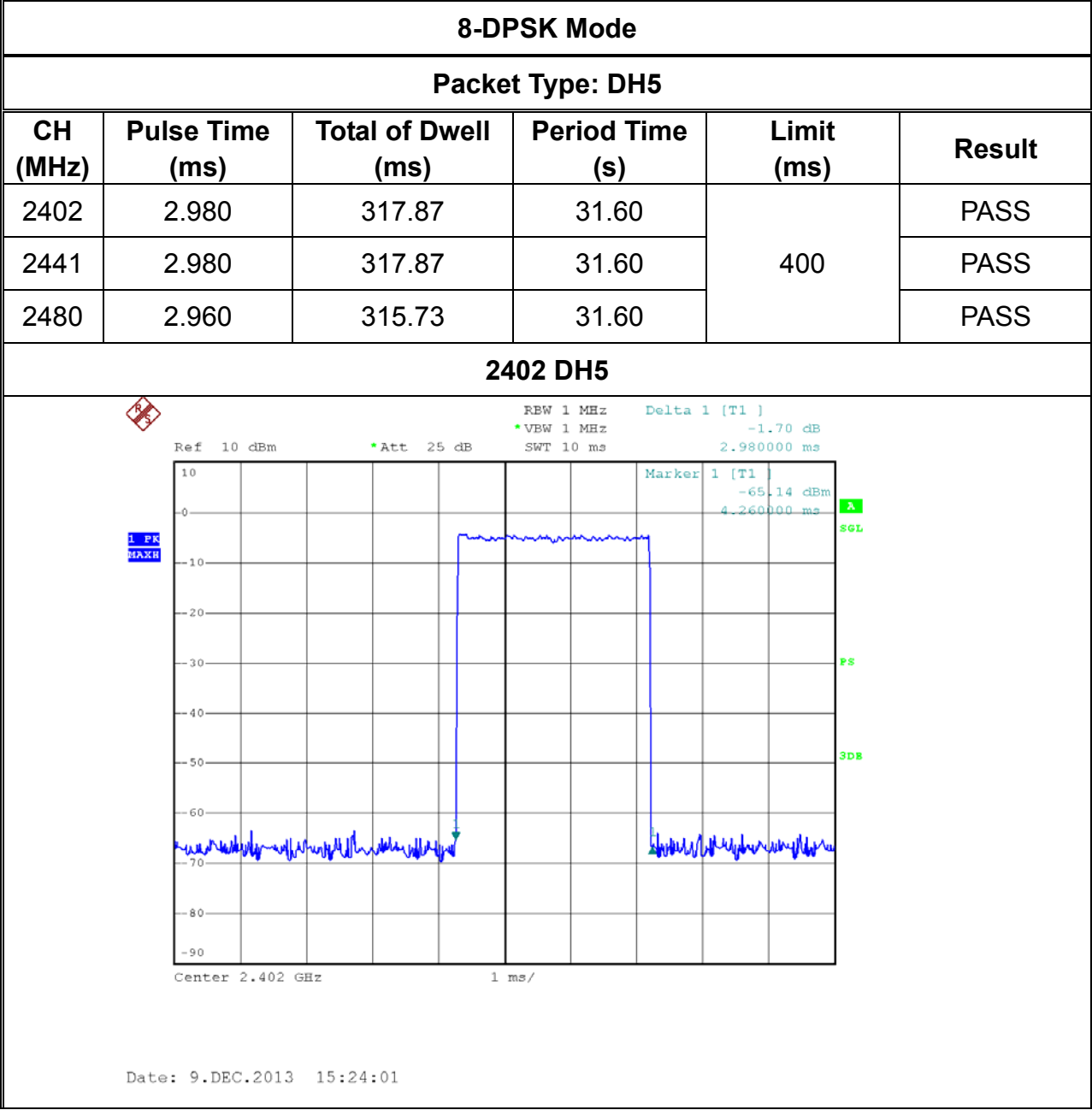

2441 DH5

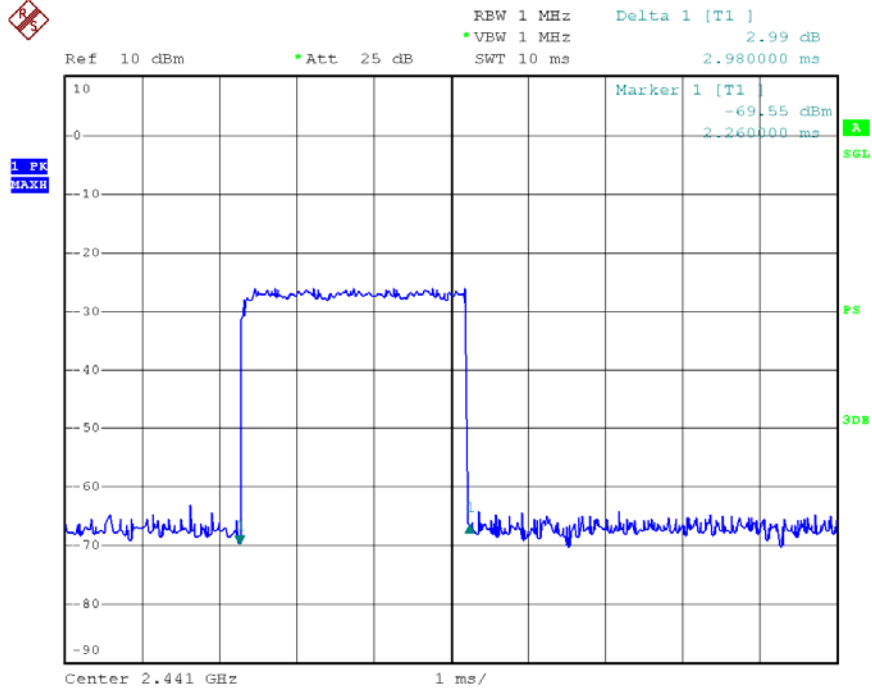

Date: 9.DEC.2013 15:25:32

2480 DH5

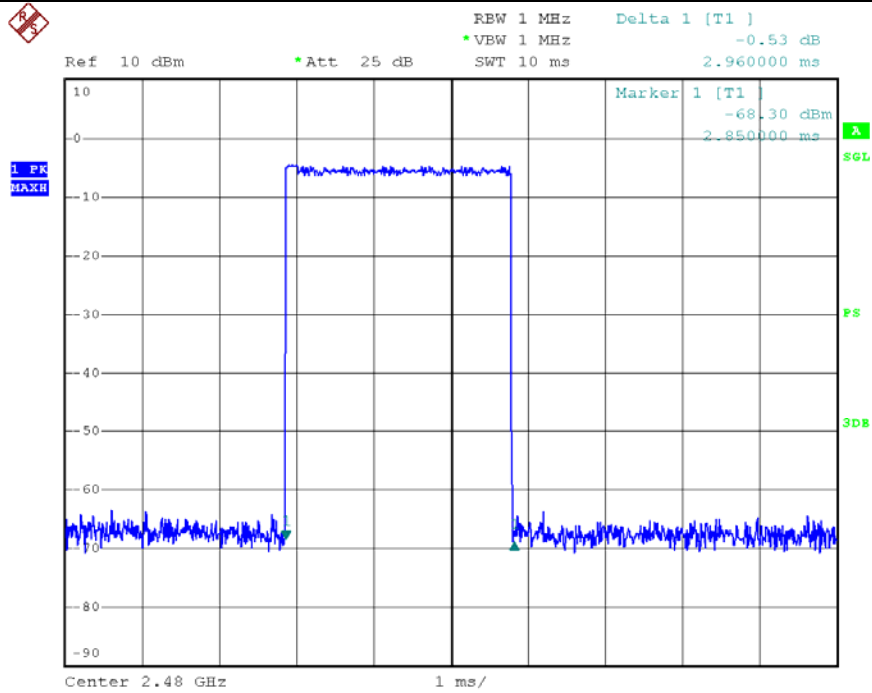

Date: 9.DEC.2013 16:49:39

8. Channel Separation and Bandwidth Test

8.1 Test Standard and Limit

8.1.1 Test Standard
FCC Part 15.247

8.1.2 Test Limit

Test Item	Limit	Frequency Range(MHz)
Bandwidth	≤ 1 MHz (20dB bandwidth)	2400~2483.5
Channel Separation	>25 KHz or $>$ two-thirds of the 20 dB bandwidth Which is greater	2400~2483.5

8.2 Test Setup

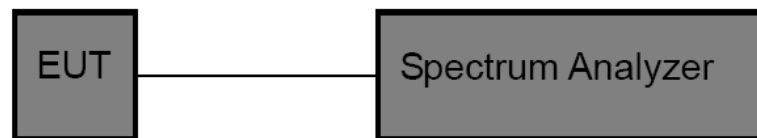

8.3 Test Procedure

- (1) The EUT was directly connected to the spectrum analyzer and antenna output port as show in the block diagram above.
- (2) Spectrum Setting:
Channel Separation: RBW=30 kHz, VBW=100 kHz.
Bandwidth: RBW=30 kHz, VBW=100 kHz.
- (3) The bandwidth is measured at an amplitude level reduced 20dB from the reference level. The reference level is the level of the highest amplitude signal observed from the transmitter at the fundamental frequency. Once the reference level is established, the equipment is conditioned with typical modulating signal to produce the worst –case (i.e the widest) bandwidth.
- (4) Measure the channel separation the spectrum analyzer was set to Resolution Bandwidth:30 kHz, and Video Bandwidth:100 kHz. Sweep Time set auto.

8.4 EUT Operating Condition

The EUT was set to the Hopping Mode for Channel Separation Test and continuously transmitting for the Bandwidth Test.

8.5 Test Equipment

Description	Manufacturer	Model No.	Serial No.	Cal. Date	Cal. Due Date
Spectrum Analyzer	ROHDE & SCHWARZ	FSP30	DE25181	2012-12-31	2013-12-30

8.6 Test Data

1 Mbps			
Channel frequency (MHz)	99% OBW (kHz)	20dB Bandwidth (kHz)	Read Value*2/3 (kHz)
2402	834.00	840.00	560.00
2441	834.00	840.00	560.00
2480	834.00	840.00	560.00

2402 MHz

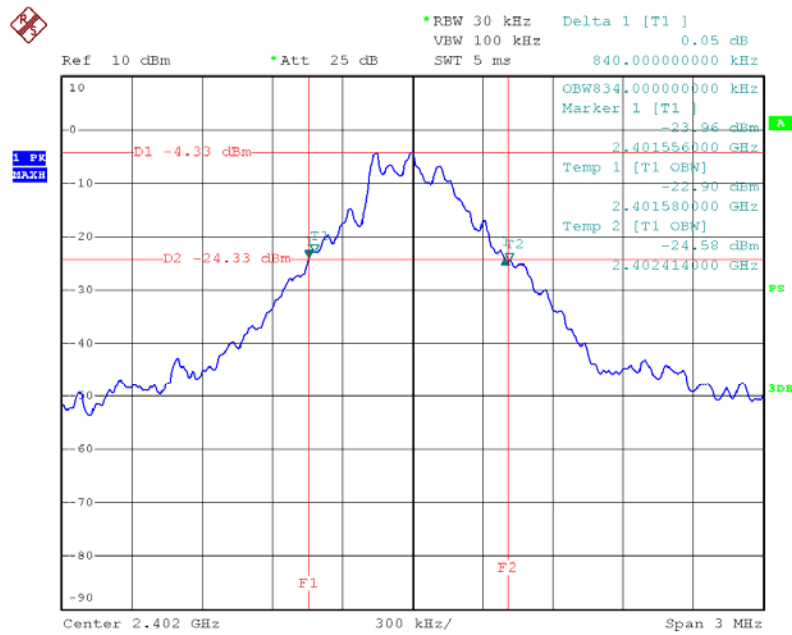

Date: 7.DEC.2013 14:47:01

2441 MHz

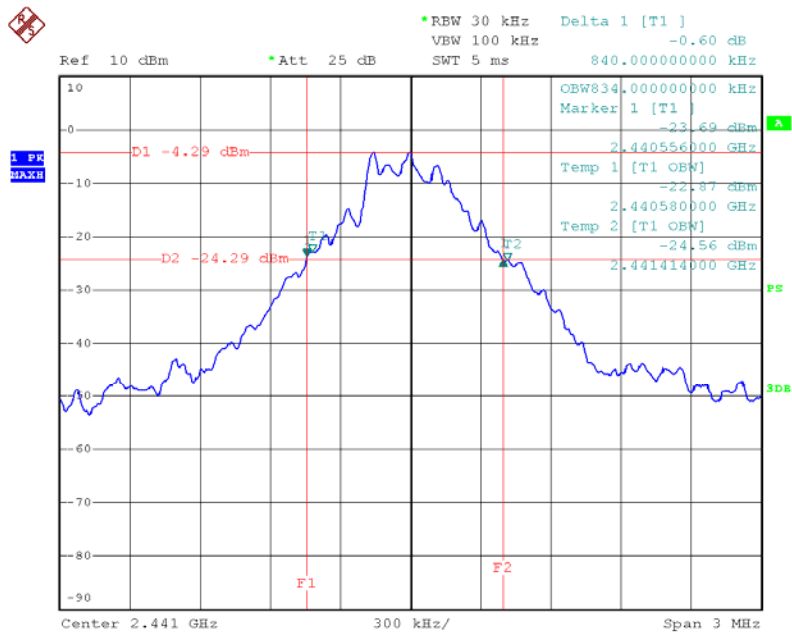

Date: 7.DEC.2013 14:50:01

2480 MHz

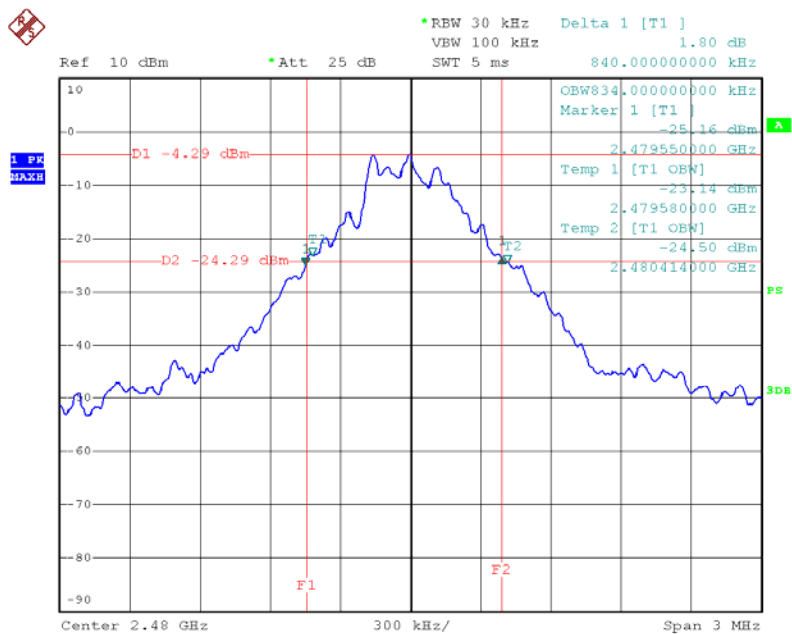

Date: 7.DEC.2013 14:52:31

1 Mbps			
Channel number	Channel frequency (MHz)	Separation Read Value (kHz)	Separation Limit (kHz)
CH 00	2402	1002.00	>560.00 kHz
CH 39	2441	1008.00	>560.00 kHz
CH 78	2480	1008.00	>560.00 kHz

2402 MHz

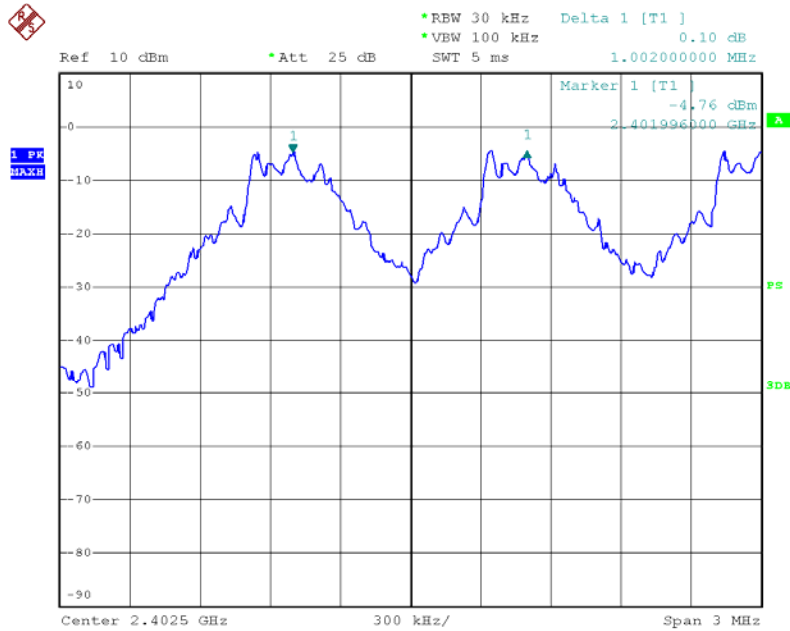

Date: 9.DEC.2013 14:52:11

2441 MHz

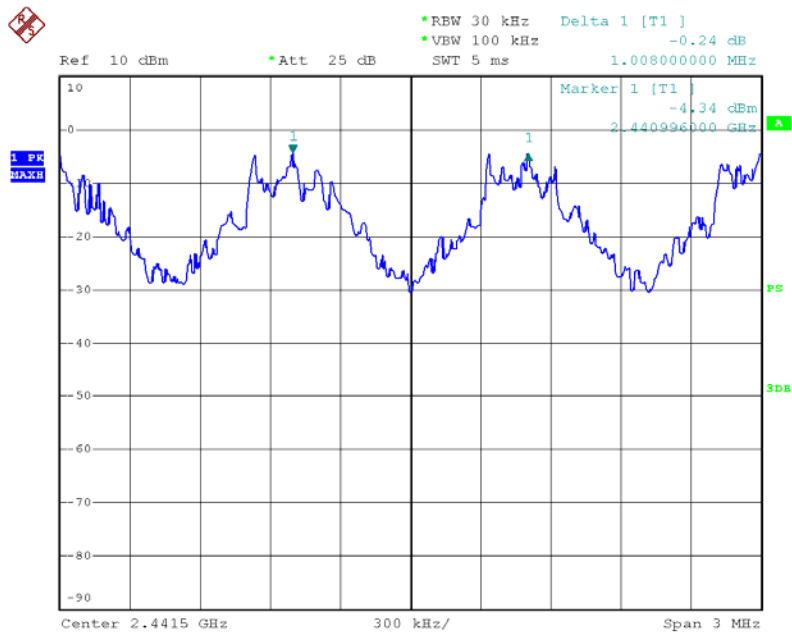

Date: 9.DEC.2013 14:44:42

2480 MHz

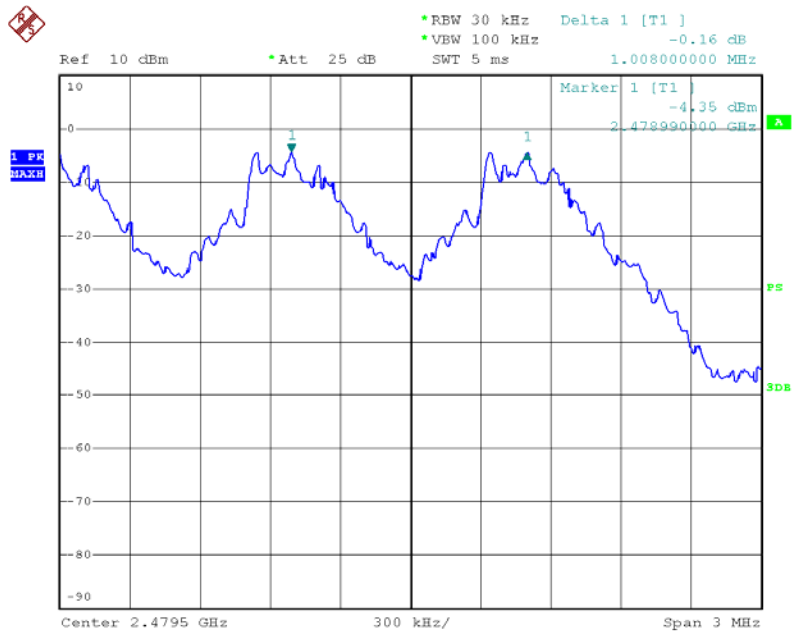

Date: 9.DEC.2013 14:43:22

3 Mbps			
Channel frequency (MHz)	99% OBW (kHz)	20dB Bandwidth (kHz)	Read Value*2/3 (kHz)
2402	1128.00	1212.00	808.00
2441	1128.00	1212.00	808.00
2480	1128.00	1212.00	808.00

2402 MHz

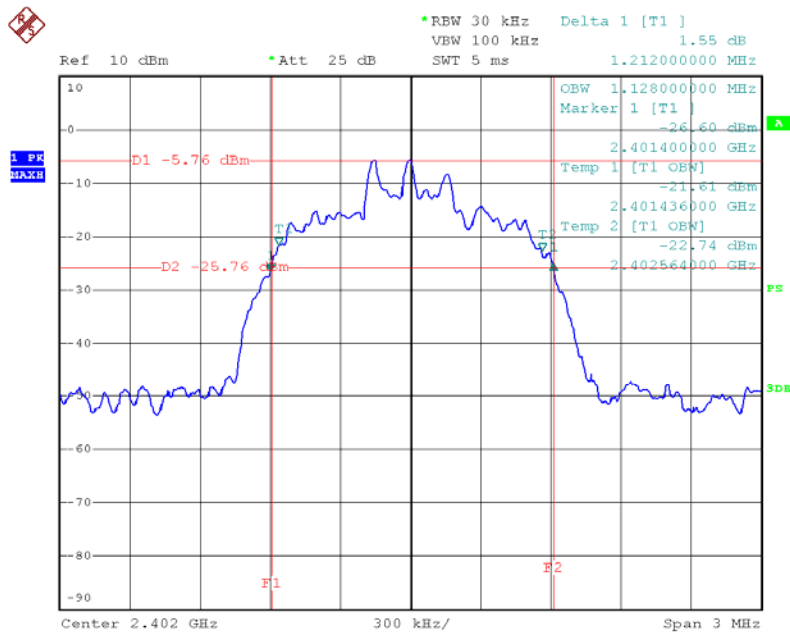

Date: 7.DEC.2013 14:57:40

2441 MHz

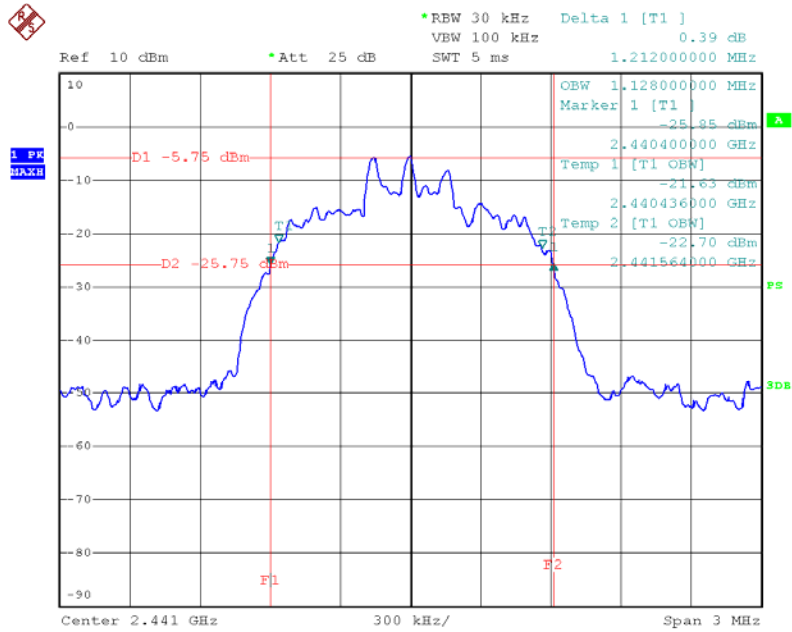

Date: 7.DEC.2013 14:56:15

2480 MHz

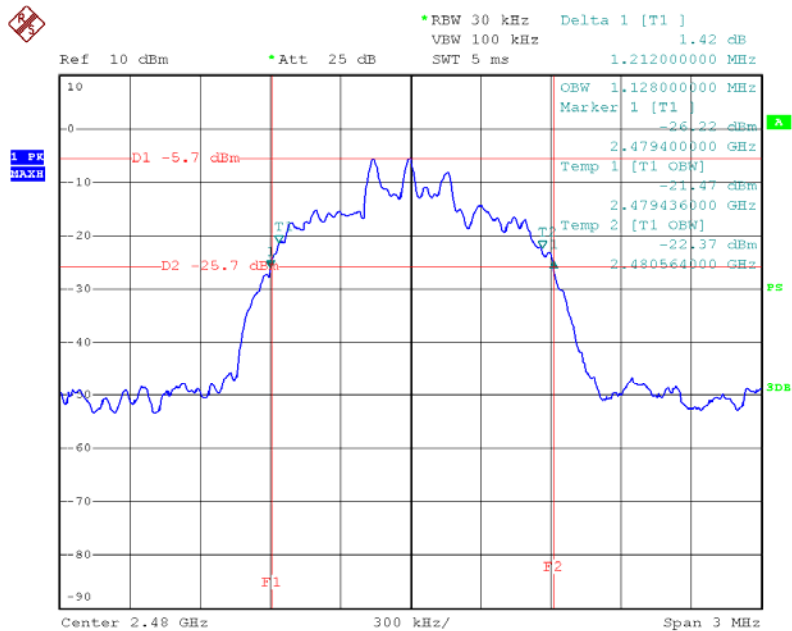

Date: 7.DEC.2013 14:54:52

3 Mbps			
Channel number	Channel frequency (MHz)	Separation Read Value (kHz)	Separation Limit (kHz)
CH 00	2402	1002.00	>808.00 kHz
CH 39	2441	1002.00	>808.00 kHz
CH 78	2480	1002.00	>808.00 kHz

2402 MHz

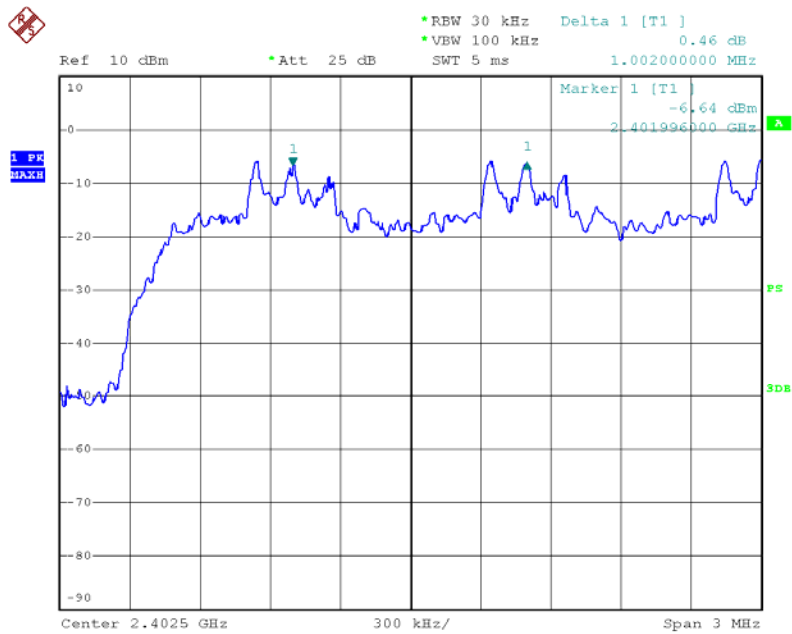

Date: 9.DEC.2013 14:33:55

2441 MHz

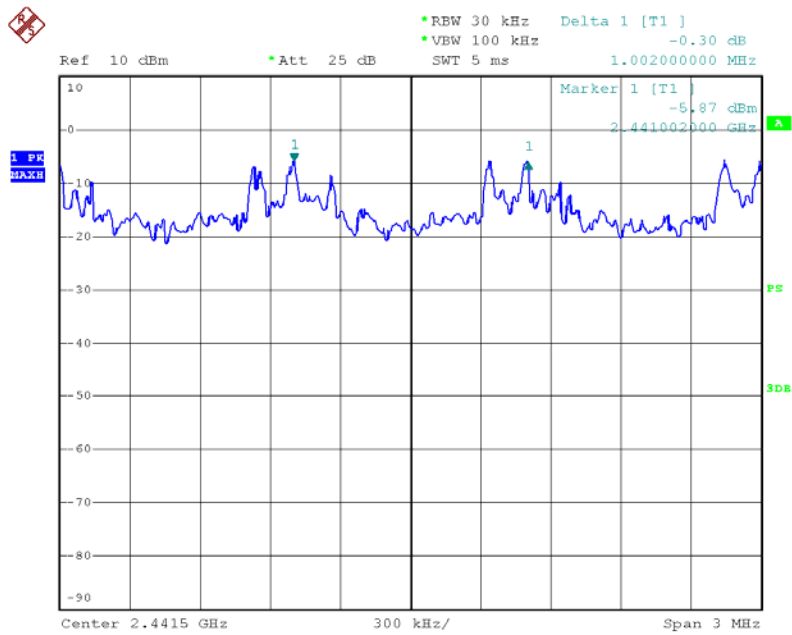

Date: 9.DEC.2013 14:36:40

2480 MHz

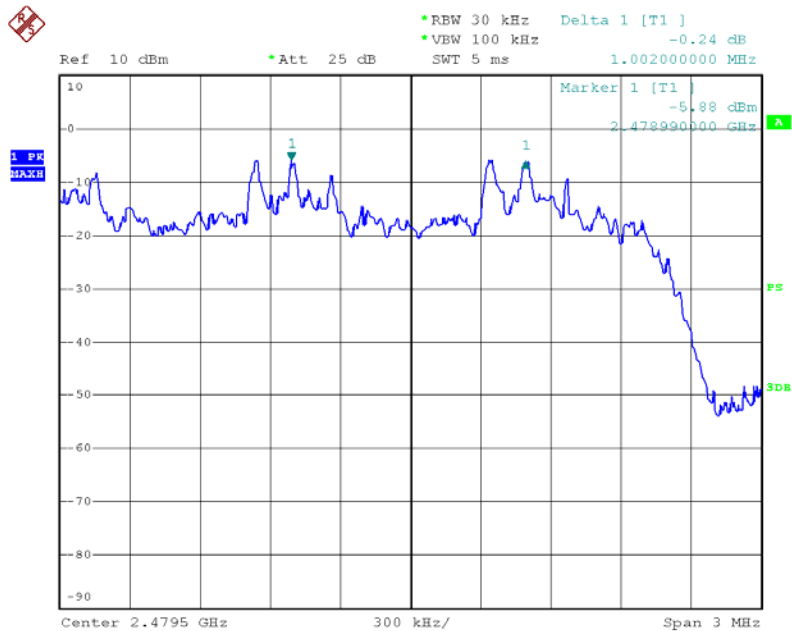

Date: 9.DEC.2013 14:38:49

9. Peak Output Power Test

9.1 Test Standard and Limit

9.1.1 Test Standard

FCC Part 15.247 (b) (1)

9.1.2 Test Limit

Test Item	Limit	Frequency Range(MHz)
Peak Output Power	Hopping Channels>75 Power<1W(30dBm) Other <125 mW(21dBm)	2400~2483.5

9.2 Test Setup

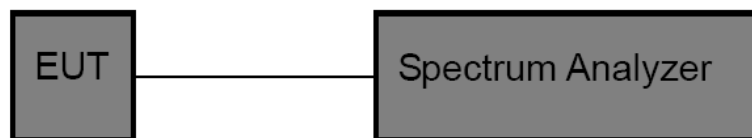

9.3 Test Procedure

- (1) The EUT was directly connected to the spectrum analyzer and antenna output port as show in the block diagram above.
- (2) Spectrum Setting:
Channel Separation: RBW=1 MHz, VBW=1 MHz.

9.4 EUT Operating Condition

The EUT was set to continuously transmitting in the max power during the test.

9.5 Test Equipment

Description	Manufacturer	Model No.	Serial No.	Cal. Date	Cal. Due Date
Spectrum Analyzer	ROHDE& SCHWARZ	FSP30	DE25181	2012-12-31	2013-12-30

8.6 Test Data

1 Mbps			
Channel number	Channel frequency (MHz)	Test Result (dBm)	Limit
CH 00	2402	-2.55	1W(30dBm)
CH 39	2441	-2.46	1W(30dBm)
CH 78	2480	-2.46	1W(30dBm))

2402 Power

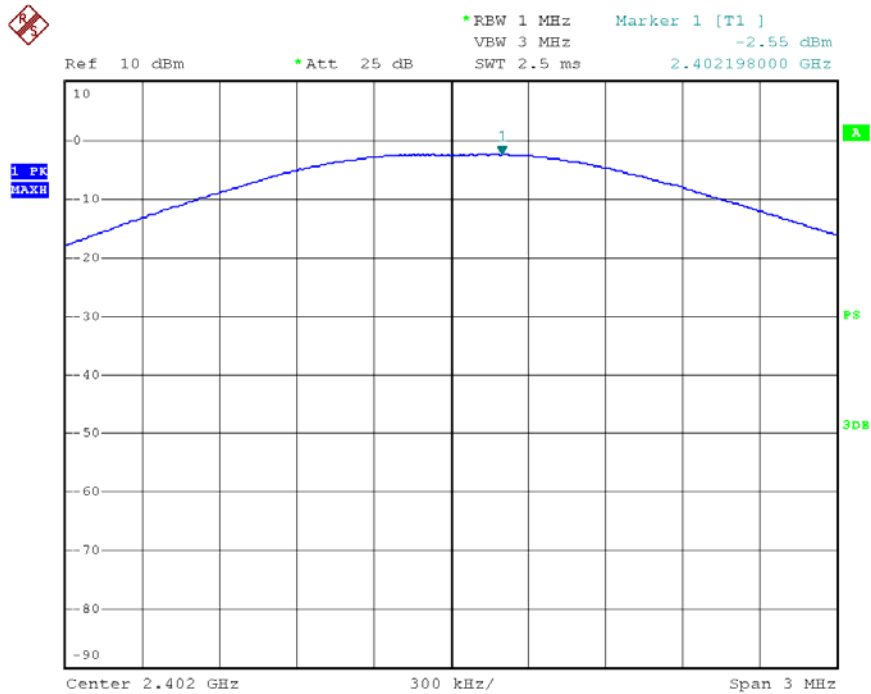

Date: 7.DEC.2013 15:07:03

2441 Power

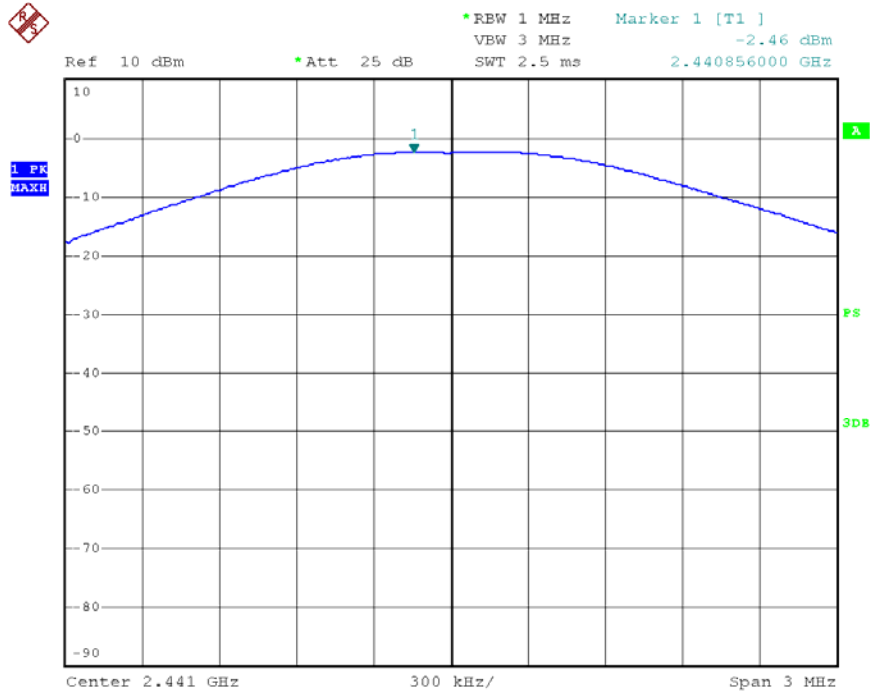

Date: 7.DEC.2013 15:05:55

2480 Power

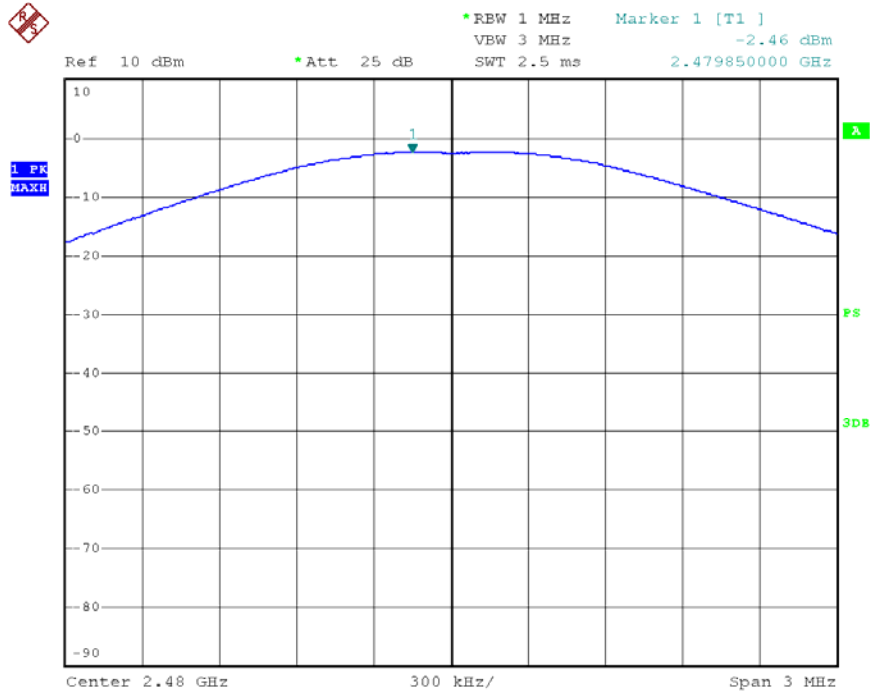

Date: 7.DEC.2013 15:05:08

3 Mbps			
Channel number	Channel frequency (MHz)	Test Result (dBm)	Limit
CH 00	2402	-3.49	1W(30dBm)
CH 39	2441	-4.17	1W(30dBm)
CH 78	2480	-5.14	1W(30dBm)

2402 Power

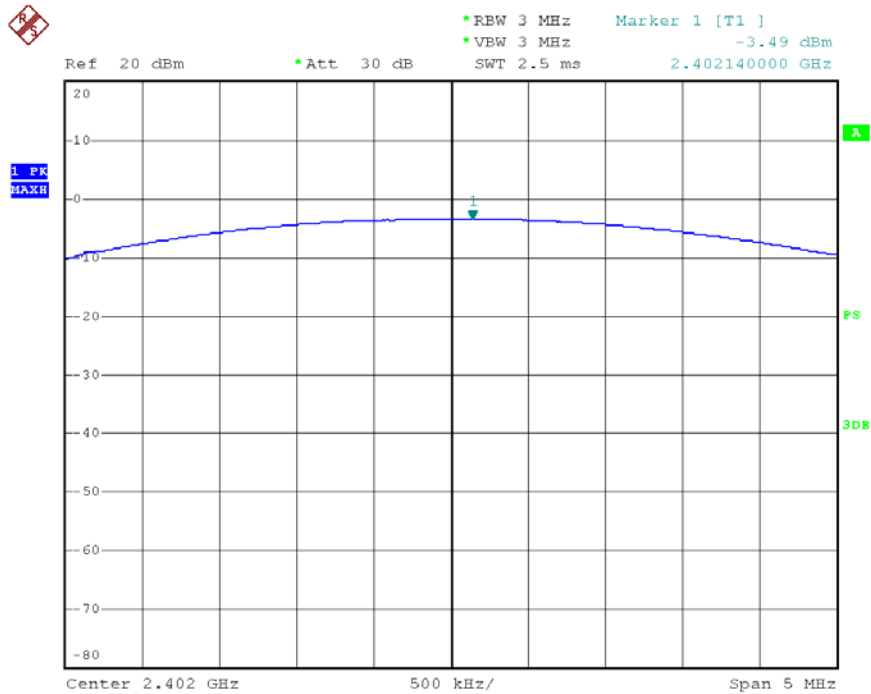

Date: 27.DEC.2013 17:36:54

2441 Power

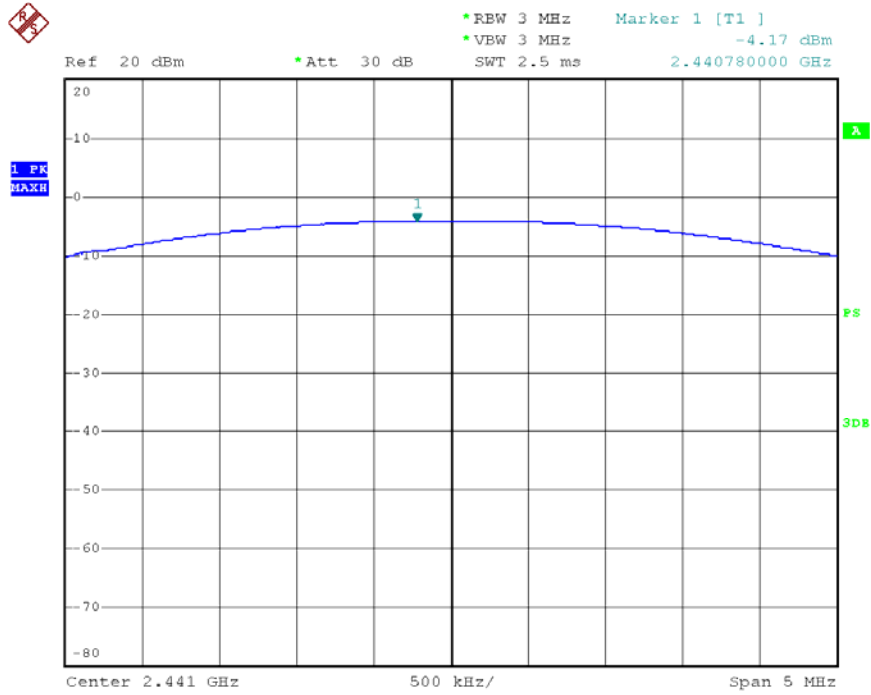

Date: 27.DEC.2013 17:37:22

2480 Power

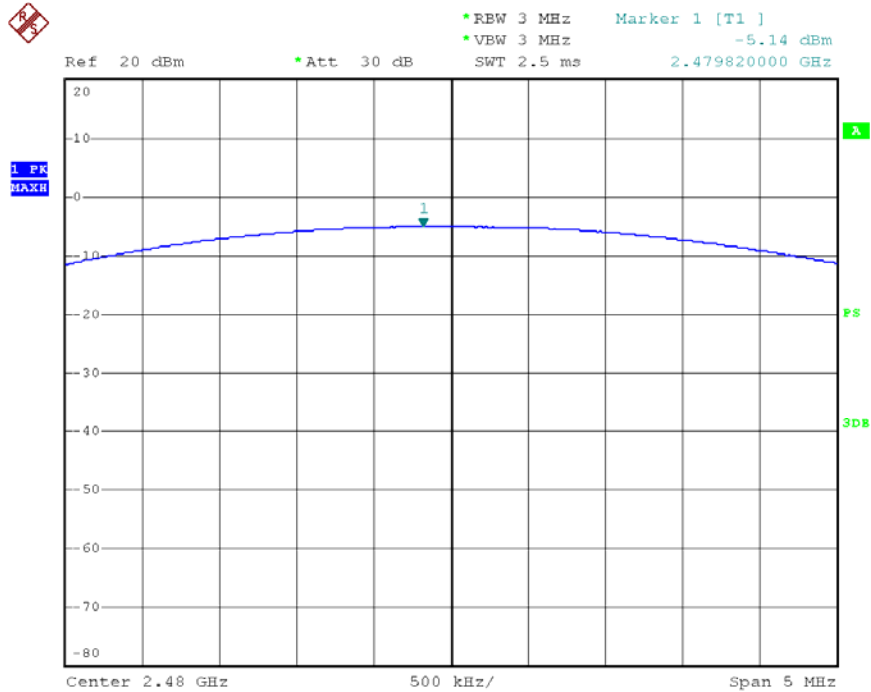

Date: 30.DEC.2013 13:36:42

10. Antenna Conducted Spurious Emission

10.1 Test Standard and Limit

10.1.1 Test Standard

FCC Part 15.247 (d)

10.1.2 Test Limit

In any 100 kHz bandwidth outside the frequency band in which the spread spectrum or digitally modulated intentional radiator is operating, the radio frequency power that is produced by the intentional radiator shall be at least 20 dB below that in the 100 kHz bandwidth within the band that contains the highest level of the desired power. In case the emission fall within the restricted band specified on 15.205(a), then the 15.209(a) limit in the table below has to be followed.

Frequencies (MHz)	Field Strength (microvolt/meter)	Measurement Distance (meters)
0.009~0.490	2400/F(KHz)	300
0.490~1.705	24000/F(KHz)	30
1.705~30.0	30	30
30~88	100	3
88~216	150	3
216~960	200	3
Above~960	500	3

10.2 Test Setup

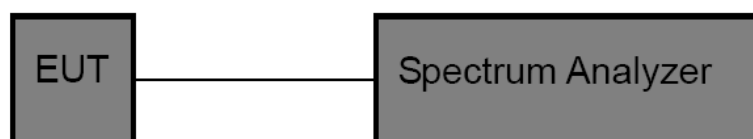

10.3 Test Procedure

- (1) The EUT was directly connected to the spectrum analyzer and antenna output port as show in the block diagram above.
- (2) Spectrum Setting:
 RBW=100 KHz, VBW=300 KHz.
 Frequency range: from 30MHz to 25 GHz

10.4 EUT Operating Condition

The EUT was set to continuously transmitting in the max power during the test.

10.5 Test Equipment

Description	Manufacturer	Model No.	Serial No.	Cal. Date	Cal. Due Date
Spectrum Analyzer	ROHDE& SCHWARZ	FSP30	DE25181	2012-12-31	2013-12-30

10.6 Test Data

TX CH 00 2402MHz (1 Mbps)

Above 1 GHz

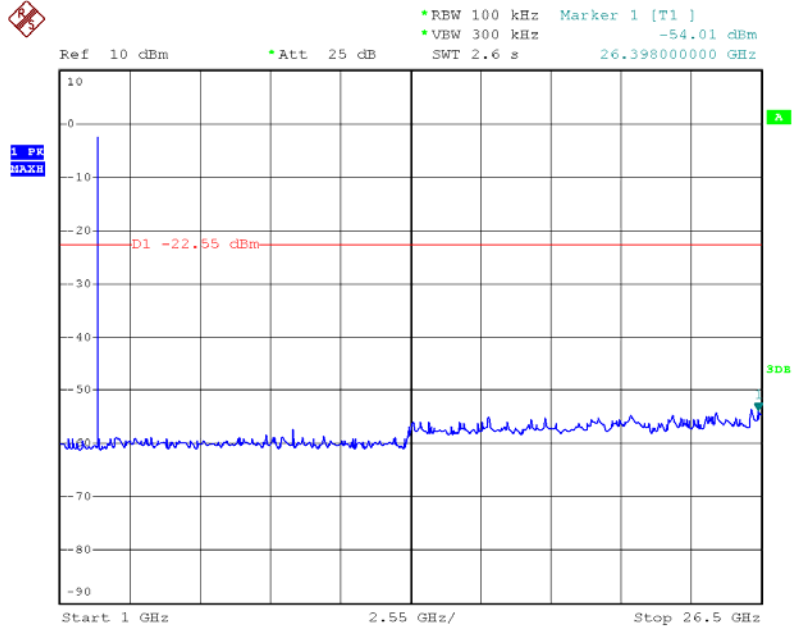

Date: 9.DEC.2013 16:23:08

Bellow 1 GHz

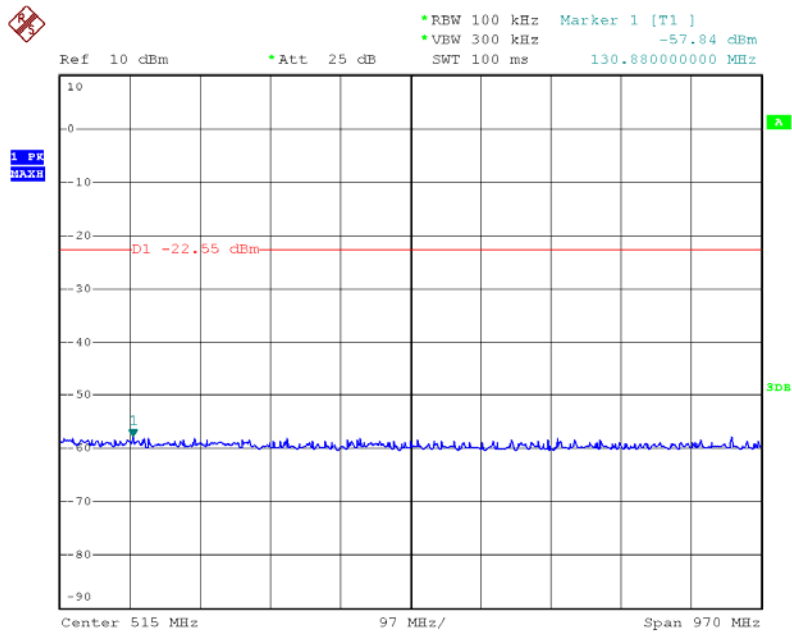

Date: 9.DEC.2013 10:50:34

TX CH 39 2441MHz (1 Mbps)

Above 1 GHz

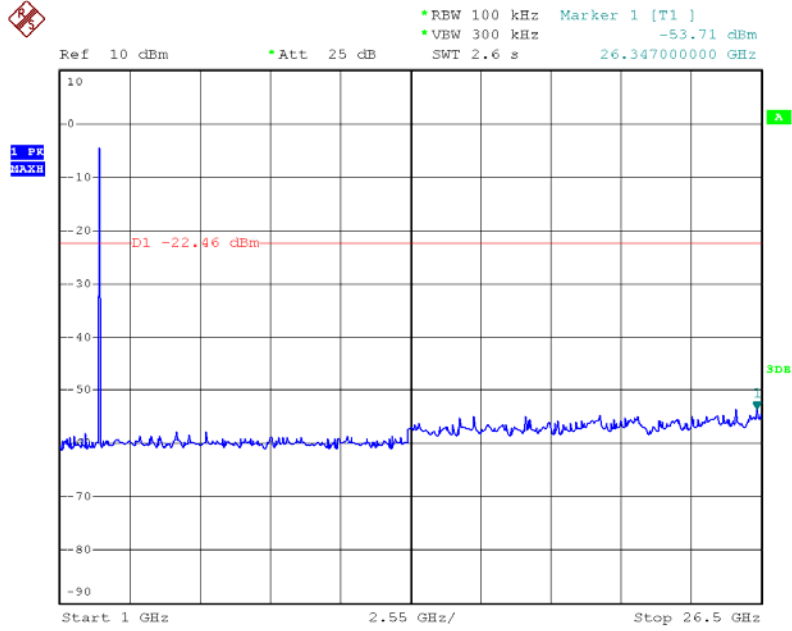

Date: 9.DEC.2013 16:24:34

Bellow 1 GHz

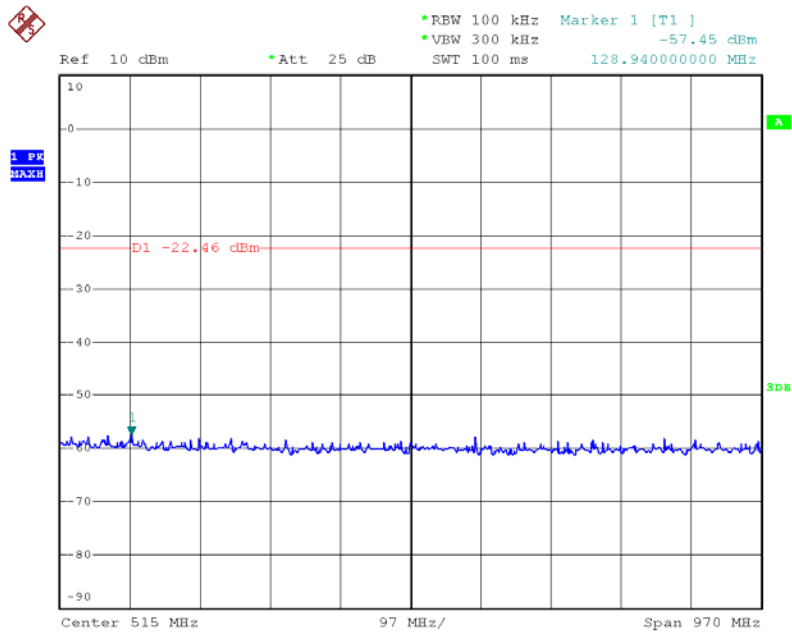

Date: 9.DEC.2013 10:51:06

TX CH 78 2480MHz (1 Mbps)

Above 1 GHz

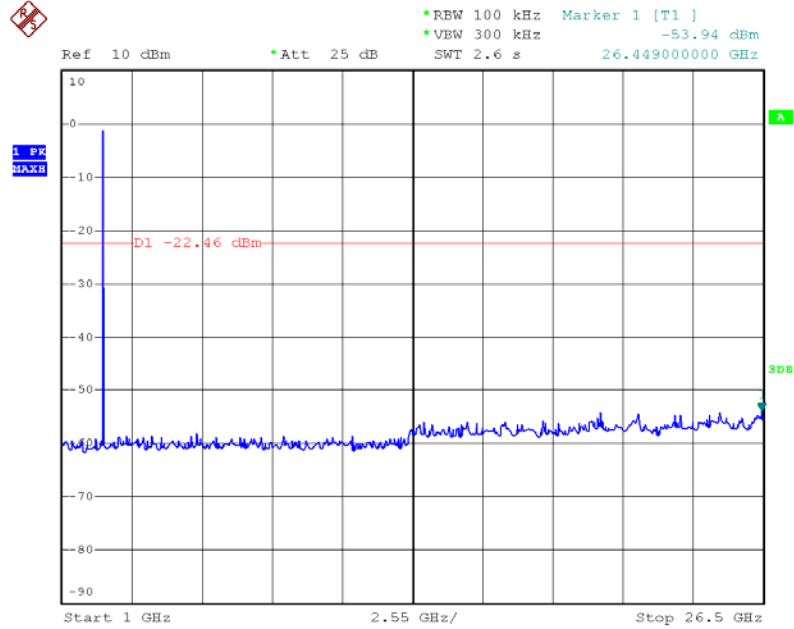

Date: 9.DEC.2013 16:26:16

Bellow 1 GHz

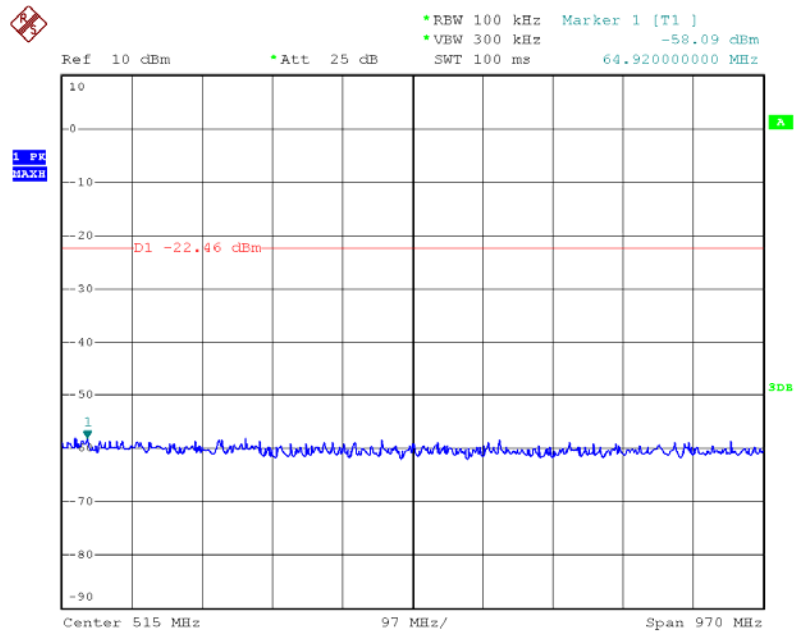

Date: 9.DEC.2013 10:51:27

TX CH 00 2402MHz (3 Mbps)

Above 1 GHz

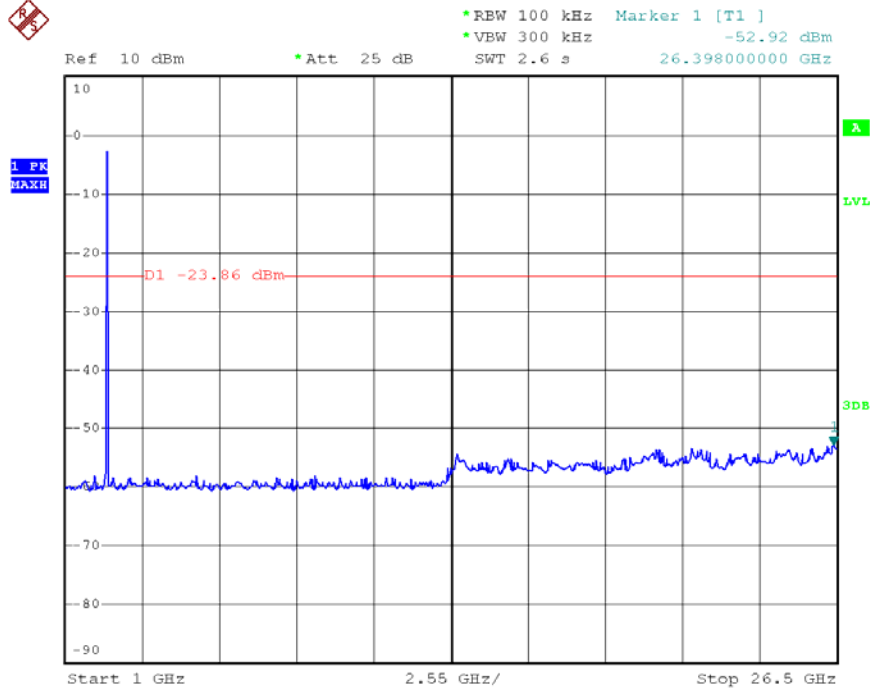

Date: 9.DEC.2013 11:28:38

Bellow 1 GHz

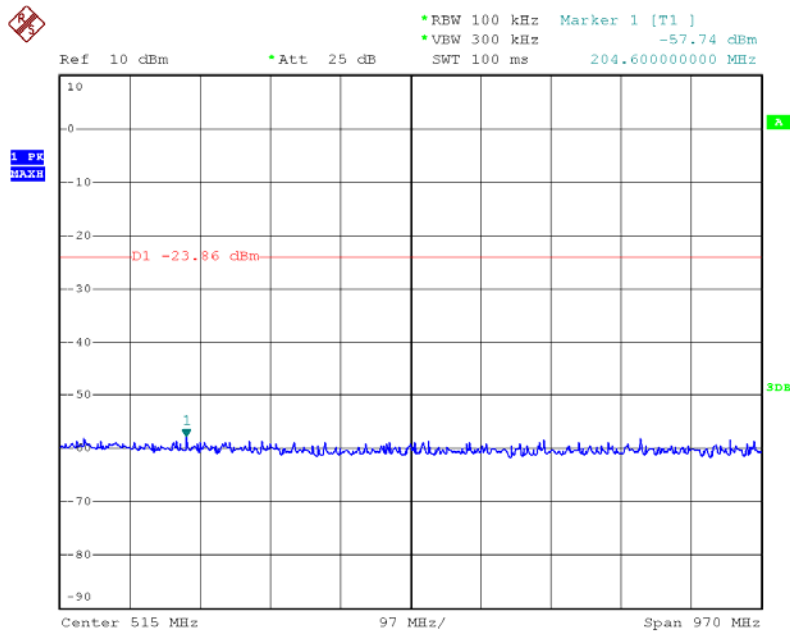

Date: 9.DEC.2013 10:51:46

TX CH 39 2441MHz (3 Mbps)

Above 1 GHz

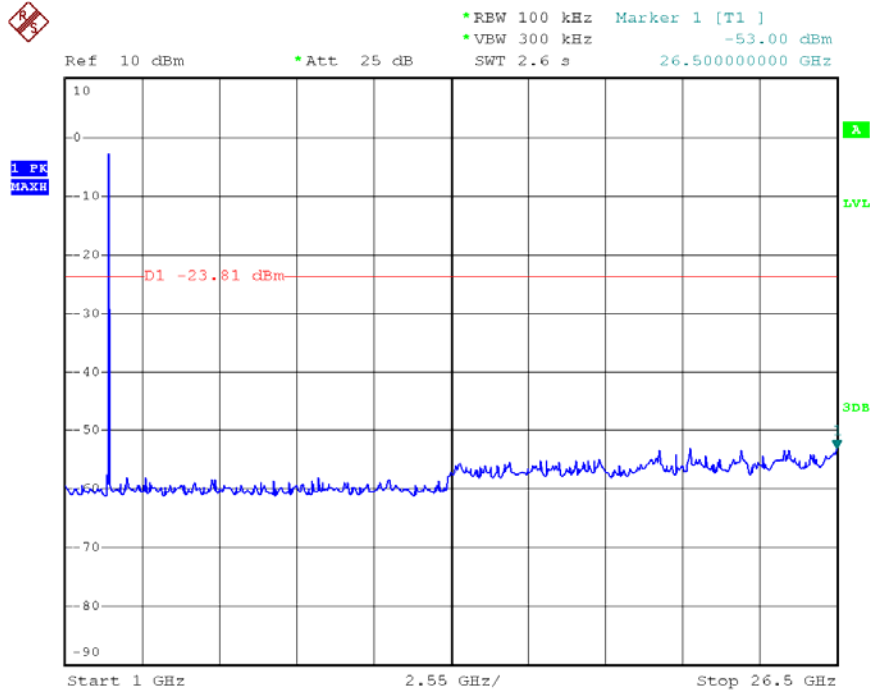

Date: 9.DEC.2013 11:31:36

Bellow 1 GHz

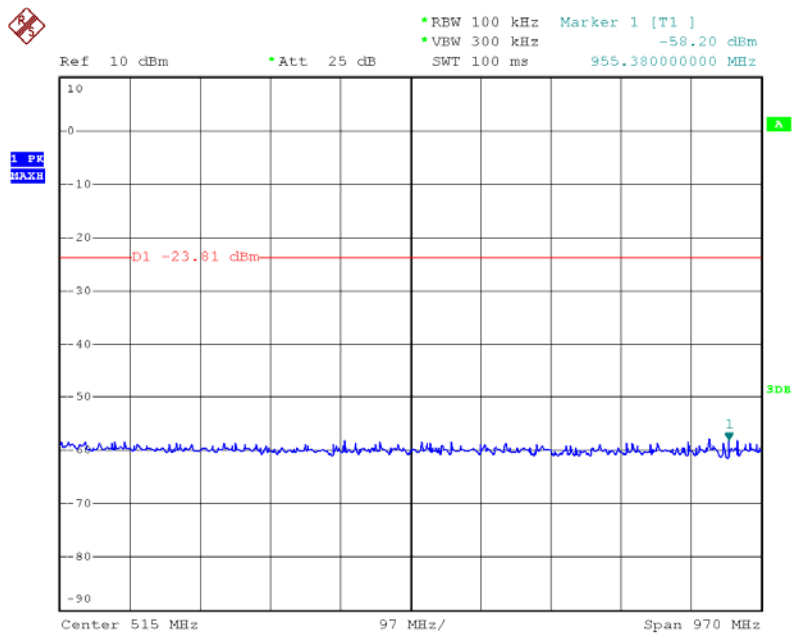

Date: 9.DEC.2013 10:52:21

TX CH 78 2480MHz (3 Mbps)

Above 1 GHz

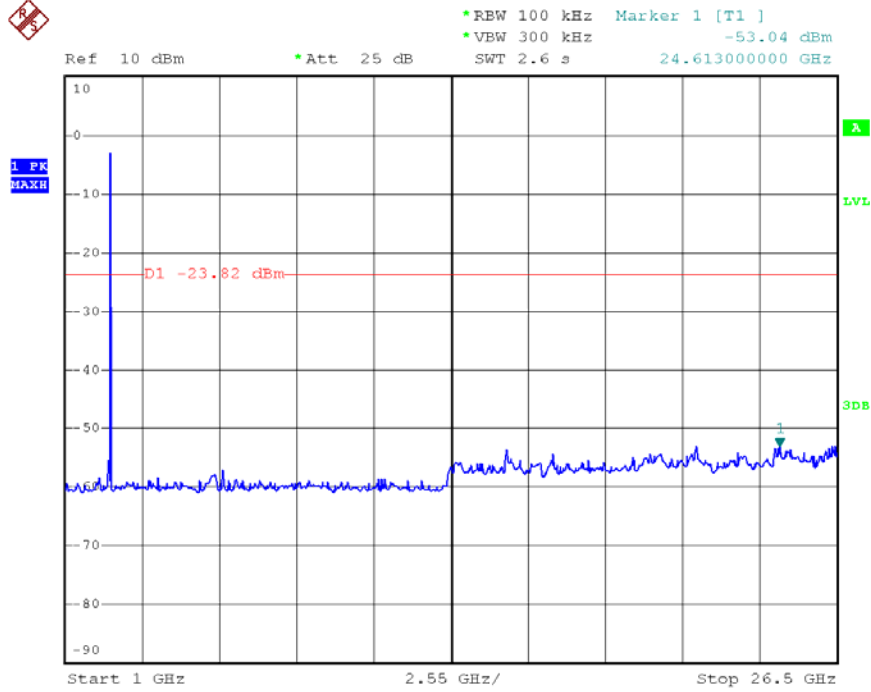

Date: 9.DEC.2013 11:38:51

Bellow 1 GHz

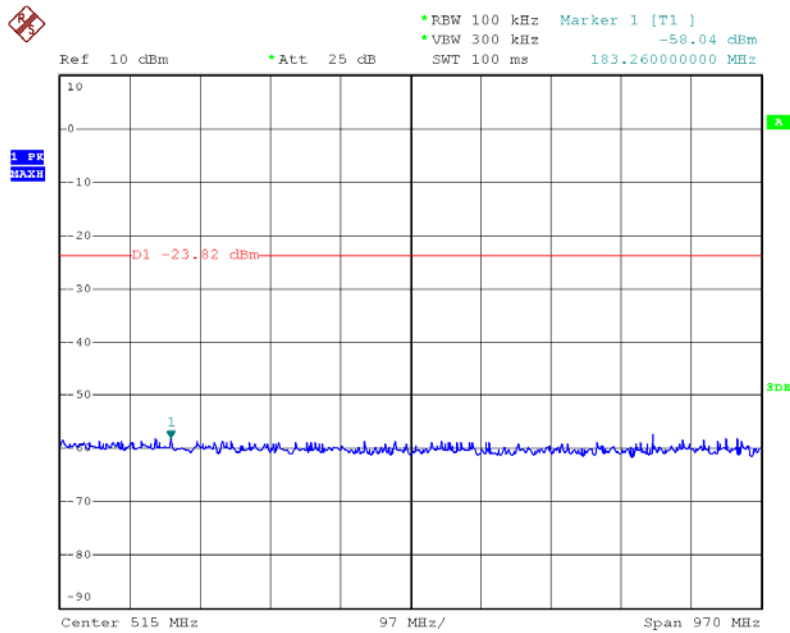

Date: 9.DEC.2013 10:52:43

11. Antenna Requirement

11.1 Standard Requirement

11.1.1 Standard

FCC Part 15.203

11.1.2 Requirement

An intentional radiator shall be designed to ensure that no antenna other than that furnished by the responsible party shall be used with the device. The use of a permanently attached antenna or of an antenna that uses a unique coupling to the intentional radiator shall be considered sufficient to comply with the provisions of this Section. The manufacturer may design the unit so that a broken antenna can be replaced by the user, but the use of a standard antenna jack or electrical connector is prohibited.

11.2 Antenna Connected Construction

The directional gains of the antenna used for transmitting is 0 dBi, and the antenna connector is de-signed with permanent attachment and no consideration of replacement. Please see the EUT photo for details.

11.2 Result

The EUT antenna is a PCB Antenna. It complies with the standard requirement.