



FURRION

Furrion Ltd. (Furrion) is a wholly owned subsidiary of Lippert Components, Inc. (Lippert)

Furrion Innovation Center & Institute of Technology

- 22244 Innovation Drive, Elkhart, IN 46514-5514, USA
- Toll free: 1-800-789-3341
- Email: support@furrion.com

©2007-2023 Furrion Ltd. Furrion® and the Furrion logo are trademarks licensed for use by Furrion Ltd. and registered in the U.S. and other countries.

For Patent Info: www.Lippert.com/patentsFurrion.com



The contents of this manual are proprietary and copyright protected by Lippert. Lippert prohibits the copying or dissemination of portions of this manual unless prior written consent from an authorized Lippert representative has been provided. Any unauthorized use shall void any applicable warranty. The information contained in this manual is subject to change without notice and at the sole discretion of Lippert. Revised editions are available for free download from lippert.com.

Please recycle all obsolete materials.

For all concerns or questions, please contact Lippert.

Ph: 432-LIPPERT (432-547-7378) | Web: lippert.com | Email: customerservice@lci1.com

CCO-0007726 | REV DATE: 4.4.23

This quick start guide will help you install and use the device properly. For further support and to download the complete user manual please visit <https://support.lci1.com/stereo-subwoofers-soundbars>.

WHAT'S IN THE BOX

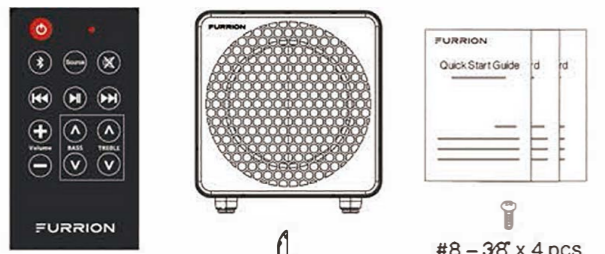

#8 - 3/8" x 4 pcs

#10 - 3/8" x 2 pcs



NOTE: Product design and packaging may change without notice.

2. Mount on wall

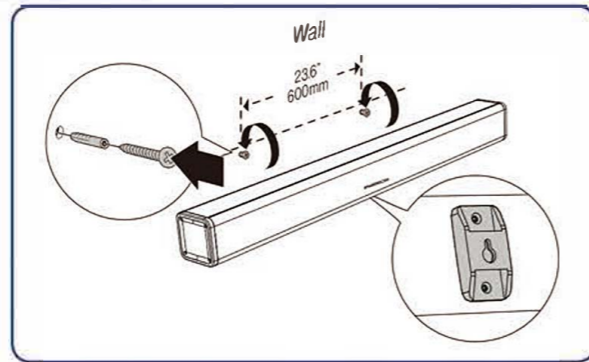

CONNECT POWER

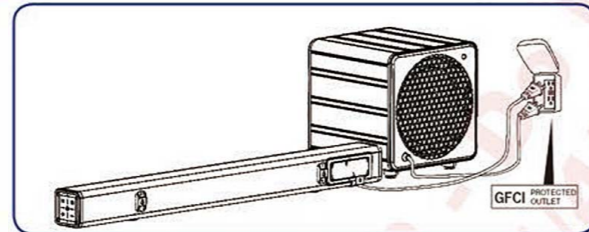

INSTALL REMOTE CONTROL BATTERY



BASIC OPERATION

Soundbar Buttons

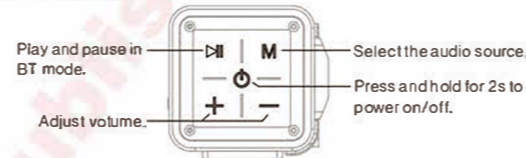

Soundbar Remote Control Operation

Remote Control Button	Function
	Power on/off.
	Short press to switch the source mode to Bluetooth; Press and hold it for 3s to unpair and launch pairing again. (BT Name: Furrion SB 2.0/ Furrion SB 2.1)
Source	Select the audio source (OPT. HDMI, AUX, BLUE).
	Mute or un-mute the audio output.
	Skip to the previous track in BT mode.
	Start or pause playback in BT mode.
	Skip to the next track in BT mode.
	Adjust volume.
BASS/TREBLE	Adjust the EQ balance of treble and bass

Tip: See the complete user manual online for detailed functional explanation.

TV Remote Control Operation

When the Soundbar is connected to the TV via HDMI, the TV remote may be used to control the soundbar. TV remotes differ based on brand and model, but general functionality is based on buttons found on most remotes.

- Power Button - Turns soundbar on/off with TV.
- Volume UP/DOWN - Adjusts the soundbar volume
- Mute - Mutes or unmutes the audio output.

FURRION

Aurora Bluetooth Sound Bar with Subwoofer



Quick Start Guide

Lippert Number:2022323660



<https://support.lci1.com/stereo-subwoofers-soundbars>

* To view the multi-language user manual, please access the link or scan the QR code.

* Pour obtenir le manuel d'utilisateur multilingue, accédez au lien ou scannez le QR code.

* Para ver el manual de usuario en otros idiomas, acceda al siguiente enlace o escanee el código QR.

FCC Statement

Changes or modifications not expressly approved by the party responsible for compliance could void the user's authority to operate the equipment.

This equipment has been tested and found to comply with the limits for a Class B digital device, pursuant to Part 15 of the FCC Rules. These limits are designed to provide reasonable protection against harmful interference in a residential installation. This equipment generates, uses, and can radiate radio frequency energy and, if not installed and used in accordance with the instructions, may cause harmful interference to radio communications. However, there is no guarantee that interference will not occur in a particular installation. If this equipment does cause harmful interference to radio or television reception, which can be determined by turning the equipment off and on, the user is encouraged to try to correct the interference by one or more of the following measures:

- Reorient or relocate the receiving antenna.
- Increase the separation between the equipment and receiver.
- Connect the equipment into an outlet on a circuit different from that to which the receiver is connected.
- Consult the dealer or an experienced radio/TV technician for help.

This device complies with part 15 of the FCC rules. Operation is subject to the following two conditions: (1) this device may not cause harmful interference, and (2) this device must accept any interference received, including interference that may cause undesired operation.

This equipment complies with FCC radiation exposure limits set forth for an uncontrolled environment. This equipment should be installed and operated with minimum distance 20cm between the radiator & your body.

CONNECT

- Open the protective cover on the back by removing the screws then connect the cables.

Note: All external devices and cables shown in the diagram are for reference only and not included in the package.

1. Connect Soundbar with TV and Subwoofer

- Power on the soundbar by plugging it in and pressing the power button on the soundbar or on the remote.
- Power on the Subwoofer by plugging it in.
- Subwoofer will auto pair to the soundbar. Indicator light on the front of the Subwoofer will illuminate RED. Pairing begins when the Indicator light begins flashing BLUE. Pairing is complete when the Indicator Light illuminates solid BLUE.

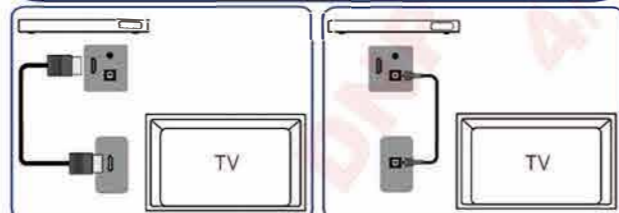
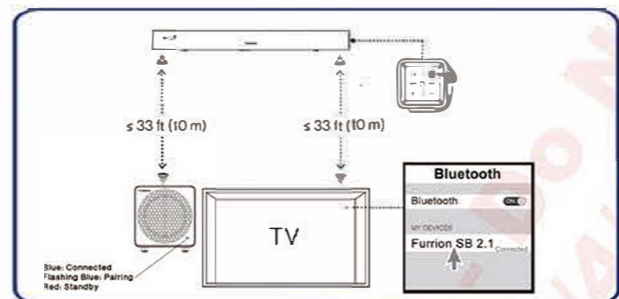

2. Connect Soundbar with other devices

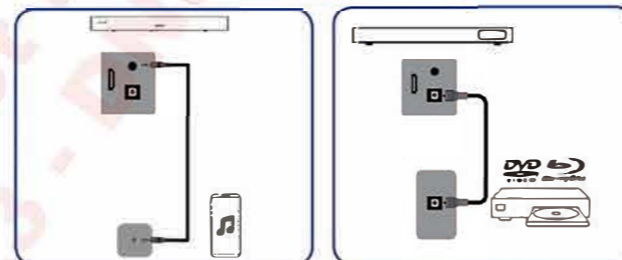
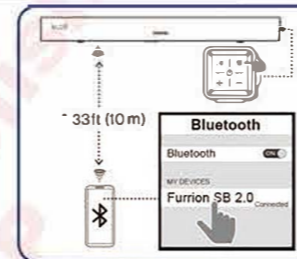

- After the connections are completed, close the protective cover and tighten the screws for the best weatherproof effect.

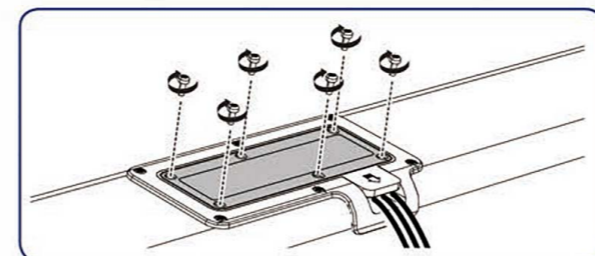

INSTALL

IMPORTANT: Before final installation, check by powering the Soundbar on to make sure the unit operates properly.

1. Install Soundbar to the compatible Furrion Aurora™ TV

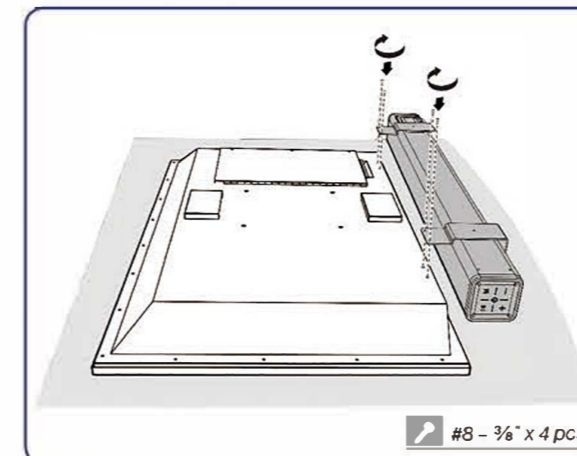
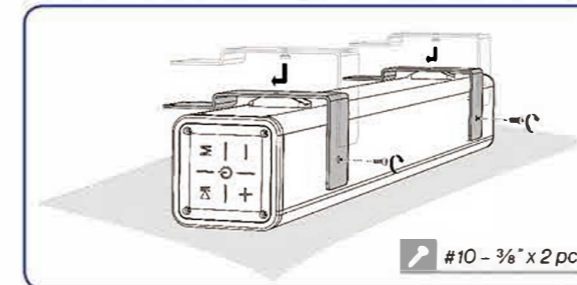

CCO-0007726

IC Statement

This device contains licence exempt transmitter(s)/receiver(s) that comply with Innovation, Science and Economic Development Canada's licence exempt RSS(s). Operation is subject to the following two conditions:

- (1) This device may not cause interference.
- (2) This device must accept any interference, including interference that may cause undesired operation of the device.

The term IC: before the certification/registration number only signifies that the Industry Canada technical specifications were met.

This product meets the applicable Industry Canada technical specifications. Cet appareil contient des émetteurs / récepteurs exempts de licence conformes aux RSS (RSS) d'Innovation, Sciences et Développement économique Canada. L'exploitation n'est autorisée aux deux conditions suivantes: (1) l'appareil ne doit pas produire de brouillage, et (2) l'utilisateur de l'appareil doit accepter tout brouillage radioélectrique subi, même si le brouillage est susceptible d'en compromettre le fonctionnement.

L'émetteur/récepteur exempt de licence contenu dans le présent appareil est conforme aux CNR d'Innovation, Sciences et Développement économique Canada applicables aux appareils radio exempts de licence. L'exploitation est autorisée aux deux conditions suivantes:

- 1) L'appareil ne doit pas produire de brouillage;
- 2) L'appareil doit accepter tout brouillage radioélectrique subi, même si le brouillage est susceptible d'en compromettre le fonctionnement.

This transmitter must not be co-located or operating in conjunction with any other antenna or transmitter. This equipment should be installed and operated with a minimum distance of 20 centimeters between the radiator and your body. Cet émetteur ne doit pas être co-placé ou fonctionner en même temps qu'aucune autre antenne ou émetteur. Cet équipement devrait être installé et actionné avec une distance minimum de 20 centimètres entre le radiateur et votre corps.