

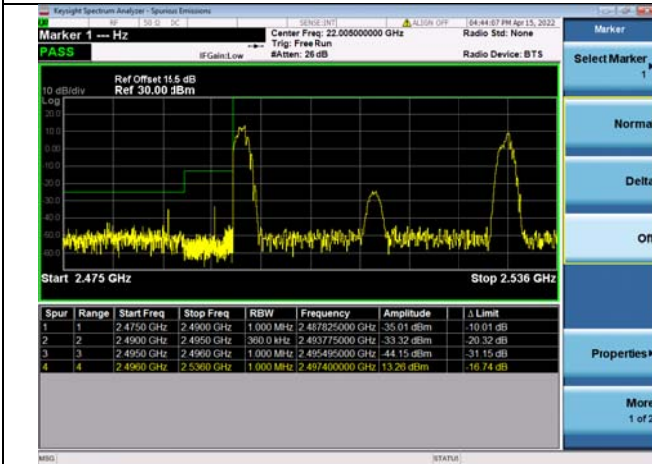

LTE CA 41C

Channel Bandwidth: 20MHz+15MHz

Low 1RB0 and 1RB74



High 1RB0 and 1RB74

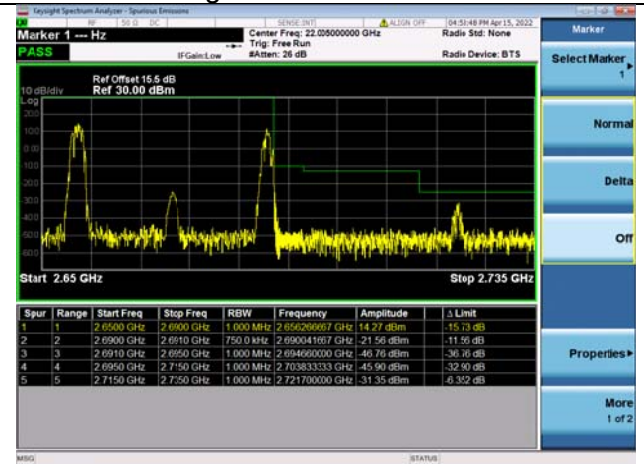

Low 1RB99 and 1RB0

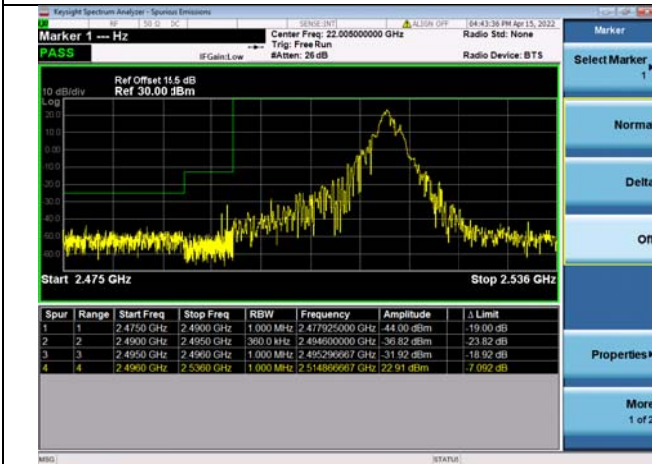

High 1RB99 and 1RB0

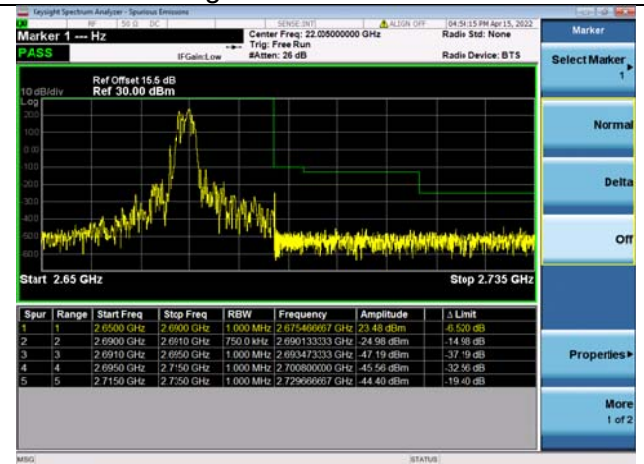

Low FULL RB

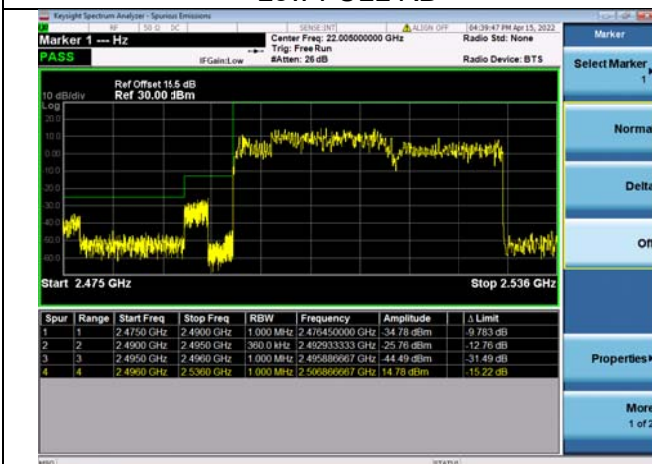

High FULL RB





LTE CA 41C

Channel Bandwidth: 20MHz+20MHz

Low 1RB0 and 1RB99

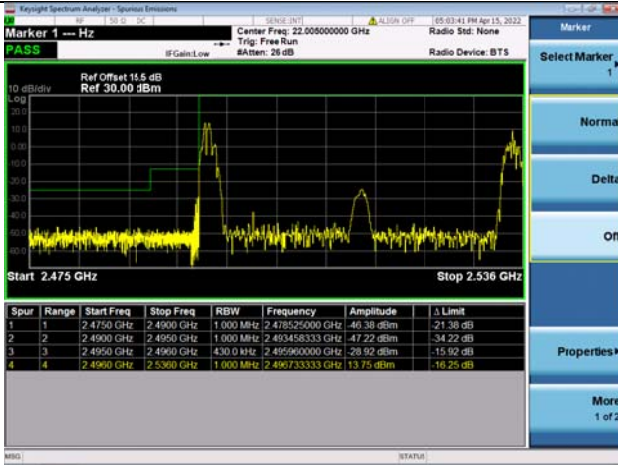

High 1RB0 and 1RB99

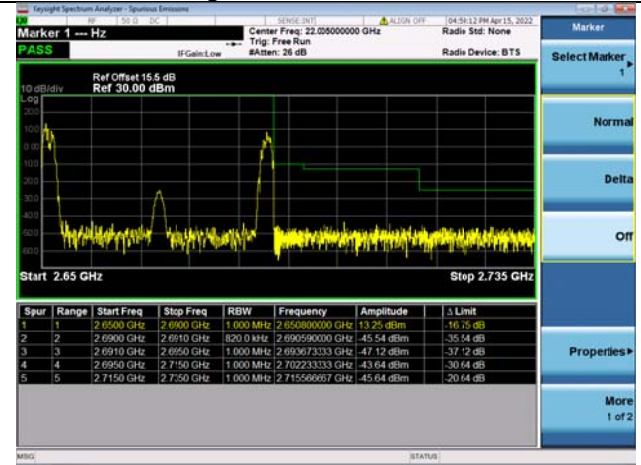

Low 1RB99 and 1RB0

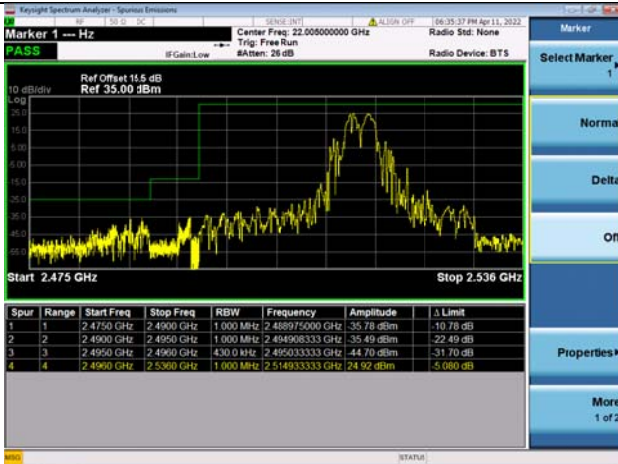

High 1RB99 and 1RB0

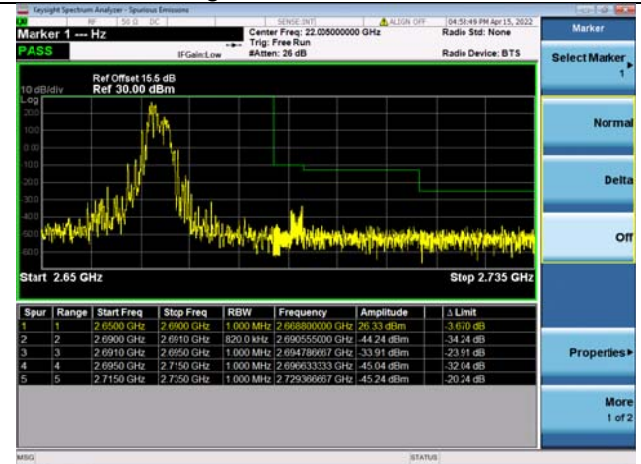

Low FULL RB

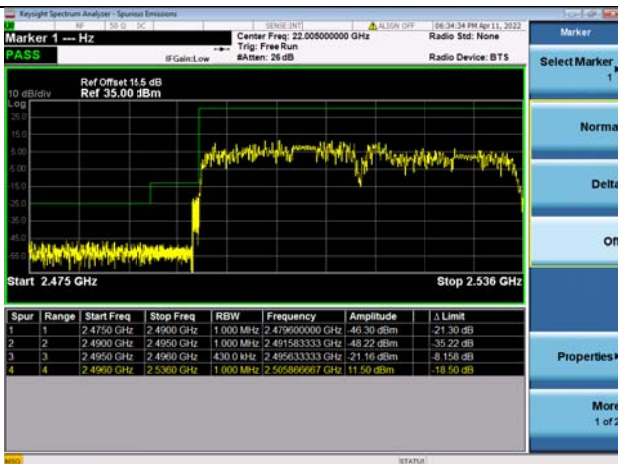

High FULL RB

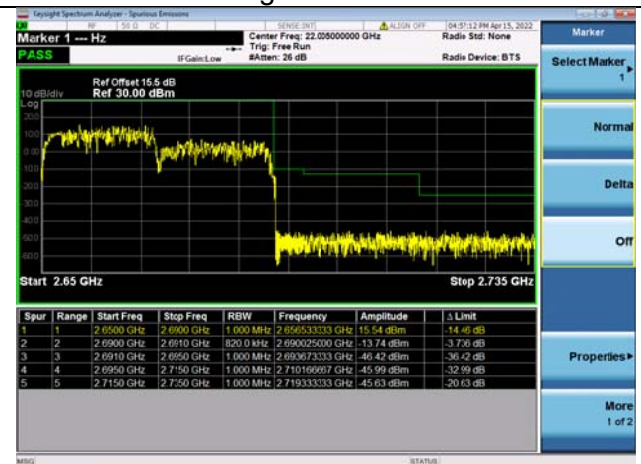

## 2.5. Radiated Spurious Emissions

### 2.5.1. Requirement

According to FCC section 2.1051, the power of any emission outside of the authorized operating frequency ranges must be attenuated below the transmitting power (P) by a factor of at least  $43+10\log(P)$ dB. This calculated to be -13dBm.

Additional requirement for LTE Band 41: The power of any emission outside of the authorized operating frequency ranges must be attenuated below the transmitting power (P) by a factor of at least  $55 + 10 \log(P)$  dB. This calculated to be -25dBm.

### 2.5.2. Test Description

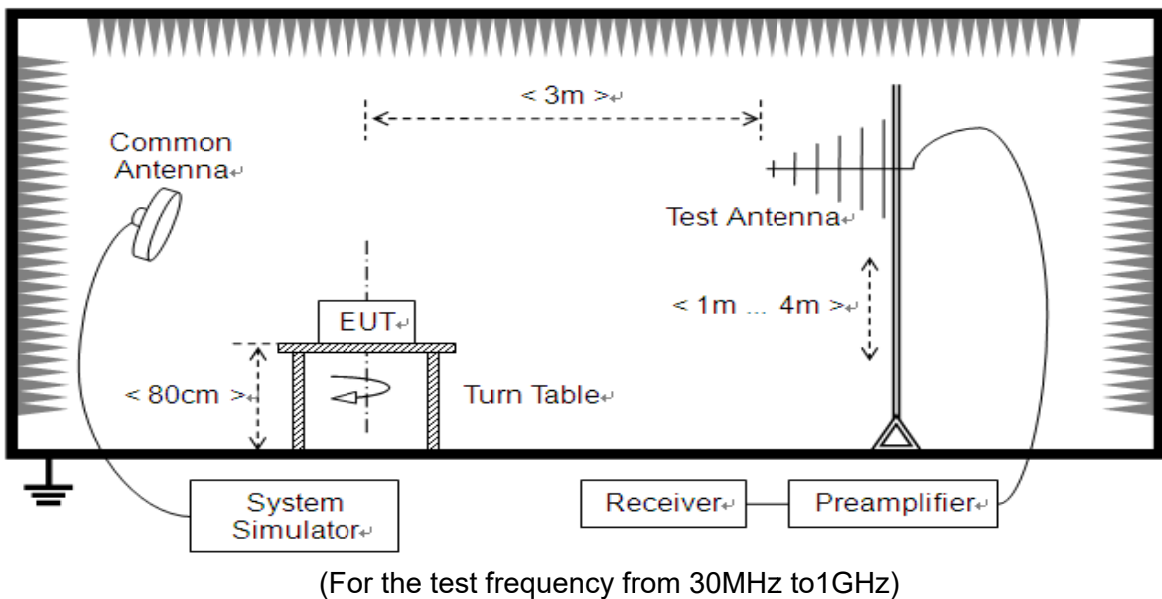

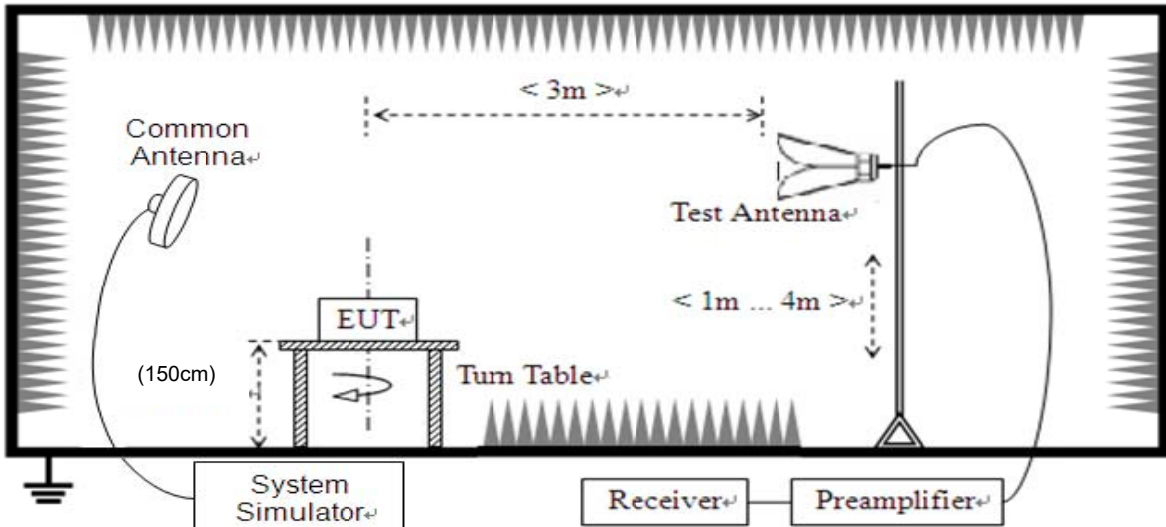

(For the test frequency above 1GHz)

The EUT is located in a 3m Full-Anechoic Chamber, the cable loss, air loss and so on of the site as factors are pre-calibrated using the "Substitution" method, and calculated to correct the reading.

A call is established between the EUT and the SS via a Common Antenna. The EUT is commanded by the SS to operate at the maximum and minimum output power, and only the test result of the maximum output power was recorded.

In the frequency range above 30MHz, Bi-Log Test Antenna (30MHz to 1GHz) and Horn Test Antenna (above 1GHz) are used. Test Antenna is 3m away from the EUT. Test Antenna height is varied from 1m to 4m above the ground and the Turn Table is actuated to turn from 0° to 360° to determine the maximum value of the radiated power. The emission levels at both horizontal and vertical polarizations should be tested. The Filters consists of Notch Filters and High Pass Filter.

**Note:** when doing measurements above 1GHz, the EUT has been within the 3dB cone width of the horn antenna during horizontal antenna.

### 2.5.3. Test procedure

KDB 971168 D01v03 Section 5.8 and ANSI/TIA-603-E-2016.



## 2.5.4. Test Result

The measurement frequency range is from 30MHz to the 10th harmonic of the fundamental frequency. Test Antenna height is varied from 1m to 4m above the ground, and the Turn Table is actuated to turn from 0° to 360°, both horizontal and vertical polarizations of the Test Antenna are used to find the maximum radiated power. Mid channels on all channel bandwidth verified. Only the worst RB size/offset presented.

The substitution corrections are obtained as described below:

$$A_{\text{SUBST}} = P_{\text{SUBST\_TX}} - P_{\text{SUBST\_RX}} - L_{\text{SUBST\_CABLES}} + G_{\text{SUBST\_TX\_ANT}}$$

$$A_{\text{TOT}} = L_{\text{CABLES}} + A_{\text{SUBST}}$$

Where  $A_{\text{SUBST}}$  is the final substitution correction including receive antenna gain.

$P_{\text{SUBST\_TX}}$  is signal generator level,

$P_{\text{SUBST\_RX}}$  is receiver level,

$L_{\text{SUBST\_CABLES}}$  is cable losses including TX cable,

$G_{\text{SUBST\_TX\_ANT}}$  is substitution antenna gain.

$A_{\text{TOT}}$  is total correction factor including cable loss and substitution correction

During the test, the data of  $A_{\text{TOT}}$  was added in the Test Spectrum Analyze, so Spectrum Analyze reading is the final values which contain the data of  $A_{\text{TOT}}$ .

**Note1:** The power of the EUT transmitting frequency should be ignored.

**Note2:** All Spurious Emission tests were performed in X, Y, Z axis direction. And only the worst axis test condition was recorded in this test report.

**Note3:** All bandwidth and test channel were considered and evaluated respectively by performing full test for each band, only the worst cases were recorded in this test report.

### Test Graph

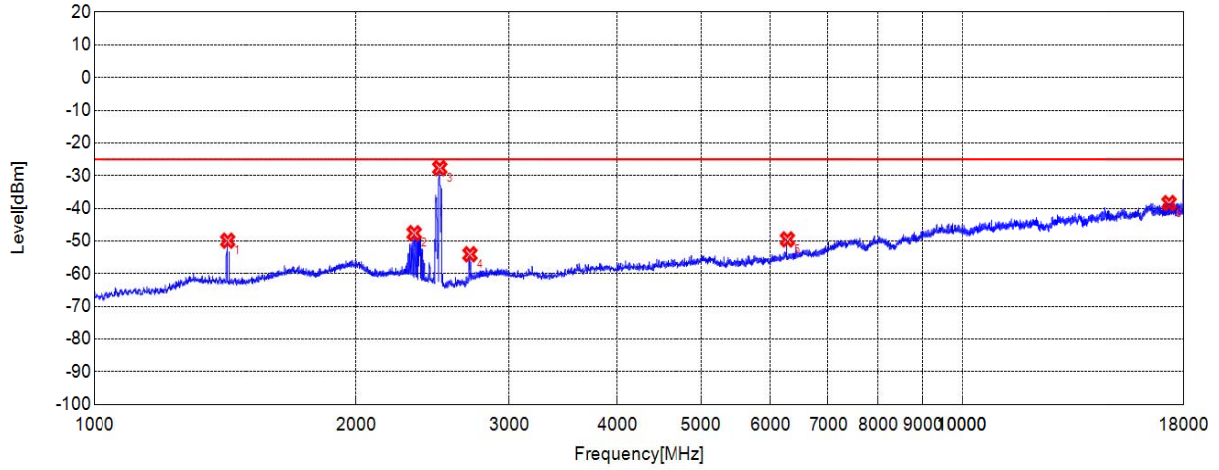

✱ Final Test

Suspected List								
NO.	Freq. [MHz]	Level [dBm]	Limit [dBm]	Margin [dB]	Factor [dB]	Path [dB]	Air [dB]	Ant. Pol.
1	1422.8080	-49.9	-25.00	24.90	-12.06	-48.76	36.70	Horizontal
2	2337.7790	-47.62	-25.00	22.62	-9.26	-47.79	38.53	Horizontal
3	2500.5000	-27.69	-25.00	2.69	-10.96	-47.64	36.68	NA
4	2707.2360	-54.05	-25.00	29.05	-10.35	-47.72	37.37	Horizontal
5	6275.5460	-49.51	-25.00	24.51	0.94	-41.10	42.04	Horizontal
6	17322.3870	-38.4	-25.00	13.40	22.82	-28.65	51.47	Horizontal

CA\_41C Low 20M QPSK PCC RB 1 0 SCC RB 0 0 1-18G H

### Test Graph

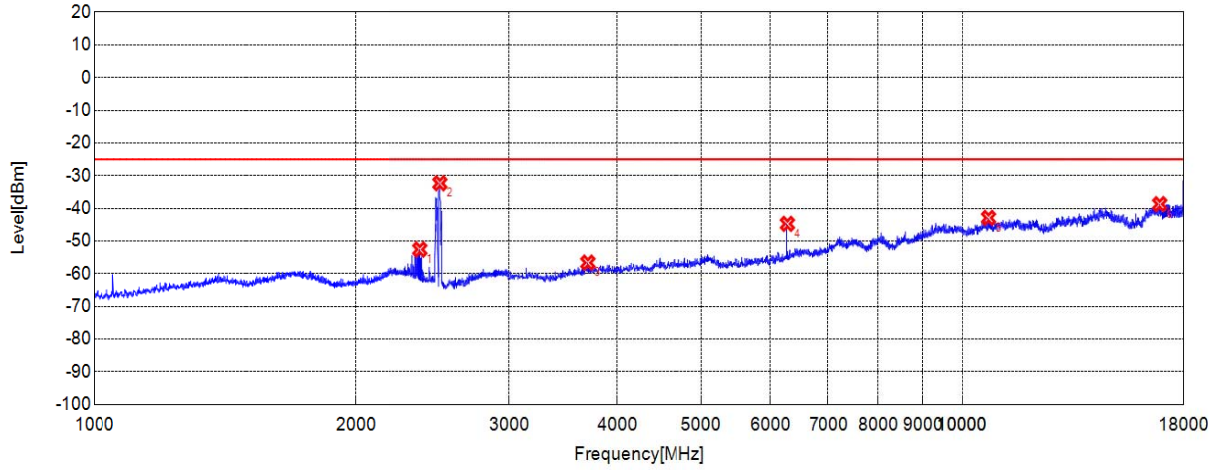

✖ Final Test

Suspected List								
NO.	Freq. [MHz]	Level [dBm]	Limit [dBm]	Margin [dB]	Factor [dB]	Path [dB]	Air [dB]	Ant. Pol.
1	2372.4570	-52.59	-25.00	27.59	-10.07	-47.73	37.66	Vertical
2	2501.1670	-32.34	-25.00	7.34	-11.10	-47.64	36.54	NA
3	3702.6170	-56.62	-25.00	31.62	-6.64	-45.71	39.07	Vertical
4	6275.5460	-44.75	-25.00	19.75	0.84	-41.10	41.94	Vertical
5	10721.2870	-42.93	-25.00	17.93	13.01	-35.79	48.80	Vertical
6	16902.3170	-38.73	-25.00	13.73	22.37	-29.39	51.76	Vertical

CA\_41C Low 20M QPSK PCC RB 1 0 SCC RB 0 0 1-18G V

### Test Graph

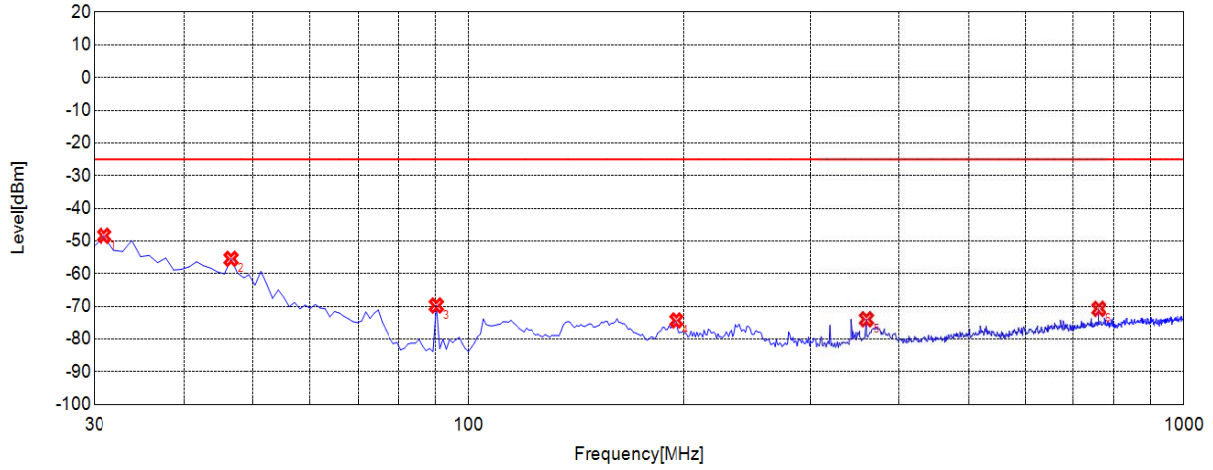

✧ Final Test

Suspected List								
NO.	Freq. [MHz]	Level [dBm]	Limit [dBm]	Margin [dB]	Factor [dB]	Path [dB]	Air [dB]	Ant. Pol.
1	30.9710	-48.38	-25.00	23.38	-14.15	-42.64	28.49	Horizontal
2	46.5070	-55.45	-25.00	30.45	-10.04	-42.50	32.46	Horizontal
3	90.2000	-69.74	-25.00	44.74	-22.79	-42.58	19.79	Horizontal
4	195.0650	-74.3	-25.00	49.30	-19.68	-42.80	23.12	Horizontal
5	360.1300	-73.93	-25.00	48.93	-16.48	-41.88	25.40	Horizontal
6	760.1700	-70.76	-25.00	45.76	-8.77	-40.49	31.72	Horizontal

CA\_41C Low 20M QPSK PCC RB 1 0 SCC RB 0 0 30M-1G H



# Test Graph

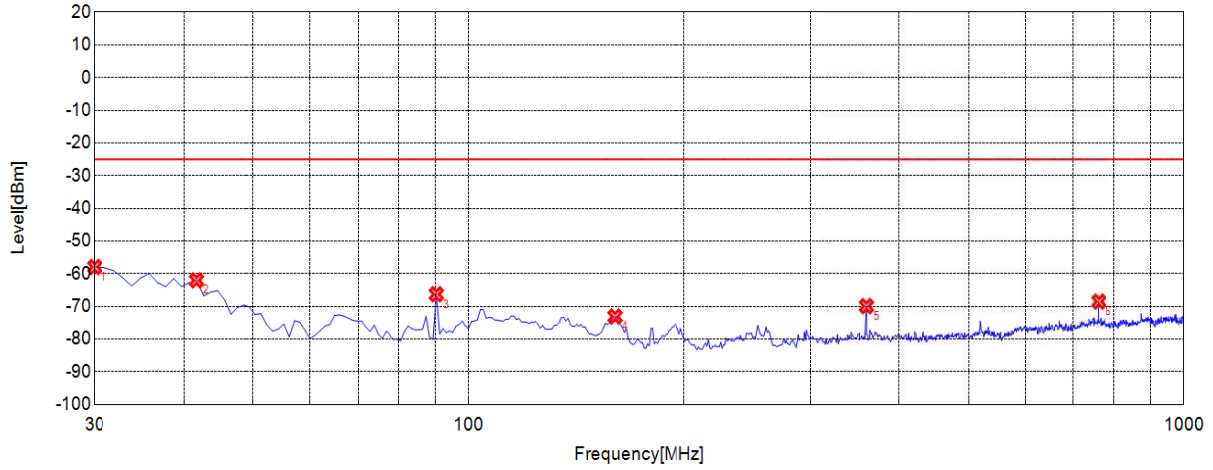

✘ Final Test

Suspected List								
NO.	Freq. [MHz]	Level [dBm]	Limit [dBm]	Margin [dB]	Factor [dB]	Path [dB]	Air [dB]	Ant. Pol.
1	30.0000	-57.94	-25.00	32.94	-20.03	-42.62	22.59	Vertical
2	41.6520	-62.04	-25.00	37.04	-19.16	-42.55	23.39	Vertical
3	90.2000	-66.29	-25.00	41.29	-20.37	-42.58	22.21	Vertical
4	160.1100	-73.11	-25.00	48.11	-21.39	-42.82	21.43	Vertical
5	360.1300	-69.92	-25.00	44.92	-16.03	-41.88	25.85	Vertical
6	760.1700	-68.53	-25.00	43.53	-8.58	-40.49	31.91	Vertical

CA\_41C Low 20M QPSK PCC RB 1 0 SCC RB 0 0 30M-1G V

### Test Graph

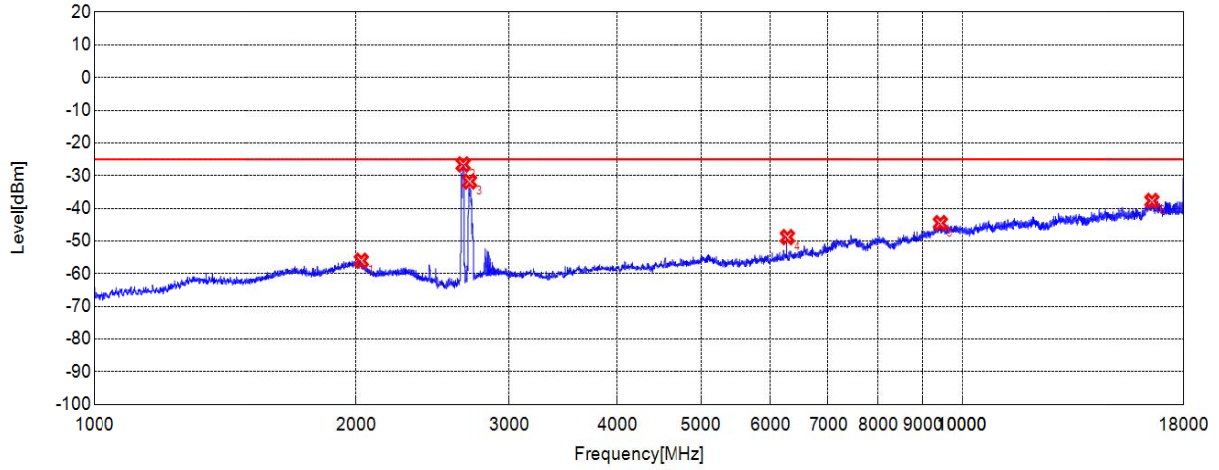

⊗ Final Test

Suspected List								
NO.	Freq. [MHz]	Level [dBm]	Limit [dBm]	Margin [dB]	Factor [dB]	Path [dB]	Air [dB]	Ant. Pol.
1	2027.6760	-56.03	-25.00	31.03	-6.61	-47.75	41.14	Horizontal
2	2659.2200	-26.58	-25.00	1.58	-10.58	-47.72	37.14	NA
3	2703.9010	-31.8	-25.00	6.80	-10.39	-47.73	37.34	Horizontal
4	6275.5460	-48.81	-25.00	23.81	0.94	-41.10	42.04	Horizontal
5	9431.0720	-44.52	-25.00	19.52	11.60	-37.17	48.77	Horizontal
6	16562.2600	-37.74	-25.00	12.74	22.44	-29.14	51.58	Horizontal

CA\_41C High 20M QPSK PCC RB 1 0 SCC RB 0 0 1-18G H

### Test Graph

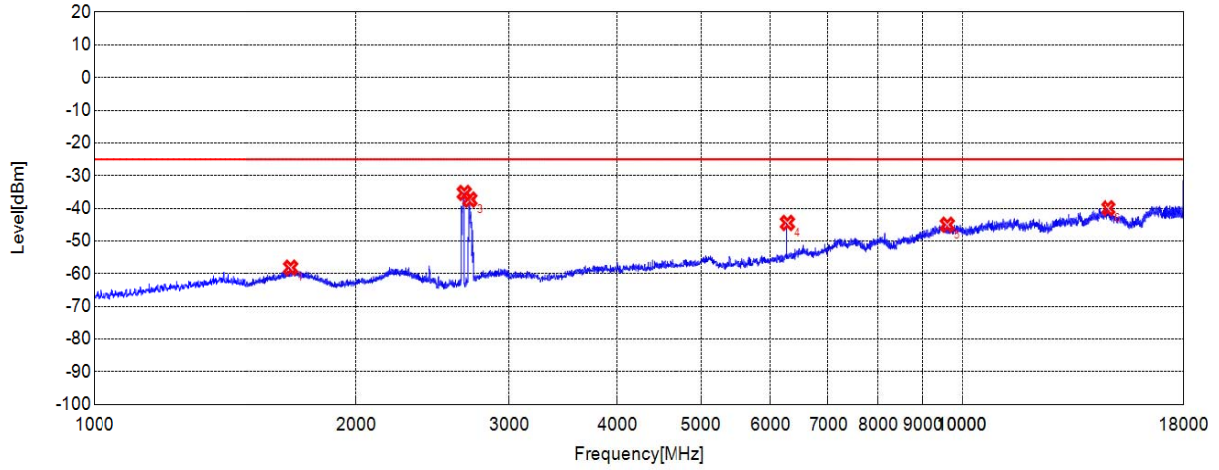

⊗ Final Test

Suspected List								
NO.	Freq. [MHz]	Level [dBm]	Limit [dBm]	Margin [dB]	Factor [dB]	Path [dB]	Air [dB]	Ant. Pol.
1	1684.2280	-58.17	-25.00	33.17	-9.82	-46.59	36.77	Vertical
2	2666.5560	-35.3	-25.00	10.30	-10.78	-47.73	36.95	NA
3	2706.5690	-37.33	-25.00	12.33	-10.62	-47.72	37.10	Vertical
4	6275.5460	-44.47	-25.00	19.47	0.84	-41.10	41.94	Vertical
5	9606.1010	-45.03	-25.00	20.03	11.24	-37.49	48.73	Vertical
6	14744.4570	-39.98	-25.00	14.98	19.17	-31.35	50.52	Vertical

CA\_41C High 20M QPSK PCC RB 1 0 SCC RB 0 0 1-18G V

### Test Graph

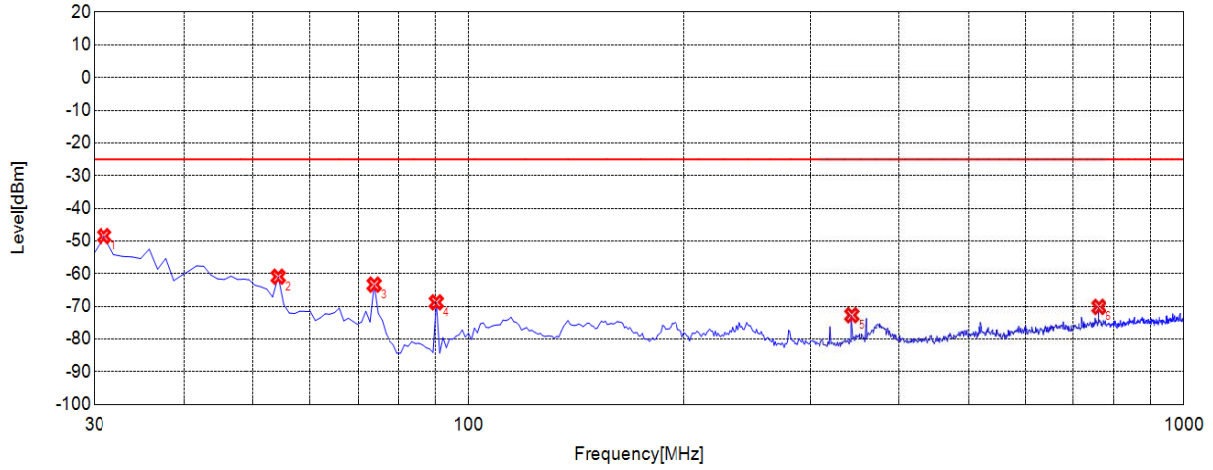

⊗ Final Test

Suspected List								
NO.	Freq. [MHz]	Level [dBm]	Limit [dBm]	Margin [dB]	Factor [dB]	Path [dB]	Air [dB]	Ant. Pol.
1	30.9710	-48.49	-25.00	23.49	-14.15	-42.64	28.49	Horizontal
2	54.2740	-60.92	-25.00	35.92	-11.59	-42.37	30.78	Horizontal
3	73.6940	-63.35	-25.00	38.35	-19.95	-42.46	22.51	Horizontal
4	90.2000	-68.77	-25.00	43.77	-22.79	-42.58	19.79	Horizontal
5	343.6240	-72.7	-25.00	47.70	-15.86	-41.86	26.00	Horizontal
6	760.1700	-70.17	-25.00	45.17	-8.77	-40.49	31.72	Horizontal

CA\_41C High 20M QPSK PCC RB 1 0 SCC RB 0 0 30M-1G H

### Test Graph

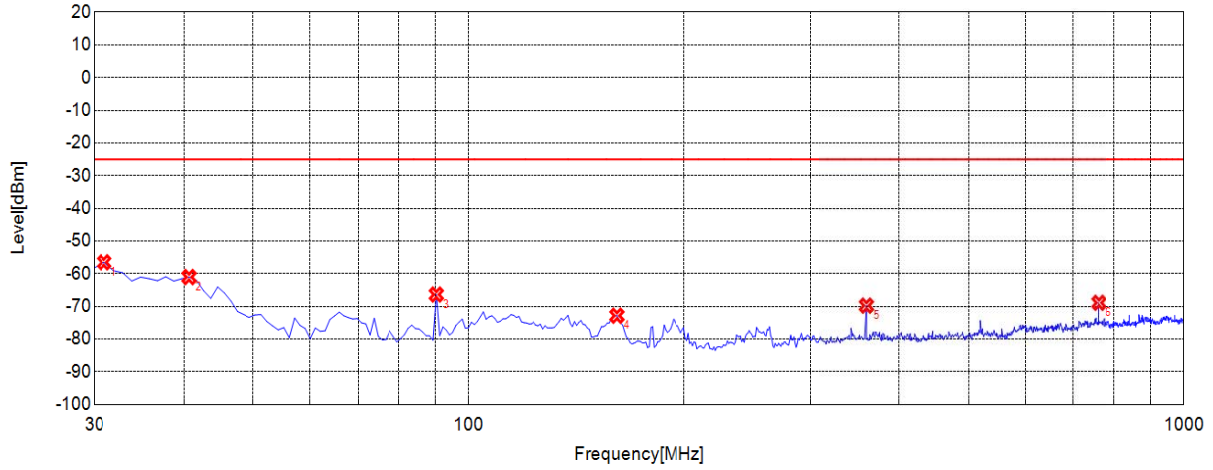

✧ Final Test

Suspected List								
NO.	Freq. [MHz]	Level [dBm]	Limit [dBm]	Margin [dB]	Factor [dB]	Path [dB]	Air [dB]	Ant. Pol.
1	30.9710	-56.52	-25.00	31.52	-19.99	-42.64	22.65	Vertical
2	40.6810	-61.03	-25.00	36.03	-19.29	-42.58	23.29	Vertical
3	90.2000	-66.37	-25.00	41.37	-20.37	-42.58	22.21	Vertical
4	161.0810	-72.86	-25.00	47.86	-21.45	-42.83	21.38	Vertical
5	360.1300	-69.77	-25.00	44.77	-16.03	-41.88	25.85	Vertical
6	760.1700	-68.9	-25.00	43.90	-8.58	-40.49	31.91	Vertical

CA\_41C High 20M QPSK PCC RB 1 0 SCC RB 0 0 30M-1G V

### Test Graph

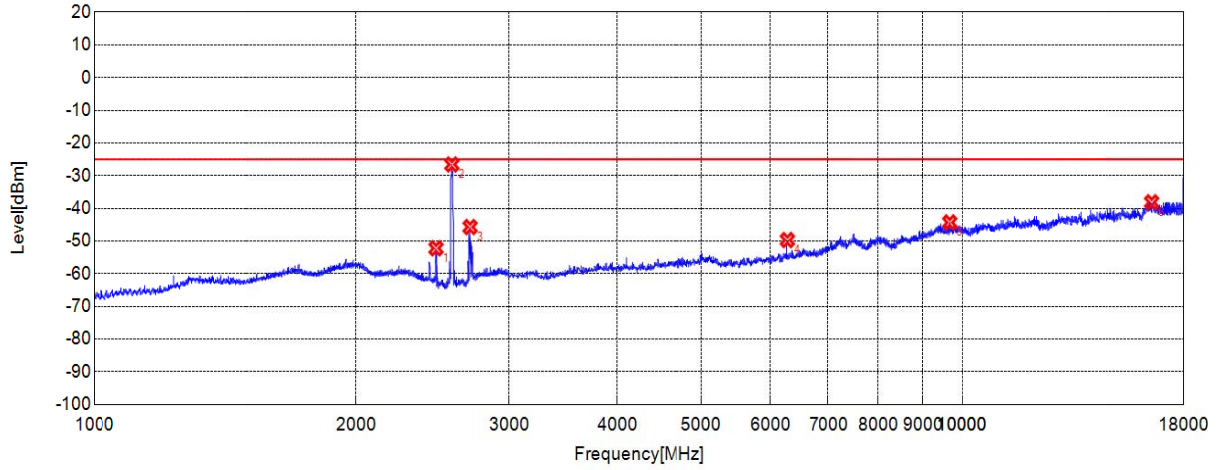

✱ Final Test

Suspected List								
NO.	Freq. [MHz]	Level [dBm]	Limit [dBm]	Margin [dB]	Factor [dB]	Path [dB]	Air [dB]	Ant. Pol.
1	2475.8250	-52.23	-25.00	27.23	-10.83	-47.65	36.82	Horizontal
2	2581.1940	-26.59	-25.00	1.59	-10.79	-47.67	36.88	NA
3	2707.9030	-45.73	-25.00	20.73	-10.34	-47.72	37.38	Horizontal
4	6275.5460	-49.71	-25.00	24.71	0.94	-41.10	42.04	Horizontal
5	9668.6110	-44.33	-25.00	19.33	11.48	-37.15	48.63	Horizontal
6	16547.2580	-38.15	-25.00	13.15	22.42	-29.13	51.55	Horizontal

CA\_41C Mid 20M QPSK PCC RB 1 0 SCC RB 0 0 1-18G H

### Test Graph

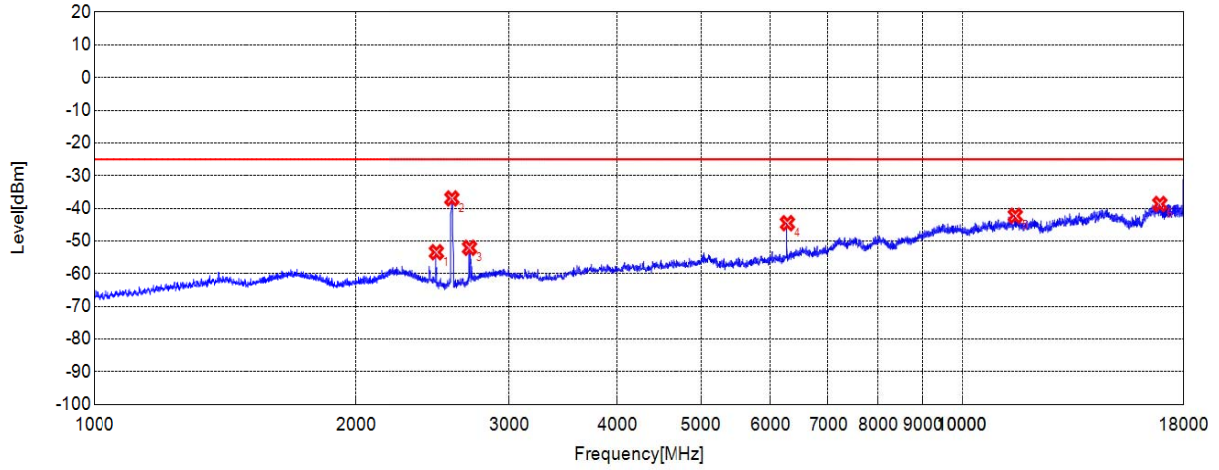

⊗ Final Test

Suspected List								
NO.	Freq. [MHz]	Level [dBm]	Limit [dBm]	Margin [dB]	Factor [dB]	Path [dB]	Air [dB]	Ant. Pol.
1	2478.4930	-53.43	-25.00	28.43	-10.98	-47.65	36.67	Vertical
2	2581.1940	-36.98	-25.00	11.98	-10.92	-47.67	36.75	NA
3	2703.9010	-52.09	-25.00	27.09	-10.66	-47.73	37.07	Vertical
4	6275.5460	-44.55	-25.00	19.55	0.84	-41.10	41.94	Vertical
5	11506.4180	-42.28	-25.00	17.28	14.78	-35.01	49.79	Vertical
6	16907.3180	-38.69	-25.00	13.69	22.36	-29.39	51.75	Vertical

CA\_41C Mid 20M QPSK PCC RB 1 0 SCC RB 0 0 1-18G V

### Test Graph

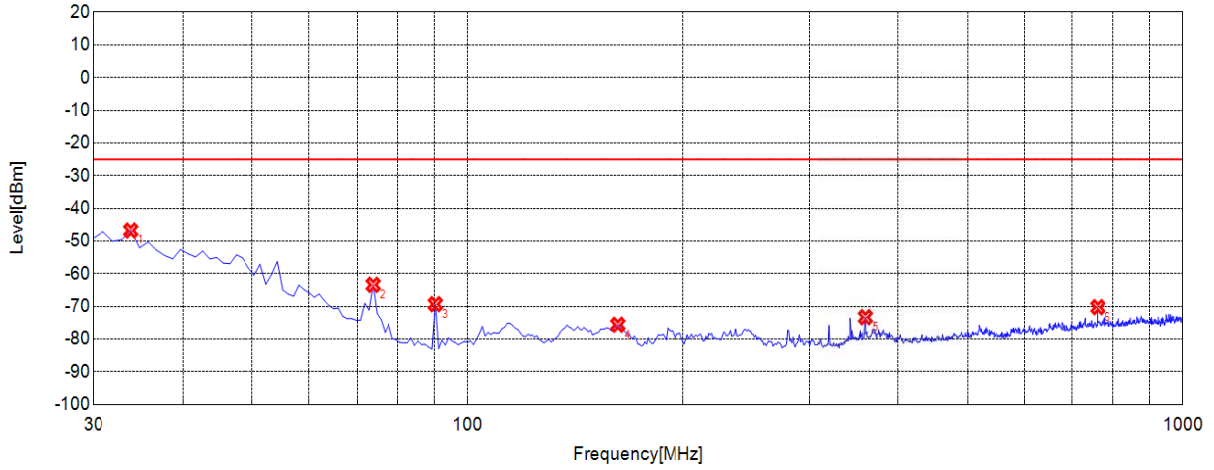

✘ Final Test

Suspected List								
NO.	Freq. [MHz]	Level [dBm]	Limit [dBm]	Margin [dB]	Factor [dB]	Path [dB]	Air [dB]	Ant. Pol.
1	33.8840	-46.79	-25.00	21.79	-12.90	-42.68	29.78	Horizontal
2	73.6940	-63.4	-25.00	38.40	-19.95	-42.46	22.51	Horizontal
3	90.2000	-69.32	-25.00	44.32	-22.79	-42.58	19.79	Horizontal
4	162.0520	-75.63	-25.00	50.63	-23.89	-42.83	18.94	Horizontal
5	360.1300	-73.32	-25.00	48.32	-16.48	-41.88	25.40	Horizontal
6	760.1700	-70.24	-25.00	45.24	-8.77	-40.49	31.72	Horizontal

CA\_41C Mid 20M QPSK PCC RB 1 0 SCC RB 0 0 30M-1G H



### Test Graph

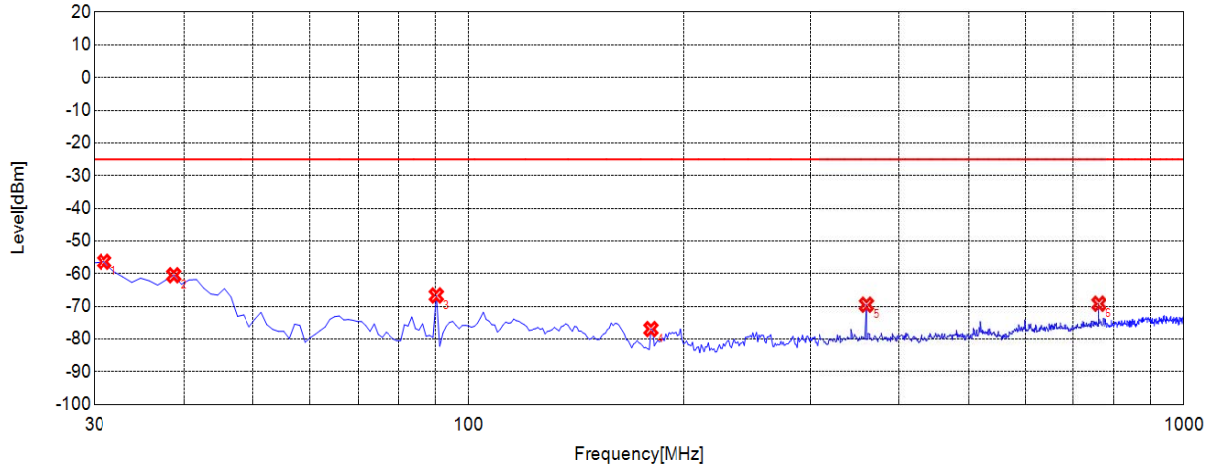

✘ Final Test

Suspected List								
NO.	Freq. [MHz]	Level [dBm]	Limit [dBm]	Margin [dB]	Factor [dB]	Path [dB]	Air [dB]	Ant. Pol.
1	30.9710	-56.35	-25.00	31.35	-19.99	-42.64	22.65	Vertical
2	38.7390	-60.47	-25.00	35.47	-19.48	-42.62	23.14	Vertical
3	90.2000	-66.66	-25.00	41.66	-20.37	-42.58	22.21	Vertical
4	179.5300	-76.94	-25.00	51.94	-21.41	-42.85	21.44	Vertical
5	360.1300	-69.5	-25.00	44.50	-16.03	-41.88	25.85	Vertical
6	760.1700	-69.19	-25.00	44.19	-8.58	-40.49	31.91	Vertical

CA\_41C Mid 20M QPSK PCC RB 1 0 SCC RB 0 0 30M-1G V



## Annex A Test Uncertainty

Where relevant, the following measurement uncertainty levels have been estimated for test performed on the EUT as specified in CISPR 16-1-2:

Test items	Uncertainty
Output Power	$\pm 2.22$ dB
Bandwidth	$\pm 5\%$
Conducted Spurious Emission	$\pm 2.77$ dB
Band Edge	$\pm 2.77$ dB
Equivalent Isotropic Radiated Power	$\pm 2.22$ dB
Radiated Spurious Emissions	$\pm 6$ dB

When the test result is a critical value, we will use the measurement uncertainty give the judgment result based on the 95% confidence intervals.



## Annex B Testing Laboratory Information

### 1. Identification of the Responsible Testing Laboratory

<b>Company Name:</b>	Shenzhen Morlab Communications Technology Co., Ltd.
<b>Address:</b>	FL.3, Building A, FeiYang Science Park, No.8 LongChang Road, Block 67, BaoAn District, ShenZhen, GuangDong Province, P. R. China
<b>Telephone:</b>	+86 755 36698555
<b>Facsimile:</b>	+86 755 36698525

### 2. Identification of the Responsible Testing Location

<b>Name:</b>	Shenzhen Morlab Communications Technology Co., Ltd.
<b>Address:</b>	FL.3, Building A, FeiYang Science Park, No.8 LongChang Road, Block 67, BaoAn District, ShenZhen, GuangDong Province, P. R. China

### 3. Facilities and Accreditations

All measurement facilities used to collect the measurement data are located at FL.3, Building A, FeiYang Science Park, Block 67, BaoAn District, Shenzhen, 518101 P. R. China. The test site is constructed in conformance with the requirements of ANSI C63.10-2013 and CISPR Publication 22; the FCC designation number is CN1192, the test firm registration number is 226174.



#### 4. Test Equipment Utilized

##### 4.1 Conducted Test Equipment

Equipment Name	Serial No.	Type	versions	Manufacturer	Cal. Date	Cal. Due
Power Splitter	NW521	1506A	N/A	Weinschel	N/A	N/A
Attenuator	N/A	10dB	N/A	Resnet	N/A	N/A
EXA Signal Analyzer	MY541705 56	N9030A	N/A	Keysight	2021.10.20	2022.10.19
System Simulator	62618305 72	MT8821C	0002214 22	Anritsu	2022.02.14	2023.02.13
RF cable (30MHz-26GHz)	CB01	RF01	N/A	Morlab	N/A	N/A
Computer	T430i	Think Pad	N/A	Lenovo	N/A	N/A

**4.2 Radiated Test Equipment**

Equipment Name	Serial No.	Type	Manufacturer	Cal. Date	Cal.Due
Loop Antenna	FMZB 1519	1519-022	SCHWARZBECK	2022.02.11	2025.02.10
Bi-Log Antenna	VULB 9163	9163-274	SCHWARZBECK	2019.11.23	2022.11.22
Bi-Log Antenna	VULB 9163	9163-519	SCHWARZBECK	2019.05.24	2022.05.23
Horn Antenna	BBHA 9120D	9120D-963	SCHWARZBECK	2019.05.24	2022.05.23
Horn Antenna	BBHA 9120D	01774	SCHWARZBECK	2019.07.26	2022.07.25
Horn Antenna	BBHA9170	BBHA9170#773	SCHWARZBECK	2019.07.26	2022.07.25
Receiver	N9038A	MY54130016	Agilent	2021.7.16	2022.07.15
Receiver	N9038A	MY56400093	KEYSIGHT	2022.3.03	2023.03.02
Receiver	PMM 9010	595WX11007	PMM	2022.3.01	2023.02.28
Receiver	PMM 9060	001WX1100	PMM	2022.3.01	2023.02.28
Signal Analyzer	N9020A	MY56060145	Agilent	2021.7.26	2022.07.25
6db Attenuator	BW-N6W5+	E191001	Mini-circuits	2021.10.18	2022.10.17
Preamplifier	S020180L3203	61171/61172	LUCIX CORP.	2021.07.16	2022.07.15
Preamplifier	S10M100L3802	46732	LUCIX CORP.	2021.07.16	2022.07.15
System Simulator	CMW500	152038	R&S	2021.10.21	2022.010.20
System Simulator	8960-E5515C	MY48364176	Agilent	2022.03.01	2023.02.28
System Simulator	MT8000A	6262148249	anritsu	2021.09.17	2022.09.16

—END OF REPORT—