



SAR TEST REPORT

No.I17N0257-HAC RF

For

Reliance Communications, LLC

GSM/CDMA/WCDMA/LTE mobile phone

Model Name: RC555L

With

Hardware Version: V2.0

Software Version: V1.6.3

FCC ID: 2AGBH-RC555L

Results Summary: M Category = M3

Issued Date: 2017-10-16

Note:

The test results in this test report relate only to the devices specified in this report. This report shall not be reproduced except in full without the written approval of CTTL.

Test Laboratory:

CTTL, Telecommunication Technology Labs, Academy of Telecommunication Research, MIIT

No.52, HuayuanNorth Road, Haidian District, Beijing, P. R. China 100191.

Tel: +86(0)10-62304633-2512, Fax: +86(0)10-62304633-2504

Email: yewu@caict.ac.cn, website: www.chinattl.com



REPORT HISTORY

Report Number	Revision	Issue Date	Description
I17N01257-HAC RF	Rev.0	2017-10-16	Initial creation of test report



TABLE OF CONTENT

1 TEST LABORATORY	5
1.1 TESTING LOCATION	5
1.2 TESTING ENVIRONMENT.....	5
1.3 PROJECT DATA	5
1.4 SIGNATURE.....	5
2 CLIENT INFORMATION	6
2.1 APPLICANT INFORMATION	6
2.2 MANUFACTURER INFORMATION	6
3 EQUIPMENT UNDER TEST (EUT) AND ANCILLARY EQUIPMENT (AE)	7
3.1 ABOUT EUT	7
3.2 INTERNAL IDENTIFICATION OF EUT USED DURING THE TEST	7
3.3 INTERNAL IDENTIFICATION OF AE USED DURING THE TEST	7
3.4 AIR INTERFACES / BANDS INDICATING OPERATING MODES	8
4. REFERENCE DOCUMENTS	8
5 OPERATIONAL CONDITIONS DURING TEST	9
5.1 HAC MEASUREMENT SET-UP.....	9
5.2 PROBE SPECIFICATION	10
5.3 TEST ARCH PHANTOM & PHONE POSITIONER.....	11
5.4 ROBOTIC SYSTEM SPECIFICATIONS	11
6 EUT ARRANGEMENT	12
6.1 WD RF EMISSION MEASUREMENTS REFERENCE AND PLANE	12
7 SYSTEM VALIDATION	13
7.1 VALIDATION PROCEDURE	13
7.2 VALIDATION RESULT	13
8 EVALUATION OF MIF	14
8.1 INTRODUCTION.....	14
8.2 MIF MEASUREMENT WITH THE AIA	15
8.3 TEST EQUIPMENT FOR THE MIF MEASUREMENT	15
8.4 TEST SIGNAL VALIDATION	15
8.5 DUT MIF RESULTS.....	16
9 EVALUATION FOR LOW-POWER EXEMPTION	17
9.1 PRODUCT TESTING THRESHOLD	17
9.2 CONDUCTED POWER.....	17
10 RF TEST PROCEDURES	18
11 MEASUREMENT RESULTS (E-FIELD).....	19



12 ANSI C 63.19-2011 LIMITS	20
13 MEASUREMENT UNCERTAINTY	21
14 MAIN TEST INSTRUMENTS.....	22
ANNEX A TEST LAYOUT.....	23
ANNEX B TEST PLOT	24
ANNEX C SYSTEM VALIDATION RESULT	44
ANNEX D PROBE CALIBRATION CERTIFICATE.....	47
ANNEX E DIPOLE CALIBRATION CERTIFICATE	57

1 Test Laboratory

1.1 Testing Location

Company Name:	CTTL(Shenzhen)
Address:	Building G, Shenzhen International Innovation Center, No.1006 Shennan Road, Futian District, Shenzhen, Guangdong, China

1.2 Testing Environment

Temperature:	18°C~25 °C
Relative humidity:	30%~ 70%
Ground system resistance:	<4Ω
Ambient noise & Reflection:	< 0.012 W/kg

1.3 Project Data

Project Leader:	Zhang Yunzhuan
Test Engineer:	Li Yongfu
Testing Start Date:	October 08, 2017
Testing End Date:	October 14, 2017

1.4 Signature

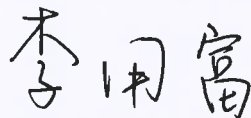

Li Yongfu

(Prepared this test report)



Zhang Yunzhuan

(Reviewed this test report)

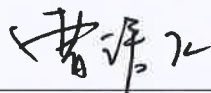

Cao Junfei

Deputy Director of the laboratory

(Approved this test report)



2 Client Information

2.1 Applicant Information

Company Name:	Reliance Communications, LLC
Address /Post:	555 Wireless BLVD, Hauppauge NY 11788
Contact:	Saqib Ghouri / Chandler Chen
Email:	saqib.ghouri@reliance.us / chandler.chen@reliance.us
Telephone:	+92-317-512-6111 / +86 185-7557-6433
Fax:	/

2.2 Manufacturer Information

Company Name:	Unimaxcomm
Address /Post:	Room 602, Building-B, Shenzhen Software Park T3, Hi-Tech Park South, Nan Shan District, Shenzhen, China
Contact:	Chunli.He
Email:	hchunli@unimaxcomm.com
Telephone:	130 7785 5257
Fax:	/



3 Equipment Under Test (EUT) and Ancillary Equipment (AE)

3.1 About EUT

Description:	GSM/CDMA/WCDMA/LTE mobile phone
Mode Name:	RC555L
Operating mode(s):	GSM 850/1900/900/1800, WCDMA 850/1700/1900, CDMA BC0/BC1/BC10 LTE_ Band 2/4/5/12/13/17/25/26/41, BT, Wi-Fi 2.4G/5G

3.2 Internal Identification of EUT used during the test

EUT ID*	IMEI	HW Version	SW Version
EUT1	358924080004905	V2.0	V1.6.3
EUT2	358924080000911	V2.0	V1.6.3

*EUT ID: is used to identify the test sample in the lab internally.

Note: It is performed to test HAC with the EUT1 and conducted power with the EUT2.

3.3 Internal Identification of AE used during the test

AE ID*	Description	Model	SN	Manufacturer
AE1	Battery	RC555L	/	Veken

*AE ID: is used to identify the test sample in the lab internally.



3.4 Air Interfaces / Bands Indicating Operating Modes

Air-interface	Band(MHz)	Type	C63.19/tested	Simultaneous Transmissions	OTT	Power Reduction
GSM	850 / 1900	VO	Yes	BT,WLAN	NA	NA
GPRS/EDGE	850 / 1900	DT	NA			NA
WCDMA (UMTS)	II / IV / V	VO	Yes	BT,WLAN	NA	NA
	HSPA	DT	NA			
CDMA	BC 0 / 1 / 10	VO	Yes	BT,WLAN	NA	NA
	1xRTT/EVDO	DT	NA			
LTE	2/4/5/12/13/17/25/26/41	VD	Yes	BT,WLAN	NA	NA
BT	2450	DT	NA	WWAN	NA	NA
WLAN	2.4G/5G	DT	NA	WWAN	NA	NA

VO: Voice CMRS/PSTN Service Only

V/D: Voice CMRS/PSTN and Data Service

DT: Digital Transport

* HAC Rating was not based on concurrent voice and data modes; Non-current mode was found to represent worst case rating for both M and T rating

4. Reference Documents

The following document listed in this section is referred for testing.

Reference	Title	Version
ANSI C63.19-2011	American National Standard for Methods of Measurement of Compatibility between Wireless Communication Devices and Hearing Aids	2011 Edition
KDB 285076 D01	Equipment Authorization Guidance for Hearing Aid Compatibility	v04

5 OPERATIONAL CONDITIONS DURING TEST

5.1 HAC MEASUREMENT SET-UP

These measurements are performed using the DASY5 NEO automated dosimetric assessment system. It is made by Schmid & Partner Engineering AG (SPEAG) in Zurich, Switzerland. It consists of high precision robotics system (Stäubli), robot controller, Intel Core2 computer, near-field probe, probe alignment sensor. The robot is a six-axis industrial robot performing precise movements. A cell controller system contains the power supply, robot controller, teach pendant (Joystick), and remote control, is used to drive the robot motors. The PC consists of the HP Intel Core2 1.86 GHz computer with Windows XP system and HAC Measurement Software DASY5 NEO, A/D interface card, monitor, mouse, and keyboard. The Stäubli Robot is connected to the cell controller to allow software manipulation of the robot. A data acquisition electronic (DAE) circuit performs the signal amplification, signal multiplexing, AD-conversion, offset measurements, mechanical surface detection, collision detection, etc. is connected to the Electro-optical coupler (EOC). The EOC performs the conversion from the optical into digital electric signal of the DAE and transfers data to the PC plug-in card.

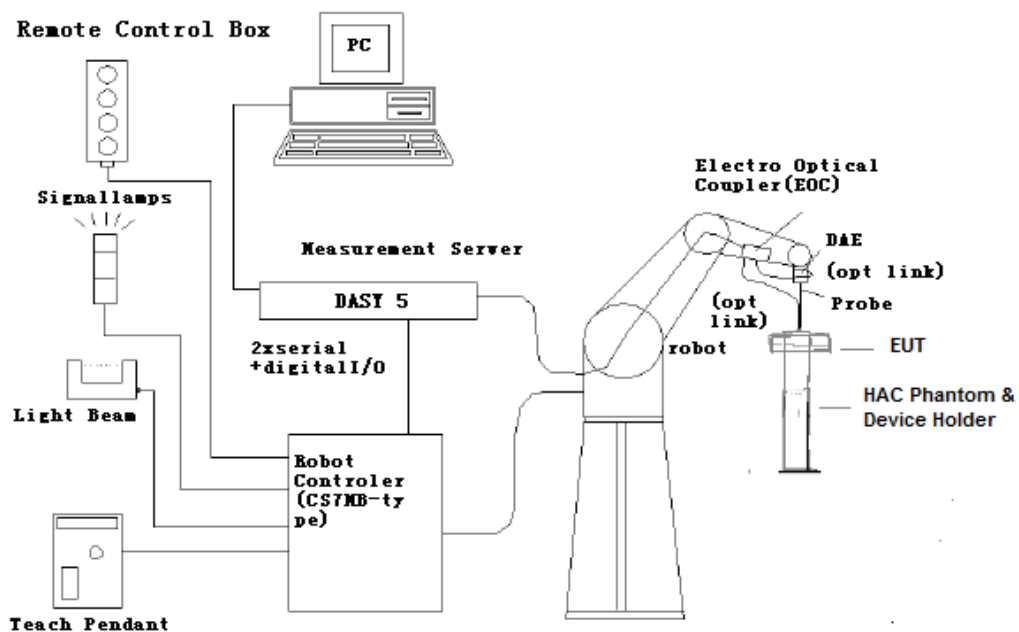

Fig. 1 HAC Test Measurement Set-up

The DAE4 consists of a highly sensitive electrometer-grade preamplifier with auto-zeroing, a channel and gain-switching multiplexer, a fast 16 bit AD-converter and a command decoder and control logic unit. Transmission to the PC-card is accomplished through an optical downlink for data and status information and an optical uplink for commands and clock lines. The mechanical probe mounting device includes two different sensor systems for frontal and sidewise probe contacts. They are also used for mechanical surface detection and probe collision detection. The robot uses its own controller with a built in VME-bus computer.

5.2 Probe Specification

E-Field Probe Description

Construction	One dipole parallel, two dipoles normal to probe axis Built-in shielding against static charges PEEK enclosure material
Calibration	In air from 100 MHz to 3.0 GHz (absolute accuracy $\pm 6.0\%$, $k=2$)
Frequency	40 MHz to > 6 GHz (can be extended to < 20 MHz) Linearity: ± 0.2 dB (100 MHz to 3 GHz)
Directivity	± 0.2 dB in air (rotation around probe axis) ± 0.4 dB in air (rotation normal to probe axis)
Dynamic Range	2 V/m to > 1000 V/m; Linearity: ± 0.2 dB
Dimensions	Overall length: 330 mm (Tip: 16 mm) Tip diameter: 8 mm (Body: 12 mm) Distance from probe tip to dipole centers: 2.5 mm
Application	General near-field measurements up to 6 GHz Field component measurements Fast automatic scanning in phantoms



[ER3DV6]

5.3 Test Arch Phantom & Phone Positioner

The Test Arch phantom should be positioned horizontally on a stable surface. Reference markings on the Phantom allow the complete setup of all predefined phantom positions and measurement grids by manually teaching three points in the robot. It enables easy and well defined positioning of the phone and validation dipoles as well as simple teaching of the robot (Dimensions: 370 x 370 x 370 mm).

The Phone Positioner supports accurate and reliable positioning of any phone with effect on near field $\leq \pm 0.5$ dB.

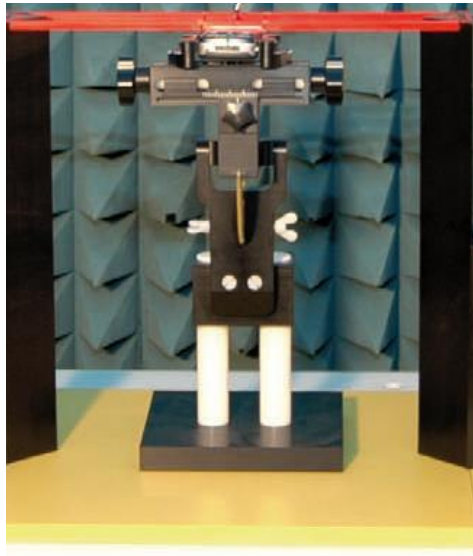

Fig. 2 HAC Phantom & Device Holder

4.4 Robotic System Specifications

Specifications

Positioner: Stäubli Unimation Corp. Robot Model: RX160XL

Repeatability: ± 0.02 mm

No. of Axis: 6

Data Acquisition Electronic (DAE) System

Cell Controller

Processor: Intel Core2

Clock Speed: 1.86 GHz

Operating System: Windows XP

Data Converter

Features: Signal Amplifier, multiplexer, A/D converter, and control logic

Software: DASY5 software

Connecting Lines: Optical downlink for data and status info.

Optical uplink for commands and clock

6 EUT ARRANGEMENT

6.1 WD RF Emission Measurements Reference and Plane

Figure 4 illustrates the references and reference plane that shall be used in the WD emissions measurement.

- The grid is 5 cm by 5 cm area that is divided into 9 evenly sized blocks or sub-grids.
- The grid is centered on the audio frequency output transducer of the WD (speaker or T-coil).
- The grid is located by reference to a reference plane. This reference plane is the planar area that contains the highest point in the area of the WD that normally rests against the user's ear
- The measurement plane is located parallel to the reference plane and 15 mm from it, out from the phone. The grid is located in the measurement plane.

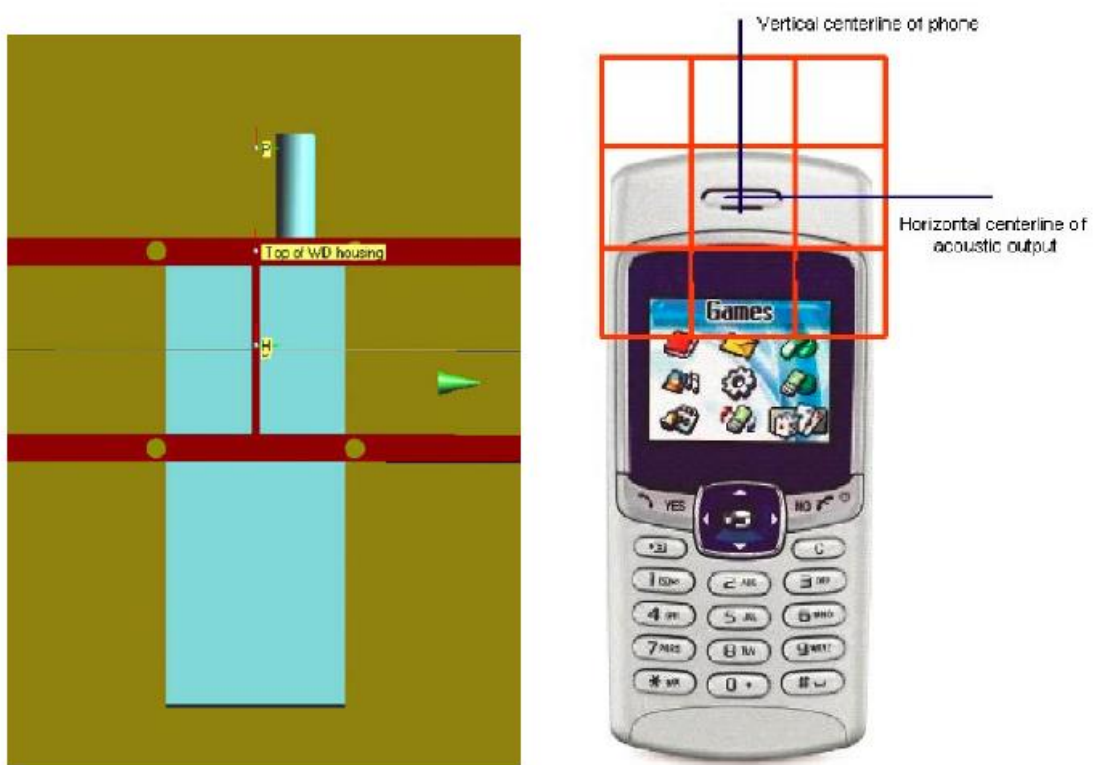

Fig. 3 WD reference and plane for RF emission measurements

7 SYSTEM VALIDATION

7.1 Validation Procedure

Place a dipole antenna meeting the requirements given in ANSI C63.19 in the position normally occupied by the WD. The dipole antenna serves as a known source for an electrical output. Position the E-field probes so that:

- The probes and their cables are parallel to the coaxial feed of the dipole antenna
- The probe cables and the coaxial feed of the dipole antenna approach the measurement area from opposite directions
- The center point of the probe element(s) are 15 mm from the closest surface of the dipole elements.

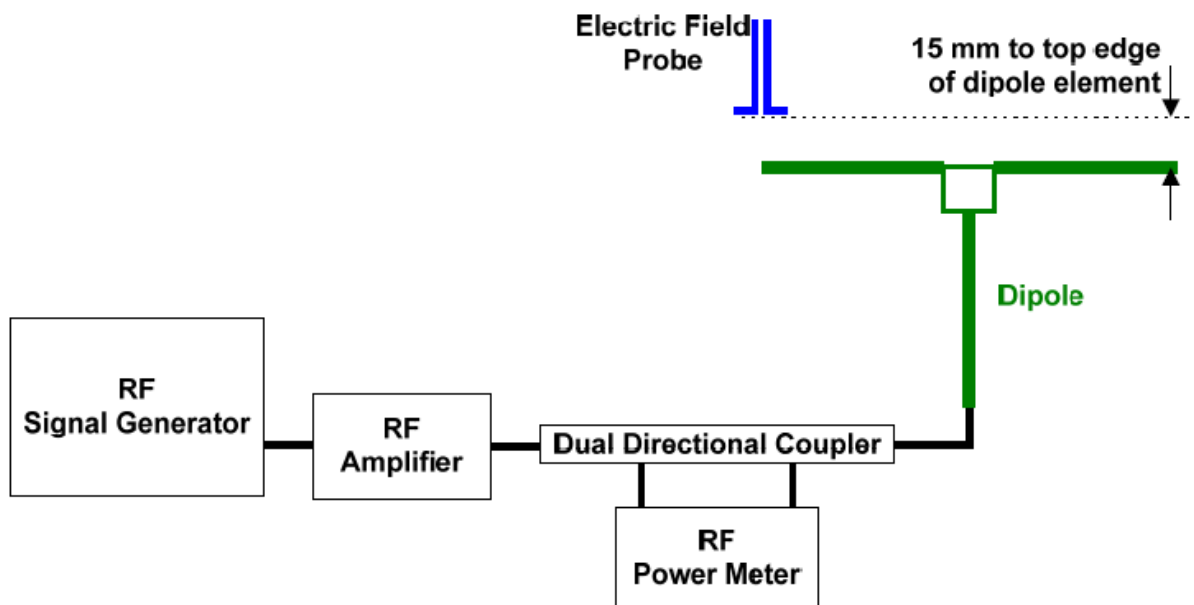

Fig. 4 Dipole Validation Setup

7.2 Validation Result

E-Field Scan						
Mode	Frequency (MHz)	Input Power (mW)	Measured ¹ Value(dBV/m)	Target ² Value(dBV/m)	Deviation ³ (%)	Limit ⁴ (%)
CW	835	100	41.35	40.59	1.87	±25
CW	1880	100	40.06	39.14	2.35	±25
CW	2600	100	39.82	38.71	2.87	±25

Notes:

1. Please refer to the attachment for detailed measurement data and plot.
2. Target value is provided by SPEAD in the calibration certificate of specific dipoles.
3. Deviation (%) = $100 * (\text{Measured value minus Target value})$ divided by Target value.
4. ANSI C63.19 requires values within $\pm 25\%$ are acceptable, of which 12% is deviation and 13% is measurement uncertainty. Values independently validated for the dipole actually used in the measurements should be used, when available.

8 Evaluation of MIF

8.1 Introduction

The MIF (Modulation Interference Factor) is used to classify E-field emission to determine Hearing Aid Compatibility (HAC). It scales the power-averaged signal to the RF audio interference level and is characteristic to a modulation scheme. The HAC standard preferred "indirect" measurement method is based on average field measurement with separate scaling by the MIF. With an Audio Interference Analyzer (AIA) designed by SPEAG specifically for the MIF measurement, these values have been verified by practical measurements on an RF signal modulated with each of the waveforms. The resulting deviations from the simulated values are within the requirements of the HAC standard.

The AIA (Audio Interference Analyzer) is a USB powered electronic sensor to evaluate signals in the frequency range 698 MHz - 6 GHz. It contains RMS detector and audio frequency circuits for sampling of the RF envelope.

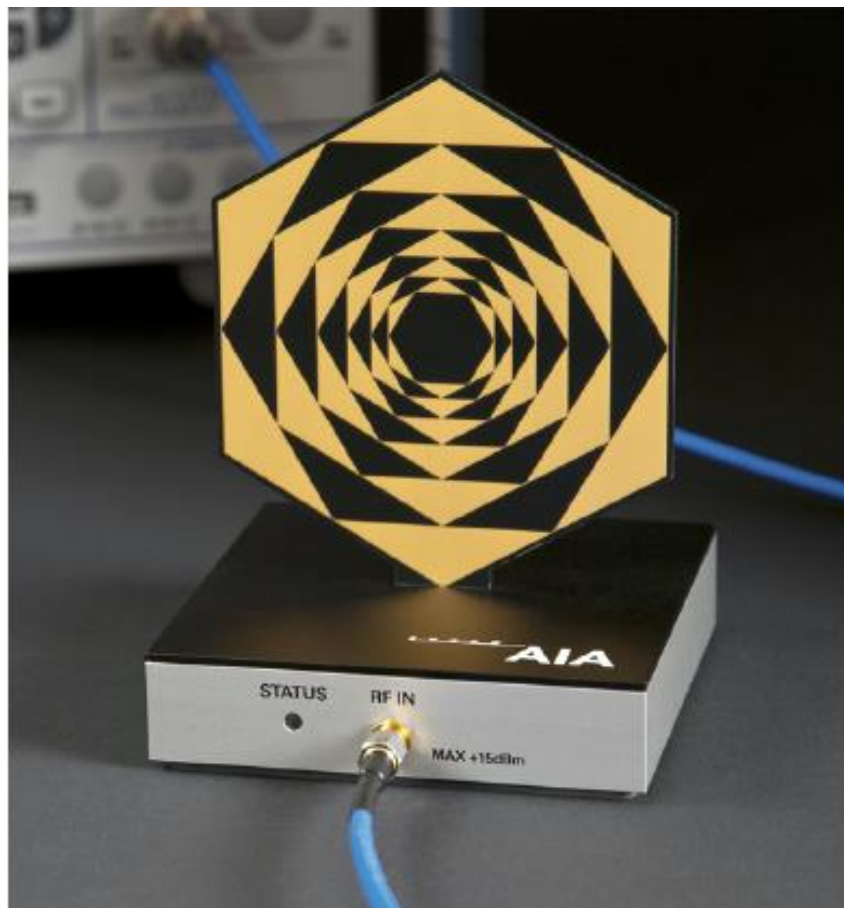

Fig. 5 AIA Front View

8.2 MIF measurement with the AIA

The MIF is measured with the AIA as follows:

1. Connect the AIA via USB to the DASY5 PC and verify the configuration settings.
2. Couple the RF signal to be evaluated to an AIA via cable or antenna.
3. Generate a MIF measurement job for the unknown signal and select the measurement port and timing settings.
4. Document the results via the post processor in a report.

8.3 Test equipment for the MIF measurement

No.	Name	Type	Serial Number	Manufacturer
01	Signal Generator	E8257D	MY47461211	Agilent
02	AIA	SE UMS 170 CB	1050	SPEAG
03	BTS	CMU200	114540	Rohde&Shwarz
04	BTS	CMU500	152499	Rohde&Shwarz

8.4 Test signal validation

The signal generator (E8257D) is used to generate a 1GHz signal with different modulation in the below table based on the ANSI C63.19-2011. The measured MIF with AIA are compared with the target values given in ANSI C63.19-2011 table D.3, D.4 and D.5

Pulse modulation	Target MIF	Measured MIF	Deviation
0.5ms pulse, 1000Hz repetition rate	-0.9 dB	-0.89 dB	0.1 dB
1ms pulse, 100Hz repetition rate	+3.9 dB	+3.7 dB	0.2 dB
0.1ms pulse, 100Hz repetition rate	+10.1 dB	+10.0 dB	0.1 dB
10ms pulse, 10Hz repetition rate	+1.6 dB	+1.7 dB	0.1 dB
Sine-wave modulation	Target MIF	Measured MIF	Deviation
1 kHz, 80% AM	-1.2 dB	-1.4 dB	0.2 dB
1 kHz, 10% AM	-9.1 dB	-9.0 dB	0.1 dB
1 kHz, 1% AM	-19.1 dB	-18.9 dB	0.2 dB
100 Hz, 10% AM	-16.1 dB	-16.0 dB	0.1 dB
10 kHz, 10% AM	-21.5 dB	-21.6 dB	0.1 dB
Transmission protocol	Target MIF	Measured MIF	Deviation
GSM; full-rate version 2; speech codec/handset low	+3.5 dB	+3.44 dB	0.06 dB
WCDMA; speech; speech codec low; AMR 12.2 kb/s	-20.0 dB	-19.65 dB	0.35 dB
CDMA; speech; SO3; RC1; 1/8 th frame rate; 8kEVRC	+3.3 dB	+3.17 dB	0.13 dB

8.5 DUT MIF results

Measured MIF levels			
Communication System Name	Modulation interference factor (dB)		
GSM 850	Channel 251	Channel 190	Channel 128
	3.44	3.42	3.41
GSM 1900	Channel 810	Channel 661	Channel 512
	3.43	3.44	3.40
WCDMA 850	Channel 4233	Channel 4182	Channel 4132
	-19.65	-19.68	-19.70
WCDMA 1700	Channel 1513	Channel 1412	Channel 1312
	-19.68	-19.71	-19.72
WCDMA 1900	Channel 9538	Channel 9400	Channel 9262
	-19.66	-19.67	-19.73
CDMA BC0	Channel 777	Channel 384	Channel 1013
	3.17	3.15	3.14
CDMA BC1	Channel 1175	Channel 600	Channel 25
	3.15	3.14	3.12
CDMA BC10	Channel 684	Channel 580	Channel 476
	3.17	3.16	3.14
LTE Band 2	Channel 19100	Channel 18900	Channel 18700
	-9.74	-9.71	-9.68
LTE Band 4	Channel 20300	Channel 20175	Channel 20050
	-9.77	-9.79	-9.82
LTE Band 5	Channel 20600	Channel 20525	Channel 20450
	-9.69	-9.71	-9.74
LTE Band 12	Channel 23130	Channel 23095	Channel 23060
	-9.73	-9.75	-9.70
LTE Band 13	/	Channel 23230	/
	/	-9.74	/
LTE Band 17	Channel 23800	Channel 23790	Channel 23780
	-9.78	-9.76	-9.71
LTE Band 25	Channel 26590	Channel 26365	Channel 26140
	-9.68	-9.70	-9.73
LTE Band 26	Channel 26965	Channel 26865	Channel 26775
	-9.74	-9.73	-9.75
LTE Band 41	Channel 41490	Channel 41055	Channel 40620
	-1.52	-1.54	-1.55
	Channel 40185	Channel 39750	/
	-1.58	-1.60	/

9 Evaluation for low-power exemption

9.1 Product testing threshold

There are two methods for exempting an RF air interface technology from testing. The first method requires evaluation of the MIF for the worst-case operating mode. An RF air interface technology of a device is exempt from testing when its average antenna input power plus its MIF is ≤ 17 dBm for any of its operating modes. The second method does not require determination of the MIF. The RF emissions testing exemption shall be applied to an RF air interface technology in a device whose peak antenna input power, averaged over intervals $\leq 50 \mu s$, is ≤ 23 dBm. An RF air interface technology that is exempted from testing by either method shall be rated as M4.

The first method is used to be exempt from testing for the RF air interface technology in this report.

9.2 Conducted power

Band	power (dBm)	MIF (dB)	Sum (dBm)	HAC Test
GSM 850	34.0	3.44	37.44	Yes
GSM 1900	31.0	3.44	34.44	Yes
WCDMA 850	24.5	-19.65	4.85	No
WCDMA 1700	24.3	-19.68	4.62	No
WCDMA 1900	24.3	-19.66	4.64	No
CDMA BC0	24.8	3.17	27.97	Yes
CDMA BC1	24.5	3.15	27.65	Yes
CDMA BC10	24.8	3.17	27.97	Yes
LTE Band 2	23.8	-9.68	14.12	No
LTE Band 4	23.5	-9.77	13.73	No
LTE Band 5	24.0	-9.69	14.31	No
LTE Band 12	24.0	-9.70	14.30	No
LTE Band 13	24.0	-9.74	14.26	No
LTE Band 17	24.0	-9.71	14.29	No
LTE Band 25	23.5	-9.68	13.82	No
LTE Band 26	24.3	-9.73	14.57	No
LTE Band 41	24.0	-1.52	22.48	Yes

Note:

1. Power = Max turn-up limit



10 RF TEST PROCEDURES

The evaluation was performed with the following procedure:

- 1) Confirm proper operation of the field probe, probe measurement system and other instrumentation and the positioning system.
- 2) Position the WD in its intended test position. The gauge block can simplify this positioning.
- 3) Configure the WD normal operation for maximum rated RF output power, at the desired channel and other operating parameters (e.g., test mode), as intended for the test.
- 4) The center sub-grid shall be centered on the center of the T-Coil mode axial measurement point or the acoustic output, as appropriate. Locate the field probe at the initial test position in the 50 mm by 50 mm grid, which is contained in the measurement plane. If the field alignment method is used, align the probe for maximum field reception.
- 5) Record the reading.
- 6) Scan the entire 50 mm by 50 mm region in equally spaced increments and record the reading at each measurement point. The distance between measurement points shall be sufficient to assure the identification of the maximum reading.
- 7) Identify the five contiguous sub-grids around the center sub-grid whose maximum reading is the lowest of all available choices. This eliminates the three sub-grids with the maximum readings. Thus, the six areas to be used to determine the WD's highest emissions are identified.
- 8) Identify the maximum field reading within the non-excluded sub-grids identified in Step 7)
- 9) Evaluate the MIF and add to the maximum steady-state rms field-strength reading to obtain the RF audio interference level..
- 10) Compare this RF audio interference level with the categories and record the resulting WD category rating.

11 Measurement Results (E-Field)

Frequency		Measured Value (dBV/m)	Power Drift (dB)	Category
MHz	Channel			
GSM 850				
848.8	251	37.77	0.03	M4 (see Fig B.1)
836.6	190	38.29	-0.04	M4 (see Fig B.2)
824.2	128	38.21	-0.01	M4 (see Fig B.3)
GSM 1900				
1909.8	810	30.79	0.03	M3 (see Fig B.4)
1880	661	30.84	0.02	M3 (see Fig B.5)
1850.2	512	29.82	0.09	M4 (see Fig B.6)
CDMA BC0				
848.31	777	37.88	0.10	M4 (see Fig B.7)
836.60	384	37.98	0.03	M4 (see Fig B.8)
824.70	1013	37.97	0.05	M4 (see Fig B.9)
CDMA BC1				
1908.75	1175	34.49	-0.07	M3 (see Fig B.10)
1880.00	600	24.41	0.07	M3 (see Fig B.11)
1851.25	25	34.85	0.06	M3 (see Fig B.12)
CDMA BC10				
823.1	684	38.18	0.02	M4 (see Fig B.13)
820.5	580	38.07	-0.05	M4 (see Fig B.14)
817.9	476	38.09	-0.03	M4 (see Fig B.15)
LTE Band 41				
2680.0	41490	21.63	-0.08	M4 (see Fig B.16)
2636.5	41055	21.58	-0.03	M4 (see Fig B.17)
2593.0	40620	21.57	-0.10	M4 (see Fig B.18)
2549.5	40185	20.55	0.05	M4 (see Fig B.19)
2506.0	39750	20.77	0.03	M4 (see Fig B.20)



12 ANSI C 63.19-2011 LIMITS

WD RF audio interference level categories in logarithmic units

Emission categories	< 960 MHz	
	E-field emissions	
Category M1	50 to 55	dB (V/m)
Category M2	45 to 50	dB (V/m)
Category M3	40 to 45	dB (V/m)
Category M4	< 40	dB (V/m)
Emission categories	> 960 MHz	
	E-field emissions	
Category M1	40 to 45	dB (V/m)
Category M2	35 to 40	dB (V/m)
Category M3	30 to 35	dB (V/m)
Category M4	< 30	dB (V/m)

13 MEASUREMENT UNCERTAINTY

No.	Error source	Type	Uncertainty Value (%)	Prob. Dist.	k	c_i E	Standard Uncertainty (%) u_i (%) E	Degree of freedom V_{eff} or v_i	source
1	System repeatability	A	0.24	N	1	1	0.24	9	Measurement
Measurement System									
2	Probe Calibration	B	10.1	N	1	1	10.1	∞	Manufacturer
3	Axial Isotropy	B	0.5	R	$\sqrt{3}$	1	0.5	∞	Cal report
4	Sensor Displacement	B	16.5	R	$\sqrt{3}$	1	9.5	∞	Manufacturer
5	Boundary Effects	B	2.4	R	$\sqrt{3}$	1	1.4	∞	Manufacturer
6	Linearity	B	0.6	R	$\sqrt{3}$	1	0.35	∞	Cal report
7	Scaling to Peak Envelope Power	B	2.0	R	$\sqrt{3}$	1	1.2	∞	Standard
8	System Detection Limit	B	1.0	R	$\sqrt{3}$	1	0.6	∞	Manufacturer
9	Readout Electronics	B	0.3	N	1	1	0.3	∞	Manufacturer
10	Response Time	B	0.8	R	$\sqrt{3}$	1	0.5	∞	Manufacturer
11	Integration Time	B	2.6	R	$\sqrt{3}$	1	1.5	∞	Manufacturer
12	RF Ambient Conditions	B	3.0	R	$\sqrt{3}$	1	1.7	∞	Measurement
13	RF Reflections	B	12.0	R	$\sqrt{3}$	1	6.9	∞	Measurement
14	Probe Positioner	A	1.2	R	$\sqrt{3}$	1	0.7	∞	Manufacturer
15	Probe Positioning	A	4.7	R	$\sqrt{3}$	1	2.7	∞	Manufacturer
16	Extra. And Interpolation	B	1.0	R	$\sqrt{3}$	1	0.6	∞	Manufacturer
Test Sample Related									
17	Device Positioning Vertical	B	4.7	R	$\sqrt{3}$	1	2.7	∞	Manufacturer
18	Device Positioning Lateral	B	1.0	R	$\sqrt{3}$	1	0.6	∞	Manufacturer
19	Device Holder and Phantom	B	2.4	R	$\sqrt{3}$	1	1.4	∞	Manufacturer
20	Power Drift	B	5.0	R	$\sqrt{3}$	1	2.9	∞	Measurement
Phantom and Setup related									
21	Phantom Thickness	B	2.4	R	$\sqrt{3}$	1	1.4	∞	Manufacturer
PMF related									
22	Monitor amplitude	B	3.5	R	$\sqrt{3}$	1	2.02	∞	Manufacturer
23	Setup repeatability	A	2.3	N	1	1	2.3	9	Manufacturer
24	Sensor amplitude	B	12	R	$\sqrt{3}$	1	6.93	∞	Manufacturer
Combined standard uncertainty(%)							18.3		
Expanded uncertainty (confidence interval of 95 %)		$u_e = 2u_c$		N	k=2		36.6		

14 MAIN TEST INSTRUMENTS

Table 1: List of Main Instruments

No.	Name	Type	Serial Number	Calibration Date	Valid Period
01	Signal Generator	E8257D	MY47461211	2017-06-06	One year
02	Power meter	NRP	102603	2017-01-06	One year
03	Power sensor	NRP-Z51	102211		
04	Amplifier	VTL5400	0404	/	
05	E-Field Probe	ER3DV6	2424	2015-01-23	Three year
06	HAC Dipole	CD835V3	1165	2015-07-20	Three year
07	HAC Dipole	CD1880V3	1149	2015-07-20	Three year
08	HAC Dipole	CD2600V3	1011	2016-02-09	Three year
09	BTS	CMU200	114540	2016-12-24	One year
10	BTS	CMU500	152499	2017-07-20	One year
11	DAE	SPEAG DAE4	786	2016-12-08	One year
12	AIA	SE UMS 170 CB	1050	/	
13	HAC Test Arch	N/A	1150	/	

ANNEX A TEST LAYOUT

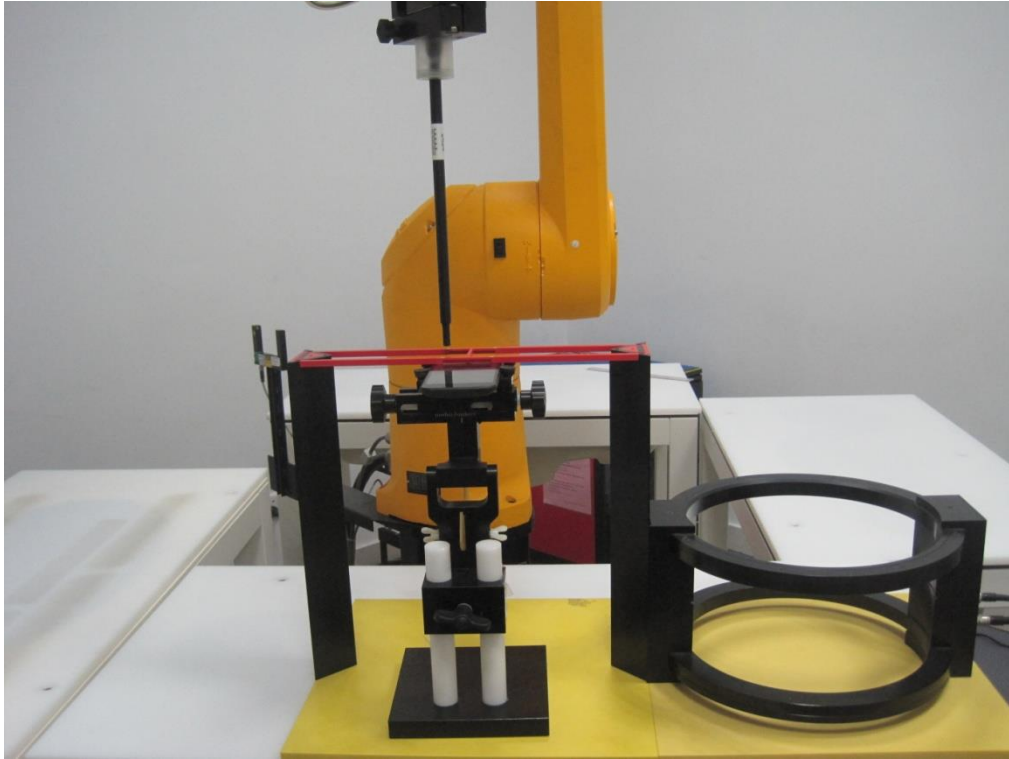

Picture A1: HAC RF System Layout

ANNEX B TEST PLOT

HAC RF E-Field GSM 850 High

Date: 2017-10-8

Electronics: DAE4 Sn786

Medium: Air

Medium parameters used: $\sigma = 0$ S/m, $\epsilon_r = 1$; $\rho = 1000$ kg/m³

Ambient Temperature: 22.0°C Liquid Temperature: 21.5°C

Communication System: GSM Frequency: 848.8 MHz Duty Cycle: 1:8.3

Probe: ER3DV6 - SN2424 ConvF (1, 1, 1);

E Scan - ER3DV6 - 2011: 15 mm from Probe Center to the Device /Hearing Aid Compatibility

Test (101x101x1): Interpolated grid: dx=0.5000 mm, dy=0.5000 mm

Device Reference Point: 0, 0, -6.3 mm

Reference Value = 64.81 V/m; Power Drift = 0.03 dB

Applied MIF = 3.44 dB

RF audio interference level = 37.77 dBV/m

Emission category: M4

MIF scaled E-field

Grid 1 M4 37.34 dBV/m	Grid 2 M4 37.65 dBV/m	Grid 3 M4 37.14 dBV/m
Grid 4 M4 37.49 dBV/m	Grid 5 M4 37.77 dBV/m	Grid 6 M4 37.25 dBV/m
Grid 7 M4 37.58 dBV/m	Grid 8 M4 37.83 dBV/m	Grid 9 M4 37.43 dBV/m

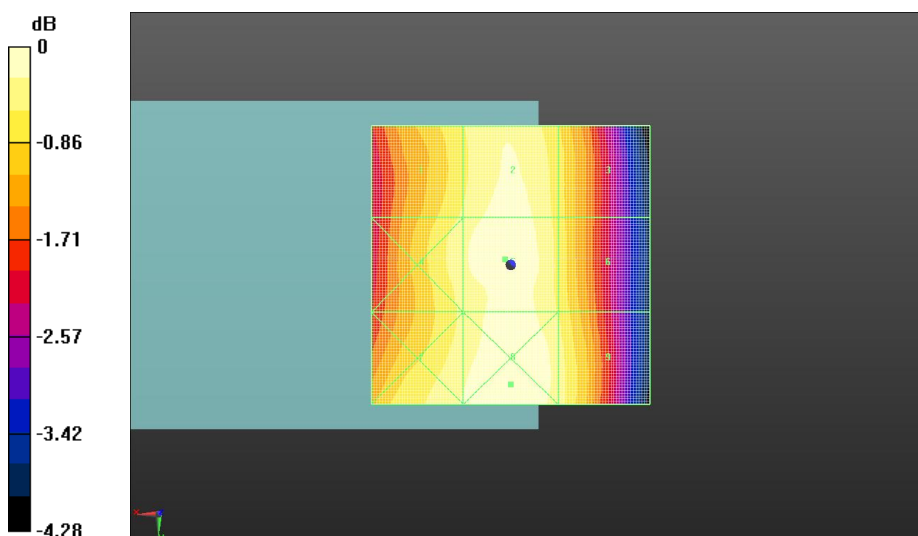

0 dB = 77.89 V/m = 37.83 dBV/m

Fig B.1 HAC RF E-Field GSM 850 High

HAC RF E-Field GSM 850 Middle

Date: 2017-10-8

Electronics: DAE4 Sn786

Medium: Air

Medium parameters used: $\sigma = 0$ S/m, $\epsilon_r = 1$; $\rho = 1000$ kg/m³

Ambient Temperature: 22.0°C Liquid Temperature: 21.5°C

Communication System: GSM Frequency: 836.6 MHz Duty Cycle: 1:8.3

Probe: ER3DV6 - SN2424 ConvF (1, 1, 1);

E Scan - ER3DV6 - 2011: 15 mm from Probe Center to the Device /Hearing Aid Compatibility

Test (101x101x1): Interpolated grid: dx=0.5000 mm, dy=0.5000 mm

Device Reference Point: 0, 0, -6.3 mm

Reference Value = 69.49 V/m; Power Drift = -0.04 dB

Applied MIF = 3.42 dB

RF audio interference level = 38.29 dBV/m

Emission category: M4

MIF scaled E-field

Grid 1 M4 37.95 dBV/m	Grid 2 M4 38.19 dBV/m	Grid 3 M4 37.59 dBV/m
Grid 4 M4 38.08 dBV/m	Grid 5 M4 38.29 dBV/m	Grid 6 M4 37.69 dBV/m
Grid 7 M4 38.13 dBV/m	Grid 8 M4 38.35 dBV/m	Grid 9 M4 37.96 dBV/m

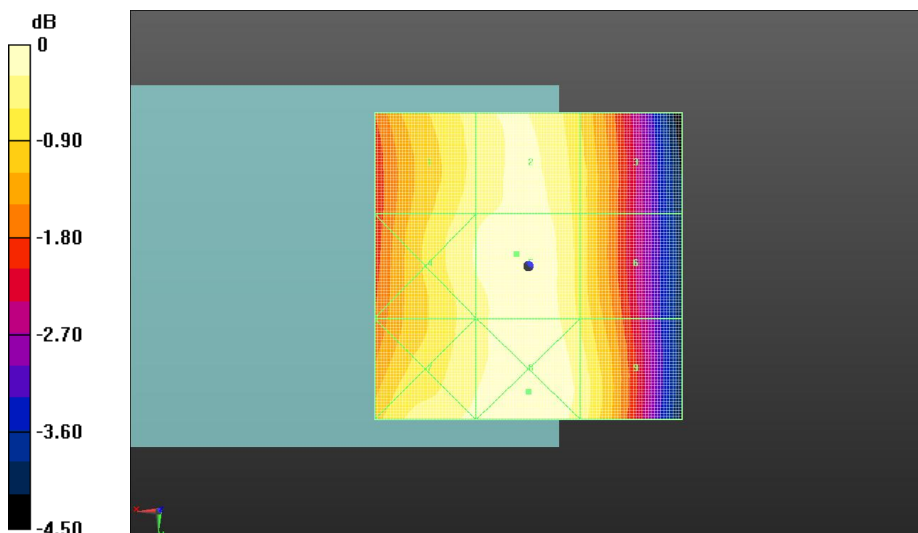

0 dB = 82.67 V/m = 38.35 dBV/m

Fig B.2 HAC RF E-Field GSM 850 Middle

HAC RF E-Field GSM 850 Low

Date: 2017-10-8

Electronics: DAE4 Sn786

Medium: Air

Medium parameters used: $\sigma = 0 \text{ S/m}$, $\epsilon_r = 1$; $\rho = 1000 \text{ kg/m}^3$

Ambient Temperature: 22.0°C Liquid Temperature: 21.5°C

Communication System: GSM Frequency: 824.2 MHz Duty Cycle: 1:8.3

Probe: ER3DV6 - SN2424 ConvF (1, 1, 1);

E Scan - ER3DV6 - 2011: 15 mm from Probe Center to the Device /Hearing Aid Compatibility

Test (101x101x1): Interpolated grid: dx=0.5000 mm, dy=0.5000 mm

Device Reference Point: 0, 0, -6.3 mm

Reference Value = 69.22 V/m; Power Drift = -0.01 dB

Applied MIF = 3.41 dB

RF audio interference level = 38.21 dBV/m

Emission category: M4

MIF scaled E-field

Grid 1 M4 37.88 dBV/m	Grid 2 M4 38.09 dBV/m	Grid 3 M4 37.35 dBV/m
Grid 4 M4 38.01 dBV/m	Grid 5 M4 38.21 dBV/m	Grid 6 M4 37.59 dBV/m
Grid 7 M4 38.04 dBV/m	Grid 8 M4 38.3 dBV/m	Grid 9 M4 37.87 dBV/m

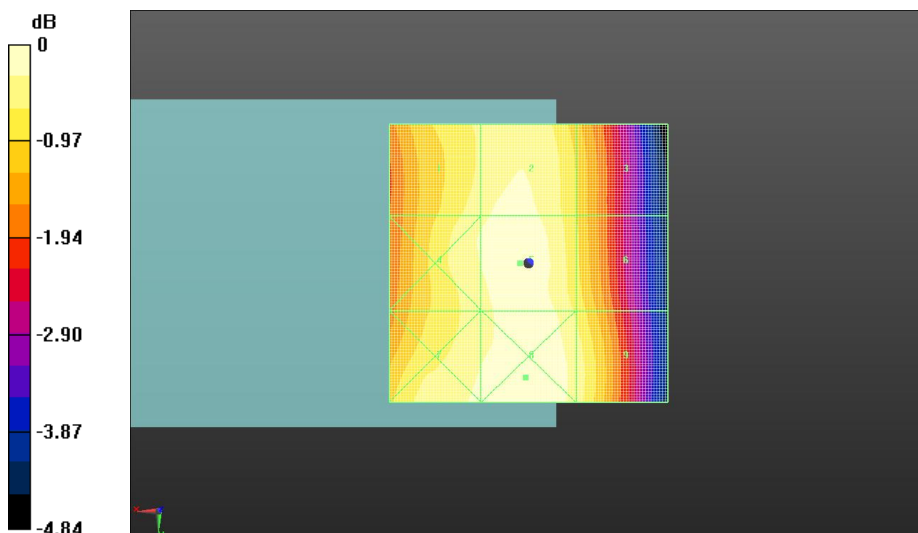

0 dB = 82.19 V/m = 38.30 dBV/m

Fig B.3 HAC RF E-Field GSM 850 Low

HAC RF E-Field GSM 1900 High

Date: 2017-10-8

Electronics: DAE4 Sn786

Medium: Air

Medium parameters used: $\sigma = 0$ S/m, $\epsilon_r = 1$; $\rho = 1000$ kg/m³

Ambient Temperature: 22.0°C Liquid Temperature: 21.5°C

Communication System: GSM Frequency: 1910 MHz Duty Cycle: 1:8.3

Probe: ER3DV6 - SN2424 ConvF (1, 1, 1);

E Scan - ER3DV6 - 2011: 15 mm from Probe Center to the Device /Hearing Aid Compatibility

Test (101x101x1): Interpolated grid: dx=0.5000 mm, dy=0.5000 mm

Device Reference Point: 0, 0, -6.3 mm

Reference Value = 20.70 V/m; Power Drift = 0.03 dB

Applied MIF = 3.43 dB

RF audio interference level = 30.79 dBV/m

Emission category: M3

MIF scaled E-field

Grid 1 M3 30.3 dBV/m	Grid 2 M4 28.95 dBV/m	Grid 3 M4 29.16 dBV/m
Grid 4 M4 26.47 dBV/m	Grid 5 M3 30.79 dBV/m	Grid 6 M3 30.84 dBV/m
Grid 7 M4 28.96 dBV/m	Grid 8 M3 31.88 dBV/m	Grid 9 M3 31.87 dBV/m

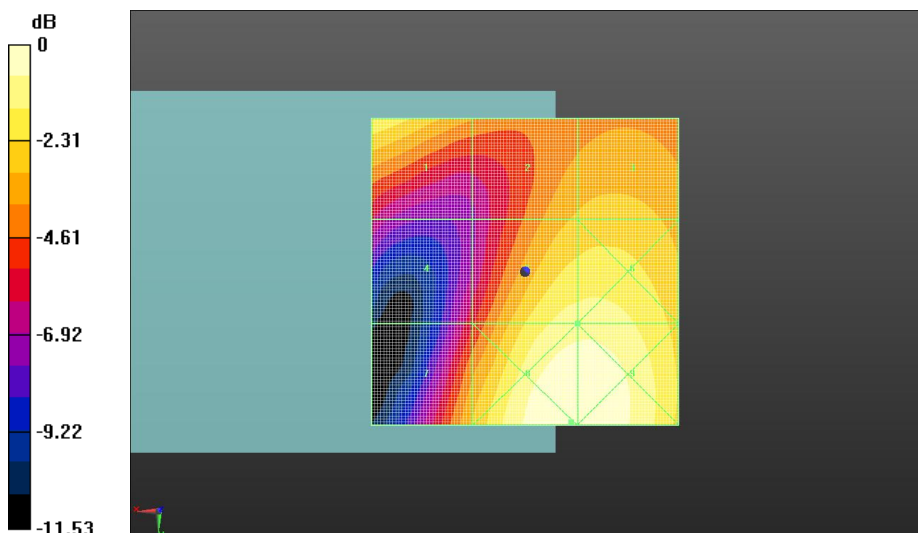

0 dB = 39.26 V/m = 31.88 dBV/m

Fig B.4 HAC RF E-Field GSM 1900 High

HAC RF E-Field GSM 1900 Middle

Date: 2017-10-8

Electronics: DAE4 Sn786

Medium: Air

Medium parameters used: $\sigma = 0$ S/m, $\epsilon_r = 1$; $\rho = 1000$ kg/m³

Ambient Temperature: 22.0°C Liquid Temperature: 21.5°C

Communication System: GSM Frequency: 1880 MHz Duty Cycle: 1:8.3

Probe: ER3DV6 - SN2424 ConvF (1, 1, 1);

E Scan - ER3DV6 - 2011: 15 mm from Probe Center to the Device /Hearing Aid Compatibility

Test (101x101x1): Interpolated grid: dx=0.5000 mm, dy=0.5000 mm

Device Reference Point: 0, 0, -6.3 mm

Reference Value = 17.25 V/m; Power Drift = 0.02 dB

Applied MIF = 3.44 dB

RF audio interference level = 30.84 dBV/m

Emission category: M3

MIF scaled E-field

Grid 1 M3 30.84 dBV/m	Grid 2 M4 27.64 dBV/m	Grid 3 M4 27.98 dBV/m
Grid 4 M4 26.78 dBV/m	Grid 5 M4 29.63 dBV/m	Grid 6 M4 29.69 dBV/m
Grid 7 M4 28.6 dBV/m	Grid 8 M3 30.9 dBV/m	Grid 9 M3 30.9 dBV/m

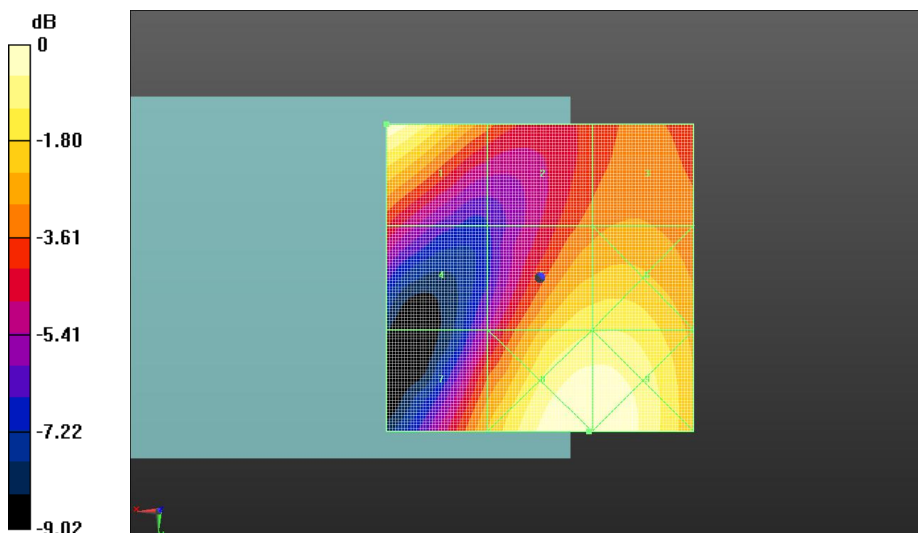

0 dB = 35.07 V/m = 30.90 dBV/m

Fig B.5 HAC RF E-Field GSM 1900 Middle

HAC RF E-Field GSM 1900 Low

Date: 2017-10-8

Electronics: DAE4 Sn786

Medium: Air

Medium parameters used: $\sigma = 0 \text{ S/m}$, $\epsilon_r = 1$; $\rho = 1000 \text{ kg/m}^3$

Ambient Temperature: 22.0°C Liquid Temperature: 21.5°C

Communication System: GSM Frequency: 1850.2 MHz Duty Cycle: 1:8.3

Probe: ER3DV6 - SN2424 ConvF (1, 1, 1);

E Scan - ER3DV6 - 2011: 15 mm from Probe Center to the Device /Hearing Aid Compatibility Test (101x101x1): Interpolated grid: dx=0.5000 mm, dy=0.5000 mm

Device Reference Point: 0, 0, -6.3 mm

Reference Value = 17.54 V/m; Power Drift = 0.09 dB

Applied MIF = 3.40 dB

RF audio interference level = 29.82 dBV/m

Emission category: M4

MIF scaled E-field

Grid 1 M4 29.55 dBV/m	Grid 2 M4 27.38 dBV/m	Grid 3 M4 27.97 dBV/m
Grid 4 M4 25.81 dBV/m	Grid 5 M4 29.82 dBV/m	Grid 6 M4 29.95 dBV/m
Grid 7 M4 28.25 dBV/m	Grid 8 M3 30.82 dBV/m	Grid 9 M3 30.83 dBV/m

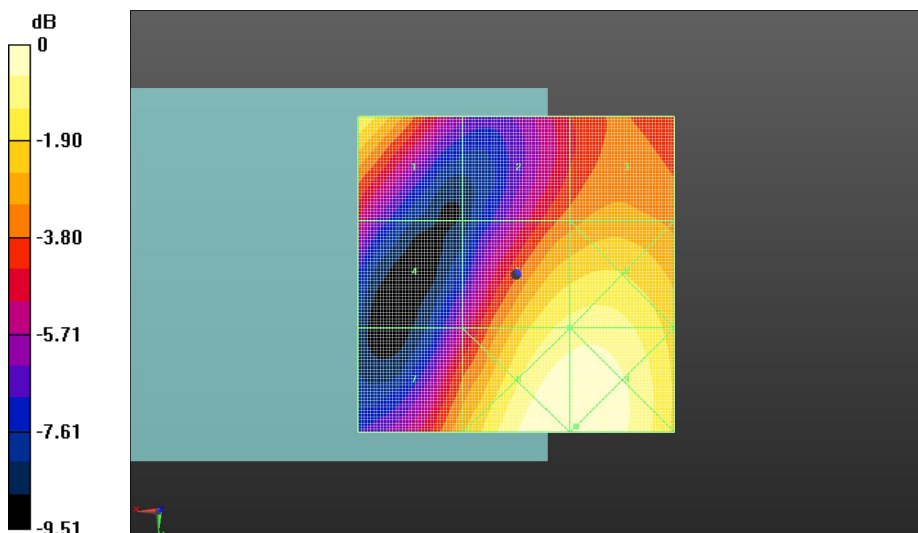

0 dB = 34.78 V/m = 30.83 dBV/m

Fig B.6 HAC RF E-Field GSM 1900 Low

HAC RF E-Field CDMA BC0 High

Date: 2017-10-8

Electronics: DAE4 Sn786

Medium: Air

Medium parameters used: $\sigma = 0 \text{ S/m}$, $\epsilon_r = 1$; $\rho = 1000 \text{ kg/m}^3$

Ambient Temperature: 22.0°C Liquid Temperature: 21.5°C

Communication System: CDMA Frequency: 848.31 MHz Duty Cycle: 1:1

Probe: ER3DV6 - SN2424 ConvF (1, 1, 1);

E Scan - ER3DV6 - 2011: 15 mm from Probe Center to the Device /Hearing Aid Compatibility

Test (101x101x1): Interpolated grid: dx=0.5000 mm, dy=0.5000 mm

Device Reference Point: 0, 0, -6.3 mm

Reference Value = 63.53 V/m; Power Drift = 0.10 dB

Applied MIF = 3.17 dB

RF audio interference level = 37.88 dBV/m

Emission category: M4

MIF scaled E-field

Grid 1 M4 36.9 dBV/m	Grid 2 M4 37.86 dBV/m	Grid 3 M4 37.84 dBV/m
Grid 4 M4 36.69 dBV/m	Grid 5 M4 37.88 dBV/m	Grid 6 M4 37.87 dBV/m
Grid 7 M4 36.22 dBV/m	Grid 8 M4 37.49 dBV/m	Grid 9 M4 37.48 dBV/m

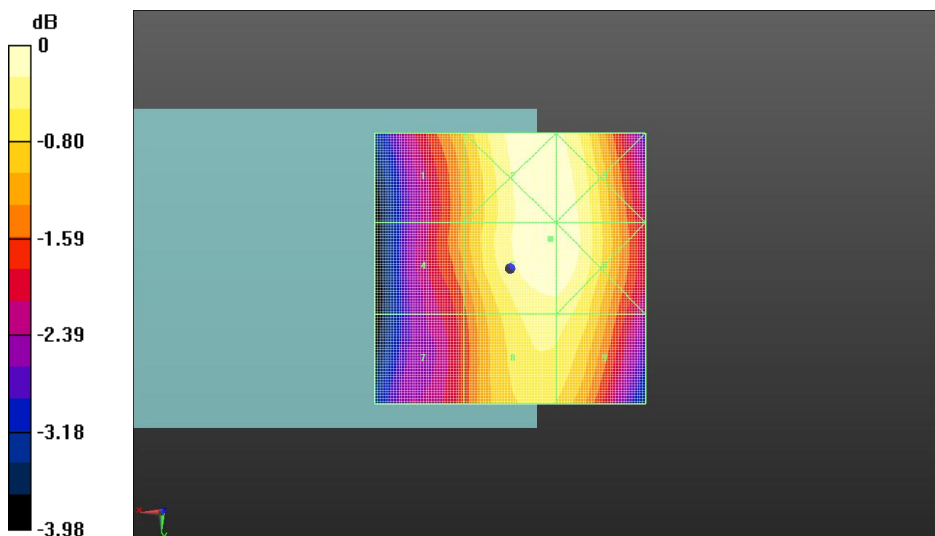

0 dB = 78.32 V/m = 37.88 dBV/m

Fig B.7 HAC RF E-Field CDMA BC0 High

HAC RF E-Field CDMA BC0 Middle

Date: 2017-10-8

Electronics: DAE4 Sn786

Medium: Air

Medium parameters used: $\sigma = 0$ S/m, $\epsilon_r = 1$; $\rho = 1000$ kg/m³

Ambient Temperature: 22.0oC Liquid Temperature: 21.5oC

Communication System: UID 0, CDMA (0) Frequency: 836.52 MHz Duty Cycle: 1:1

Probe: ER3DV6 - SN2424 ConvF (1, 1, 1);

E Scan - ER3DV6 - 2011: 15 mm from Probe Center to the Device /Hearing Aid Compatibility

Test (101x101x1): Interpolated grid: dx=0.5000 mm, dy=0.5000 mm

Device Reference Point: 0, 0, -6.3 mm

Reference Value = 66.68 V/m; Power Drift = 0.03 dB

Applied MIF = 3.15 dB

RF audio interference level = 37.98 dBV/m

Emission category: M4

MIF scaled E-field

Grid 1 M4 37.38 dBV/m	Grid 2 M4 38.05 dBV/m	Grid 3 M4 37.91 dBV/m
Grid 4 M4 37.16 dBV/m	Grid 5 M4 37.98 dBV/m	Grid 6 M4 37.92 dBV/m
Grid 7 M4 36.78 dBV/m	Grid 8 M4 37.64 dBV/m	Grid 9 M4 37.58 dBV/m

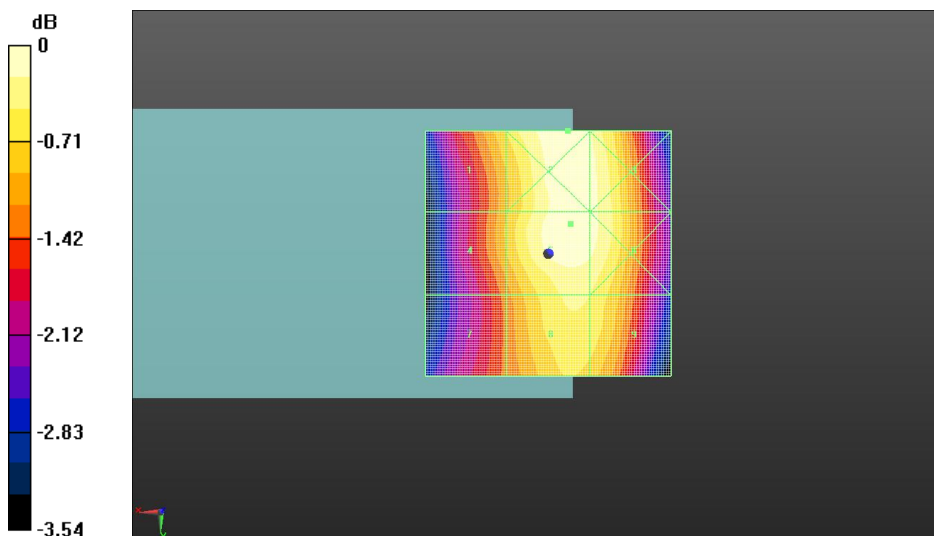

0 dB = 79.94 V/m = 38.06 dBV/m

Fig B.8 HAC RF E-Field CDMA BC0 Middle

HAC RF E-Field CDMA BC0 Low

Date: 2017-10-8

Electronics: DAE4 Sn786

Medium: Air

Medium parameters used: $\sigma = 0$ S/m, $\epsilon_r = 1$; $\rho = 1000$ kg/m³

Ambient Temperature: 22.0°C Liquid Temperature: 21.5°C

Communication System: UID 0, CDMA (0) Frequency: 824.7 MHz Duty Cycle: 1:1

Probe: ER3DV6 - SN2424 ConvF(1, 1, 1); Calibrated: 1/23/2015

E Scan - ER3DV6 - 2011: 15 mm from Probe Center to the Device /Hearing Aid Compatibility

Test (101x101x1): Interpolated grid: dx=0.5000 mm, dy=0.5000 mm

Device Reference Point: 0, 0, -6.3 mm

Reference Value = 66.50 V/m; Power Drift = 0.05 dB

Applied MIF = 3.14 dB

RF audio interference level = 37.97 dBV/m

Emission category: M4

MIF scaled E-field

Grid 1 M4 37.51 dBV/m	Grid 2 M4 38.03 dBV/m	Grid 3 M4 37.84 dBV/m
Grid 4 M4 37.28 dBV/m	Grid 5 M4 37.97 dBV/m	Grid 6 M4 37.83 dBV/m
Grid 7 M4 36.87 dBV/m	Grid 8 M4 37.65 dBV/m	Grid 9 M4 37.52 dBV/m

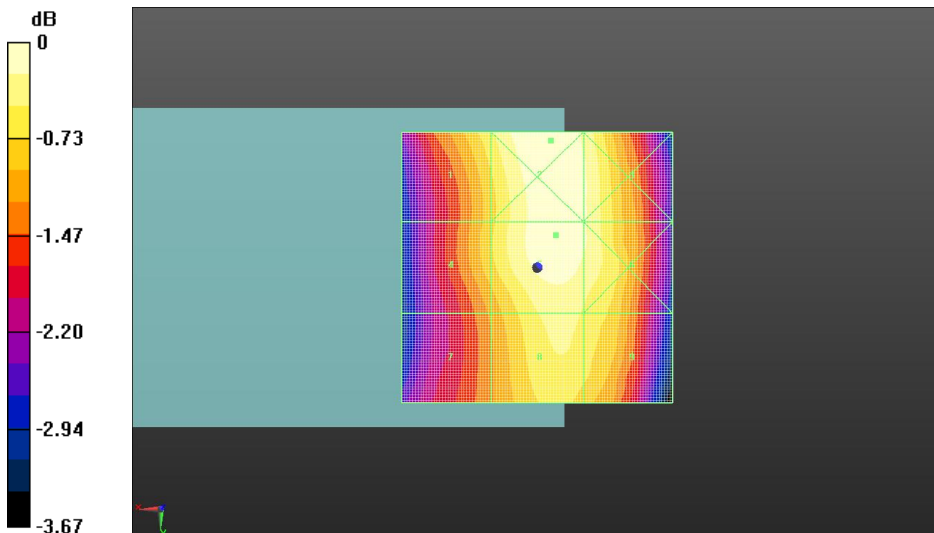

0 dB = 79.72 V/m = 38.03 dBV/m

Fig B.9 HAC RF E-Field CDMA BC0 Low

HAC RF E-Field CDMA BC1 High

Date: 2017-10-8

Electronics: DAE4 Sn786

Medium: Air

Medium parameters used: $\sigma = 0$ S/m, $\epsilon_r = 1$; $\rho = 1000$ kg/m³

Ambient Temperature: 22.0°C Liquid Temperature: 21.5°C

Communication System: UID 0, CDMA (0) Frequency: 1908.75 MHz Duty Cycle: 1:1

Probe: ER3DV6 - SN2424 ConvF (1, 1, 1);

E Scan - ER3DV6 - 2011: 15 mm from Probe Center to the Device /Hearing Aid Compatibility

Test (101x101x1): Interpolated grid: dx=0.5000 mm, dy=0.5000 mm

Device Reference Point: 0, 0, -6.3 mm

Reference Value = 29.33 V/m; Power Drift = -0.07 dB

Applied MIF = 3.15 dB

RF audio interference level = 34.69 dBV/m

Emission category: M3

MIF scaled E-field

Grid 1 M3 32.95 dBV/m	Grid 2 M3 32.14 dBV/m	Grid 3 M3 33.19 dBV/m
Grid 4 M3 30.22 dBV/m	Grid 5 M3 34.69 dBV/m	Grid 6 M2 35.33 dBV/m
Grid 7 M3 30.97 dBV/m	Grid 8 M2 35.49 dBV/m	Grid 9 M2 35.94 dBV/m

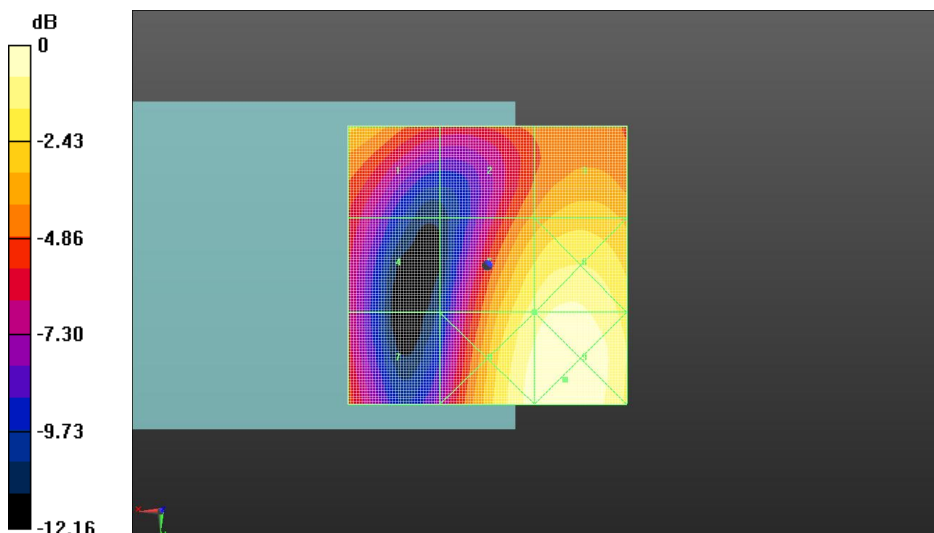

0 dB = 62.67 V/m = 35.94 dBV/m

Fig B.10 HAC RF E-Field CDMA BC1 High

HAC RF E-Field CDMA BC1 Middle

Date: 2017-10-8

Electronics: DAE4 Sn786

Medium: Air

Medium parameters used: $\sigma = 0 \text{ S/m}$, $\epsilon_r = 1$; $\rho = 1000 \text{ kg/m}^3$

Ambient Temperature: 22.0°C Liquid Temperature: 21.5°C

Communication System: UID 0, CDMA (0) Frequency: 1880 MHz Duty Cycle: 1:1

Probe: ER3DV6 - SN2424 ConvF(1, 1, 1);

E Scan - ER3DV6 - 2011: 15 mm from Probe Center to the Device /Hearing Aid Compatibility

Test (101x101x1): Interpolated grid: dx=0.5000 mm, dy=0.5000 mm

Device Reference Point: 0, 0, -6.3 mm

Reference Value = 24.94 V/m; Power Drift = 0.07 dB

Applied MIF = 3.14 dB

RF audio interference level = 34.41 dBV/m

Emission category: M3

MIF scaled E-field

Grid 1 M3 32.86 dBV/m	Grid 2 M3 31.8 dBV/m	Grid 3 M3 32.62 dBV/m
Grid 4 M4 29.58 dBV/m	Grid 5 M3 34.41 dBV/m	Grid 6 M3 34.93 dBV/m
Grid 7 M4 29.2 dBV/m	Grid 8 M2 35.49 dBV/m	Grid 9 M2 35.78 dBV/m

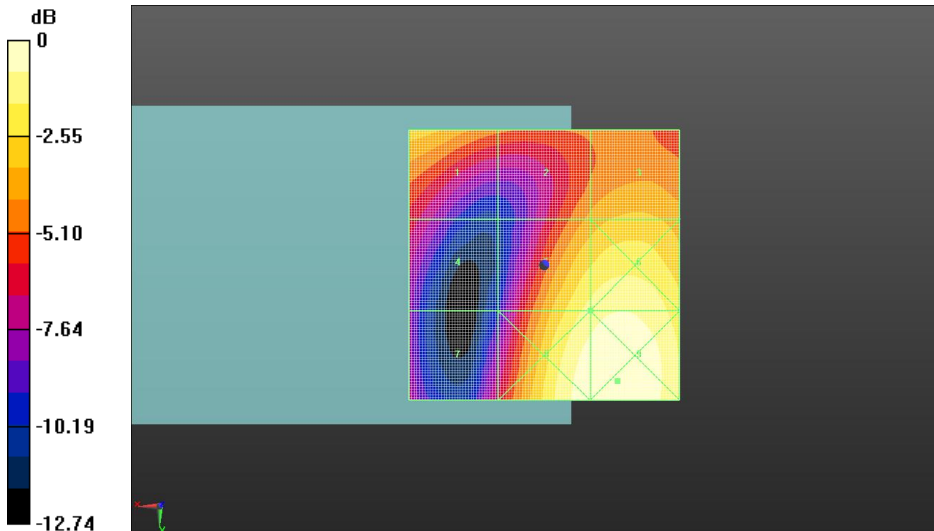

0 dB = 61.55 V/m = 35.78 dBV/m

Fig B.11 HAC RF E-Field CDMA BC1 Middle

HAC RF E-Field CDMA BC1 Low

Date: 2017-10-8

Electronics: DAE4 Sn786

Medium: Air

Medium parameters used: $\sigma = 0 \text{ S/m}$, $\epsilon_r = 1$; $\rho = 1000 \text{ kg/m}^3$

Ambient Temperature: 22.0°C Liquid Temperature: 21.5°C

Communication System: UID 0, CDMA (0) Frequency: 1851.25 MHz Duty Cycle: 1:1

Probe: ER3DV6 - SN2424 ConvF (1, 1, 1);

E Scan - ER3DV6 - 2011: 15 mm from Probe Center to the Device /Hearing Aid Compatibility

Test (101x101x1): Interpolated grid: dx=0.5000 mm, dy=0.5000 mm

Device Reference Point: 0, 0, -6.3 mm

Reference Value = 32.08 V/m; Power Drift = 0.06 dB

Applied MIF = 3.12 dB

RF audio interference level = 34.85 dBV/m

Emission category: M3

MIF scaled E-field

Grid 1 M3 32.51 dBV/m	Grid 2 M3 32.33 dBV/m	Grid 3 M3 32.95 dBV/m
Grid 4 M4 28.93 dBV/m	Grid 5 M3 34.85 dBV/m	Grid 6 M2 35.19 dBV/m
Grid 7 M3 30.91 dBV/m	Grid 8 M2 35.76 dBV/m	Grid 9 M2 35.94 dBV/m

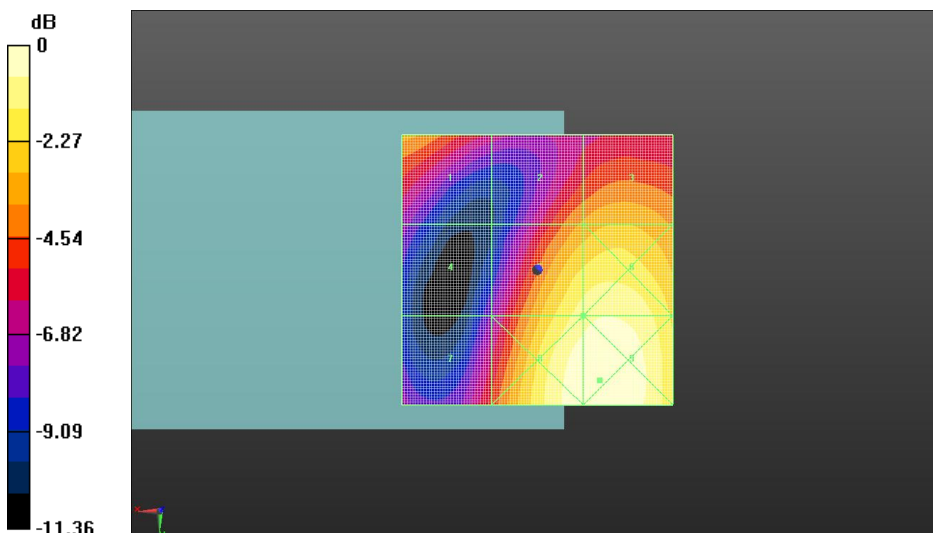

0 dB = 62.71 V/m = 35.95 dBV/m

Fig B.12 HAC RF E-Field CDMA BC1 Low

HAC RF E-Field CDMA BC10 High

Date: 2017-10-8

Electronics: DAE4 Sn786

Medium: Air

Medium parameters used: $\sigma = 0$ S/m, $\epsilon_r = 1$; $\rho = 1000$ kg/m³

Ambient Temperature: 22.0°C Liquid Temperature: 21.5°C

Communication System: UID 0, CDMA (0) Frequency: 823.1 MHz Duty Cycle: 1:1

Probe: ER3DV6 - SN2424 ConvF (1, 1, 1);

E Scan - ER3DV6 - 2011: 15 mm from Probe Center to the Device /Hearing Aid Compatibility

Test (101x101x1): Interpolated grid: dx=0.5000 mm, dy=0.5000 mm

Device Reference Point: 0, 0, -6.3 mm

Reference Value = 68.34 V/m; Power Drift = 0.02 dB

Applied MIF = 3.17 dB

RF audio interference level = 38.19 dBV/m

Emission category: M4

MIF scaled E-field

Grid 1 M4 37.79 dBV/m	Grid 2 M4 38.21 dBV/m	Grid 3 M4 38.06 dBV/m
Grid 4 M4 37.48 dBV/m	Grid 5 M4 38.19 dBV/m	Grid 6 M4 38.06 dBV/m
Grid 7 M4 37.09 dBV/m	Grid 8 M4 37.84 dBV/m	Grid 9 M4 37.7 dBV/m

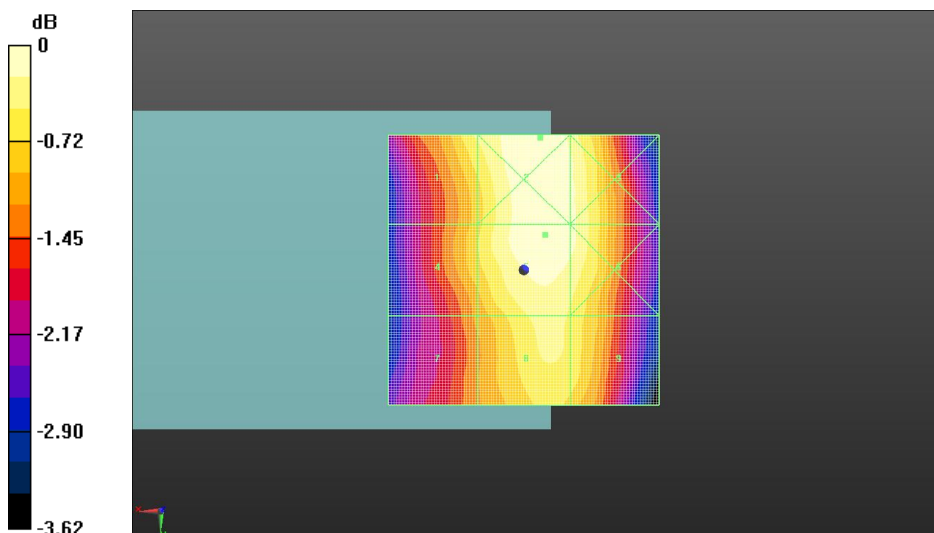

0 dB = 81.41 V/m = 38.21 dBV/m

Fig B.13 HAC RF E-Field CDMA BC10 High

HAC RF E-Field CDMA BC10 Middle

Date: 2017-10-8

Electronics: DAE4 Sn786

Medium: Air

Medium parameters used: $\sigma = 0$ S/m, $\epsilon_r = 1$; $\rho = 1000$ kg/m³

Ambient Temperature: 22.0°C Liquid Temperature: 21.5°C

Communication System: UID 0, CDMA (0) Frequency: 820.5 MHz Duty Cycle: 1:1

Probe: ER3DV6 - SN2424 ConvF (1, 1, 1);

E Scan - ER3DV6 - 2011: 15 mm from Probe Center to the Device /Hearing Aid Compatibility

Test (101x101x1): Interpolated grid: dx=0.5000 mm, dy=0.5000 mm

Device Reference Point: 0, 0, -6.3 mm

Reference Value = 67.77 V/m; Power Drift = -0.05 dB

Applied MIF = 3.16 dB

RF audio interference level = 38.07 dBV/m

Emission category: M4

MIF scaled E-field

Grid 1 M4 37.62 dBV/m	Grid 2 M4 38.12 dBV/m	Grid 3 M4 37.94 dBV/m
Grid 4 M4 37.37 dBV/m	Grid 5 M4 38.07 dBV/m	Grid 6 M4 37.89 dBV/m
Grid 7 M4 36.98 dBV/m	Grid 8 M4 37.68 dBV/m	Grid 9 M4 37.58 dBV/m

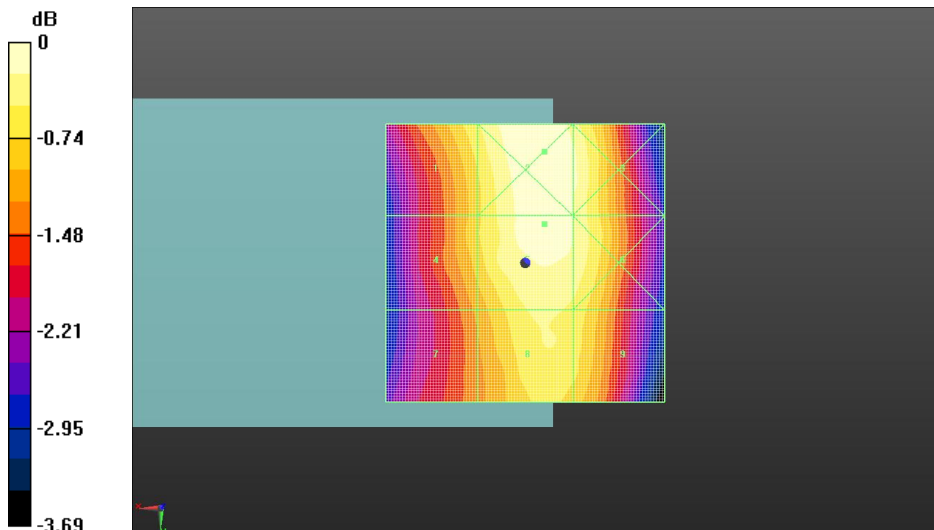

0 dB = 80.56 V/m = 38.12 dBV/m

Fig B.14 HAC RF E-Field CDMA BC10 Middle

HAC RF E-Field CDMA BC10 Low

Date: 2017-10-8

Electronics: DAE4 Sn786

Medium: Air

Medium parameters used: $\sigma = 0$ S/m, $\epsilon_r = 1$; $\rho = 1000$ kg/m³

Ambient Temperature: 22.0°C Liquid Temperature: 21.5°C

Communication System: UID 0, CDMA (0) Frequency: 817.9 MHz Duty Cycle: 1:1

Probe: ER3DV6 - SN2424 ConvF (1, 1, 1);

E Scan - ER3DV6 - 2011: 15 mm from Probe Center to the Device /Hearing Aid Compatibility

Test (101x101x1): Interpolated grid: dx=0.5000 mm, dy=0.5000 mm

Device Reference Point: 0, 0, -6.3 mm

Reference Value = 68.20 V/m; Power Drift = -0.03 dB

Applied MIF = 3.14 dB

RF audio interference level = 38.09 dBV/m

Emission category: M4

MIF scaled E-field

Grid 1 M4 37.68 dBV/m	Grid 2 M4 38.16 dBV/m	Grid 3 M4 37.96 dBV/m
Grid 4 M4 37.44 dBV/m	Grid 5 M4 38.09 dBV/m	Grid 6 M4 37.94 dBV/m
Grid 7 M4 37.03 dBV/m	Grid 8 M4 37.76 dBV/m	Grid 9 M4 37.64 dBV/m

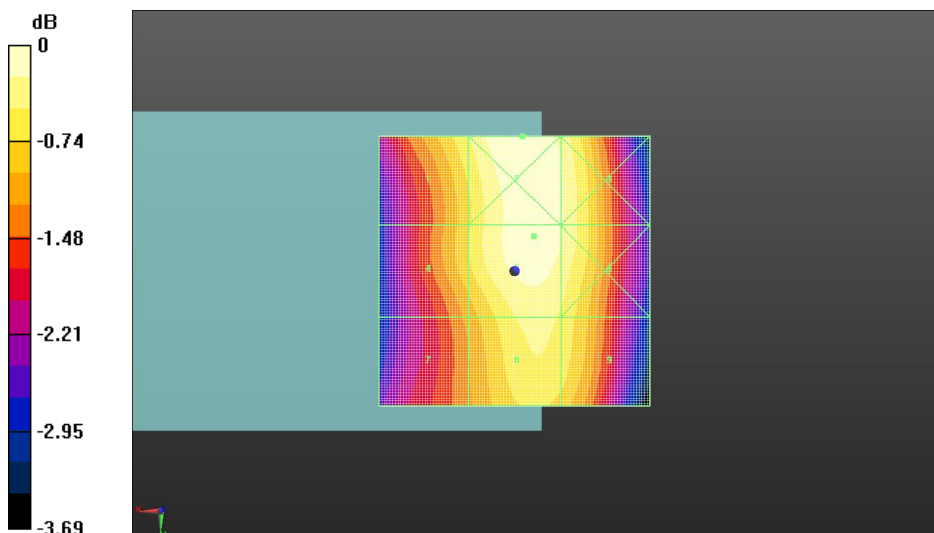

0 dB = 80.91 V/m = 38.16 dBV/m

Fig B.15 HAC RF E-Field CDMA BC10 Low

HAC RF E-Field LTE-Band 41 High

Date: 2017-10-14

Electronics: DAE4 Sn786

Medium: Air

Medium parameters used: $\sigma = 0$ S/m, $\epsilon_r = 1$; $\rho = 1000$ kg/m³

Ambient Temperature: 22.0°C Liquid Temperature: 21.5°C

Communication System: UID 0, LTE_TDD (0) Frequency: 2680 MHz Duty Cycle: 1:1.58

Probe: ER3DV6 - SN2424 ConvF (1, 1, 1);

E Scan - ER3DV6 - 2011: 15 mm from Probe Center to the Device /Hearing Aid Compatibility

Test (101x101x1): Interpolated grid: dx=0.5000 mm, dy=0.5000 mm

Device Reference Point: 0, 0, -6.3 mm

Reference Value = 7.555 V/m; Power Drift = -0.08 dB

Applied MIF = -1.52 dB

RF audio interference level = 21.63 dBV/m

Emission category: M4

MIF scaled E-field

Grid 1 M4 23 dBV/m	Grid 2 M4 23.9 dBV/m	Grid 3 M4 24.03 dBV/m
Grid 4 M4 21.54 dBV/m	Grid 5 M4 20.72 dBV/m	Grid 6 M4 21.63 dBV/m
Grid 7 M4 19.71 dBV/m	Grid 8 M4 19.53 dBV/m	Grid 9 M4 19.91 dBV/m

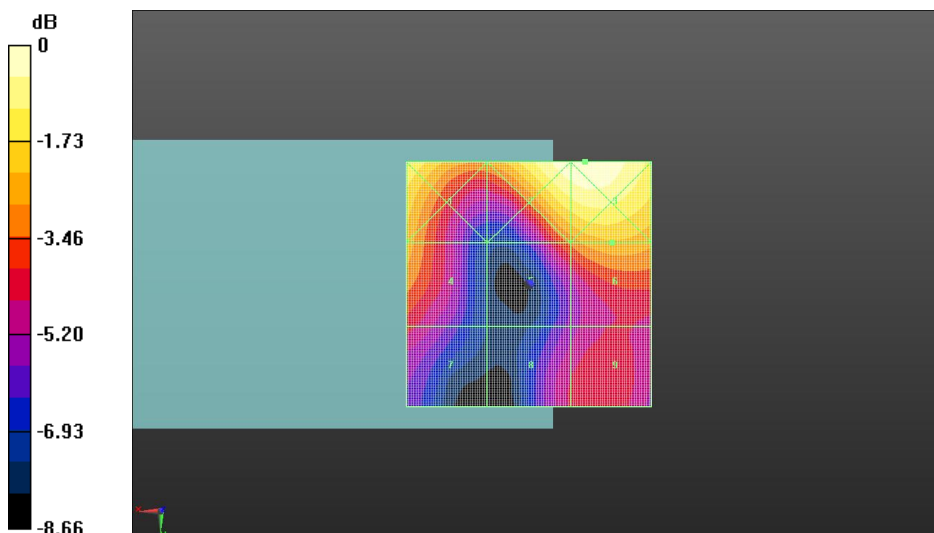

0 dB = 15.90 V/m = 24.03 dBV/m

Fig B.16 HAC RF E-Field LTE-Band 41 High

HAC RF E-Field LTE-Band 41 High-2

Date: 2017-10-14

Electronics: DAE4 Sn786

Medium: Air

Medium parameters used: $\sigma = 0$ S/m, $\epsilon_r = 1$; $\rho = 1000$ kg/m³

Ambient Temperature: 22.0°C Liquid Temperature: 21.5°C

Communication System: UID 0, LTE_TDD (0) Frequency: 2636.5 MHz Duty Cycle: 1:1.58

Probe: ER3DV6 - SN2424 ConvF (1, 1, 1);

E Scan - ER3DV6 - 2011: 15 mm from Probe Center to the Device /Hearing Aid Compatibility

Test (101x101x1): Interpolated grid: dx=0.5000 mm, dy=0.5000 mm

Device Reference Point: 0, 0, -6.3 mm

Reference Value = 7.487 V/m; Power Drift = -0.03 dB

Applied MIF = -1.54 dB

RF audio interference level = 21.58 dBV/m

Emission category: M4

MIF scaled E-field

Grid 1 M4 23.1 dBV/m	Grid 2 M4 23.7 dBV/m	Grid 3 M4 24.01 dBV/m
Grid 4 M4 21.54 dBV/m	Grid 5 M4 20.71 dBV/m	Grid 6 M4 21.58 dBV/m
Grid 7 M4 19.70 dBV/m	Grid 8 M4 19.52 dBV/m	Grid 9 M4 19.88 dBV/m

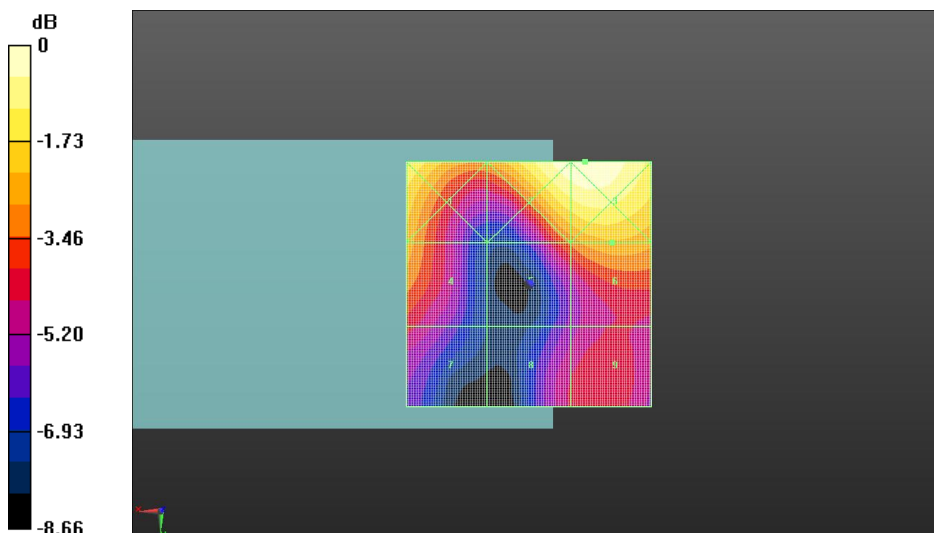

0 dB = 15.87 V/m = 24.01 dBV/m

Fig B.17 HAC RF E-Field LTE-Band 41 High-2