



RF Test Report

Applicant : Reliance Communications LLC
Product Type : GSM/CDMA/WCDMA/LTE mobile phone
Trade Name : Orbic
Model Number : RC555L
Test Specification : FCC 47 CFR PART 22H
FCC 47 CFR PART 24E
FCC 47 CFR PART 27
FCC 47 CFR PART 90S
ANSI/TIA-603-D 2010

Receive Date : Sep. 07, 2017
Test Period : Sep. 25 ~ Sep. 27, 2017
Issue Date : Oct. 16, 2017

Issue by

A Test Lab Techno Corp.
No. 140-1, Changan Street, Bade District,
Taoyuan City 33465, Taiwan (R.O.C)
Tel : +886-3-2710188 / Fax : +886-3-2710190



Taiwan Accreditation Foundation accreditation number: 1330

Test Firm MRA designation number: TW0010

Note: This report shall not be reproduced except in full, without the written approval of A Test Lab Techno Corp. This document may be altered or revised by A Test Lab Techno Corp. personnel only, and shall be noted in the revision section of the document. The client should not use it to claim product endorsement by TAF, or any government agencies. The test results in the report only apply to the tested sample.



Revision History

Rev.	Issue Date	Revisions	Revised By
00	Oct. 02, 2017	Initial Issue	Nina Lin
01	Oct. 16, 2017	Revised report information	Nina Lin

Verification of Compliance

Issued Date: Oct. 16, 2017

Applicant : Reliance Communications LLC
Product Type : GSM/CDMA/WCDMA/LTE mobile phone
Trade Name : Orbic
Model Number : RC555L
FCC ID : 2ABGH-RC555L
EUT Rated Voltage : DC 5V, 2A or DC 9V, 2A
Test Voltage : 120 Vac / 60 Hz
Applicable Standard : FCC 47 CFR PART 22H
FCC 47 CFR PART 24E
FCC 47 CFR PART 27
FCC 47 CFR PART 90S
ANSI/TIA-603-D 2010

Test Result : Complied

Performing Lab. : A Test Lab Techno Corp.
No. 140-1, Changan Street, Bade District,
Taoyuan City 33465, Taiwan (R.O.C)
Tel : +886-3-2710188 / Fax : +886-3-2710190



Taiwan Accreditation Foundation accreditation number: 1330
<http://www.atl-lab.com.tw/e-index.htm>

A Test Lab Techno Corp. tested the above equipment in accordance with the requirements set forth in the above standards. All indications of Pass/Fail in this report are opinions expressed by A Test Lab Techno Corp. based on interpretations and/or observations of test results. Measurement Uncertainties were not taken into account and are published for informational purposes only. The test results show that the equipment tested is capable of demonstrating compliance with the requirements as documented in this report.

Approved By : Fly Lu Reviewed By : Eric Ou Yang
(Manager) (Fly Lu) (Testing Engineer) (Eric Ou Yang)



TABLE OF CONTENTS

1	General Information	5
1.1.	EUT Description	5
1.2.	Mode of Operation	10
1.3.	EUT Exercise Software	15
1.4.	Configuration of Test System Details	15
1.5.	Test Instruments	16
1.6.	Test Site Environment	16
1.7.	Summary of Test Result	17
2	Measurement Procedure	18
2.1.	Effective Radiated Power / Equivalent Isotropic Radiated Power Test	18
2.2.	Radiated Emission Test	21
3	Test Results	23
	Effective Radiated Power / Equivalent Isotropic Radiated Power	23
	Radiated Emission	32



1 General Information

1.1. EUT Description

Applicant	Reliance Communications LLC 555 Wireless Blvd, Hauppauge, New York, 11788, United States		
Manufacturer	Unimaxcomm Room 602, Building-B, Shenzhen Software Park T3, Hi-Tech Park South, Nan Shan District, Shenzhen, China		
Product Type	GSM/CDMA/WCDMA/LTE mobile phone		
Trade Name	Orbic		
Model Number	RC555L		
FCC ID	2ABGH-RC555L		
IMEI No.	358924080001802		
Operate Band	Frequency Range (MHz)	Modulation	Channel Bandwidth
LTE Band 2	UL: 1850.7 ~ 1909.3	QPSK, 16QAM	1.4M, 3M, 5MHz, 10MHz, 15MHz, 20MHz
	DL: 1930.7 ~ 1989.3	QPSK, 16QAM	
LTE Band 4	UL: 1710.7 ~ 1754.3	QPSK, 16QAM	1.4M, 3M, 5MHz, 10MHz, 15MHz, 20MHz
	DL: 2110.7 ~ 2154.3	QPSK, 16QAM	
LTE Band 5	UL: 824.7 ~ 848.3	QPSK, 16QAM	1.4M, 3M, 5MHz, 10MHz
	DL: 869.7 ~ 893.3	QPSK, 16QAM	
LTE Band 12	UL: 699 ~ 716	QPSK, 16QAM	1.4M, 3M, 5MHz, 10MHz
	DL: 729 ~ 746	QPSK, 16QAM	
LTE Band 13	UL: 777 ~ 787	QPSK, 16QAM	5MHz, 10MHz
	DL: 746 ~ 756	QPSK, 16QAM	
LTE Band 17	UL: 704.0 ~ 715.9	QPSK, 16QAM	5MHz, 10MHz
	DL: 734.0 ~ 745.9	QPSK, 16QAM	
LTE Band 25	UL: 1852.5 ~ 1912.5	QPSK, 16QAM	1.4M, 3M, 5MHz, 10MHz, 15MHz, 20MHz
	DL: 1932.5 ~ 1992.5	QPSK, 16QAM	
LTE Band 26(Part 22)	UL: 824.7~ 848.3	QPSK, 16QAM	1.4M, 3M, 5MHz, 10MHz, 15MHz
	DL: 861.5 ~ 891.5	QPSK, 16QAM	
LTE Band 26(Part 90S)	UL: 814.7 ~ 823.3	QPSK, 16QAM	1.4M, 3M, 5MHz, 10MHz,
	DL: 861.5 ~ 891.5	QPSK, 16QAM	
LTE Band 41	UL/DL: 2498.5 ~ 2687.5	QPSK, 16QAM	5MHz, 10MHz, 15MHz, 20MHz



Type of Antenna	LDS Antenna	
Antenna Gain	LTE Band 2	1 dBi
	LTE Band 4	0.5 dBi
	LTE Band 5	-1 dBi
	LTE Band 12	-1.5 dBi
	LTE Band 13	-1.5 dBi
	LTE Band 17	-1.5 dBi
	LTE Band 25	1 dBi
	LTE Band 26	-1 dBi
	LTE Band 41	1.5 dBi
Operate Temp. Range	-10 ~ 40 °C	



Band	Channel Bandwidth	Modulation	E.R.P. /E.I.R.P.
			(W)
LTE Band2	1.4MHz	QPSK	0.069
LTE Band2	1.4MHz	16QAM	0.048
LTE Band2	3MHz	QPSK	0.080
LTE Band2	3MHz	16QAM	0.051
LTE Band2	5MHz	QPSK	0.069
LTE Band2	5MHz	16QAM	0.054
LTE Band2	10MHz	QPSK	0.073
LTE Band2	10MHz	16QAM	0.049
LTE Band2	15MHz	QPSK	0.071
LTE Band2	15MHz	16QAM	0.050
LTE Band2	20MHz	QPSK	0.097
LTE Band2	20MHz	16QAM	0.055
LTE Band4	1.4MHz	QPSK	0.073
LTE Band4	1.4MHz	16QAM	0.056
LTE Band4	3MHz	QPSK	0.078
LTE Band4	3MHz	16QAM	0.048
LTE Band4	5MHz	QPSK	0.089
LTE Band4	5MHz	16QAM	0.055
LTE Band4	10MHz	QPSK	0.093
LTE Band4	10MHz	16QAM	0.043
LTE Band4	15MHz	QPSK	0.083
LTE Band4	15MHz	16QAM	0.040
LTE Band4	20MHz	QPSK	0.077
LTE Band4	20MHz	16QAM	0.032
LTE Band5	1.4MHz	QPSK	0.065
LTE Band5	1.4MHz	16QAM	0.053
LTE Band5	3MHz	QPSK	0.070
LTE Band5	3MHz	16QAM	0.051
LTE Band5	5MHz	QPSK	0.056
LTE Band5	5MHz	16QAM	0.044
LTE Band5	10MHz	QPSK	0.063
LTE Band5	10MHz	16QAM	0.038



Band	Channel Bandwidth	Modulation	E.R.P. /E.I.R.P.
			(W)
LTE Band12	1.4MHz	QPSK	0.068
LTE Band12	1.4MHz	16QAM	0.040
LTE Band12	3MHz	QPSK	0.054
LTE Band12	3MHz	16QAM	0.035
LTE Band12	5MHz	QPSK	0.051
LTE Band12	5MHz	16QAM	0.037
LTE Band12	10MHz	QPSK	0.065
LTE Band12	10MHz	16QAM	0.036
LTE Band13	5MHz	QPSK	0.058
LTE Band13	5MHz	16QAM	0.040
LTE Band13	10MHz	QPSK	0.059
LTE Band13	10MHz	16QAM	0.037
LTE Band17	5MHz	QPSK	0.069
LTE Band17	5MHz	16QAM	0.025
LTE Band17	10MHz	QPSK	0.070
LTE Band17	10MHz	16QAM	0.032
LTE Band25	1.4MHz	QPSK	0.034
LTE Band25	1.4MHz	16QAM	0.033
LTE Band25	3MHz	QPSK	0.050
LTE Band25	3MHz	16QAM	0.051
LTE Band25	5MHz	QPSK	0.085
LTE Band25	5MHz	16QAM	0.058
LTE Band25	10MHz	QPSK	0.091
LTE Band25	10MHz	16QAM	0.046
LTE Band25	15MHz	QPSK	0.051
LTE Band25	15MHz	16QAM	0.052
LTE Band25	20MHz	QPSK	0.052
LTE Band25	20MHz	16QAM	0.048



Band	Channel Bandwidth	Modulation	E.R.P. /E.I.R.P.
			(W)
LTE Band26(Part 22)	1.4MHz	QPSK	0.052
LTE Band26(Part 22)	1.4MHz	16QAM	0.051
LTE Band26(Part 22)	3MHz	QPSK	0.055
LTE Band26(Part 22)	3MHz	16QAM	0.064
LTE Band26(Part 22)	5MHz	QPSK	0.063
LTE Band26(Part 22)	5MHz	16QAM	0.060
LTE Band26(Part 22)	10MHz	QPSK	0.063
LTE Band26(Part 22)	10MHz	16QAM	0.051
LTE Band26(Part 22)	15MHz	QPSK	0.065
LTE Band26(Part 22)	15MHz	16QAM	0.064
LTE Band26(Part 90S)	1.4MHz	QPSK	0.064
LTE Band26(Part 90S)	1.4MHz	16QAM	0.063
LTE Band26(Part 90S)	3MHz	QPSK	0.056
LTE Band26(Part 90S)	3MHz	16QAM	0.052
LTE Band26(Part 90S)	5MHz	QPSK	0.059
LTE Band26(Part 90S)	5MHz	16QAM	0.052
LTE Band26(Part 90S)	10MHz	QPSK	0.032
LTE Band26(Part 90S)	10MHz	16QAM	0.039
LTE Band41	5MHz	QPSK	0.055
LTE Band41	5MHz	16QAM	0.032
LTE Band41	10MHz	QPSK	0.058
LTE Band41	10MHz	16QAM	0.035
LTE Band41	15MHz	QPSK	0.056
LTE Band41	15MHz	16QAM	0.040
LTE Band41	20MHz	QPSK	0.063
LTE Band41	20MHz	16QAM	0.040

1.2. Mode of Operation

Three channels had been tested for each channel bandwidth.

LTE Band 2						
Channel Bandwidth	1.4MHz		3MHz		5MHz	
	Channel	Frequency (MHz)	Channel	Frequency (MHz)	Channel	Frequency (MHz)
Low CH	18607	1850.7	18615	1851.5	18625	1852.5
Middle CH	18900	1880.0	18900	1880.0	18900	1880.0
High CH	19193	1909.3	19185	1908.5	19175	1907.5
Channel Bandwidth	10MHz		15MHz		20MHz	
	Channel	Frequency (MHz)	Channel	Frequency (MHz)	Channel	Frequency (MHz)
Low CH	18650	1855.0	18675	1857.5	18700	1860.0
Middle CH	18900	1880.0	18900	1880.0	18900	1880.0
High CH	19150	1905.0	19125	1902.5	19100	1900.0

LTE Band 4						
Channel Bandwidth	1.4MHz		3MHz		5MHz	
	Channel	Frequency (MHz)	Channel	Frequency (MHz)	Channel	Frequency (MHz)
Low CH	19957	1710.7	19965	1711.5	19975	1712.5
Middle CH	20175	1732.5	20175	1732.5	20175	1732.5
High CH	20393	1754.3	20385	1753.5	20375	1752.5
Channel Bandwidth	10MHz		15MHz		20MHz	
	Channel	Frequency (MHz)	Channel	Frequency (MHz)	Channel	Frequency (MHz)
Low CH	20000	1715.0	20025	1717.5	20050	1720.0
Middle CH	20175	1732.5	20175	1732.5	20175	1732.5
High CH	20350	1750.0	20325	1747.5	20300	1745.0



LTE Band 5				
Channel Bandwidth	1.4MHz		3MHz	
	Channel	Frequency (MHz)	Channel	Frequency (MHz)
Low CH	20407	824.7	20415	825.5
Middle CH	20525	836.5	20525	836.5
High CH	20643	848.3	20635	847.5
Channel Bandwidth	5MHz		10MHz	
	Channel	Frequency (MHz)	Channel	Frequency (MHz)
Low CH	20425	826.5	20450	829.0
Middle CH	20525	836.5	20525	836.5
High CH	20625	846.5	20600	844.0

LTE Band 12				
Channel Bandwidth	1.4MHz		3MHz	
	Channel	Frequency (MHz)	Channel	Frequency (MHz)
Low CH	23017	699.7	23025	700.5
Middle CH	23095	707.5	23095	707.5
High CH	23173	715.3	23165	714.5
Channel Bandwidth	5MHz		10MHz	
	Channel	Frequency (MHz)	Channel	Frequency (MHz)
Low CH	23035	701.5	23060	704.0
Middle CH	23095	707.5	23095	707.5
High CH	23155	713.5	23130	711.0



LTE Band 13				
Channel Bandwidth	5MHz		10MHz	
	Channel	Frequency (MHz)	Channel	Frequency (MHz)
Low CH	23205	779.5	---	---
Middle CH	23230	782.0	23230	782.0
High CH	23255	784.5	---	---

LTE Band 17				
Channel Bandwidth	5MHz		10MHz	
	Channel	Frequency (MHz)	Channel	Frequency (MHz)
Low CH	23755	706.5	23780	709.0
Middle CH	23790	710.0	23790	710.0
High CH	23825	713.5	23800	711.0

LTE Band 25						
Channel Bandwidth	1.4MHz		3MHz		5MHz	
	Channel	Frequency (MHz)	Channel	Frequency (MHz)	Channel	Frequency (MHz)
Low CH	26047	1850.7	26055	1851.5	26065	1852.5
Middle CH	26365	1882.5	26365	1882.5	26365	1882.5
High CH	26683	1914.3	26675	1913.5	26665	1912.5
Channel Bandwidth	10MHz		15MHz		20MHz	
	Channel	Frequency (MHz)	Channel	Frequency (MHz)	Channel	Frequency (MHz)
Low CH	26090	1855	26115	1857.5	26140	1860
Middle CH	26365	1882.5	26365	1882.5	26365	1882.5
High CH	26640	1910	26615	1907.5	26590	1905



LTE Band 26 (Part 22)						
Channel Bandwidth	1.4MHz		3MHz		5MHz	
	Channel	Frequency (MHz)	Channel	Frequency (MHz)	Channel	Frequency (MHz)
Low CH	26797	824.7	26805	825.5	26815	826.5
Middle CH	26915	836.5	26915	836.5	26915	836.5
High CH	27003	848.3	27025	847.5	27015	846.5
Channel Bandwidth	10MHz		15MHz		NA	
	Channel	Frequency (MHz)	Channel	Frequency (MHz)	NA	NA
Low CH	26840	829.0	26865	831.5	NA	NA
Middle CH	26915	836.5	26915	836.5	NA	NA
High CH	26990	844.0	26965	841.5	NA	NA

LTE Band 26 (Part 90S)				
Channel Bandwidth	1.4MHz		3MHz	
	Channel	Frequency (MHz)	Channel	Frequency (MHz)
Low CH	26697	814.7	26705	815.5
Middle CH	26740	819.0	26740	819.0
High CH	26783	823.3	26775	822.5
Channel Bandwidth	5MHz		10MHz	
	Channel	Frequency (MHz)	Channel	Frequency (MHz)
Low CH	26715	816.5	26740	819.0
Middle CH	26740	819.0		
High CH	26765	821.5		



LTE Band 41				
Channel Bandwidth	5MHz		10MHz	
	Channel	Frequency (MHz)	Channel	Frequency (MHz)
Low CH	39675	2498.5	39700	2501.0
Middle CH	40620	2593.0	40620	2593.0
High CH	41565	2687.5	41540	2685.0
Channel Bandwidth	15MHz		20MHz	
	Channel	Frequency (MHz)	Channel	Frequency (MHz)
Low CH	39725	2503.5	39750	2506.0
Middle CH	40620	2593.0	40620	2593.0
High CH	41515	2682.5	41490	2680.0

Tested System Details

The types for all equipments, plus descriptions of all cables used in the tested system (including inserted cards) are:

	Product	Manufacturer	Model Number	Serial Number	Power Cord
1.	Wideband Radio Communication Tester	R & S	CMW500	103168	NA

1.3. EUT Exercise Software

1	Setup the EUT shown on “Configuration of Test System Details”.
2	Turn on the power of all equipment.
3	EUT run test program test.

1.4. Configuration of Test System Details

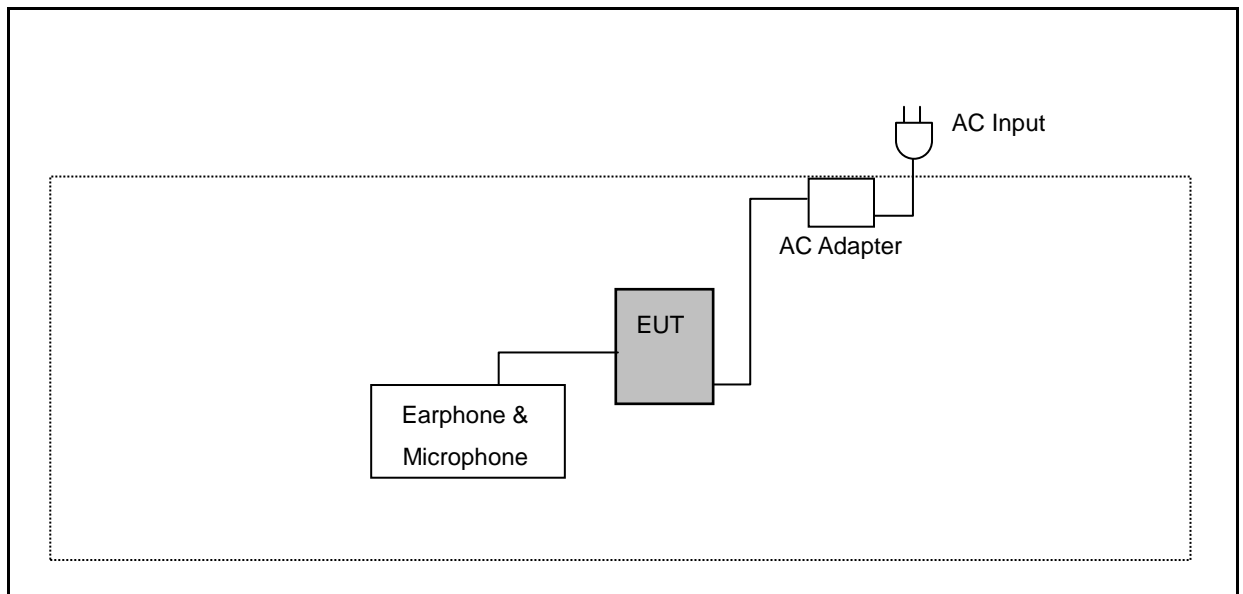



1.5. Test Instruments

For Spurious Radiation

Equipment	Manufacturer	Model Number	Serial Number	Cal. Date	Cal. Cycle
RF Pre-selector	Agilent	N9039A	MY46520256	04/24/2017	1 year
Spectrum Analyzer	Agilent	E4446A	MY46180578	04/24/2017	1 year
Pre Amplifier	Agilent	8449B	3008A02237	10/11/2016	1 year
Pre Amplifier	Agilent	8447D	2944A11119	01/12/2017	1 year
Pre Amplifier (26.5~40GHz)	EMCI	EMC2654045	980028	08/29/2017	1 year
Pre Amplifier (1~26.5GHz)	EMCI	EMC012645SE	980289	01/16/2017	1 year
Broadband Antenna	Schwarzbeck	VULB9168	416	10/13/2016	1 year
Horn Antenna (1~18GHz)	SCHWARZBECK MESS-ELEKTRONIK	BBHA9120D	9120D-550	06/20/2017	1 year
Horn Antenna (18~40GHz)	ETS	3116	00086467	09/11/2017	1 year
Microwave Cable	EMCI	EMC102-KM-KM- 14000	151001	02/20/2017	1 year
Microwave Cable	EMCI	EMC-104-SM-SM -14000	140202	02/20/2017	1 year
Microwave Cable	EMCI	EMC104-SM-SM- 600	140301	02/20/2017	1 year
Signal Generator	Agilent	E8257D	MY44320425	03/02/2017	1 year
Test Site	ATL	TE01	888001	08/29/2017	1 year

Note: N.C.R. = No Calibration Request.

1.6. Test Site Environment

Items	Required (IEC 68-1)	Actual
Temperature (°C)	15-35	26
Humidity (%RH)	25-75	60
Barometric pressure (mbar)	860-1060	950



1.7. Summary of Test Result

FCC Rule	Description	Result
§2.1046	Conducted Output Average Power	N/A (Note)
§22.913 §24.232 §27. 50 §90.635 §27. 50	Equivalent Isotropic Radiated Power / Equivalent Radiated Power	Pass
§2.1055 §22.355 §24.235 §27. 54	Frequency Stability	N/A (Note)
§2.1049	Emission Bandwidth & Occupied Bandwidth	N/A (Note)
§24.232 §27.50	Peak to average ratio	N/A (Note)
§2.1051 §22.917 §24.238 §27.53	Band Edge	N/A (Note)
§2.1051 §22.917 §24.238 §27.53	Conducted Spurious Emissions	N/A (Note)
§2.1053 §22.917 §24.238 §27.53 §90.691	Radiated Spurious Emissions	Pass

Note : Refer report number : I17Z61374-WMD03 / I17Z61374-WMD06

2 Measurement Procedure

2.1. Effective Radiated Power / Equivalent Isotropic Radiated Power Test

■ Limit

For FCC Part 27: The EIRP of mobile transmitters and auxiliary test transmitters must not exceed 1 Watts.

For FCC Part 27.50(b)(9): Control stations and mobile stations transmitting in the 746-757 MHz, and 776-788 MHz bands are limited to 30 watts ERP.

For FCC Part 27.50(c)(9): Control and mobile stations in the 698-746 MHz band are limited to 30 watts ERP.

For FCC Part 22.913(a)(2): The ERP of mobile transmitters and auxiliary test transmitters must not exceed 7 Watts.

For FCC Part 24.232(b): The EIRP of mobile transmitters and auxiliary test transmitters must not exceed 2 Watts.

For FCC Part 27.50(h)(2): Mobile stations in BRS and EBS band are limited to 2watts EIRP.

For FCC Part 90.635(b): ERP maximum power is 100 watts for mobile stations.

■ Test Setup

Below 1 GHz

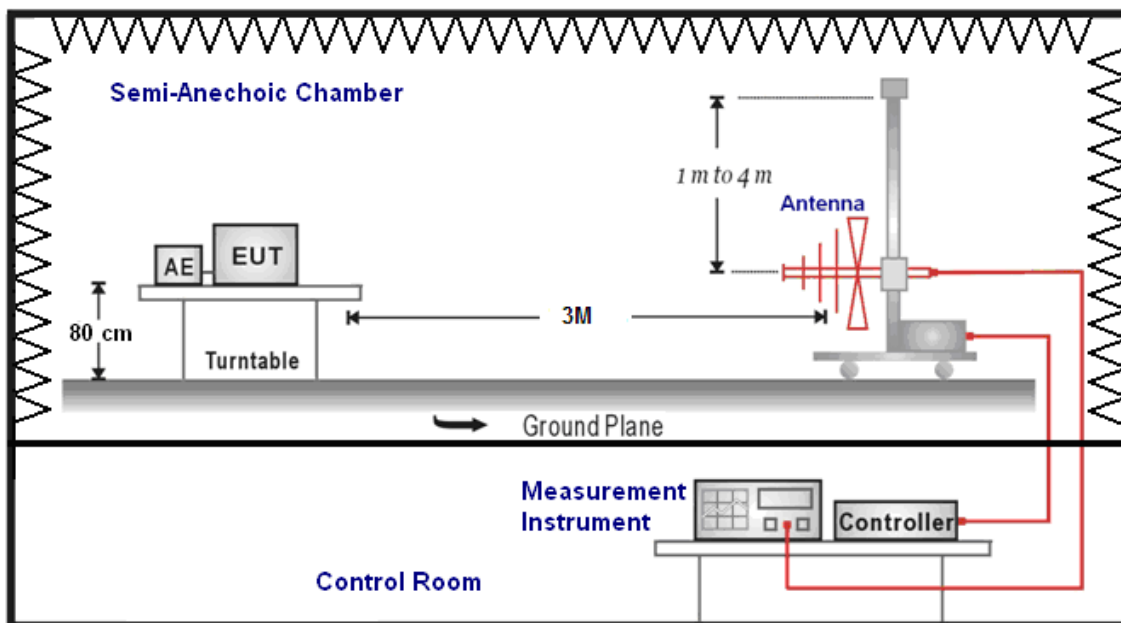

Above 1 GHz

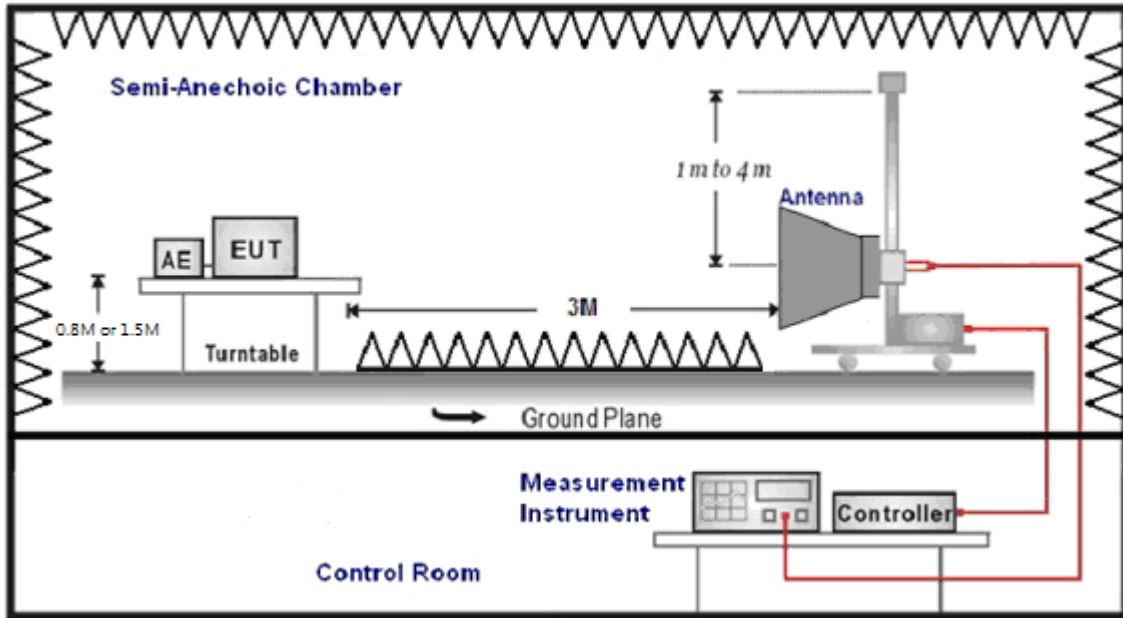

For Substituted Method Test Set-UP

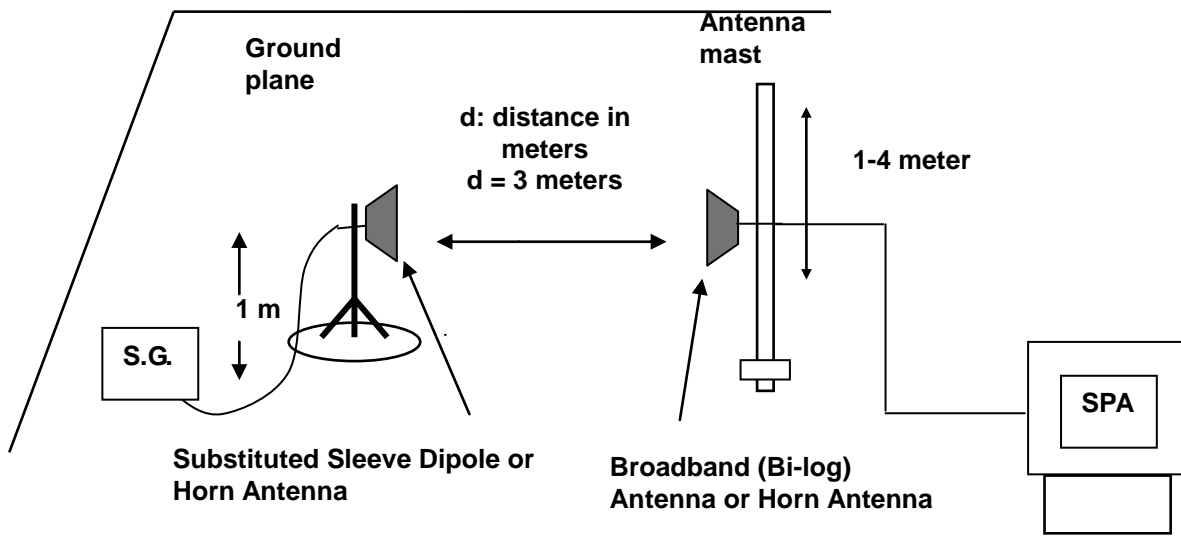



■ Test Procedure

- a. The EUT was set up for the maximum power with wwan link data modulation. The power was measured with Spectrum Analyzer. All measurements were done at 3 channels (low, middle and high operational frequency range).
- b. E.I.R.P power measurement. In the semi-anechoic chamber, EUT placed on the 0.8m height of Turn Table, rotated the table around 360 degrees to search the maximum radiation power and receiver antenna shall be rotated vertical and horizontal polarization and moved height from 1m to 4m to find the maximum polar radiated power. The "Read Value" is the spectrum reading the maximum power value.
- c. The substitution antenna (Note:1 & 2) is substituted for EUT at the same position and signals generator export the CW signal to the substitution antenna via a TX cable. Rotated the Turn Table and moved receiving antenna to find the maximum radiation power. Adjust output power level of S.G to get a Value of spectrum reading equal to "Read Value" of step a. Record the power level of S.G.
- d. $E.I.R.P. = \text{Output power level of S.G} - \text{TX cable loss} + \text{Antenna gain of substitution horn}$
- e. $E.R.P. = E.I.R.P. - 2.15 \text{ dB}$

Note: 1. Below 1 GHz Substituted Method Test : Sleeve dipole antenna to Bi-Log Antenna

2. Above 1 GHz Substituted Method Test : Horn antenna to Horn Antenna

■ Uncertainty

The measurement uncertainty is defined as for Field Strength of Spurious Radiation measurement is $\pm 3.072 \text{ dB}$.

2.2. Radiated Emission Test

■ Limit

The power of any emission outside a licensee's frequency block shall be attenuated below the transmitter power (P) by at least $43 + 10 \log_{10}(P)$ dB. The limit of emission equal to -13dBm

■ Setup

Below 1GHz

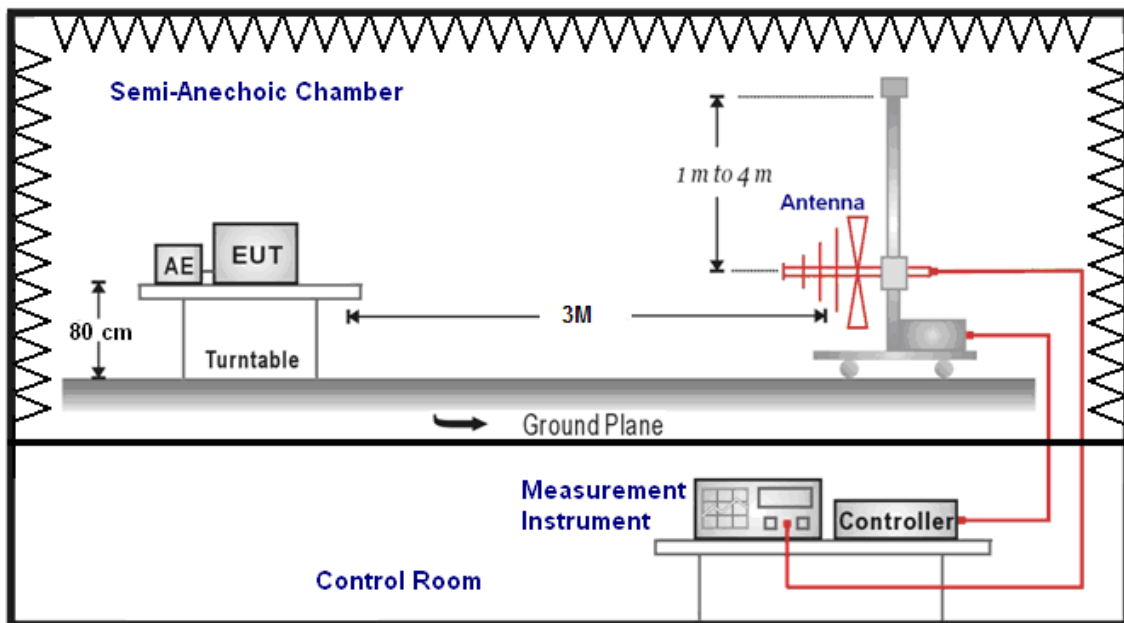

Above 1GHz

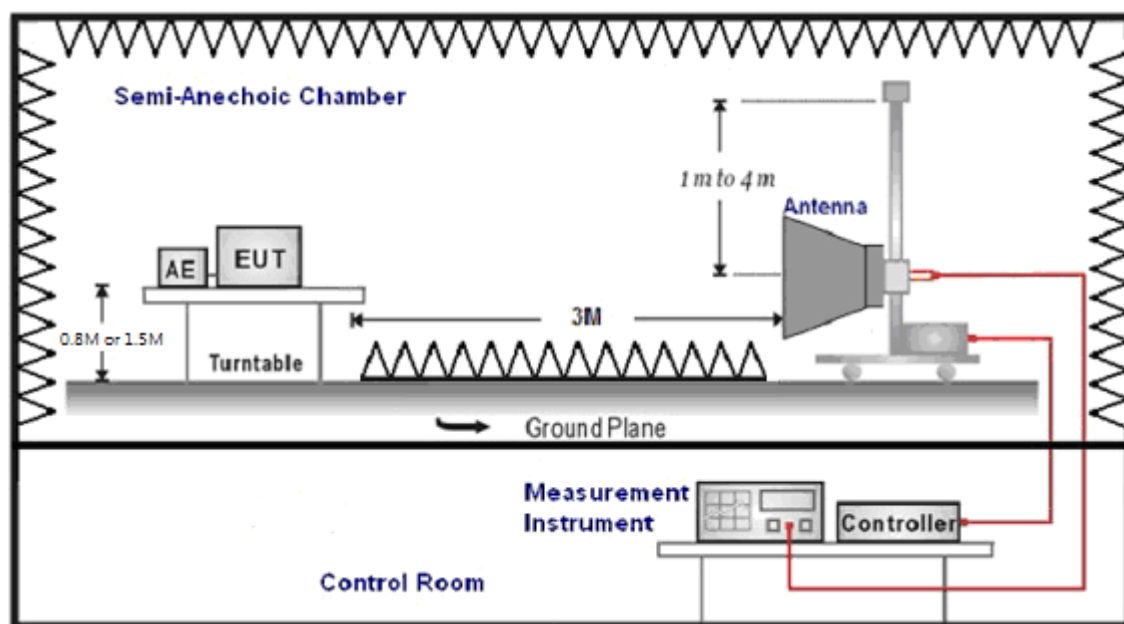

For Substituted Method Test Set-UP

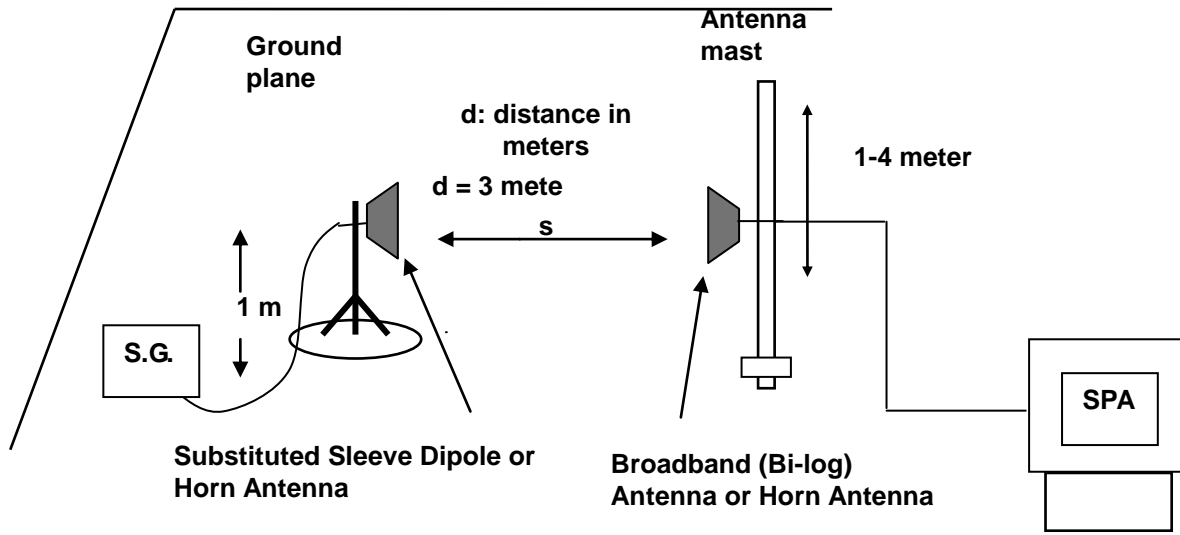

■ Test Procedure

- The EUT was set up for the maximum power with wwan link data modulation. The power was measured with Spectrum Analyzer. All measurements were done at 3 channels (low, middle and high operational frequency range).
- Radiation Emission measurement. In the semi-anechoic chamber, EUT placed on the 0.8m height of Turn Table, rotated the table around 360 degrees to search the maximum radiation power and receiver antenna shall be rotated vertical and horizontal polarization and moved height from 1m to 4m to find the maximum polar radiated power. The "Read Value" is the spectrum reading the maximum power value.
- The substitution antenna (Note:1 & 2) is substituted for EUT at the same position and signals generator export the CW signal to the substitution antenna via a TX cable. Rotated the Turn Table and moved receiving antenna to find the maximum radiation power. Adjust output power level of S.G to get a Value of spectrum reading equal to "Read Value" of step a. Record the power level of S.G.
- $E.I.R.P. = \text{Output power level of S.G} - \text{TX cable loss} + \text{Antenna gain of substitution horn}$
- $E.R.P. = E.I.R.P. - 2.15 \text{ dB}$

Note: 1. Below 1 GHz Substituted Method Test : Sleeve dipole antenna to Bi-Log Antenna

2. Above 1 GHz Substituted Method Test : Horn antenna to Horn Antenn

■ Uncertainty

The measurement uncertainty is defined as for Field Strength of Spurious Radiation measurement is $\pm 3.072 \text{ dB}$.



3 Test Results

Effective Radiated Power / Equivalent Isotropic Radiated Power

Band 2								
Channel Bandwidth	Modulation	Frequency (MHz)	Ant. Polar.	Read Level (dBm)	Correction Factor (dBm)	E.I.R.P.		Limit (W)
						(dBm)	(W)	
1.4M	QPSK	1850.7	H	27.07	-10.70	16.37	0.043	< 2
			V	28.29	-10.70	17.59	0.057	< 2
		1880.0	H	26.80	-10.25	16.55	0.045	< 2
			V	28.64	-10.25	18.39	0.069	< 2
	1909.3	H	25.00	-9.79	15.21	0.033	< 2	
		V	27.64	-9.79	17.85	0.061	< 2	
16QAM	1880.0	H	27.04	-10.25	16.79	0.048	< 2	
		V	27.04	-10.25	16.79	0.048	< 2	
3M	QPSK	1851.5	H	26.72	-10.70	16.02	0.040	< 2
			V	29.13	-10.70	18.43	0.070	< 2
		1880.0	H	26.63	-10.26	16.37	0.043	< 2
			V	29.28	-10.26	19.02	0.080	< 2
	1908.5	H	24.88	-9.82	15.06	0.032	< 2	
		V	27.10	-9.82	17.28	0.053	< 2	
16QAM	1880.0	H	25.30	-10.26	15.04	0.032	< 2	
		V	27.37	-10.26	17.11	0.051	< 2	
5M	QPSK	1852.5	H	26.12	-10.70	15.42	0.035	< 2
			V	28.66	-10.70	17.96	0.063	< 2
		1880.0	H	25.35	-10.28	15.07	0.032	< 2
			V	28.67	-10.28	18.39	0.069	< 2
	1907.5	H	25.02	-9.84	15.18	0.033	< 2	
		V	27.63	-9.84	17.79	0.060	< 2	
16QAM	1880.0	H	24.30	-10.28	14.02	0.025	< 2	
		V	27.63	-10.28	17.35	0.054	< 2	
10M	QPSK	1855.0	H	27.09	-10.70	16.39	0.044	< 2
			V	29.36	-10.70	18.66	0.073	< 2
		1880.0	H	25.31	-10.32	14.99	0.032	< 2
			V	28.39	-10.32	18.07	0.064	< 2
	1905.0	H	25.37	-9.93	15.44	0.035	< 2	
		V	27.86	-9.93	17.93	0.062	< 2	
16QAM	1880.0	H	24.24	-10.32	13.92	0.025	< 2	
		V	27.21	-10.32	16.89	0.049	< 2	
15M	QPSK	1857.5	H	26.76	-10.70	16.06	0.040	< 2
			V	29.22	-10.70	18.52	0.071	< 2
		1880.0	H	25.83	-10.36	15.47	0.035	< 2
			V	28.20	-10.36	17.84	0.061	< 2
	1902.5	H	26.49	-10.01	16.48	0.044	< 2	
		V	28.54	-10.01	18.53	0.071	< 2	
16QAM	1880.0	H	25.07	-10.36	14.71	0.030	< 2	
		V	27.34	-10.36	16.98	0.050	< 2	
20M	QPSK	1860.0	H	27.19	-10.70	16.49	0.045	< 2
			V	29.49	-10.70	18.79	0.076	< 2
		1880.0	H	27.55	-10.36	17.19	0.052	< 2
			V	29.38	-10.36	19.02	0.080	< 2
	1900.0	H	26.36	-10.06	16.30	0.043	< 2	
		V	29.93	-10.06	19.87	0.097	< 2	
16QAM	1880.0	H	25.78	-10.36	15.42	0.035	< 2	
		V	27.74	-10.36	17.38	0.055	< 2	



Band 4								
Channel Bandwidth	Modulation	Frequency (MHz)	Ant. Polar.	Read Level (dBm)	Correction Factor (dBm)	E.I.R.P.		Limit (W)
						(dBm)	(W)	
1.4M	QPSK	1710.7	H	28.61	-12.58	16.03	0.040	< 1
			V	31.19	-12.58	18.61	0.073	< 1
		1732.5	H	28.33	-12.29	16.04	0.040	< 1
			V	30.92	-12.29	18.63	0.073	< 1
		1754.3	H	27.64	-12.00	15.64	0.037	< 1
			V	30.13	-12.00	18.13	0.065	< 1
16QAM	1732.5	H	27.16	-12.29	14.87	0.031	< 1	
		V	29.81	-12.29	17.52	0.056	< 1	
3M	QPSK	1711.5	H	28.60	-12.58	16.02	0.040	< 1
			V	31.52	-12.58	18.94	0.078	< 1
		1732.5	H	27.72	-12.30	15.42	0.035	< 1
			V	30.39	-12.30	18.09	0.064	< 1
		1753.5	H	27.33	-12.02	15.31	0.034	< 1
			V	29.80	-12.02	17.78	0.060	< 1
16QAM	1732.5	H	26.97	-12.30	14.67	0.029	< 1	
		V	29.15	-12.30	16.85	0.048	< 1	
5M	QPSK	1712.5	H	29.06	-12.58	16.48	0.044	< 1
			V	31.62	-12.58	19.04	0.080	< 1
		1732.5	H	28.74	-12.31	16.43	0.044	< 1
			V	31.67	-12.31	19.36	0.086	< 1
		1752.5	H	29.05	-12.03	17.02	0.050	< 1
			V	31.51	-12.03	19.48	0.089	< 1
16QAM	1732.5	H	25.41	-12.31	13.10	0.020	< 1	
		V	29.75	-12.31	17.44	0.055	< 1	
10M	QPSK	1715.0	H	26.80	-12.58	14.22	0.026	< 1
			V	32.09	-12.58	19.51	0.089	< 1
		1732.5	H	29.43	-12.34	17.09	0.051	< 1
			V	32.02	-12.34	19.68	0.093	< 1
		1750.0	H	28.83	-12.10	16.73	0.047	< 1
			V	29.59	-12.10	17.49	0.056	< 1
16QAM	1732.5	H	26.13	-12.34	13.79	0.024	< 1	
		V	28.65	-12.34	16.31	0.043	< 1	
15M	QPSK	1717.5	H	30.14	-12.57	17.57	0.057	< 1
			V	31.76	-12.57	19.19	0.083	< 1
		1732.5	H	28.79	-12.37	16.42	0.044	< 1
			V	30.33	-12.37	17.96	0.063	< 1
		1747.5	H	29.02	-12.16	16.86	0.049	< 1
			V	30.77	-12.16	18.61	0.073	< 1
16QAM	1732.5	H	26.38	-12.37	14.01	0.025	< 1	
		V	28.40	-12.37	16.03	0.040	< 1	
20M	QPSK	1720.0	H	26.69	-12.57	14.12	0.026	< 1
			V	31.46	-12.57	18.89	0.077	< 1
		1732.5	H	25.80	-12.40	13.40	0.022	< 1
			V	28.98	-12.40	16.58	0.045	< 1
		1745.0	H	27.28	-12.22	15.06	0.032	< 1
			V	29.12	-12.22	16.90	0.049	< 1
16QAM	1732.5	H	25.37	-12.40	12.97	0.020	< 1	
		V	27.47	-12.40	15.07	0.032	< 1	



Band 5								
Channel Bandwidth	Modulation	Frequency (MHz)	Ant. Polar.	Read Level (dBm)	Correction Factor (dBm)	E.R.P.		Limit (W)
						(dBm)	(W)	
1.4M	QPSK	824.7	H	15.80	-0.09	15.71	0.037	< 7
			V	18.05	-0.09	17.96	0.063	< 7
		836.5	H	16.04	0.04	16.08	0.041	< 7
			V	18.10	0.04	18.14	0.065	< 7
		848.3	H	14.75	0.04	14.79	0.030	< 7
			V	15.97	0.04	16.01	0.040	< 7
	16QAM	836.5	H	14.27	0.04	14.31	0.027	< 7
			V	17.19	0.04	17.23	0.053	< 7
3M	QPSK	825.5	H	16.22	-0.09	16.13	0.041	< 7
			V	18.51	-0.09	18.42	0.070	< 7
		836.5	H	15.66	0.04	15.70	0.037	< 7
			V	18.38	0.04	18.42	0.070	< 7
		847.5	H	15.63	0.03	15.66	0.037	< 7
			V	18.11	0.03	18.14	0.065	< 7
	16QAM	836.5	H	13.93	0.04	13.97	0.025	< 7
			V	17.00	0.04	17.04	0.051	< 7
5M	QPSK	826.5	H	14.14	-0.09	14.05	0.025	< 7
			V	17.18	-0.09	17.09	0.051	< 7
		836.5	H	13.94	0.03	13.97	0.025	< 7
			V	17.26	0.03	17.29	0.054	< 7
		846.5	H	15.60	0.04	15.64	0.037	< 7
			V	17.47	0.04	17.51	0.056	< 7
	16QAM	836.5	H	12.35	0.03	12.38	0.017	< 7
			V	16.41	0.03	16.44	0.044	< 7
10M	QPSK	829.0	H	15.87	-0.08	15.79	0.038	< 7
			V	18.09	-0.08	18.01	0.063	< 7
		836.5	H	15.58	0.03	15.61	0.036	< 7
			V	16.95	0.03	16.98	0.050	< 7
		844.0	H	14.92	0.05	14.97	0.031	< 7
			V	17.38	0.05	17.43	0.055	< 7
	16QAM	836.5	H	13.66	0.03	13.69	0.023	< 7
			V	15.76	0.03	15.79	0.038	< 7



Band 12								
Channel Bandwidth	Modulation	Frequency (MHz)	Ant. Polar.	Read Level (dBm)	Correction Factor (dBm)	E.R.P.		Limit (W)
						(dBm)	(W)	
1.4M	QPSK	699.7	H	17.05	-2.08	14.97	0.031	< 3
			V	20.40	-2.08	18.32	0.068	< 3
		707.5	H	17.07	-1.89	15.18	0.033	< 3
			V	19.76	-1.89	17.87	0.061	< 3
		715.3	H	17.30	-1.70	15.60	0.036	< 3
			V	19.04	-1.70	17.34	0.054	< 3
16QAM	707.5	H	15.72	-1.88	13.84	0.024	< 3	
		V	17.93	-1.88	16.05	0.040	< 3	
3M	QPSK	700.5	H	15.94	-2.08	13.86	0.024	< 3
			V	19.07	-2.08	16.99	0.050	< 3
		707.5	H	17.35	-1.91	15.44	0.035	< 3
			V	19.19	-1.91	17.28	0.053	< 3
		714.5	H	16.13	-1.74	14.39	0.027	< 3
			V	19.04	-1.74	17.30	0.054	< 3
16QAM	707.5	H	14.97	-1.91	13.06	0.020	< 3	
		V	17.40	-1.91	15.49	0.035	< 3	
5M	QPSK	701.5	H	16.09	-2.07	14.02	0.025	< 3
			V	17.45	-2.07	15.38	0.035	< 3
		707.5	H	16.09	-1.93	14.16	0.026	< 3
			V	18.28	-1.93	16.35	0.043	< 3
		713.5	H	16.30	-1.79	14.51	0.028	< 3
			V	18.84	-1.78	17.06	0.051	< 3
16QAM	707.5	H	14.64	-1.93	12.71	0.019	< 3	
		V	17.66	-1.93	15.73	0.037	< 3	
10M	QPSK	704.0	H	17.43	-2.06	15.37	0.034	< 3
			V	20.12	-2.06	18.06	0.064	< 3
		707.5	H	17.16	-1.98	15.18	0.033	< 3
			V	19.75	-1.97	17.78	0.060	< 3
		711.0	H	16.84	-1.88	14.96	0.031	< 3
			V	20.02	-1.88	18.14	0.065	< 3
16QAM	707.5	H	15.88	-1.98	13.90	0.025	< 3	
		V	17.52	-1.97	15.55	0.036	< 3	



Band 13								
Channel Bandwidth	Modulation	Frequency (MHz)	Ant. Polar.	Read Level (dBm)	Correction Factor (dBm)	E.R.P.		Limit (W)
						(dBm)	(W)	
5M	QPSK	779.5	H	14.40	-0.44	13.96	0.025	< 3
			V	17.20	-0.44	16.76	0.047	< 3
		782.0	H	15.01	-0.39	14.62	0.029	< 3
			V	18.00	-0.39	17.61	0.058	< 3
		784.5	H	14.85	-0.39	14.46	0.028	< 3
			V	17.93	-0.39	17.54	0.057	< 3
16QAM	782.0	H	14.15	-0.39	13.76	0.024	< 3	
		V	16.42	-0.39	16.03	0.040	< 3	
10M	QPSK	782.0	H	15.56	-0.43	15.13	0.033	< 3
			V	18.12	-0.43	17.69	0.059	< 3
	16QAM		H	13.49	-0.43	13.06	0.020	< 3
			V	16.07	-0.43	15.64	0.037	< 3

Band 17								
Channel Bandwidth	Modulation	Frequency (MHz)	Ant. Polar.	Read Level (dBm)	Correction Factor (dBm)	E.R.P.		Limit (W)
						(dBm)	(W)	
5M	QPSK	706.5	H	17.57	-1.95	15.62	0.036	< 3
			V	20.04	-1.95	18.09	0.064	< 3
		710.0	H	16.13	-1.86	14.27	0.027	< 3
			V	18.73	-1.86	16.87	0.049	< 3
		713.5	H	16.83	-1.75	15.08	0.032	< 3
			V	20.13	-1.76	18.37	0.069	< 3
16QAM	710.0	H	14.27	-1.86	12.41	0.017	< 3	
		V	15.92	-1.86	14.06	0.025	< 3	
10M	QPSK	709.0	H	16.73	-1.94	14.79	0.030	< 3
			V	20.18	-1.94	18.24	0.067	< 3
		710.0	H	17.08	-1.92	15.16	0.033	< 3
			V	20.25	-1.92	18.33	0.068	< 3
		711.0	H	17.18	-1.89	15.29	0.034	< 3
			V	20.35	-1.88	18.47	0.070	< 3
16QAM	710.0	H	15.05	-1.92	13.13	0.021	< 3	
		V	17.01	-1.92	15.09	0.032	< 3	



Band 25								
Channel Bandwidth	Modulation	Frequency (MHz)	Ant. Polar.	Read Level (dBm)	Correction Factor (dBm)	E.I.R.P.		Limit (W)
						(dBm)	(W)	
1.4M	QPSK	1850.7	H	24.78	-11.40	13.38	0.022	< 2
			V	25.48	-11.40	14.08	0.026	< 2
		1882.5	H	24.95	-10.20	14.75	0.030	< 2
			V	24.58	-10.20	14.38	0.027	< 2
		1914.3	H	24.78	-9.71	15.07	0.032	< 2
			V	25.05	-9.71	15.34	0.034	< 2
16QAM	1882.5	H	25.28	-10.20	15.08	0.032	< 2	
		V	25.39	-10.20	15.19	0.033	< 2	
3M	QPSK	1851.5	H	24.76	-10.68	14.08	0.026	< 2
			V	25.25	-10.68	14.57	0.029	< 2
		1882.5	H	25.29	-10.20	15.09	0.032	< 2
			V	24.88	-10.20	14.68	0.029	< 2
		1913.5	H	26.68	-9.72	16.96	0.050	< 2
			V	26.75	-9.72	17.03	0.050	< 2
16QAM	1882.5	H	27.16	-10.20	16.96	0.050	< 2	
		V	27.26	-10.20	17.06	0.051	< 2	
5M	QPSK	1852.5	H	26.44	-10.70	15.74	0.037	< 2
			V	29.65	-10.70	18.95	0.079	< 2
		1882.5	H	26.28	-10.24	16.04	0.040	< 2
			V	28.81	-10.24	18.57	0.072	< 2
		1912.5	H	26.21	-9.77	16.44	0.044	< 2
			V	29.04	-9.77	19.27	0.085	< 2
16QAM	1882.5	H	25.16	-10.24	14.92	0.031	< 2	
		V	27.87	-10.24	17.63	0.058	< 2	
10M	QPSK	1855.0	H	27.72	-10.70	17.02	0.050	< 2
			V	30.03	-10.70	19.33	0.086	< 2
		1882.5	H	25.97	-10.27	15.70	0.037	< 2
			V	29.24	-10.27	18.97	0.079	< 2
		1910.0	H	25.87	-9.84	16.03	0.040	< 2
			V	29.45	-9.84	19.61	0.091	< 2
16QAM	1882.5	H	24.18	-10.27	13.91	0.025	< 2	
		V	26.91	-10.27	16.64	0.046	< 2	
15M	QPSK	1857.5	H	27.46	-10.60	16.86	0.049	< 2
			V	27.68	-10.60	17.08	0.051	< 2
		1882.5	H	27.26	-10.20	17.06	0.051	< 2
			V	27.56	-10.60	16.96	0.050	< 2
		1907.5	H	26.65	-9.81	16.84	0.048	< 2
			V	26.39	-9.81	16.58	0.045	< 2
16QAM	1882.5	H	27.33	-10.20	17.13	0.052	< 2	
		V	27.17	-10.20	16.97	0.050	< 2	
20M	QPSK	1860.0	H	26.51	-10.55	15.96	0.039	< 2
			V	26.63	-10.55	16.08	0.041	< 2
		1882.5	H	26.38	-10.20	16.18	0.041	< 2
			V	26.78	-10.20	16.58	0.045	< 2
		1905.0	H	26.97	-9.84	17.13	0.052	< 2
			V	26.90	-9.84	17.06	0.051	< 2
16QAM	1882.5	H	27.05	-10.20	16.85	0.048	< 2	
		V	26.45	-10.20	16.25	0.042	< 2	



Band 26(Part 22)								
Channel Bandwidth	Modulation	Frequency (MHz)	Ant. Polar.	Read Level (dBm)	Correction Factor (dBm)	E.R.P.		Limit (W)
						(dBm)	(W)	
1.4M	QPSK	836.5	H	16.83	0.04	16.87	0.049	< 7
			V	17.11	0.04	17.15	0.052	< 7
		824.7	H	16.06	-0.09	15.97	0.040	< 7
			V	16.66	-0.09	16.57	0.045	< 7
		836.5	H	17.01	0.04	17.05	0.051	< 7
			V	16.13	0.04	16.17	0.041	< 7
	16QAM	845.3	H	15.71	0.04	15.75	0.038	< 7
			V	14.91	0.04	14.95	0.031	< 7
3M	QPSK	836.5	H	17.37	0.04	17.41	0.055	< 7
			V	16.83	0.04	16.87	0.049	< 7
		825.5	H	16.23	-0.06	16.17	0.041	< 7
			V	15.84	-0.06	15.78	0.038	< 7
		836.5	H	18.00	0.04	18.04	0.064	< 7
			V	17.84	0.04	17.88	0.061	< 7
	16QAM	847.5	H	16.94	0.04	16.98	0.050	< 7
			V	15.95	0.04	15.99	0.040	< 7
5M	QPSK	836.5	H	17.98	0.04	18.02	0.063	< 7
			V	17.67	0.04	17.71	0.059	< 7
		826.5	H	17.15	-0.04	17.11	0.051	< 7
			V	16.12	-0.04	16.08	0.041	< 7
		836.5	H	16.14	0.04	16.18	0.041	< 7
			V	17.04	0.04	17.08	0.051	< 7
	16QAM	846.5	H	17.72	0.04	17.76	0.060	< 7
			V	17.02	0.04	17.06	0.051	< 7
10M	QPSK	836.5	H	16.75	0.04	16.79	0.048	< 7
			V	17.95	0.04	17.99	0.063	< 7
		829.0	H	15.77	0.00	15.77	0.038	< 7
			V	15.97	0.00	15.97	0.040	< 7
		836.5	H	16.35	0.04	16.39	0.044	< 7
			V	17.01	0.04	17.05	0.051	< 7
	16QAM	844.0	H	16.07	0.04	16.11	0.041	< 7
			V	17.02	0.04	17.06	0.051	< 7
15M	QPSK	836.5	H	18.09	0.04	18.13	0.065	< 7
			V	17.87	0.04	17.91	0.062	< 7
		831.5	H	16.76	0.02	16.78	0.048	< 7
			V	17.16	0.02	17.18	0.052	< 7
		836.5	H	15.62	0.04	15.66	0.037	< 7
			V	16.78	0.04	16.82	0.048	< 7
	16QAM	841.5	H	17.63	0.05	17.68	0.059	< 7
			V	17.98	0.05	18.03	0.064	< 7



Band 26(Part 90S)								
Channel Bandwidth	Modulation	Frequency (MHz)	Ant. Polar.	Read Level (dBm)	Correction Factor (dBm)	E.R.P.		Limit (W)
						(dBm)	(W)	
1.4M	QPSK	814.7	H	18.31	-0.25	18.06	0.064	< 100
			V	18.21	-0.25	17.96	0.063	< 100
		819.0	H	18.17	-0.18	17.99	0.063	< 100
			V	18.22	-0.18	18.04	0.064	< 100
		823.3	H	17.35	-0.11	17.24	0.053	< 100
			V	17.09	-0.11	16.98	0.050	< 100
	16QAM	819.0	H	16.35	-0.18	16.17	0.041	< 100
			V	18.14	-0.18	17.96	0.063	< 100
3M	QPSK	815.5	H	17.21	-0.18	17.03	0.050	< 100
			V	17.11	-0.18	16.93	0.049	< 100
		819.0	H	17.76	-0.24	17.52	0.056	< 100
			V	17.35	-0.24	17.11	0.051	< 100
		822.5	H	17.01	0.00	17.01	0.050	< 100
			V	16.95	0.00	16.95	0.050	< 100
	16QAM	819.0	H	17.11	-0.18	16.93	0.049	< 100
			V	17.33	-0.18	17.15	0.052	< 100
5M	QPSK	816.5	H	16.26	-0.23	16.03	0.040	< 100
			V	16.19	-0.23	15.96	0.039	< 100
		819.0	H	16.36	-0.18	16.18	0.041	< 100
			V	17.22	-0.18	17.04	0.051	< 100
		821.5	H	16.99	-0.14	16.85	0.048	< 100
			V	17.82	-0.14	17.68	0.059	< 100
	16QAM	819.0	H	17.12	0.00	17.12	0.052	< 100
			V	16.38	0.00	16.38	0.043	< 100
10M	QPSK	819.0	H	15.14	-0.18	14.96	0.031	< 100
			V	15.26	-0.18	15.08	0.032	< 100
			V	18.21	-0.25	17.96	0.063	< 100
	16QAM	819.0	H	18.17	-0.18	17.99	0.063	< 100
			V	18.22	-0.18	18.04	0.064	< 100



Band 41								
Channel Bandwidth	Modulation	Frequency (MHz)	Ant. Polar.	Read Level (dBm)	Correction Factor (dBm)	E.I.R.P.		Limit (W)
						(dBm)	(W)	
5M	QPSK	2498.5	H	24.65	-9.38	15.27	0.034	< 2
			V	26.76	-9.38	17.38	0.055	< 2
		2593.0	H	23.10	-9.20	13.90	0.025	< 2
			V	25.39	-9.20	16.19	0.042	< 2
		2687.5	H	23.78	-8.99	14.79	0.030	< 2
			V	25.81	-8.99	16.82	0.048	< 2
16QAM	2593.0	H	22.07	-9.20	12.87	0.019	< 2	
		V	24.26	-9.20	15.06	0.032	< 2	
10M	QPSK	2501.0	H	24.58	-9.38	15.20	0.033	< 2
			V	26.80	-9.38	17.42	0.055	< 2
		2593.0	H	23.77	-9.21	14.56	0.029	< 2
			V	26.03	-9.21	16.82	0.048	< 2
		2685.0	H	23.81	-9.00	14.81	0.030	< 2
			V	26.67	-9.00	17.67	0.058	< 2
16QAM	2593.0	H	22.40	-9.21	13.19	0.021	< 2	
		V	24.67	-9.21	15.46	0.035	< 2	
15M	QPSK	2503.5	H	23.35	-9.38	13.97	0.025	< 2
			V	25.87	-9.38	16.49	0.045	< 2
		2593.0	H	24.43	-9.21	15.22	0.033	< 2
			V	25.95	-9.21	16.74	0.047	< 2
		2682.5	H	23.00	-9.01	13.99	0.025	< 2
			V	26.47	-9.01	17.46	0.056	< 2
16QAM	2593.0	H	22.91	-9.21	13.70	0.023	< 2	
		V	25.25	-9.21	16.04	0.040	< 2	
20M	QPSK	2506.0	H	24.18	-9.37	14.81	0.030	< 2
			V	27.39	-9.37	18.02	0.063	< 2
		2593.0	H	24.24	-9.21	15.03	0.032	< 2
			V	26.88	-9.21	17.67	0.058	< 2
		2680.0	H	24.35	-9.02	15.33	0.034	< 2
			V	26.65	-9.02	17.63	0.058	< 2
16QAM	2593.0	H	23.39	-9.21	14.18	0.026	< 2	
		V	25.20	-9.21	15.99	0.040	< 2	



Radiated Emission

Standard:	FCC Part 22H/24E/27/90	Test Distance:	3m
Test item:	Harmonic	Power:	AC 120V/60Hz
Frequency:	1850.7MHz	Temp.(°C)/Hum.(%RH):	26(°C)/60%RH
Mode:	4G_Band 2_1.4M_QPSK_CH18607	Date:	09/25/2017
Ant.Polar.:	Horizontal		

No.	Frequency (MHz)	Reading (dBm)	Correct Factor (dB)	Result (dBm)	Limit (dBm)	Margin (dB)	Remark
1	3701.400	-44.27	-6.12	-50.39	-13.00	-37.39	peak

Standard:	FCC Part 22H/24E/27/90	Test Distance:	3m
Test item:	Harmonic	Power:	AC 120V/60Hz
Frequency:	1850.7MHz	Temp.(°C)/Hum.(%RH):	26(°C)/60%RH
Mode:	4G_Band 2_1.4M_QPSK_CH18607	Date:	09/25/2017
Ant.Polar.:	Vertical		

No.	Frequency (MHz)	Reading (dBm)	Correct Factor (dB)	Result (dBm)	Limit (dBm)	Margin (dB)	Remark
1	3701.400	-42.60	-6.12	-48.72	-13.00	-35.72	peak



Standard:	FCC Part 22H/24E/27/90	Test Distance:	3m
Test item:	Harmonic	Power:	AC 120V/60Hz
Frequency:	1880MHz	Temp.(°C)/Hum.(%RH):	26(°C)/60%RH
Mode:	4G_Band 2_1.4M_QPSK_CH18900	Date:	09/25/2017
Ant.Polar.:	Horizontal		

No.	Frequency (MHz)	Reading (dBm)	Correct Factor (dB)	Result (dBm)	Limit (dBm)	Margin (dB)	Remark
1	3760.000	-42.84	-5.87	-48.71	-13.00	-35.71	peak

Standard:	FCC Part 22H/24E/27/90	Test Distance:	3m
Test item:	Harmonic	Power:	AC 120V/60Hz
Frequency:	1880MHz	Temp.(°C)/Hum.(%RH):	26(°C)/60%RH
Mode:	4G_Band 2_1.4M_QPSK_CH18900	Date:	09/25/2017
Ant.Polar.:	Vertical		

No.	Frequency (MHz)	Reading (dBm)	Correct Factor (dB)	Result (dBm)	Limit (dBm)	Margin (dB)	Remark
1	3760.000	-44.59	-5.87	-50.46	-13.00	-37.46	peak



Standard:	FCC Part 22H/24E/27/90	Test Distance:	3m
Test item:	Harmonic	Power:	AC 120V/60Hz
Frequency:	1909.3MHz	Temp.(°C)/Hum.(%RH):	26(°C)/60%RH
Mode:	4G_Band 2_1.4M_QPSK_CH19193	Date:	09/25/2017
Ant.Polar.:	Horizontal		

No.	Frequency (MHz)	Reading (dBm)	Correct Factor (dB)	Result (dBm)	Limit (dBm)	Margin (dB)	Remark
1	3818.600	-42.89	-5.82	-48.71	-13.00	-35.71	peak

Standard:	FCC Part 22H/24E/27/90	Test Distance:	3m
Test item:	Harmonic	Power:	AC 120V/60Hz
Frequency:	1909.3MHz	Temp.(°C)/Hum.(%RH):	26(°C)/60%RH
Mode:	4G_Band 2_1.4M_QPSK_CH19193	Date:	09/25/2017
Ant.Polar.:	Vertical		

No.	Frequency (MHz)	Reading (dBm)	Correct Factor (dB)	Result (dBm)	Limit (dBm)	Margin (dB)	Remark
1	3818.600	-42.89	-5.82	-48.71	-13.00	-35.71	peak



Standard:	FCC Part 22H/24E/27/90	Test Distance:	3m
Test item:	Harmonic	Power:	AC 120V/60Hz
Frequency:	1880MHz	Temp.(°C)/Hum.(%RH):	26(°C)/60%RH
Mode:	4G_Band 2_1.4M-16QAM_CH18900	Date:	09/25/2017
Ant.Polar.:	Horizontal		

No.	Frequency (MHz)	Reading (dBm)	Correct Factor (dB)	Result (dBm)	Limit (dBm)	Margin (dB)	Remark
1	3760.000	-49.02	-5.87	-54.89	-13.00	-41.89	peak

Standard:	FCC Part 22H/24E/27/90	Test Distance:	3m
Test item:	Harmonic	Power:	AC 120V/60Hz
Frequency:	1880MHz	Temp.(°C)/Hum.(%RH):	26(°C)/60%RH
Mode:	4G_Band 2_1.4M-16QAM_CH18900	Date:	09/25/2017
Ant.Polar.:	Vertical		

No.	Frequency (MHz)	Reading (dBm)	Correct Factor (dB)	Result (dBm)	Limit (dBm)	Margin (dB)	Remark
1	3760.000	-47.80	-5.87	-53.67	-13.00	-40.67	peak



Standard:	FCC Part 22H/24E/27/90	Test Distance:	3m
Test item:	Harmonic	Power:	AC 120V/60Hz
Frequency:	1851.5MHz	Temp.(°C)/Hum.(%RH):	26(°C)/60%RH
Mode:	4G_Band 2_3M_QPSK_CH18615	Date:	09/25/2017
Ant.Polar.:	Horizontal		

No.	Frequency (MHz)	Reading (dBm)	Correct Factor (dB)	Result (dBm)	Limit (dBm)	Margin (dB)	Remark
1	3703.000	-39.81	-6.12	-45.93	-13.00	-32.93	peak

Standard:	FCC Part 22H/24E/27/90	Test Distance:	3m
Test item:	Harmonic	Power:	AC 120V/60Hz
Frequency:	1851.5MHz	Temp.(°C)/Hum.(%RH):	26(°C)/60%RH
Mode:	4G_Band 2_3M_QPSK_CH18615	Date:	09/25/2017
Ant.Polar.:	Vertical		

No.	Frequency (MHz)	Reading (dBm)	Correct Factor (dB)	Result (dBm)	Limit (dBm)	Margin (dB)	Remark
1	3703.000	-39.81	-6.12	-45.93	-13.00	-32.93	peak



Standard:	FCC Part 22H/24E/27/90	Test Distance:	3m
Test item:	Harmonic	Power:	AC 120V/60Hz
Frequency:	1880MHz	Temp.(°C)/Hum.(%RH):	26(°C)/60%RH
Mode:	4G_Band 2_3M_QPSK_CH18900	Date:	09/25/2017
Ant.Polar.:	Horizontal		

No.	Frequency (MHz)	Reading (dBm)	Correct Factor (dB)	Result (dBm)	Limit (dBm)	Margin (dB)	Remark
1	3760.000	-40.66	-5.87	-46.53	-13.00	-33.53	peak

Standard:	FCC Part 22H/24E/27/90	Test Distance:	3m
Test item:	Harmonic	Power:	AC 120V/60Hz
Frequency:	1880MHz	Temp.(°C)/Hum.(%RH):	26(°C)/60%RH
Mode:	4G_Band 2_3M_QPSK_CH18900	Date:	09/25/2017
Ant.Polar.:	Vertical		

No.	Frequency (MHz)	Reading (dBm)	Correct Factor (dB)	Result (dBm)	Limit (dBm)	Margin (dB)	Remark
1	3760.000	-38.42	-5.87	-44.29	-13.00	-31.29	peak



Standard:	FCC Part 22H/24E/27/90	Test Distance:	3m
Test item:	Harmonic	Power:	AC 120V/60Hz
Frequency:	1908.5MHz	Temp.(°C)/Hum.(%RH):	26(°C)/60%RH
Mode:	4G_Band 2_3M_QPSK_CH19185	Date:	09/25/2017
Ant.Polar.:	Horizontal		

No.	Frequency (MHz)	Reading (dBm)	Correct Factor (dB)	Result (dBm)	Limit (dBm)	Margin (dB)	Remark
1	3817.000	-39.74	-5.82	-45.56	-13.00	-32.56	peak

Standard:	FCC Part 22H/24E/27/90	Test Distance:	3m
Test item:	Harmonic	Power:	AC 120V/60Hz
Frequency:	1908.5MHz	Temp.(°C)/Hum.(%RH):	26(°C)/60%RH
Mode:	4G_Band 2_3M_QPSK_CH19185	Date:	09/25/2017
Ant.Polar.:	Vertical		

No.	Frequency (MHz)	Reading (dBm)	Correct Factor (dB)	Result (dBm)	Limit (dBm)	Margin (dB)	Remark
1	3817.000	-39.74	-5.82	-45.56	-13.00	-32.56	peak



Standard:	FCC Part 22H/24E/27/90	Test Distance:	3m
Test item:	Harmonic	Power:	AC 120V/60Hz
Frequency:	1880MHz	Temp.(°C)/Hum.(%RH):	26(°C)/60%RH
Mode:	4G_Band 2_3M-16QAM_CH18900	Date:	09/25/2017
Ant.Polar.:	Horizontal		

No.	Frequency (MHz)	Reading (dBm)	Correct Factor (dB)	Result (dBm)	Limit (dBm)	Margin (dB)	Remark
1	3760.000	-50.90	-5.87	-56.77	-13.00	-43.77	peak

Standard:	FCC Part 22H/24E/27/90	Test Distance:	3m
Test item:	Harmonic	Power:	AC 120V/60Hz
Frequency:	1880MHz	Temp.(°C)/Hum.(%RH):	26(°C)/60%RH
Mode:	4G_Band 2_3M-16QAM_CH18900	Date:	09/25/2017
Ant.Polar.:	Vertical		

No.	Frequency (MHz)	Reading (dBm)	Correct Factor (dB)	Result (dBm)	Limit (dBm)	Margin (dB)	Remark
1	3760.000	-47.52	-5.87	-53.39	-13.00	-40.39	peak



Standard:	FCC Part 22H/24E/27/90	Test Distance:	3m
Test item:	Harmonic	Power:	AC 120V/60Hz
Frequency:	1852.5MHz	Temp.(°C)/Hum.(%RH):	26(°C)/60%RH
Mode:	4G_Band 2_5M_QPSK_CH18625	Date:	09/25/2017
Ant.Polar.:	Horizontal		

No.	Frequency (MHz)	Reading (dBm)	Correct Factor (dB)	Result (dBm)	Limit (dBm)	Margin (dB)	Remark
1	3705.000	-44.30	-6.09	-50.39	-13.00	-37.39	peak

Standard:	FCC Part 22H/24E/27/90	Test Distance:	3m
Test item:	Harmonic	Power:	AC 120V/60Hz
Frequency:	1852.5MHz	Temp.(°C)/Hum.(%RH):	26(°C)/60%RH
Mode:	4G_Band 2_5M_QPSK_CH18625	Date:	09/25/2017
Ant.Polar.:	Vertical		

No.	Frequency (MHz)	Reading (dBm)	Correct Factor (dB)	Result (dBm)	Limit (dBm)	Margin (dB)	Remark
1	3705.000	-44.30	-6.09	-50.39	-13.00	-37.39	peak



Standard:	FCC Part 22H/24E/27/90	Test Distance:	3m
Test item:	Harmonic	Power:	AC 120V/60Hz
Frequency:	1880MHz	Temp.(°C)/Hum.(%RH):	26(°C)/60%RH
Mode:	4G_Band 2_5M_QPSK_CH18900	Date:	09/25/2017
Ant.Polar.:	Horizontal		

No.	Frequency (MHz)	Reading (dBm)	Correct Factor (dB)	Result (dBm)	Limit (dBm)	Margin (dB)	Remark
1	3760.000	-44.22	-5.87	-50.09	-13.00	-37.09	peak

Standard:	FCC Part 22H/24E/27/90	Test Distance:	3m
Test item:	Harmonic	Power:	AC 120V/60Hz
Frequency:	1880MHz	Temp.(°C)/Hum.(%RH):	26(°C)/60%RH
Mode:	4G_Band 2_5M_QPSK_CH18900	Date:	09/25/2017
Ant.Polar.:	Vertical		

No.	Frequency (MHz)	Reading (dBm)	Correct Factor (dB)	Result (dBm)	Limit (dBm)	Margin (dB)	Remark
1	3760.000	-42.61	-5.87	-48.48	-13.00	-35.48	peak



Standard:	FCC Part 22H/24E/27/90	Test Distance:	3m
Test item:	Harmonic	Power:	AC 120V/60Hz
Frequency:	1907.5MHz	Temp.(°C)/Hum.(%RH):	26(°C)/60%RH
Mode:	4G_Band 2_5M_QPSK_CH19175	Date:	09/25/2017
Ant.Polar.:	Horizontal		

No.	Frequency (MHz)	Reading (dBm)	Correct Factor (dB)	Result (dBm)	Limit (dBm)	Margin (dB)	Remark
1	3815.000	-45.34	-5.82	-51.16	-13.00	-38.16	peak

Standard:	FCC Part 22H/24E/27/90	Test Distance:	3m
Test item:	Harmonic	Power:	AC 120V/60Hz
Frequency:	1907.5MHz	Temp.(°C)/Hum.(%RH):	26(°C)/60%RH
Mode:	4G_Band 2_5M_QPSK_CH19175	Date:	09/25/2017
Ant.Polar.:	Vertical		

No.	Frequency (MHz)	Reading (dBm)	Correct Factor (dB)	Result (dBm)	Limit (dBm)	Margin (dB)	Remark
1	3815.000	-43.46	-5.82	-49.28	-13.00	-36.28	peak



Standard:	FCC Part 22H/24E/27/90	Test Distance:	3m
Test item:	Harmonic	Power:	AC 120V/60Hz
Frequency:	1880MHz	Temp.(°C)/Hum.(%RH):	26(°C)/60%RH
Mode:	4G_Band 2_5M-16QAM_CH18900	Date:	09/25/2017
Ant.Polar.:	Horizontal		

No.	Frequency (MHz)	Reading (dBm)	Correct Factor (dB)	Result (dBm)	Limit (dBm)	Margin (dB)	Remark
1	3760.000	-51.07	-5.87	-56.94	-13.00	-43.94	peak

Standard:	FCC Part 22H/24E/27/90	Test Distance:	3m
Test item:	Harmonic	Power:	AC 120V/60Hz
Frequency:	1880MHz	Temp.(°C)/Hum.(%RH):	26(°C)/60%RH
Mode:	4G_Band 2_5M-16QAM_CH18900	Date:	09/25/2017
Ant.Polar.:	Vertical		

No.	Frequency (MHz)	Reading (dBm)	Correct Factor (dB)	Result (dBm)	Limit (dBm)	Margin (dB)	Remark
1	3760.000	-48.15	-5.87	-54.02	-13.00	-41.02	peak



Standard:	FCC Part 22H/24E/27/90	Test Distance:	3m
Test item:	Harmonic	Power:	AC 120V/60Hz
Frequency:	1855MHz	Temp.(°C)/Hum.(%RH):	26(°C)/60%RH
Mode:	4G_Band 2_10M_QPSK_CH18650	Date:	09/25/2017
Ant.Polar.:	Horizontal		

No.	Frequency (MHz)	Reading (dBm)	Correct Factor (dB)	Result (dBm)	Limit (dBm)	Margin (dB)	Remark
1	3710.000	-45.46	-6.07	-51.53	-13.00	-38.53	peak

Standard:	FCC Part 22H/24E/27/90	Test Distance:	3m
Test item:	Harmonic	Power:	AC 120V/60Hz
Frequency:	1855MHz	Temp.(°C)/Hum.(%RH):	26(°C)/60%RH
Mode:	4G_Band 2_10M_QPSK_CH18650	Date:	09/25/2017
Ant.Polar.:	Vertical		

No.	Frequency (MHz)	Reading (dBm)	Correct Factor (dB)	Result (dBm)	Limit (dBm)	Margin (dB)	Remark
1	3710.000	-42.50	-6.07	-48.57	-13.00	-35.57	peak



Standard:	FCC Part 22H/24E/27/90	Test Distance:	3m
Test item:	Harmonic	Power:	AC 120V/60Hz
Frequency:	1880MHz	Temp.(°C)/Hum.(%RH):	26(°C)/60%RH
Mode:	4G_Band 2_10M_QPSK_CH18900	Date:	09/25/2017
Ant.Polar.:	Horizontal		

No.	Frequency (MHz)	Reading (dBm)	Correct Factor (dB)	Result (dBm)	Limit (dBm)	Margin (dB)	Remark
1	3760.000	-45.66	-5.87	-51.53	-13.00	-38.53	peak

Standard:	FCC Part 22H/24E/27/90	Test Distance:	3m
Test item:	Harmonic	Power:	AC 120V/60Hz
Frequency:	1880MHz	Temp.(°C)/Hum.(%RH):	26(°C)/60%RH
Mode:	4G_Band 2_10M_QPSK_CH18900	Date:	09/25/2017
Ant.Polar.:	Vertical		

No.	Frequency (MHz)	Reading (dBm)	Correct Factor (dB)	Result (dBm)	Limit (dBm)	Margin (dB)	Remark
1	3760.000	-45.66	-5.87	-51.53	-13.00	-38.53	peak



Standard:	FCC Part 22H/24E/27/90	Test Distance:	3m
Test item:	Harmonic	Power:	AC 120V/60Hz
Frequency:	1905MHz	Temp.(°C)/Hum.(%RH):	26(°C)/60%RH
Mode:	4G_Band 2_10M_QPSK_CH19150	Date:	09/25/2017
Ant.Polar.:	Horizontal		

No.	Frequency (MHz)	Reading (dBm)	Correct Factor (dB)	Result (dBm)	Limit (dBm)	Margin (dB)	Remark
1	3810.000	-43.02	-5.81	-48.83	-13.00	-35.83	peak

Standard:	FCC Part 22H/24E/27/90	Test Distance:	3m
Test item:	Harmonic	Power:	AC 120V/60Hz
Frequency:	1905MHz	Temp.(°C)/Hum.(%RH):	26(°C)/60%RH
Mode:	4G_Band 2_10M_QPSK_CH19150	Date:	09/25/2017
Ant.Polar.:	Vertical		

No.	Frequency (MHz)	Reading (dBm)	Correct Factor (dB)	Result (dBm)	Limit (dBm)	Margin (dB)	Remark
1	3810.000	-44.66	-5.81	-50.47	-13.00	-37.47	peak



Standard:	FCC Part 22H/24E/27/90	Test Distance:	3m
Test item:	Harmonic	Power:	AC 120V/60Hz
Frequency:	1880MHz	Temp.(°C)/Hum.(%RH):	26(°C)/60%RH
Mode:	4G_Band 2_10M-16QAM_CH18900	Date:	09/25/2017
Ant.Polar.:	Horizontal		

No.	Frequency (MHz)	Reading (dBm)	Correct Factor (dB)	Result (dBm)	Limit (dBm)	Margin (dB)	Remark
1	3760.000	-48.83	-5.87	-54.70	-13.00	-41.70	peak

Standard:	FCC Part 22H/24E/27/90	Test Distance:	3m
Test item:	Harmonic	Power:	AC 120V/60Hz
Frequency:	1880MHz	Temp.(°C)/Hum.(%RH):	26(°C)/60%RH
Mode:	4G_Band 2_10M-16QAM_CH18900	Date:	09/25/2017
Ant.Polar.:	Vertical		

No.	Frequency (MHz)	Reading (dBm)	Correct Factor (dB)	Result (dBm)	Limit (dBm)	Margin (dB)	Remark
1	3760.000	-48.83	-5.87	-54.70	-13.00	-41.70	peak



Standard:	FCC Part 22H/24E/27/90	Test Distance:	3m
Test item:	Harmonic	Power:	AC 120V/60Hz
Frequency:	1857.5MHz	Temp.(°C)/Hum.(%RH):	26(°C)/60%RH
Mode:	4G_Band 2_15M_QPSK_CH18675	Date:	09/25/2017
Ant.Polar.:	Horizontal		

No.	Frequency (MHz)	Reading (dBm)	Correct Factor (dB)	Result (dBm)	Limit (dBm)	Margin (dB)	Remark
1	3715.000	-46.41	-6.06	-52.47	-13.00	-39.47	peak

Standard:	FCC Part 22H/24E/27/90	Test Distance:	3m
Test item:	Harmonic	Power:	AC 120V/60Hz
Frequency:	1857.5MHz	Temp.(°C)/Hum.(%RH):	26(°C)/60%RH
Mode:	4G_Band 2_15M_QPSK_CH18675	Date:	09/25/2017
Ant.Polar.:	Vertical		

No.	Frequency (MHz)	Reading (dBm)	Correct Factor (dB)	Result (dBm)	Limit (dBm)	Margin (dB)	Remark
1	3715.000	-44.18	-6.06	-50.24	-13.00	-37.24	peak



Standard:	FCC Part 22H/24E/27/90	Test Distance:	3m
Test item:	Harmonic	Power:	AC 120V/60Hz
Frequency:	1880MHz	Temp.(°C)/Hum.(%RH):	26(°C)/60%RH
Mode:	4G_Band 2_15M_QPSK_CH18900	Date:	09/25/2017
Ant.Polar.:	Horizontal		

No.	Frequency (MHz)	Reading (dBm)	Correct Factor (dB)	Result (dBm)	Limit (dBm)	Margin (dB)	Remark
1	3760.000	-45.47	-5.87	-51.34	-13.00	-38.34	peak

Standard:	FCC Part 22H/24E/27/90	Test Distance:	3m
Test item:	Harmonic	Power:	AC 120V/60Hz
Frequency:	1880MHz	Temp.(°C)/Hum.(%RH):	26(°C)/60%RH
Mode:	4G_Band 2_15M_QPSK_CH18900	Date:	09/25/2017
Ant.Polar.:	Vertical		

No.	Frequency (MHz)	Reading (dBm)	Correct Factor (dB)	Result (dBm)	Limit (dBm)	Margin (dB)	Remark
1	3760.000	-43.20	-5.87	-49.07	-13.00	-36.07	peak



Standard:	FCC Part 22H/24E/27/90	Test Distance:	3m
Test item:	Harmonic	Power:	AC 120V/60Hz
Frequency:	1902.5MHz	Temp.(°C)/Hum.(%RH):	26(°C)/60%RH
Mode:	4G_Band 2_15M_QPSK_CH19125	Date:	09/25/2017
Ant.Polar.:	Horizontal		

No.	Frequency (MHz)	Reading (dBm)	Correct Factor (dB)	Result (dBm)	Limit (dBm)	Margin (dB)	Remark
1	3805.000	-47.63	-5.83	-53.46	-13.00	-40.46	peak

Standard:	FCC Part 22H/24E/27/90	Test Distance:	3m
Test item:	Harmonic	Power:	AC 120V/60Hz
Frequency:	1902.5MHz	Temp.(°C)/Hum.(%RH):	26(°C)/60%RH
Mode:	4G_Band 2_15M_QPSK_CH19125	Date:	09/25/2017
Ant.Polar.:	Vertical		

No.	Frequency (MHz)	Reading (dBm)	Correct Factor (dB)	Result (dBm)	Limit (dBm)	Margin (dB)	Remark
1	3805.000	-44.04	-5.83	-49.87	-13.00	-36.87	peak



Standard:	FCC Part 22H/24E/27/90	Test Distance:	3m
Test item:	Harmonic	Power:	AC 120V/60Hz
Frequency:	1880MHz	Temp.(°C)/Hum.(%RH):	26(°C)/60%RH
Mode:	4G_Band 2_15M-16QAM_CH18900	Date:	09/25/2017
Ant.Polar.:	Horizontal		

No.	Frequency (MHz)	Reading (dBm)	Correct Factor (dB)	Result (dBm)	Limit (dBm)	Margin (dB)	Remark
1	3760.000	-49.62	-5.87	-55.49	-13.00	-42.49	peak

Standard:	FCC Part 22H/24E/27/90	Test Distance:	3m
Test item:	Harmonic	Power:	AC 120V/60Hz
Frequency:	1880MHz	Temp.(°C)/Hum.(%RH):	26(°C)/60%RH
Mode:	4G_Band 2_15M-16QAM_CH18900	Date:	09/25/2017
Ant.Polar.:	Vertical		

No.	Frequency (MHz)	Reading (dBm)	Correct Factor (dB)	Result (dBm)	Limit (dBm)	Margin (dB)	Remark
1	3760.000	-45.55	-5.87	-51.42	-13.00	-38.42	peak



Standard:	FCC Part 22H/24E/27/90	Test Distance:	3m
Test item:	Harmonic	Power:	AC 120V/60Hz
Frequency:	1860MHz	Temp.(°C)/Hum.(%RH):	26(°C)/60%RH
Mode:	4G_Band 2_20M_QPSK_CH18700	Date:	09/25/2017
Ant.Polar.:	Horizontal		

No.	Frequency (MHz)	Reading (dBm)	Correct Factor (dB)	Result (dBm)	Limit (dBm)	Margin (dB)	Remark
1	3720.000	-42.02	-6.03	-48.05	-13.00	-35.05	peak

Standard:	FCC Part 22H/24E/27/90	Test Distance:	3m
Test item:	Harmonic	Power:	AC 120V/60Hz
Frequency:	1860MHz	Temp.(°C)/Hum.(%RH):	26(°C)/60%RH
Mode:	4G_Band 2_20M_QPSK_CH18700	Date:	09/25/2017
Ant.Polar.:	Vertical		

No.	Frequency (MHz)	Reading (dBm)	Correct Factor (dB)	Result (dBm)	Limit (dBm)	Margin (dB)	Remark
1	3720.000	-42.02	-6.03	-48.05	-13.00	-35.05	peak



Standard:	FCC Part 22H/24E/27/90	Test Distance:	3m
Test item:	Harmonic	Power:	AC 120V/60Hz
Frequency:	1880MHz	Temp.(°C)/Hum.(%RH):	26(°C)/60%RH
Mode:	4G_Band 2_20M_QPSK_CH18900	Date:	09/25/2017
Ant.Polar.:	Horizontal		

No.	Frequency (MHz)	Reading (dBm)	Correct Factor (dB)	Result (dBm)	Limit (dBm)	Margin (dB)	Remark
1	3760.000	-41.92	-5.87	-47.79	-13.00	-34.79	peak

Standard:	FCC Part 22H/24E/27/90	Test Distance:	3m
Test item:	Harmonic	Power:	AC 120V/60Hz
Frequency:	1880MHz	Temp.(°C)/Hum.(%RH):	26(°C)/60%RH
Mode:	4G_Band 2_20M_QPSK_CH18900	Date:	09/25/2017
Ant.Polar.:	Vertical		

No.	Frequency (MHz)	Reading (dBm)	Correct Factor (dB)	Result (dBm)	Limit (dBm)	Margin (dB)	Remark
1	3760.000	-39.40	-5.87	-45.27	-13.00	-32.27	peak



Standard:	FCC Part 22H/24E/27/90	Test Distance:	3m
Test item:	Harmonic	Power:	AC 120V/60Hz
Frequency:	1900MHz	Temp.(°C)/Hum.(%RH):	26(°C)/60%RH
Mode:	4G_Band 2_20M_QPSK_CH19100	Date:	09/25/2017
Ant.Polar.:	Horizontal		

No.	Frequency (MHz)	Reading (dBm)	Correct Factor (dB)	Result (dBm)	Limit (dBm)	Margin (dB)	Remark
1	3800.000	-43.51	-5.83	-49.34	-13.00	-36.34	peak

Standard:	FCC Part 22H/24E/27/90	Test Distance:	3m
Test item:	Harmonic	Power:	AC 120V/60Hz
Frequency:	1900MHz	Temp.(°C)/Hum.(%RH):	26(°C)/60%RH
Mode:	4G_Band 2_20M_QPSK_CH19100	Date:	09/25/2017
Ant.Polar.:	Vertical		

No.	Frequency (MHz)	Reading (dBm)	Correct Factor (dB)	Result (dBm)	Limit (dBm)	Margin (dB)	Remark
1	3800.000	-40.86	-5.83	-46.69	-13.00	-33.69	peak



Standard:	FCC Part 22H/24E/27/90	Test Distance:	3m
Test item:	Harmonic	Power:	AC 120V/60Hz
Frequency:	1880MHz	Temp.(°C)/Hum.(%RH):	26(°C)/60%RH
Mode:	4G_Band 2_20M-16QAM_CH18900	Date:	09/25/2017
Ant.Polar.:	Horizontal		

No.	Frequency (MHz)	Reading (dBm)	Correct Factor (dB)	Result (dBm)	Limit (dBm)	Margin (dB)	Remark
1	3760.000	-50.91	-5.87	-56.78	-13.00	-43.78	peak

Standard:	FCC Part 22H/24E/27/90	Test Distance:	3m
Test item:	Harmonic	Power:	AC 120V/60Hz
Frequency:	1880MHz	Temp.(°C)/Hum.(%RH):	26(°C)/60%RH
Mode:	4G_Band 2_20M-16QAM_CH18900	Date:	09/25/2017
Ant.Polar.:	Vertical		

No.	Frequency (MHz)	Reading (dBm)	Correct Factor (dB)	Result (dBm)	Limit (dBm)	Margin (dB)	Remark
1	3760.000	-46.49	-5.87	-52.36	-13.00	-39.36	peak



Standard:	FCC Part 22H/24E/27/90	Test Distance:	3m
Test item:	Harmonic	Power:	AC 120V/60Hz
Frequency:	1710.7MHz	Temp.(°C)/Hum.(%RH):	26(°C)/60%RH
Mode:	4G_Band 4_1.4M_QPSK_CH19957	Date:	09/25/2017
Ant.Polar.:	Horizontal		

No.	Frequency (MHz)	Reading (dBm)	Correct Factor (dB)	Result (dBm)	Limit (dBm)	Margin (dB)	Remark
1	3421.400	-44.48	-7.32	-51.80	-13.00	-38.80	peak

Standard:	FCC Part 22H/24E/27/90	Test Distance:	3m
Test item:	Harmonic	Power:	AC 120V/60Hz
Frequency:	1710.7MHz	Temp.(°C)/Hum.(%RH):	26(°C)/60%RH
Mode:	4G_Band 4_1.4M_QPSK_CH19957	Date:	09/25/2017
Ant.Polar.:	Vertical		

No.	Frequency (MHz)	Reading (dBm)	Correct Factor (dB)	Result (dBm)	Limit (dBm)	Margin (dB)	Remark
1	3421.400	-44.48	-7.32	-51.80	-13.00	-38.80	peak



Standard:	FCC Part 22H/24E/27/90	Test Distance:	3m
Test item:	Harmonic	Power:	AC 120V/60Hz
Frequency:	1732.5MHz	Temp.(°C)/Hum.(%RH):	26(°C)/60%RH
Mode:	4G_Band 4_1.4M_QPSK_CH20175	Date:	09/25/2017
Ant.Polar.:	Horizontal		

No.	Frequency (MHz)	Reading (dBm)	Correct Factor (dB)	Result (dBm)	Limit (dBm)	Margin (dB)	Remark
1	3465.000	-44.02	-7.18	-51.20	-13.00	-38.20	peak

Standard:	FCC Part 22H/24E/27/90	Test Distance:	3m
Test item:	Harmonic	Power:	AC 120V/60Hz
Frequency:	1732.5MHz	Temp.(°C)/Hum.(%RH):	26(°C)/60%RH
Mode:	4G_Band 4_1.4M_QPSK_CH20175	Date:	09/25/2017
Ant.Polar.:	Vertical		

No.	Frequency (MHz)	Reading (dBm)	Correct Factor (dB)	Result (dBm)	Limit (dBm)	Margin (dB)	Remark
1	3465.000	-45.83	-7.18	-53.01	-13.00	-40.01	peak



Standard:	FCC Part 22H/24E/27/90	Test Distance:	3m
Test item:	Harmonic	Power:	AC 120V/60Hz
Frequency:	1754.3MHz	Temp.(°C)/Hum.(%RH):	26(°C)/60%RH
Mode:	4G_Band 4_1.4M_QPSK_CH20393	Date:	09/25/2017
Ant.Polar.:	Horizontal		

No.	Frequency (MHz)	Reading (dBm)	Correct Factor (dB)	Result (dBm)	Limit (dBm)	Margin (dB)	Remark
1	3508.600	-43.76	-7.03	-50.79	-13.00	-37.79	peak

Standard:	FCC Part 22H/24E/27/90	Test Distance:	3m
Test item:	Harmonic	Power:	AC 120V/60Hz
Frequency:	1754.3MHz	Temp.(°C)/Hum.(%RH):	26(°C)/60%RH
Mode:	4G_Band 4_1.4M_QPSK_CH20393	Date:	09/25/2017
Ant.Polar.:	Vertical		

No.	Frequency (MHz)	Reading (dBm)	Correct Factor (dB)	Result (dBm)	Limit (dBm)	Margin (dB)	Remark
1	3508.600	-40.68	-7.03	-47.71	-13.00	-34.71	peak



Standard:	FCC Part 22H/24E/27/90	Test Distance:	3m
Test item:	Harmonic	Power:	AC 120V/60Hz
Frequency:	1732.5MHz	Temp.(°C)/Hum.(%RH):	26(°C)/60%RH
Mode:	4G_Band 4_1.4M-16QAM_CH20175	Date:	09/25/2017
Ant.Polar.:	Horizontal		

No.	Frequency (MHz)	Reading (dBm)	Correct Factor (dB)	Result (dBm)	Limit (dBm)	Margin (dB)	Remark
1	3465.000	-46.29	-7.18	-53.47	-13.00	-40.47	peak

Standard:	FCC Part 22H/24E/27/90	Test Distance:	3m
Test item:	Harmonic	Power:	AC 120V/60Hz
Frequency:	1732.5MHz	Temp.(°C)/Hum.(%RH):	26(°C)/60%RH
Mode:	4G_Band 4_1.4M-16QAM_CH20175	Date:	09/25/2017
Ant.Polar.:	Vertical		

No.	Frequency (MHz)	Reading (dBm)	Correct Factor (dB)	Result (dBm)	Limit (dBm)	Margin (dB)	Remark
1	3465.000	-44.60	-7.18	-51.78	-13.00	-38.78	peak



Standard:	FCC Part 22H/24E/27/90	Test Distance:	3m
Test item:	Harmonic	Power:	AC 120V/60Hz
Frequency:	1711.5MHz	Temp.(°C)/Hum.(%RH):	26(°C)/60%RH
Mode:	4G_Band 4_3M_QPSK_CH19965	Date:	09/25/2017
Ant.Polar.:	Horizontal		

No.	Frequency (MHz)	Reading (dBm)	Correct Factor (dB)	Result (dBm)	Limit (dBm)	Margin (dB)	Remark
1	3423.000	-41.55	-7.31	-48.86	-13.00	-35.86	peak

Standard:	FCC Part 22H/24E/27/90	Test Distance:	3m
Test item:	Harmonic	Power:	AC 120V/60Hz
Frequency:	1711.5MHz	Temp.(°C)/Hum.(%RH):	26(°C)/60%RH
Mode:	4G_Band 4_3M_QPSK_CH19965	Date:	09/25/2017
Ant.Polar.:	Vertical		

No.	Frequency (MHz)	Reading (dBm)	Correct Factor (dB)	Result (dBm)	Limit (dBm)	Margin (dB)	Remark
1	3423.000	-41.55	-7.31	-48.86	-13.00	-35.86	peak



Standard:	FCC Part 22H/24E/27/90	Test Distance:	3m
Test item:	Harmonic	Power:	AC 120V/60Hz
Frequency:	1732.5MHz	Temp.(°C)/Hum.(%RH):	26(°C)/60%RH
Mode:	4G_Band 4_3M_QPSK_CH20175	Date:	09/25/2017
Ant.Polar.:	Horizontal		

No.	Frequency (MHz)	Reading (dBm)	Correct Factor (dB)	Result (dBm)	Limit (dBm)	Margin (dB)	Remark
1	3465.000	-38.71	-7.18	-45.89	-13.00	-32.89	peak

Standard:	FCC Part 22H/24E/27/90	Test Distance:	3m
Test item:	Harmonic	Power:	AC 120V/60Hz
Frequency:	1732.5MHz	Temp.(°C)/Hum.(%RH):	26(°C)/60%RH
Mode:	4G_Band 4_3M_QPSK_CH20175	Date:	09/25/2017
Ant.Polar.:	Vertical		

No.	Frequency (MHz)	Reading (dBm)	Correct Factor (dB)	Result (dBm)	Limit (dBm)	Margin (dB)	Remark
1	3465.000	-41.73	-7.18	-48.91	-13.00	-35.91	peak



Standard:	FCC Part 22H/24E/27/90	Test Distance:	3m
Test item:	Harmonic	Power:	AC 120V/60Hz
Frequency:	1753.5MHz	Temp.(°C)/Hum.(%RH):	26(°C)/60%RH
Mode:	4G_Band 4_3M_QPSK_CH20385	Date:	09/25/2017
Ant.Polar.:	Horizontal		

No.	Frequency (MHz)	Reading (dBm)	Correct Factor (dB)	Result (dBm)	Limit (dBm)	Margin (dB)	Remark
1	3507.000	-46.73	-7.03	-53.76	-13.00	-40.76	peak

Standard:	FCC Part 22H/24E/27/90	Test Distance:	3m
Test item:	Harmonic	Power:	AC 120V/60Hz
Frequency:	1753.5MHz	Temp.(°C)/Hum.(%RH):	26(°C)/60%RH
Mode:	4G_Band 4_3M_QPSK_CH20385	Date:	09/25/2017
Ant.Polar.:	Vertical		

No.	Frequency (MHz)	Reading (dBm)	Correct Factor (dB)	Result (dBm)	Limit (dBm)	Margin (dB)	Remark
1	3507.000	-46.73	-7.03	-53.76	-13.00	-40.76	peak



Standard:	FCC Part 22H/24E/27/90	Test Distance:	3m
Test item:	Harmonic	Power:	AC 120V/60Hz
Frequency:	1732.5MHz	Temp.(°C)/Hum.(%RH):	26(°C)/60%RH
Mode:	4G_Band 4_3M-16QAM_CH20175	Date:	09/25/2017
Ant.Polar.:	Horizontal		

No.	Frequency (MHz)	Reading (dBm)	Correct Factor (dB)	Result (dBm)	Limit (dBm)	Margin (dB)	Remark
1	3465.000	-48.31	-7.18	-55.49	-13.00	-42.49	peak

Standard:	FCC Part 22H/24E/27/90	Test Distance:	3m
Test item:	Harmonic	Power:	AC 120V/60Hz
Frequency:	1732.5MHz	Temp.(°C)/Hum.(%RH):	26(°C)/60%RH
Mode:	4G_Band 4_3M-16QAM_CH20175	Date:	09/25/2017
Ant.Polar.:	Vertical		

No.	Frequency (MHz)	Reading (dBm)	Correct Factor (dB)	Result (dBm)	Limit (dBm)	Margin (dB)	Remark
1	3465.000	-48.31	-7.18	-55.49	-13.00	-42.49	peak



Standard:	FCC Part 22H/24E/27/90	Test Distance:	3m
Test item:	Harmonic	Power:	AC 120V/60Hz
Frequency:	1712.5MHz	Temp.(°C)/Hum.(%RH):	26(°C)/60%RH
Mode:	4G_Band 4_5M_QPSK_CH19975	Date:	09/25/2017
Ant.Polar.:	Horizontal		

No.	Frequency (MHz)	Reading (dBm)	Correct Factor (dB)	Result (dBm)	Limit (dBm)	Margin (dB)	Remark
1	3425.000	-44.73	-7.31	-52.04	-13.00	-39.04	peak

Standard:	FCC Part 22H/24E/27/90	Test Distance:	3m
Test item:	Harmonic	Power:	AC 120V/60Hz
Frequency:	1712.5MHz	Temp.(°C)/Hum.(%RH):	26(°C)/60%RH
Mode:	4G_Band 4_5M_QPSK_CH19975	Date:	09/25/2017
Ant.Polar.:	Vertical		

No.	Frequency (MHz)	Reading (dBm)	Correct Factor (dB)	Result (dBm)	Limit (dBm)	Margin (dB)	Remark
1	3425.000	-44.73	-7.31	-52.04	-13.00	-39.04	peak



Standard:	FCC Part 22H/24E/27/90	Test Distance:	3m
Test item:	Harmonic	Power:	AC 120V/60Hz
Frequency:	1732.5MHz	Temp.(°C)/Hum.(%RH):	26(°C)/60%RH
Mode:	4G_Band 4_5M_QPSK_CH20175	Date:	09/25/2017
Ant.Polar.:	Horizontal		

No.	Frequency (MHz)	Reading (dBm)	Correct Factor (dB)	Result (dBm)	Limit (dBm)	Margin (dB)	Remark
1	3465.000	-42.15	-7.18	-49.33	-13.00	-36.33	peak

Standard:	FCC Part 22H/24E/27/90	Test Distance:	3m
Test item:	Harmonic	Power:	AC 120V/60Hz
Frequency:	1732.5MHz	Temp.(°C)/Hum.(%RH):	26(°C)/60%RH
Mode:	4G_Band 4_5M_QPSK_CH20175	Date:	09/25/2017
Ant.Polar.:	Vertical		

No.	Frequency (MHz)	Reading (dBm)	Correct Factor (dB)	Result (dBm)	Limit (dBm)	Margin (dB)	Remark
1	3465.000	-42.15	-7.18	-49.33	-13.00	-36.33	peak



Standard:	FCC Part 22H/24E/27/90	Test Distance:	3m
Test item:	Harmonic	Power:	AC 120V/60Hz
Frequency:	1752.5MHz	Temp.(°C)/Hum.(%RH):	26(°C)/60%RH
Mode:	4G_Band 4_5M_QPSK_CH20375	Date:	09/25/2017
Ant.Polar.:	Horizontal		

No.	Frequency (MHz)	Reading (dBm)	Correct Factor (dB)	Result (dBm)	Limit (dBm)	Margin (dB)	Remark
1	3505.000	-39.65	-7.04	-46.69	-13.00	-33.69	peak

Standard:	FCC Part 22H/24E/27/90	Test Distance:	3m
Test item:	Harmonic	Power:	AC 120V/60Hz
Frequency:	1752.5MHz	Temp.(°C)/Hum.(%RH):	26(°C)/60%RH
Mode:	4G_Band 4_5M_QPSK_CH20375	Date:	09/25/2017
Ant.Polar.:	Vertical		

No.	Frequency (MHz)	Reading (dBm)	Correct Factor (dB)	Result (dBm)	Limit (dBm)	Margin (dB)	Remark
1	3505.000	-39.65	-7.04	-46.69	-13.00	-33.69	peak



Standard:	FCC Part 22H/24E/27/90	Test Distance:	3m
Test item:	Harmonic	Power:	AC 120V/60Hz
Frequency:	1732.5MHz	Temp.(°C)/Hum.(%RH):	26(°C)/60%RH
Mode:	4G_Band 4_5M-16QAM_CH20175	Date:	09/25/2017
Ant.Polar.:	Horizontal		

No.	Frequency (MHz)	Reading (dBm)	Correct Factor (dB)	Result (dBm)	Limit (dBm)	Margin (dB)	Remark
1	3465.000	-50.83	-7.18	-58.01	-13.00	-45.01	peak

Standard:	FCC Part 22H/24E/27/90	Test Distance:	3m
Test item:	Harmonic	Power:	AC 120V/60Hz
Frequency:	1732.5MHz	Temp.(°C)/Hum.(%RH):	26(°C)/60%RH
Mode:	4G_Band 4_5M-16QAM_CH20175	Date:	09/25/2017
Ant.Polar.:	Vertical		

No.	Frequency (MHz)	Reading (dBm)	Correct Factor (dB)	Result (dBm)	Limit (dBm)	Margin (dB)	Remark
1	3465.000	-48.21	-7.18	-55.39	-13.00	-42.39	peak



Standard:	FCC Part 22H/24E/27/90	Test Distance:	3m
Test item:	Harmonic	Power:	AC 120V/60Hz
Frequency:	1715MHz	Temp.(°C)/Hum.(%RH):	26(°C)/60%RH
Mode:	4G_Band 4_10M_QPSK_CH20000	Date:	09/25/2017
Ant.Polar.:	Horizontal		

No.	Frequency (MHz)	Reading (dBm)	Correct Factor (dB)	Result (dBm)	Limit (dBm)	Margin (dB)	Remark
1	3430.000	-40.43	-7.29	-47.72	-13.00	-34.72	peak

Standard:	FCC Part 22H/24E/27/90	Test Distance:	3m
Test item:	Harmonic	Power:	AC 120V/60Hz
Frequency:	1715MHz	Temp.(°C)/Hum.(%RH):	26(°C)/60%RH
Mode:	4G_Band 4_10M_QPSK_CH20000	Date:	09/25/2017
Ant.Polar.:	Vertical		

No.	Frequency (MHz)	Reading (dBm)	Correct Factor (dB)	Result (dBm)	Limit (dBm)	Margin (dB)	Remark
1	3430.000	-40.43	-7.29	-47.72	-13.00	-34.72	peak



Standard:	FCC Part 22H/24E/27/90	Test Distance:	3m
Test item:	Harmonic	Power:	AC 120V/60Hz
Frequency:	1732.5MHz	Temp.(°C)/Hum.(%RH):	26(°C)/60%RH
Mode:	4G_Band 4_10M_QPSK_CH20175	Date:	09/25/2017
Ant.Polar.:	Horizontal		

No.	Frequency (MHz)	Reading (dBm)	Correct Factor (dB)	Result (dBm)	Limit (dBm)	Margin (dB)	Remark
1	3465.000	-41.63	-7.18	-48.81	-13.00	-35.81	peak

Standard:	FCC Part 22H/24E/27/90	Test Distance:	3m
Test item:	Harmonic	Power:	AC 120V/60Hz
Frequency:	1732.5MHz	Temp.(°C)/Hum.(%RH):	26(°C)/60%RH
Mode:	4G_Band 4_10M_QPSK_CH20175	Date:	09/25/2017
Ant.Polar.:	Vertical		

No.	Frequency (MHz)	Reading (dBm)	Correct Factor (dB)	Result (dBm)	Limit (dBm)	Margin (dB)	Remark
1	3465.000	-38.06	-7.18	-45.24	-13.00	-32.24	peak



Standard:	FCC Part 22H/24E/27/90	Test Distance:	3m
Test item:	Harmonic	Power:	AC 120V/60Hz
Frequency:	1750MHz	Temp.(°C)/Hum.(%RH):	26(°C)/60%RH
Mode:	4G_Band 4_10M_QPSK_CH20350	Date:	09/25/2017
Ant.Polar.:	Horizontal		

No.	Frequency (MHz)	Reading (dBm)	Correct Factor (dB)	Result (dBm)	Limit (dBm)	Margin (dB)	Remark
1	3500.000	-38.99	-7.07	-46.06	-13.00	-33.06	peak

Standard:	FCC Part 22H/24E/27/90	Test Distance:	3m
Test item:	Harmonic	Power:	AC 120V/60Hz
Frequency:	1750MHz	Temp.(°C)/Hum.(%RH):	26(°C)/60%RH
Mode:	4G_Band 4_10M_QPSK_CH20350	Date:	09/25/2017
Ant.Polar.:	Vertical		

No.	Frequency (MHz)	Reading (dBm)	Correct Factor (dB)	Result (dBm)	Limit (dBm)	Margin (dB)	Remark
1	3500.000	-38.99	-7.07	-46.06	-13.00	-33.06	peak



Standard:	FCC Part 22H/24E/27/90	Test Distance:	3m
Test item:	Harmonic	Power:	AC 120V/60Hz
Frequency:	1732.5MHz	Temp.(°C)/Hum.(%RH):	26(°C)/60%RH
Mode:	4G_Band 4_10M-16QAM_CH20175	Date:	09/25/2017
Ant.Polar.:	Horizontal		

No.	Frequency (MHz)	Reading (dBm)	Correct Factor (dB)	Result (dBm)	Limit (dBm)	Margin (dB)	Remark
1	3465.000	-42.43	-7.18	-49.61	-13.00	-36.61	peak

Standard:	FCC Part 22H/24E/27/90	Test Distance:	3m
Test item:	Harmonic	Power:	AC 120V/60Hz
Frequency:	1732.5MHz	Temp.(°C)/Hum.(%RH):	26(°C)/60%RH
Mode:	4G_Band 4_10M-16QAM_CH20175	Date:	09/25/2017
Ant.Polar.:	Vertical		

No.	Frequency (MHz)	Reading (dBm)	Correct Factor (dB)	Result (dBm)	Limit (dBm)	Margin (dB)	Remark
1	3465.000	-42.43	-7.18	-49.61	-13.00	-36.61	peak



Standard:	FCC Part 22H/24E/27/90	Test Distance:	3m
Test item:	Harmonic	Power:	AC 120V/60Hz
Frequency:	1717.5MHz	Temp.(°C)/Hum.(%RH):	26(°C)/60%RH
Mode:	4G_Band 4_15M_QPSK_CH20025	Date:	09/25/2017
Ant.Polar.:	Horizontal		

No.	Frequency (MHz)	Reading (dBm)	Correct Factor (dB)	Result (dBm)	Limit (dBm)	Margin (dB)	Remark
1	3435.000	-40.80	-7.27	-48.07	-13.00	-35.07	peak

Standard:	FCC Part 22H/24E/27/90	Test Distance:	3m
Test item:	Harmonic	Power:	AC 120V/60Hz
Frequency:	1717.5MHz	Temp.(°C)/Hum.(%RH):	26(°C)/60%RH
Mode:	4G_Band 4_15M_QPSK_CH20025	Date:	09/25/2017
Ant.Polar.:	Vertical		

No.	Frequency (MHz)	Reading (dBm)	Correct Factor (dB)	Result (dBm)	Limit (dBm)	Margin (dB)	Remark
1	3435.000	-41.75	-7.27	-49.02	-13.00	-36.02	peak



Standard:	FCC Part 22H/24E/27/90	Test Distance:	3m
Test item:	Harmonic	Power:	AC 120V/60Hz
Frequency:	1732.5MHz	Temp.(°C)/Hum.(%RH):	26(°C)/60%RH
Mode:	4G_Band 4_15M_QPSK_CH20175	Date:	09/25/2017
Ant.Polar.:	Horizontal		

No.	Frequency (MHz)	Reading (dBm)	Correct Factor (dB)	Result (dBm)	Limit (dBm)	Margin (dB)	Remark
1	3465.000	-41.67	-7.18	-48.85	-13.00	-35.85	peak

Standard:	FCC Part 22H/24E/27/90	Test Distance:	3m
Test item:	Harmonic	Power:	AC 120V/60Hz
Frequency:	1732.5MHz	Temp.(°C)/Hum.(%RH):	26(°C)/60%RH
Mode:	4G_Band 4_15M_QPSK_CH20175	Date:	09/25/2017
Ant.Polar.:	Vertical		

No.	Frequency (MHz)	Reading (dBm)	Correct Factor (dB)	Result (dBm)	Limit (dBm)	Margin (dB)	Remark
1	3465.000	-38.43	-7.18	-45.61	-13.00	-32.61	peak



Standard:	FCC Part 22H/24E/27/90	Test Distance:	3m
Test item:	Harmonic	Power:	AC 120V/60Hz
Frequency:	1747.5MHz	Temp.(°C)/Hum.(%RH):	26(°C)/60%RH
Mode:	4G_Band 4_15M_QPSK_CH20325	Date:	09/25/2017
Ant.Polar.:	Horizontal		

No.	Frequency (MHz)	Reading (dBm)	Correct Factor (dB)	Result (dBm)	Limit (dBm)	Margin (dB)	Remark
1	3495.000	-42.82	-7.09	-49.91	-13.00	-36.91	peak

Standard:	FCC Part 22H/24E/27/90	Test Distance:	3m
Test item:	Harmonic	Power:	AC 120V/60Hz
Frequency:	1747.5MHz	Temp.(°C)/Hum.(%RH):	26(°C)/60%RH
Mode:	4G_Band 4_15M_QPSK_CH20325	Date:	09/25/2017
Ant.Polar.:	Vertical		

No.	Frequency (MHz)	Reading (dBm)	Correct Factor (dB)	Result (dBm)	Limit (dBm)	Margin (dB)	Remark
1	3495.000	-40.43	-7.09	-47.52	-13.00	-34.52	peak



Standard:	FCC Part 22H/24E/27/90	Test Distance:	3m
Test item:	Harmonic	Power:	AC 120V/60Hz
Frequency:	1732.5MHz	Temp.(°C)/Hum.(%RH):	26(°C)/60%RH
Mode:	4G_Band 4_15M-16QAM_CH20175	Date:	09/25/2017
Ant.Polar.:	Horizontal		

No.	Frequency (MHz)	Reading (dBm)	Correct Factor (dB)	Result (dBm)	Limit (dBm)	Margin (dB)	Remark
1	3465.000	-46.31	-7.18	-53.49	-13.00	-40.49	peak

Standard:	FCC Part 22H/24E/27/90	Test Distance:	3m
Test item:	Harmonic	Power:	AC 120V/60Hz
Frequency:	1732.5MHz	Temp.(°C)/Hum.(%RH):	26(°C)/60%RH
Mode:	4G_Band 4_15M-16QAM_CH20175	Date:	09/25/2017
Ant.Polar.:	Vertical		

No.	Frequency (MHz)	Reading (dBm)	Correct Factor (dB)	Result (dBm)	Limit (dBm)	Margin (dB)	Remark
1	3465.000	-46.31	-7.18	-53.49	-13.00	-40.49	peak



Standard:	FCC Part 22H/24E/27/90	Test Distance:	3m
Test item:	Harmonic	Power:	AC 120V/60Hz
Frequency:	1720MHz	Temp.(°C)/Hum.(%RH):	26(°C)/60%RH
Mode:	4G_Band 4_20M_QPSK_CH20050	Date:	09/25/2017
Ant.Polar.:	Horizontal		

No.	Frequency (MHz)	Reading (dBm)	Correct Factor (dB)	Result (dBm)	Limit (dBm)	Margin (dB)	Remark
1	3440.000	-42.67	-7.26	-49.93	-13.00	-36.93	peak

Standard:	FCC Part 22H/24E/27/90	Test Distance:	3m
Test item:	Harmonic	Power:	AC 120V/60Hz
Frequency:	1720MHz	Temp.(°C)/Hum.(%RH):	26(°C)/60%RH
Mode:	4G_Band 4_20M_QPSK_CH20050	Date:	09/25/2017
Ant.Polar.:	Vertical		

No.	Frequency (MHz)	Reading (dBm)	Correct Factor (dB)	Result (dBm)	Limit (dBm)	Margin (dB)	Remark
1	3440.000	-42.67	-7.26	-49.93	-13.00	-36.93	peak



Standard:	FCC Part 22H/24E/27/90	Test Distance:	3m
Test item:	Harmonic	Power:	AC 120V/60Hz
Frequency:	1732.5MHz	Temp.(°C)/Hum.(%RH):	26(°C)/60%RH
Mode:	4G_Band 4_20M_QPSK_CH20175	Date:	09/25/2017
Ant.Polar.:	Horizontal		

No.	Frequency (MHz)	Reading (dBm)	Correct Factor (dB)	Result (dBm)	Limit (dBm)	Margin (dB)	Remark
1	3465.000	-44.66	-7.18	-51.84	-13.00	-38.84	peak

Standard:	FCC Part 22H/24E/27/90	Test Distance:	3m
Test item:	Harmonic	Power:	AC 120V/60Hz
Frequency:	-285MHz	Temp.(°C)/Hum.(%RH):	26(°C)/60%RH
Mode:	4G_Band 4_20M_QPSK_CH20175	Date:	09/25/2017
Ant.Polar.:	Vertical		

No.	Frequency (MHz)	Reading (dBm)	Correct Factor (dB)	Result (dBm)	Limit (dBm)	Margin (dB)	Remark
1	3465.000	-40.52	-7.18	-47.70	-13.00	-34.70	peak



Standard:	FCC Part 22H/24E/27/90	Test Distance:	3m
Test item:	Harmonic	Power:	AC 120V/60Hz
Frequency:	1745MHz	Temp.(°C)/Hum.(%RH):	26(°C)/60%RH
Mode:	4G_Band 4_20M_QPSK_CH20300	Date:	09/25/2017
Ant.Polar.:	Horizontal		

No.	Frequency (MHz)	Reading (dBm)	Correct Factor (dB)	Result (dBm)	Limit (dBm)	Margin (dB)	Remark
1	3490.000	-38.02	-7.10	-45.12	-13.00	-32.12	peak

Standard:	FCC Part 22H/24E/27/90	Test Distance:	3m
Test item:	Harmonic	Power:	AC 120V/60Hz
Frequency:	1745MHz	Temp.(°C)/Hum.(%RH):	26(°C)/60%RH
Mode:	4G_Band 4_20M_QPSK_CH20300	Date:	09/25/2017
Ant.Polar.:	Vertical		

No.	Frequency (MHz)	Reading (dBm)	Correct Factor (dB)	Result (dBm)	Limit (dBm)	Margin (dB)	Remark
1	3490.000	-38.02	-7.10	-45.12	-13.00	-32.12	peak



Standard:	FCC Part 22H/24E/27/90	Test Distance:	3m
Test item:	Harmonic	Power:	AC 120V/60Hz
Frequency:	1732.5MHz	Temp.(°C)/Hum.(%RH):	26(°C)/60%RH
Mode:	4G_Band 4_20M-16QAM_CH20175	Date:	09/25/2017
Ant.Polar.:	Horizontal		

No.	Frequency (MHz)	Reading (dBm)	Correct Factor (dB)	Result (dBm)	Limit (dBm)	Margin (dB)	Remark
1	3465.000	-45.19	-7.18	-52.37	-13.00	-39.37	peak

Standard:	FCC Part 22H/24E/27/90	Test Distance:	3m
Test item:	Harmonic	Power:	AC 120V/60Hz
Frequency:	1732.5MHz	Temp.(°C)/Hum.(%RH):	26(°C)/60%RH
Mode:	4G_Band 4_20M-16QAM_CH20175	Date:	09/25/2017
Ant.Polar.:	Vertical		

No.	Frequency (MHz)	Reading (dBm)	Correct Factor (dB)	Result (dBm)	Limit (dBm)	Margin (dB)	Remark
1	3465.000	-49.91	-7.18	-57.09	-13.00	-44.09	peak



Standard:	FCC Part 22H/24E/27/90	Test Distance:	3m
Test item:	Harmonic	Power:	AC 120V/60Hz
Frequency:	824.7MHz	Temp.(°C)/Hum.(%RH):	26(°C)/60%RH
Mode:	4G_Band 5_1.4M_QPSK_CH20407	Date:	09/25/2017
Ant.Polar.:	Horizontal		

No.	Frequency (MHz)	Reading (dBm)	Correct Factor (dB)	Result (dBm)	Limit (dBm)	Margin (dB)	Remark
1	1649.400	-39.36	-13.42	-52.78	-13.00	-39.78	peak

Standard:	FCC Part 22H/24E/27/90	Test Distance:	3m
Test item:	Harmonic	Power:	AC 120V/60Hz
Frequency:	824.7MHz	Temp.(°C)/Hum.(%RH):	26(°C)/60%RH
Mode:	4G_Band 5_1.4M_QPSK_CH20407	Date:	09/25/2017
Ant.Polar.:	Vertical		

No.	Frequency (MHz)	Reading (dBm)	Correct Factor (dB)	Result (dBm)	Limit (dBm)	Margin (dB)	Remark
1	1649.400	-35.55	-13.42	-48.97	-13.00	-35.97	peak



Standard:	FCC Part 22H/24E/27/90	Test Distance:	3m
Test item:	Harmonic	Power:	AC 120V/60Hz
Frequency:	836.5MHz	Temp.(°C)/Hum.(%RH):	26(°C)/60%RH
Mode:	4G_Band 5_1.4M_QPSK_CH20525	Date:	09/25/2017
Ant.Polar.:	Horizontal		

No.	Frequency (MHz)	Reading (dBm)	Correct Factor (dB)	Result (dBm)	Limit (dBm)	Margin (dB)	Remark
1	1673.000	-32.29	-13.10	-45.39	-13.00	-32.39	peak

Standard:	FCC Part 22H/24E/27/90	Test Distance:	3m
Test item:	Harmonic	Power:	AC 120V/60Hz
Frequency:	836.5MHz	Temp.(°C)/Hum.(%RH):	26(°C)/60%RH
Mode:	4G_Band 5_1.4M_QPSK_CH20525	Date:	09/25/2017
Ant.Polar.:	Vertical		

No.	Frequency (MHz)	Reading (dBm)	Correct Factor (dB)	Result (dBm)	Limit (dBm)	Margin (dB)	Remark
1	1673.000	-34.52	-13.10	-47.62	-13.00	-34.62	peak



Standard:	FCC Part 22H/24E/27/90	Test Distance:	3m
Test item:	Harmonic	Power:	AC 120V/60Hz
Frequency:	848.3MHz	Temp.(°C)/Hum.(%RH):	26(°C)/60%RH
Mode:	4G_Band 5_1.4M_QPSK_CH20643	Date:	09/25/2017
Ant.Polar.:	Horizontal		

No.	Frequency (MHz)	Reading (dBm)	Correct Factor (dB)	Result (dBm)	Limit (dBm)	Margin (dB)	Remark
1	1696.600	-33.31	-12.77	-46.08	-13.00	-33.08	peak

Standard:	FCC Part 22H/24E/27/90	Test Distance:	3m
Test item:	Harmonic	Power:	AC 120V/60Hz
Frequency:	848.3MHz	Temp.(°C)/Hum.(%RH):	26(°C)/60%RH
Mode:	4G_Band 5_1.4M_QPSK_CH20643	Date:	09/25/2017
Ant.Polar.:	Vertical		

No.	Frequency (MHz)	Reading (dBm)	Correct Factor (dB)	Result (dBm)	Limit (dBm)	Margin (dB)	Remark
1	1696.600	-33.31	-12.77	-46.08	-13.00	-33.08	peak



Standard:	FCC Part 22H/24E/27/90	Test Distance:	3m
Test item:	Harmonic	Power:	AC 120V/60Hz
Frequency:	836.5MHz	Temp.(°C)/Hum.(%RH):	26(°C)/60%RH
Mode:	4G_Band 5_1.4M-16QAM_CH20525	Date:	09/25/2017
Ant.Polar.:	Horizontal		

No.	Frequency (MHz)	Reading (dBm)	Correct Factor (dB)	Result (dBm)	Limit (dBm)	Margin (dB)	Remark
1	1673.000	-39.78	-13.10	-52.88	-13.00	-39.88	peak

Standard:	FCC Part 22H/24E/27/90	Test Distance:	3m
Test item:	Harmonic	Power:	AC 120V/60Hz
Frequency:	836.5MHz	Temp.(°C)/Hum.(%RH):	26(°C)/60%RH
Mode:	4G_Band 5_1.4M-16QAM_CH20525	Date:	09/25/2017
Ant.Polar.:	Vertical		

No.	Frequency (MHz)	Reading (dBm)	Correct Factor (dB)	Result (dBm)	Limit (dBm)	Margin (dB)	Remark
1	1673.000	-36.16	-13.10	-49.26	-13.00	-36.26	peak



Standard:	FCC Part 22H/24E/27/90	Test Distance:	3m
Test item:	Harmonic	Power:	AC 120V/60Hz
Frequency:	825.5MHz	Temp.(°C)/Hum.(%RH):	26(°C)/60%RH
Mode:	4G_Band 5_3M_QPSK_CH20415	Date:	09/25/2017
Ant.Polar.:	Horizontal		

No.	Frequency (MHz)	Reading (dBm)	Correct Factor (dB)	Result (dBm)	Limit (dBm)	Margin (dB)	Remark
1	1651.000	-36.59	-13.39	-49.98	-13.00	-36.98	peak

Standard:	FCC Part 22H/24E/27/90	Test Distance:	3m
Test item:	Harmonic	Power:	AC 120V/60Hz
Frequency:	825.5MHz	Temp.(°C)/Hum.(%RH):	26(°C)/60%RH
Mode:	4G_Band 5_3M_QPSK_CH20415	Date:	09/25/2017
Ant.Polar.:	Vertical		

No.	Frequency (MHz)	Reading (dBm)	Correct Factor (dB)	Result (dBm)	Limit (dBm)	Margin (dB)	Remark
1	1651.000	-36.59	-13.39	-49.98	-13.00	-36.98	peak



Standard:	FCC Part 22H/24E/27/90	Test Distance:	3m
Test item:	Harmonic	Power:	AC 120V/60Hz
Frequency:	836.5MHz	Temp.(°C)/Hum.(%RH):	26(°C)/60%RH
Mode:	4G_Band 5_3M_QPSK_CH20525	Date:	09/25/2017
Ant.Polar.:	Horizontal		

No.	Frequency (MHz)	Reading (dBm)	Correct Factor (dB)	Result (dBm)	Limit (dBm)	Margin (dB)	Remark
1	1673.000	-35.15	-13.10	-48.25	-13.00	-35.25	peak

Standard:	FCC Part 22H/24E/27/90	Test Distance:	3m
Test item:	Harmonic	Power:	AC 120V/60Hz
Frequency:	836.5MHz	Temp.(°C)/Hum.(%RH):	26(°C)/60%RH
Mode:	4G_Band 5_3M_QPSK_CH20525	Date:	09/25/2017
Ant.Polar.:	Vertical		

No.	Frequency (MHz)	Reading (dBm)	Correct Factor (dB)	Result (dBm)	Limit (dBm)	Margin (dB)	Remark
1	1673.000	-33.61	-13.10	-46.71	-13.00	-33.71	peak



Standard:	FCC Part 22H/24E/27/90	Test Distance:	3m
Test item:	Harmonic	Power:	AC 120V/60Hz
Frequency:	847.5MHz	Temp.(°C)/Hum.(%RH):	26(°C)/60%RH
Mode:	4G_Band 5_3M_QPSK_CH20635	Date:	09/25/2017
Ant.Polar.:	Horizontal		

No.	Frequency (MHz)	Reading (dBm)	Correct Factor (dB)	Result (dBm)	Limit (dBm)	Margin (dB)	Remark
1	1695.000	-33.97	-12.79	-46.76	-13.00	-33.76	peak

Standard:	FCC Part 22H/24E/27/90	Test Distance:	3m
Test item:	Harmonic	Power:	AC 120V/60Hz
Frequency:	847.5MHz	Temp.(°C)/Hum.(%RH):	26(°C)/60%RH
Mode:	4G_Band 5_3M_QPSK_CH20635	Date:	09/25/2017
Ant.Polar.:	Vertical		

No.	Frequency (MHz)	Reading (dBm)	Correct Factor (dB)	Result (dBm)	Limit (dBm)	Margin (dB)	Remark
1	1695.000	-32.19	-12.79	-44.98	-13.00	-31.98	peak



Standard:	FCC Part 22H/24E/27/90	Test Distance:	3m
Test item:	Harmonic	Power:	AC 120V/60Hz
Frequency:	836.5MHz	Temp.(°C)/Hum.(%RH):	26(°C)/60%RH
Mode:	4G_Band 5_3M-16QAM_CH20525	Date:	09/25/2017
Ant.Polar.:	Horizontal		

No.	Frequency (MHz)	Reading (dBm)	Correct Factor (dB)	Result (dBm)	Limit (dBm)	Margin (dB)	Remark
1	1673.000	-40.81	-13.10	-53.91	-13.00	-40.91	peak

Standard:	FCC Part 22H/24E/27/90	Test Distance:	3m
Test item:	Harmonic	Power:	AC 120V/60Hz
Frequency:	836.5MHz	Temp.(°C)/Hum.(%RH):	26(°C)/60%RH
Mode:	4G_Band 5_3M-16QAM_CH20525	Date:	09/25/2017
Ant.Polar.:	Vertical		

No.	Frequency (MHz)	Reading (dBm)	Correct Factor (dB)	Result (dBm)	Limit (dBm)	Margin (dB)	Remark
1	1673.000	-40.81	-13.10	-53.91	-13.00	-40.91	peak



Standard:	FCC Part 22H/24E/27/90	Test Distance:	3m
Test item:	Harmonic	Power:	AC 120V/60Hz
Frequency:	826.5MHz	Temp.(°C)/Hum.(%RH):	26(°C)/60%RH
Mode:	4G_Band 5_5M_QPSK_CH20425	Date:	09/25/2017
Ant.Polar.:	Horizontal		

No.	Frequency (MHz)	Reading (dBm)	Correct Factor (dB)	Result (dBm)	Limit (dBm)	Margin (dB)	Remark
1	1653.000	-35.46	-13.37	-48.83	-13.00	-35.83	peak

Standard:	FCC Part 22H/24E/27/90	Test Distance:	3m
Test item:	Harmonic	Power:	AC 120V/60Hz
Frequency:	826.5MHz	Temp.(°C)/Hum.(%RH):	26(°C)/60%RH
Mode:	4G_Band 5_5M_QPSK_CH20425	Date:	09/25/2017
Ant.Polar.:	Vertical		

No.	Frequency (MHz)	Reading (dBm)	Correct Factor (dB)	Result (dBm)	Limit (dBm)	Margin (dB)	Remark
1	1653.000	-35.46	-13.37	-48.83	-13.00	-35.83	peak



Standard:	FCC Part 22H/24E/27/90	Test Distance:	3m
Test item:	Harmonic	Power:	AC 120V/60Hz
Frequency:	836.5MHz	Temp.(°C)/Hum.(%RH):	26(°C)/60%RH
Mode:	4G_Band 5_5M_QPSK_CH20525	Date:	09/25/2017
Ant.Polar.:	Horizontal		

No.	Frequency (MHz)	Reading (dBm)	Correct Factor (dB)	Result (dBm)	Limit (dBm)	Margin (dB)	Remark
1	1673.000	-39.38	-13.10	-52.48	-13.00	-39.48	peak

Standard:	FCC Part 22H/24E/27/90	Test Distance:	3m
Test item:	Harmonic	Power:	AC 120V/60Hz
Frequency:	836.5MHz	Temp.(°C)/Hum.(%RH):	26(°C)/60%RH
Mode:	4G_Band 5_5M_QPSK_CH20525	Date:	09/25/2017
Ant.Polar.:	Vertical		

No.	Frequency (MHz)	Reading (dBm)	Correct Factor (dB)	Result (dBm)	Limit (dBm)	Margin (dB)	Remark
1	1673.000	-36.81	-13.10	-49.91	-13.00	-36.91	peak



Standard:	FCC Part 22H/24E/27/90	Test Distance:	3m
Test item:	Harmonic	Power:	AC 120V/60Hz
Frequency:	846.5MHz	Temp.(°C)/Hum.(%RH):	26(°C)/60%RH
Mode:	4G_Band 5_5M_QPSK_CH20625	Date:	09/25/2017
Ant.Polar.:	Horizontal		

No.	Frequency (MHz)	Reading (dBm)	Correct Factor (dB)	Result (dBm)	Limit (dBm)	Margin (dB)	Remark
1	1693.000	-38.21	-12.83	-51.04	-13.00	-38.04	peak

Standard:	FCC Part 22H/24E/27/90	Test Distance:	3m
Test item:	Harmonic	Power:	AC 120V/60Hz
Frequency:	846.5MHz	Temp.(°C)/Hum.(%RH):	26(°C)/60%RH
Mode:	4G_Band 5_5M_QPSK_CH20625	Date:	09/25/2017
Ant.Polar.:	Vertical		

No.	Frequency (MHz)	Reading (dBm)	Correct Factor (dB)	Result (dBm)	Limit (dBm)	Margin (dB)	Remark
1	1693.000	-38.21	-12.83	-51.04	-13.00	-38.04	peak



Standard:	FCC Part 22H/24E/27/90	Test Distance:	3m
Test item:	Harmonic	Power:	AC 120V/60Hz
Frequency:	836.5MHz	Temp.(°C)/Hum.(%RH):	26(°C)/60%RH
Mode:	4G_Band 5_5M-16QAM_CH20525	Date:	09/25/2017
Ant.Polar.:	Horizontal		

No.	Frequency (MHz)	Reading (dBm)	Correct Factor (dB)	Result (dBm)	Limit (dBm)	Margin (dB)	Remark
1	1673.000	-43.94	-13.10	-57.04	-13.00	-44.04	peak

Standard:	FCC Part 22H/24E/27/90	Test Distance:	3m
Test item:	Harmonic	Power:	AC 120V/60Hz
Frequency:	836.5MHz	Temp.(°C)/Hum.(%RH):	26(°C)/60%RH
Mode:	4G_Band 5_5M-16QAM_CH20525	Date:	09/25/2017
Ant.Polar.:	Vertical		

No.	Frequency (MHz)	Reading (dBm)	Correct Factor (dB)	Result (dBm)	Limit (dBm)	Margin (dB)	Remark
1	1673.000	-43.51	-13.10	-56.61	-13.00	-43.61	peak



Standard:	FCC Part 22H/24E/27/90	Test Distance:	3m
Test item:	Harmonic	Power:	AC 120V/60Hz
Frequency:	829MHz	Temp.(°C)/Hum.(%RH):	26(°C)/60%RH
Mode:	4G_Band 5_10M_QPSK_CH20450	Date:	09/25/2017
Ant.Polar.:	Horizontal		

No.	Frequency (MHz)	Reading (dBm)	Correct Factor (dB)	Result (dBm)	Limit (dBm)	Margin (dB)	Remark
1	1658.000	-38.19	-13.29	-51.48	-13.00	-38.48	peak

Standard:	FCC Part 22H/24E/27/90	Test Distance:	3m
Test item:	Harmonic	Power:	AC 120V/60Hz
Frequency:	829MHz	Temp.(°C)/Hum.(%RH):	26(°C)/60%RH
Mode:	4G_Band 5_10M_QPSK_CH20450	Date:	09/25/2017
Ant.Polar.:	Vertical		

No.	Frequency (MHz)	Reading (dBm)	Correct Factor (dB)	Result (dBm)	Limit (dBm)	Margin (dB)	Remark
1	1658.000	-38.99	-13.29	-52.28	-13.00	-39.28	peak



Standard:	FCC Part 22H/24E/27/90	Test Distance:	3m
Test item:	Harmonic	Power:	AC 120V/60Hz
Frequency:	836.5MHz	Temp.(°C)/Hum.(%RH):	26(°C)/60%RH
Mode:	4G_Band 5_10M_QPSK_CH20525	Date:	09/25/2017
Ant.Polar.:	Horizontal		

No.	Frequency (MHz)	Reading (dBm)	Correct Factor (dB)	Result (dBm)	Limit (dBm)	Margin (dB)	Remark
1	1673.000	-33.62	-13.10	-46.72	-13.00	-33.72	peak

Standard:	FCC Part 22H/24E/27/90	Test Distance:	3m
Test item:	Harmonic	Power:	AC 120V/60Hz
Frequency:	836.5MHz	Temp.(°C)/Hum.(%RH):	26(°C)/60%RH
Mode:	4G_Band 5_10M_QPSK_CH20525	Date:	09/25/2017
Ant.Polar.:	Vertical		

No.	Frequency (MHz)	Reading (dBm)	Correct Factor (dB)	Result (dBm)	Limit (dBm)	Margin (dB)	Remark
1	1673.000	-33.62	-13.10	-46.72	-13.00	-33.72	peak



Standard:	FCC Part 22H/24E/27/90	Test Distance:	3m
Test item:	Harmonic	Power:	AC 120V/60Hz
Frequency:	844MHz	Temp.(°C)/Hum.(%RH):	26(°C)/60%RH
Mode:	4G_Band 5_10M_QPSK_CH20600	Date:	09/25/2017
Ant.Polar.:	Horizontal		

No.	Frequency (MHz)	Reading (dBm)	Correct Factor (dB)	Result (dBm)	Limit (dBm)	Margin (dB)	Remark
1	1688.000	-32.63	-12.89	-45.52	-13.00	-32.52	peak

Standard:	FCC Part 22H/24E/27/90	Test Distance:	3m
Test item:	Harmonic	Power:	AC 120V/60Hz
Frequency:	844MHz	Temp.(°C)/Hum.(%RH):	26(°C)/60%RH
Mode:	4G_Band 5_10M_QPSK_CH20600	Date:	09/25/2017
Ant.Polar.:	Vertical		

No.	Frequency (MHz)	Reading (dBm)	Correct Factor (dB)	Result (dBm)	Limit (dBm)	Margin (dB)	Remark
1	1688.000	-32.63	-12.89	-45.52	-13.00	-32.52	peak



Standard:	FCC Part 22H/24E/27/90	Test Distance:	3m
Test item:	Harmonic	Power:	AC 120V/60Hz
Frequency:	836.5MHz	Temp.(°C)/Hum.(%RH):	26(°C)/60%RH
Mode:	4G_Band 5_10M-16QAM_CH20525	Date:	09/25/2017
Ant.Polar.:	Horizontal		

No.	Frequency (MHz)	Reading (dBm)	Correct Factor (dB)	Result (dBm)	Limit (dBm)	Margin (dB)	Remark
1	1673.000	-42.13	-13.10	-55.23	-13.00	-42.23	peak

Standard:	FCC Part 22H/24E/27/90	Test Distance:	3m
Test item:	Harmonic	Power:	AC 120V/60Hz
Frequency:	836.5MHz	Temp.(°C)/Hum.(%RH):	26(°C)/60%RH
Mode:	4G_Band 5_10M-16QAM_CH20525	Date:	09/25/2017
Ant.Polar.:	Vertical		

No.	Frequency (MHz)	Reading (dBm)	Correct Factor (dB)	Result (dBm)	Limit (dBm)	Margin (dB)	Remark
1	1673.000	-39.39	-13.10	-52.49	-13.00	-39.49	peak



Standard:	FCC Part 22H/24E/27/90	Test Distance:	3m
Test item:	Harmonic	Power:	AC 120V/60Hz
Frequency:	699.7MHz	Temp.(°C)/Hum.(%RH):	26(°C)/60%RH
Mode:	4G_Band 12_1.4M_QPSK_CH23017	Date:	09/25/2017
Ant.Polar.:	Horizontal		

No.	Frequency (MHz)	Reading (dBm)	Correct Factor (dB)	Result (dBm)	Limit (dBm)	Margin (dB)	Remark
1	1399.400	-36.13	-15.11	-51.24	-13.00	-38.24	peak

Standard:	FCC Part 22H/24E/27/90	Test Distance:	3m
Test item:	Harmonic	Power:	AC 120V/60Hz
Frequency:	699.7MHz	Temp.(°C)/Hum.(%RH):	26(°C)/60%RH
Mode:	4G_Band 12_1.4M_QPSK_CH23017	Date:	09/25/2017
Ant.Polar.:	Vertical		

No.	Frequency (MHz)	Reading (dBm)	Correct Factor (dB)	Result (dBm)	Limit (dBm)	Margin (dB)	Remark
1	1399.400	-36.13	-15.11	-51.24	-13.00	-38.24	peak



Standard:	FCC Part 22H/24E/27/90	Test Distance:	3m
Test item:	Harmonic	Power:	AC 120V/60Hz
Frequency:	707.5MHz	Temp.(°C)/Hum.(%RH):	26(°C)/60%RH
Mode:	4G_Band 12_1.4M_QPSK_CH23095	Date:	09/25/2017
Ant.Polar.:	Horizontal		

No.	Frequency (MHz)	Reading (dBm)	Correct Factor (dB)	Result (dBm)	Limit (dBm)	Margin (dB)	Remark
1	1415.000	-35.05	-15.14	-50.19	-13.00	-37.19	peak

Standard:	FCC Part 22H/24E/27/90	Test Distance:	3m
Test item:	Harmonic	Power:	AC 120V/60Hz
Frequency:	707.5MHz	Temp.(°C)/Hum.(%RH):	26(°C)/60%RH
Mode:	4G_Band 12_1.4M_QPSK_CH23095	Date:	09/25/2017
Ant.Polar.:	Vertical		

No.	Frequency (MHz)	Reading (dBm)	Correct Factor (dB)	Result (dBm)	Limit (dBm)	Margin (dB)	Remark
1	1415.000	-33.01	-15.14	-48.15	-13.00	-35.15	peak



Standard:	FCC Part 22H/24E/27/90	Test Distance:	3m
Test item:	Harmonic	Power:	AC 120V/60Hz
Frequency:	715.3MHz	Temp.(°C)/Hum.(%RH):	26(°C)/60%RH
Mode:	4G_Band 12_1.4M_QPSK_CH23173	Date:	09/25/2017
Ant.Polar.:	Horizontal		

No.	Frequency (MHz)	Reading (dBm)	Correct Factor (dB)	Result (dBm)	Limit (dBm)	Margin (dB)	Remark
1	1430.600	-33.71	-15.18	-48.89	-13.00	-35.89	peak

Standard:	FCC Part 22H/24E/27/90	Test Distance:	3m
Test item:	Harmonic	Power:	AC 120V/60Hz
Frequency:	715.3MHz	Temp.(°C)/Hum.(%RH):	26(°C)/60%RH
Mode:	4G_Band 12_1.4M_QPSK_CH23173	Date:	09/25/2017
Ant.Polar.:	Vertical		

No.	Frequency (MHz)	Reading (dBm)	Correct Factor (dB)	Result (dBm)	Limit (dBm)	Margin (dB)	Remark
1	1430.600	-30.34	-15.18	-45.52	-13.00	-32.52	peak



Standard:	FCC Part 22H/24E/27/90	Test Distance:	3m
Test item:	Harmonic	Power:	AC 120V/60Hz
Frequency:	707.5MHz	Temp.(°C)/Hum.(%RH):	26(°C)/60%RH
Mode:	4G_Band 12_1.4M-16QAM_CH23095	Date:	09/25/2017
Ant.Polar.:	Horizontal		

No.	Frequency (MHz)	Reading (dBm)	Correct Factor (dB)	Result (dBm)	Limit (dBm)	Margin (dB)	Remark
1	1415.000	-35.88	-15.14	-51.02	-13.00	-38.02	peak

Standard:	FCC Part 22H/24E/27/90	Test Distance:	3m
Test item:	Harmonic	Power:	AC 120V/60Hz
Frequency:	707.5MHz	Temp.(°C)/Hum.(%RH):	26(°C)/60%RH
Mode:	4G_Band 12_1.4M-16QAM_CH23095	Date:	09/25/2017
Ant.Polar.:	Vertical		

No.	Frequency (MHz)	Reading (dBm)	Correct Factor (dB)	Result (dBm)	Limit (dBm)	Margin (dB)	Remark
1	1415.000	-35.88	-15.14	-51.02	-13.00	-38.02	peak



Standard:	FCC Part 22H/24E/27/90	Test Distance:	3m
Test item:	Harmonic	Power:	AC 120V/60Hz
Frequency:	700.5MHz	Temp.(°C)/Hum.(%RH):	26(°C)/60%RH
Mode:	4G_Band 12_3M_QPSK_CH23025	Date:	09/25/2017
Ant.Polar.:	Horizontal		

No.	Frequency (MHz)	Reading (dBm)	Correct Factor (dB)	Result (dBm)	Limit (dBm)	Margin (dB)	Remark
1	1401.000	-31.56	-15.12	-46.68	-13.00	-33.68	peak

Standard:	FCC Part 22H/24E/27/90	Test Distance:	3m
Test item:	Harmonic	Power:	AC 120V/60Hz
Frequency:	700.5MHz	Temp.(°C)/Hum.(%RH):	26(°C)/60%RH
Mode:	4G_Band 12_3M_QPSK_CH23025	Date:	09/25/2017
Ant.Polar.:	Vertical		

No.	Frequency (MHz)	Reading (dBm)	Correct Factor (dB)	Result (dBm)	Limit (dBm)	Margin (dB)	Remark
1	1401.000	-31.56	-15.12	-46.68	-13.00	-33.68	peak



Standard:	FCC Part 22H/24E/27/90	Test Distance:	3m
Test item:	Harmonic	Power:	AC 120V/60Hz
Frequency:	707.5MHz	Temp.(°C)/Hum.(%RH):	26(°C)/60%RH
Mode:	4G_Band 12_3M_QPSK_CH23095	Date:	09/25/2017
Ant.Polar.:	Horizontal		

No.	Frequency (MHz)	Reading (dBm)	Correct Factor (dB)	Result (dBm)	Limit (dBm)	Margin (dB)	Remark
1	1415.000	-34.84	-15.14	-49.98	-13.00	-36.98	peak

Standard:	FCC Part 22H/24E/27/90	Test Distance:	3m
Test item:	Harmonic	Power:	AC 120V/60Hz
Frequency:	707.5MHz	Temp.(°C)/Hum.(%RH):	26(°C)/60%RH
Mode:	4G_Band 12_3M_QPSK_CH23095	Date:	09/25/2017
Ant.Polar.:	Vertical		

No.	Frequency (MHz)	Reading (dBm)	Correct Factor (dB)	Result (dBm)	Limit (dBm)	Margin (dB)	Remark
1	1415.000	-31.00	-15.14	-46.14	-13.00	-33.14	peak



Standard:	FCC Part 22H/24E/27/90	Test Distance:	3m
Test item:	Harmonic	Power:	AC 120V/60Hz
Frequency:	714.5MHz	Temp.(°C)/Hum.(%RH):	26(°C)/60%RH
Mode:	4G_Band 12_3M_QPSK_CH23165	Date:	09/25/2017
Ant.Polar.:	Horizontal		

No.	Frequency (MHz)	Reading (dBm)	Correct Factor (dB)	Result (dBm)	Limit (dBm)	Margin (dB)	Remark
1	1429.000	-32.56	-15.17	-47.73	-13.00	-34.73	peak

Standard:	FCC Part 22H/24E/27/90	Test Distance:	3m
Test item:	Harmonic	Power:	AC 120V/60Hz
Frequency:	714.5MHz	Temp.(°C)/Hum.(%RH):	26(°C)/60%RH
Mode:	4G_Band 12_3M_QPSK_CH23165	Date:	09/25/2017
Ant.Polar.:	Vertical		

No.	Frequency (MHz)	Reading (dBm)	Correct Factor (dB)	Result (dBm)	Limit (dBm)	Margin (dB)	Remark
1	1429.000	-32.56	-15.17	-47.73	-13.00	-34.73	peak



Standard:	FCC Part 22H/24E/27/90	Test Distance:	3m
Test item:	Harmonic	Power:	AC 120V/60Hz
Frequency:	707.5MHz	Temp.(°C)/Hum.(%RH):	26(°C)/60%RH
Mode:	4G_Band 12_3M-16QAM_CH23095	Date:	09/25/2017
Ant.Polar.:	Horizontal		

No.	Frequency (MHz)	Reading (dBm)	Correct Factor (dB)	Result (dBm)	Limit (dBm)	Margin (dB)	Remark
1	1415.000	-37.94	-15.14	-53.08	-13.00	-40.08	peak

Standard:	FCC Part 22H/24E/27/90	Test Distance:	3m
Test item:	Harmonic	Power:	AC 120V/60Hz
Frequency:	707.5MHz	Temp.(°C)/Hum.(%RH):	26(°C)/60%RH
Mode:	4G_Band 12_3M-16QAM_CH23095	Date:	09/25/2017
Ant.Polar.:	Vertical		

No.	Frequency (MHz)	Reading (dBm)	Correct Factor (dB)	Result (dBm)	Limit (dBm)	Margin (dB)	Remark
1	1415.000	-35.65	-15.14	-50.79	-13.00	-37.79	peak



Standard:	FCC Part 22H/24E/27/90	Test Distance:	3m
Test item:	Harmonic	Power:	AC 120V/60Hz
Frequency:	701.5MHz	Temp.(°C)/Hum.(%RH):	26(°C)/60%RH
Mode:	4G_Band 12_5M_QPSK_CH23035	Date:	09/25/2017
Ant.Polar.:	Horizontal		

No.	Frequency (MHz)	Reading (dBm)	Correct Factor (dB)	Result (dBm)	Limit (dBm)	Margin (dB)	Remark
1	1403.000	-36.67	-15.11	-51.78	-13.00	-38.78	peak

Standard:	FCC Part 22H/24E/27/90	Test Distance:	3m
Test item:	Harmonic	Power:	AC 120V/60Hz
Frequency:	701.5MHz	Temp.(°C)/Hum.(%RH):	26(°C)/60%RH
Mode:	4G_Band 12_5M_QPSK_CH23035	Date:	09/25/2017
Ant.Polar.:	Vertical		

No.	Frequency (MHz)	Reading (dBm)	Correct Factor (dB)	Result (dBm)	Limit (dBm)	Margin (dB)	Remark
1	1403.000	-36.67	-15.11	-51.78	-13.00	-38.78	peak



Standard:	FCC Part 22H/24E/27/90	Test Distance:	3m
Test item:	Harmonic	Power:	AC 120V/60Hz
Frequency:	707.5MHz	Temp.(°C)/Hum.(%RH):	26(°C)/60%RH
Mode:	4G_Band 12_5M_QPSK_CH23095	Date:	09/25/2017
Ant.Polar.:	Horizontal		

No.	Frequency (MHz)	Reading (dBm)	Correct Factor (dB)	Result (dBm)	Limit (dBm)	Margin (dB)	Remark
1	1415.000	-34.02	-15.14	-49.16	-13.00	-36.16	peak

Standard:	FCC Part 22H/24E/27/90	Test Distance:	3m
Test item:	Harmonic	Power:	AC 120V/60Hz
Frequency:	707.5MHz	Temp.(°C)/Hum.(%RH):	26(°C)/60%RH
Mode:	4G_Band 12_5M_QPSK_CH23095	Date:	09/25/2017
Ant.Polar.:	Vertical		

No.	Frequency (MHz)	Reading (dBm)	Correct Factor (dB)	Result (dBm)	Limit (dBm)	Margin (dB)	Remark
1	1415.000	-34.02	-15.14	-49.16	-13.00	-36.16	peak



Standard:	FCC Part 22H/24E/27/90	Test Distance:	3m
Test item:	Harmonic	Power:	AC 120V/60Hz
Frequency:	713.5MHz	Temp.(°C)/Hum.(%RH):	26(°C)/60%RH
Mode:	4G_Band 12_5M_QPSK_CH23155	Date:	09/25/2017
Ant.Polar.:	Horizontal		

No.	Frequency (MHz)	Reading (dBm)	Correct Factor (dB)	Result (dBm)	Limit (dBm)	Margin (dB)	Remark
1	1427.000	-37.11	-15.18	-52.29	-13.00	-39.29	peak

Standard:	FCC Part 22H/24E/27/90	Test Distance:	3m
Test item:	Harmonic	Power:	AC 120V/60Hz
Frequency:	713.5MHz	Temp.(°C)/Hum.(%RH):	26(°C)/60%RH
Mode:	4G_Band 12_5M_QPSK_CH23155	Date:	09/25/2017
Ant.Polar.:	Vertical		

No.	Frequency (MHz)	Reading (dBm)	Correct Factor (dB)	Result (dBm)	Limit (dBm)	Margin (dB)	Remark
1	1427.000	-37.11	-15.18	-52.29	-13.00	-39.29	peak



Standard:	FCC Part 22H/24E/27/90	Test Distance:	3m
Test item:	Harmonic	Power:	AC 120V/60Hz
Frequency:	707.5MHz	Temp.(°C)/Hum.(%RH):	26(°C)/60%RH
Mode:	4G_Band 12_5M-16QAM_CH23095	Date:	09/25/2017
Ant.Polar.:	Horizontal		

No.	Frequency (MHz)	Reading (dBm)	Correct Factor (dB)	Result (dBm)	Limit (dBm)	Margin (dB)	Remark
1	1415.000	-33.93	-15.14	-49.07	-13.00	-36.07	peak

Standard:	FCC Part 22H/24E/27/90	Test Distance:	3m
Test item:	Harmonic	Power:	AC 120V/60Hz
Frequency:	707.5MHz	Temp.(°C)/Hum.(%RH):	26(°C)/60%RH
Mode:	4G_Band 12_5M-16QAM_CH23095	Date:	09/25/2017
Ant.Polar.:	Vertical		

No.	Frequency (MHz)	Reading (dBm)	Correct Factor (dB)	Result (dBm)	Limit (dBm)	Margin (dB)	Remark
1	1415.000	-33.93	-15.14	-49.07	-13.00	-36.07	peak



Standard:	FCC Part 22H/24E/27/90	Test Distance:	3m
Test item:	Harmonic	Power:	AC 120V/60Hz
Frequency:	704MHz	Temp.(°C)/Hum.(%RH):	26(°C)/60%RH
Mode:	4G_Band 12_10M_QPSK_CH23060	Date:	09/25/2017
Ant.Polar.:	Horizontal		

No.	Frequency (MHz)	Reading (dBm)	Correct Factor (dB)	Result (dBm)	Limit (dBm)	Margin (dB)	Remark
1	1408.000	-36.72	-15.12	-51.84	-13.00	-38.84	peak

Standard:	FCC Part 22H/24E/27/90	Test Distance:	3m
Test item:	Harmonic	Power:	AC 120V/60Hz
Frequency:	704MHz	Temp.(°C)/Hum.(%RH):	26(°C)/60%RH
Mode:	4G_Band 12_10M_QPSK_CH23060	Date:	09/25/2017
Ant.Polar.:	Vertical		

No.	Frequency (MHz)	Reading (dBm)	Correct Factor (dB)	Result (dBm)	Limit (dBm)	Margin (dB)	Remark
1	1408.000	-36.72	-15.12	-51.84	-13.00	-38.84	peak



Standard:	FCC Part 22H/24E/27/90	Test Distance:	3m
Test item:	Harmonic	Power:	AC 120V/60Hz
Frequency:	707.5MHz	Temp.(°C)/Hum.(%RH):	26(°C)/60%RH
Mode:	4G_Band 12_10M_QPSK_CH23095	Date:	09/25/2017
Ant.Polar.:	Horizontal		

No.	Frequency (MHz)	Reading (dBm)	Correct Factor (dB)	Result (dBm)	Limit (dBm)	Margin (dB)	Remark
1	1415.000	-37.93	-15.14	-53.07	-13.00	-40.07	peak

Standard:	FCC Part 22H/24E/27/90	Test Distance:	3m
Test item:	Harmonic	Power:	AC 120V/60Hz
Frequency:	707.5MHz	Temp.(°C)/Hum.(%RH):	26(°C)/60%RH
Mode:	4G_Band 12_10M_QPSK_CH23095	Date:	09/25/2017
Ant.Polar.:	Vertical		

No.	Frequency (MHz)	Reading (dBm)	Correct Factor (dB)	Result (dBm)	Limit (dBm)	Margin (dB)	Remark
1	1415.000	-37.93	-15.14	-53.07	-13.00	-40.07	peak



Standard:	FCC Part 22H/24E/27/90	Test Distance:	3m
Test item:	Harmonic	Power:	AC 120V/60Hz
Frequency:	711MHz	Temp.(°C)/Hum.(%RH):	26(°C)/60%RH
Mode:	4G_Band 12_10M_QPSK_CH23130	Date:	09/25/2017
Ant.Polar.:	Horizontal		

No.	Frequency (MHz)	Reading (dBm)	Correct Factor (dB)	Result (dBm)	Limit (dBm)	Margin (dB)	Remark
1	1422.000	-41.23	-15.16	-56.39	-13.00	-43.39	peak

Standard:	FCC Part 22H/24E/27/90	Test Distance:	3m
Test item:	Harmonic	Power:	AC 120V/60Hz
Frequency:	711MHz	Temp.(°C)/Hum.(%RH):	26(°C)/60%RH
Mode:	4G_Band 12_10M_QPSK_CH23130	Date:	09/25/2017
Ant.Polar.:	Vertical		

No.	Frequency (MHz)	Reading (dBm)	Correct Factor (dB)	Result (dBm)	Limit (dBm)	Margin (dB)	Remark
1	1422.000	-39.25	-15.16	-54.41	-13.00	-41.41	peak



Standard:	FCC Part 22H/24E/27/90	Test Distance:	3m
Test item:	Harmonic	Power:	AC 120V/60Hz
Frequency:	707.5MHz	Temp.(°C)/Hum.(%RH):	26(°C)/60%RH
Mode:	4G_Band 12_10M-16QAM_CH23095	Date:	09/25/2017
Ant.Polar.:	Horizontal		

No.	Frequency (MHz)	Reading (dBm)	Correct Factor (dB)	Result (dBm)	Limit (dBm)	Margin (dB)	Remark
1	1415.000	-39.15	-15.14	-54.29	-13.00	-41.29	peak

Standard:	FCC Part 22H/24E/27/90	Test Distance:	3m
Test item:	Harmonic	Power:	AC 120V/60Hz
Frequency:	707.5MHz	Temp.(°C)/Hum.(%RH):	26(°C)/60%RH
Mode:	4G_Band 12_10M-16QAM_CH23095	Date:	09/25/2017
Ant.Polar.:	Vertical		

No.	Frequency (MHz)	Reading (dBm)	Correct Factor (dB)	Result (dBm)	Limit (dBm)	Margin (dB)	Remark
1	1415.000	-36.52	-15.14	-51.66	-13.00	-38.66	peak



Standard:	FCC Part 22H/24E/27/90	Test Distance:	3m
Test item:	Harmonic	Power:	AC 120V/60Hz
Frequency:	779.5MHz	Temp.(°C)/Hum.(%RH):	26(°C)/60%RH
Mode:	4G_Band 13_5M_QPSK_CH23205	Date:	09/25/2017
Ant.Polar.:	Horizontal		

No.	Frequency (MHz)	Reading (dBm)	Correct Factor (dB)	Result (dBm)	Limit (dBm)	Margin (dB)	Remark
1	1559.000	-38.61	-14.60	-53.21	-40.00	-13.21	peak

Standard:	FCC Part 22H/24E/27/90	Test Distance:	3m
Test item:	Harmonic	Power:	AC 120V/60Hz
Frequency:	779.5MHz	Temp.(°C)/Hum.(%RH):	26(°C)/60%RH
Mode:	4G_Band 13_5M_QPSK_CH23205	Date:	09/25/2017
Ant.Polar.:	Vertical		

No.	Frequency (MHz)	Reading (dBm)	Correct Factor (dB)	Result (dBm)	Limit (dBm)	Margin (dB)	Remark
1	1559.000	-41.18	-14.60	-55.78	-40.00	-15.78	peak



Standard:	FCC Part 22H/24E/27/90	Test Distance:	3m
Test item:	Harmonic	Power:	AC 120V/60Hz
Frequency:	782MHz	Temp.(°C)/Hum.(%RH):	26(°C)/60%RH
Mode:	4G_Band 13_5M_QPSK_CH23230	Date:	09/25/2017
Ant.Polar.:	Horizontal		

No.	Frequency (MHz)	Reading (dBm)	Correct Factor (dB)	Result (dBm)	Limit (dBm)	Margin (dB)	Remark
1	1564.000	-40.59	-14.55	-55.14	-40.00	-15.14	peak

Standard:	FCC Part 22H/24E/27/90	Test Distance:	3m
Test item:	Harmonic	Power:	AC 120V/60Hz
Frequency:	782MHz	Temp.(°C)/Hum.(%RH):	26(°C)/60%RH
Mode:	4G_Band 13_5M_QPSK_CH23230	Date:	09/25/2017
Ant.Polar.:	Vertical		

No.	Frequency (MHz)	Reading (dBm)	Correct Factor (dB)	Result (dBm)	Limit (dBm)	Margin (dB)	Remark
1	1564.000	-38.64	-14.55	-53.19	-40.00	-13.19	peak



Standard:	FCC Part 22H/24E/27/90	Test Distance:	3m
Test item:	Harmonic	Power:	AC 120V/60Hz
Frequency:	784.5MHz	Temp.(°C)/Hum.(%RH):	26(°C)/60%RH
Mode:	4G_Band 13_5M_QPSK_CH23255	Date:	09/25/2017
Ant.Polar.:	Horizontal		

No.	Frequency (MHz)	Reading (dBm)	Correct Factor (dB)	Result (dBm)	Limit (dBm)	Margin (dB)	Remark
1	1569.000	-42.19	-14.48	-56.67	-40.00	-16.67	peak

Standard:	FCC Part 22H/24E/27/90	Test Distance:	3m
Test item:	Harmonic	Power:	AC 120V/60Hz
Frequency:	784.5MHz	Temp.(°C)/Hum.(%RH):	26(°C)/60%RH
Mode:	4G_Band 13_5M_QPSK_CH23255	Date:	09/25/2017
Ant.Polar.:	Vertical		

No.	Frequency (MHz)	Reading (dBm)	Correct Factor (dB)	Result (dBm)	Limit (dBm)	Margin (dB)	Remark
1	1569.000	-37.66	-14.48	-52.14	-40.00	-12.14	peak



Standard:	FCC Part 22H/24E/27/90	Test Distance:	3m
Test item:	Harmonic	Power:	AC 120V/60Hz
Frequency:	782MHz	Temp.(°C)/Hum.(%RH):	26(°C)/60%RH
Mode:	4G_Band 13_5M-16QAM_CH23230	Date:	09/25/2017
Ant.Polar.:	Horizontal		

No.	Frequency (MHz)	Reading (dBm)	Correct Factor (dB)	Result (dBm)	Limit (dBm)	Margin (dB)	Remark
1	1564.000	-40.28	-14.55	-54.83	-40.00	-14.83	peak

Standard:	FCC Part 22H/24E/27/90	Test Distance:	3m
Test item:	Harmonic	Power:	AC 120V/60Hz
Frequency:	782MHz	Temp.(°C)/Hum.(%RH):	26(°C)/60%RH
Mode:	4G_Band 13_5M-16QAM_CH23230	Date:	09/25/2017
Ant.Polar.:	Vertical		

No.	Frequency (MHz)	Reading (dBm)	Correct Factor (dB)	Result (dBm)	Limit (dBm)	Margin (dB)	Remark
1	1564.000	-36.46	-14.55	-51.01	-40.00	-11.01	peak



Standard:	FCC Part 22H/24E/27/90	Test Distance:	3m
Test item:	Harmonic	Power:	AC 120V/60Hz
Frequency:	782MHz	Temp.(°C)/Hum.(%RH):	26(°C)/60%RH
Mode:	4G_Band 13_10M_QPSK_CH23230	Date:	09/25/2017
Ant.Polar.:	Horizontal		

No.	Frequency (MHz)	Reading (dBm)	Correct Factor (dB)	Result (dBm)	Limit (dBm)	Margin (dB)	Remark
1	1564.000	-37.24	-14.55	-51.79	-40.00	-11.79	peak

Standard:	FCC Part 22H/24E/27/90	Test Distance:	3m
Test item:	Harmonic	Power:	AC 120V/60Hz
Frequency:	782MHz	Temp.(°C)/Hum.(%RH):	26(°C)/60%RH
Mode:	4G_Band 13_10M_QPSK_CH23230	Date:	09/25/2017
Ant.Polar.:	Vertical		

No.	Frequency (MHz)	Reading (dBm)	Correct Factor (dB)	Result (dBm)	Limit (dBm)	Margin (dB)	Remark
1	1564.000	-37.24	-14.55	-51.79	-40.00	-11.79	peak



Standard:	FCC Part 22H/24E/27/90	Test Distance:	3m
Test item:	Harmonic	Power:	AC 120V/60Hz
Frequency:	782MHz	Temp.(°C)/Hum.(%RH):	26(°C)/60%RH
Mode:	4G_Band 13_10M-16QAM_CH23230	Date:	09/25/2017
Ant.Polar.:	Horizontal		

No.	Frequency (MHz)	Reading (dBm)	Correct Factor (dB)	Result (dBm)	Limit (dBm)	Margin (dB)	Remark
1	1564.000	-40.91	-14.55	-55.46	-40.00	-15.46	peak

Standard:	FCC Part 22H/24E/27/90	Test Distance:	3m
Test item:	Harmonic	Power:	AC 120V/60Hz
Frequency:	782MHz	Temp.(°C)/Hum.(%RH):	26(°C)/60%RH
Mode:	4G_Band 13_10M-16QAM_CH23230	Date:	09/25/2017
Ant.Polar.:	Vertical		

No.	Frequency (MHz)	Reading (dBm)	Correct Factor (dB)	Result (dBm)	Limit (dBm)	Margin (dB)	Remark
1	1564.000	-37.48	-14.55	-52.03	-40.00	-12.03	peak



Standard:	FCC Part 22H/24E/27/90	Test Distance:	3m
Test item:	Harmonic	Power:	AC 120V/60Hz
Frequency:	706.5MHz	Temp.(°C)/Hum.(%RH):	26(°C)/60%RH
Mode:	4G_Band 17_5M_QPSK_CH23755	Date:	09/25/2017
Ant.Polar.:	Horizontal		

No.	Frequency (MHz)	Reading (dBm)	Correct Factor (dB)	Result (dBm)	Limit (dBm)	Margin (dB)	Remark
1	1413.000	-37.12	-15.14	-52.26	-13.00	-39.26	peak

Standard:	FCC Part 22H/24E/27/90	Test Distance:	3m
Test item:	Harmonic	Power:	AC 120V/60Hz
Frequency:	706.5MHz	Temp.(°C)/Hum.(%RH):	26(°C)/60%RH
Mode:	4G_Band 17_5M_QPSK_CH23755	Date:	09/25/2017
Ant.Polar.:	Vertical		

No.	Frequency (MHz)	Reading (dBm)	Correct Factor (dB)	Result (dBm)	Limit (dBm)	Margin (dB)	Remark
1	1413.000	-37.12	-15.14	-52.26	-13.00	-39.26	peak



Standard:	FCC Part 22H/24E/27/90	Test Distance:	3m
Test item:	Harmonic	Power:	AC 120V/60Hz
Frequency:	710MHz	Temp.(°C)/Hum.(%RH):	26(°C)/60%RH
Mode:	4G_Band 17_5M_QPSK_CH23790	Date:	09/25/2017
Ant.Polar.:	Horizontal		

No.	Frequency (MHz)	Reading (dBm)	Correct Factor (dB)	Result (dBm)	Limit (dBm)	Margin (dB)	Remark
1	1420.000	-42.16	-15.15	-57.31	-13.00	-44.31	peak

Standard:	FCC Part 22H/24E/27/90	Test Distance:	3m
Test item:	Harmonic	Power:	AC 120V/60Hz
Frequency:	710MHz	Temp.(°C)/Hum.(%RH):	26(°C)/60%RH
Mode:	4G_Band 17_5M_QPSK_CH23790	Date:	09/25/2017
Ant.Polar.:	Vertical		

No.	Frequency (MHz)	Reading (dBm)	Correct Factor (dB)	Result (dBm)	Limit (dBm)	Margin (dB)	Remark
1	1420.000	-40.54	-15.15	-55.69	-13.00	-42.69	peak



Standard:	FCC Part 22H/24E/27/90	Test Distance:	3m
Test item:	Harmonic	Power:	AC 120V/60Hz
Frequency:	713.5MHz	Temp.(°C)/Hum.(%RH):	26(°C)/60%RH
Mode:	4G_Band 17_5M_QPSK_CH23825	Date:	09/25/2017
Ant.Polar.:	Horizontal		

No.	Frequency (MHz)	Reading (dBm)	Correct Factor (dB)	Result (dBm)	Limit (dBm)	Margin (dB)	Remark
1	1427.000	-38.90	-15.18	-54.08	-13.00	-41.08	peak

Standard:	FCC Part 22H/24E/27/90	Test Distance:	3m
Test item:	Harmonic	Power:	AC 120V/60Hz
Frequency:	713.5MHz	Temp.(°C)/Hum.(%RH):	26(°C)/60%RH
Mode:	4G_Band 17_5M_QPSK_CH23825	Date:	09/25/2017
Ant.Polar.:	Vertical		

No.	Frequency (MHz)	Reading (dBm)	Correct Factor (dB)	Result (dBm)	Limit (dBm)	Margin (dB)	Remark
1	1427.000	-36.26	-15.18	-51.44	-13.00	-38.44	peak



Standard:	FCC Part 22H/24E/27/90	Test Distance:	3m
Test item:	Harmonic	Power:	AC 120V/60Hz
Frequency:	710MHz	Temp.(°C)/Hum.(%RH):	26(°C)/60%RH
Mode:	4G_Band 17_5M-16QAM_CH23790	Date:	09/25/2017
Ant.Polar.:	Horizontal		

No.	Frequency (MHz)	Reading (dBm)	Correct Factor (dB)	Result (dBm)	Limit (dBm)	Margin (dB)	Remark
1	1420.000	-39.94	-15.15	-55.09	-13.00	-42.09	peak

Standard:	FCC Part 22H/24E/27/90	Test Distance:	3m
Test item:	Harmonic	Power:	AC 120V/60Hz
Frequency:	710MHz	Temp.(°C)/Hum.(%RH):	26(°C)/60%RH
Mode:	4G_Band 17_5M-16QAM_CH23790	Date:	09/25/2017
Ant.Polar.:	Vertical		

No.	Frequency (MHz)	Reading (dBm)	Correct Factor (dB)	Result (dBm)	Limit (dBm)	Margin (dB)	Remark
1	1420.000	-37.03	-15.15	-52.18	-13.00	-39.18	peak



Standard:	FCC Part 22H/24E/27/90	Test Distance:	3m
Test item:	Harmonic	Power:	AC 120V/60Hz
Frequency:	709MHz	Temp.(°C)/Hum.(%RH):	26(°C)/60%RH
Mode:	4G_Band 17_10M_QPSK_CH23780	Date:	09/25/2017
Ant.Polar.:	Horizontal		

No.	Frequency (MHz)	Reading (dBm)	Correct Factor (dB)	Result (dBm)	Limit (dBm)	Margin (dB)	Remark
1	1418.000	-35.28	-15.14	-50.42	-13.00	-37.42	peak

Standard:	FCC Part 22H/24E/27/90	Test Distance:	3m
Test item:	Harmonic	Power:	AC 120V/60Hz
Frequency:	709MHz	Temp.(°C)/Hum.(%RH):	26(°C)/60%RH
Mode:	4G_Band 17_10M_QPSK_CH23780	Date:	09/25/2017
Ant.Polar.:	Vertical		

No.	Frequency (MHz)	Reading (dBm)	Correct Factor (dB)	Result (dBm)	Limit (dBm)	Margin (dB)	Remark
1	1418.000	-33.61	-15.14	-48.75	-13.00	-35.75	peak



Standard:	FCC Part 22H/24E/27/90	Test Distance:	3m
Test item:	Harmonic	Power:	AC 120V/60Hz
Frequency:	710MHz	Temp.(°C)/Hum.(%RH):	26(°C)/60%RH
Mode:	4G_Band 17_10M_QPSK_CH23790	Date:	09/25/2017
Ant.Polar.:	Horizontal		

No.	Frequency (MHz)	Reading (dBm)	Correct Factor (dB)	Result (dBm)	Limit (dBm)	Margin (dB)	Remark
1	1420.000	-36.51	-15.15	-51.66	-13.00	-38.66	peak

Standard:	FCC Part 22H/24E/27/90	Test Distance:	3m
Test item:	Harmonic	Power:	AC 120V/60Hz
Frequency:	710MHz	Temp.(°C)/Hum.(%RH):	26(°C)/60%RH
Mode:	4G_Band 17_10M_QPSK_CH23790	Date:	09/25/2017
Ant.Polar.:	Vertical		

No.	Frequency (MHz)	Reading (dBm)	Correct Factor (dB)	Result (dBm)	Limit (dBm)	Margin (dB)	Remark
1	1420.000	-40.33	-15.15	-55.48	-13.00	-42.48	peak



Standard:	FCC Part 22H/24E/27/90	Test Distance:	3m
Test item:	Harmonic	Power:	AC 120V/60Hz
Frequency:	711MHz	Temp.(°C)/Hum.(%RH):	26(°C)/60%RH
Mode:	4G_Band 17_10M_QPSK_CH23800	Date:	09/25/2017
Ant.Polar.:	Horizontal		

No.	Frequency (MHz)	Reading (dBm)	Correct Factor (dB)	Result (dBm)	Limit (dBm)	Margin (dB)	Remark
1	1422.000	-39.22	-15.16	-54.38	-13.00	-41.38	peak

Standard:	FCC Part 22H/24E/27/90	Test Distance:	3m
Test item:	Harmonic	Power:	AC 120V/60Hz
Frequency:	711MHz	Temp.(°C)/Hum.(%RH):	26(°C)/60%RH
Mode:	4G_Band 17_10M_QPSK_CH23800	Date:	09/25/2017
Ant.Polar.:	Vertical		

No.	Frequency (MHz)	Reading (dBm)	Correct Factor (dB)	Result (dBm)	Limit (dBm)	Margin (dB)	Remark
1	1422.000	-36.32	-15.16	-51.48	-13.00	-38.48	peak



Standard:	FCC Part 22H/24E/27/90	Test Distance:	3m
Test item:	Harmonic	Power:	AC 120V/60Hz
Frequency:	710MHz	Temp.(°C)/Hum.(%RH):	26(°C)/60%RH
Mode:	4G_Band 17_10M-16QAM_CH23790	Date:	09/25/2017
Ant.Polar.:	Horizontal		

No.	Frequency (MHz)	Reading (dBm)	Correct Factor (dB)	Result (dBm)	Limit (dBm)	Margin (dB)	Remark
1	1420.000	-35.18	-15.15	-50.33	-13.00	-37.33	peak

Standard:	FCC Part 22H/24E/27/90	Test Distance:	3m
Test item:	Harmonic	Power:	AC 120V/60Hz
Frequency:	710MHz	Temp.(°C)/Hum.(%RH):	26(°C)/60%RH
Mode:	4G_Band 17_10M-16QAM_CH23790	Date:	09/25/2017
Ant.Polar.:	Vertical		

No.	Frequency (MHz)	Reading (dBm)	Correct Factor (dB)	Result (dBm)	Limit (dBm)	Margin (dB)	Remark
1	1420.000	-35.18	-15.15	-50.33	-13.00	-37.33	peak



Standard:	FCC Part 22H/24E/27/90S	Test Distance:	3m
Test item:	Harmonic	Power:	AC 120V/60Hz
Frequency:	1850.7MHz	Temp.(°C)/Hum.(%RH):	26(°C)/60%RH
Mode:	4G_Band 25_1.4M_QPSK_CH26047	Date:	10/13/2017
Ant.Polar.:	Horizontal		

No.	Frequency (MHz)	Reading (dBm)	Correct Factor (dB)	Result (dBm)	Limit (dBm)	Margin (dB)	Remark
1	3701.400	-33.55	-6.12	-39.67	-13.00	-26.67	peak

Standard:	FCC Part 22H/24E/27/90S	Test Distance:	3m
Test item:	Harmonic	Power:	AC 120V/60Hz
Frequency:	1850.7MHz	Temp.(°C)/Hum.(%RH):	26(°C)/60%RH
Mode:	4G_Band 25_1.4M_QPSK_CH26047	Date:	10/13/2017
Ant.Polar.:	Vertical		

No.	Frequency (MHz)	Reading (dBm)	Correct Factor (dB)	Result (dBm)	Limit (dBm)	Margin (dB)	Remark
1	3701.400	-32.53	-6.12	-38.65	-13.00	-25.65	peak



Standard:	FCC Part 22H/24E/27/90S	Test Distance:	3m
Test item:	Harmonic	Power:	AC 120V/60Hz
Frequency:	1882.5MHz	Temp.(°C)/Hum.(%RH):	26(°C)/60%RH
Mode:	4G_Band 25_1.4M_QPSK_CH26365	Date:	10/13/2017
Ant.Polar.:	Horizontal		

No.	Frequency (MHz)	Reading (dBm)	Correct Factor (dB)	Result (dBm)	Limit (dBm)	Margin (dB)	Remark
1	3765.000	-33.76	-6.12	-39.88	-13.00	-26.88	peak

Standard:	FCC Part 22H/24E/27/90S	Test Distance:	3m
Test item:	Harmonic	Power:	AC 120V/60Hz
Frequency:	1882.5MHz	Temp.(°C)/Hum.(%RH):	26(°C)/60%RH
Mode:	4G_Band 25_1.4M_QPSK_CH26365	Date:	10/13/2017
Ant.Polar.:	Vertical		

No.	Frequency (MHz)	Reading (dBm)	Correct Factor (dB)	Result (dBm)	Limit (dBm)	Margin (dB)	Remark
1	3765.000	-32.67	-5.87	-38.54	-13.00	-25.54	peak



Standard:	FCC Part 22H/24E/27/90S	Test Distance:	3m
Test item:	Harmonic	Power:	AC 120V/60Hz
Frequency:	1914.3MHz	Temp.(°C)/Hum.(%RH):	26(°C)/60%RH
Mode:	4G_Band 25_1.4M_QPSK_CH26683	Date:	10/13/2017
Ant.Polar.:	Horizontal		

No.	Frequency (MHz)	Reading (dBm)	Correct Factor (dB)	Result (dBm)	Limit (dBm)	Margin (dB)	Remark
1	3828.600	-35.71	-5.81	-41.52	-13.00	-28.52	peak

Standard:	FCC Part 22H/24E/27/90S	Test Distance:	3m
Test item:	Harmonic	Power:	AC 120V/60Hz
Frequency:	1914.3MHz	Temp.(°C)/Hum.(%RH):	26(°C)/60%RH
Mode:	4G_Band 25_1.4M_QPSK_CH26683	Date:	10/13/2017
Ant.Polar.:	Vertical		

No.	Frequency (MHz)	Reading (dBm)	Correct Factor (dB)	Result (dBm)	Limit (dBm)	Margin (dB)	Remark
1	3828.600	-34.44	-5.81	-40.25	-13.00	-27.25	peak



Standard:	FCC Part 22H/24E/27/90S	Test Distance:	3m
Test item:	Harmonic	Power:	AC 120V/60Hz
Frequency:	1882.5MHz	Temp.(°C)/Hum.(%RH):	26(°C)/60%RH
Mode:	4G_Band 25_1.4M-16QAM_CH26365	Date:	10/13/2017
Ant.Polar.:	Horizontal		

No.	Frequency (MHz)	Reading (dBm)	Correct Factor (dB)	Result (dBm)	Limit (dBm)	Margin (dB)	Remark
1	3765.000	-33.53	-6.12	-39.65	-13.00	-26.65	peak

Standard:	FCC Part 22H/24E/27/90S	Test Distance:	3m
Test item:	Harmonic	Power:	AC 120V/60Hz
Frequency:	1882.5MHz	Temp.(°C)/Hum.(%RH):	26(°C)/60%RH
Mode:	4G_Band 25_1.4M-16QAM_CH26365	Date:	10/13/2017
Ant.Polar.:	Vertical		

No.	Frequency (MHz)	Reading (dBm)	Correct Factor (dB)	Result (dBm)	Limit (dBm)	Margin (dB)	Remark
1	3765.000	-29.81	-5.87	-35.68	-13.00	-22.68	peak



Standard:	FCC Part 22H/24E/27/90S	Test Distance:	3m
Test item:	Harmonic	Power:	AC 120V/60Hz
Frequency:	1851.5MHz	Temp.(°C)/Hum.(%RH):	26(°C)/60%RH
Mode:	4G_Band 25_3M_QPSK_CH26055	Date:	10/13/2017
Ant.Polar.:	Horizontal		

No.	Frequency (MHz)	Reading (dBm)	Correct Factor (dB)	Result (dBm)	Limit (dBm)	Margin (dB)	Remark
1	3703.000	-24.73	-6.12	-30.85	-13.00	-17.85	peak

Standard:	FCC Part 22H/24E/27/90S	Test Distance:	3m
Test item:	Harmonic	Power:	AC 120V/60Hz
Frequency:	1851.5MHz	Temp.(°C)/Hum.(%RH):	26(°C)/60%RH
Mode:	4G_Band 25_3M_QPSK_CH26055	Date:	10/13/2017
Ant.Polar.:	Vertical		

No.	Frequency (MHz)	Reading (dBm)	Correct Factor (dB)	Result (dBm)	Limit (dBm)	Margin (dB)	Remark
1	3703.000	-26.73	-6.12	-32.85	-13.00	-19.85	peak



Standard:	FCC Part 22H/24E/27/90S	Test Distance:	3m
Test item:	Harmonic	Power:	AC 120V/60Hz
Frequency:	1882.5MHz	Temp.(°C)/Hum.(%RH):	26(°C)/60%RH
Mode:	4G_Band 25_3M_QPSK_CH26365	Date:	10/13/2017
Ant.Polar.:	Horizontal		

No.	Frequency (MHz)	Reading (dBm)	Correct Factor (dB)	Result (dBm)	Limit (dBm)	Margin (dB)	Remark
1	3765.000	-25.29	-5.87	-31.16	-13.00	-18.16	peak

Standard:	FCC Part 22H/24E/27/90S	Test Distance:	3m
Test item:	Harmonic	Power:	AC 120V/60Hz
Frequency:	1882.5MHz	Temp.(°C)/Hum.(%RH):	26(°C)/60%RH
Mode:	4G_Band 25_3M_QPSK_CH26365	Date:	10/13/2017
Ant.Polar.:	Vertical		

No.	Frequency (MHz)	Reading (dBm)	Correct Factor (dB)	Result (dBm)	Limit (dBm)	Margin (dB)	Remark
1	3765.000	-27.78	-5.87	-33.65	-13.00	-20.65	peak



Standard:	FCC Part 22H/24E/27/90S	Test Distance:	3m
Test item:	Harmonic	Power:	AC 120V/60Hz
Frequency:	1913.5MHz	Temp.(°C)/Hum.(%RH):	26(°C)/60%RH
Mode:	4G_Band 25_3M_QPSK_CH26675	Date:	10/13/2017
Ant.Polar.:	Horizontal		

No.	Frequency (MHz)	Reading (dBm)	Correct Factor (dB)	Result (dBm)	Limit (dBm)	Margin (dB)	Remark
1	3827.000	-25.04	-5.81	-30.85	-13.00	-17.85	peak

Standard:	FCC Part 22H/24E/27/90S	Test Distance:	3m
Test item:	Harmonic	Power:	AC 120V/60Hz
Frequency:	1913.5MHz	Temp.(°C)/Hum.(%RH):	26(°C)/60%RH
Mode:	4G_Band 25_3M_QPSK_CH26675	Date:	10/13/2017
Ant.Polar.:	Vertical		

No.	Frequency (MHz)	Reading (dBm)	Correct Factor (dB)	Result (dBm)	Limit (dBm)	Margin (dB)	Remark
1	3827.000	-25.66	-5.81	-31.47	-13.00	-18.47	peak



Standard:	FCC Part 22H/24E/27/90S	Test Distance:	3m
Test item:	Harmonic	Power:	AC 120V/60Hz
Frequency:	1882.5MHz	Temp.(°C)/Hum.(%RH):	26(°C)/60%RH
Mode:	4G_Band 25_3M-16QAM_CH26365	Date:	10/13/2017
Ant.Polar.:	Horizontal		

No.	Frequency (MHz)	Reading (dBm)	Correct Factor (dB)	Result (dBm)	Limit (dBm)	Margin (dB)	Remark
1	3765.000	-29.71	-5.87	-35.58	-13.00	-22.58	peak

Standard:	FCC Part 22H/24E/27/90S	Test Distance:	3m
Test item:	Harmonic	Power:	AC 120V/60Hz
Frequency:	1882.5MHz	Temp.(°C)/Hum.(%RH):	26(°C)/60%RH
Mode:	4G_Band 25_3M-16QAM_CH26365	Date:	10/13/2017
Ant.Polar.:	Vertical		

No.	Frequency (MHz)	Reading (dBm)	Correct Factor (dB)	Result (dBm)	Limit (dBm)	Margin (dB)	Remark
1	3765.000	-30.98	-5.87	-36.85	-13.00	-23.85	peak



Standard:	FCC Part 22H/24E/27/90	Test Distance:	3m
Test item:	Harmonic	Power:	AC 120V/60Hz
Frequency:	1852.5MHz	Temp.(°C)/Hum.(%RH):	26(°C)/60%RH
Mode:	4G_Band 25_5M_QPSK_CH26065	Date:	09/26/2017
Ant.Polar.:	Horizontal		

No.	Frequency (MHz)	Reading (dBm)	Correct Factor (dB)	Result (dBm)	Limit (dBm)	Margin (dB)	Remark
1	3705.000	-45.69	-6.09	-51.78	-13.00	-38.78	peak

Standard:	FCC Part 22H/24E/27/90	Test Distance:	3m
Test item:	Harmonic	Power:	AC 120V/60Hz
Frequency:	1852.5MHz	Temp.(°C)/Hum.(%RH):	26(°C)/60%RH
Mode:	4G_Band 25_5M_QPSK_CH26065	Date:	09/26/2017
Ant.Polar.:	Vertical		

No.	Frequency (MHz)	Reading (dBm)	Correct Factor (dB)	Result (dBm)	Limit (dBm)	Margin (dB)	Remark
1	3705.000	-42.62	-6.09	-48.71	-13.00	-35.71	peak



Standard:	FCC Part 22H/24E/27/90	Test Distance:	3m
Test item:	Harmonic	Power:	AC 120V/60Hz
Frequency:	1882.5MHz	Temp.(°C)/Hum.(%RH):	26(°C)/60%RH
Mode:	4G_Band 25_5M_QPSK_CH26365	Date:	09/26/2017
Ant.Polar.:	Horizontal		

No.	Frequency (MHz)	Reading (dBm)	Correct Factor (dB)	Result (dBm)	Limit (dBm)	Margin (dB)	Remark
1	3765.000	-44.04	-5.87	-49.91	-13.00	-36.91	peak

Standard:	FCC Part 22H/24E/27/90	Test Distance:	3m
Test item:	Harmonic	Power:	AC 120V/60Hz
Frequency:	1882.5MHz	Temp.(°C)/Hum.(%RH):	26(°C)/60%RH
Mode:	4G_Band 25_5M_QPSK_CH26365	Date:	09/26/2017
Ant.Polar.:	Vertical		

No.	Frequency (MHz)	Reading (dBm)	Correct Factor (dB)	Result (dBm)	Limit (dBm)	Margin (dB)	Remark
1	3765.000	-41.28	-5.87	-47.15	-13.00	-34.15	peak



Standard:	FCC Part 22H/24E/27/90	Test Distance:	3m
Test item:	Harmonic	Power:	AC 120V/60Hz
Frequency:	1912.5MHz	Temp.(°C)/Hum.(%RH):	26(°C)/60%RH
Mode:	4G_Band 25_5M_QPSK_CH26665	Date:	09/26/2017
Ant.Polar.:	Horizontal		

No.	Frequency (MHz)	Reading (dBm)	Correct Factor (dB)	Result (dBm)	Limit (dBm)	Margin (dB)	Remark
1	3825.000	-45.65	-5.81	-51.46	-13.00	-38.46	peak

Standard:	FCC Part 22H/24E/27/90	Test Distance:	3m
Test item:	Harmonic	Power:	AC 120V/60Hz
Frequency:	1912.5MHz	Temp.(°C)/Hum.(%RH):	26(°C)/60%RH
Mode:	4G_Band 25_5M_QPSK_CH26665	Date:	09/26/2017
Ant.Polar.:	Vertical		

No.	Frequency (MHz)	Reading (dBm)	Correct Factor (dB)	Result (dBm)	Limit (dBm)	Margin (dB)	Remark
1	3825.000	-45.65	-5.81	-51.46	-13.00	-38.46	peak



Standard:	FCC Part 22H/24E/27/90	Test Distance:	3m
Test item:	Harmonic	Power:	AC 120V/60Hz
Frequency:	1882.5MHz	Temp.(°C)/Hum.(%RH):	26(°C)/60%RH
Mode:	4G_Band 25_5M-16QAM_CH26365	Date:	09/26/2017
Ant.Polar.:	Horizontal		

No.	Frequency (MHz)	Reading (dBm)	Correct Factor (dB)	Result (dBm)	Limit (dBm)	Margin (dB)	Remark
1	3765.000	-47.73	-5.87	-53.60	-13.00	-40.60	peak

Standard:	FCC Part 22H/24E/27/90	Test Distance:	3m
Test item:	Harmonic	Power:	AC 120V/60Hz
Frequency:	1882.5MHz	Temp.(°C)/Hum.(%RH):	26(°C)/60%RH
Mode:	4G_Band 25_5M-16QAM_CH26365	Date:	09/26/2017
Ant.Polar.:	Vertical		

No.	Frequency (MHz)	Reading (dBm)	Correct Factor (dB)	Result (dBm)	Limit (dBm)	Margin (dB)	Remark
1	3765.000	-43.21	-5.87	-49.08	-13.00	-36.08	peak



Standard:	FCC Part 22H/24E/27/90	Test Distance:	3m
Test item:	Harmonic	Power:	AC 120V/60Hz
Frequency:	1855MHz	Temp.(°C)/Hum.(%RH):	26(°C)/60%RH
Mode:	4G_Band 25_10M_QPSK_CH26090	Date:	09/26/2017
Ant.Polar.:	Horizontal		

No.	Frequency (MHz)	Reading (dBm)	Correct Factor (dB)	Result (dBm)	Limit (dBm)	Margin (dB)	Remark
1	3710.000	-45.37	-6.07	-51.44	-13.00	-38.44	peak

Standard:	FCC Part 22H/24E/27/90	Test Distance:	3m
Test item:	Harmonic	Power:	AC 120V/60Hz
Frequency:	1855MHz	Temp.(°C)/Hum.(%RH):	26(°C)/60%RH
Mode:	4G_Band 25_10M_QPSK_CH26090	Date:	09/26/2017
Ant.Polar.:	Vertical		

No.	Frequency (MHz)	Reading (dBm)	Correct Factor (dB)	Result (dBm)	Limit (dBm)	Margin (dB)	Remark
1	3710.000	-42.49	-6.07	-48.56	-13.00	-35.56	peak



Standard:	FCC Part 22H/24E/27/90	Test Distance:	3m
Test item:	Harmonic	Power:	AC 120V/60Hz
Frequency:	1882.5MHz	Temp.(°C)/Hum.(%RH):	26(°C)/60%RH
Mode:	4G_Band 25_10M_QPSK_CH26365	Date:	09/26/2017
Ant.Polar.:	Horizontal		

No.	Frequency (MHz)	Reading (dBm)	Correct Factor (dB)	Result (dBm)	Limit (dBm)	Margin (dB)	Remark
1	3765.000	-47.04	-5.87	-52.91	-13.00	-39.91	peak

Standard:	FCC Part 22H/24E/27/90	Test Distance:	3m
Test item:	Harmonic	Power:	AC 120V/60Hz
Frequency:	1882.5MHz	Temp.(°C)/Hum.(%RH):	26(°C)/60%RH
Mode:	4G_Band 25_10M_QPSK_CH26365	Date:	09/26/2017
Ant.Polar.:	Vertical		

No.	Frequency (MHz)	Reading (dBm)	Correct Factor (dB)	Result (dBm)	Limit (dBm)	Margin (dB)	Remark
1	3765.000	-43.20	-5.87	-49.07	-13.00	-36.07	peak



Standard:	FCC Part 22H/24E/27/90	Test Distance:	3m
Test item:	Harmonic	Power:	AC 120V/60Hz
Frequency:	1910MHz	Temp.(°C)/Hum.(%RH):	26(°C)/60%RH
Mode:	4G_Band 25_10M_QPSK_CH26640	Date:	09/26/2017
Ant.Polar.:	Horizontal		

No.	Frequency (MHz)	Reading (dBm)	Correct Factor (dB)	Result (dBm)	Limit (dBm)	Margin (dB)	Remark
1	3820.000	-43.24	-5.81	-49.05	-13.00	-36.05	peak

Standard:	FCC Part 22H/24E/27/90	Test Distance:	3m
Test item:	Harmonic	Power:	AC 120V/60Hz
Frequency:	1910MHz	Temp.(°C)/Hum.(%RH):	26(°C)/60%RH
Mode:	4G_Band 25_10M_QPSK_CH26640	Date:	09/26/2017
Ant.Polar.:	Vertical		

No.	Frequency (MHz)	Reading (dBm)	Correct Factor (dB)	Result (dBm)	Limit (dBm)	Margin (dB)	Remark
1	3820.000	-40.50	-5.81	-46.31	-13.00	-33.31	peak



Standard:	FCC Part 22H/24E/27/90	Test Distance:	3m
Test item:	Harmonic	Power:	AC 120V/60Hz
Frequency:	1882.5MHz	Temp.(°C)/Hum.(%RH):	26(°C)/60%RH
Mode:	4G_Band 25_10M-16QAM_CH26365	Date:	09/26/2017
Ant.Polar.:	Horizontal		

No.	Frequency (MHz)	Reading (dBm)	Correct Factor (dB)	Result (dBm)	Limit (dBm)	Margin (dB)	Remark
1	3765.000	-49.42	-5.87	-55.29	-13.00	-42.29	peak

Standard:	FCC Part 22H/24E/27/90	Test Distance:	3m
Test item:	Harmonic	Power:	AC 120V/60Hz
Frequency:	1882.5MHz	Temp.(°C)/Hum.(%RH):	26(°C)/60%RH
Mode:	4G_Band 25_10M-16QAM_CH26365	Date:	09/26/2017
Ant.Polar.:	Vertical		

No.	Frequency (MHz)	Reading (dBm)	Correct Factor (dB)	Result (dBm)	Limit (dBm)	Margin (dB)	Remark
1	3765.000	-46.05	-5.87	-51.92	-13.00	-38.92	peak



Standard:	FCC Part 22H/24E/27/90S	Test Distance:	3m
Test item:	Harmonic	Power:	AC 120V/60Hz
Frequency:	1857.5MHz	Temp.(°C)/Hum.(%RH):	26(°C)/60%RH
Mode:	4G_Band 25_15M_QPSK_CH26115	Date:	10/13/2017
Ant.Polar.:	Horizontal		

No.	Frequency (MHz)	Reading (dBm)	Correct Factor (dB)	Result (dBm)	Limit (dBm)	Margin (dB)	Remark
1	3715.000	-33.00	-6.06	-39.06	-13.00	-26.06	peak

Standard:	FCC Part 22H/24E/27/90S	Test Distance:	3m
Test item:	Harmonic	Power:	AC 120V/60Hz
Frequency:	1857.5MHz	Temp.(°C)/Hum.(%RH):	26(°C)/60%RH
Mode:	4G_Band 25_15M_QPSK_CH26115	Date:	10/13/2017
Ant.Polar.:	Vertical		

No.	Frequency (MHz)	Reading (dBm)	Correct Factor (dB)	Result (dBm)	Limit (dBm)	Margin (dB)	Remark
1	3715.000	-32.59	-6.06	-38.65	-13.00	-25.65	peak



Standard:	FCC Part 22H/24E/27/90S	Test Distance:	3m
Test item:	Harmonic	Power:	AC 120V/60Hz
Frequency:	1882.5MHz	Temp.(°C)/Hum.(%RH):	26(°C)/60%RH
Mode:	4G_Band 25_15M_QPSK_CH26365	Date:	10/13/2017
Ant.Polar.:	Horizontal		

No.	Frequency (MHz)	Reading (dBm)	Correct Factor (dB)	Result (dBm)	Limit (dBm)	Margin (dB)	Remark
1	3765.000	-33.07	-5.87	-38.94	-13.00	-25.94	peak

Standard:	FCC Part 22H/24E/27/90S	Test Distance:	3m
Test item:	Harmonic	Power:	AC 120V/60Hz
Frequency:	1882.5MHz	Temp.(°C)/Hum.(%RH):	26(°C)/60%RH
Mode:	4G_Band 25_15M_QPSK_CH26365	Date:	10/13/2017
Ant.Polar.:	Vertical		

No.	Frequency (MHz)	Reading (dBm)	Correct Factor (dB)	Result (dBm)	Limit (dBm)	Margin (dB)	Remark
1	3765.000	-33.17	-5.87	-39.04	-13.00	-26.04	peak



Standard:	FCC Part 22H/24E/27/90S	Test Distance:	3m
Test item:	Harmonic	Power:	AC 120V/60Hz
Frequency:	1907.5MHz	Temp.(°C)/Hum.(%RH):	26(°C)/60%RH
Mode:	4G_Band 25_15M_QPSK_CH26615	Date:	10/13/2017
Ant.Polar.:	Horizontal		

No.	Frequency (MHz)	Reading (dBm)	Correct Factor (dB)	Result (dBm)	Limit (dBm)	Margin (dB)	Remark
1	3815.000	-31.83	-5.82	-37.65	-13.00	-24.65	peak

Standard:	FCC Part 22H/24E/27/90S	Test Distance:	3m
Test item:	Harmonic	Power:	AC 120V/60Hz
Frequency:	1907.5MHz	Temp.(°C)/Hum.(%RH):	26(°C)/60%RH
Mode:	4G_Band 25_15M_QPSK_CH26615	Date:	10/13/2017
Ant.Polar.:	Vertical		

No.	Frequency (MHz)	Reading (dBm)	Correct Factor (dB)	Result (dBm)	Limit (dBm)	Margin (dB)	Remark
1	3815.000	-29.86	-5.82	-35.68	-13.00	-22.68	peak



Standard:	FCC Part 22H/24E/27/90S	Test Distance:	3m
Test item:	Harmonic	Power:	AC 120V/60Hz
Frequency:	1882.5MHz	Temp.(°C)/Hum.(%RH):	26(°C)/60%RH
Mode:	4G_Band 25_15M-16QAM_CH26365	Date:	10/13/2017
Ant.Polar.:	Horizontal		

No.	Frequency (MHz)	Reading (dBm)	Correct Factor (dB)	Result (dBm)	Limit (dBm)	Margin (dB)	Remark
1	3765.000	-33.89	-5.87	-39.76	-13.00	-26.76	peak

Standard:	FCC Part 22H/24E/27/90S	Test Distance:	3m
Test item:	Harmonic	Power:	AC 120V/60Hz
Frequency:	1882.5MHz	Temp.(°C)/Hum.(%RH):	26(°C)/60%RH
Mode:	4G_Band 25_15M-16QAM_CH26365	Date:	10/13/2017
Ant.Polar.:	Vertical		

No.	Frequency (MHz)	Reading (dBm)	Correct Factor (dB)	Result (dBm)	Limit (dBm)	Margin (dB)	Remark
1	3765.000	-34.08	-5.87	-39.95	-13.00	-26.95	peak



Standard:	FCC Part 22H/24E/27/90S	Test Distance:	3m
Test item:	Harmonic	Power:	AC 120V/60Hz
Frequency:	1860MHz	Temp.(°C)/Hum.(%RH):	26(°C)/60%RH
Mode:	4G_Band 25_20M_QPSK_CH26140	Date:	10/13/2017
Ant.Polar.:	Horizontal		

No.	Frequency (MHz)	Reading (dBm)	Correct Factor (dB)	Result (dBm)	Limit (dBm)	Margin (dB)	Remark
1	3720.000	-32.65	-6.03	-38.68	-13.00	-25.68	peak

Standard:	FCC Part 22H/24E/27/90S	Test Distance:	3m
Test item:	Harmonic	Power:	AC 120V/60Hz
Frequency:	1860MHz	Temp.(°C)/Hum.(%RH):	26(°C)/60%RH
Mode:	4G_Band 25_20M_QPSK_CH26140	Date:	10/13/2017
Ant.Polar.:	Vertical		

No.	Frequency (MHz)	Reading (dBm)	Correct Factor (dB)	Result (dBm)	Limit (dBm)	Margin (dB)	Remark
1	3720.000	-31.78	-6.03	-37.81	-13.00	-24.81	peak



Standard:	FCC Part 22H/24E/27/90S	Test Distance:	3m
Test item:	Harmonic	Power:	AC 120V/60Hz
Frequency:	1882.5MHz	Temp.(°C)/Hum.(%RH):	26(°C)/60%RH
Mode:	4G_Band 25_20M_QPSK_CH26365	Date:	10/13/2017
Ant.Polar.:	Horizontal		

No.	Frequency (MHz)	Reading (dBm)	Correct Factor (dB)	Result (dBm)	Limit (dBm)	Margin (dB)	Remark
1	3765.000	-31.81	-5.87	-37.68	-13.00	-24.68	peak

Standard:	FCC Part 22H/24E/27/90S	Test Distance:	3m
Test item:	Harmonic	Power:	AC 120V/60Hz
Frequency:	1882.5MHz	Temp.(°C)/Hum.(%RH):	26(°C)/60%RH
Mode:	4G_Band 25_20M_QPSK_CH26365	Date:	10/13/2017
Ant.Polar.:	Vertical		

No.	Frequency (MHz)	Reading (dBm)	Correct Factor (dB)	Result (dBm)	Limit (dBm)	Margin (dB)	Remark
1	3765.000	-31.18	-5.87	-37.05	-13.00	-24.05	peak



Standard:	FCC Part 22H/24E/27/90S	Test Distance:	3m
Test item:	Harmonic	Power:	AC 120V/60Hz
Frequency:	1905MHz	Temp.(°C)/Hum.(%RH):	26(°C)/60%RH
Mode:	4G_Band 25_20M_QPSK_CH26590	Date:	10/13/2017
Ant.Polar.:	Horizontal		

No.	Frequency (MHz)	Reading (dBm)	Correct Factor (dB)	Result (dBm)	Limit (dBm)	Margin (dB)	Remark
1	3810.000	-30.35	-5.81	-36.16	-13.00	-23.16	peak

Standard:	FCC Part 22H/24E/27/90S	Test Distance:	3m
Test item:	Harmonic	Power:	AC 120V/60Hz
Frequency:	1905MHz	Temp.(°C)/Hum.(%RH):	26(°C)/60%RH
Mode:	4G_Band 25_20M_QPSK_CH26590	Date:	10/13/2017
Ant.Polar.:	Vertical		

No.	Frequency (MHz)	Reading (dBm)	Correct Factor (dB)	Result (dBm)	Limit (dBm)	Margin (dB)	Remark
1	3810.000	-31.26	-5.81	-37.07	-13.00	-24.07	peak



Standard:	FCC Part 22H/24E/27/90S	Test Distance:	3m
Test item:	Harmonic	Power:	AC 120V/60Hz
Frequency:	1882.5MHz	Temp.(°C)/Hum.(%RH):	26(°C)/60%RH
Mode:	4G_Band 25_20M-16QAM_CH26365	Date:	10/13/2017
Ant.Polar.:	Horizontal		

No.	Frequency (MHz)	Reading (dBm)	Correct Factor (dB)	Result (dBm)	Limit (dBm)	Margin (dB)	Remark
1	3765.000	-29.97	-5.87	-35.84	-13.00	-22.84	peak

Standard:	FCC Part 22H/24E/27/90S	Test Distance:	3m
Test item:	Harmonic	Power:	AC 120V/60Hz
Frequency:	1882.5MHz	Temp.(°C)/Hum.(%RH):	26(°C)/60%RH
Mode:	4G_Band 25_20M-16QAM_CH26365	Date:	10/13/2017
Ant.Polar.:	Vertical		

No.	Frequency (MHz)	Reading (dBm)	Correct Factor (dB)	Result (dBm)	Limit (dBm)	Margin (dB)	Remark
1	3765.000	-31.04	-5.87	-36.91	-13.00	-23.91	peak



Standard:	FCC Part 22H/24E/27/90S	Test Distance:	3m
Test item:	Harmonic	Power:	AC 120V/60Hz
Frequency:	824.7MHz	Temp.(°C)/Hum.(%RH):	26(°C)/60%RH
Mode:	4G_Band 26_1.4M_QPSK_CH26797	Date:	10/13/2017
Ant.Polar.:	Horizontal		

No.	Frequency (MHz)	Reading (dBm)	Correct Factor (dB)	Result (dBm)	Limit (dBm)	Margin (dB)	Remark
1	1648.400	-28.89	-13.43	-42.32	-13.00	-29.32	peak

Standard:	FCC Part 22H/24E/27/90S	Test Distance:	3m
Test item:	Harmonic	Power:	AC 120V/60Hz
Frequency:	824.7MHz	Temp.(°C)/Hum.(%RH):	26(°C)/60%RH
Mode:	4G_Band 26_1.4M_QPSK_CH26797	Date:	10/13/2017
Ant.Polar.:	Vertical		

No.	Frequency (MHz)	Reading (dBm)	Correct Factor (dB)	Result (dBm)	Limit (dBm)	Margin (dB)	Remark
1	1648.400	-35.07	-13.43	-48.50	-13.00	-35.50	peak



Standard:	FCC Part 22H/24E/27/90S	Test Distance:	3m
Test item:	Harmonic	Power:	AC 120V/60Hz
Frequency:	836.5MHz	Temp.(°C)/Hum.(%RH):	26(°C)/60%RH
Mode:	4G_Band 26_1.4M_QPSK_CH26915	Date:	10/13/2017
Ant.Polar.:	Horizontal		

No.	Frequency (MHz)	Reading (dBm)	Correct Factor (dB)	Result (dBm)	Limit (dBm)	Margin (dB)	Remark
1	1673.000	-24.86	-13.10	-37.96	-13.00	-24.96	peak

Standard:	FCC Part 22H/24E/27/90S	Test Distance:	3m
Test item:	Harmonic	Power:	AC 120V/60Hz
Frequency:	836.5MHz	Temp.(°C)/Hum.(%RH):	26(°C)/60%RH
Mode:	4G_Band 26_1.4M_QPSK_CH26915	Date:	10/13/2017
Ant.Polar.:	Vertical		

No.	Frequency (MHz)	Reading (dBm)	Correct Factor (dB)	Result (dBm)	Limit (dBm)	Margin (dB)	Remark
1	1673.000	-23.49	-13.10	-36.59	-13.00	-23.59	peak



Standard:	FCC Part 22H/24E/27/90S	Test Distance:	3m
Test item:	Harmonic	Power:	AC 120V/60Hz
Frequency:	845.3MHz	Temp.(°C)/Hum.(%RH):	26(°C)/60%RH
Mode:	4G_Band 26_1.4M_QPSK_CH27003	Date:	10/13/2017
Ant.Polar.:	Horizontal		

No.	Frequency (MHz)	Reading (dBm)	Correct Factor (dB)	Result (dBm)	Limit (dBm)	Margin (dB)	Remark
1	1696.600	-25.29	-12.77	-38.06	-13.00	-25.06	peak

Standard:	FCC Part 22H/24E/27/90S	Test Distance:	3m
Test item:	Harmonic	Power:	AC 120V/60Hz
Frequency:	845.3MHz	Temp.(°C)/Hum.(%RH):	26(°C)/60%RH
Mode:	4G_Band 26_1.4M_QPSK_CH27003	Date:	10/13/2017
Ant.Polar.:	Vertical		

No.	Frequency (MHz)	Reading (dBm)	Correct Factor (dB)	Result (dBm)	Limit (dBm)	Margin (dB)	Remark
1	1696.600	-24.28	-12.77	-37.05	-13.00	-24.05	peak



Standard:	FCC Part 22H/24E/27/90S	Test Distance:	3m
Test item:	Harmonic	Power:	AC 120V/60Hz
Frequency:	836.5MHz	Temp.(°C)/Hum.(%RH):	26(°C)/60%RH
Mode:	4G_Band 26_1.4M-16QAM_CH26915	Date:	10/13/2017
Ant.Polar.:	Horizontal		

No.	Frequency (MHz)	Reading (dBm)	Correct Factor (dB)	Result (dBm)	Limit (dBm)	Margin (dB)	Remark
1	1673.000	-25.03	-13.10	-38.13	-13.00	-25.13	peak

Standard:	FCC Part 22H/24E/27/90S	Test Distance:	3m
Test item:	Harmonic	Power:	AC 120V/60Hz
Frequency:	836.5MHz	Temp.(°C)/Hum.(%RH):	26(°C)/60%RH
Mode:	4G_Band 26_1.4M-16QAM_CH26915	Date:	10/13/2017
Ant.Polar.:	Vertical		

No.	Frequency (MHz)	Reading (dBm)	Correct Factor (dB)	Result (dBm)	Limit (dBm)	Margin (dB)	Remark
1	1673.000	-25.26	-13.10	-38.36	-13.00	-25.36	peak



Standard:	FCC Part 22H/24E/27/90S	Test Distance:	3m
Test item:	Harmonic	Power:	AC 120V/60Hz
Frequency:	825.5MHz	Temp.(°C)/Hum.(%RH):	26(°C)/60%RH
Mode:	4G_Band 26_3M_QPSK_CH26805	Date:	10/13/2017
Ant.Polar.:	Horizontal		

No.	Frequency (MHz)	Reading (dBm)	Correct Factor (dB)	Result (dBm)	Limit (dBm)	Margin (dB)	Remark
1	1651.000	-25.26	-13.39	-38.65	-13.00	-25.65	peak

Standard:	FCC Part 22H/24E/27/90S	Test Distance:	3m
Test item:	Harmonic	Power:	AC 120V/60Hz
Frequency:	825.5MHz	Temp.(°C)/Hum.(%RH):	26(°C)/60%RH
Mode:	4G_Band 26_3M_QPSK_CH26805	Date:	10/13/2017
Ant.Polar.:	Vertical		

No.	Frequency (MHz)	Reading (dBm)	Correct Factor (dB)	Result (dBm)	Limit (dBm)	Margin (dB)	Remark
1	1651.000	-25.69	-13.39	-39.08	-13.00	-26.08	peak



Standard:	FCC Part 22H/24E/27/90S	Test Distance:	3m
Test item:	Harmonic	Power:	AC 120V/60Hz
Frequency:	836.5MHz	Temp.(°C)/Hum.(%RH):	26(°C)/60%RH
Mode:	4G_Band 26_3M_QPSK_CH26915	Date:	10/13/2017
Ant.Polar.:	Horizontal		

No.	Frequency (MHz)	Reading (dBm)	Correct Factor (dB)	Result (dBm)	Limit (dBm)	Margin (dB)	Remark
1	1673.000	-26.57	-13.10	-39.67	-13.00	-26.67	peak

Standard:	FCC Part 22H/24E/27/90S	Test Distance:	3m
Test item:	Harmonic	Power:	AC 120V/60Hz
Frequency:	836.5MHz	Temp.(°C)/Hum.(%RH):	26(°C)/60%RH
Mode:	4G_Band 26_3M_QPSK_CH26915	Date:	10/13/2017
Ant.Polar.:	Vertical		

No.	Frequency (MHz)	Reading (dBm)	Correct Factor (dB)	Result (dBm)	Limit (dBm)	Margin (dB)	Remark
1	1673.000	-25.66	-13.10	-38.76	-13.00	-25.76	peak



Standard:	FCC Part 22H/24E/27/90S	Test Distance:	3m
Test item:	Harmonic	Power:	AC 120V/60Hz
Frequency:	847.5MHz	Temp.(°C)/Hum.(%RH):	26(°C)/60%RH
Mode:	4G_Band 26_3M_QPSK_CH27025	Date:	10/13/2017
Ant.Polar.:	Horizontal		

No.	Frequency (MHz)	Reading (dBm)	Correct Factor (dB)	Result (dBm)	Limit (dBm)	Margin (dB)	Remark
1	1695.000	-23.40	-12.79	-36.19	-13.00	-23.19	peak

Standard:	FCC Part 22H/24E/27/90S	Test Distance:	3m
Test item:	Harmonic	Power:	AC 120V/60Hz
Frequency:	847.5MHz	Temp.(°C)/Hum.(%RH):	26(°C)/60%RH
Mode:	4G_Band 26_3M_QPSK_CH27025	Date:	10/13/2017
Ant.Polar.:	Vertical		

No.	Frequency (MHz)	Reading (dBm)	Correct Factor (dB)	Result (dBm)	Limit (dBm)	Margin (dB)	Remark
1	1695.000	-23.18	-12.79	-35.97	-13.00	-22.97	peak



Standard:	FCC Part 22H/24E/27/90S	Test Distance:	3m
Test item:	Harmonic	Power:	AC 120V/60Hz
Frequency:	836.5MHz	Temp.(°C)/Hum.(%RH):	26(°C)/60%RH
Mode:	4G_Band 26_3M-16QAM_CH26915	Date:	10/13/2017
Ant.Polar.:	Horizontal		

No.	Frequency (MHz)	Reading (dBm)	Correct Factor (dB)	Result (dBm)	Limit (dBm)	Margin (dB)	Remark
1	1673.000	-25.87	-13.10	-38.97	-13.00	-25.97	peak

Standard:	FCC Part 22H/24E/27/90S	Test Distance:	3m
Test item:	Harmonic	Power:	AC 120V/60Hz
Frequency:	836.5MHz	Temp.(°C)/Hum.(%RH):	26(°C)/60%RH
Mode:	4G_Band 26_3M-16QAM_CH26915	Date:	10/13/2017
Ant.Polar.:	Vertical		

No.	Frequency (MHz)	Reading (dBm)	Correct Factor (dB)	Result (dBm)	Limit (dBm)	Margin (dB)	Remark
1	1673.000	-23.38	-13.10	-36.48	-13.00	-23.48	peak



Standard:	FCC Part 22H/24E/27/90S	Test Distance:	3m
Test item:	Harmonic	Power:	AC 120V/60Hz
Frequency:	826.5MHz	Temp.(°C)/Hum.(%RH):	26(°C)/60%RH
Mode:	4G_Band 26_5M_QPSK_CH26815	Date:	10/13/2017
Ant.Polar.:	Horizontal		

No.	Frequency (MHz)	Reading (dBm)	Correct Factor (dB)	Result (dBm)	Limit (dBm)	Margin (dB)	Remark
1	1653.000	-22.61	-13.37	-35.98	-13.00	-22.98	peak

Standard:	FCC Part 22H/24E/27/90S	Test Distance:	3m
Test item:	Harmonic	Power:	AC 120V/60Hz
Frequency:	826.5MHz	Temp.(°C)/Hum.(%RH):	26(°C)/60%RH
Mode:	4G_Band 26_5M_QPSK_CH26815	Date:	10/13/2017
Ant.Polar.:	Vertical		

No.	Frequency (MHz)	Reading (dBm)	Correct Factor (dB)	Result (dBm)	Limit (dBm)	Margin (dB)	Remark
1	1653.000	-23.08	-13.37	-36.45	-13.00	-23.45	peak



Standard:	FCC Part 22H/24E/27/90S	Test Distance:	3m
Test item:	Harmonic	Power:	AC 120V/60Hz
Frequency:	846.5MHz	Temp.(°C)/Hum.(%RH):	26(°C)/60%RH
Mode:	4G_Band 26_5M_QPSK_CH27015	Date:	10/13/2017
Ant.Polar.:	Horizontal		

No.	Frequency (MHz)	Reading (dBm)	Correct Factor (dB)	Result (dBm)	Limit (dBm)	Margin (dB)	Remark
1	1693.000	-24.09	-12.83	-36.92	-13.00	-23.92	peak

Standard:	FCC Part 22H/24E/27/90S	Test Distance:	3m
Test item:	Harmonic	Power:	AC 120V/60Hz
Frequency:	846.5MHz	Temp.(°C)/Hum.(%RH):	26(°C)/60%RH
Mode:	4G_Band 26_5M_QPSK_CH27015	Date:	10/13/2017
Ant.Polar.:	Vertical		

No.	Frequency (MHz)	Reading (dBm)	Correct Factor (dB)	Result (dBm)	Limit (dBm)	Margin (dB)	Remark
1	1693.000	-26.86	-12.83	-39.69	-13.00	-26.69	peak



Standard:	FCC Part 22H/24E/27/90S	Test Distance:	3m
Test item:	Harmonic	Power:	AC 120V/60Hz
Frequency:	836.5MHz	Temp.(°C)/Hum.(%RH):	26(°C)/60%RH
Mode:	4G_Band 26_5M-16QAM_CH26915	Date:	10/13/2017
Ant.Polar.:	Horizontal		

No.	Frequency (MHz)	Reading (dBm)	Correct Factor (dB)	Result (dBm)	Limit (dBm)	Margin (dB)	Remark
1	1673.000	-23.32	-13.37	-36.69	-13.00	-23.69	peak

Standard:	FCC Part 22H/24E/27/90S	Test Distance:	3m
Test item:	Harmonic	Power:	AC 120V/60Hz
Frequency:	836.5MHz	Temp.(°C)/Hum.(%RH):	26(°C)/60%RH
Mode:	4G_Band 26_5M-16QAM_CH26915	Date:	10/13/2017
Ant.Polar.:	Vertical		

No.	Frequency (MHz)	Reading (dBm)	Correct Factor (dB)	Result (dBm)	Limit (dBm)	Margin (dB)	Remark
1	1673.000	-23.65	-13.37	-37.02	-13.00	-24.02	peak



Standard:	FCC Part 22H/24E/27/90S	Test Distance:	3m
Test item:	Harmonic	Power:	AC 120V/60Hz
Frequency:	829MHz	Temp.(°C)/Hum.(%RH):	26(°C)/60%RH
Mode:	4G_Band 26_10M_QPSK_CH26840	Date:	10/13/2017
Ant.Polar.:	Horizontal		

No.	Frequency (MHz)	Reading (dBm)	Correct Factor (dB)	Result (dBm)	Limit (dBm)	Margin (dB)	Remark
1	1659.000	-30.06	-13.28	-43.34	-13.00	-30.34	peak

Standard:	FCC Part 22H/24E/27/90S	Test Distance:	3m
Test item:	Harmonic	Power:	AC 120V/60Hz
Frequency:	829MHz	Temp.(°C)/Hum.(%RH):	26(°C)/60%RH
Mode:	4G_Band 26_10M_QPSK_CH26840	Date:	10/13/2017
Ant.Polar.:	Vertical		

No.	Frequency (MHz)	Reading (dBm)	Correct Factor (dB)	Result (dBm)	Limit (dBm)	Margin (dB)	Remark
1	1659.000	-28.36	-13.28	-41.64	-13.00	-28.64	peak



Standard:	FCC Part 22H/24E/27/90S	Test Distance:	3m
Test item:	Harmonic	Power:	AC 120V/60Hz
Frequency:	844MHz	Temp.(°C)/Hum.(%RH):	26(°C)/60%RH
Mode:	4G_Band 26_10M_QPSK_CH26990	Date:	10/13/2017
Ant.Polar.:	Horizontal		

No.	Frequency (MHz)	Reading (dBm)	Correct Factor (dB)	Result (dBm)	Limit (dBm)	Margin (dB)	Remark
1	1688.000	-21.80	-12.89	-34.69	-13.00	-21.69	peak

Standard:	FCC Part 22H/24E/27/90S	Test Distance:	3m
Test item:	Harmonic	Power:	AC 120V/60Hz
Frequency:	844MHz	Temp.(°C)/Hum.(%RH):	26(°C)/60%RH
Mode:	4G_Band 26_10M_QPSK_CH26990	Date:	10/13/2017
Ant.Polar.:	Vertical		

No.	Frequency (MHz)	Reading (dBm)	Correct Factor (dB)	Result (dBm)	Limit (dBm)	Margin (dB)	Remark
1	1688.000	-22.18	-12.89	-35.07	-13.00	-22.07	peak



Standard:	FCC Part 22H/24E/27/90S	Test Distance:	3m
Test item:	Harmonic	Power:	AC 120V/60Hz
Frequency:	836.5MHz	Temp.(°C)/Hum.(%RH):	26(°C)/60%RH
Mode:	4G_Band 26_10M-16QAM_CH26915	Date:	10/13/2017
Ant.Polar.:	Horizontal		

No.	Frequency (MHz)	Reading (dBm)	Correct Factor (dB)	Result (dBm)	Limit (dBm)	Margin (dB)	Remark
1	1673.000	-22.24	-12.89	-35.13	-13.00	-22.13	peak

Standard:	FCC Part 22H/24E/27/90S	Test Distance:	3m
Test item:	Harmonic	Power:	AC 120V/60Hz
Frequency:	836.5MHz	Temp.(°C)/Hum.(%RH):	26(°C)/60%RH
Mode:	4G_Band 26_10M-16QAM_CH26915	Date:	10/13/2017
Ant.Polar.:	Vertical		

No.	Frequency (MHz)	Reading (dBm)	Correct Factor (dB)	Result (dBm)	Limit (dBm)	Margin (dB)	Remark
1	1673.000	-22.90	-12.89	-35.79	-13.00	-22.79	peak



Standard:	FCC Part 22H/24E/27/90S	Test Distance:	3m
Test item:	Harmonic	Power:	AC 120V/60Hz
Frequency:	831.5MHz	Temp.(°C)/Hum.(%RH):	26(°C)/60%RH
Mode:	4G_Band 26_15M_QPSK_CH26865	Date:	10/13/2017
Ant.Polar.:	Horizontal		

No.	Frequency (MHz)	Reading (dBm)	Correct Factor (dB)	Result (dBm)	Limit (dBm)	Margin (dB)	Remark
1	1663.000	-20.74	-13.24	-33.98	-13.00	-20.98	peak

Standard:	FCC Part 22H/24E/27/90S	Test Distance:	3m
Test item:	Harmonic	Power:	AC 120V/60Hz
Frequency:	831.5MHz	Temp.(°C)/Hum.(%RH):	26(°C)/60%RH
Mode:	4G_Band 26_15M_QPSK_CH26865	Date:	10/13/2017
Ant.Polar.:	Vertical		

No.	Frequency (MHz)	Reading (dBm)	Correct Factor (dB)	Result (dBm)	Limit (dBm)	Margin (dB)	Remark
1	1663.000	-21.72	-13.24	-34.96	-13.00	-21.96	peak



Standard:	FCC Part 22H/24E/27/90S	Test Distance:	3m
Test item:	Harmonic	Power:	AC 120V/60Hz
Frequency:	836.5MHz	Temp.(°C)/Hum.(%RH):	26(°C)/60%RH
Mode:	4G_Band 26_15M_QPSK_CH26915	Date:	10/13/2017
Ant.Polar.:	Horizontal		

No.	Frequency (MHz)	Reading (dBm)	Correct Factor (dB)	Result (dBm)	Limit (dBm)	Margin (dB)	Remark
1	1673.000	-17.88	-13.10	-30.98	-13.00	-17.98	peak

Standard:	FCC Part 22H/24E/27/90S	Test Distance:	3m
Test item:	Harmonic	Power:	AC 120V/60Hz
Frequency:	836.5MHz	Temp.(°C)/Hum.(%RH):	26(°C)/60%RH
Mode:	4G_Band 26_15M_QPSK_CH26915	Date:	10/13/2017
Ant.Polar.:	Vertical		

No.	Frequency (MHz)	Reading (dBm)	Correct Factor (dB)	Result (dBm)	Limit (dBm)	Margin (dB)	Remark
1	1673.000	-18.68	-13.10	-31.78	-13.00	-18.78	peak



Standard:	FCC Part 22H/24E/27/90S	Test Distance:	3m
Test item:	Harmonic	Power:	AC 120V/60Hz
Frequency:	841.5MHz	Temp.(°C)/Hum.(%RH):	26(°C)/60%RH
Mode:	4G_Band 26_15M_QPSK_CH26965	Date:	10/13/2017
Ant.Polar.:	Horizontal		

No.	Frequency (MHz)	Reading (dBm)	Correct Factor (dB)	Result (dBm)	Limit (dBm)	Margin (dB)	Remark
1	1683.000	-20.13	-12.96	-33.09	-13.00	-20.09	peak

Standard:	FCC Part 22H/24E/27/90S	Test Distance:	3m
Test item:	Harmonic	Power:	AC 120V/60Hz
Frequency:	841.5MHz	Temp.(°C)/Hum.(%RH):	26(°C)/60%RH
Mode:	4G_Band 26_15M_QPSK_CH26965	Date:	10/13/2017
Ant.Polar.:	Vertical		

No.	Frequency (MHz)	Reading (dBm)	Correct Factor (dB)	Result (dBm)	Limit (dBm)	Margin (dB)	Remark
1	1683.000	-20.00	-12.96	-32.96	-13.00	-19.96	peak



Standard:	FCC Part 22H/24E/27/90S	Test Distance:	3m
Test item:	Harmonic	Power:	AC 120V/60Hz
Frequency:	836.5MHz	Temp.(°C)/Hum.(%RH):	26(°C)/60%RH
Mode:	4G_Band 26_15M-16QAM_CH26915	Date:	10/13/2017
Ant.Polar.:	Horizontal		

No.	Frequency (MHz)	Reading (dBm)	Correct Factor (dB)	Result (dBm)	Limit (dBm)	Margin (dB)	Remark
1	1673.000	-18.46	-13.10	-31.56	-13.00	-18.56	peak

Standard:	FCC Part 22H/24E/27/90S	Test Distance:	3m
Test item:	Harmonic	Power:	AC 120V/60Hz
Frequency:	836.5MHz	Temp.(°C)/Hum.(%RH):	26(°C)/60%RH
Mode:	4G_Band 26_15M-16QAM_CH26915	Date:	10/13/2017
Ant.Polar.:	Vertical		

No.	Frequency (MHz)	Reading (dBm)	Correct Factor (dB)	Result (dBm)	Limit (dBm)	Margin (dB)	Remark
1	1673.000	-17.59	-13.10	-30.69	-13.00	-17.69	peak



Standard:	FCC Part 22H/24E/27/90S	Test Distance:	3m
Test item:	Harmonic	Power:	AC 120V/60Hz
Frequency:	814.7MHz	Temp.(°C)/Hum.(%RH):	26(°C)/60%RH
Mode:	4G_Band 26_1.4M_QPSK_CH26697	Date:	10/13/2017
Ant.Polar.:	Horizontal		

No.	Frequency (MHz)	Reading (dBm)	Correct Factor (dB)	Result (dBm)	Limit (dBm)	Margin (dB)	Remark
1	1629.400	-22.72	-13.69	-36.41	-13.00	-23.41	peak

Standard:	FCC Part 22H/24E/27/90S	Test Distance:	3m
Test item:	Harmonic	Power:	AC 120V/60Hz
Frequency:	814.7MHz	Temp.(°C)/Hum.(%RH):	26(°C)/60%RH
Mode:	4G_Band 26_1.4M_QPSK_CH26697	Date:	10/13/2017
Ant.Polar.:	Vertical		

No.	Frequency (MHz)	Reading (dBm)	Correct Factor (dB)	Result (dBm)	Limit (dBm)	Margin (dB)	Remark
1	1629.400	-21.87	-13.69	-35.56	-13.00	-22.56	peak



Standard:	FCC Part 22H/24E/27/90S	Test Distance:	3m
Test item:	Harmonic	Power:	AC 120V/60Hz
Frequency:	819MHz	Temp.(°C)/Hum.(%RH):	26(°C)/60%RH
Mode:	4G_Band 26_1.4M_QPSK_CH26740	Date:	10/13/2017
Ant.Polar.:	Horizontal		

No.	Frequency (MHz)	Reading (dBm)	Correct Factor (dB)	Result (dBm)	Limit (dBm)	Margin (dB)	Remark
1	1638.000	-24.38	-13.57	-37.95	-13.00	-24.95	peak

Standard:	FCC Part 22H/24E/27/90S	Test Distance:	3m
Test item:	Harmonic	Power:	AC 120V/60Hz
Frequency:	819MHz	Temp.(°C)/Hum.(%RH):	26(°C)/60%RH
Mode:	4G_Band 26_1.4M_QPSK_CH26740	Date:	10/13/2017
Ant.Polar.:	Vertical		

No.	Frequency (MHz)	Reading (dBm)	Correct Factor (dB)	Result (dBm)	Limit (dBm)	Margin (dB)	Remark
1	1638.000	-19.58	-13.57	-33.15	-13.00	-20.15	peak



Standard:	FCC Part 22H/24E/27/90S	Test Distance:	3m
Test item:	Harmonic	Power:	AC 120V/60Hz
Frequency:	823.3MHz	Temp.(°C)/Hum.(%RH):	26(°C)/60%RH
Mode:	4G_Band 26_1.4M_QPSK_CH26783	Date:	10/13/2017
Ant.Polar.:	Horizontal		

No.	Frequency (MHz)	Reading (dBm)	Correct Factor (dB)	Result (dBm)	Limit (dBm)	Margin (dB)	Remark
1	1646.600	-24.20	-13.45	-37.65	-13.00	-24.65	peak

Standard:	FCC Part 22H/24E/27/90S	Test Distance:	3m
Test item:	Harmonic	Power:	AC 120V/60Hz
Frequency:	823.3MHz	Temp.(°C)/Hum.(%RH):	26(°C)/60%RH
Mode:	4G_Band 26_1.4M_QPSK_CH26783	Date:	10/13/2017
Ant.Polar.:	Vertical		

No.	Frequency (MHz)	Reading (dBm)	Correct Factor (dB)	Result (dBm)	Limit (dBm)	Margin (dB)	Remark
1	1646.600	-25.40	-13.45	-38.85	-13.00	-25.85	peak



Standard:	FCC Part 22H/24E/27/90S	Test Distance:	3m
Test item:	Harmonic	Power:	AC 120V/60Hz
Frequency:	819MHz	Temp.(°C)/Hum.(%RH):	26(°C)/60%RH
Mode:	4G_Band 26_1.4M-16QAM_CH26740	Date:	10/13/2017
Ant.Polar.:	Horizontal		

No.	Frequency (MHz)	Reading (dBm)	Correct Factor (dB)	Result (dBm)	Limit (dBm)	Margin (dB)	Remark
1	1638.000	-23.02	-13.57	-36.59	-13.00	-23.59	peak

Standard:	FCC Part 22H/24E/27/90S	Test Distance:	3m
Test item:	Harmonic	Power:	AC 120V/60Hz
Frequency:	819MHz	Temp.(°C)/Hum.(%RH):	26(°C)/60%RH
Mode:	4G_Band 26_1.4M-16QAM_CH26740	Date:	10/13/2017
Ant.Polar.:	Vertical		

No.	Frequency (MHz)	Reading (dBm)	Correct Factor (dB)	Result (dBm)	Limit (dBm)	Margin (dB)	Remark
1	1638.000	-20.22	-13.57	-33.79	-13.00	-20.79	peak



Standard:	FCC Part 22H/24E/27/90S	Test Distance:	3m
Test item:	Harmonic	Power:	AC 120V/60Hz
Frequency:	819MHz	Temp.(°C)/Hum.(%RH):	26(°C)/60%RH
Mode:	4G_Band 26_3M_QPSK_CH26740	Date:	10/13/2017
Ant.Polar.:	Horizontal		

No.	Frequency (MHz)	Reading (dBm)	Correct Factor (dB)	Result (dBm)	Limit (dBm)	Margin (dB)	Remark
1	1631.000	-25.12	-13.67	-38.79	-13.00	-25.79	peak

Standard:	FCC Part 22H/24E/27/90S	Test Distance:	3m
Test item:	Harmonic	Power:	AC 120V/60Hz
Frequency:	819MHz	Temp.(°C)/Hum.(%RH):	26(°C)/60%RH
Mode:	4G_Band 26_3M_QPSK_CH26740	Date:	10/13/2017
Ant.Polar.:	Vertical		

No.	Frequency (MHz)	Reading (dBm)	Correct Factor (dB)	Result (dBm)	Limit (dBm)	Margin (dB)	Remark
1	1631.000	-25.34	-13.67	-39.01	-13.00	-26.01	peak



Standard:	FCC Part 22H/24E/27/90S	Test Distance:	3m
Test item:	Harmonic	Power:	AC 120V/60Hz
Frequency:	820MHz	Temp.(°C)/Hum.(%RH):	26(°C)/60%RH
Mode:	4G_Band 26_3M_QPSK_CH26750	Date:	10/13/2017
Ant.Polar.:	Horizontal		

No.	Frequency (MHz)	Reading (dBm)	Correct Factor (dB)	Result (dBm)	Limit (dBm)	Margin (dB)	Remark
1	1631.000	-26.08	-13.67	-39.75	-13.00	-26.75	peak

Standard:	FCC Part 22H/24E/27/90S	Test Distance:	3m
Test item:	Harmonic	Power:	AC 120V/60Hz
Frequency:	820MHz	Temp.(°C)/Hum.(%RH):	26(°C)/60%RH
Mode:	4G_Band 26_3M_QPSK_CH26750	Date:	10/13/2017
Ant.Polar.:	Vertical		

No.	Frequency (MHz)	Reading (dBm)	Correct Factor (dB)	Result (dBm)	Limit (dBm)	Margin (dB)	Remark
1	1631.000	-24.01	-13.67	-37.68	-13.00	-24.68	peak



Standard:	FCC Part 22H/24E/27/90S	Test Distance:	3m
Test item:	Harmonic	Power:	AC 120V/60Hz
Frequency:	822.5MHz	Temp.(°C)/Hum.(%RH):	26(°C)/60%RH
Mode:	4G_Band 26_3M_QPSK_CH26775	Date:	10/13/2017
Ant.Polar.:	Horizontal		

No.	Frequency (MHz)	Reading (dBm)	Correct Factor (dB)	Result (dBm)	Limit (dBm)	Margin (dB)	Remark
1	1645.000	-27.31	-13.47	-40.78	-13.00	-27.78	peak

Standard:	FCC Part 22H/24E/27/90S	Test Distance:	3m
Test item:	Harmonic	Power:	AC 120V/60Hz
Frequency:	822.5MHz	Temp.(°C)/Hum.(%RH):	26(°C)/60%RH
Mode:	4G_Band 26_3M_QPSK_CH26775	Date:	10/13/2017
Ant.Polar.:	Vertical		

No.	Frequency (MHz)	Reading (dBm)	Correct Factor (dB)	Result (dBm)	Limit (dBm)	Margin (dB)	Remark
1	1645.000	-25.13	-13.47	-38.60	-13.00	-25.60	peak



Standard:	FCC Part 22H/24E/27/90S	Test Distance:	3m
Test item:	Harmonic	Power:	AC 120V/60Hz
Frequency:	819MHz	Temp.(°C)/Hum.(%RH):	26(°C)/60%RH
Mode:	4G_Band 26_3M-16QAM_CH26740	Date:	10/13/2017
Ant.Polar.:	Horizontal		

No.	Frequency (MHz)	Reading (dBm)	Correct Factor (dB)	Result (dBm)	Limit (dBm)	Margin (dB)	Remark
1	1631.000	-26.00	-13.67	-39.67	-13.00	-26.67	peak

Standard:	FCC Part 22H/24E/27/90S	Test Distance:	3m
Test item:	Harmonic	Power:	AC 120V/60Hz
Frequency:	819MHz	Temp.(°C)/Hum.(%RH):	26(°C)/60%RH
Mode:	4G_Band 26_3M-16QAM_CH26740	Date:	10/13/2017
Ant.Polar.:	Vertical		

No.	Frequency (MHz)	Reading (dBm)	Correct Factor (dB)	Result (dBm)	Limit (dBm)	Margin (dB)	Remark
1	1631.000	-26.49	-13.67	-40.16	-13.00	-27.16	peak



Standard:	FCC Part 22H/24E/27/90S	Test Distance:	3m
Test item:	Harmonic	Power:	AC 120V/60Hz
Frequency:	816.5MHz	Temp.(°C)/Hum.(%RH):	26(°C)/60%RH
Mode:	4G_Band 26_5M_QPSK_CH26715	Date:	10/13/2017
Ant.Polar.:	Horizontal		

No.	Frequency (MHz)	Reading (dBm)	Correct Factor (dB)	Result (dBm)	Limit (dBm)	Margin (dB)	Remark
1	1633.000	-27.21	-13.64	-40.85	-13.00	-27.85	peak

Standard:	FCC Part 22H/24E/27/90S	Test Distance:	3m
Test item:	Harmonic	Power:	AC 120V/60Hz
Frequency:	816.5MHz	Temp.(°C)/Hum.(%RH):	26(°C)/60%RH
Mode:	4G_Band 26_5M_QPSK_CH26715	Date:	10/13/2017
Ant.Polar.:	Vertical		

No.	Frequency (MHz)	Reading (dBm)	Correct Factor (dB)	Result (dBm)	Limit (dBm)	Margin (dB)	Remark
1	1633.000	-26.03	-13.64	-39.67	-13.00	-26.67	peak



Standard:	FCC Part 22H/24E/27/90S	Test Distance:	3m
Test item:	Harmonic	Power:	AC 120V/60Hz
Frequency:	819MHz	Temp.(°C)/Hum.(%RH):	26(°C)/60%RH
Mode:	4G_Band 26_5M_QPSK_CH26740	Date:	10/13/2017
Ant.Polar.:	Horizontal		

No.	Frequency (MHz)	Reading (dBm)	Correct Factor (dB)	Result (dBm)	Limit (dBm)	Margin (dB)	Remark
1	1638.000	-27.94	-13.57	-41.51	-13.00	-28.51	peak

Standard:	FCC Part 22H/24E/27/90S	Test Distance:	3m
Test item:	Harmonic	Power:	AC 120V/60Hz
Frequency:	819MHz	Temp.(°C)/Hum.(%RH):	26(°C)/60%RH
Mode:	4G_Band 26_5M_QPSK_CH26740	Date:	10/13/2017
Ant.Polar.:	Vertical		

No.	Frequency (MHz)	Reading (dBm)	Correct Factor (dB)	Result (dBm)	Limit (dBm)	Margin (dB)	Remark
1	1638.000	-27.28	-13.57	-40.85	-13.00	-27.85	peak



Standard:	FCC Part 22H/24E/27/90S	Test Distance:	3m
Test item:	Harmonic	Power:	AC 120V/60Hz
Frequency:	821.5MHz	Temp.(°C)/Hum.(%RH):	26(°C)/60%RH
Mode:	4G_Band 26_5M_QPSK_CH26765	Date:	10/13/2017
Ant.Polar.:	Horizontal		

No.	Frequency (MHz)	Reading (dBm)	Correct Factor (dB)	Result (dBm)	Limit (dBm)	Margin (dB)	Remark
1	1642.000	-27.33	-13.52	-40.85	-13.00	-27.85	peak

Standard:	FCC Part 22H/24E/27/90S	Test Distance:	3m
Test item:	Harmonic	Power:	AC 120V/60Hz
Frequency:	821.5MHz	Temp.(°C)/Hum.(%RH):	26(°C)/60%RH
Mode:	4G_Band 26_5M_QPSK_CH26765	Date:	10/13/2017
Ant.Polar.:	Vertical		

No.	Frequency (MHz)	Reading (dBm)	Correct Factor (dB)	Result (dBm)	Limit (dBm)	Margin (dB)	Remark
1	1642.000	-28.06	-13.52	-41.58	-13.00	-28.58	peak



Standard:	FCC Part 22H/24E/27/90S	Test Distance:	3m
Test item:	Harmonic	Power:	AC 120V/60Hz
Frequency:	819MHz	Temp.(°C)/Hum.(%RH):	26(°C)/60%RH
Mode:	4G_Band 26_5M-16QAM_CH26740	Date:	10/13/2017
Ant.Polar.:	Horizontal		

No.	Frequency (MHz)	Reading (dBm)	Correct Factor (dB)	Result (dBm)	Limit (dBm)	Margin (dB)	Remark
1	1638.000	-29.02	-13.57	-42.59	-13.00	-29.59	peak

Standard:	FCC Part 22H/24E/27/90S	Test Distance:	3m
Test item:	Harmonic	Power:	AC 120V/60Hz
Frequency:	819MHz	Temp.(°C)/Hum.(%RH):	26(°C)/60%RH
Mode:	4G_Band 26_5M-16QAM_CH26740	Date:	10/13/2017
Ant.Polar.:	Vertical		

No.	Frequency (MHz)	Reading (dBm)	Correct Factor (dB)	Result (dBm)	Limit (dBm)	Margin (dB)	Remark
1	1638.000	-29.50	-13.57	-43.07	-13.00	-30.07	peak



Standard:	FCC Part 22H/24E/27/90S	Test Distance:	3m
Test item:	Harmonic	Power:	AC 120V/60Hz
Frequency:	819MHz	Temp.(°C)/Hum.(%RH):	26(°C)/60%RH
Mode:	4G_Band 26_10M_QPSK_CH26740	Date:	10/13/2017
Ant.Polar.:	Horizontal		

No.	Frequency (MHz)	Reading (dBm)	Correct Factor (dB)	Result (dBm)	Limit (dBm)	Margin (dB)	Remark
1	1638.000	-29.01	-13.57	-42.58	-13.00	-29.58	peak

Standard:	FCC Part 22H/24E/27/90S	Test Distance:	3m
Test item:	Harmonic	Power:	AC 120V/60Hz
Frequency:	819MHz	Temp.(°C)/Hum.(%RH):	26(°C)/60%RH
Mode:	4G_Band 26_10M_QPSK_CH26740	Date:	10/13/2017
Ant.Polar.:	Vertical		

No.	Frequency (MHz)	Reading (dBm)	Correct Factor (dB)	Result (dBm)	Limit (dBm)	Margin (dB)	Remark
1	1638.000	-27.59	-13.57	-41.16	-13.00	-28.16	peak



Standard:	FCC Part 22H/24E/27/90S	Test Distance:	3m
Test item:	Harmonic	Power:	AC 120V/60Hz
Frequency:	819MHz	Temp.(°C)/Hum.(%RH):	26(°C)/60%RH
Mode:	4G_Band 26_10M-16QAM_CH26740	Date:	10/13/2017
Ant.Polar.:	Horizontal		

No.	Frequency (MHz)	Reading (dBm)	Correct Factor (dB)	Result (dBm)	Limit (dBm)	Margin (dB)	Remark
1	1638.000	-32.39	-13.57	-45.96	-13.00	-32.96	peak

Standard:	FCC Part 22H/24E/27/90S	Test Distance:	3m
Test item:	Harmonic	Power:	AC 120V/60Hz
Frequency:	819MHz	Temp.(°C)/Hum.(%RH):	26(°C)/60%RH
Mode:	4G_Band 26_10M-16QAM_CH26740	Date:	10/13/2017
Ant.Polar.:	Vertical		

No.	Frequency (MHz)	Reading (dBm)	Correct Factor (dB)	Result (dBm)	Limit (dBm)	Margin (dB)	Remark
1	1638.000	-30.39	-13.57	-43.96	-13.00	-30.96	peak



Standard:	FCC Part 22H/24E/27/90	Test Distance:	3m
Test item:	Harmonic	Power:	AC 120V/60Hz
Frequency:	2498.5MHz	Temp.(°C)/Hum.(%RH):	26(°C)/60%RH
Mode:	4G_Band 41_5M_QPSK_CH39675	Date:	09/26/2017
Ant.Polar.:	Horizontal		

No.	Frequency (MHz)	Reading (dBm)	Correct Factor (dB)	Result (dBm)	Limit (dBm)	Margin (dB)	Remark
1	4997.000	-41.90	-3.18	-45.08	-25.00	-20.08	peak

Standard:	FCC Part 22H/24E/27/90	Test Distance:	3m
Test item:	Harmonic	Power:	AC 120V/60Hz
Frequency:	2498.5MHz	Temp.(°C)/Hum.(%RH):	26(°C)/60%RH
Mode:	4G_Band 41_5M_QPSK_CH39675	Date:	09/26/2017
Ant.Polar.:	Vertical		

No.	Frequency (MHz)	Reading (dBm)	Correct Factor (dB)	Result (dBm)	Limit (dBm)	Margin (dB)	Remark
1	4997.000	-39.61	-3.18	-42.79	-25.00	-17.79	peak



Standard:	FCC Part 22H/24E/27/90	Test Distance:	3m
Test item:	Harmonic	Power:	AC 120V/60Hz
Frequency:	2593MHz	Temp.(°C)/Hum.(%RH):	26(°C)/60%RH
Mode:	4G_Band 41_5M_QPSK_CH40620	Date:	09/26/2017
Ant.Polar.:	Horizontal		

No.	Frequency (MHz)	Reading (dBm)	Correct Factor (dB)	Result (dBm)	Limit (dBm)	Margin (dB)	Remark
1	5186.000	-43.57	-2.52	-46.09	-25.00	-21.09	peak

Standard:	FCC Part 22H/24E/27/90	Test Distance:	3m
Test item:	Harmonic	Power:	AC 120V/60Hz
Frequency:	2593MHz	Temp.(°C)/Hum.(%RH):	26(°C)/60%RH
Mode:	4G_Band 41_5M_QPSK_CH40620	Date:	09/26/2017
Ant.Polar.:	Vertical		

No.	Frequency (MHz)	Reading (dBm)	Correct Factor (dB)	Result (dBm)	Limit (dBm)	Margin (dB)	Remark
1	5186.000	-42.19	-2.52	-44.71	-25.00	-19.71	peak



Standard:	FCC Part 22H/24E/27/90	Test Distance:	3m
Test item:	Harmonic	Power:	AC 120V/60Hz
Frequency:	2687.5MHz	Temp.(°C)/Hum.(%RH):	26(°C)/60%RH
Mode:	4G_Band 41_5M_QPSK_CH41565	Date:	09/26/2017
Ant.Polar.:	Horizontal		

No.	Frequency (MHz)	Reading (dBm)	Correct Factor (dB)	Result (dBm)	Limit (dBm)	Margin (dB)	Remark
1	5375.000	-44.98	-2.31	-47.29	-25.00	-22.29	peak

Standard:	FCC Part 22H/24E/27/90	Test Distance:	3m
Test item:	Harmonic	Power:	AC 120V/60Hz
Frequency:	2687.5MHz	Temp.(°C)/Hum.(%RH):	26(°C)/60%RH
Mode:	4G_Band 41_5M_QPSK_CH41565	Date:	09/26/2017
Ant.Polar.:	Vertical		

No.	Frequency (MHz)	Reading (dBm)	Correct Factor (dB)	Result (dBm)	Limit (dBm)	Margin (dB)	Remark
1	5375.000	-43.02	-2.31	-45.33	-25.00	-20.33	peak



Standard:	FCC Part 22H/24E/27/90	Test Distance:	3m
Test item:	Harmonic	Power:	AC 120V/60Hz
Frequency:	2593MHz	Temp.(°C)/Hum.(%RH):	26(°C)/60%RH
Mode:	4G_Band 41_5M-16QAM_CH40620	Date:	09/26/2017
Ant.Polar.:	Horizontal		

No.	Frequency (MHz)	Reading (dBm)	Correct Factor (dB)	Result (dBm)	Limit (dBm)	Margin (dB)	Remark
1	5186.000	-46.53	-2.52	-49.05	-25.00	-24.05	peak

Standard:	FCC Part 22H/24E/27/90	Test Distance:	3m
Test item:	Harmonic	Power:	AC 120V/60Hz
Frequency:	2593MHz	Temp.(°C)/Hum.(%RH):	26(°C)/60%RH
Mode:	4G_Band 41_5M-16QAM_CH40620	Date:	09/26/2017
Ant.Polar.:	Vertical		

No.	Frequency (MHz)	Reading (dBm)	Correct Factor (dB)	Result (dBm)	Limit (dBm)	Margin (dB)	Remark
1	5186.000	-44.37	-2.52	-46.89	-25.00	-21.89	peak



Standard:	FCC Part 22H/24E/27/90	Test Distance:	3m
Test item:	Harmonic	Power:	AC 120V/60Hz
Frequency:	2501MHz	Temp.(°C)/Hum.(%RH):	26(°C)/60%RH
Mode:	4G_Band 41_10M_QPSK_CH39700	Date:	09/26/2017
Ant.Polar.:	Horizontal		

No.	Frequency (MHz)	Reading (dBm)	Correct Factor (dB)	Result (dBm)	Limit (dBm)	Margin (dB)	Remark
1	5002.000	-48.28	-3.18	-51.46	-25.00	-26.46	peak

Standard:	FCC Part 22H/24E/27/90	Test Distance:	3m
Test item:	Harmonic	Power:	AC 120V/60Hz
Frequency:	2501MHz	Temp.(°C)/Hum.(%RH):	26(°C)/60%RH
Mode:	4G_Band 41_10M_QPSK_CH39700	Date:	09/26/2017
Ant.Polar.:	Vertical		

No.	Frequency (MHz)	Reading (dBm)	Correct Factor (dB)	Result (dBm)	Limit (dBm)	Margin (dB)	Remark
1	5002.000	-45.79	-3.18	-48.97	-25.00	-23.97	peak



Standard:	FCC Part 22H/24E/27/90	Test Distance:	3m
Test item:	Harmonic	Power:	AC 120V/60Hz
Frequency:	2593MHz	Temp.(°C)/Hum.(%RH):	26(°C)/60%RH
Mode:	4G_Band 41_10M_QPSK_CH40620	Date:	09/26/2017
Ant.Polar.:	Horizontal		

No.	Frequency (MHz)	Reading (dBm)	Correct Factor (dB)	Result (dBm)	Limit (dBm)	Margin (dB)	Remark
1	5186.000	-43.29	-2.52	-45.81	-25.00	-20.81	peak

Standard:	FCC Part 22H/24E/27/90	Test Distance:	3m
Test item:	Harmonic	Power:	AC 120V/60Hz
Frequency:	2593MHz	Temp.(°C)/Hum.(%RH):	26(°C)/60%RH
Mode:	4G_Band 41_10M_QPSK_CH40620	Date:	09/26/2017
Ant.Polar.:	Vertical		

No.	Frequency (MHz)	Reading (dBm)	Correct Factor (dB)	Result (dBm)	Limit (dBm)	Margin (dB)	Remark
1	5186.000	-40.66	-2.52	-43.18	-25.00	-18.18	peak



Standard:	FCC Part 22H/24E/27/90	Test Distance:	3m
Test item:	Harmonic	Power:	AC 120V/60Hz
Frequency:	2685MHz	Temp.(°C)/Hum.(%RH):	26(°C)/60%RH
Mode:	4G_Band 41_10M_QPSK_CH41540	Date:	09/26/2017
Ant.Polar.:	Horizontal		

No.	Frequency (MHz)	Reading (dBm)	Correct Factor (dB)	Result (dBm)	Limit (dBm)	Margin (dB)	Remark
1	5370.000	-45.73	-2.30	-48.03	-25.00	-23.03	peak

Standard:	FCC Part 22H/24E/27/90	Test Distance:	3m
Test item:	Harmonic	Power:	AC 120V/60Hz
Frequency:	2685MHz	Temp.(°C)/Hum.(%RH):	26(°C)/60%RH
Mode:	4G_Band 41_10M_QPSK_CH41540	Date:	09/26/2017
Ant.Polar.:	Vertical		

No.	Frequency (MHz)	Reading (dBm)	Correct Factor (dB)	Result (dBm)	Limit (dBm)	Margin (dB)	Remark
1	5370.000	-43.92	-2.30	-46.22	-25.00	-21.22	peak



Standard:	FCC Part 22H/24E/27/90	Test Distance:	3m
Test item:	Harmonic	Power:	AC 120V/60Hz
Frequency:	2593MHz	Temp.(°C)/Hum.(%RH):	26(°C)/60%RH
Mode:	4G_Band 41_10M-16QAM_CH40620	Date:	09/26/2017
Ant.Polar.:	Horizontal		

No.	Frequency (MHz)	Reading (dBm)	Correct Factor (dB)	Result (dBm)	Limit (dBm)	Margin (dB)	Remark
1	5186.000	-48.27	-2.52	-50.79	-25.00	-25.79	peak

Standard:	FCC Part 22H/24E/27/90	Test Distance:	3m
Test item:	Harmonic	Power:	AC 120V/60Hz
Frequency:	2593MHz	Temp.(°C)/Hum.(%RH):	26(°C)/60%RH
Mode:	4G_Band 41_10M-16QAM_CH40620	Date:	09/26/2017
Ant.Polar.:	Vertical		

No.	Frequency (MHz)	Reading (dBm)	Correct Factor (dB)	Result (dBm)	Limit (dBm)	Margin (dB)	Remark
1	5186.000	-48.27	-2.52	-50.79	-25.00	-25.79	peak



Standard:	FCC Part 22H/24E/27/90	Test Distance:	3m
Test item:	Harmonic	Power:	AC 120V/60Hz
Frequency:	2503.5MHz	Temp.(°C)/Hum.(%RH):	26(°C)/60%RH
Mode:	4G_Band 41_15M_QPSK_CH39725	Date:	09/26/2017
Ant.Polar.:	Horizontal		

No.	Frequency (MHz)	Reading (dBm)	Correct Factor (dB)	Result (dBm)	Limit (dBm)	Margin (dB)	Remark
1	5007.000	-41.92	-3.16	-45.08	-25.00	-20.08	peak

Standard:	FCC Part 22H/24E/27/90	Test Distance:	3m
Test item:	Harmonic	Power:	AC 120V/60Hz
Frequency:	2503.5MHz	Temp.(°C)/Hum.(%RH):	26(°C)/60%RH
Mode:	4G_Band 41_15M_QPSK_CH39725	Date:	09/26/2017
Ant.Polar.:	Vertical		

No.	Frequency (MHz)	Reading (dBm)	Correct Factor (dB)	Result (dBm)	Limit (dBm)	Margin (dB)	Remark
1	5007.000	-44.80	-3.16	-47.96	-25.00	-22.96	peak



Standard:	FCC Part 22H/24E/27/90	Test Distance:	3m
Test item:	Harmonic	Power:	AC 120V/60Hz
Frequency:	2593MHz	Temp.(°C)/Hum.(%RH):	26(°C)/60%RH
Mode:	4G_Band 41_15M_QPSK_CH40620	Date:	09/26/2017
Ant.Polar.:	Horizontal		

No.	Frequency (MHz)	Reading (dBm)	Correct Factor (dB)	Result (dBm)	Limit (dBm)	Margin (dB)	Remark
1	5186.000	-43.81	-2.52	-46.33	-25.00	-21.33	peak

Standard:	FCC Part 22H/24E/27/90	Test Distance:	3m
Test item:	Harmonic	Power:	AC 120V/60Hz
Frequency:	2593MHz	Temp.(°C)/Hum.(%RH):	26(°C)/60%RH
Mode:	4G_Band 41_15M_QPSK_CH40620	Date:	09/26/2017
Ant.Polar.:	Vertical		

No.	Frequency (MHz)	Reading (dBm)	Correct Factor (dB)	Result (dBm)	Limit (dBm)	Margin (dB)	Remark
1	5186.000	-43.81	-2.52	-46.33	-25.00	-21.33	peak



Standard:	FCC Part 22H/24E/27/90	Test Distance:	3m
Test item:	Harmonic	Power:	AC 120V/60Hz
Frequency:	2682.5MHz	Temp.(°C)/Hum.(%RH):	26(°C)/60%RH
Mode:	4G_Band 41_15M_QPSK_CH41515	Date:	09/26/2017
Ant.Polar.:	Horizontal		

No.	Frequency (MHz)	Reading (dBm)	Correct Factor (dB)	Result (dBm)	Limit (dBm)	Margin (dB)	Remark
1	5365.000	-43.22	-2.30	-45.52	-25.00	-20.52	peak

Standard:	FCC Part 22H/24E/27/90	Test Distance:	3m
Test item:	Harmonic	Power:	AC 120V/60Hz
Frequency:	2682.5MHz	Temp.(°C)/Hum.(%RH):	26(°C)/60%RH
Mode:	4G_Band 41_15M_QPSK_CH41515	Date:	09/26/2017
Ant.Polar.:	Vertical		

No.	Frequency (MHz)	Reading (dBm)	Correct Factor (dB)	Result (dBm)	Limit (dBm)	Margin (dB)	Remark
1	5365.000	-43.22	-2.30	-45.52	-25.00	-20.52	peak



Standard:	FCC Part 22H/24E/27/90	Test Distance:	3m
Test item:	Harmonic	Power:	AC 120V/60Hz
Frequency:	2593MHz	Temp.(°C)/Hum.(%RH):	26(°C)/60%RH
Mode:	4G_Band 41_15M-16QAM_CH40620	Date:	09/26/2017
Ant.Polar.:	Horizontal		

No.	Frequency (MHz)	Reading (dBm)	Correct Factor (dB)	Result (dBm)	Limit (dBm)	Margin (dB)	Remark
1	5186.000	-53.52	-2.52	-56.04	-25.00	-31.04	peak

Standard:	FCC Part 22H/24E/27/90	Test Distance:	3m
Test item:	Harmonic	Power:	AC 120V/60Hz
Frequency:	2593MHz	Temp.(°C)/Hum.(%RH):	26(°C)/60%RH
Mode:	4G_Band 41_15M-16QAM_CH40620	Date:	09/26/2017
Ant.Polar.:	Vertical		

No.	Frequency (MHz)	Reading (dBm)	Correct Factor (dB)	Result (dBm)	Limit (dBm)	Margin (dB)	Remark
1	5186.000	-48.59	-2.52	-51.11	-25.00	-26.11	peak



Standard:	FCC Part 22H/24E/27/90	Test Distance:	3m
Test item:	Harmonic	Power:	AC 120V/60Hz
Frequency:	2506MHz	Temp.(°C)/Hum.(%RH):	26(°C)/60%RH
Mode:	4G_Band 41_20M_QPSK_CH39750	Date:	09/26/2017
Ant.Polar.:	Horizontal		

No.	Frequency (MHz)	Reading (dBm)	Correct Factor (dB)	Result (dBm)	Limit (dBm)	Margin (dB)	Remark
1	5012.000	-45.04	-3.14	-48.18	-25.00	-23.18	peak

Standard:	FCC Part 22H/24E/27/90	Test Distance:	3m
Test item:	Harmonic	Power:	AC 120V/60Hz
Frequency:	2506MHz	Temp.(°C)/Hum.(%RH):	26(°C)/60%RH
Mode:	4G_Band 41_20M_QPSK_CH39750	Date:	09/26/2017
Ant.Polar.:	Vertical		

No.	Frequency (MHz)	Reading (dBm)	Correct Factor (dB)	Result (dBm)	Limit (dBm)	Margin (dB)	Remark
1	5012.000	-45.04	-3.14	-48.18	-25.00	-23.18	peak



Standard:	FCC Part 22H/24E/27/90	Test Distance:	3m
Test item:	Harmonic	Power:	AC 120V/60Hz
Frequency:	2593MHz	Temp.(°C)/Hum.(%RH):	26(°C)/60%RH
Mode:	4G_Band 41_20M_QPSK_CH40620	Date:	09/26/2017
Ant.Polar.:	Horizontal		

No.	Frequency (MHz)	Reading (dBm)	Correct Factor (dB)	Result (dBm)	Limit (dBm)	Margin (dB)	Remark
1	5186.000	-42.43	-2.52	-44.95	-25.00	-19.95	peak

Standard:	FCC Part 22H/24E/27/90	Test Distance:	3m
Test item:	Harmonic	Power:	AC 120V/60Hz
Frequency:	2593MHz	Temp.(°C)/Hum.(%RH):	26(°C)/60%RH
Mode:	4G_Band 41_20M_QPSK_CH40620	Date:	09/26/2017
Ant.Polar.:	Vertical		

No.	Frequency (MHz)	Reading (dBm)	Correct Factor (dB)	Result (dBm)	Limit (dBm)	Margin (dB)	Remark
1	5186.000	-42.43	-2.52	-44.95	-25.00	-19.95	peak



Standard:	FCC Part 22H/24E/27/90	Test Distance:	3m
Test item:	Harmonic	Power:	AC 120V/60Hz
Frequency:	2680MHz	Temp.(°C)/Hum.(%RH):	26(°C)/60%RH
Mode:	4G_Band 41_20M_QPSK_CH41490	Date:	09/26/2017
Ant.Polar.:	Horizontal		

No.	Frequency (MHz)	Reading (dBm)	Correct Factor (dB)	Result (dBm)	Limit (dBm)	Margin (dB)	Remark
1	5360.000	-45.81	-2.30	-48.11	-25.00	-23.11	peak

Standard:	FCC Part 22H/24E/27/90	Test Distance:	3m
Test item:	Harmonic	Power:	AC 120V/60Hz
Frequency:	2680MHz	Temp.(°C)/Hum.(%RH):	26(°C)/60%RH
Mode:	4G_Band 41_20M_QPSK_CH41490	Date:	09/26/2017
Ant.Polar.:	Vertical		

No.	Frequency (MHz)	Reading (dBm)	Correct Factor (dB)	Result (dBm)	Limit (dBm)	Margin (dB)	Remark
1	5360.000	-45.81	-2.30	-48.11	-25.00	-23.11	peak



Standard:	FCC Part 22H/24E/27/90	Test Distance:	3m
Test item:	Harmonic	Power:	AC 120V/60Hz
Frequency:	2593MHz	Temp.(°C)/Hum.(%RH):	26(°C)/60%RH
Mode:	4G_Band 41_20M-16QAM_CH40620	Date:	09/26/2017
Ant.Polar.:	Horizontal		

No.	Frequency (MHz)	Reading (dBm)	Correct Factor (dB)	Result (dBm)	Limit (dBm)	Margin (dB)	Remark
1	5186.000	-51.68	-2.52	-54.20	-25.00	-29.20	peak

Standard:	FCC Part 22H/24E/27/90	Test Distance:	3m
Test item:	Harmonic	Power:	AC 120V/60Hz
Frequency:	2593MHz	Temp.(°C)/Hum.(%RH):	26(°C)/60%RH
Mode:	4G_Band 41_20M-16QAM_CH40620	Date:	09/26/2017
Ant.Polar.:	Vertical		

No.	Frequency (MHz)	Reading (dBm)	Correct Factor (dB)	Result (dBm)	Limit (dBm)	Margin (dB)	Remark
1	5186.000	-49.79	-2.52	-52.31	-25.00	-27.31	peak