



FCC PART 15C TEST REPORT

BLUETOOTH LOW ENERGY (BLE) PART

No. I16Z40908-SRD03

for

Reliance Communications, LLC

GSM/WCDMA/LTE Android mobile phone

Model Name: RC503L

FCC ID: 2ABGH-RC503L

IC: 20994-RC503L

with

Hardware Version: RC503L V.01

Software Version: Orbic-RC503L_V2.0.0

Issued Date: Jun 28th, 2016



Note:

The test results in this test report relate only to the devices specified in this report. This report shall not be reproduced except in full without the written approval of CTTL.

Test Laboratory:

CTTL, Telecommunication Technology Labs, Academy of Telecommunication Research, MIIT.

No.52, HuayuanNorth Road, Haidian District, Beijing, P. R. China 100191.

[Tel:+86\(0\)10-62304633-2512](tel:+86(0)10-62304633-2512), [Fax:+86\(0\)10-62304633-2504](tel:+86(0)10-62304633-2504)

Email: cttl_terminals@catr.cn, website: www.chinattl.com



REPORT HISTORY

Report Number	Revision	Description	Issue Date
I16Z40908-SRD03	Rev.0	1st edition	2016-06-23
I16Z40908-SRD03	Rev.1	2nd edition	2016-06-28



CONTENTS

1. TEST LABORATORY	4
1.1. TESTING LOCATION	4
1.2. TESTING ENVIRONMENT	4
1.3. PROJECT DATA	4
1.4. SIGNATURE	4
2. CLIENT INFORMATION	5
2.1. APPLICANT INFORMATION	5
2.2. MANUFACTURER INFORMATION	5
3. EQUIPMENT UNDER TEST (EUT) AND ANCILLARY EQUIPMENT (AE)	6
3.1. ABOUT EUT	6
3.2. INTERNAL IDENTIFICATION OF EUT	6
3.3. INTERNAL IDENTIFICATION OF AE	6
3.4. NORMAL ACCESSORY SETTING	6
3.5. GENERAL DESCRIPTION	6
4. REFERENCE DOCUMENTS	7
4.1. DOCUMENTS SUPPLIED BY APPLICANT	7
4.2. REFERENCE DOCUMENTS FOR TESTING	7
5. TEST RESULTS	8
5.1. SUMMARY OF TEST RESULTS	8
5.2. STATEMENTS	8
6. TEST FACILITIES UTILIZED	9
ANNEX A: DETAILED TEST RESULTS	10
A.1. MEASUREMENT METHOD	10
A.2. PEAK OUTPUT POWER - CONDUCTED	11
A.3. FREQUENCY BAND EDGES - CONDUCTED	12
A.4. TRANSMITTER SPURIOUS EMISSION - CONDUCTED	14
A.5. TRANSMITTER SPURIOUS EMISSION - RADIATED	21
A.6. 6dB BANDWIDTH	28
A.7. MAXIMUM POWER SPECTRAL DENSITY LEVEL	31
A.8. OCCUPIED BANDWIDTH	34
A.9. AC POWERLINE CONDUCTED EMISSION	37
ANNEX B: ACCREDITATION CERTIFICATE	41

1. Test Laboratory

1.1. Testing Location

Location 1:CTTL(huayuan North Road)

Address: No. 52, Huayuan North Road, Haidian District, Beijing,
P. R. China100191

Location 2:CTTL(Shouxiang)

Address: No. 51 Shouxiang Science Building, Xueyuan Road,
Haidian District, Beijing, P. R. China100191

1.2. Testing Environment

Normal Temperature: 15-35°C
Extreme Temperature: -20/+50°C
Relative Humidity: 20-75%

1.3. Project data

Testing Start Date: 2016-04-27
Testing End Date: 2016-06-15

1.4. Signature



Sun Zhenyu
(Prepared this test report)



Li Zhuofang
(Reviewed this test report)

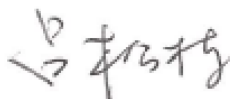

Lv Songdong
(Approved this test report)



2. Client Information

2.1. Applicant Information

Company Name: Reliance Communications, LLC
Address /Post: 555 Wireless Blvd, Hauppauge, NY 11788,United States
City: Hauppauge, NY
Postal Code: /
Country: USA
Telephone: 631-2408394
Fax: /

2.2. Manufacturer Information

Company Name: Reliance Communications, LLC
Address /Post: 555 Wireless Blvd, Hauppauge, NY 11788,United States
City: Hauppauge, NY
Postal Code: /
Country: USA
Telephone: 631-2408394
Fax: /

3. Equipment Under Test (EUT) and Ancillary Equipment (AE)

3.1. About EUT

Description	GSM/WCDMA/LTE Android mobile phone
Model Name	RC503L
FCC ID	2ABGH-RC503L
IC	20994-RC503L
Frequency Band	ISM 2400MHz~2483.5MHz
Type of Modulation(LE mode)	GFSK (Bluetooth Low Energy)
Number of Channels(LE mode)	40
Power Supply	3.8V DC by Battery

3.2. Internal Identification of EUT

EUT ID*	IMEI	HW Version	SW Version	Receive Date
EUT1	359611070000881	RC503L V.01	Orbic-RC503L_V2.0.0	2016-04-27

*EUT ID: is used to identify the test sample in the lab internally.

3.3. Internal Identification of AE

AE ID*	Description		
AE1	Battery	Orbic-RC503L	Inbuilt
AE2	Charger	TL6D-0501000	/

*AE ID: is used to identify the test sample in the lab internally.

3.4. Normal Accessory setting

Fully charged battery is used during the test.

3.5. General Description

The Equipment Under Test (EUT) is a model of GSM/WCDMA/LTE Android mobile phone with integrated antenna. It consists of normal options: lithium battery, charger. Manual and specifications of the EUT were provided to fulfil the test. Samples undergoing test were selected by the Client.

4. Reference Documents

4.1. Documents supplied by applicant

EUT feature information is supplied by the applicant or manufacturer, which is the basis of testing.

4.2. Reference Documents for testing

The following documents listed in this section are referred for testing.

Reference	Title	Version
FCC Part15	FCC CFR 47, Part 15, Subpart C: 15.205 Restricted bands of operation; 15.209 Radiated emission limits, general requirements; 15.247 Operation within the bands 902–928MHz, 2400–2483.5 MHz, and 5725–5850 MHz.	2015
ANSI C63.10	American National Standard of Procedures for Compliance Testing of Unlicensed Wireless Devices Spectrum Management and Telecommunications	June,2013
RSS - Gen	Radio Standards Specification General Requirements for Compliance of Radio Apparatus	Issue 4 Nov. 2014
RSS-247	Digital Transmission Systems (DTSs), Frequency Hopping Systems (FHSs) and Licence-Exempt Local Area Network (LE-LAN) Devices	Issue 1 May, 2015

5. Test Results

5.1. Summary of Test Results

Abbreviations used in this clause:

- P** Pass, The EUT complies with the essential requirements in the standard.
- F** Fail, The EUT does not comply with the essential requirements in the standard
- NA** Not Applicable, The test was not applicable
- NP** Not Performed, The test was not performed by CTTL

SUMMARY OF MEASUREMENT RESULTS	Sub-clause	Sub-clause of IC	Verdict
6dB Bandwidth	15.247 (a)(2)	Chapter 5.2	P
Peak Output Power - Conducted	15.247 (b)(1)	Chapter 5.4	P
Maximum Power Spectral Density Level	15.247(e)	Chapter 5.2	P
Conducted Emission	15.247 (d)	Chapter 5.5/RSS-Gen 6.13	P
Radiated Emission	15.247, 15.205, 15.209	Chapter 5.5/RSS-Gen 6.13	P
Frequency Band Edges	15.247 (d)	Chapter 5.5	P
Occupied Bandwidth	/	RSS-Gen 6.6	NA
AC Powerline Conducted Emission	15.107, 15.207	RSS-Gen 8.8	P

Please refer to **ANNEX A** for detail.

The measurement is made according to ANSI C63.10.

5.2. Statements

CTTL has evaluated the test cases requested by the applicant /manufacturer as listed in section 5.1 of this report for the EUT specified in section 3 according to the standards or reference documents listed in section 4.2

6. Test Facilities Utilized

Conducted test system

No.	Equipment	Model	Serial Number	Manufacturer	Calibration Period	Calibration Due date
1	Vector Signal Analyzer	FSV40	100903	Rohde & Schwarz	1 year	2017-03-21
2	LISN	ESH2-Z5	100196	Rohde & Schwarz	1 year	2017-01-12
3	Test Receiver	ESCI	100701	Rohde & Schwarz	1 year	2016-08-10

Radiated emission test system

No.	Equipment	Model	Serial Number	Manufacturer	Calibration Period	Calibration Due date
1	Test Receiver	ESCI 7	100948	Rohde & Schwarz	1 year	2016-07-16
2	Loop antenna	HFH2-Z2	829324/00 7	Rohde & Schwarz	3 year	2017-12-16
3	BiLog Antenna	VULB9163	234	Schwarzbeck	3 year	2016-09-15
4	Dual-Ridge Waveguide Horn Antenna	3115	6914	EMCO	3 year	2017-12-15
5	Dual-Ridge Waveguide Horn Antenna	3116	2661	ETS-Lindgren	3 year	2017-06-30
6	Vector Signal Analyzer	FSV	101047	Rohde & Schwarz	1 year	2016-07-03
7	Semi-anechoic chamber	/	CT000332 -1074	Frankonia German	/	/

ANNEX A: Detailed Test Results

A.1. Measurement Method

A.1.1. Conducted Measurements

The measurement is made according to ANSI C63.10.

- 1). Connect the EUT to the test system correctly.
- 2). Set the EUT to the required work mode (Transmitter, receiver or transmitter & receiver).
- 3). Set the EUT to the required channel.
- 4). Set the EUT hopping mode (hopping or hopping off).
- 5). Set the spectrum analyzer to start measurement.
- 6). Record the values. Vector Signal Analyzer

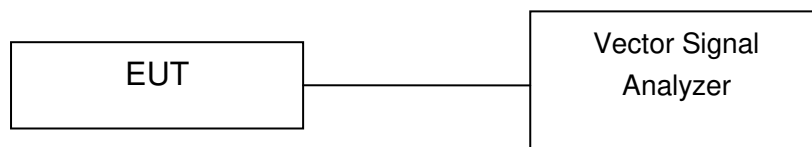

A.1.2. Radiated Emission Measurements

The measurement is made according to ANSI C63.10.

The radiated emission test is performed in semi-anechoic chamber. The distance from the EUT to the reference point of measurement antenna is 3m. The test is carried out on both vertical and horizontal polarization and only maximization result of both polarizations is kept. During the test, the turntable is rotated 360° and the measurement antenna is moved from 1m to 4m to get the maximization result.

In the case of radiated emission, the used settings are as follows,

Sweep frequency from 30 MHz to 1GHz, RBW = 100 kHz, VBW = 300 kHz;

Sweep frequency from 1 GHz to 26GHz, RBW = 1MHz, VBW = 1MHz;

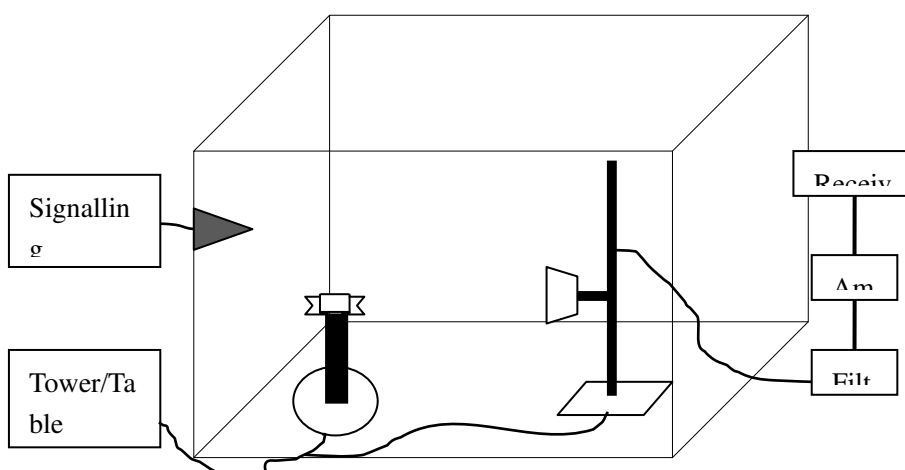



A.2. Peak Output Power - Conducted

Method of Measurement: See ANSI C63.10-clause 11.9.1.1

- a) Set the RBW = 3 MHz.
- b) Set VBW = 3 MHz.
- c) Set span = 5 MHz.
- d) Sweep time = auto couple.
- e) Detector = peak.
- f) Trace mode = max hold.
- g) Allow trace to fully stabilize.
- h) Use peak marker function to determine the peak amplitude level.

Measurement Limit:

Standard	Limit (dBm)
FCC Part 15.247(b)(1) & RSS-247 section 5.4	< 30

Measurement Results:

For GFSK

Channel No.	Frequency (MHz)	Peak Conducted Output Power (dBm)	Conclusion
0	2402	0.62	P
19	2440	0.73	P
39	2480	0.53	P

Conclusion: PASS

A.3. Frequency Band Edges - Conducted

Method of Measurement: See ANSI C63.10-clause 6.10.4

Connect the spectrum analyzer to the EUT using an appropriate RF cable connected to the EUT output. Configure the spectrum analyzer settings as described below.

- a) Set Span = 10MHz
- b) Sweep Time: coupled
- c) Set the RBW= 100 kHz
- c) Set the VBW= 300 kHz
- d) Detector: Peak
- e) Trace: Max hold

Observe the stored trace and measure the amplitude delta between the peak of the fundamental and the peak of the band-edge emission. This is not an absolute field strength measurement; it is only a relative measurement to determine the amount by which the emission drops at the band edge relative to the highest fundamental emission level.

Measurement Limit:

Standard	Limit (dBc)
FCC 47 CFR Part 15.247 (d) & RSS-247 section 5.5	< -20

Measurement Result:

For GFSK

Channel No.	Frequency (MHz)	Hopping	Band Edge Power (dBc)		Conclusion
0	2402	Hopping OFF	Fig.1	-37.82	P
39	2480	Hopping OFF	Fig.2	-37.90	P

Conclusion: PASS

Test graphs as below

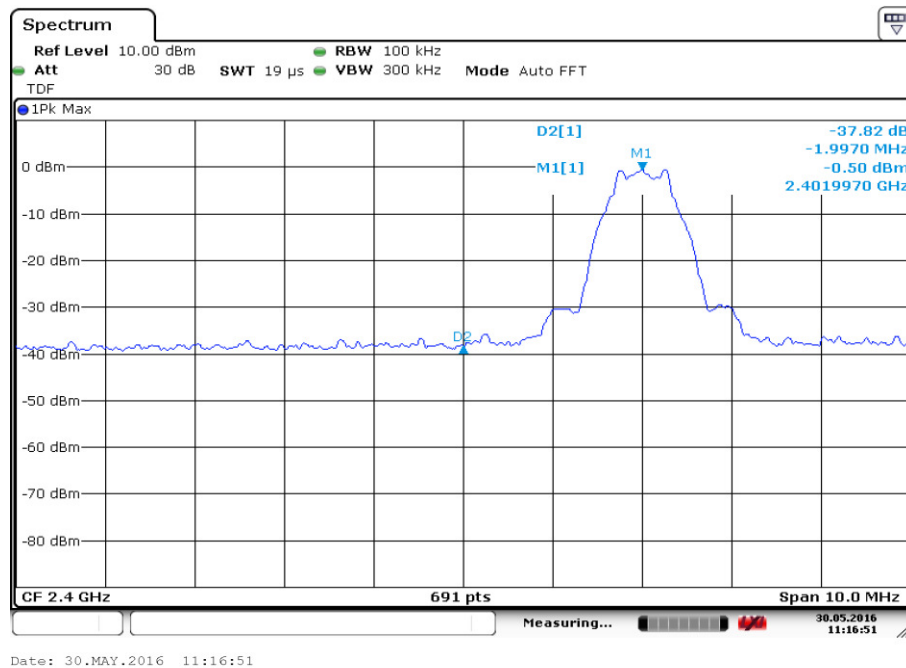

Fig.1. Frequency Band Edges: GFSK, 2402 MHz, Hopping Off

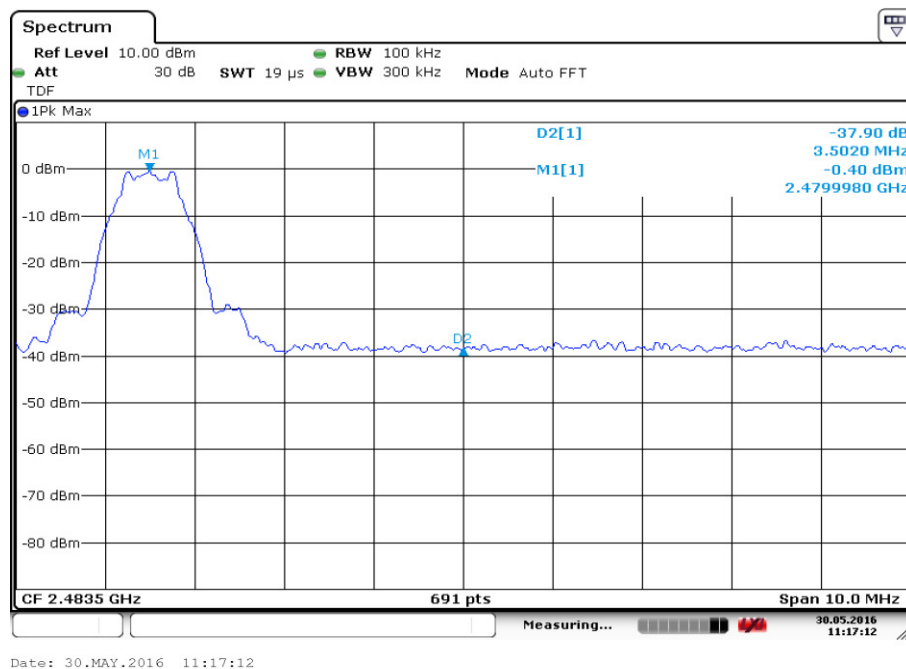

Fig.2. Frequency Band Edges: GFSK, 2480 MHz, Hopping Off



A.4. Transmitter Spurious Emission - Conducted

Method of Measurement: See ANSI C63.10-clause 11.11.2 and clause 11.11.3

Measurement Procedure – Reference Level

1. Set the RBW = 100 kHz.
2. Set the VBW = 300 kHz.
3. Set the span to ≥ 1.5 times the DTS bandwidth.
4. Detector = peak.
5. Sweep time = auto couple.
6. Trace mode = max hold.
7. Allow trace to fully stabilize.
8. Use the peak marker function to determine the maximum PSD level. Next, determine the power in 100 kHz band segments outside of the authorized frequency band using the following measurement:

Measurement Procedure - Unwanted Emissions

1. Set RBW = 100 kHz.
 2. Set VBW = 300 kHz.
 3. Set span to encompass the spectrum to be examined.
 4. Detector = peak.
 5. Trace Mode = max hold.
 6. Sweep = auto couple.
 7. Allow the trace to stabilize (this may take some time, depending on the extent of the span).
- Ensure that the amplitude of all unwanted emissions outside of the authorized frequency band (excluding restricted frequency bands) is attenuated by at least the minimum requirements specified above.

Measurement Limit:

Standard	Limit
FCC 47 CFR Part 15.247 (d) & RSS-247 section 5.5	20dB below peak output power in 100 kHz bandwidth

Measurement Results:
For GFSK

Channel No.	Frequency (MHz)	Frequency Range	Test Results	Conclusion
0	2402	Center Frequency	Fig.3	P
		30 MHz-3 GHz	Fig.4	P
		3GHz-18GHz	Fig.5	P
19	2440	Center Frequency	Fig.6	P
		30 MHz-3 GHz	Fig.7	P
		3GHz-18GHz	Fig.8	P
39	2480	Center Frequency	Fig.9	P
		30 MHz-3 GHz	Fig.10	P
		3GHz-18GHz	Fig.11	P
All Channels		18GHz-26GHz	Fig.12	P

Conclusion: PASS

Test graphs as below

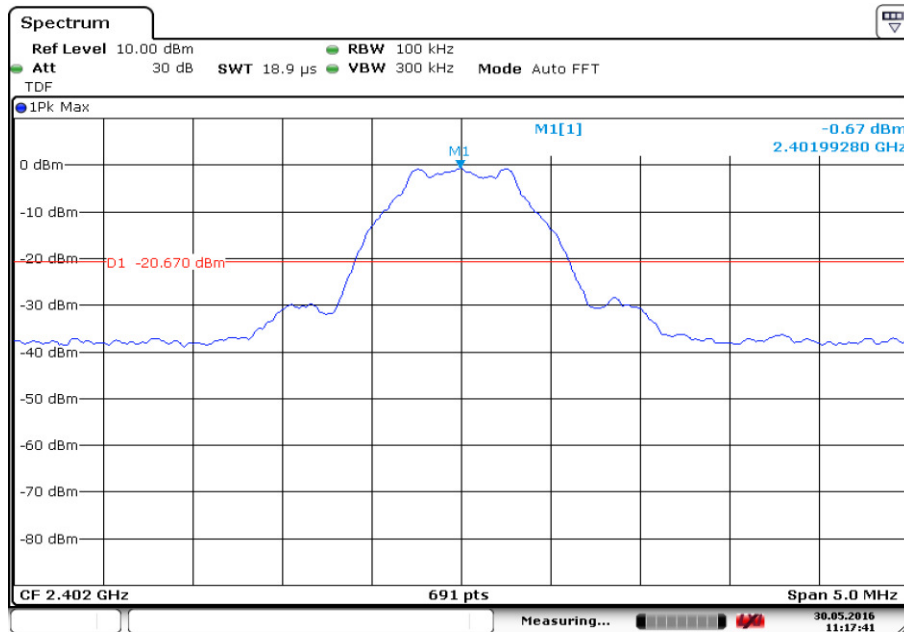

Fig.3. Conducted Spurious Emission (Ch0, Center Frequency)

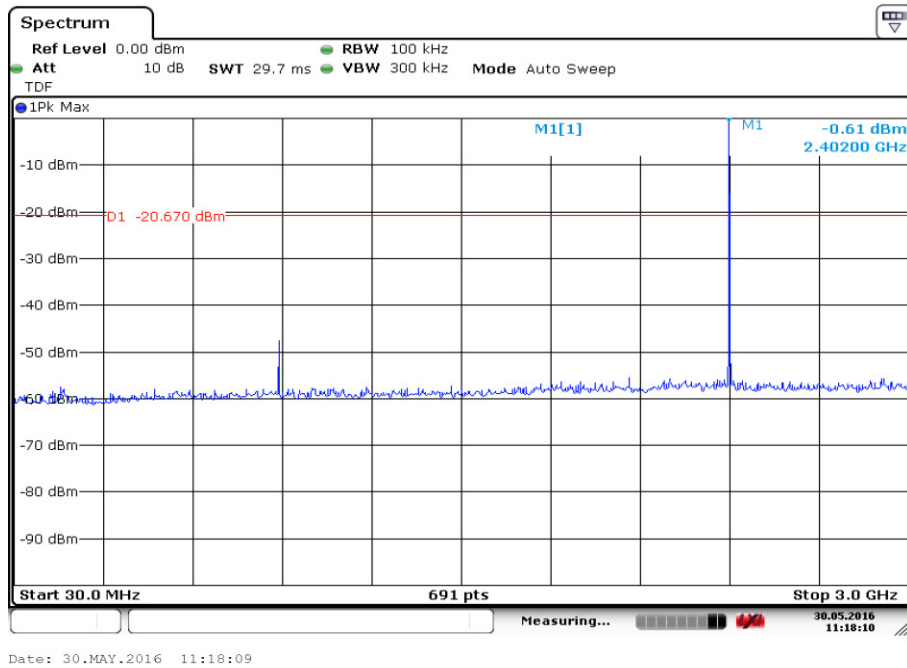

Fig.4. Conducted Spurious Emission (Ch0, 30 MHz-3 GHz)

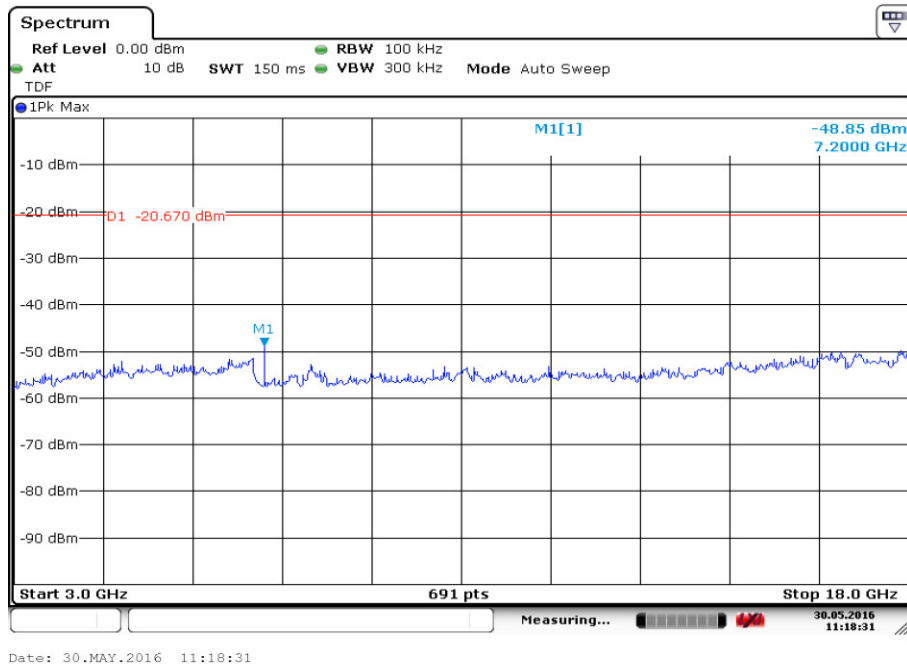
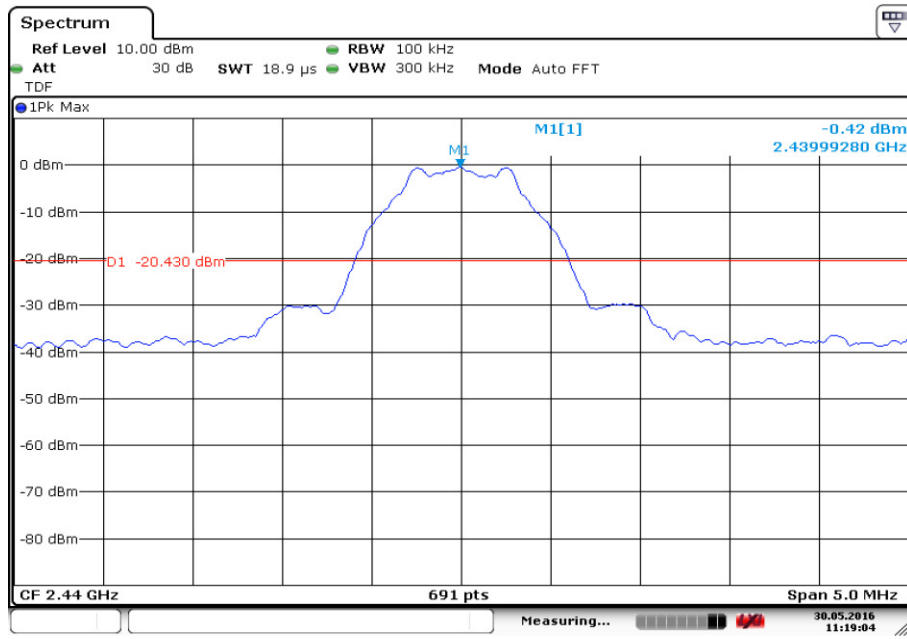
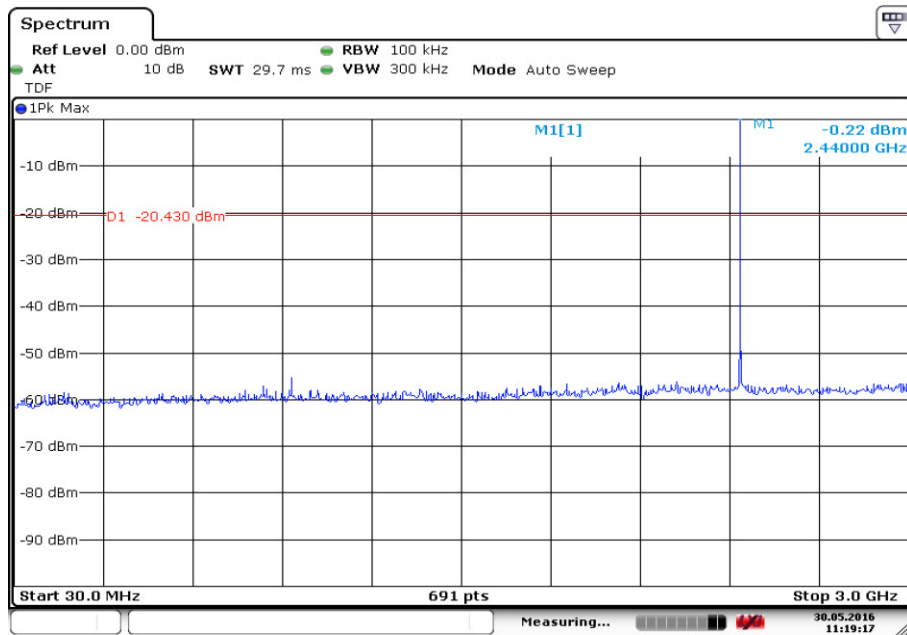

Fig.5. Conducted Spurious Emission (Ch0, 3 GHz-18 GHz)



Date: 30.MAY.2016 11:19:03

Fig.6. Conducted Spurious Emission (Ch19, Center Frequency)



Date: 30.MAY.2016 11:19:17

Fig.7. Conducted Spurious Emission (Ch19, 30 MHz-3 GHz)

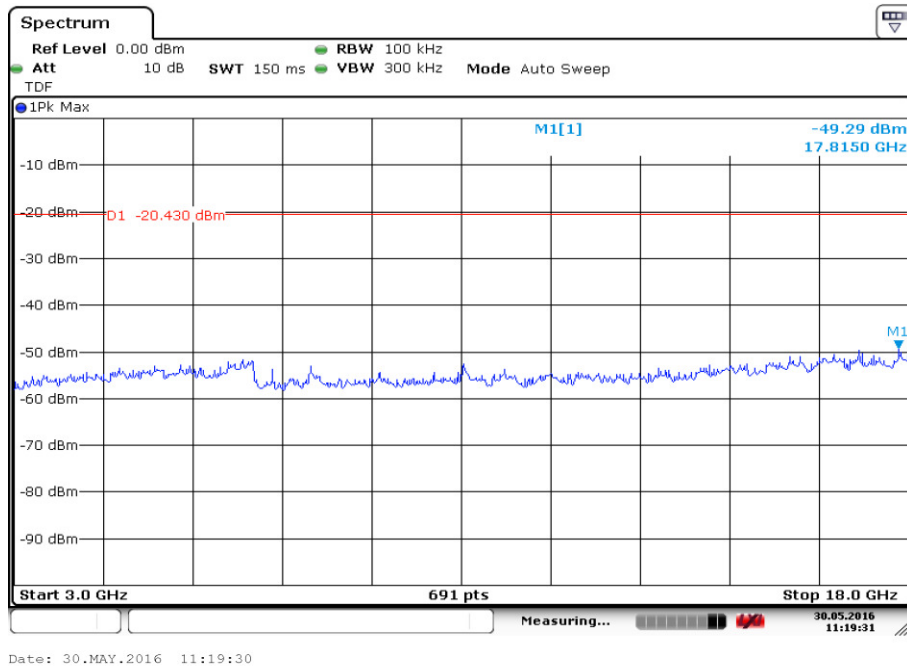

Fig.8. Conducted Spurious Emission (Ch19, 3 GHz-18 GHz)

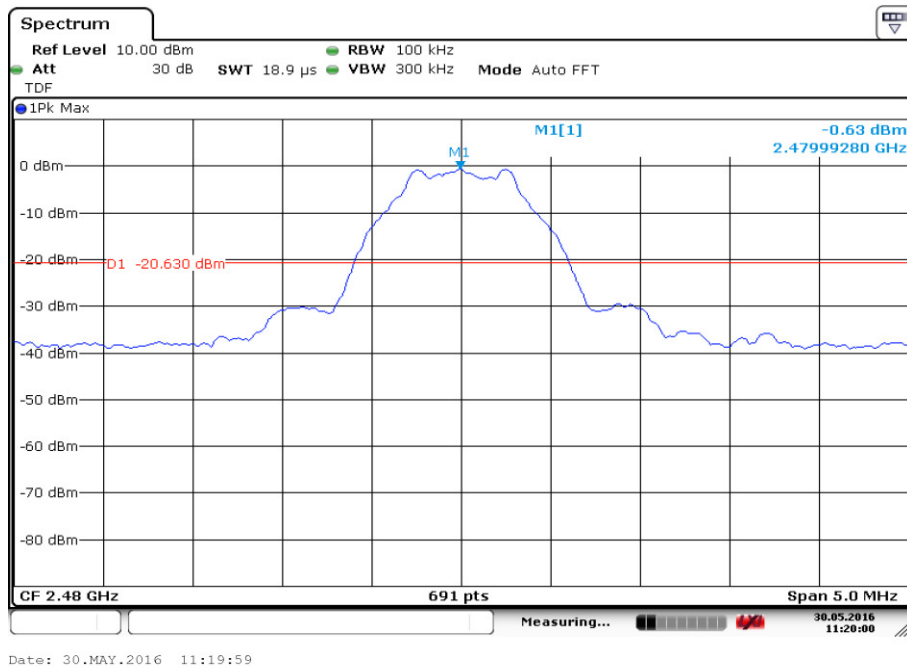
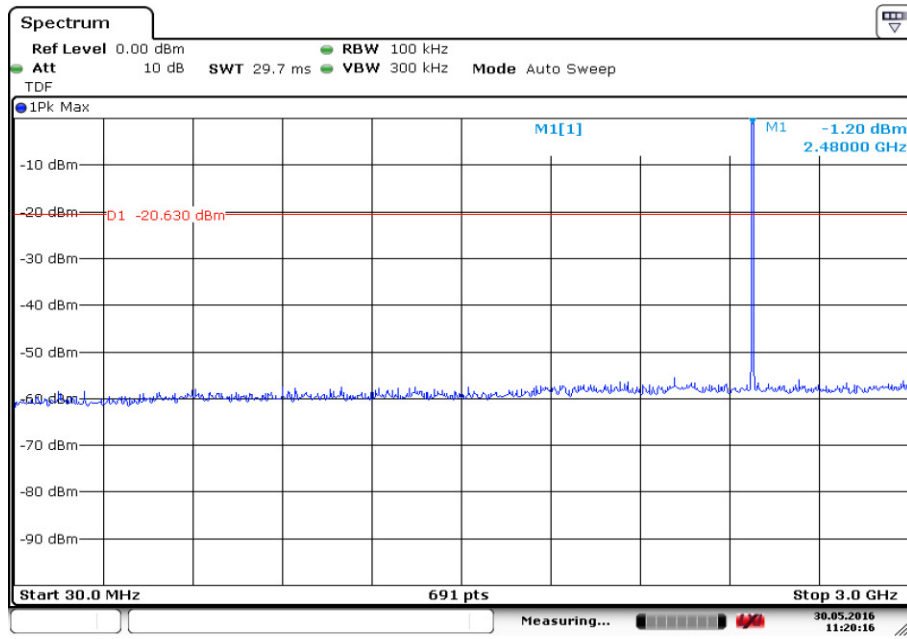
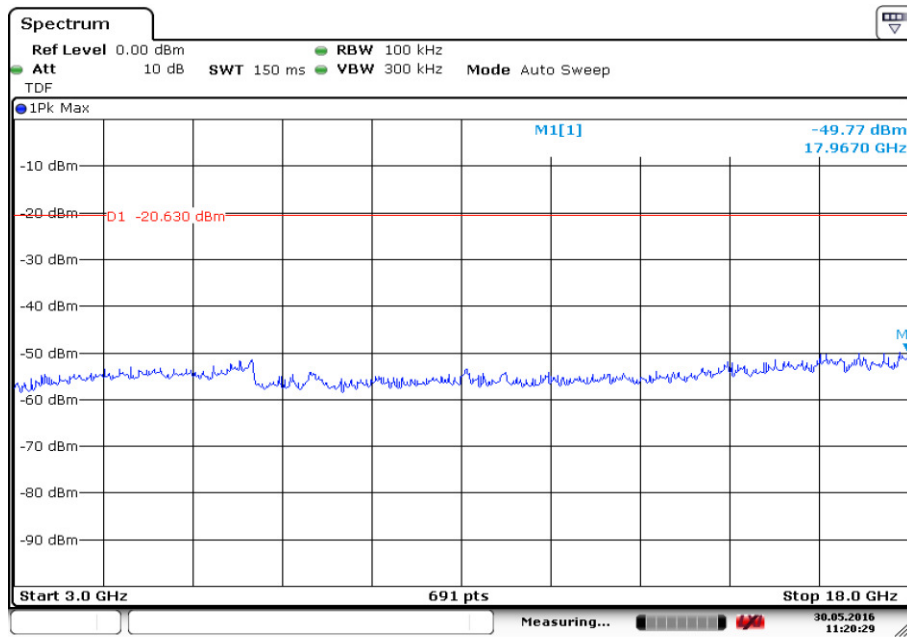

Fig.9. Conducted Spurious Emission (Ch39, Center Frequency)



Date: 30.MAY.2016 11:20:15

Fig.10. Conducted Spurious Emission (Ch39, 30 MHz-3 GHz)



Date: 30.MAY.2016 11:20:29

Fig.11. Conducted Spurious Emission (Ch39, 3 GHz-18 GHz)

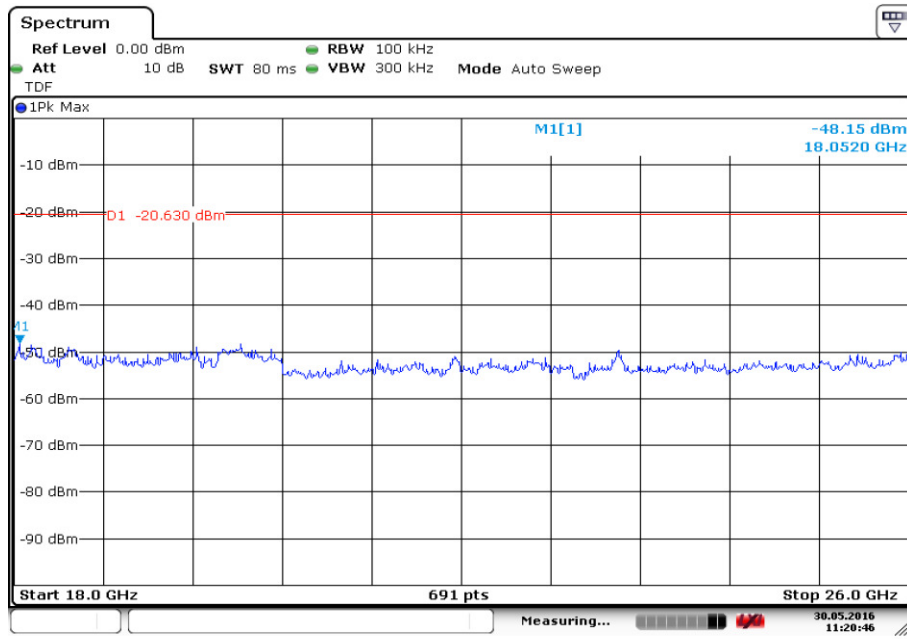

Date: 30.MAY.2016 11:20:46

Fig.12. Conducted Spurious Emission (All channels, 18 GHz-26 GHz)

A.5. Transmitter Spurious Emission - Radiated

Measurement Limit:

Standard	Limit
FCC 47 CFR Part 15.247, 15.205, 15.209 & RSS-247 section 5.5	20dB below peak output power

In addition, radiated emissions which fall in the restricted bands, as defined in § 15.205(a), must also comply with the radiated emission limits specified in § 15.209(a) (see § 15.205(c)).

The measurement is made according to ANSI C63.10

Limit in restricted band:

Frequency of emission (MHz)	Field strength(uV/m)	Field strength(dBuV/m)
30-88	100	40
88-216	150	43.5
216-960	200	46
Above 960	500	54

Test Condition

The EUT was placed on a non-conductive table. The measurement antenna was placed at a distance of 3 meters from the EUT. During the tests, the antenna height and the EUT azimuth were varied in order to identify the maximum level of emissions from the EUT. This maximization process was repeated with the EUT positioned in each of its three orthogonal orientations.

Frequency of emission (MHz)	RBW/VBW	Sweep Time(s)
30-1000	100KHz/300KHz	5
1000-4000	1MHz/1MHz	15
4000-18000	1MHz/1MHz	40
18000-26500	1MHz/1MHz	20

Measurement Results:

A "reference path loss" is established and the A_{Rpl} is the attenuation of "reference path loss", and including the gain of receive antenna, the gain of the preamplifier, the cable los.

The measurement results are obtained as described below:

For GFSK

Mode	Channel	Frequency Range	Test Results	Conclusion
GFSK	0	1 GHz ~18 GHz	Fig.13	P
	19	9kHz~30MHz	Fig.14	P
		30MHz~1GHz	Fig.15	P
		1 GHz ~18 GHz	Fig.16	P
	39	1 GHz ~18 GHz	Fig.17	P
	Power(CH0)	2.38 GHz ~ 2.45 GHz	Fig.18	P
	Power(CH78)	2.45 GHz ~ 2.5 GHz	Fig.19	P
/	All channels	18 GHz~ 26.5 GHz	Fig.20	P

GFSK CH0 (1-18GHz)

Frequency (MHz)	MaxPeak-ClearWrite (dB μ V/m)	Polarization	Corr. (dB)	Margin (dB)	Limit (dB μ V/m)
14552.000000	55.4	H	11.9	18.6	74.0
15172.000000	56.1	H	12.1	17.9	74.0
15674.000000	58.2	H	12.6	15.8	74.0
16238.500000	59.0	V	13.2	15.0	74.0
16803.000000	59.1	V	13.9	14.9	74.0
17406.500000	59.0	H	14.0	15.0	74.0

Frequency (MHz)	Average-ClearWrite (dB μ V/m)	Polarization	Corr. (dB)	Margin (dB)	Limit (dB μ V/m)
14546.000000	43.6	H	11.9	10.4	54.0
15163.500000	44.8	H	12.1	9.2	54.0
15735.500000	46.3	H	12.7	7.7	54.0
16243.500000	46.7	H	13.2	7.3	54.0
16751.000000	47.5	V	13.9	6.5	54.0
17292.000000	46.7	H	13.9	7.3	54.0

GFSK CH19 (1-18GHz)

Frequency (MHz)	MaxPeak-ClearWrite (dB μ V/m)	Polarization	Corr. (dB)	Margin (dB)	Limit (dB μ V/m)
14040.000000	55.9	V	10.9	18.1	74.0
15087.500000	56.7	H	12.1	17.3	74.0
15688.500000	57.8	H	12.7	16.2	74.0
16232.500000	58.2	V	13.1	15.8	74.0
16845.000000	59.5	H	13.9	14.5	74.0
17398.000000	58.8	H	14.0	15.2	74.0

Frequency (MHz)	Average-ClearWrite (dB μ V/m)	Polarization	Corr. (dB)	Margin (dB)	Limit (dB μ V/m)
14528.500000	43.9	H	11.8	10.1	54.0
15163.500000	44.8	V	12.1	9.2	54.0
15679.500000	46.5	H	12.6	7.5	54.0
16208.000000	46.7	H	13.1	7.3	54.0
16724.000000	47.4	H	13.8	6.6	54.0
17279.500000	47.1	H	13.9	6.9	54.0



GFSK CH39 (1-18GHz)

Frequency (MHz)	MaxPeak-ClearWrite (dB μ V/m)	Polarization	Corr. (dB)	Margin (dB)	Limit (dB μ V/m)
14057.000000	56.5	V	11.0	17.5	74.0
14639.500000	57.1	V	11.9	16.9	74.0
15678.500000	58.4	H	12.6	15.6	74.0
16229.500000	58.9	H	13.1	15.1	74.0
16823.000000	59.4	H	13.9	14.6	74.0
17352.000000	58.8	H	14.0	15.2	74.0

Frequency (MHz)	Average-ClearWrite (dB μ V/m)	Polarization	Corr. (dB)	Margin (dB)	Limit (dB μ V/m)
14542.500000	43.9	V	11.9	10.1	54.0
15137.000000	45.0	V	12.1	9.0	54.0
15744.000000	46.5	H	12.8	7.5	54.0
16215.500000	46.8	V	13.1	7.2	54.0
16773.000000	47.5	H	13.9	6.5	54.0
17287.500000	47.0	H	13.9	7.0	54.0

Conclusion: PASS

Test graphs as below:

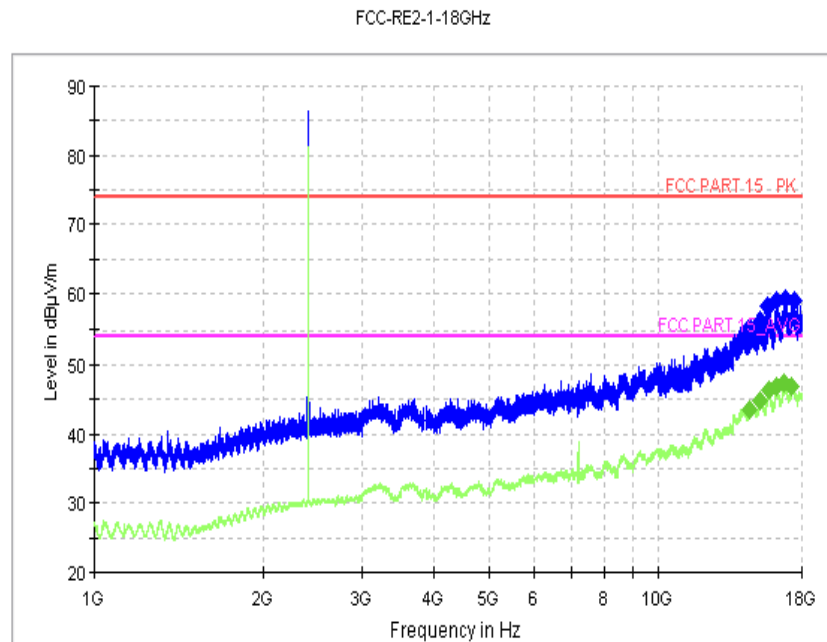

Fig.13. Radiated Spurious Emission (GFSK, Ch0, 1 GHz ~18 GHz)

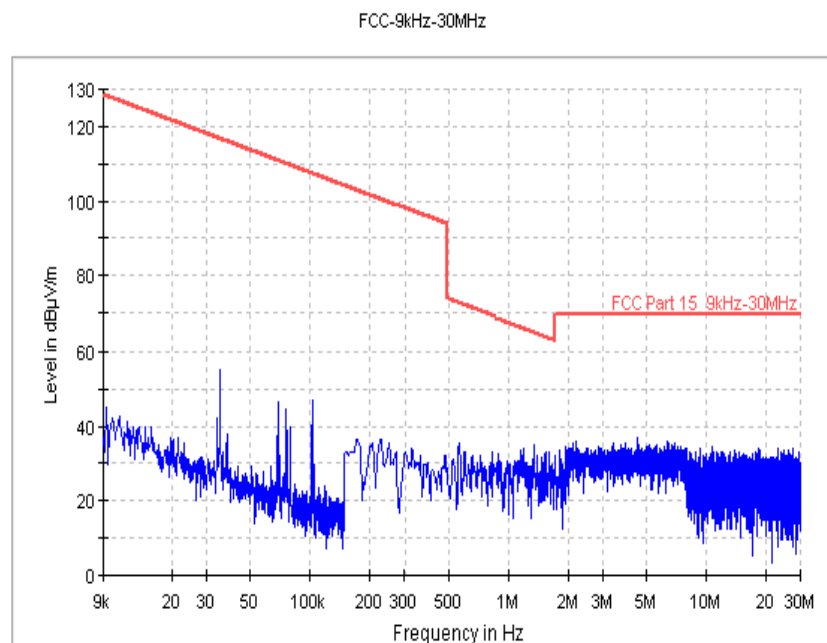

Fig.14. Radiated Spurious Emission (Ch19, 9 kHz-30 MHz)

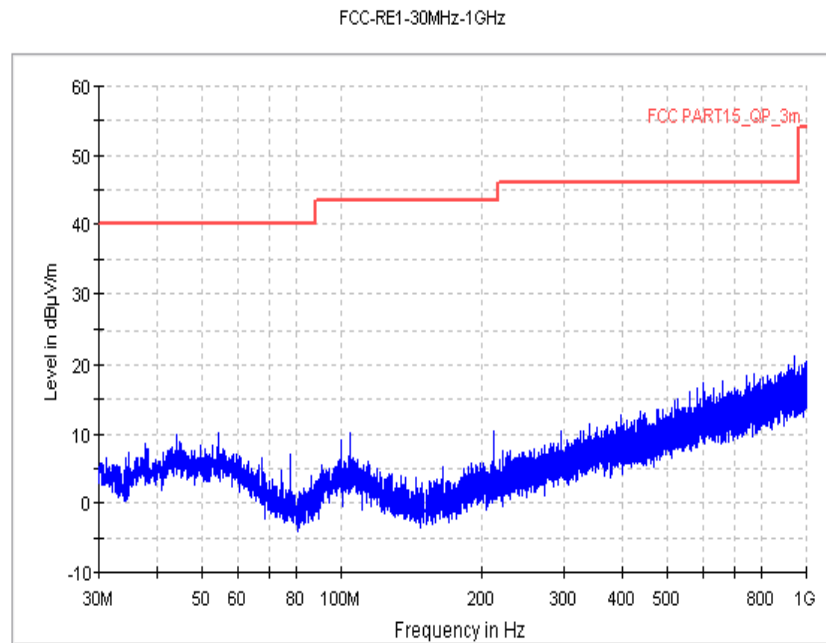

Fig.15. Radiated Spurious Emission (Ch19, 30 MHz-1 GHz)

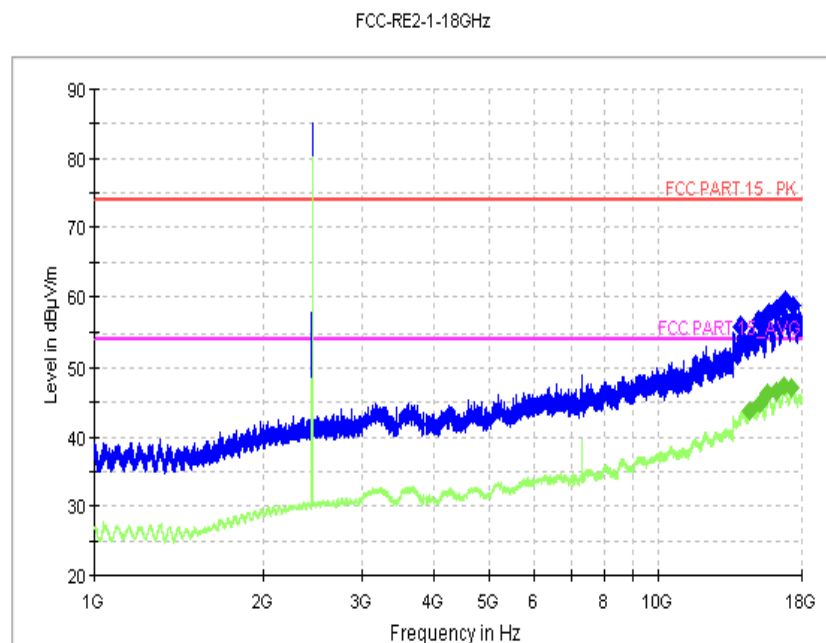

Fig.16. Radiated Spurious Emission (Ch19, 1 GHz-18 GHz)

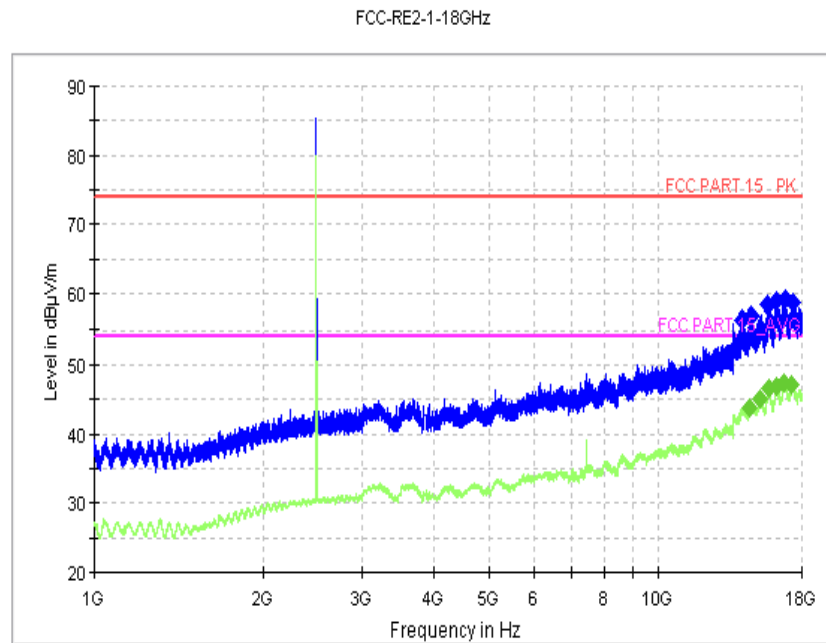

Fig.17. Radiated Spurious Emission (Ch39, 1 GHz-18 GHz)

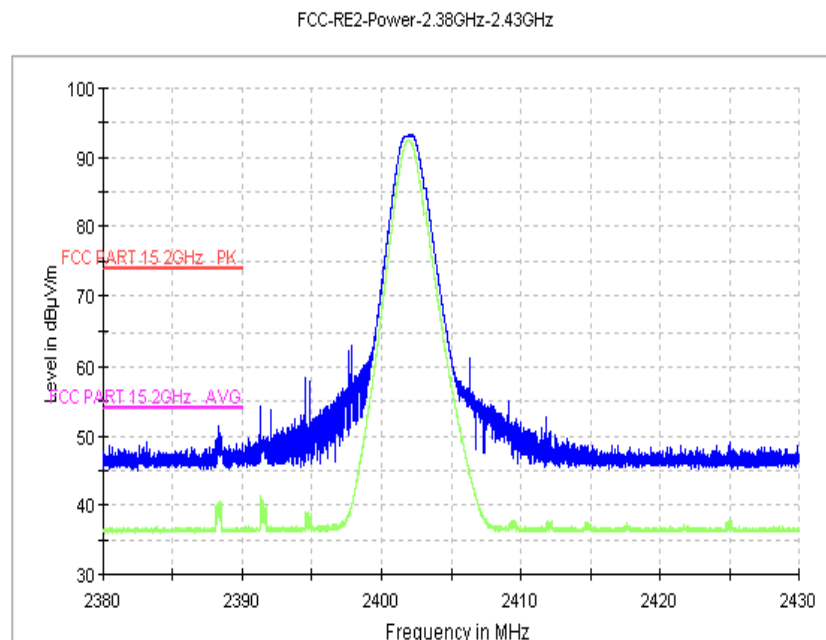

Fig.18. Radiated Emission Power (GFSK, Ch0, 2380MHz~2430MHz)

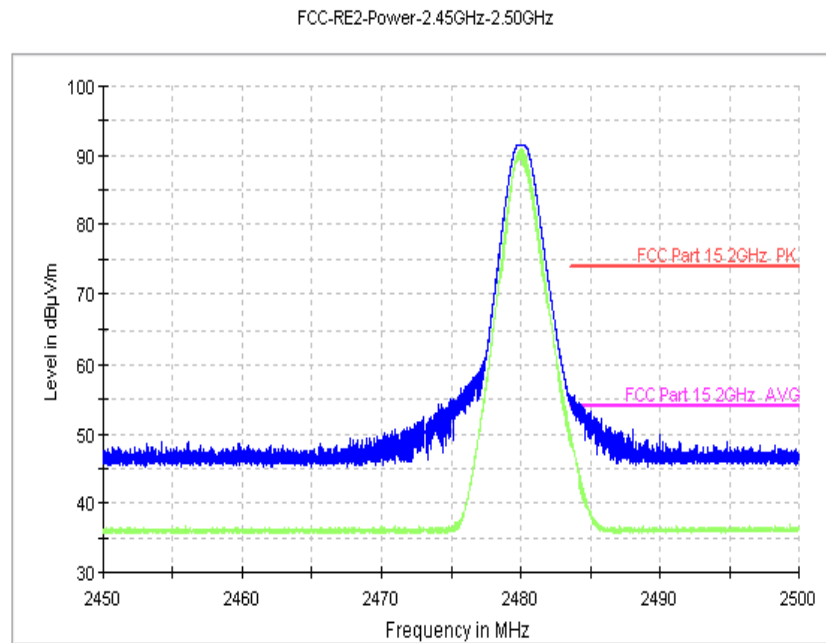

Fig.19. Radiated Emission Power (GFSK, Ch39, 2450MHz~2500MHz)

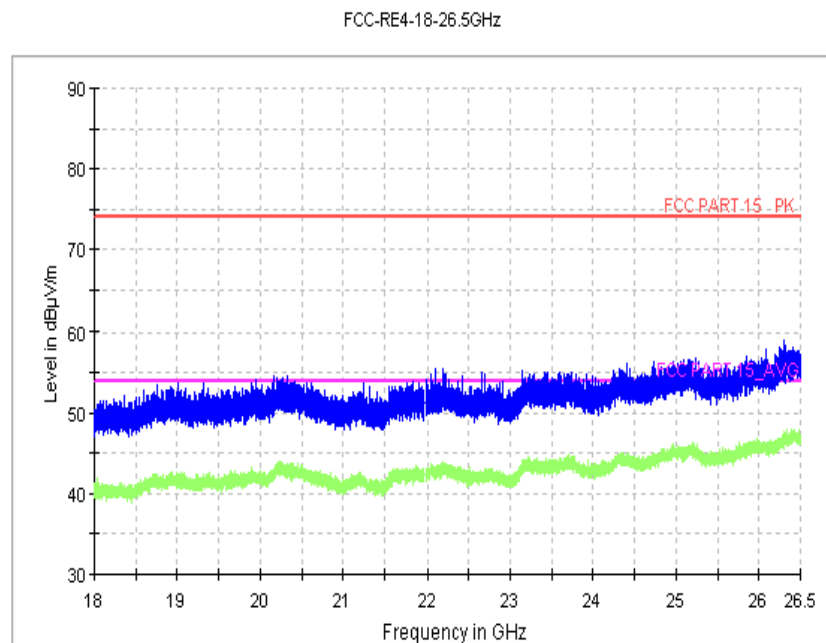

Fig.20. Radiated emission: 18 GHz – 26.5 GHz



A.6. 6dB Bandwidth

Method of Measurement:

The measurement is made according to ANSI C63.10 clause 11.8.1

1. Set RBW = 100 kHz.
2. Set the video bandwidth (VBW) = 300 kHz.
3. Detector = Peak.
4. Trace mode = max hold.
5. Sweep = auto couple.
6. Allow the trace to stabilize.
7. Measure the maximum width of the emission that is constrained by the frequencies associated with the two outermost amplitude points (upper and lower frequencies) that are attenuated by 6 dB relative to the maximum level measured in the fundamental emission.

Measurement Limit:

Standard	Limit
FCC 47 CFR Part 15.247(a)(2) & RSS-247 section 5.2(1)	$\geq 500\text{KHz}$

Measurement Results:

For GFSK

Channel No.	Frequency (MHz)	6dB Bandwidth (kHz)		Conclusion
0	2402	Fig.21	701.9	P
19	2440	Fig.22	701.9	P
39	2480	Fig.23	694.6	P

Conclusion: PASS

Test graphs as below:

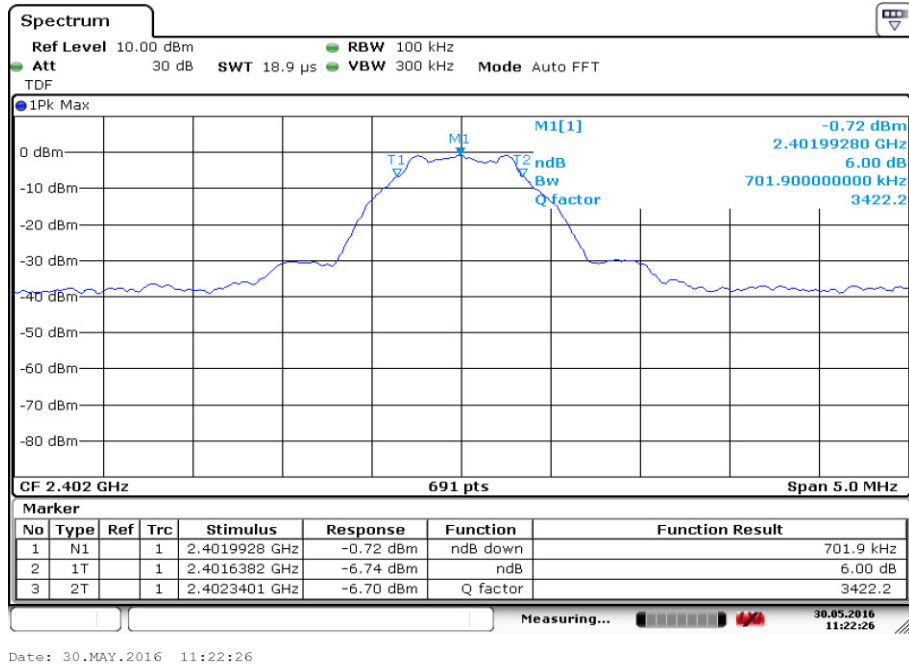

Fig.21. 6dB Bandwidth: GFSK, 2402 MHz

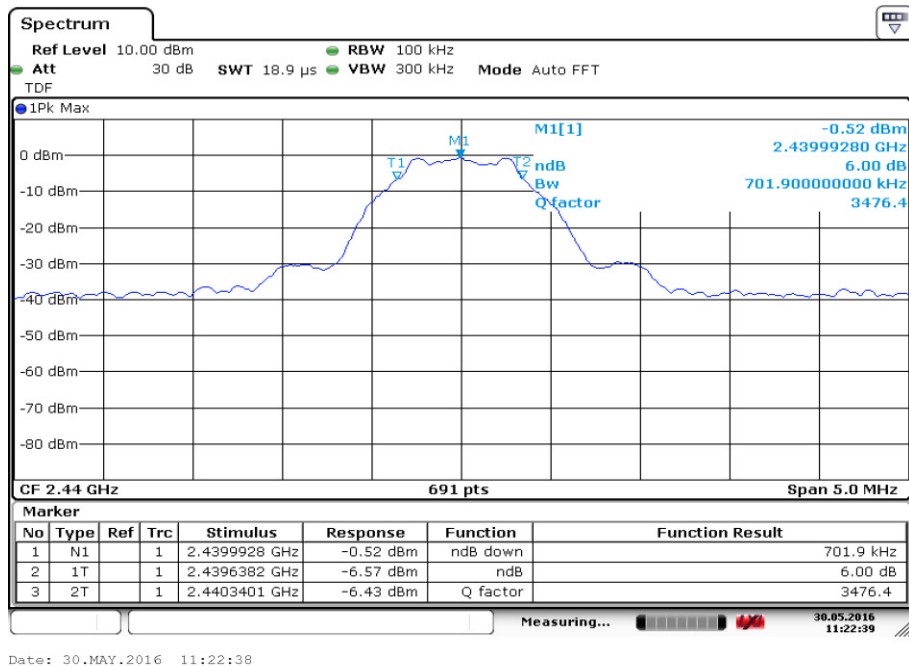
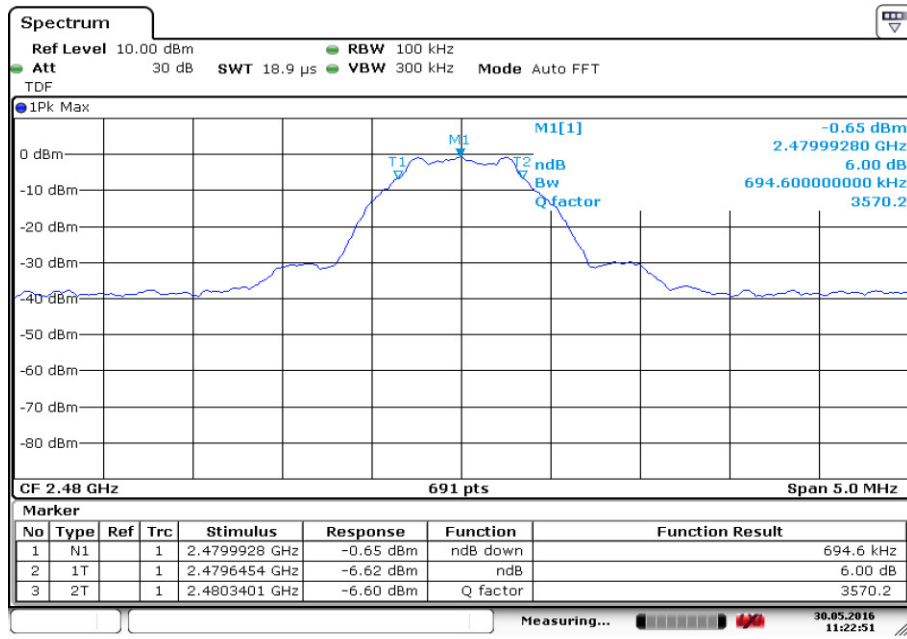

Fig.22. 6dB Bandwidth: GFSK, 2440 MHz



Date: 30.MAY.2016 11:22:51

Fig.23. 6dB Bandwidth: GFSK, 2480 MHz

A.7. Maximum Power Spectral Density Level

Method of Measurement:

The measurement is made according to ANSI C63.10 clause 11.10.2

1. Set the RBW = 3 kHz.
2. Set the VBW = 10 kHz.
3. Set the span to 2 times the DTS bandwidth.
4. Detector = peak.
5. Sweep time = auto couple.
6. Trace mode = max hold.
7. Allow trace to fully stabilize.
8. Use the peak marker function to determine the maximum amplitude level within the RBW.

Measurement Limit:

Standard	Limit
FCC 47 CFR Part 15.247(e) & RSS-247 section 5.2(2)	$\leq 8.0\text{dBm}/3\text{kHz}$

Measurement Results:

For GFSK

Channel No.	Frequency (MHz)	Maximum Power Spectral Density Level(dBm/3kHz)		Conclusion
		Fig.	Level	
0	2402	Fig.24	-15.51	P
19	2440	Fig.25	-15.37	P
39	2480	Fig.26	-15.51	P

Test graphs as below:

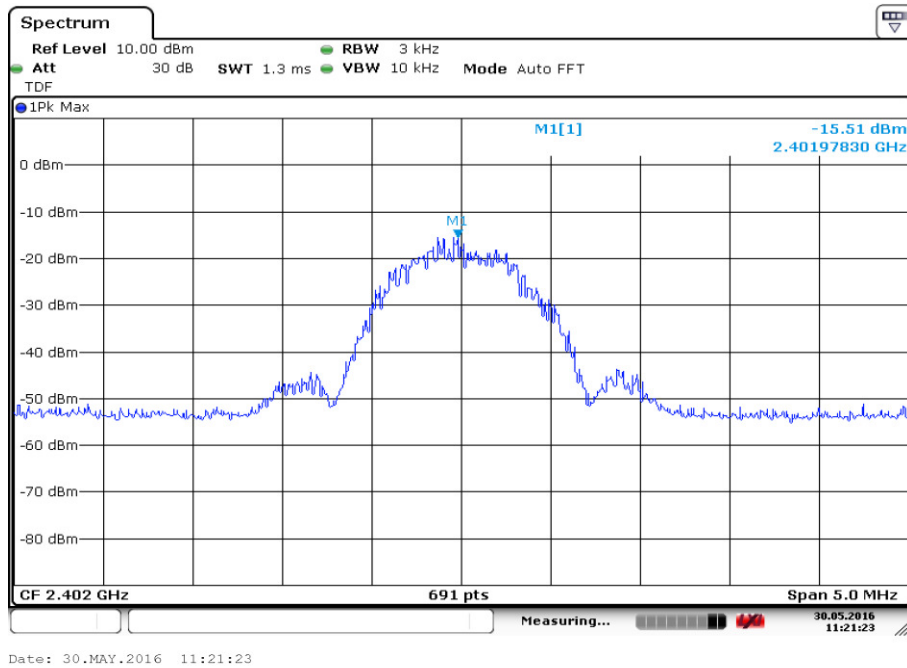

Fig.24. Maximum Power Spectral Density Level Function: GFSK, 2402 MHz

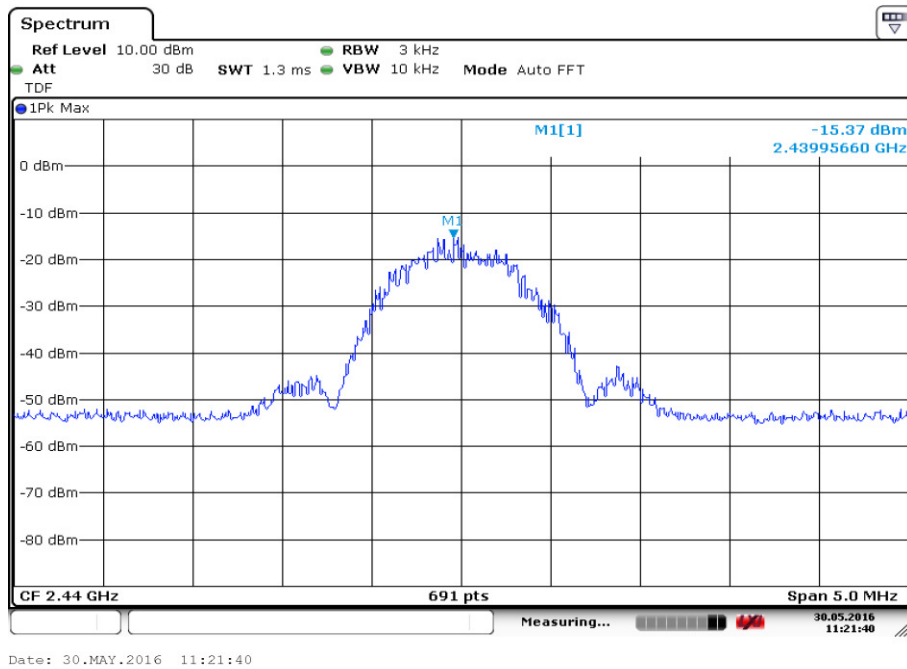
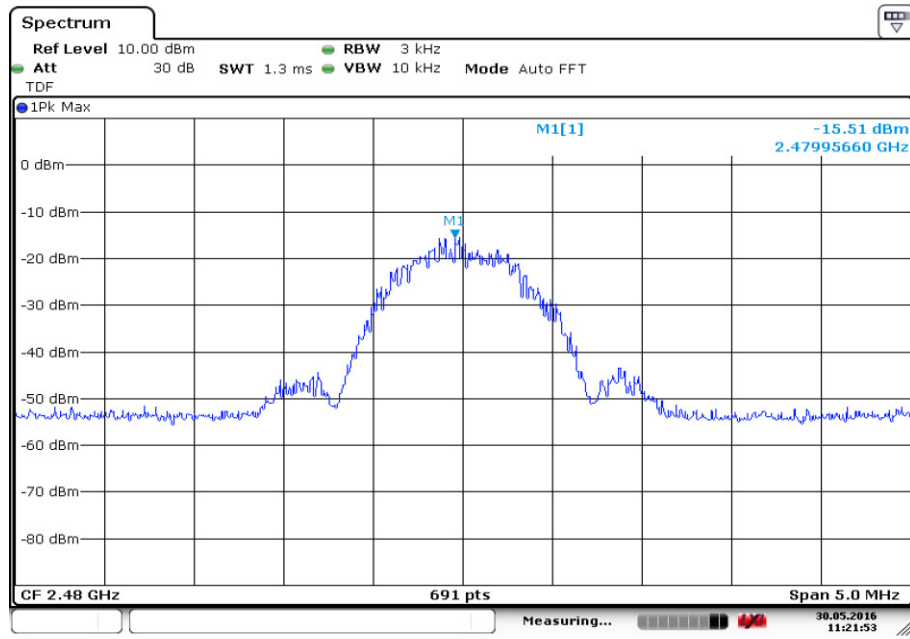

Fig.25. Maximum Power Spectral Density Level Function: GFSK, 2440 MHz



Date: 30.MAY.2016 11:21:53

Fig.26. Maximum Power Spectral Density Level Function: GFSK, 2480 MHz

A.8. Occupied Bandwidth

Method of Measurement:

The measurement is made according to ANSI C63.10 clause 11.8.1

1. Set RBW = 100 kHz.
2. Set the video bandwidth (VBW) = 300 kHz.
3. Detector = Peak.
4. Trace mode = max hold.
5. Sweep = auto couple.
6. Allow the trace to stabilize.
7. Measure the maximum width of the emission that is constrained by the frequencies associated with the two outermost amplitude points (upper and lower frequencies) that are attenuated by 6 dB relative to the maximum level measured in the fundamental emission.

Measurement Limit:

Standard	Limit
RSS-Gen Issue4 6.6	NA *

Measurement Results:

For GFSK

Channel No.	Frequency (MHz)	6dB Bandwidth (kHz)		Conclusion
0	2402	Fig.27	1049.2	NA
19	2440	Fig.28	1049.2	NA
39	2480	Fig.29	1049.2	NA

Conclusion: NA

Test graphs as below:

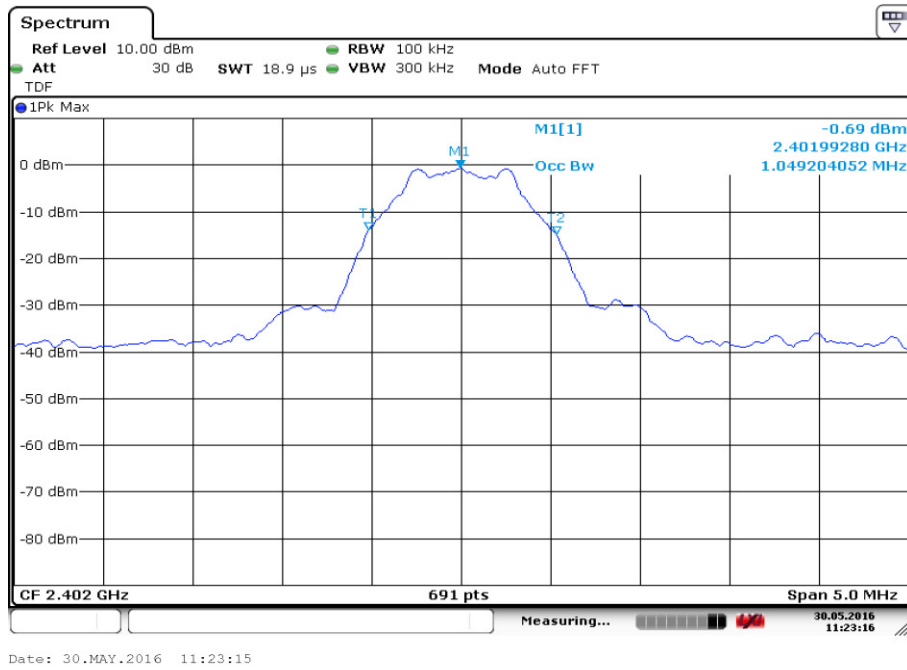

Fig.27. Occupied Bandwidth: GFSK, 2402 MHz

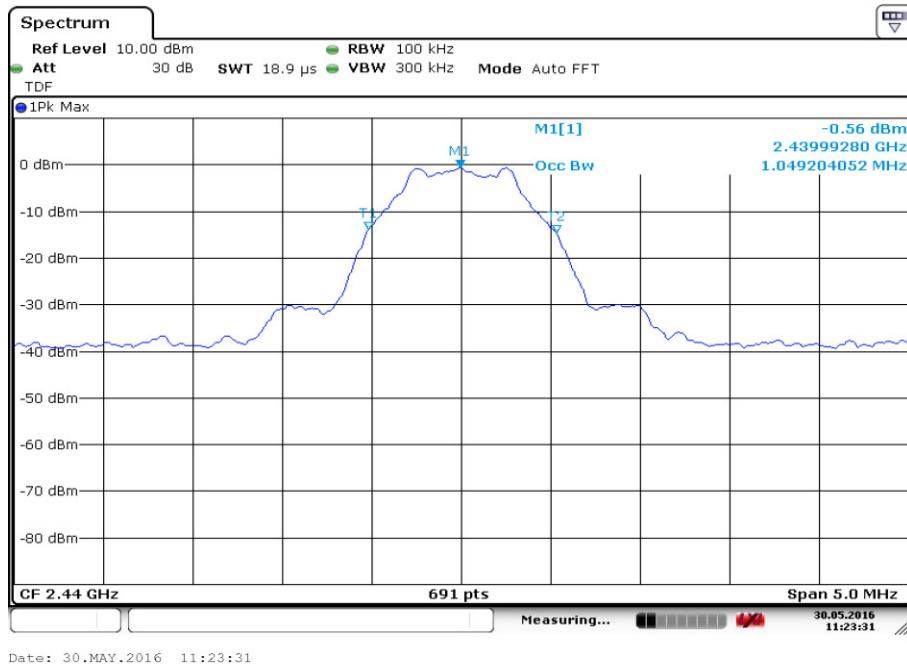
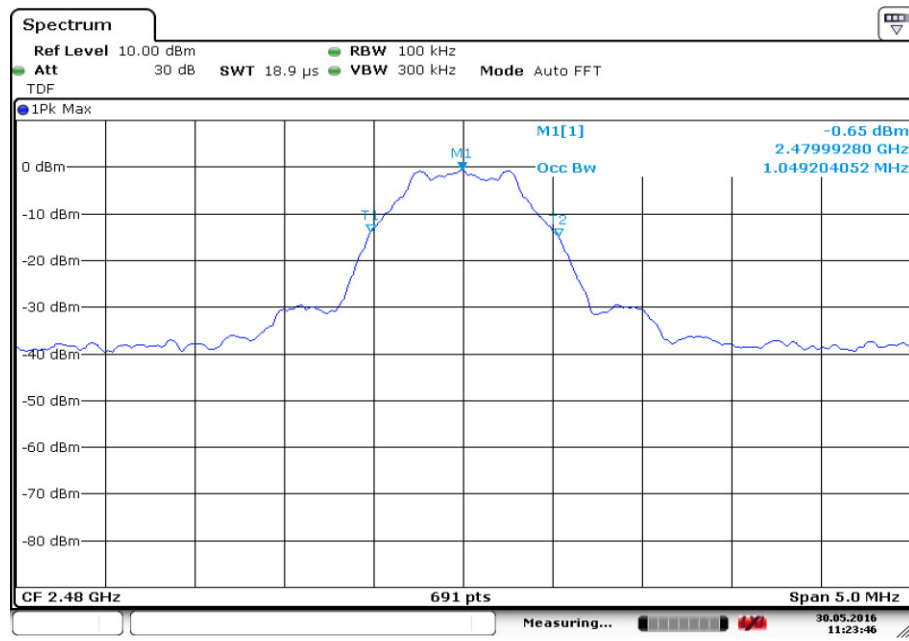

Fig.28. Occupied Bandwidth: GFSK, 2440 MHz



Date: 30.MAY.2016 11:23:45

Fig.29. Occupied Bandwidth: GFSK, 2480 MHz

A.9. AC Powerline Conducted Emission

Method of Measurement: See ANSI C63.10-clause 6.2

1. the one EUT cable configuration and arrangement and mode of operation that produced the emission with the highest amplitude relative to the limit is selected for the final measurement, while applying the appropriate modulating signal to the EUT.
2. If the EUT is relocated from an exploratory test site to a final test site, the highest emissions shall be remaximized at the final test location before final ac power-line conducted emission measurements are performed.
3. The final test on all current-carrying conductors of all of the power cords to the equipment that comprises the EUT (but not the cords associated with other non-EUT equipment in the system) is then performed for the full frequency range for which the EUT is being tested for compliance without further variation of the EUT arrangement, cable positions, or EUT mode of operation.
4. If the EUT is comprised of equipment units that have their own separate ac power connections, e.g., floor-standing equipment with independent power cords for each shelf that are able to connect directly to the ac power network, each current-carrying conductor of one unit is measured while the other units are connected to a second (or more) LISN(s). All units shall be separately measured. If a power strip is provided by the manufacturer, to supply all of the units making up the EUT, only the conductors in the power cord of the power strip shall be measured.
5. If the EUT uses a detachable antenna, these measurements shall be made with a suitable dummy load connected to the antenna output terminals; otherwise, the tests shall be made with the antenna connected and, if adjustable, fully extended. When measuring the ac conducted emissions from a device that operates between 150 kHz and 30 MHz a non-detachable antenna may be replaced with a dummy load for the measurements within the fundamental emission band of the transmitter, but only for those measurements.³⁶ Record the six highest EUT emissions relative to the limit of each of the current-carrying conductors of the power cords of the equipment that comprises the EUT over the frequency range specified by the procuring or regulatory agency. Diagram or photograph the test setup that was used. See Clause 8 for full reporting requirements.

Test Condition

Voltage (V)	Frequency (Hz)
120	60

Measurement Result and limit:

Bluetooth (Quasi-peak Limit)

Frequency range (MHz)	Quasi-peak Limit (dB μ V)	Conclusion
0.15 to 0.5	66 to 56	P
0.5 to 5	56	
5 to 30	60	

NOTE: The limit decreases linearly with the logarithm of the frequency in the range 0.15 MHz to 0.5 MHz.



Bluetooth (Average Limit)

Frequency range (MHz)	Average Limit (dB μ V)	Conclusion
0.15 to 0.5	56 to 46	P
0.5 to 5	46	
5 to 30	50	

NOTE: The limit decreases linearly with the logarithm of the frequency in the range 0.15 MHz to 0.5 MHz.

The measurement is made according to ANSI C63.10

Conclusion: PASS

Test graphs as below:

Traffic:

ESH2-Z5 Scan-FCC

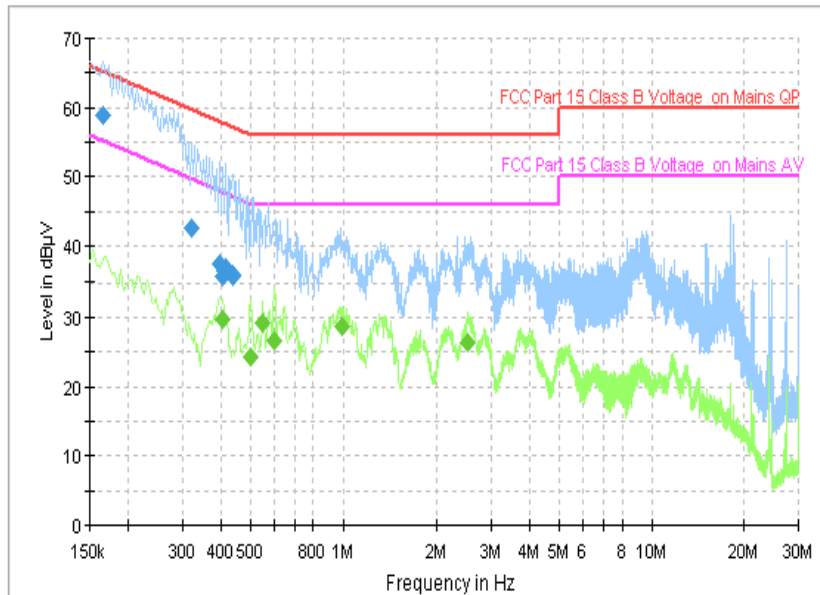

Final Result 1

Frequency (MHz)	QuasiPeak (dBuV)	PE	Line	Corr. (dB)	Margin (dB)	Limit (dBuV)
0.166000	58.8	GND	L1	10.0	6.3	65.2
0.322000	42.5	GND	L1	10.0	17.1	59.7
0.398000	37.4	GND	L1	10.0	20.5	57.9
0.406000	35.8	GND	L1	10.0	21.9	57.7
0.414000	37.0	GND	L1	10.0	20.6	57.6
0.438000	36.0	GND	L1	10.0	21.1	57.1

Final Result 2

Frequency (MHz)	Average (dBuV)	PE	Line	Corr. (dB)	Margin (dB)	Limit (dBuV)
0.406000	29.8	GND	L1	10.0	18.0	47.7
0.502000	24.3	GND	L1	10.0	21.7	46.0
0.550000	29.3	GND	L1	10.1	16.7	46.0
0.598000	26.7	GND	L1	10.1	19.3	46.0
0.994000	28.6	GND	L1	10.1	17.4	46.0
2.514000	26.2	GND	L1	10.2	19.8	46.0

Idle:

ESH2-Z5 Scan-FCC

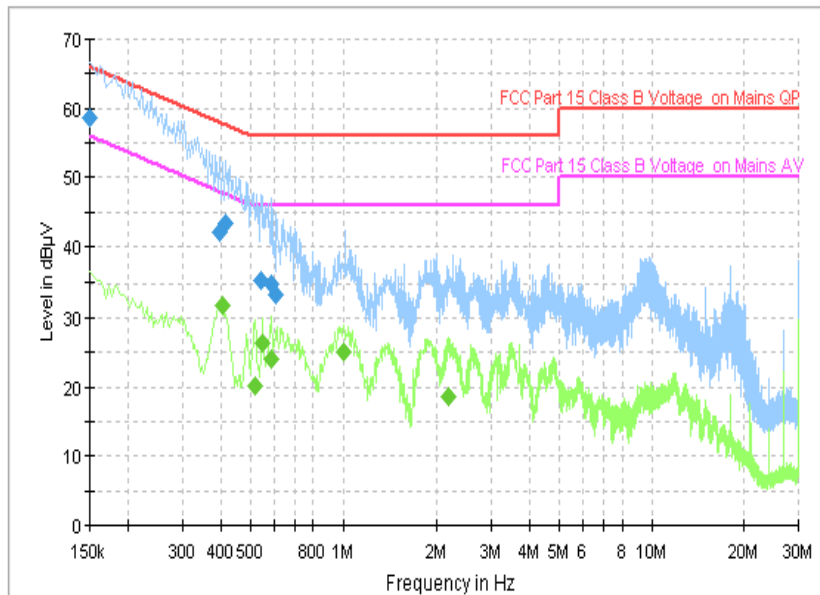

Final Result 1

Frequency (MHz)	QuasiPeak (dBuV)	PE	Line	Corr. (dB)	Margin (dB)	Limit (dBuV)
0.150000	58.6	GND	L1	10.0	7.4	66.0
0.398000	42.1	GND	L1	10.0	15.8	57.9
0.414000	43.4	GND	L1	10.0	14.2	57.6
0.542000	35.4	GND	L1	10.1	20.6	56.0
0.582000	34.8	GND	L1	10.1	21.2	56.0
0.606000	33.4	GND	L1	10.0	22.6	56.0

Final Result 2

Frequency (MHz)	Average (dBuV)	PE	Line	Corr. (dB)	Margin (dB)	Limit (dBuV)
0.406000	31.8	GND	L1	10.0	16.0	47.7
0.518000	20.1	GND	L1	10.0	25.9	46.0
0.550000	26.4	GND	L1	10.1	19.6	46.0
0.586000	24.1	GND	L1	10.1	21.9	46.0
1.010000	25.1	GND	L1	10.0	20.9	46.0
2.190000	18.6	GND	L1	10.1	27.4	46.0

ANNEX B: Accreditation Certificate



China National Accreditation Service for Conformity Assessment

LABORATORY ACCREDITATION CERTIFICATE

(No. CNAS L0570)

Telecommunication Technology Labs,

Academy of Telecommunication Research, MIIT

No.52, Huayuan North Road, Haidian District, Beijing, China

No.51, Xueyuan Road, Haidian District, Beijing, China

to ISO/IEC 17025:2005 General Requirements for the Competence of Testing and Calibration Laboratories(CNAS-CL01 Accreditation Criteria for the Competence of Testing and Calibration Laboratories) for the competence in the field of testing and calibration.

The scope of accreditation is detailed in the attached schedule bearing the same accreditation number as above. The schedule forms an integral part of this certificate.

Date of Issue: 2014-10-29

Date of Expiry: 2017-06-19

Date of Initial Accreditation: 1998-07-03



Signed on behalf of China National Accreditation Service
for Conformity Assessment

China National Accreditation Service for Conformity Assessment (CNAS) is authorized by Certification and Accreditation Administration of the People's Republic of China (CNCA) to operate the national accreditation schemes for conformity assessment. CNAS is the signatory to International Laboratory Accreditation Cooperation Multilateral Recognition Arrangement (ILAC MRA) and Asia Pacific Laboratory Accreditation Cooperation Multilateral Recognition Arrangement (APLAC MRA).

No.CNAS AL 2

0011149

*****END OF REPORT*****