



SAR TEST REPORT

No. I16Z40350-SEM02

For

Reliance Communications LLC

GSM quad band and wcdma and LTE mobile Phone

Model Name: RC501L

With

Hardware Version: WMDGa

Software Version: ORBIC-RC501L_V1.0.10

FCC ID: 2ABGH-RC501L

Issued Date: 2016-3-4



Note:

The test results in this test report relate only to the devices specified in this report. This report shall not be reproduced except in full without the written approval of CTTL.

Test Laboratory:

CTTL, Telecommunication Technology Labs, Academy of Telecommunication Research, MIIT

No.52, HuayuanNorth Road, Haidian District, Beijing, P. R. China 100191.

Tel:+86(0)10-62304633-2512,Fax:+86(0)10-62304633-2504

Email:cttl_terminals@catr.cn, website:www.chinattl.com



REPORT HISTORY

Report Number	Revision	Issue Date	Description
I16Z40350-SEM02	Rev.0	2016-3-4	Initial creation of test report



TABLE OF CONTENT

1 TEST LABORATORY	5
1.1 TESTING LOCATION	5
1.2 TESTING ENVIRONMENT.....	5
1.3 PROJECT DATA	5
1.4 SIGNATURE.....	5
2 STATEMENT OF COMPLIANCE	6
3 CLIENT INFORMATION	8
3.1 APPLICANT INFORMATION	8
3.2 MANUFACTURER INFORMATION	8
4 EQUIPMENT UNDER TEST (EUT) AND ANCILLARY EQUIPMENT (AE)	9
4.1 ABOUT EUT	9
4.2 INTERNAL IDENTIFICATION OF EUT USED DURING THE TEST	9
4.3 INTERNAL IDENTIFICATION OF AE USED DURING THE TEST	10
5 TEST METHODOLOGY	11
5.1 APPLICABLE LIMIT REGULATIONS	11
5.2 APPLICABLE MEASUREMENT STANDARDS.....	11
6 SPECIFIC ABSORPTION RATE (SAR)	12
6.1 INTRODUCTION.....	12
6.2 SAR DEFINITION.....	12
7 TISSUE SIMULATING LIQUIDS	13
7.1 TARGETS FOR TISSUE SIMULATING LIQUID	13
7.2 DIELECTRIC PERFORMANCE	13
8 SYSTEM VERIFICATION	19
8.1 SYSTEM SETUP.....	19
8.2 SYSTEM VERIFICATION.....	20
8.3 JUSTIFICATION FOR EXTENDED SAR DIPOLE CALIBRATIONS	21
9 MEASUREMENT PROCEDURES	22
9.1 TESTS TO BE PERFORMED	22
9.2 GENERAL MEASUREMENT PROCEDURE.....	23
9.3 WCDMA MEASUREMENT PROCEDURES FOR SAR	24
9.4 BLUETOOTH & WI-FI MEASUREMENT PROCEDURES FOR SAR	25
9.5 SAR MEASUREMENT FOR LTE.....	25
9.6 POWER DRIFT.....	26
10 AREA SCAN BASED 1-G SAR	27
10.1 REQUIREMENT OF KDB.....	27
10.2 FAST SAR ALGORITHMS	27

11 CONDUCTED OUTPUT POWER	28
11.1 MANUFACTURING TOLERANCE	28
11.2 GSM MEASUREMENT RESULT	32
11.3 WCDMA MEASUREMENT RESULT.....	34
11.4 LTE_FDD MEASUREMENT RESULT	35
11.5 WI-FI AND BT MEASUREMENT RESULT	46
11.6 SPOT CHECK MEASUREMENT RESULT.....	47
12 SIMULTANEOUS TX SAR CONSIDERATIONS	48
12.1 INTRODUCTION.....	48
12.2 TRANSMIT ANTENNA SEPARATION DISTANCES	48
12.3 SAR MEASUREMENT POSITIONS	48
12.4 STANDALONE SAR TEST EXCLUSION CONSIDERATIONS	49
13 EVALUATION OF SIMULTANEOUS	50
14 SAR TEST RESULT	51
14.1 SAR RESULTS FOR FAST SAR.....	52
14.2 SAR RESULTS FOR STANDARD PROCEDURE	69
14.3 WLAN EVALUATION	74
15 MEASUREMENT UNCERTAINTY	76
15.1 MEASUREMENT UNCERTAINTY FOR NORMAL SAR TESTS (300MHz~3GHz)	76
15.2 MEASUREMENT UNCERTAINTY FOR FAST SAR TESTS (300MHz~3GHz)	77
16 MAIN TEST INSTRUMENTS	78
ANNEX A GRAPH RESULTS	79
ANNEX B SYSTEM VERIFICATION RESULTS	123
ANNEX C SAR MEASUREMENT SETUP	142
ANNEX D POSITION OF THE WIRELESS DEVICE IN RELATION TO THE PHANTOM	148
ANNEX E EQUIVALENT MEDIA RECIPES	151
ANNEX F SYSTEM VALIDATION	152
ANNEX G DAE CALIBRATION CERTIFICATE	153
ANNEX H PROBE CALIBRATION CERTIFICATE	156
ANNEX I DIPOLE CALIBRATION CERTIFICATE	167
ANNEX J ACCREDITATION CERTIFICATE	207

1 Test Laboratory

1.1 Testing Location

Company Name:	CTTL(Shouxiang)
Address:	No. 51 Shouxiang Science Building, Xueyuan Road, Haidian District, Beijing, P. R. China100191

1.2 Testing Environment

Temperature:	Min. = 15 °C, Max. = 30 °C
Relative humidity:	Min. = 30%, Max. = 70%
Ground system resistance:	< 0.5 Ω
Ambient noise & Reflection:	< 0.012 W/kg

1.3 Project Data

Project Leader:	Qi Dianyuan
Test Engineer:	Lin Xiaojun
Testing Start Date:	December 16, 2015
Testing End Date:	February 28, 2016

1.4 Signature



Lin Xiaojun
(Prepared this test report)

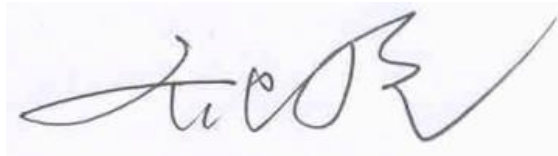

Qi Dianyuan
(Reviewed this test report)



Xiao Li
Deputy Director of the laboratory
(Approved this test report)

2 Statement of Compliance

This EUT is a variant product and the report of original sample is No. I15Z43162-SEM02. According to the client request, we perform the spot check for head and body of each band respectively. If the spot check value is larger than the original value, the spot check value replaces the original values and others are quoted. Otherwise, all the original values are quoted directly. The results for GSM and Wi-Fi and BT antennas are the same as that of the original sample. The details are presented in the section 14.2. The original values are marked with “original” in the right column of data tables and the new tested values are marked with “new”.

The maximum results of Specific Absorption Rate (SAR) found during testing for Reliance Communications LLC GSM quad band and wcdma and LTE mobile Phone RC501L are as follows:

Table 2.1: Highest Reported SAR (1g)

Exposure Configuration	Technology Band	Highest Reported SAR 1g(W/Kg)	Equipment Class
Head (Separation Distance 0mm)	GSM 850	0.30	PCE
	PCS 1900	0.14	
	UMTS FDD 5	0.23	
	UMTS FDD 2	0.34	
	UMTS FDD 4	0.29	
	LTE Band 2	0.41	
	LTE Band 4	0.37	
	LTE Band 5	0.18	
	LTE Band 12	0.06	
	LTE Band 17	0.07	
	WLAN 2.4 GHz	0.19	DTS
Hotspot (Separation Distance 10mm)	GSM 850	0.83	PCE
	PCS 1900	0.49	
	UMTS FDD 5	0.39	
	UMTS FDD 2	0.46	
	UMTS FDD 4	0.68	
	LTE Band 2	0.45	
	LTE Band 4	0.76	
	LTE Band 5	0.37	
	LTE Band 12	0.10	
	LTE Band 17	0.13	
	WLAN 2.4 GHz	0.10	DTS

The SAR values found for the Mobile Phone are below the maximum recommended levels of 1.6 W/Kg as averaged over any 1g tissue according to the ANSI C95.1-1992.

For body worn operation, this device has been tested and meets FCC RF exposure guidelines when used with any accessory that contains no metal and which provides a minimum separation distance of 10 mm for hotspot on and 10mm for hotspot off between this device and the body of the user. Use

of other accessories may not ensure compliance with FCC RF exposure guidelines.

The EUT battery must be fully charged and checked periodically during the test to ascertain uniform power output.

The measurement together with the test system set-up is described in annex C of this test report. A detailed description of the equipment under test can be found in chapter 4 of this test report.

The highest reported SAR value is obtained at the case of **(Table 2.1)**, and the values are: **0.83 W/kg (1g)**.

Table 2.2: The sum of reported SAR values for main antenna and WiFi

	Position	Main antenna	WiFi	Sum
Highest reported SAR value for Head	Left hand, Touch cheek	0.41	0.06	0.47
	Right hand, Touch cheek	0.30	0.19	0.49
Highest reported SAR value for Body	Rear	0.83	0.10	0.93

Table 2.3: The sum of reported SAR values for main antenna and BT

	Position	Main antenna	BT*	Sum
Highest reported SAR value for Head	Left hand, Touch cheek	0.41	0.26	0.67
	Right hand, Touch cheek	0.30	0.26	0.56
Highest reported SAR value for Body	Rear	0.83	0.13	0.96

BT* - Estimated SAR for Bluetooth (see the table 13.3)

According to the above tables, the highest sum of reported SAR values is **0.96 W/kg (1g)**. The detail for simultaneous transmission consideration is described in chapter 13.



3 Client Information

3.1 Applicant Information

Company Name:	Reliance Communications LLC
Address /Post:	555 Wireless Blvd, Hauppauge, NY 11788,United States
Contact:	Saqib Ghouri
Email:	Saqib.ghouri@reliance.us
Telephone:	631-240-8394
Fax:	/

3.2 Manufacturer Information

Company Name:	Reliance Communications LLC
Address /Post:	555 Wireless Blvd, Hauppauge, NY 11788,United States
Contact:	Saqib Ghouri
Email:	Saqib.ghouri@reliance.us
Telephone:	631-240-8394
Fax:	/

4 Equipment Under Test (EUT) and Ancillary Equipment (AE)

4.1 About EUT

Description:	GSM quad band and wcdma and LTE mobile Phone
Model Name:	RC501L
Operating mode(s):	GSM 850/1900, WCDMA 850/1700/1900, LTE_FDD Band 2/4/5/12/17, BT, Wi-Fi
Tested Tx Frequency:	825 – 848.8 MHz (GSM 850)
	1850.2 – 1910 MHz (GSM 1900)
	826.4–846.6 MHz (WCDMA850 Band V)
	1712.4–1752.6 MHz (WCDMA1700 Band IV)
	1852.4–1907.6 MHz (WCDMA1900 Band II)
	1860–1900 MHz (LTE_FDD Band II)
	1720–1745 MHz (LTE_FDD Band IV)
	829–844 MHz (LTE_FDD Band V)
	704–711 MHz (LTE_FDD Band XII)
	709–711 MHz (LTE_FDD Band 17)
2412 – 2462 MHz (Wi-Fi 2.4G)	
GPRS&EGPRS Multislot Class:	12;
GPRS capability Class:	B
WCDMA Category:	HSDPA: 14
	HSUPA: 7
	HSPA+: 7
	DC-HSDPA: 24
Release Version:	GSM: Rel4
	GPRS: Rel5
	UMTS: R8
Test device Production information:	Production unit
Device type:	Portable device
Antenna type:	Integrated antenna
Accessories/Body-worn configurations:	Headset
Hotspot mode:	Support simultaneous transmission of hotspot and voice(or data)
Form factor:	143mm x 70 mm

4.2 Internal Identification of EUT used during the test

EUT ID*	SN or IMEI	HW Version	SW Version
EUT1	357706070096996	WMDGa	Orbic-RC501L_v1.0.10
EUT2	357706070094660	WMDGa	Orbic-RC501L_v1.010

*EUT ID: is used to identify the test sample in the lab internally.

Note: It is performed to test SAR with the EUT1 and conducted power with the EUT 2



4.3 Internal Identification of AE used during the test

AE ID*	Description	Model	SN	Manufacturer
AE1	Battery	Orbic-RC501L	/	Shenzhen City Rui electronic industry Co., Ltd.
AE2	Headset	JD15120703	/	Dongguan JinDingBao Electronics Technology Co.,Ltd.

*AE ID: is used to identify the test sample in the lab internally.



5 TEST METHODOLOGY

5.1 Applicable Limit Regulations

ANSI C95.1–1992: IEEE Standard for Safety Levels with Respect to Human Exposure to Radio Frequency Electromagnetic Fields, 3 kHz to 300 GHz.

It specifies the maximum exposure limit of **1.6 W/kg** as averaged over any 1 gram of tissue for portable devices being used within 20 cm of the user in the uncontrolled environment.

5.2 Applicable Measurement Standards

IEEE 1528–2013: Recommended Practice for Determining the Peak Spatial-Average Specific Absorption Rate (SAR) in the Human Head from Wireless Communications Devices: Experimental Techniques.

KDB 447498 D01 General RF Exposure Guidance v06: Mobile and Portable Devices RF Exposure Procedures and Equipment Authorization Policies.

KDB648474 D04 Handset SAR v01r02: SAR Evaluation Considerations for Wireless Handsets.

KDB941225 D01 SAR test for 3G devices v03r01: SAR Measurement Procedures for 3G Devices

KDB941225 D05 SAR for LTE Devices v02r04: SAR Evaluation Considerations for LTE Devices

KDB 941225 D06 Hot Spot SAR v02r01: SAR Evaluation Procedures for Portable Devices with Wireless Router Capabilities

KDB 248227 D01 802.11 Wi-Fi SAR v02r02: SAR Guidance for IEEE 802.11 (Wi-Fi) Transmitters.

KDB 865664 D01 SAR measurement 100 MHz to 6 GHz v01r04: SAR Measurement Requirements for 100 MHz to 6 GHz.

KDB 865664 D02 RF Exposure Reporting v01r02: RF Exposure Compliance Reporting and Documentation Considerations

6 Specific Absorption Rate (SAR)

6.1 Introduction

SAR is related to the rate at which energy is absorbed per unit mass in an object exposed to a radio field. The SAR distribution in a biological body is complicated and is usually carried out by experimental techniques or numerical modeling. The standard recommends limits for two tiers of groups, occupational/controlled and general population/uncontrolled, based on a person's awareness and ability to exercise control over his or her exposure. In general, occupational/controlled exposure limits are higher than the limits for general population/uncontrolled.

6.2 SAR Definition

The SAR definition is the time derivative (rate) of the incremental energy (dW) absorbed by (dissipated in) an incremental mass (dm) contained in a volume element (dv) of a given density (ρ). The equation description is as below:

$$SAR = \frac{d}{dt} \left(\frac{dW}{dm} \right) = \frac{d}{dt} \left(\frac{dW}{\rho dv} \right)$$

SAR is expressed in units of Watts per kilogram (W/kg)

SAR measurement can be either related to the temperature elevation in tissue by

$$SAR = c \left(\frac{\delta T}{\delta t} \right)$$

Where: C is the specific heat capacity, δT is the temperature rise and δt is the exposure duration, or related to the electrical field in the tissue by

$$SAR = \frac{\sigma |E|^2}{\rho}$$

Where: σ is the conductivity of the tissue, ρ is the mass density of tissue and E is the RMS electrical field strength.

However for evaluating SAR of low power transmitter, electrical field measurement is typically applied.

7 Tissue Simulating Liquids

7.1 Targets for tissue simulating liquid

Table 7.1: Targets for tissue simulating liquid

Frequency (MHz)	Liquid Type	Conductivity (σ)	$\pm 5\%$ Range	Permittivity (ϵ)	$\pm 5\%$ Range
750	Head	0.89	0.85~0.93	41.94	39.84~44.04
750	Body	0.96	0.91~1.01	55.5	52.73~58.28
835	Head	0.90	0.86~0.95	41.5	39.4~43.6
835	Body	0.97	0.92~1.02	55.2	52.4~58.0
1800	Head	1.4	1.33~1.47	40.00	38.0~42.0
1800	Body	1.52	1.40~1.60	53.50	50.8~56.2
1900	Head	1.40	1.33~1.47	40.0	38.0~42.0
1900	Body	1.52	1.44~1.60	53.3	50.6~56.0
2450	Head	1.80	1.71~1.89	39.2	37.2~41.2
2450	Body	1.95	1.85~2.05	52.7	50.1~55.3

7.2 Dielectric Performance

Table 7.2: Dielectric Performance of Tissue Simulating Liquid

Measurement Date (yyyy-mm-dd)	Type	Frequency	Permittivity ϵ	Drift (%)	Conductivity σ (S/m)	Drift (%)
2015-12-28	Head	750 MHz	42.20	0.62	0.88	-1.12
2015-12-28	Body	750 MHz	56.68	2.13	0.94	-2.08
2015-12-16	Head	835 MHz	40.18	-3.18	0.93	3.33
2015-12-25	Body	835 MHz	53.49	-3.10	0.97	0.00
2015-12-24	Head	1800 MHz	38.67	-3.33	1.35	-3.57
2015-12-26	Body	1800 MHz	53.68	0.34	1.48	-2.63
2015-12-17	Head	1900 MHz	38.38	-4.05	1.41	0.71
2015-12-26	Body	1900 MHz	53.44	0.26	1.57	3.29
2015-12-27	Head	2450 MHz	37.71	-3.80	1.83	1.67
2015-12-27	Body	2450 MHz	50.22	-4.71	1.98	1.54
2016-2-18	Head	750 MHz	42.25	0.74	0.87	-2.25
2016-2-28	Body	750 MHz	56.78	2.31	0.95	-1.04
2016-2-18	Head	835 MHz	40.23	-3.06	0.93	1.09
2016-2-28	Body	835 MHz	53.52	-3.04	0.98	1.03
2016-2-21	Head	1800 MHz	38.36	-4.1	1.43	2.14
2016-2-24	Body	1800 MHz	51.02	-4.64	1.47	-3.29
2016-2-22	Head	1900 MHz	41.07	2.68	1.42	1.43
2016-2-25	Body	1900 MHz	53.29	-0.02	1.54	1.32

Note: The liquid temperature is 22.0 °C

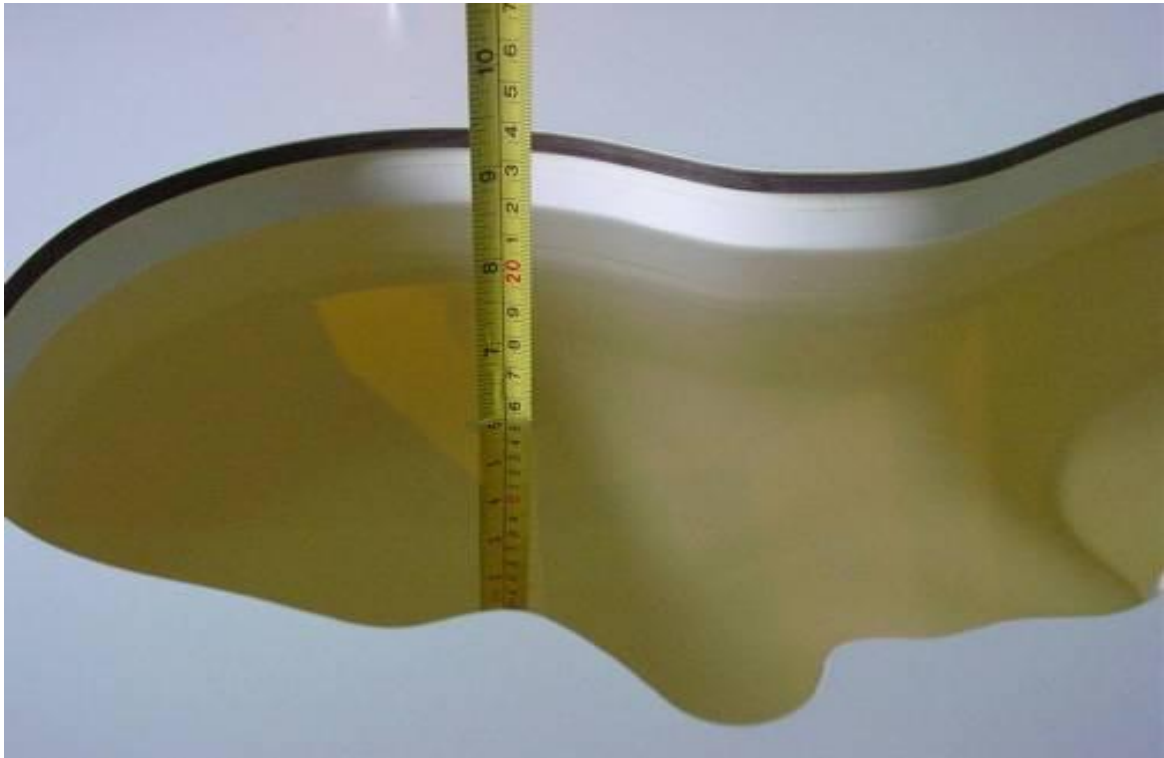

Picture 7-1: Liquid depth in the Head Phantom (750 MHz)

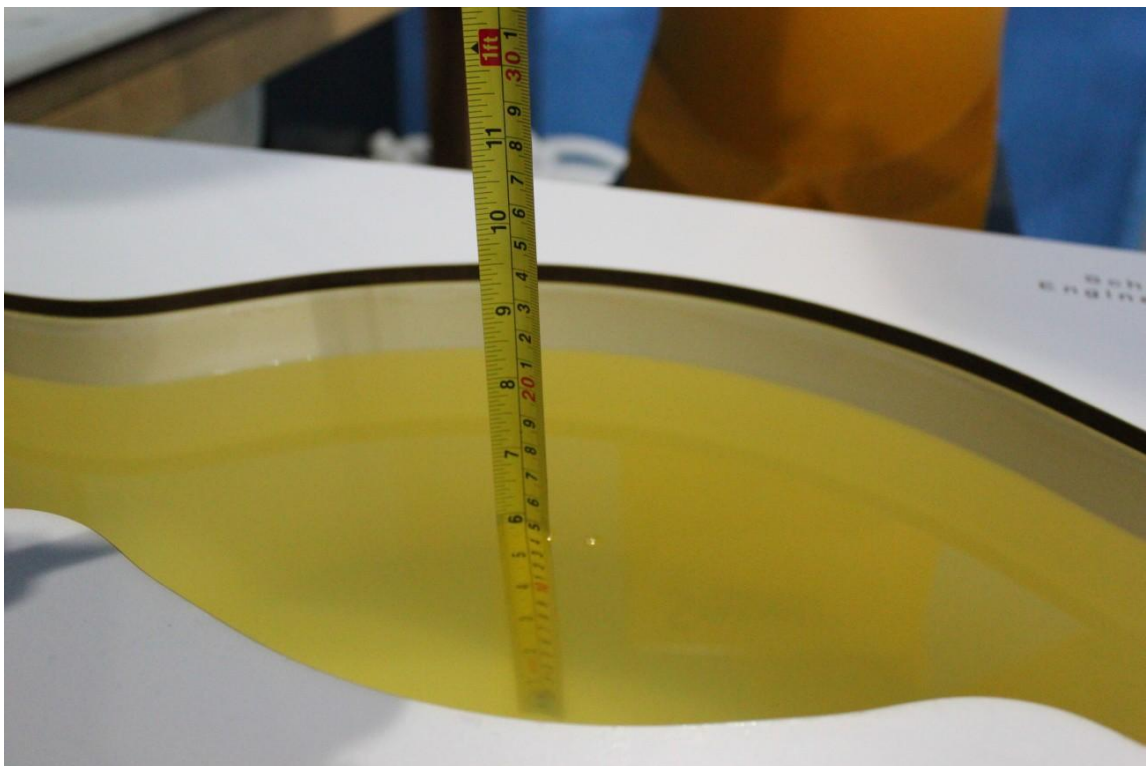

Picture 7-2: Liquid depth in the Flat Phantom (750 MHz)

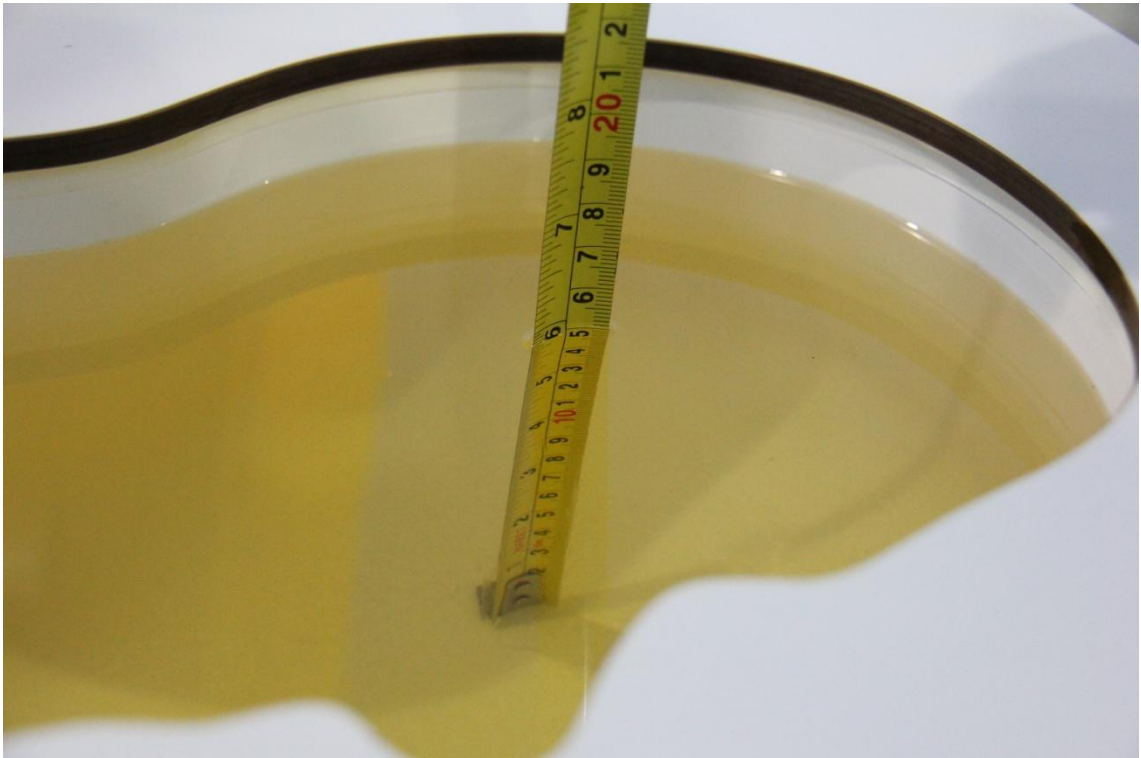

Picture 7-3: Liquid depth in the Head Phantom (835 MHz)

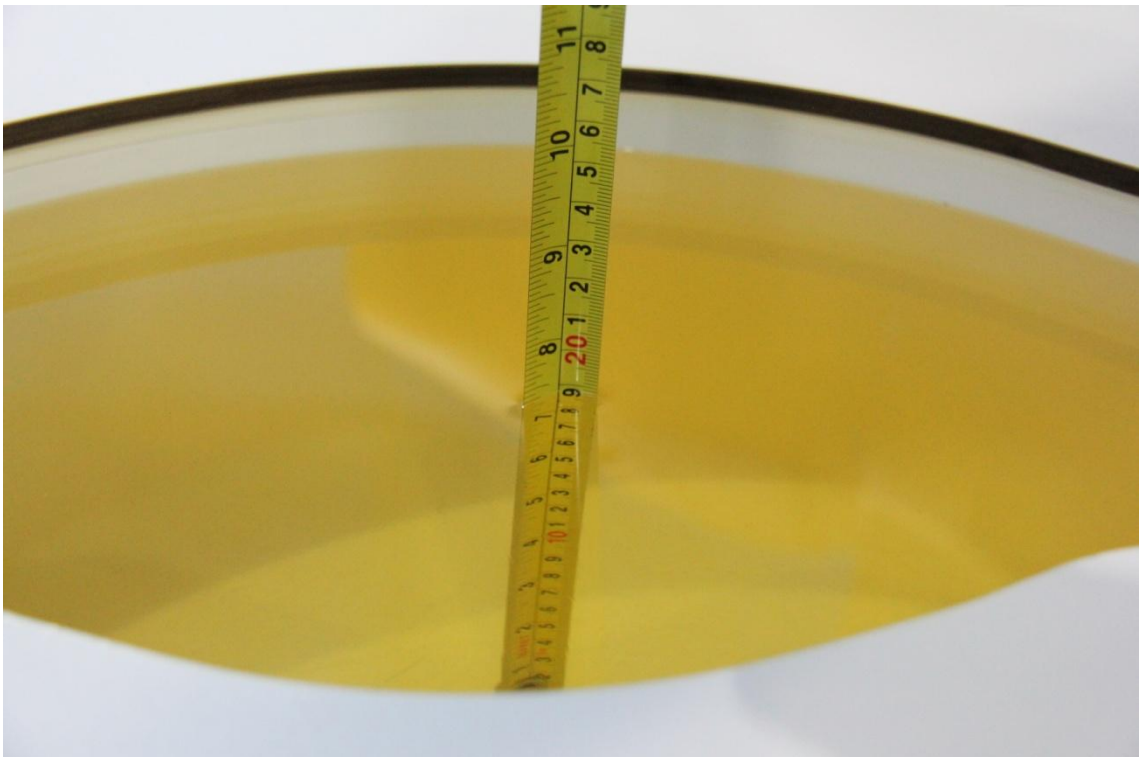

Picture 7-4: Liquid depth in the Flat Phantom (835 MHz)

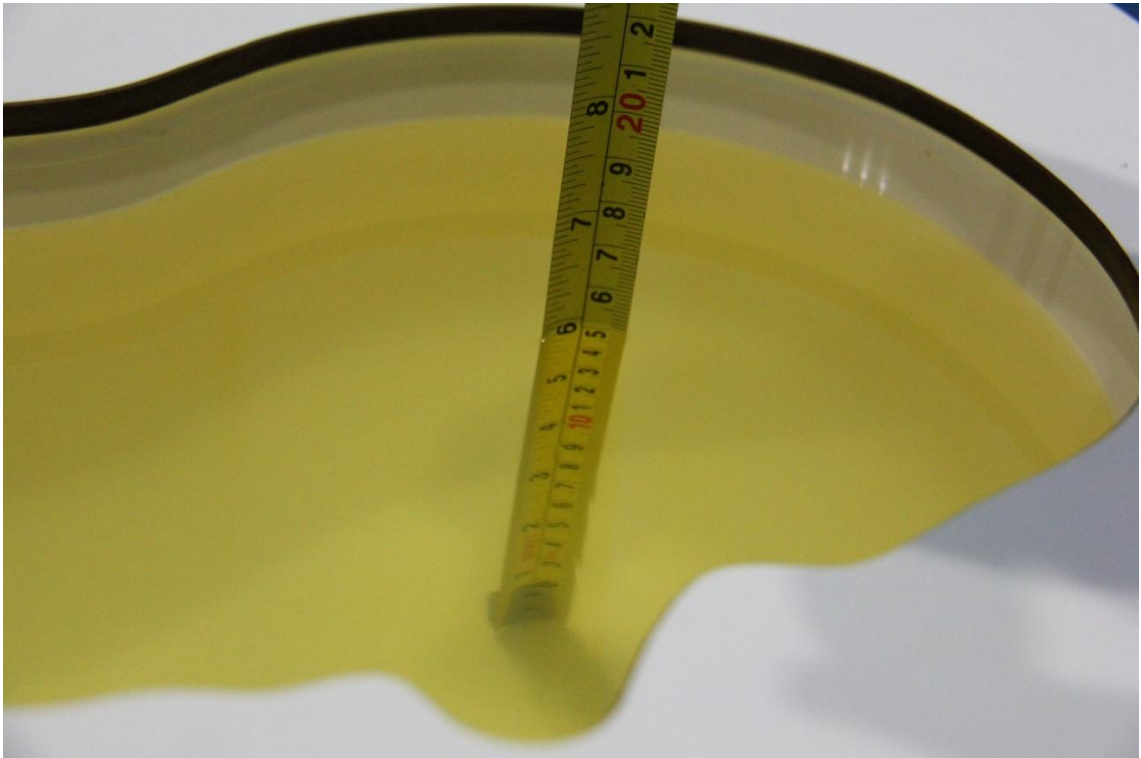

Picture 7-5: Liquid depth in the Head Phantom (1800 MHz)



Picture 7-6: Liquid depth in the Flat Phantom (1800MHz)

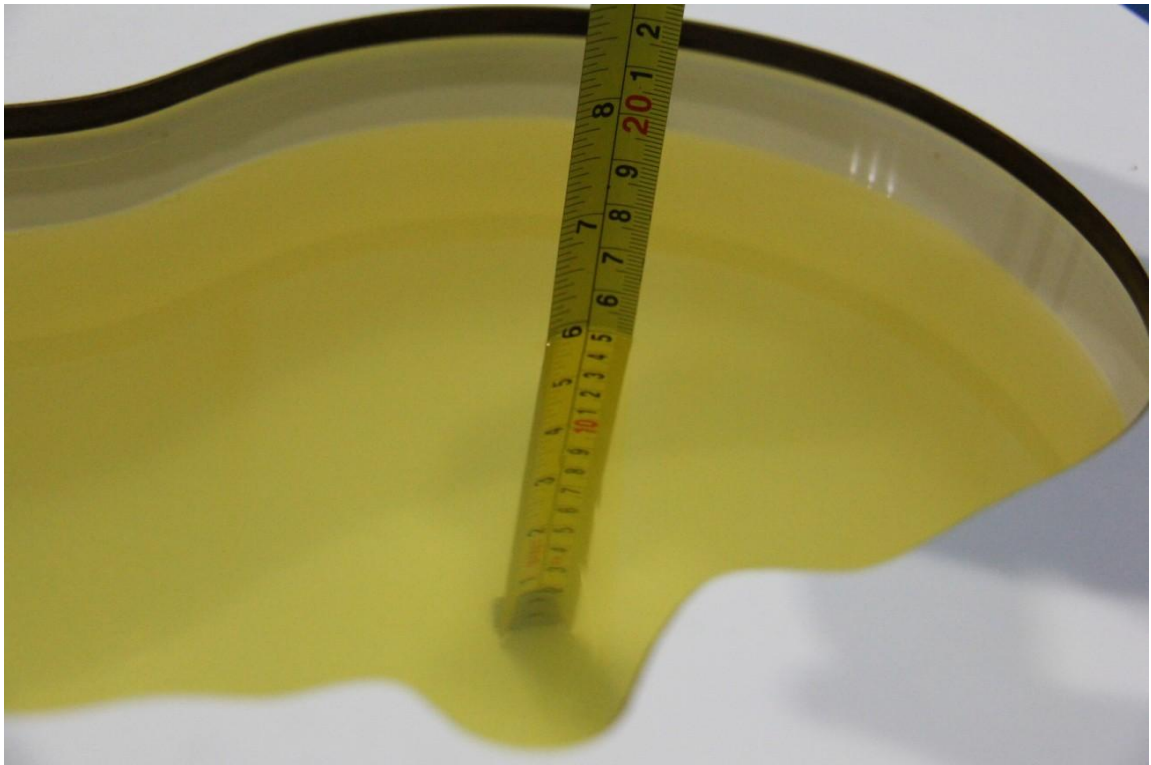

Picture 7-7: Liquid depth in the Head Phantom (1900 MHz)

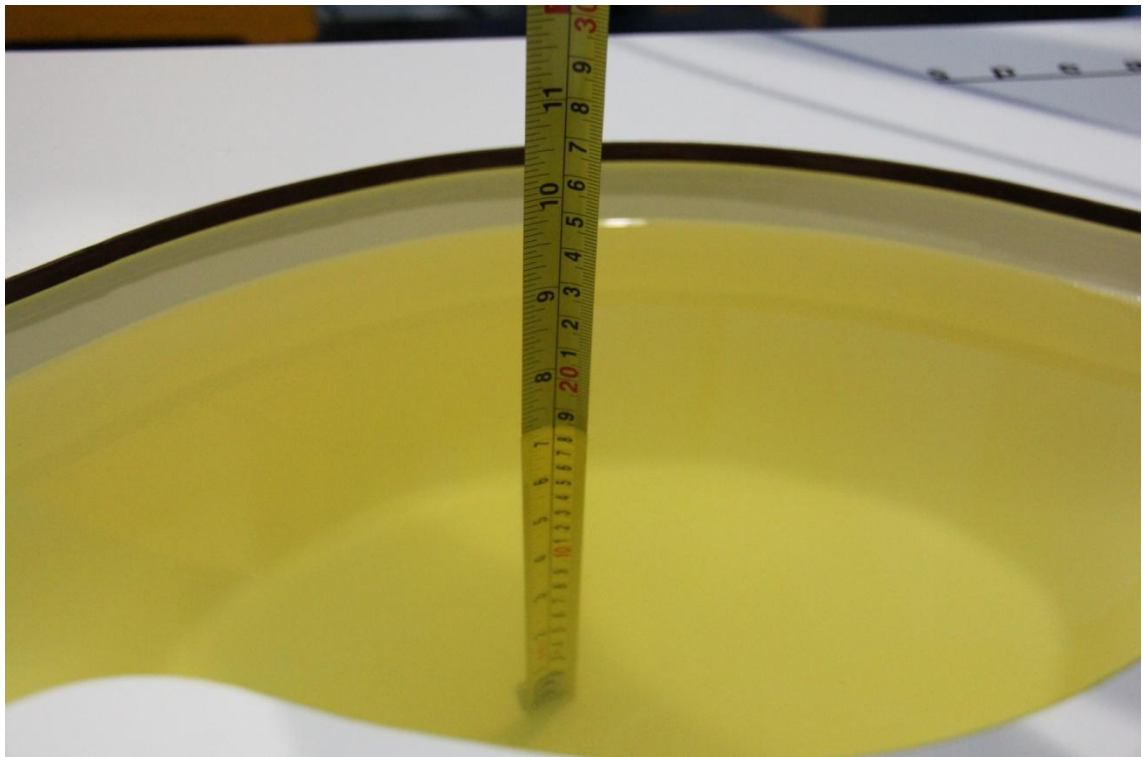

Picture 7-8: Liquid depth in the Flat Phantom (1900MHz)

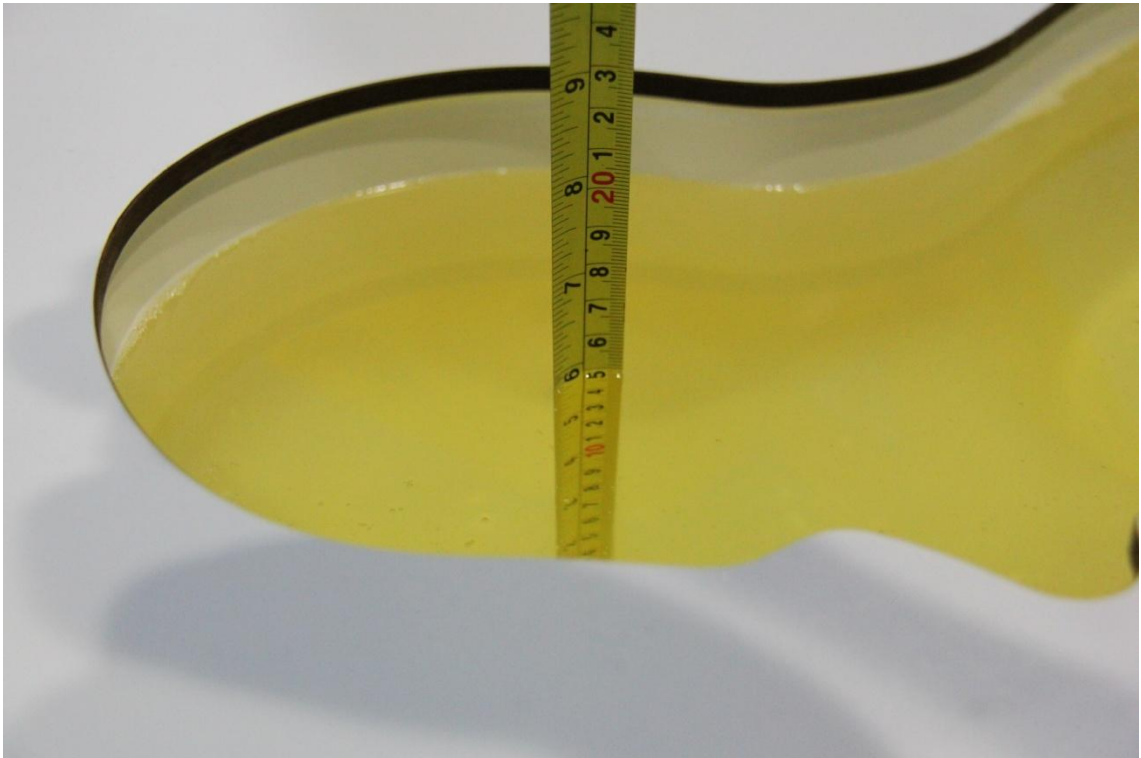

Picture 7-9: Liquid depth in the Head Phantom (2450MHz)



Picture 7-10: Liquid depth in the Head Phantom (2450MHz)

8 System verification

8.1 System Setup

In the simplified setup for system evaluation, the DUT is replaced by a calibrated dipole and the power source is replaced by a continuous wave that comes from a signal generator. The calibrated dipole must be placed beneath the flat phantom section of the SAM twin phantom with the correct distance holder. The distance holder should touch the phantom surface with a light pressure at the reference marking and be oriented parallel to the long side of the phantom. The equipment setup is shown below:

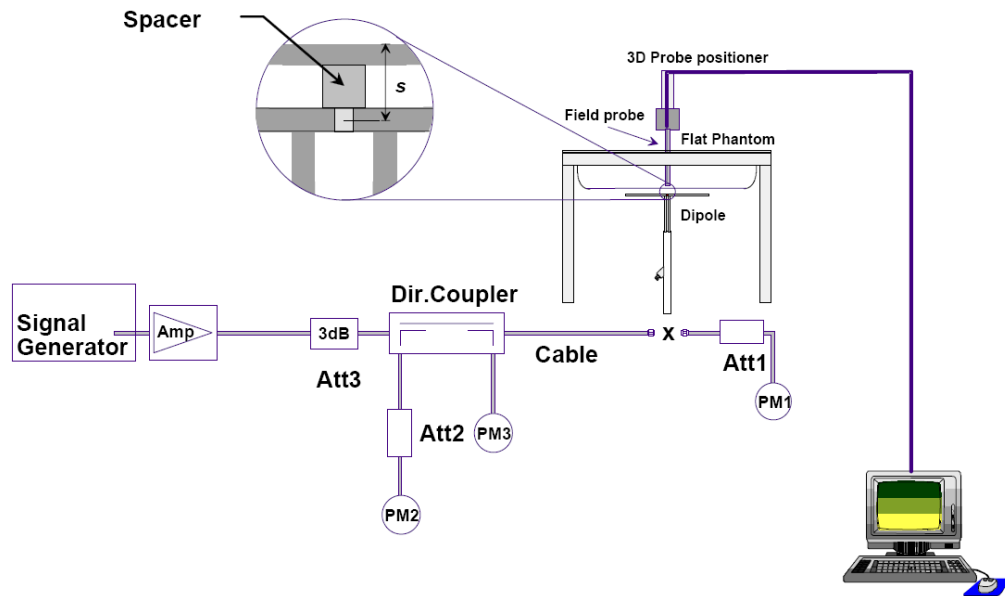

Picture 8.1 System Setup for System Evaluation

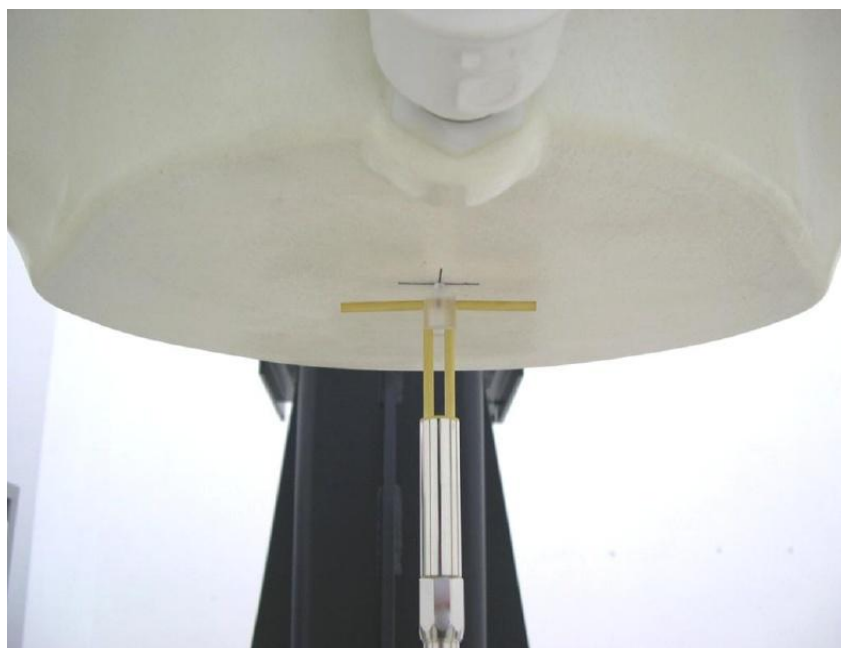

Picture 8.2 Photo of Dipole Setup

8.2 System Verification

SAR system verification is required to confirm measurement accuracy, according to the tissue dielectric media, probe calibration points and other system operating parameters required for measuring the SAR of a test device. The system verification must be performed for each frequency band and within the valid range of each probe calibration point required for testing the device.

The system verification results are required that the area scan estimated 1-g SAR is within 3% of the zoom scan 1-g SAR. The details are presented in annex B.

Table 8.1: System Verification of Head

Measurement Date (yyyy-mm-dd)	Frequency	Target value (W/kg)		Measured value (W/kg)		Deviation	
		10 g Average	1 g Average	10 g Average	1 g Average	10 g Average	1 g Average
2015-12-28	750 MHz	5.49	8.31	5.52	8.44	0.55%	1.56%
2015-12-16	835 MHz	6.03	9.22	5.88	9.52	-2.49%	3.25%
2015-12-24	1800 MHz	20.6	38.8	19.96	37.52	-3.11%	-3.30%
2015-12-17	1900 MHz	21.0	40.8	20.48	39.96	-2.48%	-2.06%
2015-12-27	2450 MHz	24.1	52.5	24.84	54.80	3.07%	4.38%
2016-2-18	750 MHz	5.49	8.31	5.44	8.44	-0.91%	1.56%
2016-2-18	835 MHz	6.03	9.22	6.00	9.44	-0.50%	2.39%
2016-2-21	1800 MHz	20.60	38.80	20.2	37.48	-1.94%	-3.40%
2016-2-22	1900 MHz	21.00	40.80	21.00	40.04	0.00%	-1.86%

Table 8.2: System Verification of Body

Measurement Date (yyyy-mm-dd)	Frequency	Target value (W/kg)		Measured value (W/kg)		Deviation	
		10 g Average	1 g Average	10 g Average	1 g Average	10 g Average	1 g Average
2015-12-28	750 MHz	5.85	8.75	5.96	8.96	1.88%	2.40%
2015-12-25	835 MHz	6.20	9.44	6.16	9.72	-0.65%	2.97%
2015-12-26	1800 MHz	21.1	39.6	20.16	39.28	-2.94%	-0.81%
2015-12-26	1900 MHz	21.3	41.1	21.80	40.92	2.35%	-0.44%
2015-12-27	2450 MHz	24.4	52.3	25.00	53.60	2.46%	2.49%
2016-2-28	750 MHz	5.85	8.75	5.92	8.92	1.20%	1.94%
2016-2-28	835 MHz	6.20	9.44	6.36	9.68	2.58%	2.54%
2016-2-24	1800 MHz	21.10	39.60	21.08	39.68	-0.09%	0.20%
2016-2-25	1900 MHz	21.30	41.10	20.88	40.00	-1.97%	-2.68%



8.3 Justification for Extended SAR Dipole Calibrations

Usage of SAR dipoles calibrated less than 2 years ago but more than 1 year ago were confirmed in maintaining return loss (< -20 dB, within 20% of prior calibration) and impedance (within 5 ohm from prior calibration) requirements per extended calibrations in KDB 865664 D01:

Dipole D750V3 SN: 1017				
Head Liquid				
Date of Measurement	Return Loss(dB)	Δ %	Impedance (Ω)	$\Delta\Omega$
2/23/2015	-30.1	/	53.2	/
8/27/2015	-28.9	4.0	51.3	1.9
Body Liquid				
Date of Measurement	Return Loss(dB)	Δ %	Impedance (Ω)	$\Delta\Omega$
2/23/2015	-28.9	/	48.0	/
8/27/2015	-28.2	2.4	46.6	1.4

9 Measurement Procedures

9.1 Tests to be performed

In order to determine the highest value of the peak spatial-average SAR of a handset, all device positions, configurations and operational modes shall be tested for each frequency band according to steps 1 to 3 below. A flowchart of the test process is shown in picture 9.1.

Step 1: The tests described in 9.2 shall be performed at the channel that is closest to the centre of the transmit frequency band (f_c) for:

- a) all device positions (cheek and tilt, for both left and right sides of the SAM phantom, as described in annex D),
- b) all configurations for each device position in a), e.g., antenna extended and retracted, and
- c) all operational modes, e.g., analogue and digital, for each device position in a) and configuration in b) in each frequency band.

If more than three frequencies need to be tested according to 11.1 (i.e., $N_c > 3$), then all frequencies, configurations and modes shall be tested for all of the above test conditions.

Step 2: For the condition providing highest peak spatial-average SAR determined in Step 1, perform all tests described in 9.2 at all other test frequencies, i.e., lowest and highest frequencies. In addition, for all other conditions (device position, configuration and operational mode) where the peak spatial-average SAR value determined in Step 1 is within 3 dB of the applicable SAR limit, it is recommended that all other test frequencies shall be tested as well.

Step 3: Examine all data to determine the highest value of the peak spatial-average SAR found in Steps 1 to 2.

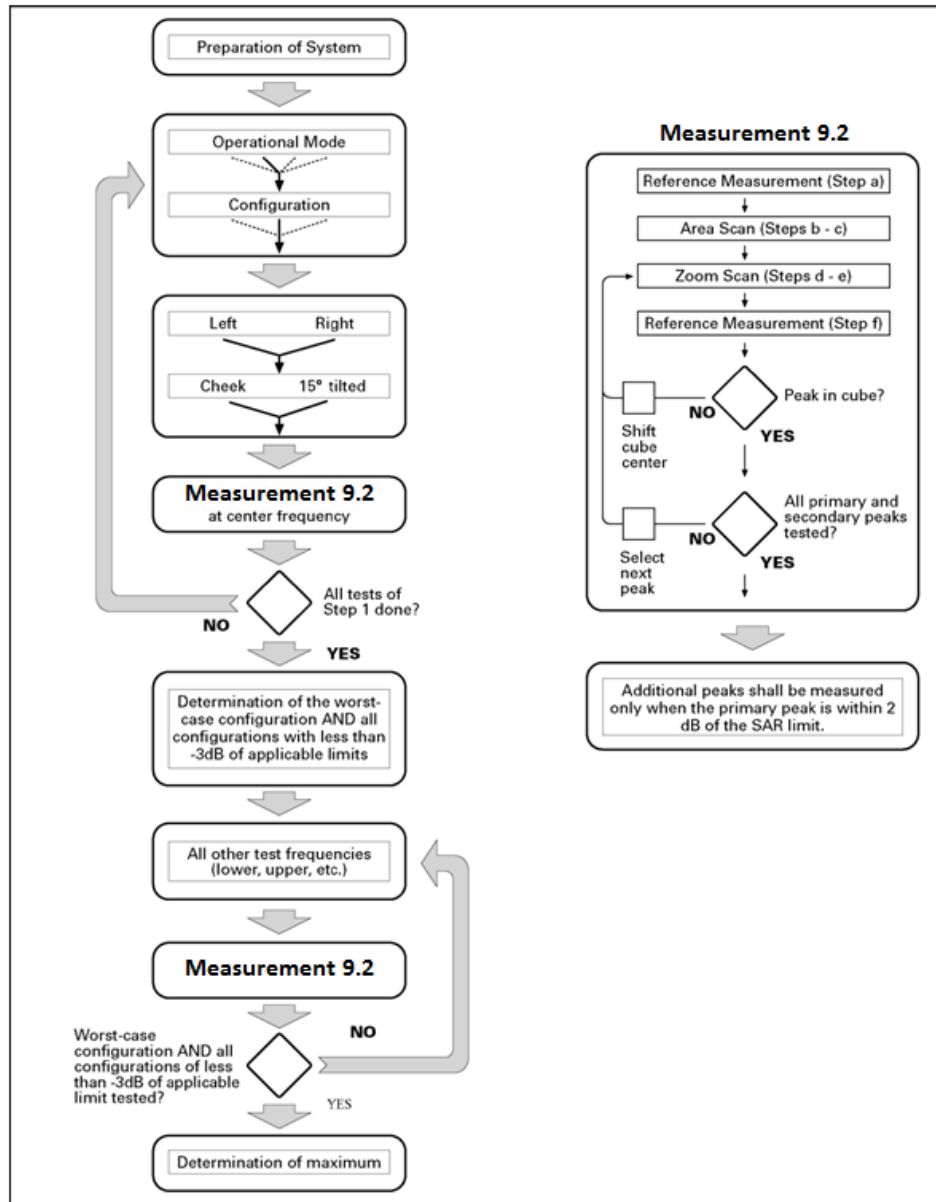

Picture 9.1 Block diagram of the tests to be performed

9.2 General Measurement Procedure

The area and zoom scan resolutions specified in the table below must be applied to the SAR measurements and fully documented in SAR reports to qualify for TCB approval. Probe boundary effect error compensation is required for measurements with the probe tip closer than half a probe tip diameter to the phantom surface. Both the probe tip diameter and sensor offset distance must satisfy measurement protocols; to ensure probe boundary effect errors are minimized and the higher fields closest to the phantom surface can be correctly measured and extrapolated to the phantom surface for computing 1-g SAR. Tolerances of the post-processing algorithms must be verified by the test laboratory for the scan resolutions used in the SAR measurements, according to the reference distribution functions specified in IEEE Std 1528-2013. The results should be documented as part of the system validation records and may be requested to support test results

when all the measurement parameters in the following table are not satisfied.

		≤ 3 GHz	> 3 GHz
Maximum distance from closest measurement point (geometric center of probe sensors) to phantom surface		5 ± 1 mm	$\frac{1}{2} \cdot \delta \cdot \ln(2) \pm 0.5$ mm
Maximum probe angle from probe axis to phantom surface normal at the measurement location		$30^\circ \pm 1^\circ$	$20^\circ \pm 1^\circ$
Maximum area scan spatial resolution: $\Delta x_{Area}, \Delta y_{Area}$		≤ 2 GHz: ≤ 15 mm 2 – 3 GHz: ≤ 12 mm	3 – 4 GHz: ≤ 12 mm 4 – 6 GHz: ≤ 10 mm
		When the x or y dimension of the test device, in the measurement plane orientation, is smaller than the above, the measurement resolution must be \leq the corresponding x or y dimension of the test device with at least one measurement point on the test device.	
Maximum zoom scan spatial resolution: $\Delta x_{Zoom}, \Delta y_{Zoom}$		≤ 2 GHz: ≤ 8 mm 2 – 3 GHz: ≤ 5 mm*	3 – 4 GHz: ≤ 5 mm* 4 – 6 GHz: ≤ 4 mm*
Maximum zoom scan spatial resolution, normal to phantom surface	uniform grid: $\Delta z_{Zoom}(n)$	≤ 5 mm	3 – 4 GHz: ≤ 4 mm 4 – 5 GHz: ≤ 3 mm 5 – 6 GHz: ≤ 2 mm
	graded grid $\Delta z_{Zoom}(1)$: between 1 st two points closest to phantom surface	≤ 4 mm	3 – 4 GHz: ≤ 3 mm 4 – 5 GHz: ≤ 2.5 mm 5 – 6 GHz: ≤ 2 mm
	$\Delta z_{Zoom}(n>1)$: between subsequent points	$\leq 1.5 \cdot \Delta z_{Zoom}(n-1)$	
Minimum zoom scan volume	x, y, z	≥ 30 mm	3 – 4 GHz: ≥ 28 mm 4 – 5 GHz: ≥ 25 mm 5 – 6 GHz: ≥ 22 mm
<p>Note: δ is the penetration depth of a plane-wave at normal incidence to the tissue medium; see draft standard IEEE P1528-2011 for details.</p> <p>* When zoom scan is required and the <i>reported</i> SAR from the area scan based <i>I-g SAR estimation</i> procedures of KDB 447498 is ≤ 1.4 W/kg, ≤ 8 mm, ≤ 7 mm and ≤ 5 mm zoom scan resolution may be applied, respectively, for 2 GHz to 3 GHz, 3 GHz to 4 GHz and 4 GHz to 6 GHz.</p>			

9.3 WCDMA Measurement Procedures for SAR

The following procedures are applicable to WCDMA handsets operating under 3GPP Release99, Release 5 and Release 6. The default test configuration is to measure SAR with an established radio link between the DUT and a communication test set using a 12.2kbps RMC (reference measurement channel) configured in Test Loop Mode 1. SAR is selectively confirmed for other physical channel configurations (DPCCH & DPDCH_n), HSDPA and HSPA (HSUPA/HSDPA) modes according to output power, exposure conditions and device operating capabilities. Both uplink and downlink should be configured with the same RMC or AMR, when required. SAR for Release 5 HSDPA and Release 6 HSPA are measured using the applicable FRC (fixed reference channel) and E-DCH reference channel configurations. Maximum output power is verified according to applicable versions of 3GPP TS 34.121 and SAR must be measured according to these maximum output conditions. When Maximum Power Reduction (MPR) is not implemented according to Cubic Metric (CM) requirements for Release 6 HSPA, the following procedures do not apply.

For Release 5 HSDPA Data Devices:

Sub-test	β_c	β_d	β_d (SF)	β_c / β_d	β_{hs}	CM/dB
1	2/15	15/15	64	2/15	4/15	0.0
2	12/15	15/15	64	12/15	24/25	1.0
3	15/15	8/15	64	15/8	30/15	1.5
4	15/15	4/15	64	15/4	30/15	1.5

For Release 6 HSPA Data Devices

Sub-test	β_c	β_d	β_d (SF)	β_c / β_d	β_{hs}	β_{ec}	β_{ed}	β_{ed} (SF)	β_{ed} (codes)	CM (dB)	MPR (dB)	AG Index	E-TFCI
1	11/15	15/15	64	11/15	22/15	209/225	1039/225	4	1	1.0	0.0	20	75
2	6/15	15/15	64	6/15	12/15	12/15	12/15	4	1	3.0	2.0	12	67
3	15/15	9/15	64	15/9	30/15	30/15	$\beta_{ed1}:47/15$ $\beta_{ed2}:47/15$	4	2	2.0	1.0	15	92
4	2/15	15/15	64	2/15	4/15	4/15	56/75	4	1	3.0	2.0	17	71
5	15/15	15/15	64	15/15	24/15	30/15	134/15	4	1	1.0	0.0	21	81

9.4 Bluetooth & Wi-Fi Measurement Procedures for SAR

Normal network operating configurations are not suitable for measuring the SAR of 802.11 transmitters in general. Unpredictable fluctuations in network traffic and antenna diversity conditions can introduce undesirable variations in SAR results. The SAR for these devices should be measured using chipset based test mode software to ensure that the results are consistent and reliable.

Chipset based test mode software is hardware dependent and generally varies among manufacturers. The device operating parameters established in a test mode for SAR measurements must be identical to those programmed in production units, including output power levels, amplifier gain settings and other RF performance tuning parameters. The test frequencies should correspond to actual channel frequencies defined for domestic use. SAR for devices with switched diversity should be measured with only one antenna transmitting at a time during each SAR measurement, according to a fixed modulation and data rate. The same data pattern should be used for all measurements.

9.5 SAR Measurement for LTE

SAR tests for LTE are performed with a base station simulator, Anristu MT8820C. Closed loop power control was used so the UE transmits with maximum output power during SAR testing. All powers were measured with the Anristu MT8820C. It is performed for conducted power and SAR based on the KDB941225 D05.

SAR is evaluated separately according to the following procedures for the different test positions in each exposure condition – head, body, body-worn accessories and other use

conditions. The procedures in the following subsections are applied separately to test each LTE frequency band.

1) QPSK with 1 RB allocation

Start with the largest channel bandwidth and measure SAR for QPSK with 1 RB allocation, using the RB offset and required test channel combination with the highest maximum output power among RB offsets at the upper edge, middle and lower edge of each required test channel. When the reported SAR is ≤ 0.8 W/kg, testing of the remaining RB offset configurations and required test channels is not required for 1 RB allocation; otherwise, SAR is required for the remaining required test channels and only for the RB offset configuration with the highest output power for that channel. When the reported SAR of a required test channel is > 1.45 W/kg, SAR is required for all three RB offset configurations for that required test channel.

2) QPSK with 50% RB allocation

The procedures required for 1 RB allocation in 1) are applied to measure the SAR for QPSK with 50% RB allocation.

3) QPSK with 100% RB allocation

For QPSK with 100% RB allocation, SAR is not required when the highest maximum output power for 100 % RB allocation is less than the highest maximum output power in 50% and 1 RB allocations and the highest reported SAR for 1 RB and 50% RB allocation in 1) and 2) are ≤ 0.8 W/kg. Otherwise, SAR is measured for the highest output power channel; and if the reported SAR is > 1.45 W/kg, the remaining required test channels must also be tested.

9.6 Power Drift

To control the output power stability during the SAR test, DASY4 system calculates the power drift by measuring the E-field at the same location at the beginning and at the end of the measurement for each test position. These drift values can be found in Table 14.2 to Table 14.25 labeled as: (Power Drift [dB]). This ensures that the power drift during one measurement is within 5%.

10 Area Scan Based 1-g SAR

10.1 Requirement of KDB

According to the KDB447498 D01 v05, when the implementation is based the specific polynomial fit algorithm as presented at the 29th Bioelectromagnetics Society meeting (2007) and the estimated 1-g SAR is ≤ 1.2 W/kg, a zoom scan measurement is not required provided it is also not needed for any other purpose; for example, if the peak SAR location required for simultaneous transmission SAR test exclusion can be determined accurately by the SAR system or manually to discriminate between distinctive peaks and scattered noisy SAR distributions from area scans.

There must not be any warning or alert messages due to various measurement concerns identified by the SAR system; for example, noise in measurements, peaks too close to scan boundary, peaks are too sharp, spatial resolution and uncertainty issues etc. The SAR system verification must also demonstrate that the area scan estimated 1-g SAR is within 3% of the zoom scan 1-g SAR (See Annex B). When all the SAR results for each exposure condition in a frequency band and wireless mode are based on estimated 1-g SAR, the 1-g SAR for the highest SAR configuration must be determined by a zoom scan.

10.2 Fast SAR Algorithms

The approach is based on the area scan measurement applying a frequency dependent attenuation parameter. This attenuation parameter was empirically determined by analyzing a large number of phones. The MOTOROLA FAST SAR was developed and validated by the MOTOROLA Research Group in Ft. Lauderdale.

In the initial study, an approximation algorithm based on Linear fit was developed. The accuracy of the algorithm has been demonstrated across a broad frequency range (136-2450 MHz) and for both 1- and 10-g averaged SAR using a sample of 264 SAR measurements from 55 wireless handsets. For the sample size studied, the root-mean-squared errors of the algorithm are 1.2% and 5.8% for 1- and 10-g averaged SAR, respectively. The paper describing the algorithm in detail is expected to be published in August 2004 within the Special Issue of Transactions on MTT.

In the second step, the same research group optimized the fitting algorithm to an Polynomial fit whereby the frequency validity was extended to cover the range 30-6000MHz. Details of this study can be found in the BEMS 2007 Proceedings.

Both algorithms are implemented in DASYS software.

11 Conducted Output Power

11.1 Manufacturing tolerance

Table 11.1: GSM Speech

GSM 850			
Channel	Channel 251	Channel 190	Channel 128
Target (dBm)	33	33	33
Tolerance \pm (dB)	1	1	1
GSM 1900			
Channel	Channel 810	Channel 661	Channel 512
Target (dBm)	30	30	30
Tolerance \pm (dB)	1	1	1

Table 11.2: GPRS & EGPRS & 8PSK

GSM 850 GPRS&EGPRS (GMSK)				
Channel		251	190	128
1 Txslot	Target (dBm)	33	33	33
	Tolerance \pm (dB)	1	1	1
2 Txslots	Target (dBm)	32	32	32
	Tolerance \pm (dB)	1	1	1
3Txslots	Target (dBm)	30	30	30
	Tolerance \pm (dB)	1	1	1
4 Txslots	Target (dBm)	29	29	29
	Tolerance \pm (dB)	1	1	1
GSM 850 EGPRS (8PSK)				
Channel		251	190	128
1 Txslot	Target (dBm)	26.5	26.5	26.5
	Tolerance \pm (dB)	1	1	1
2 Txslots	Target (dBm)	26	26	26
	Tolerance \pm (dB)	1	1	1
3Txslots	Target (dBm)	23.5	23.5	23.5
	Tolerance \pm (dB)	1	1	1
4 Txslots	Target (dBm)	23	23	23
	Tolerance \pm (dB)	1	1	1
GSM 1900 GPRS&EGPRS (GMSK)				
Channel		810	661	512
1 Txslot	Target (dBm)	30	30	30
	Tolerance \pm (dB)	1	1	1
2 Txslots	Target (dBm)	29	29	29
	Tolerance \pm (dB)	1	1	1
3Txslots	Target (dBm)	28	28	28
	Tolerance \pm (dB)	1	1	1

4 Txslots	Target (dBm)	26	26	26
	Tolerance \pm (dB)	1	1	1
GSM 1900 EGPRS (8PSK)				
Channel		810	661	512
1 Txslot	Target (dBm)	25.5	25.5	25.5
	Tolerance \pm (dB)	1	1	1
2 Txslots	Target (dBm)	25	25	25
	Tolerance \pm (dB)	1	1	1
3Txslots	Target (dBm)	23	23	23
	Tolerance \pm (dB)	1	1	1
4 Txslots	Target (dBm)	22	22	22
	Tolerance \pm (dB)	1	1	1

Table 11.3: WCDMA

UMTS Band V		Conducted Power (dBm)		
		Channel 4233	Channel 4183	Channel 4132
CS	Target (dBm)	23	23	23
	Tolerance \pm (dB)	1	1	1
HSUPA sub-test 1	Target (dBm)	19	19	19
	Tolerance \pm (dB)	1	1	1
HSUPA sub-test 2	Target (dBm)	19	19	19
	Tolerance \pm (dB)	1	1	1
HSUPA sub-test 3	Target (dBm)	20	20	20
	Tolerance \pm (dB)	1	1	1
HSUPA sub-test 4	Target (dBm)	19	19	19
	Tolerance \pm (dB)	1	1	1
HSUPA sub-test 5	Target (dBm)	22	22	22
	Tolerance \pm (dB)	1	1	1
HSDPA sub-test 1-4	Target (dBm)	21	21	21
	Tolerance \pm (dB)	1	1	1
HSPA+ (16QAM)	Target (dBm)	19	19	19
	Tolerance \pm (dB)	1	1	1
UMTS Band IV		Conducted Power (dBm)		
		Channel 1513	Channel 1413	Channel 1312
CS	Target (dBm)	23	23	23
	Tolerance \pm (dB)	1	1	1
HSUPA sub-test 1	Target (dBm)	20	20	20
	Tolerance \pm (dB)	1	1	1
HSUPA sub-test 2	Target (dBm)	20	20	20
	Tolerance \pm (dB)	1	1	1
HSUPA sub-test 3	Target (dBm)	20	20	20
	Tolerance \pm (dB)	1	1	1
HSUPA	Target (dBm)	20	20	20

sub-test 4	Tolerance \pm (dB)	1	1	1
HSUPA sub-test 5	Target (dBm)	22	22	22
	Tolerance \pm (dB)	1	1	1
HSDPA sub-test 1-4	Target (dBm)	22	22	22
	Tolerance \pm (dB)	1	1	1
HSPA+ (16QAM)	Target (dBm)	20	20	20
	Tolerance \pm (dB)	1	1	1
UMTS Band II		Conducted Power (dBm)		
		Channel 9538	Channel 9400	Channel 9262
CS	Target (dBm)	23	23	23
	Tolerance \pm (dB)	1	1	1
HSUPA sub-test 1	Target (dBm)	20	20	20
	Tolerance \pm (dB)	1	1	1
HSUPA sub-test 2	Target (dBm)	20	20	20
	Tolerance \pm (dB)	1	1	1
HSUPA sub-test 3	Target (dBm)	21	21	21
	Tolerance \pm (dB)	1	1	1
HSUPA sub-test 4	Target (dBm)	20	20	20
	Tolerance \pm (dB)	1	1	1
HSUPA sub-test 5	Target (dBm)	22	22	22
	Tolerance \pm (dB)	1	1	1
HSDPA sub-test 1-4	Target (dBm)	22.5	22.5	22.5
	Tolerance \pm (dB)	1	1	1
HSPA+ (16QAM)	Target (dBm)	20	20	20
	Tolerance \pm (dB)	1	1	1

Table 11.4: LTE

LTE Band 2			
Channel	Channel 19100	Channel 18900	Channel 18700
Target (dBm)	23	23	23
Tolerance \pm (dB)	1	1	1
LTE Band 4			
Channel	Channel 20300	Channel 20175	Channel 20050
Target (dBm)	23	23	23
Tolerance \pm (dB)	1	1	1
LTE Band 5			
Channel	Channel 20600	Channel 20525	Channel 20450
Target (dBm)	22	22	22
Tolerance \pm (dB)	2	2	2
LTE Band 12			
Channel	Channel 23130	Channel 23095	Channel 23060
Target (dBm)	21	21	21
Tolerance \pm (dB)	2	2	2
LTE Band 17			
Channel	Channel 23130	Channel 23095	Channel 23060
Target (dBm)	22	22	22
Tolerance \pm (dB)	2	2	2

LTE MPR will follow up 3GPP setting as below:

Modulation	Channel bandwidth / Transmission bandwidth (NRB)						MPR (dB)
	1.4MHz	3.0MHz	5MHz	10MHz	15MHz	20MHz	
QPSK	> 5	> 4	> 8	> 12	> 16	> 18	1
16 QAM	\leq 5	\leq 4	\leq 8	\leq 12	\leq 16	\leq 18	1
16 QAM	> 5	> 4	> 8	> 12	> 16	> 18	2

Table 11.5: Bluetooth

Mode		Channel 1	Channel39	Channel 78
GFSK	Target (dBm)	7	7	7
	Tolerance \pm (dB)	1	1	1

Table 11.6: WiFi

Mode	Channel/Data rate	Target (dBm)	Tolerance \pm (dB)
802.11 b (2.4GHz)	1Mbps	13	1
	2Mbps	13	1
	5.5Mbps	13	1
	11Mbps	13	1
802.11 g (2.4GHz)	6-18Mbps	11	1
	24-36Mbps	11	1
	48-54Mbps	11	1
802.11 n (2.4GHz HT20)	MCS0-7	11	1

11.2 GSM Measurement result

During the process of testing, the EUT was controlled via Agilent Digital Radio Communication tester (E5515C) to ensure the maximum power transmission and proper modulation. This result contains conducted output power for the EUT. In all cases, the measured peak output power should be greater and within 5% than EMI measurement.

Table 11.7: The conducted power measurement results for GSM850/1900

GSM 850MHz	Conducted Power (dBm)		
	Channel 251(848.8MHz)	Channel 190(836.6MHz)	Channel 128(824.2MHz)
	33.36	33.28	33.15
GSM 1900MHz	Conducted Power (dBm)		
	Channel 810(1909.8MHz)	Channel 661(1880MHz)	Channel 512(1850.2MHz)
	30.65	30.72	30.51

Table 11.8: The conducted power measurement results for GPRS and EGPRS

GSM 850		Measured Power (dBm)			calculation	Average Power (dBm)		
		251	190	128		251	190	128
GPRS	1Txslots	33.36	33.28	33.15	-9.03dB	24.33	24.25	24.12
	2Txslots	32.68	32.59	32.47	-6.02dB	26.66	26.57	26.45
	3Txslots	30.91	30.82	30.68	-4.26dB	26.65	26.56	26.42
	4Txslots	29.72	29.64	29.47	-3.01dB	26.71	26.63	26.46
EGPRS (GMSK)	1Txslots	33.33	33.26	33.13	-9.03dB	24.30	24.23	24.10
	2Txslots	32.66	32.57	32.46	-6.02dB	26.64	26.55	26.44
	3Txslots	30.91	30.81	30.66	-4.26dB	26.65	26.55	26.40
	4Txslots	29.71	29.63	29.45	-3.01dB	26.70	26.62	26.44
EGPRS (8PSK)	1Txslots	26.17	26.23	26.29	-9.03dB	17.14	17.20	17.26
	2Txslots	25.28	25.37	25.28	-6.02dB	19.26	19.35	19.26
	3Txslots	23.56	23.45	23.64	-4.26dB	19.30	19.19	19.38
	4Txslots	22.68	22.38	22.44	-3.01dB	19.67	19.37	19.43
GSM 1900		Measured Power (dBm)			calculation	Average Power (dBm)		
		810	661	512		810	661	512
GPRS	1Txslots	30.65	30.72	30.51	-9.03dB	21.62	21.69	21.48
	2Txslots	29.89	29.89	29.56	-6.02dB	23.87	23.87	23.54
	3Txslots	28.01	27.83	27.31	-4.26dB	23.75	23.57	23.05
	4Txslots	26.80	26.54	26.01	-3.01dB	23.79	23.53	23.00
EGPRS (GMSK)	1Txslots	30.63	30.71	30.50	-9.03dB	21.60	21.68	21.47
	2Txslots	29.88	29.88	29.55	-6.02dB	23.86	23.86	23.53
	3Txslots	28.01	27.82	27.31	-4.26dB	23.75	23.56	23.05
	4Txslots	26.78	26.52	26.00	-3.01dB	23.77	23.51	22.99
EGPRS (8PSK)	1Txslots	25.10	25.01	25.01	-9.03dB	16.07	15.98	15.98
	2Txslots	24.68	24.81	24.41	-6.02dB	18.66	18.79	18.39
	3Txslots	22.50	22.97	22.54	-4.26dB	18.24	18.71	18.28
	4Txslots	21.32	21.79	21.36	-3.01dB	18.31	18.78	18.35

NOTES:

1) Division Factors

To average the power, the division factor is as follows:

1TX-slot = 1 transmit time slot out of 8 time slots=> conducted power divided by (8/1) => -9.03dB

2TX-slots = 2 transmit time slots out of 8 time slots=> conducted power divided by (8/2) => -6.02dB

3TX-slots = 3 transmit time slots out of 8 time slots=> conducted power divided by (8/3) => -4.26dB

4TX-slots = 4 transmit time slots out of 8 time slots=> conducted power divided by (8/4) => -3.01dB

According to the conducted power as above, the body measurements are performed with 4Txslots for GSM 850 and 2Txslots for GSM 1900.

11.3 WCDMA Measurement result

Table 11.9: The conducted Power for WCDMA850/1700/1900

Item	band	FDD V result		
	ARFCN	4233 (846.6MHz)	4182(836.4MHz)	4133 (826.4MHz)
WCDMA	\	23.02	22.97	23.22
HSUPA	1	19.79	19.87	19.77
	2	19.67	19.61	19.73
	3	20.68	20.62	20.81
	4	19.20	19.09	19.25
	5	22.03	21.94	22.13
HSDPA	1	21.71	21.64	21.82
	2	21.70	21.70	21.87
	3	21.75	21.72	21.88
	4	21.74	21.67	21.87
HSPA+ (16QAM)		19.76	19.77	19.81
Item	band	FDD IV result		
	ARFCN	1513 (1752.6MHz)	1413(1732.6MHz)	1312 (1712.4MHz)
WCDMA	\	23.60	23.70	23.70
HSUPA	1	20.60	20.80	20.80
	2	20.60	20.20	20.80
	3	20.60	20.80	20.80
	4	20.10	20.10	20.20
	5	22.70	22.60	22.80
HSDPA	1	22.60	22.60	22.70
	2	21.80	22.70	22.70
	3	22.10	22.20	22.30
	4	22.10	22.20	22.20
HSPA+ (16QAM)		20.78	20.68	20.69
Item	band	FDD II result		
	ARFCN	9538 (1907.6MHz)	9400 (1880MHz)	9262 (1852.4MHz)
WCDMA	\	23.67	23.51	23.73
HSUPA	1	20.64	20.38	20.37
	2	20.60	20.36	20.34
	3	21.60	21.35	21.34
	4	20.08	19.91	19.88
	5	23.14	22.89	22.89
HSDPA	1	22.57	22.91	22.90
	2	22.60	22.34	22.88
	3	22.58	22.34	22.88
	4	22.58	22.35	22.32
HSPA+ (16QAM)		20.82	20.65	20.72

11.4 LTE_FDD Measurement result

Table 11.10: The conducted Power for LTE-FDD

LTE-FDD Band 2				Actual output Power (dBm)			
Band-width	RBAllocation	RBoffset	Modulation	High	Middle	Low	
1.4 MHz				1909.3MHz	1880MHz	1850.7MHz	
	1RB	High	QPSK	23.48	23.48	23.52	
			16QAM	22.47	22.51	22.50	
		Middle	QPSK	23.46	23.49	23.52	
			16QAM	22.43	22.44	22.48	
		Low	QPSK	23.48	23.50	23.53	
			16QAM	22.48	22.51	22.54	
	3RB	High	QPSK	23.49	23.50	23.52	
			16QAM	22.33	22.48	22.37	
		Middle	QPSK	23.49	23.51	23.54	
			16QAM	22.33	22.51	22.39	
		Low	QPSK	23.56	23.46	23.57	
			16QAM	22.51	22.50	22.54	
	6RB	/	QPSK	22.49	22.51	22.53	
			16QAM	21.55	21.56	21.55	
	3 MHz				1908.5MHz	1880MHz	1851.5MHz
		1RB	High	QPSK	23.44	23.44	23.47
				16QAM	22.50	22.49	22.51
Middle			QPSK	23.46	23.51	23.52	
			16QAM	22.49	22.50	22.50	
Low			QPSK	23.43	23.47	23.52	
			16QAM	22.49	22.51	22.54	
8RB		High	QPSK	22.60	22.59	22.57	
			16QAM	21.58	21.58	21.59	
		Middle	QPSK	22.56	22.65	22.63	
			16QAM	21.62	21.60	21.59	
		Low	QPSK	22.60	22.62	22.64	
			16QAM	21.65	21.64	21.65	
15RB		/	QPSK	22.54	22.56	22.58	
			16QAM	21.55	21.56	21.55	

				1907.5MHz	1880MHz	1852.5MHz
5 MHz	1RB	High	QPSK	23.49	23.48	23.50
			16QAM	22.48	22.51	22.51
		Middle	QPSK	23.46	23.46	23.50
			16QAM	22.49	22.49	22.51
		Low	QPSK	23.44	23.48	23.53
			16QAM	22.51	22.51	22.54
	12RB	High	QPSK	22.55	22.59	22.62
			16QAM	21.60	21.59	21.62
		Middle	QPSK	22.60	22.59	22.58
			16QAM	21.67	21.58	21.67
		Low	QPSK	22.59	22.61	22.63
			16QAM	21.61	21.60	21.64
	25RB		QPSK	22.56	22.58	22.60
			16QAM	21.55	21.54	21.58
10 MHz				1905MHz	1880MHz	1855MHz
	1RB	High	QPSK	23.49	23.48	23.50
			16QAM	22.51	22.50	22.51
		Middle	QPSK	23.50	23.46	23.51
			16QAM	22.48	22.47	22.47
		Low	QPSK	23.46	23.49	23.53
			16QAM	22.50	22.50	22.53
	25RB	High	QPSK	22.59	22.61	22.63
			16QAM	21.63	21.68	21.65
		Middle	QPSK	22.59	22.60	22.62
			16QAM	21.63	21.69	21.69
		Low	QPSK	22.59	22.61	22.63
			16QAM	21.61	21.61	21.65
	50RB	/	QPSK	22.54	22.56	22.58
16QAM			21.56	21.59	21.61	

				1902.5MHz	1880MHz	1857.5MHz
15 MHz	1RB	High	QPSK	23.47	23.48	23.50
			16QAM	22.50	22.47	22.50
		Middle	QPSK	23.47	23.49	23.50
			16QAM	22.52	22.46	22.49
		Low	QPSK	23.45	23.50	23.54
			16QAM	22.49	22.50	22.54
	36RB	High	QPSK	22.60	22.61	22.63
			16QAM	21.60	21.68	21.65
		Middle	QPSK	22.62	22.61	22.62
			16QAM	21.63	21.59	21.59
		Low	QPSK	22.59	22.61	22.64
			16QAM	21.60	21.64	21.62
	75RB	/	QPSK	22.58	22.59	22.61
			16QAM	21.55	21.56	21.61
20 MHz				1900MHz	1880MHz	1860MHz
	1RB	High	QPSK	23.50	23.51	23.54
			16QAM	22.49	22.48	22.51
		Middle	QPSK	23.50	23.52	23.55
			16QAM	22.52	22.49	22.53
		Low	QPSK	23.49	23.54	23.56
			16QAM	22.51	22.52	22.56
	50RB	High	QPSK	22.59	22.61	22.63
			16QAM	21.61	21.60	21.62
		Middle	QPSK	22.59	22.61	22.60
			16QAM	21.60	21.62	21.65
		Low	QPSK	22.61	22.63	22.64
			16QAM	21.63	21.62	21.65
	100RB	/	QPSK	22.59	22.60	22.63
16QAM			21.57	21.58	21.61	

LTE-FDD Band 4				Actual output Power (dBm)		
Band-width	RBallocation	RBoffset	Modulation	High	Middle	Low
1.4 MHz				1754.3MHz	1732.5MHz	1710.7MHz
	1RB	High	QPSK	23.43	23.41	23.42
			16QAM	22.64	22.61	22.63
		Middle	QPSK	23.46	23.44	23.40
			16QAM	22.67	22.65	22.66
		Low	QPSK	23.44	23.45	23.42
			16QAM	22.64	22.67	22.63
	3RB	High	QPSK	23.43	23.42	23.43
			16QAM	22.47	22.46	22.44
		Middle	QPSK	23.45	23.42	23.46
			16QAM	22.49	22.46	22.45
		Low	QPSK	23.48	23.49	23.46
			16QAM	22.54	22.44	22.53
	6RB	/	QPSK	23.48	23.47	23.46
16QAM			22.49	22.45	22.44	
3 MHz				1753.5MHz	1732.5MHz	1711.5MHz
	1RB	High	QPSK	23.43	23.43	23.40
			16QAM	22.62	22.68	22.65
		Middle	QPSK	23.42	23.40	23.41
			16QAM	22.65	22.65	22.66
		Low	QPSK	23.47	23.47	23.43
			16QAM	22.64	22.66	22.65
	8RB	High	QPSK	22.55	22.58	22.50
			16QAM	21.57	21.57	21.59
		Middle	QPSK	22.49	22.52	22.54
			16QAM	21.51	21.51	21.52
		Low	QPSK	22.56	22.55	22.54
			16QAM	21.57	21.59	21.60
	15RB	/	QPSK	22.52	22.49	22.45
16QAM			21.53	21.51	21.50	

				1752.5MHz	1732.5MHz	1712.5MHz
5 MHz	1RB	High	QPSK	23.45	23.42	23.43
			16QAM	22.67	22.65	22.68
		Middle	QPSK	23.45	23.42	23.46
			16QAM	22.61	22.62	22.64
		Low	QPSK	23.48	23.44	23.41
			16QAM	22.68	22.64	22.63
	12RB	High	QPSK	22.50	22.52	22.54
			16QAM	21.56	21.53	21.55
		Middle	QPSK	22.54	22.52	22.49
			16QAM	21.54	21.52	21.54
		Low	QPSK	22.55	22.54	22.53
			16QAM	21.59	21.51	21.61
	25RB	/	QPSK	22.48	22.47	22.45
			16QAM	21.46	21.48	21.47
10 MHz				1750MHz	1732.5MHz	1715MHz
	1RB	High	QPSK	23.44	23.42	23.43
			16QAM	22.65	22.62	22.64
		Middle	QPSK	23.47	23.42	23.46
			16QAM	22.64	22.63	22.61
		Low	QPSK	23.48	23.44	23.45
			16QAM	22.67	22.66	22.65
	25RB	High	QPSK	22.54	22.53	22.53
			16QAM	21.57	21.54	21.55
		Middle	QPSK	22.55	22.54	22.53
			16QAM	21.57	21.61	21.57
		Low	QPSK	22.55	22.54	22.53
			16QAM	21.61	21.62	21.57
	50RB	/	QPSK	22.50	22.49	22.47
			16QAM	21.49	21.46	21.47

				1747.5MHz	1732.5MHz	1717.5MHz
15 MHz	1RB	High	QPSK	23.46	23.45	23.44
			16QAM	22.63	22.62	22.68
		Middle	QPSK	23.47	23.46	23.41
			16QAM	22.66	22.63	22.64
		Low	QPSK	23.48	23.46	23.42
			16QAM	22.67	22.65	22.66
	36RB	High	QPSK	22.56	22.54	22.53
			16QAM	21.54	21.57	21.54
		Middle	QPSK	22.55	22.54	22.54
			16QAM	21.57	21.61	21.54
		Low	QPSK	22.58	22.54	22.56
			16QAM	21.51	21.52	21.57
	75RB	/	QPSK	22.48	22.47	22.45
			16QAM	21.52	21.51	21.48
20 MHz				1745MHz	1732.5MHz	1720MHz
	1RB	High	QPSK	23.50	23.48	23.46
			16QAM	22.65	22.64	22.69
		Middle	QPSK	23.51	23.48	23.47
			16QAM	22.62	22.60	22.59
		Low	QPSK	23.54	23.48	23.47
			16QAM	22.69	22.64	22.65
	50RB	High	QPSK	22.56	22.54	22.53
			16QAM	21.57	21.55	21.57
		Middle	QPSK	22.56	22.54	22.53
			16QAM	21.57	21.52	21.55
		Low	QPSK	22.58	22.54	22.53
			16QAM	21.57	21.55	21.54
	100RB	/	QPSK	22.53	22.51	22.50
			16QAM	21.52	21.50	21.49

LTE-FDD Band 5				Actual output Power (dBm)		
Band-width	RAllocation	RBoffset	Modulation	High	Middle	Low
1.4 MHz				848.3MHz	836.5MHz	824.7MHz
	1RB	High	QPSK	23.26	23.25	23.21
			16QAM	22.35	22.34	22.29
		Middle	QPSK	23.28	23.26	23.24
			16QAM	22.35	22.36	22.33
		Low	QPSK	23.25	23.26	23.25
			16QAM	22.34	22.32	22.32
	3RB	High	QPSK	23.17	23.11	23.13
			16QAM	22.24	22.21	22.26
		Middle	QPSK	23.17	23.11	23.13
			16QAM	22.24	22.21	22.26
		Low	QPSK	23.14	23.11	23.14
			16QAM	22.30	22.26	22.25
	6RB	/	QPSK	22.24	22.25	22.24
16QAM			21.37	21.39	21.35	
3 MHz				847.5MHz	836.5MHz	825.5MHz
	1RB	High	QPSK	23.25	23.25	23.21
			16QAM	22.35	22.32	22.33
		Middle	QPSK	23.28	23.28	23.24
			16QAM	22.34	22.33	22.34
		Low	QPSK	23.24	23.27	23.24
			16QAM	22.34	22.35	22.31
	8RB	High	QPSK	22.27	22.23	22.25
			16QAM	21.35	21.33	21.39
		Middle	QPSK	22.25	22.24	22.25
			16QAM	21.39	21.35	21.38
		Low	QPSK	22.24	22.26	22.23
			16QAM	21.33	21.37	21.32
	15RB	/	QPSK	22.26	22.22	22.23
16QAM			21.35	21.34	21.33	
5 MHz				846.5MHz	836.5MHz	826.5MHz
	1RB	High	QPSK	23.21	23.19	23.20
			16QAM	22.33	22.30	22.31
		Middle	QPSK	23.27	23.25	23.21
			16QAM	22.33	22.32	22.35
		Low	QPSK	23.27	23.26	23.25
			16QAM	22.36	22.32	22.34
	12RB	High	QPSK	22.31	22.26	22.30
			16QAM	21.41	21.35	21.42
		Middle	QPSK	22.32	22.31	22.29
16QAM			21.36	21.37	21.41	

		Low	QPSK	22.35	22.34	22.32
			16QAM	21.40	21.38	21.35
	25RB	/	QPSK	22.31	22.27	22.25
			16QAM	21.41	21.39	21.38
10 MHz				844MHz	836.5MHz	829MHz
	1RB	High	QPSK	23.31	23.26	23.22
			16QAM	22.38	22.36	22.35
		Middle	QPSK	23.29	23.29	23.26
			16QAM	22.35	22.34	22.32
		Low	QPSK	23.28	23.26	23.24
			16QAM	22.35	22.36	22.33
	25RB	High	QPSK	22.34	22.32	22.30
			16QAM	21.35	21.34	21.33
		Middle	QPSK	22.32	22.31	22.30
			16QAM	21.39	21.41	21.39
		Low	QPSK	22.31	22.32	22.31
			16QAM	21.42	21.36	21.37
	50RB	/	QPSK	22.36	22.29	22.25
			16QAM	21.42	21.41	21.39

LTE-FDD Band 12				Actual output Power (dBm)		
Band-width	RAllocation	RBoffset	Modulation	High	Middle	Low
1.4 MHz				715.3MHz	707.5MHz	699.7MHz
	1RB	High	QPSK	21.97	21.96	21.95
			16QAM	21.09	21.09	21.10
		Middle	QPSK	21.94	21.89	21.99
			16QAM	21.10	20.94	21.05
		Low	QPSK	21.98	22.02	21.99
			16QAM	21.05	21.06	21.06
	3RB	High	QPSK	21.93	21.91	21.91
			16QAM	21.00	21.01	21.00
		Middle	QPSK	21.92	21.92	21.92
			16QAM	20.97	20.96	20.94
		Low	QPSK	21.94	21.91	21.94
			16QAM	20.99	20.98	20.99
	6RB	/	QPSK	20.96	20.94	20.93
16QAM			20.11	20.08	20.09	
3 MHz				714.5MHz	707.5MHz	700.5MHz
	1RB	High	QPSK	22.00	21.98	21.96
			16QAM	21.07	21.06	21.07
		Middle	QPSK	21.93	21.95	21.97
			16QAM	21.12	21.09	21.08
		Low	QPSK	22.00	22.00	21.99
			16QAM	21.06	21.06	21.06
	8RB	High	QPSK	21.07	21.07	21.05
			16QAM	20.04	20.04	20.05
		Middle	QPSK	21.00	21.00	20.98
			16QAM	20.08	20.07	20.03
		Low	QPSK	20.98	20.99	20.97
			16QAM	20.06	20.07	20.06
	15RB	/	QPSK	21.04	21.03	20.97
16QAM			20.05	20.04	20.03	
5 MHz				713.5MHz	707.5MHz	701.5MHz
	1RB	High	QPSK	21.98	21.97	21.97
			16QAM	21.11	21.08	21.08
		Middle	QPSK	21.98	21.93	21.89
			16QAM	21.19	21.15	21.11
		Low	QPSK	21.97	21.97	21.98
			16QAM	21.10	21.11	21.10
	12RB	High	QPSK	21.08	21.04	21.06
			16QAM	20.06	20.03	20.02
Middle		QPSK	20.94	20.98	20.96	



		Low	16QAM	20.04	20.05	20.06
			QPSK	20.99	21.00	20.99
		16QAM	20.08	20.09	20.08	
	25RB	/	QPSK	21.02	21.02	21.01
			16QAM	20.07	20.05	20.03
10 MHz				711MHz	707.5MHz	704MHz
	1RB	High	QPSK	22.01	22.00	22.00
			16QAM	21.09	21.03	21.04
		Middle	QPSK	21.95	21.93	21.90
			16QAM	21.03	21.13	21.07
		Low	QPSK	21.90	21.88	21.89
			16QAM	21.08	21.05	21.09
	25RB	High	QPSK	21.05	21.04	21.03
			16QAM	20.02	20.01	20.01
		Middle	QPSK	20.98	20.96	20.96
			16QAM	20.04	20.10	20.08
		Low	QPSK	21.01	21.00	20.98
			16QAM	20.05	20.03	20.06
	50RB	/	QPSK	21.16	21.17	20.95
			16QAM	20.09	20.05	20.04

LTE-FDD Band 17				Actual output Power (dBm)		
Band-width	RAllocation	ROffset	Modulation	High	Middle	Low
5 MHz				713.5MHz	710MHz	706.5MHz
	1RB	High	QPSK	23.45	23.45	23.48
			16QAM	21.53	21.52	21.54
		Middle	QPSK	23.41	23.41	23.43
			16QAM	21.53	21.52	21.56
		Low	QPSK	23.38	23.37	23.43
			16QAM	21.44	21.47	21.49
	12RB	High	QPSK	22.49	22.50	22.52
			16QAM	21.52	21.54	21.57
		Middle	QPSK	22.47	22.51	22.50
			16QAM	21.52	21.55	21.58
		Low	QPSK	22.45	22.48	22.49
			16QAM	21.56	21.59	21.60
	25RB	/	QPSK	22.54	22.56	22.57
16QAM			21.62	21.59	21.60	
10 MHz				711MHz	710MHz	709MHz
	1RB	High	QPSK	23.49	23.48	23.52
			16QAM	21.55	21.56	21.58
		Middle	QPSK	23.43	23.43	23.47
			16QAM	21.48	21.54	21.55
		Low	QPSK	23.42	23.42	23.47
			16QAM	21.52	21.52	21.54
	25RB	High	QPSK	22.50	22.51	22.55
			16QAM	21.53	21.56	21.59
		Middle	QPSK	22.50	22.50	22.52
			16QAM	21.53	21.51	21.60
		Low	QPSK	22.49	22.51	22.54
			16QAM	21.58	21.58	21.61
	50RB	/	QPSK	22.56	22.59	22.61
16QAM			21.60	21.63	21.66	



11.5 Wi-Fi and BT Measurement result

The output power of BT antenna is as following:

Mode	Conducted Power (dBm)		
	Channel 0 (2402MHz)	Channel 39 (2441MHz)	Channel 78 (2480MHz)
GFSK	7.21	7.55	7.27

The average conducted power for Wi-Fi is as following:

802.11b (dBm)

Channel\data rate	1Mbps	2Mbps	5.5Mbps	11Mbps
1(2412MHz)	13.45	13.48	13.48	13.29
6(2437MHz)	13.5	13.3	13.37	13.34
11(2462MHz)	13.38	13.4	13.46	13.13

802.11g (dBm)

Channel\data rate	6Mbps	9Mbps	12Mbps	18Mbps	24Mbps	36Mbps	48Mbps	54Mbps
1(2412MHz)	11.5	11.5	11.48	11.57	11.29	11.37	11.57	11.45
6(2437MHz)	11.5	11.48	11.62	11.73	11.48	11.47	11.46	11.52
11(2462MHz)	11.56	11.58	11.58	11.67	11.47	11.42	11.42	11.42

802.11n (dBm) - HT20 (2.4G)

Channel\data rate	MCS0	MCS1	MCS2	MCS3	MCS4	MCS5	MCS6	MCS7
1(2412MHz)	11.72	11.73	11.46	11.47	11.5	11.7	11.69	11.71
6(2437MHz)	11.57	11.31	11.35	11.36	11.42	11.49	11.47	11.47
11(2462MHz)	11.29	11.4	11.29	11.53	11.46	11.65	11.71	11.73

11.6 Spot Check Measurement result

Table 11.6-1: The conducted power results for WCDMA

Item	band	FDD V result		
	ARFCN	4233 (846.6MHz)	4182 (836.4MHz)	4132 (826.4MHz)
WCDMA	\	22.93	22.85	\
Item	band	FDD II result		
	ARFCN	9538 (1907.6MHz)	9400 (1880MHz)	9262 (1852.4MHz)
WCDMA	\	\	\	23.80
Item	band	FDD IV result		
	ARFCN	1513 (1752.6MHz)	1413 (1732.6MHz)	1312 (1712.4MHz)
WCDMA	\	\	23.62	\

Table 11.6-2: The conducted power results for LTE

LTE Band 2 20MHz-QPSK 1RB-Low	1900 (19100)	\
	1880 (18900)	\
	1860 (18700)	23.63
LTE Band 4 20MHz-QPSK 1RB-Low	1745 (20300)	23.60
	1732.5 (20175)	\
	1720 (20050)	\
LTE Band 5 10MHz-QPSK 1RB-Low	844 (20600)	23.40
	836.5 (20525)	\
	829 (20450)	\

12 Simultaneous TX SAR Considerations

12.1 Introduction

The following procedures adopted from “FCC SAR Considerations for Cell Phones with Multiple Transmitters” are applicable to handsets with built-in unlicensed transmitters such as 802.11 a/b/g and Bluetooth devices which may simultaneously transmit with the licensed transmitter.

For this device, the BT and Wi-Fi can transmit simultaneous with other transmitters.

12.2 Transmit Antenna Separation Distances

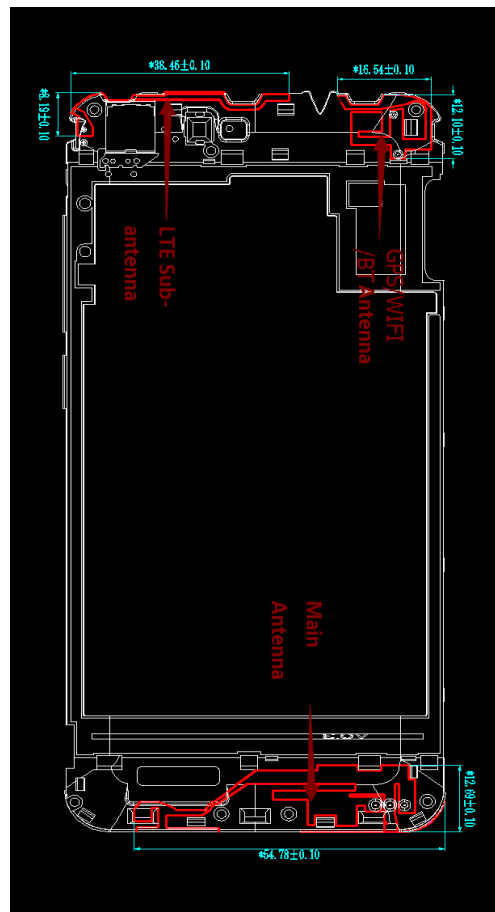

Picture 12.1 Antenna Locations

12.3 SAR Measurement Positions

According to the KDB941225 D06 Hot Spot SAR v01, the edges with less than 2.5 cm distance to the antennas need to be tested for SAR.

SAR measurement positions						
Mode	Front	Rear	Left edge	Right edge	Top edge	Bottom edge
Main antenna	Yes	Yes	Yes	Yes	No	Yes
WLAN	Yes	Yes	Yes	No	Yes	No

12.4 Standalone SAR Test Exclusion Considerations

Standalone 1-g head or body SAR evaluation by measurement or numerical simulation is not required when the corresponding SAR Exclusion Threshold condition, listed below, is satisfied. The 1-g SAR test exclusion threshold for 100 MHz to 6 GHz at test separation distances ≤ 50 mm are determined by:

$[(\text{max. power of channel, including tune-up tolerance, mW}) / (\text{min. test separation distance, mm})] \cdot [\sqrt{f(\text{GHz})}] \leq 3.0$ for 1-g SAR, where

- $f(\text{GHz})$ is the RF channel transmit frequency in GHz
- Power and distance are rounded to the nearest mW and mm before calculation
- The result is rounded to one decimal place for comparison

Table 12.1: Standalone SAR test exclusion considerations

Band/Mode	F(GHz)	Position	SAR test exclusion threshold (mW)	RF output power		SAR test exclusion
				dBm	mW	
Bluetooth	2.441	Head	9.60	8	6.31	Yes
		Body	19.20	8	6.31	Yes
2.4GHz WLAN 802.11 b	2.45	Head	9.58	14	25.12	No
		Body	19.17	14	25.12	No

13 Evaluation of Simultaneous

Table 13.1: The sum of reported SAR values for main antenna and WiFi

	Position	Main antenna	WiFi	Sum
Highest reported SAR value for Head	Left hand, Touch cheek	0.41	0.06	0.47
	Right hand, Touch cheek	0.30	0.19	0.49
Highest reported SAR value for Body	Rear	0.83	0.10	0.93

Table 13.2: The sum of reported SAR values for main antenna and Bluetooth

	Position	Main antenna	BT*	Sum
Highest reported SAR value for Head	Left hand, Touch cheek	0.41	0.26	0.67
	Right hand, Touch cheek	0.30	0.26	0.56
Highest reported SAR value for Body	Rear	0.83	0.13	0.96

BT* - Estimated SAR for Bluetooth (see the table 13.3)

Table 13.3: Estimated SAR for Bluetooth

Position	F (GHz)	Distance (mm)	Upper limit of power *		Estimated _{1g} (W/kg)
			dBm	mW	
Head	2.441	5	8	6.31	0.26
Body	2.441	10	8	6.31	0.13

* - Maximum possible output power declared by manufacturer

When standalone SAR test exclusion applies to an antenna that transmits simultaneously with other antennas, the standalone SAR must be estimated according to following to determine simultaneous transmission SAR test exclusion:

(max. power of channel, including tune-up tolerance, mW)/(min. test separation distance, mm) · [√f(GHz)/x] W/kg for test separation distances ≤ 50 mm;

where x = 7.5 for 1-g SAR.

When the minimum test separation distance is < 5 mm, a distance of 5 mm is applied to determine SAR test exclusion

Conclusion:

According to the above tables, the sum of reported SAR values is < 1.6W/kg. So the simultaneous transmission SAR with volume scans is not required.

14 SAR Test Result

It is determined by user manual for the distance between the EUT and the phantom bottom.

The distance is 10mm and just applied to the condition of body worn accessory.

It is performed for all SAR measurements with area scan based 1-g SAR estimation (Fast SAR). A zoom scan measurement is added when the estimated 1-g SAR is the highest measured SAR in each exposure configuration, wireless mode and frequency band combination or > 1.2W/kg.

The calculated SAR is obtained by the following formula:

$$\text{Reported SAR} = \text{Measured SAR} \times 10^{(P_{\text{Target}} - P_{\text{Measured}})/10}$$

Where P_{Target} is the power of manufacturing upper limit;

P_{Measured} is the measured power in chapter 11.

Table 14.1: Duty Cycle

Mode	Duty Cycle
Speech for GSM850/1900	1:8.3
GPRS&EGPRS for GSM850	1:2
GPRS&EGPRS for GSM1900	1:4
WCDMA850/1700/1900	1:1

14.1 SAR results for Fast SAR

According to the client request, we perform the spot check for head and body of each band respectively. If the spot check value is larger than the original value, the spot check value replaces the original values and others are quoted. Otherwise, all the original values are quoted directly. The results for GSM and Wi-Fi and BT antennas are the same as that of the original sample. The details are presented in the section 14.2. The original values are marked with “original” in the right column of data tables and the new tested values are marked with “new”.

Table 14.1: SAR Values (GSM 850 MHz Band - Head)

Frequency		Side	Test Position	Figure No.	Conducted Power (dBm)	Max. tune-up Power (dBm)	Measured SAR(10g) (W/kg)	Reported SAR(10g) (W/kg)	Measured SAR(1g) (W/kg)	Reported SAR(1g) (W/kg)	Power Drift (dB)
MHz	Ch.										
Ambient Temperature: 23.7 °C		Liquid Temperature: 23.2 °C									
836.6	190	Left	Touch	/	33.28	34	0.127	0.15	0.184	0.22	0.10
836.6	190	Left	Tilt	/	33.28	34	0.094	0.11	0.135	0.16	0.18
836.6	190	Right	Touch	Fig.1	33.28	34	0.187	0.22	0.253	0.30	-0.09
836.6	190	Right	Tilt	/	33.28	34	0.116	0.14	0.168	0.20	0.11
848.8	251	Right	Touch	/	33.36	34	0.149	0.17	0.204	0.24	-0.11
824.2	128	Right	Touch	/	33.15	34	0.066	0.08	0.090	0.11	-0.04

Table 14.2: SAR Values (GSM 850 MHz Band - Body) -AP OFF

Frequency		Test Position	Figure No.	Conducted Power (dBm)	Max. tune-up Power (dBm)	Measured SAR(10g) (W/kg)	Reported SAR(10g) (W/kg)	Measured SAR(1g) (W/kg)	Reported SAR(1g) (W/kg)	Power Drift (dB)
MHz	Ch.									
Ambient Temperature: 23.0 °C		Liquid Temperature: 22.5 °C								
836.6	190	Front	/	29.64	30	0.266	0.29	0.378	0.41	0.12
848.8	251	Rear	/	29.72	30	0.578	0.62	0.780	0.83	0.13
836.6	190	Rear	/	29.64	30	0.470	0.51	0.609	0.66	-0.02
824.2	128	Rear	/	29.47	30	0.378	0.43	0.509	0.58	-0.08
848.8	251	Rear EGPRS	/	29.71	30	0.564	0.60	0.755	0.81	0.08

Note1: The distance between the EUT and the phantom bottom is 10mm.

Table 14.3: SAR Values (GSM 850 MHz Band - Body) -AP ON

Frequency		Test Position	Figure No.	Conducted Power (dBm)	Max. tune-up Power (dBm)	Measured SAR(10g) (W/kg)	Reported SAR(10g) (W/kg)	Measured SAR(1g) (W/kg)	Reported SAR(1g) (W/kg)	Power Drift (dB)
MHz	Ch.									
Ambient Temperature: 23.0 °C		Liquid Temperature: 22.5 °C								
836.6	190	Front	/	29.64	30	0.266	0.29	0.378	0.41	0.12
848.8	251	Rear	Fig.2	29.72	30	0.578	0.62	0.780	0.83	0.13
836.6	190	Rear	/	29.64	30	0.470	0.51	0.609	0.66	-0.02

824.2	128	Rear	/	29.47	30	0.378	0.43	0.509	0.58	-0.08
836.6	190	Left	/	29.64	30	0.113	0.12	0.166	0.18	0.12
836.6	190	Right	/	29.64	30	0.204	0.22	0.309	0.34	0.15
836.6	190	Bottom	/	29.64	30	0.015	0.02	0.026	0.03	0.10
848.8	251	Rear EGPRS	/	29.71	30	0.564	0.60	0.755	0.81	0.08

Note1: The distance between the EUT and the phantom bottom is 10mm.

Table 14.4: SAR Values (GSM 1900 MHz Band - Head)

Frequency		Side	Test Position	Figure No.	Conducted Power (dBm)	Max. tune-up Power (dBm)	Ambient Temperature: 23.3°C		Liquid Temperature: 22.8°C		Power Drift (dB)
MHz	Ch.						Measured SAR(10g) (W/kg)	Reported SAR(10g) (W/kg)	Measured SAR(1g) (W/kg)	Reported SAR(1g) (W/kg)	
1880	661	Left	Touch	/	30.72	31	0.068	0.07	0.120	0.13	0.08
1880	661	Left	Tilt	/	30.72	31	0.055	0.06	0.098	0.10	0.17
1880	661	Right	Touch	Fig.3	30.72	31	0.080	0.09	0.131	0.14	-0.14
1880	661	Right	Tilt	/	30.72	31	0.062	0.07	0.103	0.11	0.15
1909.8	810	Left	Touch	/	30.65	31	0.053	0.06	0.092	0.10	-0.10
1850.2	512	Left	Touch	/	30.51	31	0.058	0.06	0.092	0.10	0.13

Table 14.5: SAR Values (GSM 1900 MHz Band - Body) -AP OFF

Frequency		Test Position	Figure No.	Conducted Power (dBm)	Max. tune-up Power (dBm)	Ambient Temperature: 22.5°C		Liquid Temperature: 22.0°C		Power Drift (dB)
MHz	Ch.					Measured SAR(10g) (W/kg)	Reported SAR(10g) (W/kg)	Measured SAR(1g) (W/kg)	Reported SAR(1g) (W/kg)	
1880	661	Front	/	29.89	30	0.184	0.19	0.305	0.31	0.13
1909.8	810	Rear	/	29.89	30	0.268	0.27	0.454	0.47	0.16
1880	661	Rear	/	29.89	30	0.290	0.30	0.478	0.49	0.14
1850.2	512	Rear	/	29.56	30	0.253	0.28	0.422	0.47	0.11
1880	661	RearEGPRS	/	29.88	30	0.280	0.29	0.466	0.48	0.16

Note1: The distance between the EUT and the phantom bottom is 10mm.

Table 14.6: SAR Values (GSM 1900 MHz Band - Body) -AP ON

Frequency		Test Position	Figure No.	Conducted Power (dBm)	Max. tune-up Power (dBm)	Ambient Temperature: 22.5°C		Liquid Temperature: 22.0°C		Power Drift (dB)
MHz	Ch.					Measured SAR(10g) (W/kg)	Reported SAR(10g) (W/kg)	Measured SAR(1g) (W/kg)	Reported SAR(1g) (W/kg)	
1880	661	Front	/	29.89	30	0.184	0.19	0.305	0.31	0.13
1909.8	810	Rear	/	29.89	30	0.268	0.27	0.454	0.47	0.16
1880	661	Rear	Fig.4	29.89	30	0.290	0.30	0.478	0.49	0.14
1850.2	512	Rear	/	29.56	30	0.253	0.28	0.422	0.47	0.11

1880	661	Left	/	29.89	30	0.037	0.04	0.063	0.06	-0.14
1880	661	Right	/	29.89	30	0.129	0.13	0.234	0.24	-0.15
1880	661	Bottom	/	29.89	30	0.108	0.11	0.200	0.21	0.05
1880	661	RearEGPRS	/	29.88	30	0.280	0.29	0.466	0.48	0.16

Note1: The distance between the EUT and the phantom bottom is 10mm.

Table 14.7: SAR Values (WCDMA 850 MHz Band - Head)

Frequency		Side	Test Position	Figure No.	Conducted Power (dBm)	Max. tune-up Power (dBm)	Measured SAR(10g) (W/kg)	Reported SAR(10g) (W/kg)	Measured SAR(1g) (W/kg)	Reported SAR(1g) (W/kg)	Power Drift (dB)	Note
MHz	Ch.											
				Ambient Temperature: 23.3°C				Liquid Temperature: 22.8°C				
836.4	4182	Left	Touch	/	22.97	24	0.078	0.10	0.113	0.14	0.11	original
836.4	4182	Left	Tilt	/	22.97	24	0.063	0.08	0.091	0.12	0.14	original
836.4	4182	Right	Touch	Fig.5	22.97	24	0.132	0.17	0.180	0.23	-0.07	original
836.4	4182	Right	Tilt	/	22.97	24	0.077	0.10	0.111	0.14	0.10	original
846.6	4233	Right	Touch	/	23.02	24	0.111	0.14	0.153	0.19	-0.16	original
826.4	4132	Right	Touch	/	23.22	24	0.068	0.08	0.092	0.11	-0.12	original
836.4	4182	Right	Touch	/	22.85	24	0.100	0.13	0.135	0.18	0.05	new

Table 14.8: SAR Values (WCDMA 850 MHz Band - Body) -AP OFF

Frequency		Test Position	Figure No.	Conducted Power (dBm)	Max. tune-up Power (dBm)	Measured SAR(10g) (W/kg)	Reported SAR(10g) (W/kg)	Measured SAR(1g) (W/kg)	Reported SAR(1g) (W/kg)	Power Drift (dB)	Note	
MHz	Ch.											
				Ambient Temperature: 22.5°C				Liquid Temperature: 22.0°C				
836.4	4182	Front	/	22.97	24	0.100	0.13	0.146	0.19	0.13	original	
846.6	4233	Rear	/	23.02	24	0.234	0.29	0.313	0.39	0.05	original	
836.4	4182	Rear	/	22.97	24	0.218	0.28	0.285	0.36	0.02	original	
826.4	4132	Rear	/	23.22	24	0.200	0.24	0.266	0.32	0.08	original	
846.6	4233	Rear	/	22.93	24	0.205	0.26	0.273	0.35	0.10	new	

Note1: The distance between the EUT and the phantom bottom is 10mm.

Table 14.9: SAR Values (WCDMA 850 MHz Band - Body) -AP ON

Frequency		Test Position	Figure No.	Conducted Power (dBm)	Max. tune-up Power (dBm)	Measured SAR(10g) (W/kg)	Reported SAR(10g) (W/kg)	Measured SAR(1g) (W/kg)	Reported SAR(1g) (W/kg)	Power Drift (dB)	Note	
MHz	Ch.											
				Ambient Temperature: 22.5°C				Liquid Temperature: 22.0°C				
836.4	4182	Front	/	22.97	24	0.100	0.13	0.146	0.19	0.13	original	



846.6	4233	Rear	Fig.6	23.02	24	0.234	0.29	0.313	0.39	0.05	original
836.4	4182	Rear	/	22.97	24	0.218	0.28	0.285	0.36	0.02	original
826.4	4132	Rear	/	23.22	24	0.200	0.24	0.266	0.32	0.08	original
836.4	4182	Left	/	22.97	24	0.151	0.19	0.223	0.28	0.13	original
836.4	4182	Right	/	22.97	24	0.166	0.21	0.248	0.31	0.15	original
836.4	4182	Bottom	/	22.97	24	0.014	0.02	0.026	0.03	0.14	original
846.6	4233	Rear	/	22.93	24	0.205	0.26	0.273	0.35	0.10	new

Note1: The distance between the EUT and the phantom bottom is 10mm.

Table 14.10: SAR Values (WCDMA 1900 MHz Band - Head)

Frequency		Side	Test Position	Figure No.	Conducted Power (dBm)	Max. tune-up Power (dBm)	Measured SAR(10g) (W/kg)	Reported SAR(10g) (W/kg)	Measured SAR(1g) (W/kg)	Reported SAR(1g) (W/kg)	Power Drift (dB)	Note
MHz	Ch.											
Ambient Temperature: 23.3°C Liquid Temperature: 22.8°C												
1880	9400	Left	Touch	/	23.51	24	0.179	0.20	0.293	0.33	0.08	original
1880	9400	Left	Tilt	/	23.51	24	0.117	0.13	0.215	0.24	0.13	original
1880	9400	Right	Touch	/	23.51	24	0.072	0.08	0.121	0.14	0.17	original
1880	9400	Right	Tilt	/	23.51	24	0.094	0.11	0.171	0.19	0.17	original
1907.6	9538	Left	Touch	/	23.67	24	0.169	0.18	0.277	0.30	0.06	original
1852.4	9262	Left	Touch	Fig.7	23.73	24	0.200	0.21	0.323	0.34	0.05	original
1852.4	9262	Left	Touch	/	23.80	24	0.193	0.20	0.31	0.32	0.15	new

Table 14.11: SAR Values (WCDMA 1900 MHz Band - Body)– AP OFF

Frequency		Test Position	Figure No.	Conducted Power (dBm)	Max. tune-up Power (dBm)	Measured SAR(10g) (W/kg)	Reported SAR(10g) (W/kg)	Measured SAR(1g) (W/kg)	Reported SAR(1g) (W/kg)	Power Drift (dB)	Note
MHz	Ch.										
Ambient Temperature: 22.5°C Liquid Temperature: 22.0°C											
1880	9400	Front	/	23.51	24	0.173	0.19	0.280	0.31	0.04	original
1907.6	9538	Rear	/	23.67	24	0.251	0.27	0.421	0.45	0.02	original
1880	9400	Rear	/	23.51	24	0.245	0.27	0.406	0.45	0.07	original
1852.4	9262	Rear	/	23.73	24	0.267	0.28	0.428	0.46	0.09	original
1852.4	9262	Rear	/	23.80	24	0.260	0.27	0.427	0.45	0.02	new

Note1: The distance between the EUT and the phantom bottom is 10 mm.

Table 14.12: SAR Values (WCDMA 1900 MHz Band - Body) – AP ON

Frequency		Test Position	Figure No.	Conducted Power (dBm)	Max. tune-up Power (dBm)	Measured SAR(10g) (W/kg)	Reported SAR(10g) (W/kg)	Measured SAR(1g) (W/kg)	Reported SAR(1g) (W/kg)	Power Drift (dB)	Note
MHz	Ch.										
Ambient Temperature: 22.5°C Liquid Temperature: 22.0°C											
1880	9400	Front	/	23.51	24	0.173	0.19	0.280	0.31	0.04	original
1907.6	9538	Rear	/	23.67	24	0.251	0.27	0.421	0.45	0.02	original
1880	9400	Rear	/	23.51	24	0.245	0.27	0.406	0.45	0.07	original
1852.4	9262	Rear	Fig.8	23.73	24	0.267	0.28	0.428	0.46	0.09	original
1880	9400	Left	/	23.51	24	0.111	0.12	0.196	0.22	0.10	original
1880	9400	Right	/	23.51	24	0.045	0.05	0.075	0.08	0.11	original
1880	9400	Bottom	/	23.51	24	0.123	0.14	0.215	0.24	-0.02	original
1852.4	9262	Rear	/	23.80	24	0.260	0.27	0.427	0.45	0.02	new

Note1: The distance between the EUT and the phantom bottom is 10mm.

Table 14.13: SAR Values (WCDMA 1700 MHz Band - Head)

Frequency		Side	Test Position	Figure No.	Conducted Power (dBm)	Max. tune-up Power (dBm)	Measured SAR(10g) (W/kg)	Reported SAR(10g) (W/kg)	Measured SAR(1g) (W/kg)	Reported SAR(1g) (W/kg)	Power Drift (dB)	Note
MHz	Ch.											
Ambient Temperature: 23.3°C Liquid Temperature: 22.8°C												
1732.6	1413	Left	Touch	/	23.70	24	0.132	0.14	0.229	0.25	0.08	original
1732.6	1413	Left	Tilt	/	23.70	24	0.061	0.07	0.102	0.11	0.13	original
1752.6	1513	Right	Touch	/	23.60	24	0.167	0.18	0.257	0.28	0.17	original
1732.6	1413	Right	Touch	Fig.9	23.70	24	0.174	0.19	0.266	0.29	-0.03	original
1712.4	1312	Right	Touch	/	23.70	24	0.164	0.18	0.248	0.27	0.06	original
1732.6	1413	Right	Tilt	/	23.70	24	0.081	0.09	0.139	0.15	0.02	original
1732.6	1413	Right	Touch	/	23.62	24	0.146	0.16	0.232	0.25	0.04	new

Table 14.14: SAR Values (WCDMA 1700 MHz Band - Body)– AP OFF

Frequency		Test Position	Figure No.	Conducted Power (dBm)	Max. tune-up Power (dBm)	Measured SAR(10g) (W/kg)	Reported SAR(10g) (W/kg)	Measured SAR(1g) (W/kg)	Reported SAR(1g) (W/kg)	Power Drift (dB)	Note
MHz	Ch.										
Ambient Temperature: 22.5°C Liquid Temperature: 22.0°C											
1732.6	1413	Front	/	23.70	24	0.305	0.33	0.491	0.53	0.04	original
1752.6	1513	Rear	/	23.60	24	0.326	0.36	0.509	0.56	0.03	original
1732.6	1413	Rear	/	23.70	24	0.408	0.44	0.635	0.68	-0.01	original
1712.4	1312	Rear	/	23.70	24	0.340	0.36	0.534	0.57	0.08	original
1732.6	1413	Rear	/	23.62	24	0.348	0.38	0.544	0.59	0.11	new

Note1: The distance between the EUT and the phantom bottom is 10 mm.

Table 14.15: SAR Values (WCDMA 1700 MHz Band - Body) – AP ON

Frequency		Test Position	Figure No.	Conducted Power (dBm)	Max. tune-up Power (dBm)	Measured SAR(10g) (W/kg)	Reported SAR(10g) (W/kg)	Measured SAR(1g) (W/kg)	Reported SAR(1g) (W/kg)	Power Drift (dB)	Note
MHz	Ch.										
Ambient Temperature: 22.5°C Liquid Temperature: 22.0°C											
1732.6	1413	Front	/	23.70	24	0.305	0.33	0.491	0.53	0.04	original
1752.6	1513	Rear	/	23.60	24	0.326	0.36	0.509	0.56	0.03	original
1732.6	1413	Rear	Fig.10	23.70	24	0.408	0.44	0.635	0.68	-0.01	original
1712.4	1312	Rear	/	23.70	24	0.340	0.36	0.534	0.57	0.08	original
1732.6	1413	Left	/	23.70	24	0.15	0.16	0.226	0.24	0.10	original



1732.6	1413	Right	/	23.70	24	0.056	0.06	0.098	0.11	0.11	original
1732.6	1413	Bottom	/	23.70	24	0.215	0.23	0.372	0.40	-0.02	original
1732.6	1413	Rear	/	23.62	24	0.348	0.38	0.544	0.59	0.11	new

Note1: The distance between the EUT and the phantom bottom is 10mm.

Table 14.16: SAR Values (LTE Band 2-Head)

Frequency		Ambient Temperature: 23.3°C					Liquid Temperature: 22.8°C					
MHz	Ch.	Configuration	Test Position	Conducted Power (dBm)	Max. tune-up Power (dBm)	Figure No.	Measured SAR(10g) (W/kg)	Reported SAR(10g) (W/kg)	Measured SAR(1g) (W/kg)	Reported SAR(1g) (W/kg)	Power Drift (dB)	note
1900	19100	1RB_Low	Left Touch	23.51	24	/	0.219	0.25	0.357	0.40	0.11	original
1880	18900	1RB_Low	Left Touch	23.54	24	/	0.223	0.25	0.368	0.40	0.06	original
1860	18700	1RB_Low	Left Touch	23.56	24	Fig.11	0.226	0.25	0.373	0.41	0.07	original
1860	18700	1RB_Low	Left Tilt	23.56	24	/	0.141	0.16	0.26	0.29	0.11	original
1860	18700	50RB_Low	Left Touch	22.64	23	/	0.134	0.15	0.231	0.25	0.10	original
1860	18700	50RB_Low	Left Tilt	22.64	23	/	0.111	0.12	0.205	0.22	-0.07	original
1860	18700	50RB_Low	Right Touch	23.56	24	/	0.135	0.15	0.227	0.25	0.13	original
1860	18700	50RB_Low	Right Tilt	23.56	24	/	0.100	0.11	0.179	0.20	0.18	original
1860	18700	50RB_Low	Right Touch	22.64	23	/	0.104	0.11	0.178	0.19	0.08	original
1860	18700	50RB_Low	Right Tilt	22.64	23	/	0.082	0.09	0.149	0.16	0.17	original
1860	18700	1RB_Low	Left Touch	23.63	24	/	0.231	0.25	0.364	0.40	0.10	new

Table 14.17: SAR Values (LTE Band 2-Body) – AP OFF

Frequency		Ambient Temperature: 23.4°C					Liquid Temperature: 22.9°C					
MHz	Ch.	Configuration	Test Position	Conducted Power (dBm)	Max. tune-up Power (dBm)	Figure No.	Measured SAR(10g) (W/kg)	Reported SAR(10g) (W/kg)	Measured SAR(1g) (W/kg)	Reported SAR(1g) (W/kg)	Power Drift (dB)	note
1860	18700	1RB_Low	Front	23.56	24	/	0.215	0.24	0.351	0.39	0.05	original
1860	18700	50RB_Low	Front	22.64	23	/	0.174	0.19	0.285	0.31	0.10	original
1900	19100	1RB_Low	Rear	23.51	24	/	0.232	0.26	0.387	0.43	0.07	original

1880	18900	50RB_ Low	Rear	23.54	24	/	0.247	0.27	0.396	0.44	0.19	original
1860	18700	1RB_ Low	Rear	23.56	24	/	0.254	0.28	0.411	0.45	0.11	original
1860	18700	50RB_ Low	Rear	22.64	23	/	0.196	0.21	0.325	0.35	0.14	original
1860	18700	1RB_ Low	Rear	23.63	24	/	0.266	0.29	0.395	0.43	0.10	new

Note: The distance between the EUT and the phantom bottom is 10mm.

Table 14.18: SAR Values (LTE Band 2-Body) – AP ON

Frequency		Configuration	Test Position	Conducted Power (dBm)	Max. tune-up Power (dBm)	Figure No.	Ambient Temperature: 23.4 °C		Liquid Temperature: 22.9 °C		Power Drift (dB)	note
MHz	Ch.						Measured SAR(10g) (W/kg)	Reported SAR(10g) (W/kg)	Measured SAR(1g) (W/kg)	Reported SAR(1g) (W/kg)		
1860	18700	1RB_ Low	Front	23.56	24	/	0.215	0.24	0.351	0.39	0.05	original
1860	18700	50RB_ Low	Front	22.64	23	/	0.174	0.19	0.285	0.31	0.10	original
1900	19100	1RB_ Low	Rear	23.51	24	/	0.232	0.26	0.387	0.43	0.07	original
1880	18900	1RB_ Low	Rear	23.54	24	/	0.247	0.27	0.396	0.44	0.19	original
1860	18700	1RB_ Low	Rear	23.56	24	Fig.12	0.254	0.28	0.411	0.45	0.11	original
1860	18700	50RB_ Low	Rear	22.64	23	/	0.196	0.21	0.325	0.35	0.14	original
1860	18700	1RB_ Low	Right	23.56	24	/	0.054	0.06	0.089	0.10	0.15	original
1860	18700	50RB_ Low	Right	22.64	23	/	0.042	0.05	0.069	0.07	0.19	original
1860	18700	1RB_ Low	Left	23.56	24	/	0.138	0.15	0.248	0.27	-0.12	original
1860	18700	50RB_ Low	Left	22.64	23	/	0.104	0.11	0.189	0.21	-0.08	original
1860	18700	1RB_ Low	Bottom	23.56	24	/	0.164	0.18	0.282	0.31	-0.12	original
1860	18700	50RB_ Low	Bottom	22.64	23	/	0.114	0.12	0.197	0.21	-0.06	original
1860	18700	1RB_ Low	Rear	23.63	24	/	0.266	0.29	0.395	0.43	0.10	new

Note: The distance between the EUT and the phantom bottom is 10mm.

Table 14.19: SAR Values (LTE Band 4-Head)

Frequency		Ambient Temperature: 23.3°C					Liquid Temperature: 22.8°C					
MHz	Ch.	Configuration	Test Position	Conducted Power (dBm)	Max. tune-up Power (dBm)	Figure No.	Measured SAR(10g) (W/kg)	Reported SAR(10g) (W/kg)	Measured SAR(1g) (W/kg)	Reported SAR(1g) (W/kg)	Power Drift (dB)	note
1745	20300	1RB_Low	Left Touch	23.54	24	Fig.13	0.213	0.24	0.334	0.37	0.13	original
1732.5	20175	1RB_Low	Left Touch	23.48	24	/	0.206	0.23	0.322	0.36	0.08	original
1720	20050	1RB_Low	Left Touch	23.47	24	/	0.205	0.23	0.318	0.36	0.02	original
1745	20300	1RB_Low	Left Tilt	23.54	24	/	0.160	0.18	0.269	0.30	0.12	original
1745	20300	50RB_Low	Left Touch	23.54	24	/	0.113	0.13	0.187	0.21	0.07	original
1745	20300	50RB_Low	Left Tilt	23.54	24	/	0.085	0.09	0.146	0.16	0.13	original
1745	20300	50RB_Low	Right Touch	22.58	23	/	0.160	0.18	0.269	0.30	0.08	original
1745	20300	50RB_Low	Right Tilt	22.58	23	/	0.095	0.10	0.168	0.19	0.15	original
1745	20300	50RB_Low	Right Touch	22.58	23	/	0.092	0.10	0.153	0.17	0.09	original
1745	20300	50RB_Low	Right Tilt	22.58	23	/	0.067	0.07	0.113	0.12	0.18	original
1745	20300	1RB_Low	Left Touch	23.60	24	/	0.205	0.22	0.326	0.36	0.10	new

Table 14.20: SAR Values (LTE Band 4-Body) – AP OFF

Frequency		Ambient Temperature: 23.4°C					Liquid Temperature: 22.9°C					
MHz	Ch.	Configuration	Test Position	Conducted Power (dBm)	Max. tune-up Power (dBm)	Figure No.	Measured SAR(10g) (W/kg)	Reported SAR(10g) (W/kg)	Measured SAR(1g) (W/kg)	Reported SAR(1g) (W/kg)	Power Drift (dB)	note
1745	20300	1RB_Low	Front	23.54	24	/	0.229	0.25	0.359	0.40	0.06	original
1745	20300	50RB_Low	Front	22.58	23	/	0.184	0.20	0.29	0.32	0.05	original
1745	20300	1RB_Low	Rear	23.54	24	/	0.434	0.48	0.686	0.76	0.01	original

1732.5	20175	1RB_Low	Rear	23.48	24	/	0.423	0.48	0.667	0.75	0.07	original
1720	20050	1RB_Low	Rear	23.47	24	/	0.401	0.45	0.632	0.71	0.10	original
1745	20300	50RB_Low	Rear	22.58	23	/	0.245	0.27	0.398	0.44	0.08	original
1860	18700	1RB_Low	Rear	23.60	24	/	0.380	0.42	0.605	0.66	0.08	new

Note: The distance between the EUT and the phantom bottom is 10mm.

Table 14.21: SAR Values (LTE Band 4-Body) – AP ON

Frequency		Ambient Temperature: 23.4 °C						Liquid Temperature: 22.9 °C					
MHz	Ch.	Configuration	Test Position	Conducted Power (dBm)	Max. tune-up Power (dBm)	Figure No.	Measured SAR(10g) (W/kg)	Reported SAR(10g) (W/kg)	Measured SAR(1g) (W/kg)	Reported SAR(1g) (W/kg)	Power Drift (dB)	note	
1745	20300	1RB_Low	Front	23.54	24	/	0.229	0.25	0.359	0.40	0.06	original	
1745	20300	50RB_Low	Front	22.58	23	/	0.184	0.20	0.29	0.32	0.05	original	
1745	20300	1RB_Low	Rear	23.54	24	/	0.434	0.48	0.686	0.76	0.01	original	
1732.5	20175	1RB_Low	Rear	23.48	24	/	0.423	0.48	0.667	0.75	0.07	original	
1720	20050	1RB_Low	Rear	23.47	24	Fig.14	0.401	0.45	0.632	0.71	0.10	original	
1745	20300	50RB_Low	Rear	22.58	23	/	0.245	0.27	0.398	0.44	0.08	original	
1745	20300	1RB_Low	Bottom	23.54	24	/	0.207	0.23	0.361	0.40	0.10	original	
1745	20300	50RB_Low	Bottom	22.58	23	/	0.165	0.18	0.287	0.32	0.13	original	
1745	20300	1RB_Low	Right	23.54	24	/	0.051	0.06	0.089	0.10	-0.16	original	
1745	20300	50RB_Low	Right	22.58	23	/	0.041	0.05	0.07	0.08	-0.18	original	
1745	20300	1RB_Low	Left	23.54	24	/	0.117	0.13	0.215	0.24	0.19	original	
1745	20300	50RB_Low	Left	22.58	23	/	0.095	0.10	0.174	0.19	0.12	original	
1860	18700	1RB_Low	Rear	23.60	24	/	0.380	0.42	0.605	0.66	0.08	new	

Note: The distance between the EUT and the phantom bottom is 10mm.

Table 14.22: SAR Values (LTE Band 5-Head)

Frequency		Ambient Temperature: 23.3°C					Liquid Temperature: 22.8°C					
MHz	Ch.	Configuration	Test Position	Conducted Power (dBm)	Max. tune-up Power (dBm)	Figure No.	Measured SAR(10g) (W/kg)	Reported SAR(10g) (W/kg)	Measured SAR(1g) (W/kg)	Reported SAR(1g) (W/kg)	Power Drift (dB)	note
844	20600	1RB_High	Left Touch	23.31	24	/	0.059	0.07	0.082	0.10	-0.10	original
836.5	20525	1RB_High	Left Touch	23.26	24	/	0.053	0.06	0.074	0.09	-0.12	original
829	20450	1RB_High	Left Touch	23.22	24	/	0.056	0.07	0.078	0.09	-0.06	original
844	20600	25RB_High	Left Touch	22.34	23	/	0.043	0.05	0.062	0.07	0.13	original
844	20600	1RB_High	Left Tilt	23.31	24	/	0.031	0.04	0.045	0.05	0.11	original
844	20600	25RB_High	Left Tilt	22.34	23	/	0.025	0.03	0.036	0.04	0.18	original
844	20600	1RB_High	Right Touch	23.31	24	/	0.043	0.05	0.064	0.08	0.02	original
844	20600	25RB_High	Right Touch	22.34	23	/	0.036	0.04	0.053	0.06	0.08	original
844	20600	1RB_High	Right Tilt	23.31	24	/	0.017	0.02	0.024	0.03	0.12	original
844	20600	25RB_High	Right Tilt	22.34	23	/	0.014	0.02	0.021	0.02	0.16	original
844	20600	1RB_High	Left Touch	23.40	24	Fig.15	0.116	0.13	0.161	0.18	0.07	new

Table 14.23: SAR Values (LTE Band 5-Body) – AP OFF

Frequency		Ambient Temperature: 23.4°C					Liquid Temperature: 22.9°C					
MHz	Ch.	Configuration	Test Position	Conducted Power (dBm)	Max. tune-up Power (dBm)	Figure No.	Measured SAR(10g) (W/kg)	Reported SAR(10g) (W/kg)	Measured SAR(1g) (W/kg)	Reported SAR(1g) (W/kg)	Power Drift (dB)	note
844	20600	1RB_High	Front	23.31	24	/	0.115	0.13	0.162	0.19	0.08	original
844	20600	25RB_High	Front	22.34	23	/	0.085	0.10	0.12	0.14	0.05	original
844	20600	1RB_High	Rear	23.31	24	Fig.16	0.247	0.29	0.317	0.37	0.04	original

836.5	20525	1RB_High	Rear	23.26	24	/	0.239	0.28	0.305	0.36	0.10	original
829	20450	1RB_High	Rear	23.22	24	/	0.217	0.26	0.280	0.34	0.13	original
844	20600	25RB_High	Rear	22.34	23	/	0.151	0.18	0.214	0.25	0.05	original
844	20600	1RB_High	Rear	23.40	24	/	0.199	0.23	0.263	0.30	0.08	new

Note: The distance between the EUT and the phantom bottom is 10mm.

Table 14.24: SAR Values (LTE Band 5-Body) – AP ON

Frequency		Configuration	Test Position	Conducted Power (dBm)	Max. tune-up Power (dBm)	Figure No.	Measured SAR(10g) (W/kg)	Reported SAR(10g) (W/kg)	Measured SAR(1g) (W/kg)	Reported SAR(1g) (W/kg)	Power Drift (dB)	note
MHz	Ch.											
		Ambient Temperature: 23.4 °C Liquid Temperature: 22.9 °C										
844	20600	1RB_High	Front	23.31	24	/	0.115	0.13	0.162	0.19	0.08	original
844	20600	25RB_High	Front	22.34	23	/	0.085	0.10	0.12	0.14	0.05	original
844	20600	1RB_High	Rear	23.31	24	Fig.17	0.247	0.29	0.317	0.37	0.04	original
836.5	20525	1RB_High	Rear	23.26	24	/	0.239	0.28	0.305	0.36	0.10	original
829	20450	1RB_High	Rear	23.22	24	/	0.217	0.26	0.280	0.34	0.13	original
844	20600	25RB_High	Rear	22.34	23	/	0.151	0.18	0.214	0.25	0.05	original
844	20600	1RB_High	Bottom	23.31	24	/	0.024	0.03	0.036	0.04	0.12	original
844	20600	25RB_High	Bottom	22.34	23	/	0.020	0.02	0.03	0.03	0.18	original
844	20600	1RB_High	Right	23.31	24	/	0.117	0.14	0.174	0.20	0.14	original
844	20600	25RB_High	Right	22.34	23	/	0.096	0.11	0.142	0.17	0.13	original
844	20600	1RB_High	Left	23.31	24	/	0.130	0.15	0.194	0.23	0.18	original
844	20600	25RB_High	Left	22.34	23	/	0.103	0.12	0.154	0.18	0.12	original
844	20600	1RB_High	Rear	23.40	24	/	0.199	0.23	0.263	0.30	0.08	new

Note: The distance between the EUT and the phantom bottom is 10mm.

Table 14.25: SAR Values (LTE Band 12-Head)

Frequency		Ambient Temperature: 23.3°C					Liquid Temperature: 22.8°C					Power Drift (dB)	note
MHz	Ch.	Configuration	Test Position	Conducted Power (dBm)	Max. tune-up Power (dBm)	Figure No.	Measured SAR(10g) (W/kg)	Reported SAR(10g) (W/kg)	Measured SAR(1g) (W/kg)	Reported SAR(1g) (W/kg)			
711	23130	1RB_High	Left Touch	22.01	23	Fig.18	0.034	0.04	0.044	0.06	-0.10	new	
707.5	23095	1RB_High	Left Touch	22.00	23	/	0.032	0.04	0.042	0.05	0.07	new	
704	23060	1RB_High	Left Touch	22.00	23	/	0.030	0.04	0.039	0.05	0.04	new	
711	23130	25RB_High	Left Touch	21.05	22	/	0.022	0.03	0.032	0.04	0.03	new	
711	23130	1RB_High	Left Tilt	22.01	23	/	0.018	0.02	0.025	0.03	0.06	new	
711	23130	25RB_High	Left Tilt	21.05	22	/	0.013	0.02	0.019	0.02	0.06	new	
711	23130	1RB_High	Right Touch	22.01	23	/	0.022	0.03	0.033	0.04	-0.18	new	
711	23130	25RB_High	Right Touch	21.05	22	/	0.019	0.02	0.025	0.03	0.08	new	
711	23130	1RB_High	Right Tilt	22.01	23	/	0.017	0.02	0.024	0.03	0.04	new	
711	23130	25RB_High	Right Tilt	21.05	22	/	0.013	0.02	0.024	0.03	-0.05	new	

Table 14.26: SAR Values (LTE Band 12-Body) – AP OFF

Frequency		Ambient Temperature: 23.4°C					Liquid Temperature: 22.9°C					Power Drift (dB)	note
MHz	Ch.	Configuration	Test Position	Conducted Power (dBm)	Max. tune-up Power (dBm)	Figure No.	Measured SAR(10g) (W/kg)	Reported SAR(10g) (W/kg)	Measured SAR(1g) (W/kg)	Reported SAR(1g) (W/kg)			
711	23130	1RB_High	Front	22.01	23	/	0.029	0.04	0.042	0.05	0.04	new	
711	23130	25RB_High	Front	21.05	22	/	0.023	0.03	0.033	0.04	-0.01	new	
711	23130	1RB_High	Rear	22.01	23	/	0.051	0.06	0.078	0.10	-0.00	new	
707.5	23095	1RB_High	Rear	22.00	23	/	0.042	0.05	0.064	0.08	0.06	new	

704	2306 0	1RB_ High	Rear	22.00	23	/	0.049	0.06	0.075	0.09	0.01	new
711	2313 0	25RB_ High	Rear	21.05	22	/	0.046	0.06	0.071	0.09	0.06	new

Note: The distance between the EUT and the phantom bottom is 10mm.

Table 14.27: SAR Values (LTE Band 12-Body) – AP ON

Frequency		Configurat ion	Test Position	Conduc ted Power (dBm)	Max. tune-u p Power (dBm)	Figur e No.	Ambient Temperature: 23.4 °C		Liquid Temperature: 22.9 °C		Power Drift (dB)	note
MHz	Ch.						Measur ed SAR(10 g) (W/kg)	Report ed SAR(1 0g) (W/kg)	Measure d SAR(1g) (W/kg)	Reported SAR(1g) (W/kg)		
711	2313 0	1RB_ High	Front	22.01	23	/	0.029	0.04	0.042	0.05	0.04	new
711	2313 0	25RB_ High	Front	21.05	22	/	0.023	0.03	0.033	0.04	-0.01	new
711	2313 0	1RB_ High	Rear	22.01	23	Fig.19	0.051	0.06	0.078	0.10	-0.00	new
707. 5	2309 5	1RB_ High	Rear	22.00	23	/	0.042	0.05	0.064	0.08	0.06	new
704	2306 0	1RB_ High	Rear	22.00	23	/	0.049	0.06	0.075	0.09	0.01	new
711	2313 0	25RB_ High	Rear	21.05	22	/	0.046	0.06	0.071	0.09	0.06	new
711	2313 0	1RB_ High	Bottom	22.01	23	/	0.005	0.01	0.008	0.01	0.02	new
711	2313 0	25RB_ High	Bottom	21.05	22	/	0.004	0.00	0.006	0.01	-0.04	new
711	2313 0	1RB_ High	Right	22.01	23	/	0.041	0.05	0.059	0.07	-0.16	new
711	2313 0	25RB_ High	Right	21.05	22	/	0.033	0.04	0.047	0.06	0.01	new
711	2313 0	1RB_ High	Left	22.01	23	/	0.045	0.06	0.065	0.08	-0.06	new
711	2313 0	25RB_ High	Left	21.05	22	/	0.036	0.04	0.052	0.06	0.05	new

Note: The distance between the EUT and the phantom bottom is 10mm.

Table 14.28: SAR Values (LTE Band 17-Head)

Frequency		Ambient Temperature: 23.3°C					Liquid Temperature: 22.8°C					note
MHz	Ch.	Configuration	Test Position	Conducted Power (dBm)	Max. tune-up Power (dBm)	Figure No.	Measured SAR(10g) (W/kg)	Reported SAR(10g) (W/kg)	Measured SAR(1g) (W/kg)	Reported SAR(1g) (W/kg)	Power Drift (dB)	
709	23780	1RB_High	Left Touch	23.52	24	Fig.20	0.045	0.05	0.06	0.07	0.04	original
709	23780	25RB_High	Left Touch	22.55	23	/	0.033	0.04	0.048	0.05	0.03	original
709	23780	1RB_High	Left Tilt	23.52	24	/	0.030	0.03	0.042	0.05	0.06	original
709	23780	25RB_High	Left Tilt	22.55	23	/	0.026	0.03	0.035	0.04	0.06	original
709	23780	1RB_High	Right Touch	23.52	24	/	0.038	0.04	0.055	0.06	-0.18	original
709	23780	25RB_High	Right Touch	22.55	23	/	0.033	0.04	0.046	0.05	0.08	original
709	23780	1RB_High	Right Tilt	23.52	24	/	0.024	0.03	0.033	0.04	0.04	original
709	23780	25RB_High	Right Tilt	22.55	23	/	0.020	0.02	0.028	0.03	-0.05	original
709	23780	1RB_High	Left Touch	23.52	24	/	0.035	0.04	0.047	0.05	-0.04	new

Table 14.29: SAR Values (LTE Band 17-Body) – AP OFF

Frequency		Ambient Temperature: 23.4°C					Liquid Temperature: 22.9°C					note
MHz	Ch.	Configuration	Test Position	Conducted Power (dBm)	Max. tune-up Power (dBm)	Figure No.	Measured SAR(10g) (W/kg)	Reported SAR(10g) (W/kg)	Measured SAR(1g) (W/kg)	Reported SAR(1g) (W/kg)	Power Drift (dB)	
709	23780	1RB_High	Front	23.52	24	/	0.054	0.06	0.076	0.08	0.04	original
709	23780	25RB_High	Front	22.55	23	/	0.037	0.04	0.056	0.06	-0.01	original
709	23780	1RB_High	Rear	23.52	24	/	0.080	0.09	0.12	0.13	0.01	original
709	23780	25RB_High	Rear	22.55	23	/	0.061	0.07	0.091	0.10	0.06	original
709	23780	1RB_High	Rear	23.52	24	/	0.077	0.09	0.100	0.11	0.11	new

Note: The distance between the EUT and the phantom bottom is 10mm.

Table 14.30: SAR Values (LTE Band 17-Body) – AP ON

Frequency		Ambient Temperature: 23.4 °C					Liquid Temperature: 22.9 °C					
MHz	Ch.	Config uration	Test Position	Conduc ted Power (dBm)	Max. tune-up Power (dBm)	Figur e No.	Measur ed SAR(10 g) (W/kg)	Report ed SAR(1 0g) (W/kg)	Measure d SAR(1g) (W/kg)	Reporte d SAR(1g) (W/kg)	Power Drift (dB)	note
709	23780	1RB_ High	Front	23.52	24	/	0.054	0.06	0.076	0.08	0.04	original
709	23780	25RB_ High	Front	22.55	23	/	0.037	0.04	0.056	0.06	-0.01	original
709	23780	1RB_ High	Rear	23.52	24	Fig.21	0.080	0.09	0.12	0.13	0.01	original
709	23780	1RB_ High	Rear	22.55	23	/	0.061	0.07	0.091	0.10	0.06	original
709	23780	1RB_ High	Rear	23.52	24	/	0.007	0.01	0.012	0.01	0.02	original
709	23780	25RB_ High	Rear	22.55	23	/	0.005	0.01	0.009	0.01	-0.04	original
709	23780	1RB_ High	Bottom	23.52	24	/	0.043	0.05	0.063	0.07	-0.16	original
709	23780	25RB_ High	Bottom	22.55	23	/	0.037	0.04	0.054	0.06	0.01	original
709	23780	1RB_ High	Right	23.52	24	/	0.041	0.05	0.061	0.07	-0.06	original
709	23780	25RB_ High	Right	22.55	23	/	0.038	0.04	0.055	0.06	0.05	original
709	23780	1RB_ High	Rear	23.52	24	/	0.077	0.09	0.100	0.11	0.11	new

Note: The distance between the EUT and the phantom bottom is 10mm.

14.2 SAR results for Standard procedure

There is zoom scan measurement to be added for the highest measured SAR in each exposure configuration/band.

Table 14.31: SAR Values (GSM 850 MHz Band - Head)

Ambient Temperature: 23.7 °C					Liquid Temperature: 23.2 °C						
Frequency		Side	Test Position	Figure No.	Conducted Power (dBm)	Max. tune-up Power (dBm)	Measured SAR(10g) (W/kg)	Reported SAR(10g) (W/kg)	Measured SAR(1g) (W/kg)	Reported SAR(1g) (W/kg)	Power Drift (dB)
MHz	Ch.										
836.6	190	Right	Touch	Fig.1	33.28	34	0.187	0.22	0.253	0.30	-0.09

Table 14.32: SAR Values (GSM 850 MHz Band - Body) – AP ON

Ambient Temperature: 23.0 °C					Liquid Temperature: 22.5 °C					
Frequency		Test Position	Figure No.	Conducted Power (dBm)	Max. tune-up Power (dBm)	Measured SAR(10g) (W/kg)	Reported SAR(10g) (W/kg)	Measured SAR(1g) (W/kg)	Reported SAR(1g) (W/kg)	Power Drift (dB)
MHz	Ch.									
848.8	251	Rear	Fig.2	29.72	30	0.578	0.62	0.780	0.83	0.13
836.6	190	Rear	Fig.21	29.64	30	0.470	0.51	0.609	0.66	-0.02
824.2	128	Rear	Fig.22	29.47	30	0.378	0.43	0.509	0.58	-0.08

Note1: The distance between the EUT and the phantom bottom is 10mm.

Table 14.33: SAR Values (GSM 1900 MHz Band - Head)

Ambient Temperature: 23.3 °C					Liquid Temperature: 22.8 °C						
Frequency		Side	Test Position	Figure No.	Conducted Power (dBm)	Max. tune-up Power (dBm)	Measured SAR(10g) (W/kg)	Reported SAR(10g) (W/kg)	Measured SAR(1g) (W/kg)	Reported SAR(1g) (W/kg)	Power Drift (dB)
MHz	Ch.										
1880	661	Right	Touch	Fig.3	30.72	31	0.080	0.09	0.131	0.14	-0.14

Table 14.34: SAR Values (GSM 1900 MHz Band - Body) – AP ON

Ambient Temperature: 22.5 °C					Liquid Temperature: 22.0 °C					
Frequency		Test Position	Figure No.	Conducted Power (dBm)	Max. tune-up Power (dBm)	Measured SAR(10g) (W/kg)	Reported SAR(10g) (W/kg)	Measured SAR(1g) (W/kg)	Reported SAR(1g) (W/kg)	Power Drift (dB)
MHz	Ch.									
1909.8	810	Rear	Fig.4	24.42	24.5	0.235	0.24	0.440	0.45	0.16

Note1: The distance between the EUT and the phantom bottom is 10mm.

Table 14.35: SAR Values (WCDMA 850 MHz Band - Head)

Ambient Temperature: 23.3 °C					Liquid Temperature: 22.8 °C							
Frequency		Side	Test Position	Figure No.	Conducted Power (dBm)	Max. tune-up Power (dBm)	Measured SAR(10g) (W/kg)	Reported SAR(10g) (W/kg)	Measured SAR(1g) (W/kg)	Reported SAR(1g) (W/kg)	Power Drift (dB)	Note
MHz	Ch.											
836.4	4182	Right	Touch	Fig.5	22.97	24	0.132	0.17	0.180	0.23	-0.07	original

Table 14.36: SAR Values (WCDMA 850 MHz Band - Body) – AP ON

Frequency		Test Position	Figure No.	Conducted Power (dBm)	Max. tune-up Power (dBm)	Measured SAR(10g) (W/kg)	Reported SAR(10g) (W/kg)	Measured SAR(1g) (W/kg)	Reported SAR(1g) (W/kg)	Power Drift (dB)	Note
MHz	Ch.										
		Ambient Temperature: 22.5 °C		Liquid Temperature: 22.0 °C							
846.6	4233	Rear	Fig.6	23.02	24	0.234	0.29	0.313	0.39	0.05	original

Note1: The distance between the EUT and the phantom bottom is 10mm

Table 14.37: SAR Values (WCDMA 1900 MHz Band - Head)

Frequency		Side	Test Position	Figure No.	Conducted Power (dBm)	Max. tune-up Power (dBm)	Measured SAR(10g) (W/kg)	Reported SAR(10g) (W/kg)	Measured SAR(1g) (W/kg)	Reported SAR(1g) (W/kg)	Power Drift (dB)	Note
MHz	Ch.											
		Ambient Temperature: 23.3 °C		Liquid Temperature: 22.8 °C								
1852.4	9262	Left	Touch	Fig.7	23.73	24	0.200	0.21	0.323	0.34	0.05	original

Table 14.38: SAR Values (WCDMA 1900 MHz Band - Body) – AP ON

Frequency		Test Position	Figure No.	Conducted Power (dBm)	Max. tune-up Power (dBm)	Measured SAR(10g) (W/kg)	Reported SAR(10g) (W/kg)	Measured SAR(1g) (W/kg)	Reported SAR(1g) (W/kg)	Power Drift (dB)	Note
MHz	Ch.										
		Ambient Temperature: 22.5 °C		Liquid Temperature: 22.0 °C							
1852.4	9262	Rear	Fig.8	23.73	24	0.267	0.28	0.428	0.46	0.09	original

Note1: The distance between the EUT and the phantom bottom is 10mm

Table 14.39: SAR Values (WCDMA 1700 MHz Band - Head)

Frequency		Side	Test Position	Figure No.	Conducted Power (dBm)	Max. tune-up Power (dBm)	Measured SAR(10g) (W/kg)	Reported SAR(10g) (W/kg)	Measured SAR(1g) (W/kg)	Reported SAR(1g) (W/kg)	Power Drift (dB)	Note
MHz	Ch.											
		Ambient Temperature: 23.3 °C		Liquid Temperature: 22.8 °C								
1732.6	1413	Right	Touch	Fig.9	23.70	24	0.174	0.19	0.266	0.29	-0.03	original

Table 14.40: SAR Values (WCDMA 1700 MHz Band - Body)– AP ON

Frequency		Test Position	Figure No.	Conducted Power (dBm)	Max. tune-up Power (dBm)	Measured SAR(10g) (W/kg)	Reported SAR(10g) (W/kg)	Measured SAR(1g) (W/kg)	Reported SAR(1g) (W/kg)	Power Drift (dB)	Note
MHz	Ch.										
		Ambient Temperature: 22.5 °C		Liquid Temperature: 22.0 °C							
1732.6	1413	Rear	Fig.10	23.70	24	0.408	0.44	0.635	0.68	-0.01	original

Note1: The distance between the EUT and the phantom bottom is 10mm.

Table 14.41: SAR Values (LTE Band 2-Head)

Ambient Temperature: 23.3°C						Liquid Temperature: 22.8°C						
Frequency		Configuration	Test Position	Conducted Power (dBm)	Max. tune-up Power (dBm)	Figure No.	Measured SAR(10g) (W/kg)	Reported SAR(10g) (W/kg)	Measured SAR(1g) (W/kg)	Reported SAR(1g) (W/kg)	Power Drift (dB)	note
MHz	Ch.											
1860	18700	1RB_Low	Left Touch	23.56	24	Fig.11	0.226	0.25	0.373	0.41	0.07	original

Table 14.42: SAR Values (LTE Band 2-Body) – AP ON

Ambient Temperature: 23.4°C						Liquid Temperature: 22.9°C						
Frequency		Configuration	Test Position	Conducted Power (dBm)	Max. tune-up Power (dBm)	Figure No.	Measured SAR(10g) (W/kg)	Reported SAR(10g) (W/kg)	Measured SAR(1g) (W/kg)	Reported SAR(1g) (W/kg)	Power Drift (dB)	note
MHz	Ch.											
1860	18700	1RB_Low	Rear	23.56	24	Fig.12	0.254	0.28	0.411	0.45	0.11	original

Note: The distance between the EUT and the phantom bottom is 10mm.

Table 14.43: SAR Values (LTE Band 4-Head)

Ambient Temperature: 23.3°C						Liquid Temperature: 22.8°C						
Frequency		Configuration	Test Position	Conducted Power (dBm)	Max. tune-up Power (dBm)	Figure No.	Measured SAR(10g) (W/kg)	Reported SAR(10g) (W/kg)	Measured SAR(1g) (W/kg)	Reported SAR(1g) (W/kg)	Power Drift (dB)	note
MHz	Ch.											
1745	20300	1RB_Low	Left Touch	23.54	24	Fig.13	0.213	0.24	0.334	0.37	0.13	original

Table 14.44: SAR Values (LTE Band 4-Body)– AP ON

Ambient Temperature: 23.4°C						Liquid Temperature: 22.9°C						
Frequency		Configuration	Test Position	Conducted Power (dBm)	Max. tune-up Power (dBm)	Figure No.	Measured SAR(10g) (W/kg)	Reported SAR(10g) (W/kg)	Measured SAR(1g) (W/kg)	Reported SAR(1g) (W/kg)	Power Drift (dB)	note
MHz	Ch.											
1745	20300	1RB_Low	Rear	23.54	24	Fig.14	0.434	0.48	0.686	0.76	0.01	original

Note: The distance between the EUT and the phantom bottom is 10mm.

Table 14.45: SAR Values (LTE Band 5-Head)

Frequency		Ambient Temperature: 23.3°C					Liquid Temperature: 22.8°C					
MHz	Ch.	Configuration	Test Position	Conducted Power (dBm)	Max. tune-up Power (dBm)	Figure No.	Measured SAR(10g) (W/kg)	Reported SAR(10g) (W/kg)	Measured SAR(1g) (W/kg)	Reported SAR(1g) (W/kg)	Power Drift (dB)	note
844	20600	1RB_High	Left Touch	23.40	24	Fig.15	0.116	0.13	0.161	0.18	0.07	new

Table 14.46: SAR Values (LTE Band 5-Body) – AP ON

Frequency		Ambient Temperature: 23.4°C					Liquid Temperature: 22.9°C					
MHz	Ch.	Configuration	Test Position	Conducted Power (dBm)	Max. tune-up Power (dBm)	Figure No.	Measured SAR(10g) (W/kg)	Reported SAR(10g) (W/kg)	Measured SAR(1g) (W/kg)	Reported SAR(1g) (W/kg)	Power Drift (dB)	note
844	20600	1RB_High	Rear	23.31	24	Fig.16	0.247	0.29	0.317	0.37	0.04	original

Note: The distance between the EUT and the phantom bottom is 10mm

Table 14.47: SAR Values (LTE Band 12-Head)

Frequency		Ambient Temperature: 23.3°C					Liquid Temperature: 22.8°C					
MHz	Ch.	Configuration	Test Position	Conducted Power (dBm)	Max. tune-up Power (dBm)	Figure No.	Measured SAR(10g) (W/kg)	Reported SAR(10g) (W/kg)	Measured SAR(1g) (W/kg)	Reported SAR(1g) (W/kg)	Power Drift (dB)	note
711	23130	1RB_High	Left Touch	22.01	23	Fig.17	0.034	0.04	0.044	0.06	-0.10	new

Table 14.48: SAR Values (LTE Band 12-Body) - AP ON

Frequency		Ambient Temperature: 23.4°C					Liquid Temperature: 22.9°C					
MHz	Ch.	Configuration	Test Position	Conducted Power (dBm)	Max. tune-up Power (dBm)	Figure No.	Measured SAR(10g) (W/kg)	Reported SAR(10g) (W/kg)	Measured SAR(1g) (W/kg)	Reported SAR(1g) (W/kg)	Power Drift (dB)	note
711	23130	1RB_High	Rear	22.01	23	Fig.18	0.051	0.06	0.078	0.10	-0.00	new

Note: The distance between the EUT and the phantom bottom is 10mm

Table 14.49: SAR Values (LTE Band 17-Head)

Frequency		Ambient Temperature: 23.3°C					Liquid Temperature: 22.8°C					
MHz	Ch.	Configuration	Test Position	Conducted Power (dBm)	Max. tune-up Power (dBm)	Figure No.	Measured SAR(10g) (W/kg)	Reported SAR(10g) (W/kg)	Measured SAR(1g) (W/kg)	Reported SAR(1g) (W/kg)	Power Drift (dB)	note
709	23780	1RB_High	Left Touch	23.52	24	Fig.19	0.045	0.05	0.06	0.07	0.04	original

Table 14.50: SAR Values (LTE Band 17-Body) - AP ON

Frequency		Ambient Temperature: 23.4°C					Liquid Temperature: 22.9°C					
MHz	Ch.	Configuration	Test Position	Conducted Power (dBm)	Max. tune-up Power (dBm)	Figure No.	Measured SAR(10g) (W/kg)	Reported SAR(10g) (W/kg)	Measured SAR(1g) (W/kg)	Reported SAR(1g) (W/kg)	Power Drift (dB)	note
709	23780	1RB_High	Rear	23.52	24	Fig.20	0.080	0.09	0.12	0.13	0.01	original

Note: The distance between the EUT and the phantom bottom is 10mm

14.3 WLAN Evaluation

According to the KDB248227 D01, SAR is measured for 2.4GHz 802.11b DSSS using the initial test position procedure.

Head Evaluation

Table 14.51: SAR Values (Wi-Fi 802.11b - Head)

Frequency		Side	Test Position	Figure No.	Conducted Power (dBm)	Max. tune-up Power (dBm)	Ambient Temperature: 23.0 °C		Liquid Temperature: 22.5 °C		Power Drift (dB)
MHz	Ch.						Measured SAR(10g) (W/kg)	Reported SAR(10g) (W/kg)	Measured SAR(1g) (W/kg)	Reported SAR(1g) (W/kg)	
2437	6	Left	Touch	/	13.50	14	0.026	0.03	0.054	0.06	0.17
2437	6	Left	Tilt	/	13.50	14	0.016	0.02	0.033	0.04	0.12
2437	6	Right	Touch	/	13.50	14	0.072	0.08	0.168	0.19	0.13
2437	6	Right	Tilt	/	13.50	14	0.049	0.05	0.100	0.11	0.18

As shown above table, the initial test position for head is "Right Touch". So the head SAR of WLAN is presented as below:

Table 14.52: SAR Values (WLAN - Head) – 802.11b 1Mbps (Full SAR)

Frequency		Side	Test Position	Figure No.	Conducted Power (dBm)	Max. tune-up Power (dBm)	Ambient Temperature: 22.5 °C		Liquid Temperature: 22.0 °C		Power Drift (dB)
MHz	Ch.						Measured SAR(10g) (W/kg)	Reported SAR(10g) (W/kg)	Measured SAR(1g) (W/kg)	Reported SAR(1g) (W/kg)	
2437	6	Right	Touch	Fig.21	13.50	14	0.075	0.08	0.173	0.19	0.13
2437	6	Left	Touch	/	13.50	14	0.028	0.03	0.057	0.06	0.17

According to the KDB248227 D01, The reported SAR must be scaled to 100% transmission duty factor to determine compliance at the maximum tune-up tolerance limit. A maximum transmission duty factor of 98.0% is achievable for WLAN in this project and the scaled reported SAR is presented as below.

Table 14.53: SAR Values (WLAN - Head) – 802.11b 1Mbps (Scaled Reported SAR)

Frequency		Side	Test Position	Actual duty factor	maximum duty factor	Ambient Temperature: 22.5 °C		Liquid Temperature: 22.0 °C	
MHz	Ch.					Reported SAR (1g) (W/kg)	Scaled reported SAR (1g) (W/kg)		
2437	6	Left	Touch	98.0%	100%	0.06	0.06		
2437	6	Right	Touch	98.0%	100%	0.19	0.19		

SAR is not required for OFDM because the 802.11b adjusted SAR \leq 1.2 W/kg.

Body Evaluation

Table 14.54: SAR Values (WLAN - Body) – 802.11b 1Mbps (Fast SAR)

Frequency		Test Position	Figure No.	Conducted Power (dBm)	Max. tune-up Power (dBm)	Ambient Temperature: 23.0 °C		Liquid Temperature: 22.5 °C		Power Drift (dB)
MHz	Ch.					Measured SAR(10g) (W/kg)	Reported SAR(10g) (W/kg)	Measured SAR(1g) (W/kg)	Reported SAR(1g) (W/kg)	
2437	6	Front	/	13.50	14	0.015	0.02	0.031	0.03	0.07
2437	6	Rear	/	13.50	14	0.041	0.05	0.088	0.10	0.13
2437	6	Left	/	13.50	14	0.009	0.01	0.017	0.02	0.12
2437	6	Top	/	13.50	14	0.003	0.00	0.008	0.01	0.15

Note1: The distance between the EUT and the phantom bottom is 10mm.

As shown above table, the initial test position for body is “Rear”. So the body SAR of WLAN is presented as below:

Table 14.55: SAR Values (WLAN - Body) – 802.11b 1Mbps (Full SAR)

Frequency		Test Position	Figure No.	Conducted Power (dBm)	Max. tune-up Power (dBm)	Ambient Temperature: 23.0 °C		Liquid Temperature: 22.5 °C		Power Drift (dB)
MHz	Ch.					Measured SAR(10g) (W/kg)	Reported SAR(10g) (W/kg)	Measured SAR(1g) (W/kg)	Reported SAR(1g) (W/kg)	
2437	6	Rear	Fig.22	13.50	14	0.043	0.05	0.09	0.10	0.13

According to the KDB248227 D01, The reported SAR must be scaled to 100% transmission duty factor to determine compliance at the maximum tune-up tolerance limit. A maximum transmission duty factor of 98.0% is achievable for WLAN in this project and the scaled reported SAR is presented as below.

Table 14.56: SAR Values (WLAN - Body) – 802.11b 1Mbps (Scaled Reported SAR)

Frequency		Test Position	Ambient Temperature: 22.5 °C		Liquid Temperature: 22.0 °C	
MHz	Ch.		Actual duty factor	maximum duty factor	Reported SAR (1g) (W/kg)	Scaled reported SAR (1g) (W/kg)
2437	6	Rear	98.0%	100%	0.10	0.10

SAR is not required for OFDM because the 802.11b adjusted SAR \leq 1.2 W/kg.

15 Measurement Uncertainty

15.1 Measurement Uncertainty for Normal SAR Tests (300MHz~3GHz)

No.	Error Description	Type	Uncertainty value	Probably Distribution	Div.	(Ci) 1g	(Ci) 10g	Std. Unc. (1g)	Std. Unc. (10g)	Degree of freedom
Measurement system										
1	Probe calibration	B	5.5	N	1	1	1	5.4	5.4	∞
2	Isotropy	B	4.7	R	$\sqrt{3}$	1	1	1.6	1.6	∞
3	Boundary effect	B	1.0	R	$\sqrt{3}$	1	1	6.4	6.4	∞
4	Linearity	B	4.7	R	$\sqrt{3}$	1	1	0.5	0.5	∞
5	Detection limit	B	1.0	N	1	1	1	1	1	∞
6	Readout electronics	B	0.3	R	$\sqrt{3}$	1	1	0.6	0.6	∞
7	Response time	B	0.8	R	$\sqrt{3}$	1	1	0.0	0.0	∞
8	Integration time	B	2.6	R	$\sqrt{3}$	1	1	1.0	1.0	∞
9	RF ambient conditions-noise	B	0	R	$\sqrt{3}$	1	1	1.7	1.7	∞
10	RF ambient conditions-reflection	B	0	R	$\sqrt{3}$	1	1	1.7	1.7	∞
11	Probe positioned mech. restrictions	B	0.4	R	$\sqrt{3}$	1	1	0.2	0.2	∞
12	Probe positioning with respect to phantom shell	B	2.9	R	$\sqrt{3}$	1	1	1.7	1.7	∞
13	Post-processing	B	1.0	R	$\sqrt{3}$	1	1	1.2	1.2	∞
Test sample related										
14	Test sample positioning	A	3.3	N	1	1	1	3.3	3.3	5
15	Device holder uncertainty	A	3.4	N	1	1	1	3.4	3.4	5
16	Drift of output power	B	5.0	R	$\sqrt{3}$	1	1	2.9	2.9	∞
Phantom and set-up										
17	Phantom uncertainty	B	4.0	R	$\sqrt{3}$	1	1	2.3	2.3	∞
18	Liquid conductivity (target)	B	5.0	R	$\sqrt{3}$	0.64	0.43	1.8	1.2	∞
19	Liquid conductivity (meas.)	A	2.06	N	1	0.64	0.43	1	0.28	9
20	Liquid permittivity (target)	B	5.0	R	$\sqrt{3}$	0.6	0.49	1.7	1.4	∞
21	Liquid permittivity (meas.)	A	1.6	N	1	0.6	0.49	0.31	0.25	9
Combined standard uncertainty		$u_c = \sqrt{\sum_{i=1}^{21} c_i^2 u_i^2}$						11.1	11.0	95.5
Expanded uncertainty (confidence interval of 95 %)		$u_e = 2u_c$						22.3	22.1	

15.2 Measurement Uncertainty for Fast SAR Tests (300MHz~3GHz)

No.	Error Description	Type	Uncertainty value	Probably Distribution	Div.	(Ci) 1g	(Ci) 10g	Std. Unc. (1g)	Std. Unc. (10g)	Degree of freedom
Measurement system										
1	Probe calibration	B	10.8	N	1	1	5.4	5.4	1	∞
2	Isotropy	B	2.8	R	1	1	1.6	1.6	1	∞
3	Boundary effect	B	1.0	R	1	1	0.6	0.6	1	∞
4	Linearity	B	4.7	R	1	1	2.7	2.7	1	∞
5	Detection limit	B	1.0	R	1	1	0.6	0.6	1	∞
6	Readout electronics	B	0.3	R	1	1	0.3	0.3	1	∞
7	Response time	B	0.8	R	1	1	0.5	0.5	1	∞
8	Integration time	B	2.6	R	1	1	1.5	1.5	1	∞
9	RF ambient conditions-noise	B	0	R	1	1	0	0	1	∞
10	RF ambient conditions-reflection	B	0	R	1	1	0	0	1	∞
11	Probe positioned mech. Restrictions	B	0.4	R	1	1	0.2	0.2	1	∞
12	Probe positioning with respect to phantom shell	B	2.9	R	1	1	1.7	1.7	1	∞
13	Post-processing	B	1.0	R	1	1	0.6	0.6	1	∞
14	Fast SAR z-Approximation	B	7.0	R	1	1	4.0	4.0	1	∞
Test sample related										
15	Test sample positioning	A	3.3	N	1	1	1	3.3	3.3	71
16	Device holder uncertainty	A	3.4	N	1	1	1	3.4	3.4	5
17	Drift of output power	B	5.0	R	$\sqrt{3}$	1	1	2.9	2.9	∞
Phantom and set-up										
18	Phantom uncertainty	B	4.0	R	$\sqrt{3}$	1	1	2.3	2.3	∞
19	Liquid conductivity (target)	B	5.0	R	$\sqrt{3}$	0.64	0.43	1.8	1.2	∞
20	Liquid conductivity (meas.)	A	2.06	N	1	0.64	0.43	1.32	0.89	43
21	Liquid permittivity (target)	B	5.0	R	$\sqrt{3}$	0.6	0.49	1.7	1.4	∞
22	Liquid permittivity (meas.)	A	1.6	N	1	0.6	0.49	1.0	0.8	521
Combined standard uncertainty		$u_c = \sqrt{\sum_{i=1}^{22} c_i^2 u_i^2}$						13.1	12.4	257
Expanded uncertainty (confidence interval of 95 %)		$u_e = 2u_c$						26.2	25.9	

16 MAIN TEST INSTRUMENTS

Table 16.1: List of Main Instruments

No.	Name	Type	Serial Number	Calibration Date	Valid Period
01	Network analyzer	Agilent E5071C	MY46103759	December 16,2015	One year
02	Dielectric probe	85070E	MY44300317	No Calibration Requested	
03	Power meter	NRVD	101253	March 5,2015	One year
04	Power sensor	NRV-Z5	100333		
05	Signal Generator	E4438C	MY45095825	January 12, 2016	One year
06	Amplifier	VTL5400	0404	No Calibration Requested	
07	BTS	E5515C	GB46110723	May 20, 2015	One year
08	E-field Probe	SPEAG ES3DV3	3151	October 30, 2015	One year
10	DAE	SPEAG DAE4	786	November 16, 2015	One year
11	Dipole Validation Kit	SPEAG D750V3	1017	August 28, 2014	Two year
12	Dipole Validation Kit	SPEAG D835V2	4d057	October 22, 2015	One year
13	Dipole Validation Kit	SPEAG D1800V2	2d147	November 3, 2015	One year
14	Dipole Validation Kit	SPEAG D1900V2	5d088	November 4, 2015	One year
15	Dipole Validation Kit	SPEAG D2450V2	873	October 30, 2015	One year
17	Radio Communication Analyzer	Anristu MT8820C	6201341853	March 27, 2015	One year

END OF REPORT BODY

ANNEX A Graph Results

GSM 850 Right Cheek Middle

Date/Time: 2015-12-16

Electronics: DAE4 Sn786

Medium: Head 900 MHz

Medium parameters used (interpolated): $f = 836.6$ MHz; $\sigma = 0.928$ S/m; $\epsilon_r = 40.159$; $\rho = 1000$ kg/m³

Ambient Temperature: 22.0°C Liquid Temperature: 21.5°C

Communication System: GSM Frequency: 836.6 MHz Duty Cycle: 1:8.3

Probe: ES3DV3 - SN3151 ConvF(6, 6, 6);

Right Cheek Middle/Area Scan (61x111x1): Interpolated grid: dx=1.500 mm, dy=1.500 mm
Maximum value of SAR (interpolated) = 0.272 W/kg

Right Cheek Middle/Zoom Scan (5x5x7)/Cube 0: Measurement grid: dx=8mm, dy=8mm, dz=5mm

Reference Value = 8.274 V/m; Power Drift = -0.09 dB

Peak SAR (extrapolated) = 0.331 W/kg

SAR(1 g) = 0.253 W/kg; SAR(10 g) = 0.187 W/kg

Maximum value of SAR (measured) = 0.269 W/kg

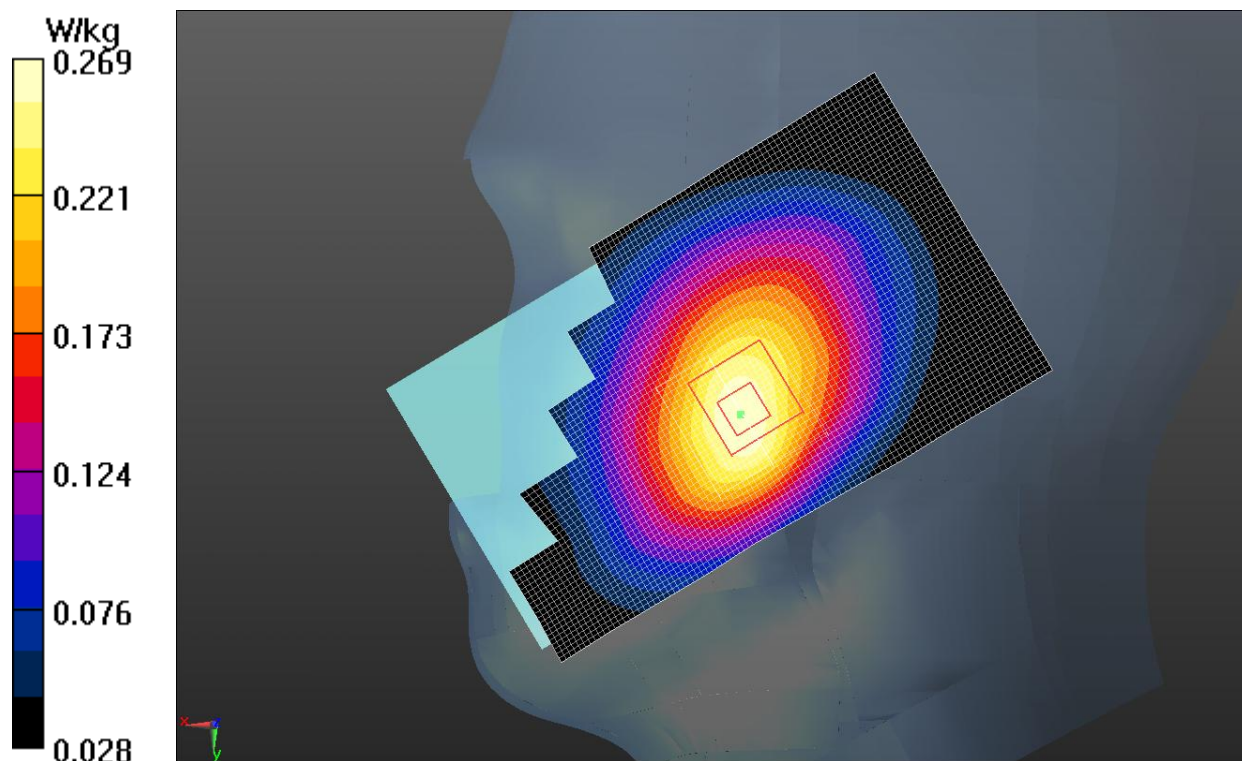

Fig.1 GSM 850MHz CH190

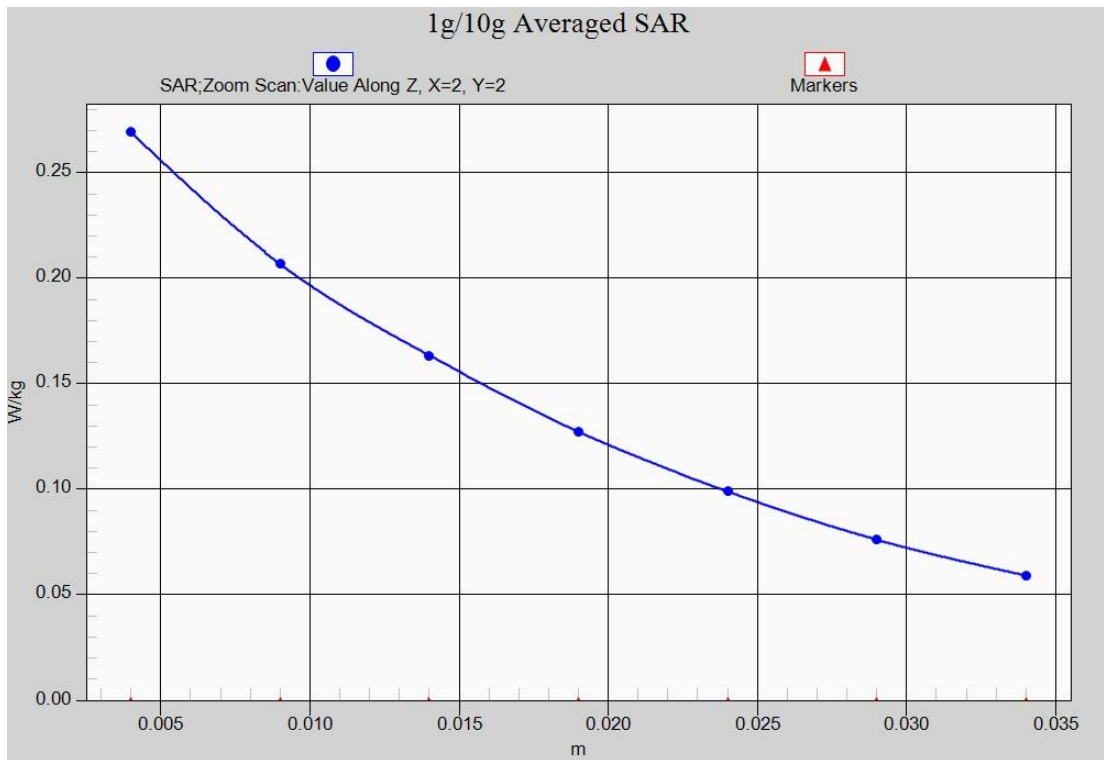

Fig.1-1 Z-Scan at power reference point (GSM 850 MHz CH190)

850 Body Rear High

Date/Time: 2015-12-25

Electronics: DAE4 Sn786

Medium: Body850 MHz

Medium parameters used (interpolated): $f = 848.8$ MHz; $\sigma = 0.984$ S/m; $\epsilon_r = 53.419$; $\rho = 1000$ kg/m³

Ambient Temperature: 22.0°C Liquid Temperature: 21.5°C

Communication System: 4 slot GPRS Frequency: 848.8 MHz Duty Cycle: 1:2

Probe: ES3DV3 - SN3151 ConvF(6.13, 6.13, 6.13);

Rear side High/Area Scan (61x101x1): Interpolated grid: dx=1.500 mm, dy=1.500 mm

Maximum value of SAR (interpolated) = 0.833 W/kg

Rear side High/Zoom Scan (5x5x7)/Cube 0: Measurement grid: dx=8mm, dy=8mm, dz=5mm

Reference Value = 25.756 V/m; Power Drift = 0.13 dB

Peak SAR (extrapolated) = 1.07 W/kg

SAR(1 g) = 0.780 W/kg; SAR(10 g) = 0.578 W/kg

Maximum value of SAR (measured) = 0.824 W/kg

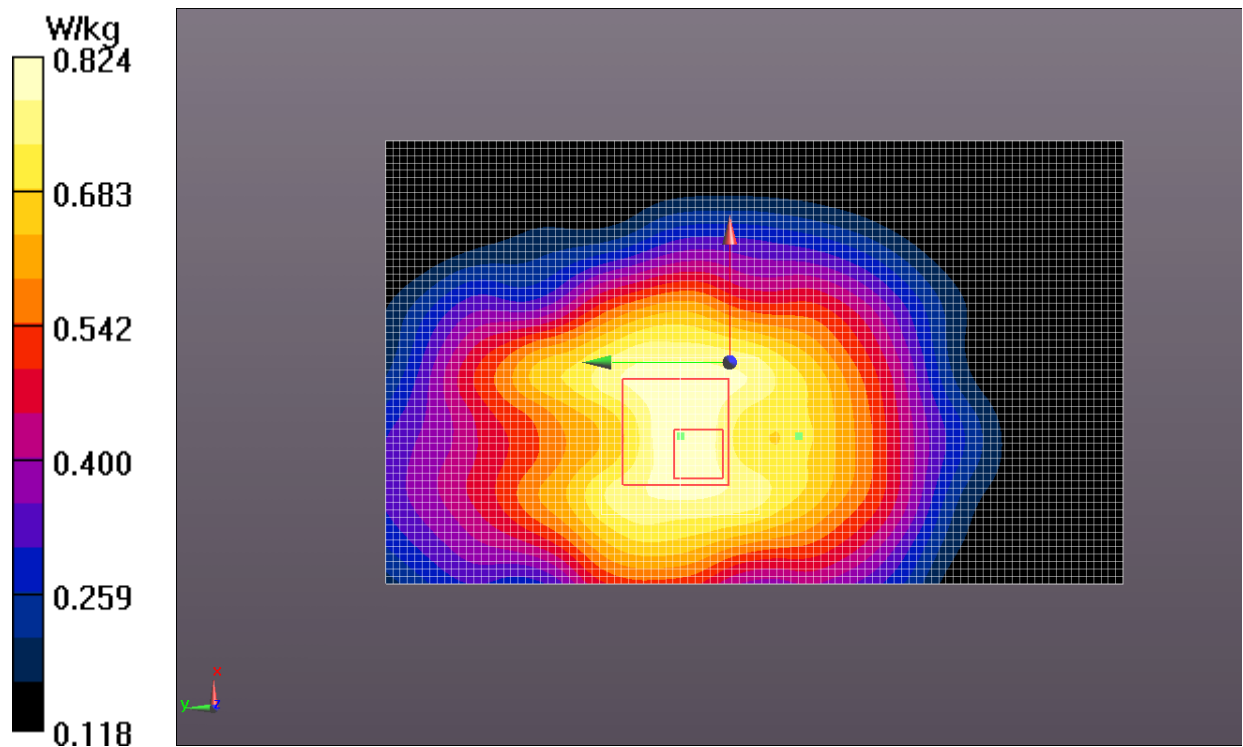

Fig.2 GSM 850 MHz CH251

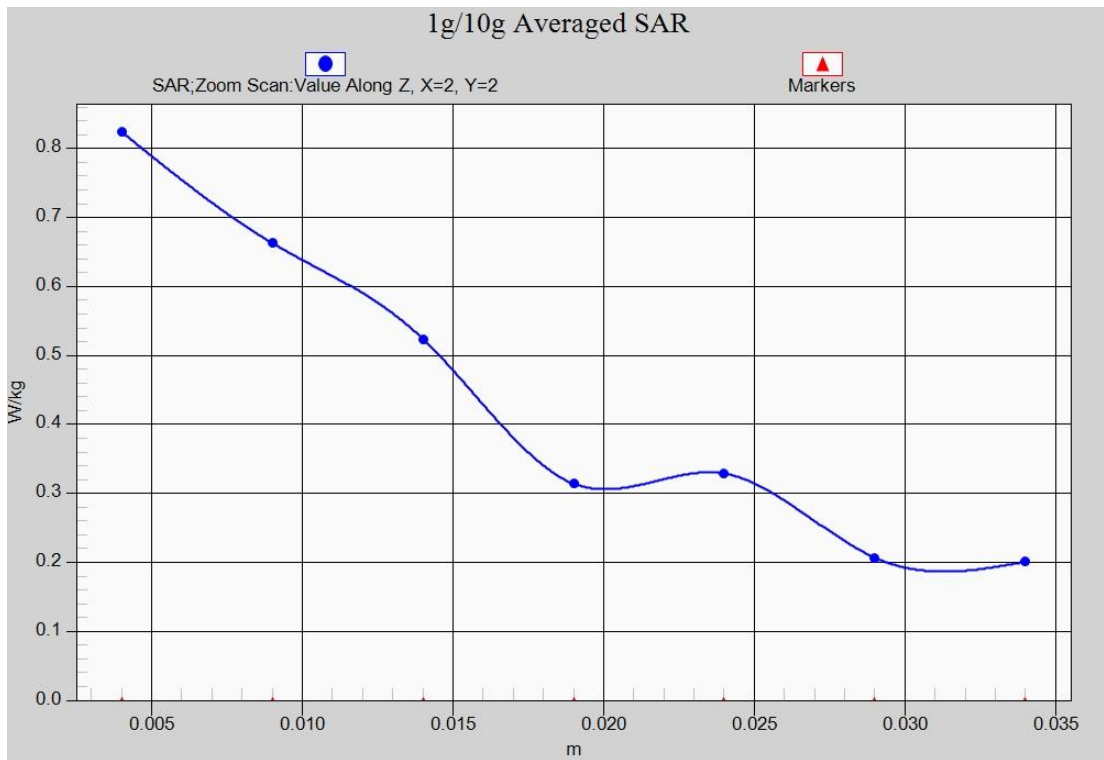

Fig.2-1 Z-Scan at power reference point (GSM 850 MHz CH251)

GSM1900 Right Cheek Middle

Date/Time: 2015-12-17

Electronics: DAE4 Sn786

Medium: 1900 Head

Medium parameters used: $f = 1880$ MHz; $\sigma = 1.394$ S/m; $\epsilon_r = 38.388$; $\rho = 1000$ kg/m³

Ambient Temperature: 22.0°C Liquid Temperature: 21.5°C

Communication System: GSM Frequency: 1880 MHz Duty Cycle: 1:8.3

Probe: ES3DV3 - SN3151 ConvF(4.96, 4.96, 4.96);

Right Cheek Middle/Area Scan (61x111x1): Interpolated grid: dx=1.500 mm, dy=1.500 mm

Maximum value of SAR (interpolated) = 0.140 W/kg

Right Cheek Middle/Zoom Scan (4x4x7)/Cube 0: Measurement grid: dx=10mm, dy=10mm, dz=5mm

Reference Value = 8.756 V/m; Power Drift = -0.14 dB

Peak SAR (extrapolated) = 0.211 W/kg

SAR(1 g) = 0.131 W/kg; SAR(10 g) = 0.080 W/kg

Maximum value of SAR (measured) = 0.133 W/kg

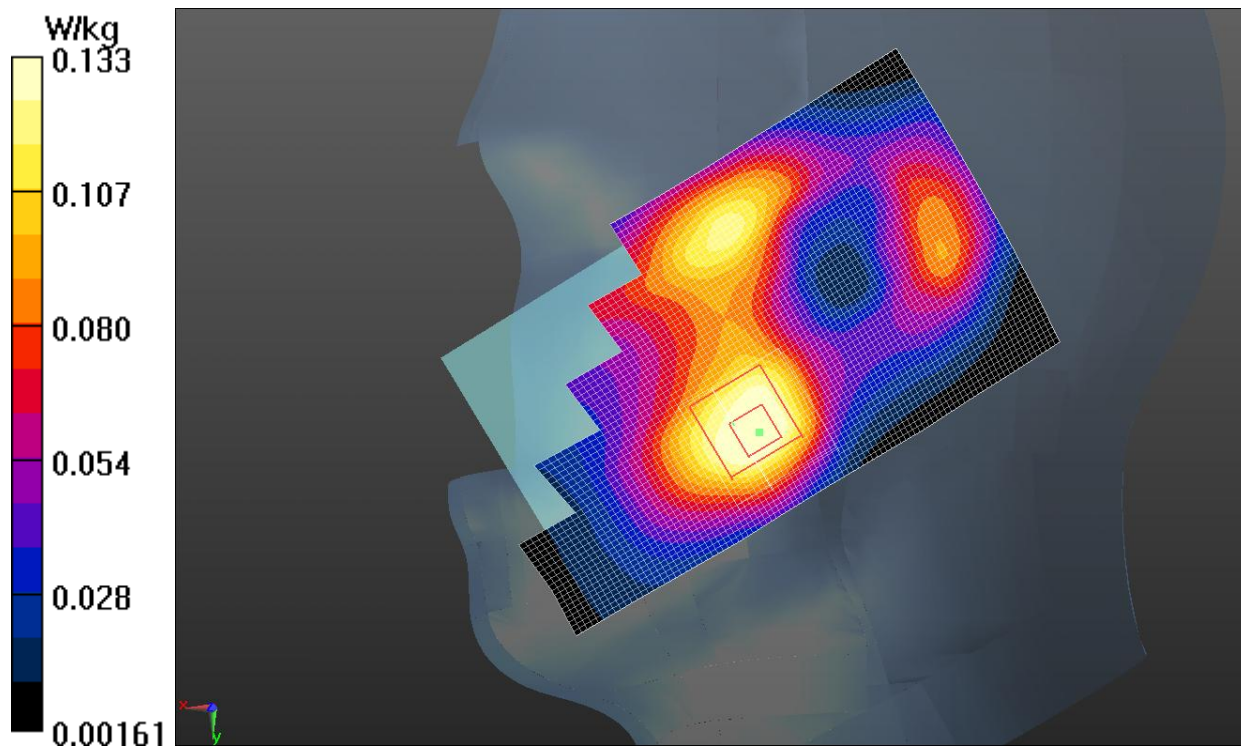

Fig.3 GSM 1900 MHz CH810

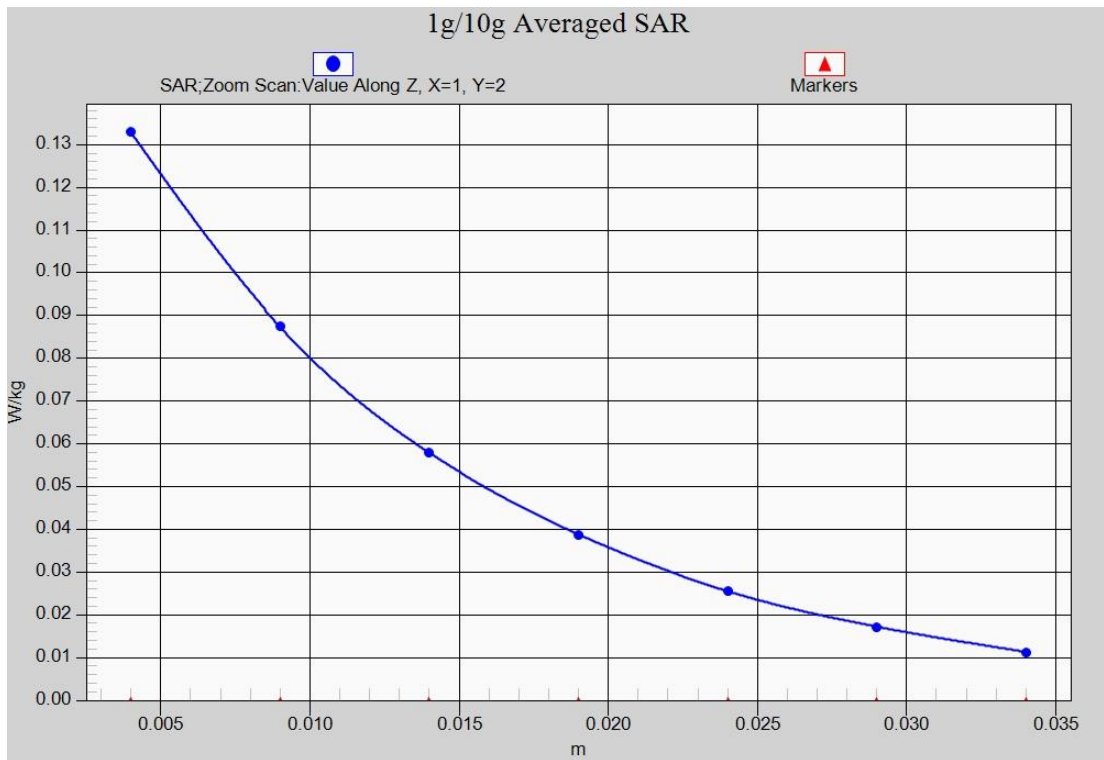

Fig.3-1 Z-Scan at power reference point (GSM 1900 MHz CH661)

GSM1900 Body Rear Middle

Date/Time: 2015-12-26

Electronics: DAE4 Sn786

Medium: Body1900 MHz

Medium parameters used: $f = 1880$ MHz; $\sigma = 1.555$ S/m; $\epsilon_r = 53.496$; $\rho = 1000$ kg/m³

Ambient Temperature: 22.0°C Liquid Temperature: 21.5°C

Communication System: 2 slot GPRS (0) Frequency: 1880 MHz Duty Cycle: 1:4

Probe: ES3DV3 - SN3151 ConvF(4.5, 4.5, 4.5);

Rear side Mid/Area Scan (61x101x1): Interpolated grid: dx=1.500 mm, dy=1.500 mm

Maximum value of SAR (interpolated) = 0.751 W/kg

Rear side Mid/Zoom Scan (5x5x7)/Cube 0: Measurement grid: dx=8mm, dy=8mm, dz=5mm

Reference Value = 8.802 V/m; Power Drift = 0.14 dB

Peak SAR (extrapolated) = 0.763 W/kg

SAR(1 g) = 0.478 W/kg; SAR(10 g) = 0.290 W/kg

Maximum value of SAR (measured) = 0.507 W/kg

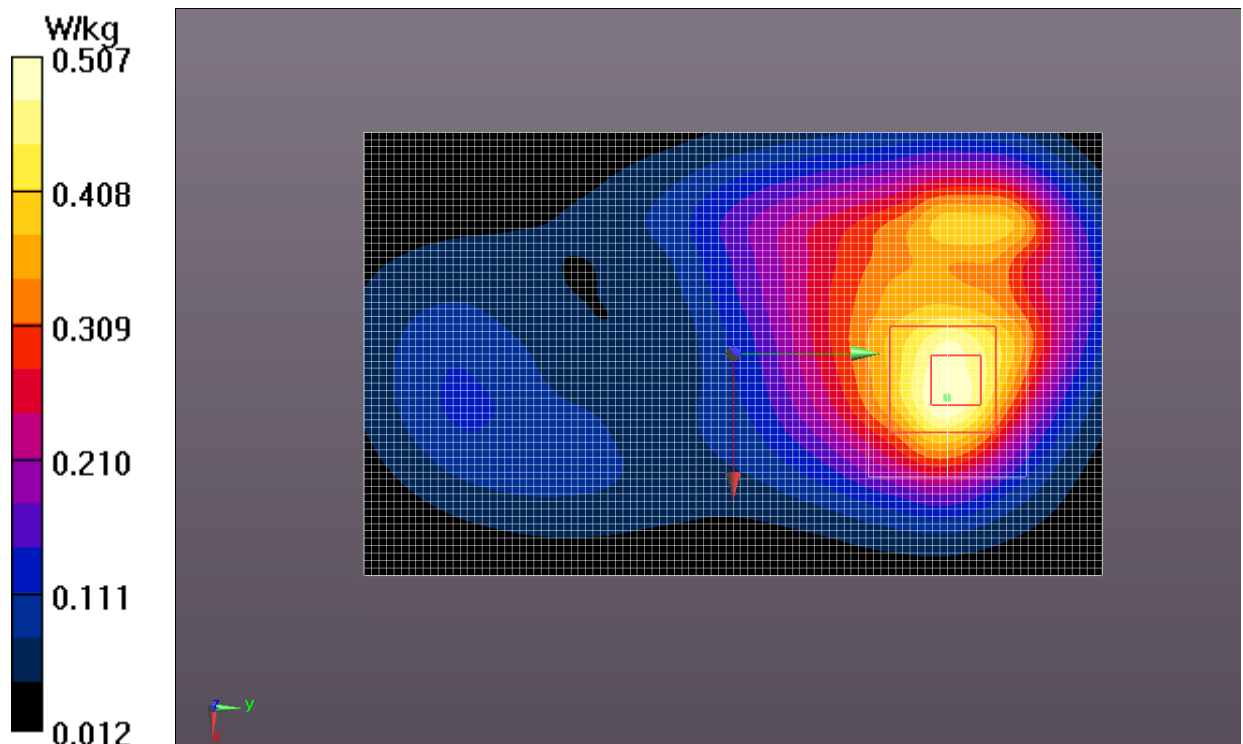

Fig.4 GSM 1900 MHz CH661

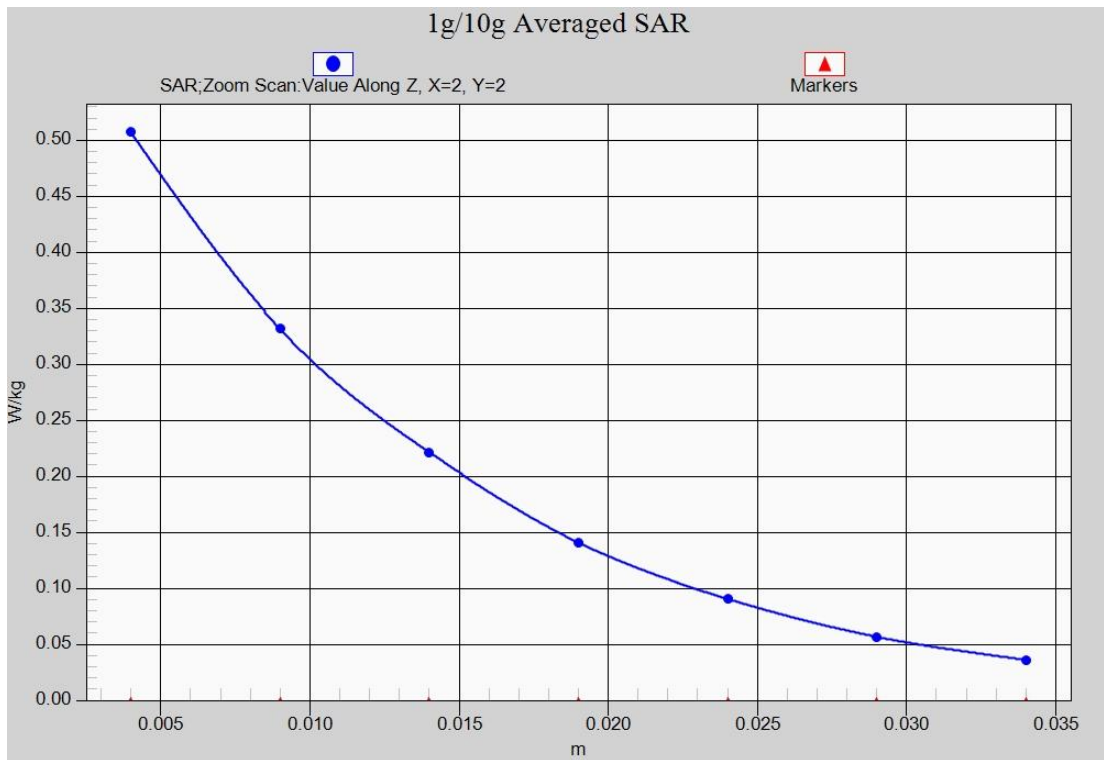

Fig.4-1 Z-Scan at power reference point (GSM 1900 MHz CH661)

WCDMA 850 Right Cheek Middle

Date/Time: 2015-12-16

Electronics: DAE4 Sn786

Medium: Head 900 MHz

Medium parameters used (interpolated): $f = 836.6$ MHz; $\sigma = 0.928$ S/m; $\epsilon_r = 40.159$; $\rho = 1000$ kg/m³

Ambient Temperature: 22.0°C Liquid Temperature: 21.5°C

Communication System: WCDMA Frequency: 836.6 MHz Duty Cycle: 1:1

Probe: ES3DV3 - SN3151 ConvF(6.00, 6.00, 6.00);

Right Cheek Middle/Area Scan (61x111x1): Interpolated grid: dx=1.500 mm, dy=1.500 mm

Maximum value of SAR (interpolated) = 0.195 W/kg

Right Cheek Middle/Zoom Scan (5x5x7)/Cube 0: Measurement grid: dx=8mm, dy=8mm, dz=5mm

Reference Value = 7.031 V/m; Power Drift = -0.07 dB

Peak SAR (extrapolated) = 0.240 W/kg

SAR(1 g) = 0.180 W/kg; SAR(10 g) = 0.132 W/kg

Maximum value of SAR (measured) = 0.188 W/kg

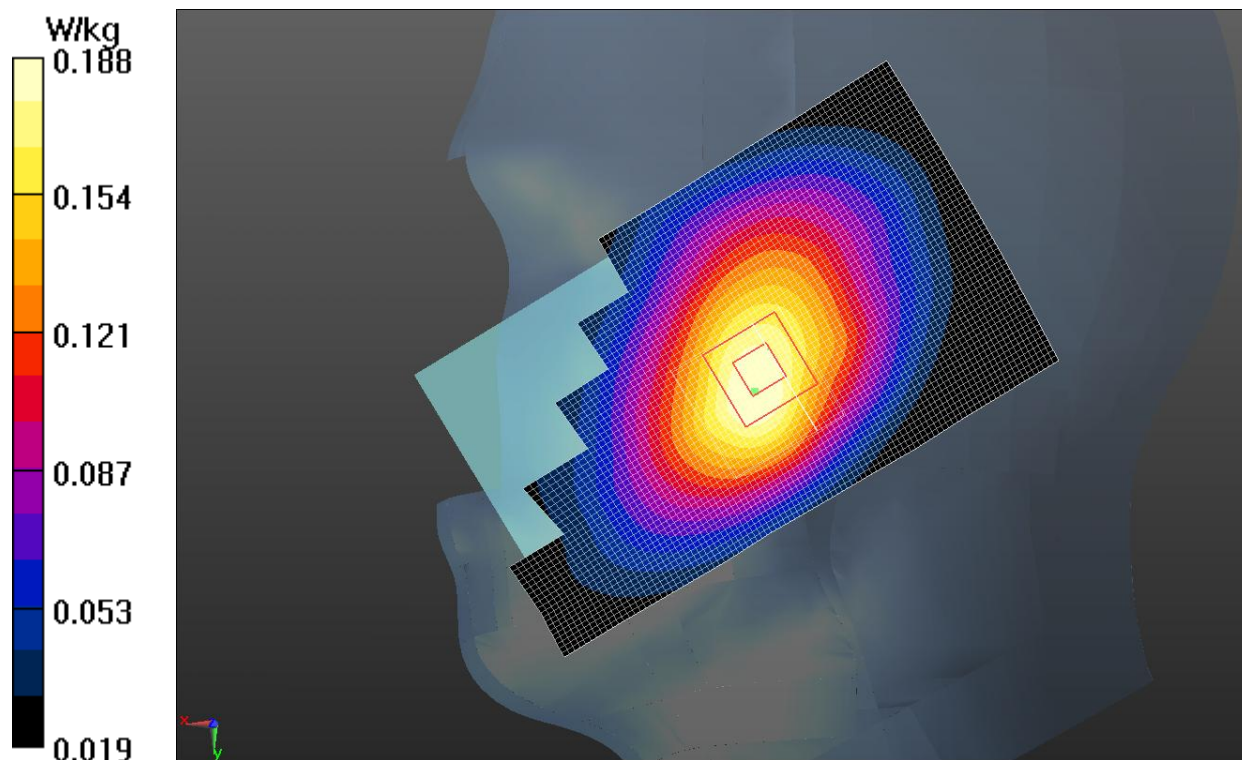

Fig.5 WCDMA 850 CH4182

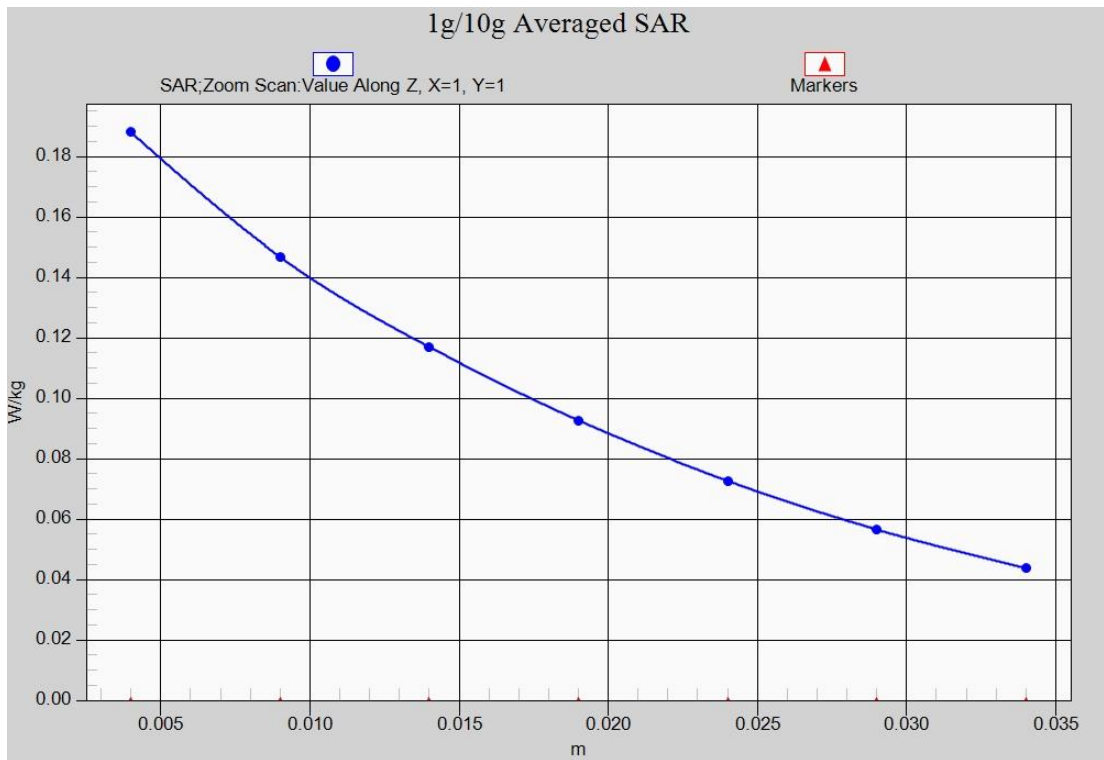

Fig.5-1 Z-Scan at power reference point (WCDMA 850 CH4182)

WCDMA 850 Body Rear High

Date/Time: 2015-12-25

Electronics: DAE4 Sn786

Medium: Body850 MHz

Medium parameters used (interpolated): $f = 846.6$ MHz; $\sigma = 0.982$ S/m; $\epsilon_r = 53.433$; $\rho = 1000$ kg/m³

Ambient Temperature: 22.0°C Liquid Temperature: 21.5°C

Communication System: WCDMA Frequency: 846.6 MHz Duty Cycle: 1:1

Probe: ES3DV3 - SN3151 ConvF(6.13, 6.13, 6.13);

Rear side High/Area Scan (61x101x1): Interpolated grid: dx=1.500 mm, dy=1.500 mm

Maximum value of SAR (interpolated) = 0.330 W/kg

Rear side High/Zoom Scan (5x5x7)/Cube 0: Measurement grid: dx=8mm, dy=8mm, dz=5mm

Reference Value = 16.143 V/m; Power Drift = 0.05 dB

Peak SAR (extrapolated) = 0.393 W/kg

SAR(1 g) = 0.313 W/kg; SAR(10 g) = 0.234 W/kg

Maximum value of SAR (measured) = 0.330 W/kg

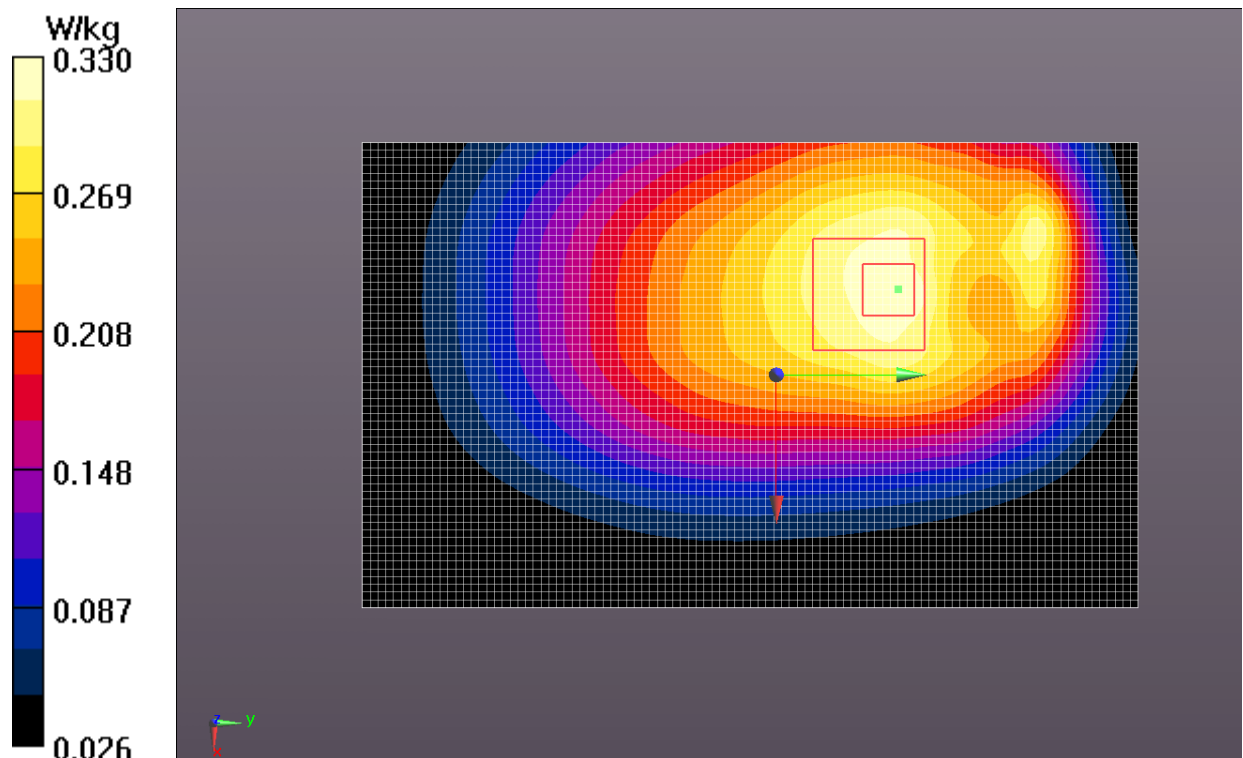

Fig.6 WCDMA 850 CH4233

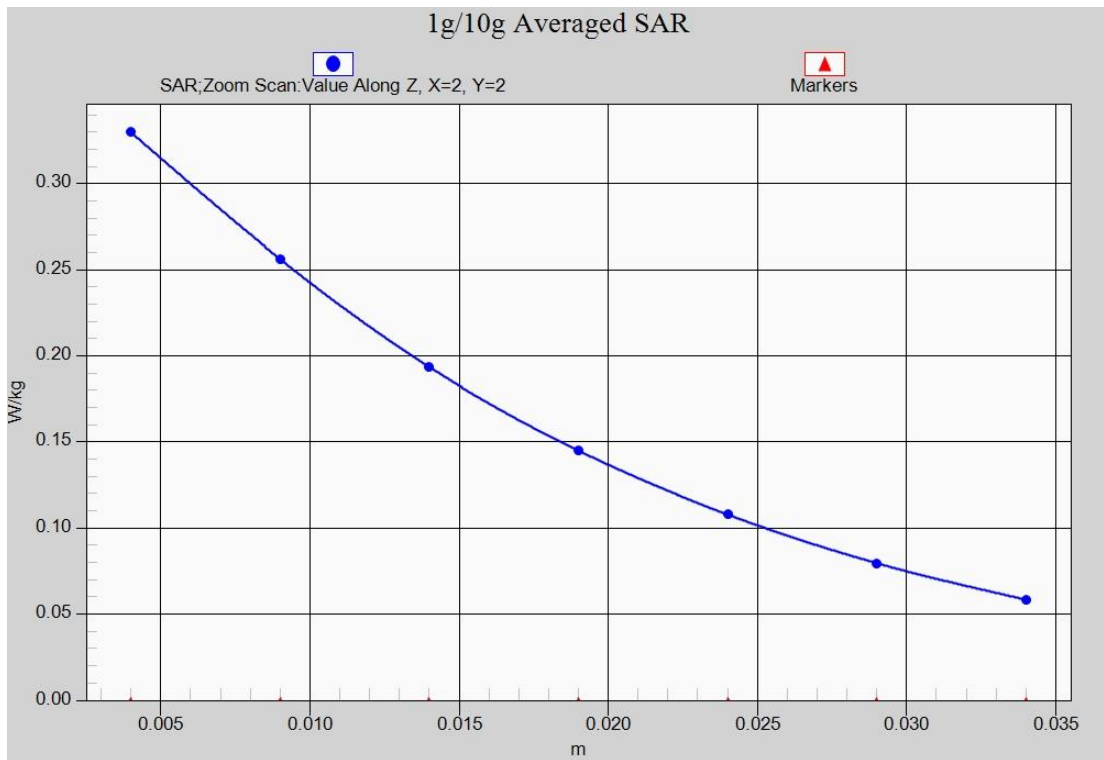

Fig.6-1 Z-Scan at power reference point (WCDMA850 CH4233)

WCDMA 1900 Left Cheek low

Date/Time: 2015-12-17

Electronics: DAE4 Sn786

Medium: 1900 Head

Medium parameters used (interpolated): $f = 1852.4$ MHz; $\sigma = 1.359$ S/m; $\epsilon_r = 38.399$; $\rho = 1000$ kg/m³

Ambient Temperature: 22.0°C Liquid Temperature: 21.5°C

Communication System: WCDMA Frequency: 1852.4 MHz Duty Cycle: 1:1

Probe: ES3DV3 - SN3151 ConvF(4.96, 4.96, 4.96);

Left Cheek Low/Area Scan (61x111x1): Interpolated grid: dx=1.500 mm, dy=1.500 mm

Maximum value of SAR (interpolated) = 0.349 W/kg

Left Cheek Low/Zoom Scan (5x5x7)/Cube 0: Measurement grid: dx=8mm, dy=8mm, dz=5mm

Reference Value = 7.607 V/m; Power Drift = 0.05 dB

Peak SAR (extrapolated) = 0.498 W/kg

SAR(1 g) = 0.323 W/kg; SAR(10 g) = 0.200 W/kg

Maximum value of SAR (measured) = 0.347 W/kg

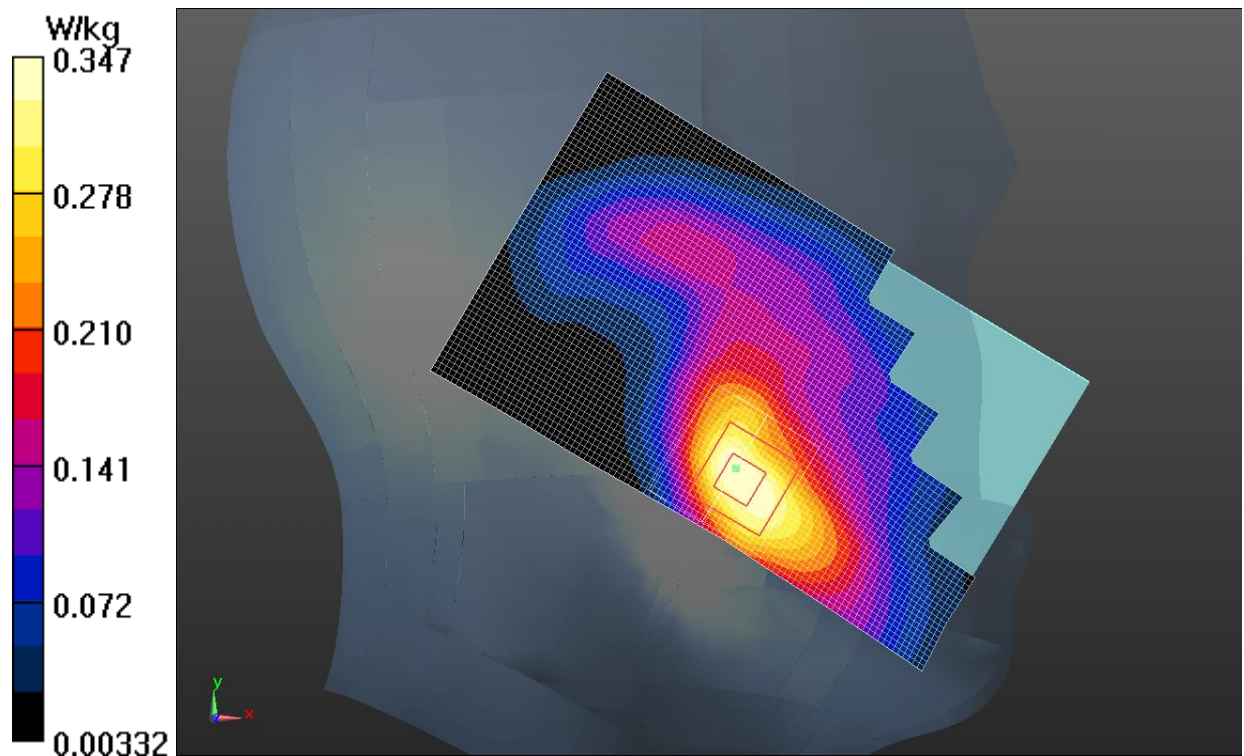

Fig.7 WCDMA1900 CH9262

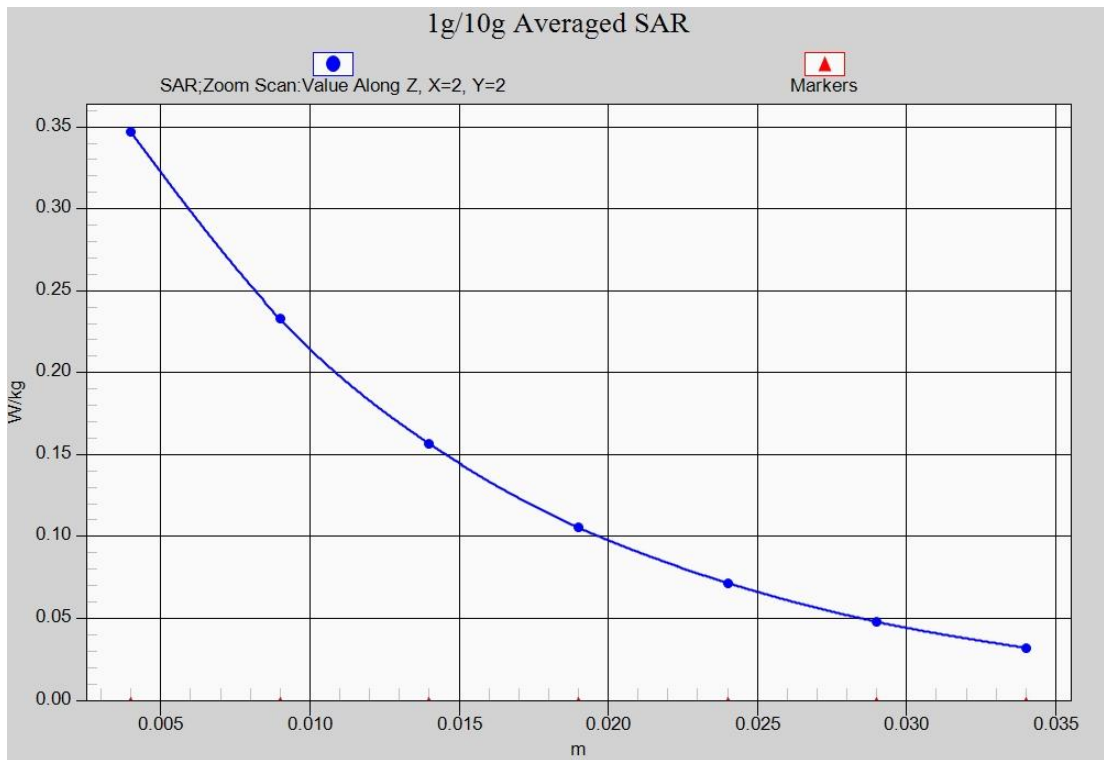

Fig.7-1 Z-Scan at power reference point (WCDMA1900 CH9262)

WCDMA 1900 Body Rear side -AP ON

Date/Time: 2015-12-26

Electronics: DAE4 Sn786

Medium: Body1900 MHz

Medium parameters used (interpolated): $f = 1852.4$ MHz; $\sigma = 1.52$ S/m; $\epsilon_r = 53.536$; $\rho = 1000$ kg/m³

Ambient Temperature: 22.0°C Liquid Temperature: 21.5°C

Communication System: WCDMA Frequency: 1852.4 MHz Duty Cycle: 1:1

Probe: ES3DV3 - SN3151 ConvF(4.5, 4.5, 4.5);

Rear side Low/Area Scan (61x101x1): Interpolated grid: dx=1.500 mm, dy=1.500 mm

Maximum value of SAR (interpolated) = 0.476 W/kg

Rear side Low/Zoom Scan (5x5x7)/Cube 0: Measurement grid: dx=8mm, dy=8mm, dz=5mm

Reference Value = 8.513 V/m; Power Drift = 0.09 dB

Peak SAR (extrapolated) = 0.668 W/kg

SAR(1 g) = 0.428 W/kg; SAR(10 g) = 0.267 W/kg

Maximum value of SAR (measured) = 0.466 W/kg

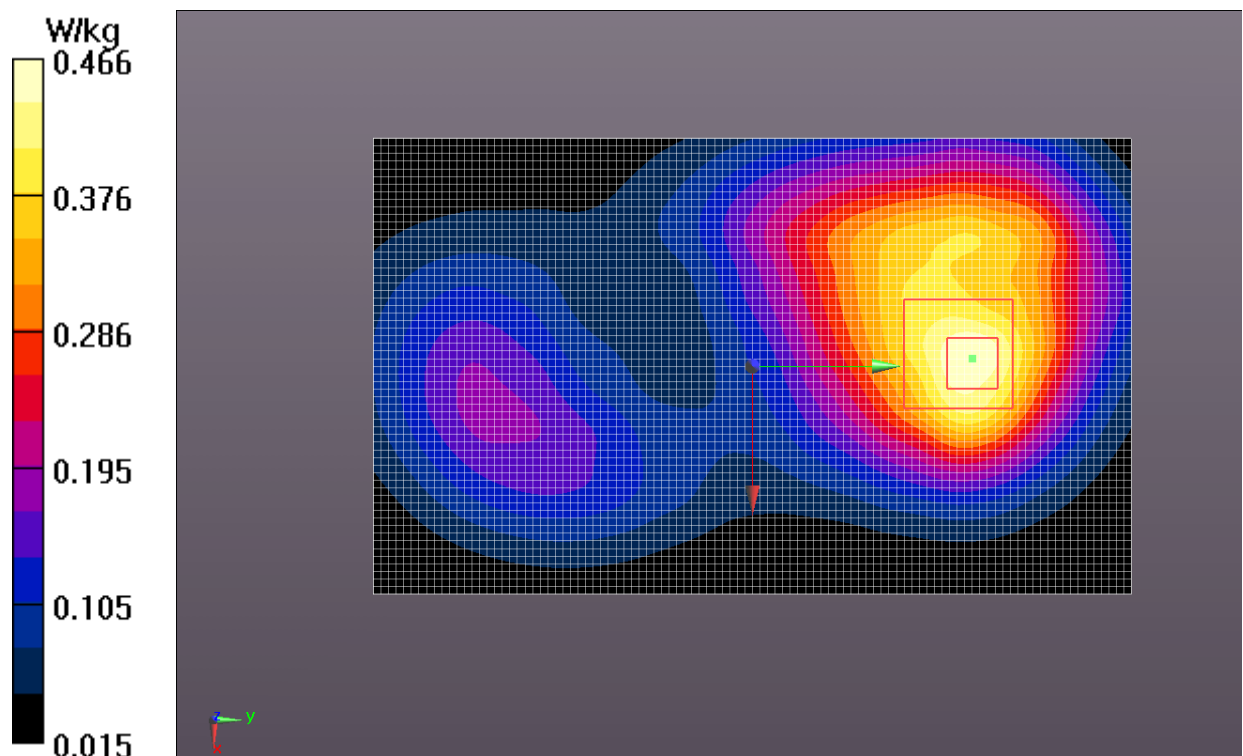

Fig.8 WCDMA1900 CH9262

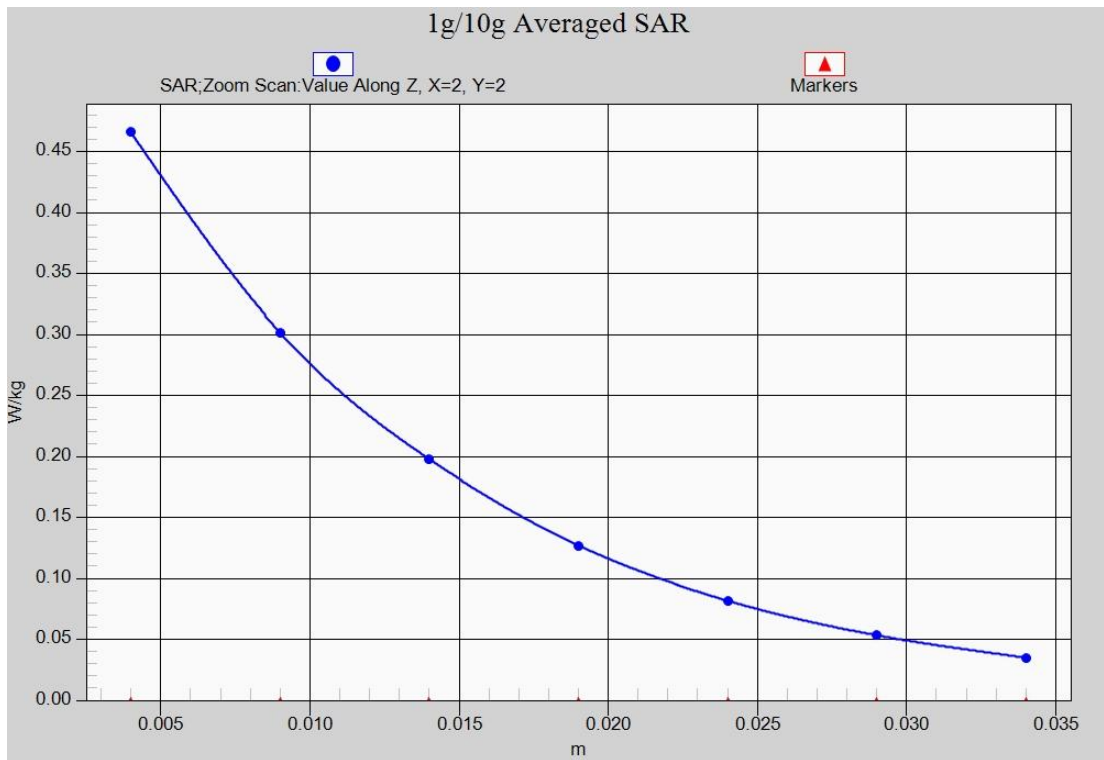

Fig.8-1 Z-Scan at power reference point (WCDMA1900 CH9262)