



Hearing Aid Compatibility (HAC) T-Coil Test Report

APPLICANT : Reliance Communications LLC
PRODUCT NAME : Orbic Style 5G
MODEL NAME : R678L5S
BRAND NAME : Orbic
FCC ID : 2ABGH-R678L5S
STANDARD(S) : FCC 47 CFR Part 20(20.19)
ANSI C63.19-2019
RECEIPT DATE : 2024-01-16
TEST DATE : 2024-02-04 to 2024-03-12
ISSUE DATE : 2024-04-17



Edited by: Xie Yiyun
Xie Yiyun (Rapporteur)
Approved by: Gan Yueming
Gan Yueming (Supervisor)

NOTE: This document is issued by Shenzhen Morlab Communications Technology Co., the test report shall not be reproduced except in full without prior written permission of the company. The test results apply only to the particular sample(s) tested and to the specific tests carried out which is available on request for validation and information confirmed at our website.





DIRECTORY

- 1. Statement of T-Coil Measurement.....4
- 2. Technical Information5
 - 2.1. Applicant and Manufacturer Information5
 - 2.2. Equipment under Test (EUT) Description.....5
 - 2.3. Photographs of the EUT7
 - 2.4. Applied Reference Documents7
- 3. Air Interface and Operating Mode8
- 4. T-Coil Test Requirements and Restrictions9
 - 4.1. T-Coil Coupling Qualifying Field Strengths9
 - 4.2. Desired ABM signal and Undesired ABM Field Qualification Requirements9
 - 4.3. Frequency Response10
- 5. HAC (T-Coil) Measurement System.....11
 - 5.1. T-Coil Measurement Setup11
 - 5.2. Base Station Gain Factor.....12
 - 5.3. T-Coil Measurement Reference Plane.....13
 - 5.4. System Validation.....14
- 6. T-Coil Test Procedure.....15
 - 6.1. General Description15
 - 6.2. T-Coil Test Flow.....17
- 7. Test Equipment List19
- 8. Summary Test Results.....20
 - 8.1. Test Guidance20
 - 8.2. Test Results21
- 9. Uncertainty Assessment25



Annex A General Information.....26

Annex B Test Setup Photos27

Annex C Plots of T-Coil Test Results.....27

Annex D DASYS Calibration Certificate.....27

Change History		
Version	Date	Reason for change
1.0	2024-04-17	First edition



1. Statement of T-Coil Measurement

The lowest contiguous point count of primary group and secondary group found during test as bellows:

Air Interface	Primary Group Contiguous Point Count	Secondary Group Contiguous Point Count	Frequency Response
GSM CMRS Voice	214	394	PASS
UMTS CMRS Voice	332	567	PASS
VoLTE	310	540	PASS
VoWiFi	335	532	PASS

Note:

1. This device is in compliance with compliance with T-Coil requirement specified in FCC 47 CFR Part 20.19 and tested in accordance with the measurement methods and procedures specified in ANSI C63.19-2019 and FCC KDB publications.
2. The 2N force is used for testing requirements related to use by persons with hearing devices and the 8N force is used for testing requirements related to use by persons without hearing devices.
3. When the test result is a critical value, we will use the measurement uncertainty give the judgment result based on the 95% confidence intervals.



2. Technical Information

Note: Provide by applicant.

2.1. Applicant and Manufacturer Information

Applicant:	Reliance Communications LLC
Applicant Address:	555 Wireless Blvd. Hauppauge, NY 11788, USA
Manufacturer:	Unimaxcomm
Manufacturer Address:	35F,HBC HuiLong Center Building-II Minzhi Street,Longhua, Shenzhen, P.R. China 518110

2.2. Equipment under Test (EUT) Description

Product Name:	Orbic Style 5G
EUT IMEI:	354170950030422
Hardware Version:	V1.0
Software Version:	R678L5S_V1.0.24_BVZ
Frequency Bands:	GSM 850: 824 MHz ~ 849 MHz GSM 1900: 1850 MHz ~ 1910 MHz WCDMA Band II: 1850 MHz ~ 1910 MHz WCDMA Band IV: 1710 MHz ~ 1755 MHz WCDMA Band V: 824 MHz ~ 849 MHz LTE Band 2: 1850 MHz ~ 1910 MHz LTE Band 4: 1710 MHz ~ 1755 MHz LTE Band 5: 824 MHz ~ 849 MHz LTE Band 7: 2500 MHz ~ 2570 MHz LTE Band 12: 699 MHz ~ 716 MHz LTE Band 13: 777 MHz ~ 787 MHz LTE Band 48: 3550 MHz ~ 3700 MHz LTE Band 66: 1710 MHz ~ 1780 MHz 5G NR n2: 1850 MHz ~ 1910 MHz 5G NR n5: 824 MHz ~ 849 MHz 5G NR n48: 3550 MHz ~ 3700 MHz 5G NR n66: 1710 MHz ~ 1780 MHz 5G NR n77: 3450 MHz ~ 3550 MHz; 3700 MHz ~3980 MHz 5G NR n78: 3450 MHz ~ 3550 MHz; 3700 MHz ~ 3800 MHz WLAN 2.4GHz: 2412 MHz ~ 2462 MHz WLAN 5.2GHz: 5180 MHz ~ 5240 MHz WLAN 5.8GHz: 5745 MHz ~ 5825 MHz



	Bluetooth: 2402 MHz ~ 2480 MHz NFC: 13.56 MHz WPT(RX): 110 KHz ~ 205 KHz	
Modulation Mode:	GSM/GPRS: GMSK EDGE: 8PSK WCDMA: QPSK, 16QAM LTE: QPSK, 16QAM, 64QAM, 256QAM (only CA support) 5G NR: DFT-s-OFDM/CP-OFDM, PI/2 BPSK QPSK, 16QAM, 64QAM, 256QAM 802.11b: DSSS 802.11a/g/n-HT20/HT40/ac-VHT20/40/80: OFDM BR+EDR: GFSK(1Mbps), $\pi/4$ -DQPSK(2Mbps), 8-DPSK(3Mbps) Bluetooth LE: GFSK(1Mbps) NFC: ASK WPT(RX): ASK	
Antenna type:	WWAN: PIFA Antenna WLAN: PIFA Antenna Bluetooth: PIFA Antenna NFC: Loop Antenna	
VoLTE Mode:	Support	
VoWi-Fi Mode:	Support	
SIM Cards Description:	SIM 1	GSM+WCDMA+LTE+5G NR
	SIM 2	GSM+WCDMA+LTE+5G NR
	For dual SIM card version, both the SIM 1 and SIM 2 are the same chipset unit and tested as a single chipset, the SIM 1 was selected for testing.	

Note: For more detailed description, please refer to specification or user manual supplied by the applicant and/or manufacturer.



2.3. Photographs of the EUT

Please refer to the External Photos for the Photos of the EUT

2.4. Applied Reference Documents

Leading reference documents for testing:

No.	Identity	Document Title	Method determination Remark
1	FCC 47 CFR Part 20 (20.19)	Hearing aid-compatible mobile handsets	No deviation
2	ANSI C63.19-2019	American National Standard Methods of Measurement of Compatibility between Wireless Communications Devices and Hearing Aids	No deviation
3	KDB 285076 D01v06r04	HAC Guidance	No deviation
4	KDB 285076 D02v04	T-Coil testing for CMRS IP	No deviation
5	KDB 285076 D03v01r06	HAC FAQ	No deviation

Note: Additions to, deviation, or exclusions from the method shall be judged in the "method determination" column of add, deviate or exclude from the specific method shall be explained in the "Remark" of the above table.



3. Air Interface and Operating Mode

Air Interface	Band	Transport Type	Simultaneous Transmitter	Name of Voice Service	Power Reduction
GSM	GSM850	VO	WLAN,BT	CMRS Voice	No
	GSM1900				No
WCDMA (UMTS)	Band II	VO	WLAN,BT	CMRS Voice	No
	Band IV				No
	Band V				No
FDD-LTE & TDD-LTE	Band 2	VD	WLAN,BT	VoLTE	No
	Band 4				No
	Band 5				No
	Band 7				No
	Band 12				No
	Band 13				No
	Band 48				No
5G NR	n2	DT	WLAN, BT	N/A	No
	n5				No
	n48				No
	n66				No
	n77				No
	n78				No
WiFi	2450	VD	GSM, UMTS, LTE, 5G NR	VoWiFi	No
	5200 (U-NII-1)				No
	5800 (U-NII-3)				No
BT	2450	DT	GSM, UMTS, LTE, 5G NR	N/A	No

Note:

- 1) Air Interface/Band MHz: List of all air interfaces and bands supported by the handset.
- 2) Type: For each air interface, indicate the type of voice transport mode:
 - i. VO = legacy Cellular Voice Service, from ANSI C63.19-2019;
 - ii. DT = Digital Transport only (no voice); and
 - iii. VD = IP Voice Service over Digital Transport.
- 3) Simultaneous Transmitter: Indicate any air interface/bands that operate in simultaneous or concurrent service transmission mode.
- 4) Name of Voice Service: See Q4 in 285076 D03 HAC FAQ for further clarification.



4. T-Coil Test Requirements and Restrictions

4.1. T-Coil Coupling Qualifying Field Strengths

In order to comply with the requirements for T-Coil use, a WD's tested operating modes shall simultaneously meet the requirements for minimum desired ABM signal level and maximum undesired ABM field contained in this sub clause at the minimum specified number of scanned locations.

When measured as specified in this standard, there are two groups of qualifying measurement points:

Primary group: A qualifying measurement point shall have its T-Coil signal, desired ABM signal, ≥ -18 dB(A/m) at 1 kHz, in a 1/3 octave band filter. These measurements shall be made with the WD operating at a reference input level as specified in Table 6.1. Simultaneously, the qualifying measurement point shall have its weighted magnetic noise, undesired ABM field ≤ -38 dB (A/m).

Secondary group: A qualifying measurement point shall have its weighted magnetic noise, undesired ABM field ≤ -38 dB (A/m). This group inherently includes all the members of the primary group.

These levels are designed to be compatible with hearing aids that produce the same acoustic output level for either an acoustic input level of 65 dB SPL or a magnetic input level of -25 dB(A/m) (56.2 mA/m) at either 1.0 kHz or 1.6 kHz. The hearing aid operational measurements are performed per ANSI S3.22-2014.

4.2. Desired ABM signal and Undesired ABM Field Qualification Requirements

➤ 2G GSM Operating Modes

If the 2G GSM operating mode(s) are selected for qualification, the qualifying measurement points shall fulfill the requirements of section 6.6.2 of ANSI C63.19; both the primary and secondary group requirements shall be met:

- The primary group shall include at least 25 measurement points.
- The secondary group shall include at least 125 contiguous measurement points.

➤ Non-2G GSM Operating Modes

The goal of this requirement is to ensure an adequate area where desired ABM signal is sufficiently strong to be heard clearly and a larger area where undesired ABM field is sufficiently low as to avoid undue annoyance. Qualifying measurement points shall fulfill the requirements of section 6.6.2 of ANSI C63.19; both the primary and secondary group requirements shall be met:

- The primary group shall include at least 75 measurement points.

- The secondary group shall include at least 300 contiguous measurement points.

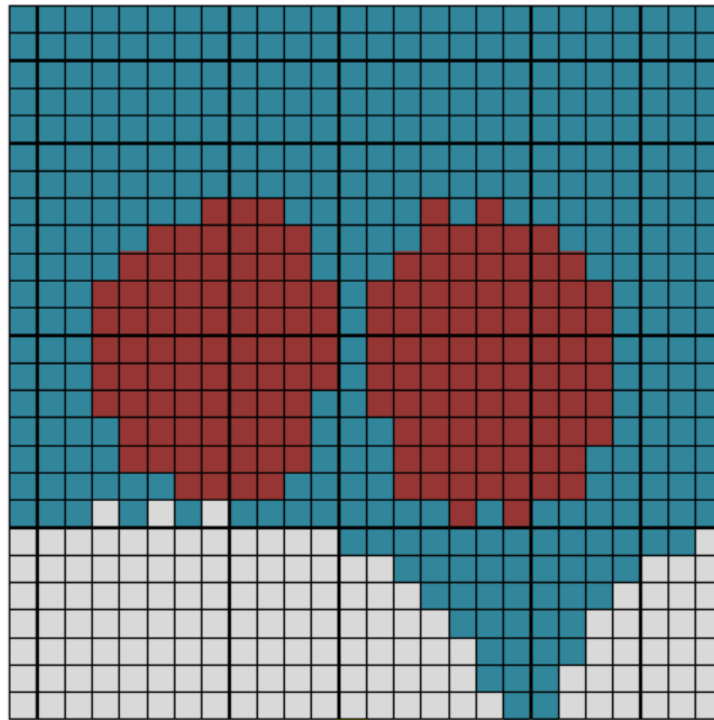

Red (primary group): AB desired ABM signal $M1 \geq -18$ dB(A/m) and undesired ABM field ≤ -38 dB(A/m)
 Blue and red (secondary group): undesired ABM field ≤ -38 dB(A/m)

Fig 4.1 An example of a qualifying desired ABM signal, undesired ABM field scan

4.3. Frequency Response

The frequency response of the perpendicular component of the magnetic field, measured in 1/3 octave bands, shall follow the response curve specified in this sub-clause, over the frequency range 300 Hz to 3 kHz.

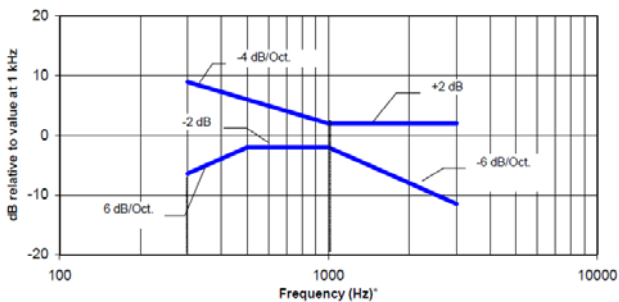

NOTE—The frequency response is between 300 Hz and 3000 Hz.

Fig 4.2 Magnetic field frequency response for WDs with field strength ≤ -15 dB (A/m) at 1 kHz

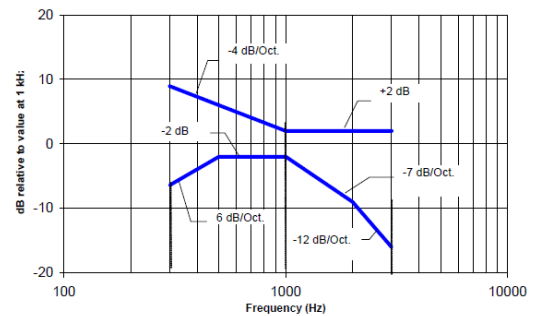

NOTE—The frequency response is between 300 Hz and 3000 Hz.

Fig 4.3 Magnetic field frequency response for WDs with a field that exceeds -15 dB (A/m) at 1 kHz

5. HAC (T-Coil) Measurement System

5.1. T-Coil Measurement Setup

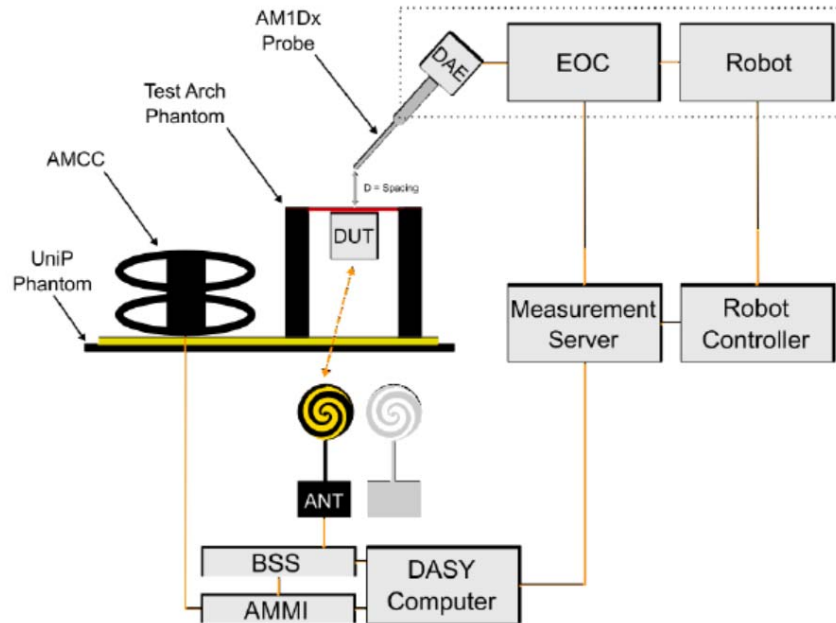

Fig 5.1 SPEAG T-Coil System Configurations

Note:

- Per C63.19 & KDB 285076 D02, define the all applicable input audio level:

Standard	Protocol	Input Level (dBm0)
TIA-2000	CDMA	-18
TIA/EIA-136	TDMA (50 Hz)	-18
J-STD-007	GSM (217 Hz)	-16
T1/T1P1/3GPP (See Note 1)	UMTS (WCDMA)	-16
iDEN	TDMA (22 Hz and 11 Hz)	-18
VoIP (See Note 2)	Voice over Internet Protocol	-16

Note 1: For UMTS (Universal Mobile Telecommunications System), refer to 3GPP TS26.131 and TS26.132.

Note 2: VoIP is used in this table as a general term specifying a group of voice services that use -16 dBm0 as their normal acoustic level. The group includes a variety of voice services, including Voice-over-LTE (VoLTE), Voice-over-IP-multimedia-subsystem (VoIMS), Voice-over-Wi-Fi (VoWiFi) and similar services. For 3G, LTE, and WLAN terminals used for Commercial Mobile Radio Service (CMRS) based telephony, refer to 3GPP TS26.131 and TS26.132.



2. A communication base station CMU200 is used for testing GSM / UMTS / CDMA, and it's "Decode Cal" and "Codec Cal" with audio option B52 and B85 to set the correct audio input level.
3. CMU200 is able to output 1 kHz audio signal equivalent to 3.14dBm0 at "Decode Cal", the signal reference is used to adjust the AMMI gain setting to reach -16dBm0 for GSM/UMTS and -18dBm0 for CDMA.
4. The callbox of CMW500 is used for VoLTE over IMS and VoWiFi over IMS T-Coil measurement, the data application unit of the CMW500 was used to simulate the IP multimedia subsystem server. And the CMW500 can be manually configured to ensure and control the speech input level result is -16dBm0 for VoLTE and -20dBm0 for VoWiFi when the device during the IMS connection.
5. The OTT VoIP call is tested on the data application unit of CMW500 connection to the internet.

5.2. Base Station Gain Factor

1. The Required gain factor for the specific signal shall typically be multiplied by this factor to achieve approx. the same level as for the 1 kHz sine signal.
2. The calculation formula as below showing how to determine the input level for air interface for this device.

The predefined signal types have the following differences / factors compared to the 1kHz sine signal:

Signal [file name]	Duration [s]	Peak-to-RMS [dB]	RMS [dB]	Required gain factor (*)	Gain setting
1kHz sine	---	3.0	0.0	1.00	
48k_1.025kHz_10s.wav	10	3.0	0.0	1.00	
48k_1kHz_3.15kHz_10s.wav	10	6.0	-3.0	1.42	
48k_315Hz_1kHz_10s.wav	10	6.0	-2.9	1.40	
48k_csek_8k_441_white_10s.wav	10	13.8	-10.5	3.34	
48k_multisine_50-5000_10s.wav	10	11.1	-7.9	2.49	
48k_voice_1kHz_1s.wav	1	16.2	-12.7	4.33	
48k_voice_300-3000_2s.wav	2	21.6	-18.6	8.48	

(*) The gain for the specific signal shall typically be multiplied by this factor to achieve approx. the same level as for the 1kHz sine signal.

Insert the gain applicable for your setup in the last column of the table.

<Input level determination>

Gain Value (linear)	Full Scaled Voltage (V)	dBm0	dB	AMMI Audio Out	AMCC Coil Out
-	1.5	3.14		0.5	3.14
100		5.6	40	2.96	-15.38
9.31		-16	19.38		-16

<Base station gain factor calculation>

Signal Type	Duration (s)	Peak to RMS (dB)	RMS (dB)	Gain Factor	Gain Setting
1kHz sine	-	3	0	1	8.17
48k_voice_1kHz	1	16.4	-12.8	4.35	40.32
48k_voice_300-3000	2	21.8	-18.7	8.51	78.96

5.3. T-Coil Measurement Reference Plane

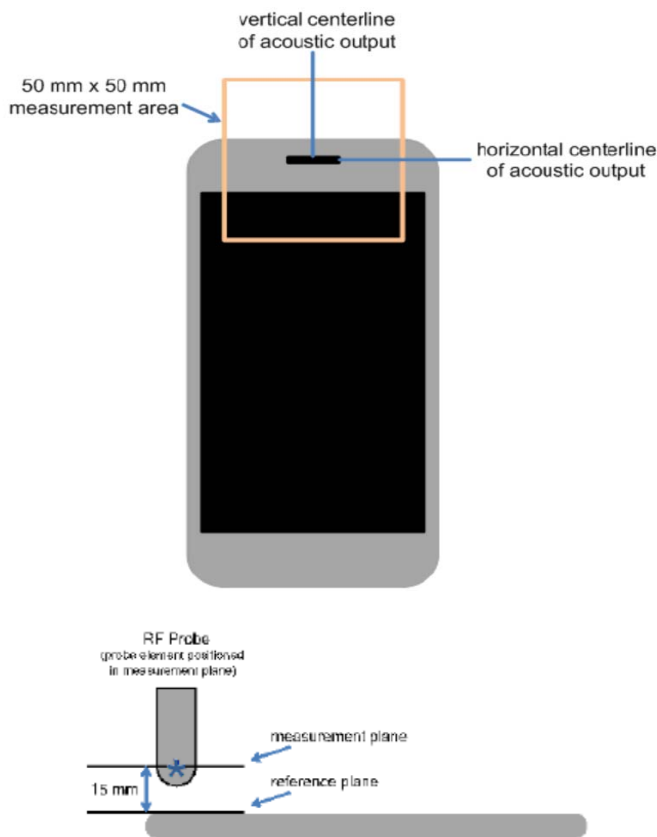

Fig 5.2 WD measurement and reference planes for RF emission measurements

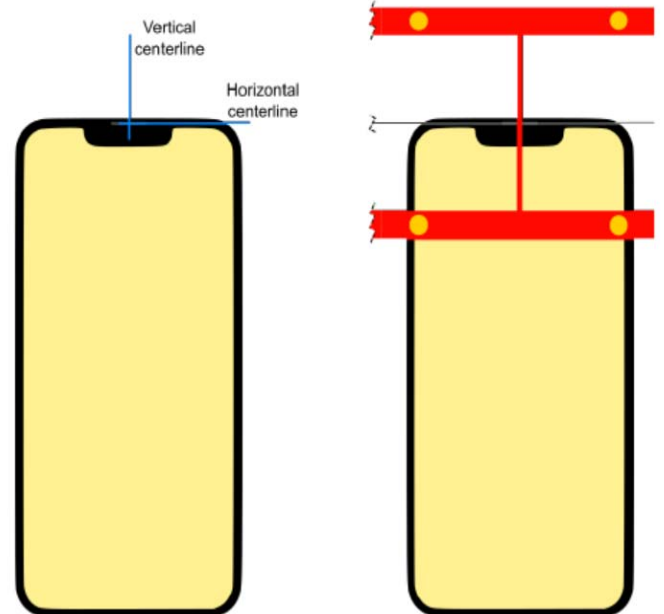

Fig 5.3 Device Under Test Positioning under the Test Arch

Note:

1. The reference plane is the planar area that contains the highest point in the area of the phone that normally rests against the user's ear. It is parallel to the centerline of the receiver area of the phone and is defined by the points of the receiver-end of the WD handset, which, in normal handset use, rest against the ear.
2. The measurement plane is parallel to, and 10 mm in front of, the reference plane.



3. The reference axis is normal to the reference plane and passes through the center of the acoustic output (or the center of the hole array); or may be centered on or near a secondary inductive source. The actual location of the reference axis and resultant measurement area shall be noted in the test report.
4. The measurement area shall be 50 mm by 50 mm. The measurement area for both desired ABM signal and undesired ABM field may be located where the transverse magnetic measurements are optimum with regard to the requirements. However, the measurement area should be in the vicinity of the acoustic output of the WD and shall be located in the same half of the phone as the WD receiver. In a WD handset with a centered receiver and a circularly symmetrical magnetic field, the measurement axis and the reference axis would coincide.
5. Measurements of desired ABM signal strength and undesired ABM field are made at 2.0 mm \pm 0.5 mm or 4 mm intervals in an X-Y measurement area pattern over the entire measurement area (676 measurement points total); either all measured, or measured plus interpolated, per 6.4 of ANSI C63.19.
6. Desired ABM signal frequency response is measured at a single location at or near the maximum desired ABM signal strength location.
7. The actual locations of the measurement points shall be noted in the test report.

5.4. System Validation

For correct and calibrated measurement of the voltages and ABM filed, DASYS will perform a calibration job follows below:

1. In phase 1, the audio output is switched off, and a 200 mW symmetric rectangular signal of 1 kHz is connected directly to both channels of the sampling unit (Coil in, Probe in).
2. In phase 2, the audio output is off, and a 20 mW symmetric 100 Hz signal is internally connected. The signals during phases 1 and 2 are available at the output on the rear panel of the AMMI. However, the output must not be loaded, in order to avoid influencing the calibration, an RMS voltmeter would indicate 100mWRMS, during the second phase after the first two phases, the two input channels are both calibrated for absolute ants of voltages. The resulting factors are displayed above the multi-meter window.
3. After phases 1 and 2, the input channels are calibrated to measure exact voltages. This is required to use the inputs for measuring voltages with their peak and RMS value.
4. In phase 3, a mult-sine signal covering each third-octave band from 50 Hz to 10 kHz is generated and applied to both audio outputs. The probe should be positioned in the center of the AMCC and aligned in the z-direction, the filed orientation of the AMCC. The "Coil In" channel is measuring the voltage over the AMCC internal shunt, which is proportional to the magnetic filed in the AMCC. At the same time, the "Probe In" channel samples the amplified signal picked up by the probe coil and provides a numerical integrator. The ratio of two voltages in each third-octave filter leads to the spectral representation over the frequency band of interest. The coil signal is scaled in dBV, and the probe signal is first integrated and normalized to show dB A/m. The ratio probe-to-coil at the frequency of 1 kHz is the sensitivity which will be used in the consecutive T-coil jobs.



6. T-Coil Test Procedure

6.1. General Description

T-Coil measurement follows Section 6.4 of ANSI C63.19-2019.

This sub clause describes the procedures used to measure the ABM (T-Coil) performance of the WD. Measurements shall be performed over a measurement area 50 mm square, in the measurement plane, as specified in A.3. The measurement area shall be scanned with a uniform measurement point spacing of 2.0 mm \pm 0.5 mm in each X-Y axis of the plane, yielding 676 measurement points with approximately even spacing throughout the area.

Optionally, measurement point spacing may be increased to 4 mm, with interpolation employed to yield the required 676 equivalent measurement points distributed uniformly over the 50 mm square measurement area. Interpolated points shall be derived from the average of the linear representations of the field strengths of the nearest two or four equidistant measured points. The area of measurement is increased to a 52 mm square so that edge rows and columns of the required 50 mm square can be either measured or interpolated, with none extrapolated.

In addition to measuring the desired ABM signal levels, the weighted magnitude of the unintended signal shall also be determined. Weighting of the unintended and undesired ABM field shall be by the spectral and temporal weighting described in D.4 through D.6.

In order to assure that the required signal quality is measured, the measurement of the intended signal and the measurement of the unintended signal shall be made at the same locations. Measurements shall not include undesired influence from the WD's RF field; therefore, use of a coaxial connection to a base station simulator or non-radiating load might be necessary. However, even then with a coaxial connection to a base station simulator or non-radiating load there could still be RF leakage from the WD, which could interfere with the desired measurement. Pre-measurement checks should be made to avoid this possibility. All measurements shall be done with the WD operating on battery power with an appropriate normal speech audio signal input level given in Table 6.1. If the device display can be turned off during a phone call, then that may be done during the measurement as well. If tested with the display in the off state this shall be documented in the test report.

Measurements shall be performed with the probe coil oriented in the transverse direction, as illustrated in A.3, that is, aligned in the plane of the measurement area and perpendicular to the long dimension of the WD. A multi-stage sequence consists of first measuring the field strength of the desired T-Coil signal (desired ABM signal) that is useful to a hearing aid T-Coil at each specified measurement point. The undesired magnetic component (undesired ABM field) is then measured in the same transverse orientation at each of



the same measurement points. At a single location only, taken at or near the highest desired ABM signal reading, the desired ABM signal frequency response shall be determined in a third measurement stage. The flowchart in Figure 6.3 illustrates this three-stage process.

To minimize the need to test every WD operating mode to the telecoil requirements of Clause 6, it is permissible to exclude some subset of supported configurations. For a given WD, every mode that supports voice communication shall be considered for telecoil testing. However, if it can be demonstrated that a certain configuration will not be the worst-case telecoil configuration, such configurations may be excluded from the full telecoil scans of 6.4.34. For example, operating modes may be pre-screened by scanning for both desired ABM signal and undesired ABM field at a lower measurement point density than the final scans, thus saving considerable testing time by eliminating configurations that are excellent performers from more detailed testing for worst-case. In any case, the specific methods and criteria used to determine which configurations are excluded for a WD shall be explicitly stated and justified in the test report. To be considered for exclusion from telecoil testing, operating modes shall also be shown to pass the frequency response requirements of 6.6.3.

Many factors could affect telecoil test results. RF power level and amplitude modulation characteristics as well as the specific current paths within the WD associated with the RF output stage(s), the display, and processing circuitry could affect the undesired ABM field. Audio codec implementation and acoustic receiver characteristics could also affect the desired ABM signal). Therefore, any justifications for exclusions should be thorough documented. If an operating mode is under user control and instructions on how to place the WD in a less interfering condition is in the user instructions, those instructions may be followed in configuring the device for testing.

6.2. T-Coil Test Flow

This section follows ANSI C63.19-2019 section 6.4.1:

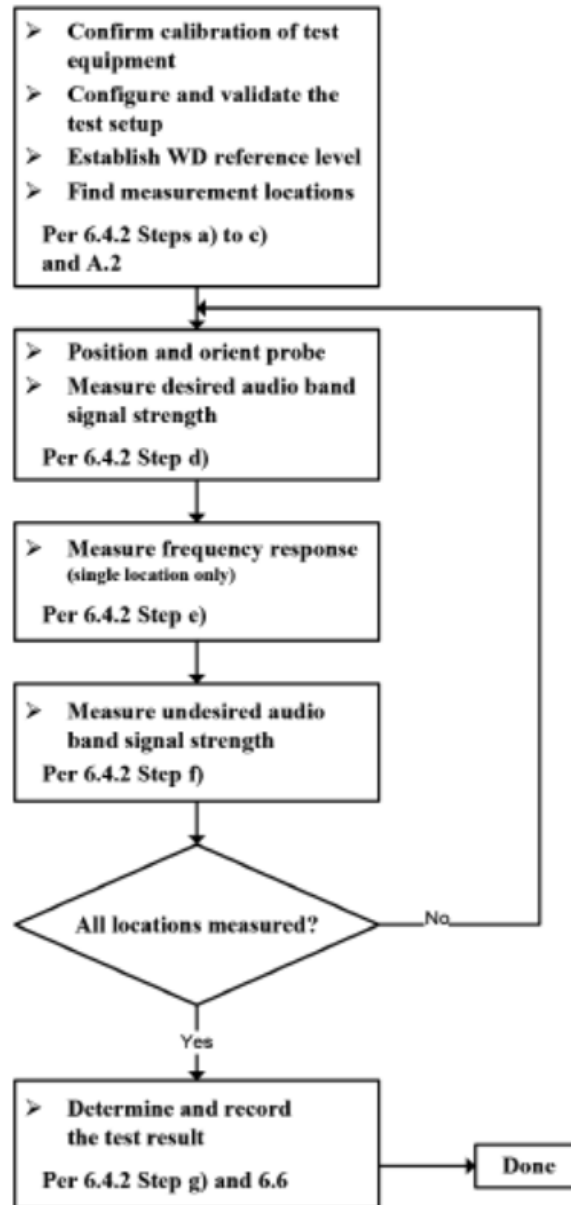

Fig 6.1 WD T-Coil signal test flowchart

Note:

The following steps summarize the basic test flow for determining desired ABM signal and undesired ABM field. These steps assume that a sine wave or narrowband 1/3 octave signal can be used for the measurement of desired ABM signal level. An alternative procedure, yielding equivalent results, using a broadband excitation is described in 6.5 of ANSI C63.19-2019.

1. A validation of the test setup and instrumentation shall be performed. This may be done using a TMFS



or Helmholtz Coil. Measure the emissions and confirm that they are within tolerance of the expected values.

2. Confirm that equipment that requires calibration has been calibrated, and that the noise level meets the requirements given in 6.3.2.
3. Position the WD in the test setup and connect the WD RF connector to a base station simulator or a non-radiating load (if necessary to control RF interference in the measurement equipment) as shown in Figure 6.1 or Figure 6.2.
4. The drive level to the WD is set such that the reference input level specified in Table 6.1 is input to the base station simulator (or manufacturer's test mode equivalent) in the 1 kHz, 1/3 octave band. This drive level shall be used for the T-Coil signal test (desired ABM signal) at $f = 1$ kHz. Either a sine wave at 1025 Hz, or a voice-like signal, band-limited to the 1 kHz 1/3 octave, as specified in 6.4.3, shall be used for the reference audio signal. If interference is found at 1025 Hz an alternative nearby reference audio signal frequency may be used.³⁵ The same drive level will be used for the desired ABM signal frequency response measurements at each 1/3 octave band center frequency. The WD volume control may be set at any level up to maximum, provided that a signal at any frequency at maximum modulation would not result in clipping or signal overload.
5. At each measurement location over the measurement area and in the transverse orientation, measure and record the desired 1 kHz T-Coil magnetic signal (desired ABM signal) as described in Step c).
6. At or near a location representing a maximum in the just-measured desired ABM signal, measure and record the desired T-Coil magnetic signals (desired ABM signal at f_i) as described in 6.4.5.2 in each individual ISO 266:1975 R10 standard 1/3 octave band. The desired audio band input frequency (f_i) shall be centered in each 1/3 octave band maintaining the same drive level as determined in Step c), and the reading taken for that band. Equivalent methods of determining the frequency response may also be employed, such as fast Fourier transform (FFT) analysis using noise excitation or input-output comparison using simulated speech. The full-band integrated or half-band integrated probe output, as described in D.9, may be used, as long as the appropriate calibration curve is applied to the measured result, so as to yield an accurate measurement of the field magnitude. (The resulting measurement shall be an accurate measurement in dB (A/m).) Compare the frequency response found to the requirements of 6.6.3.
7. At the same locations measured in Step d), measure and record the undesired broadband audio magnetic signal (undesired ABM field) with no audio signal applied (or digital zero applied, if appropriate) using the specified spectral weighting, the half-band integrator followed by the temporal weighting.
8. Calculate and record the location and number of the measurement points that satisfy both the minimum desired ABM signal level and the maximum undesired ABM field level specified in 6.6.2. Compare this to the requirements in 6.6.4 and record the result.
9. Calculate and record the location and number of the measurement points that satisfy the maximum undesired ABM field level and distribution requirements specified in 6.6.4.



7. Test Equipment List

Manufacturer	Name of Equipment	Type/Model	Serial No. / SW Version	Calibration	
				Last Cal.	Due Date
SPEAG	DOSIMETRIC ASSESSMENT SYSTEM Software	cDASY6 HAC	V1.2	NCR	NCR
SPEAG	Audio Magnetic 1D Field Probe	AM1DV3	1048	2023.06.13	2024.06.12
SPEAG	Audio Magnetic Calibration Coil	AMCC	1044	NCR	NCR
SPEAG	Audio Measuring Instrument	AMMI	1032	NCR	NCR
SPEAG	Test Arch Phantom	N/A	N/A	NCR	NCR
SPEAG	Audio Holder	N/A	1094	NCR	NCR
SPEAG	Data Acquisition Electronics	DAE4	480	2023.09.19	2024.09.18
R&S	Base Station	CMU200	107082	2023.06.21	2024.06.20
R&S	Base Station	CMW500	165755	2024.01.25	2025.01.24



8. Summary Test Results

8.1. Test Guidance

1. The middle channel of each frequency band is used for T-Coil testing according to ANSI C63.19-2019.
2. For VoLTE radio configuration investigation is choose either one codec and an investigation was performed on all frequency band, data rates and modulations and RB configuration to determine the radio configuration to be used for testing, the following tests results which the worst case configuration would be remarked to be used for the testing for the handset.
3. According to KDB 285076, reporting results involves Air Interface Investigation defined following process:
 - 1) Ratio configuration Investigation: The worst radio configuration (e.g. bandwidth, modulation data rate, subcarrier spacings, and resource blocks) should be investigated and documented.
 - 2) Codec Investigation to determine the worst-case codec for each voice service, using the worst-case codec for a voice service, a range of channels and bands tested.
 - 3) Using a frequency near the center of the frequency band to test T-Coil per ANSI C63.19-2019 section 6.3.3.
4. For 5G VoWiFi, the worst frequency band of 802.11a would be selected to test other wireless modes.
5. This device was tested under the maximum volume, backlight off and mute on.
6. HAC mode would be active to improve the audio signal to comply with the T-Coil performance of ANSI C63.19-2019.
7. The device have similar frequency in LTE bands 4/66 since the supported frequency spans for the smaller LTE bands are completely cover by the larger LTE bands, therefore, only larger LTE bands were required to be tested for hearing-aid compliance.



8.2. Test Results

➤ GSM Test Results

<Codec Investigation>

Wireless Band & Channel	Orientation	Codec Bites (Kbps)	Primary Group Contiguous Point Count	Secondary Group Contiguous Point Count	Secondary Group Max Longitudinal	Secondary Group Max Transverse	Frequency Response
GSM850 /189	Transversal (Y)	AMR-NB 4.75	418	571	26	26	PASS
		AMR-NB 12.2	406	562	26	26	PASS

Note: The worst codec of AMR-NB 12.2Kbps was selected for air interface Investigation.

<Air Interface Investigation>

Air Interface	Mode	Channel	Primary Group Contiguous Point Count	Secondary Group Contiguous Point Count	Secondary Group Max Longitudinal	Secondary Group Max Transverse	Ambient Noise dB (A/m)	Frequency Response
GSM 850	GSM Voice	189	406	562	26	26	-52.34	PASS
GSM 1900	GSM Voice	661	214	394	19	26	-52.34	PASS

➤ UMTS Test Results

<Codec Investigation>

Wireless Band & Channel	Orientation	Codec Bites (Kbps)	Primary Group Contiguous Point Count	Secondary Group Contiguous Point Count	Secondary Group Max Longitudinal	Secondary Group Max Transverse	Frequency Response
WCDMA II / 9400	Transversal (Y)	AMR-NB 4.75	344	589	26	26	PASS
		AMR-NB 12.20	332	567	26	26	PASS
		AMR-WB 6.60	342	591	26	26	PASS
		AMR-WB 12.65	339	590	26	26	PASS

Note: The worst codec of AMR-NB 12.2Kbps was selected for air interface Investigation.



<Air Interface Investigation>

Air Interface	Mode	Channel	Primary Group Contiguous Point Count	Secondary Group Contiguous Point Count	Secondary Group Max Longitudinal	Secondary Group Max Transverse	Ambient Noise dB (A/m)	Frequency Response
WCDMA II	AMR	9400	332	567	26	26	-52.34	PASS
WCDMA IV	AMR	1413	461	642	26	26	-52.34	PASS
WCDMA V	AMR	4182	502	673	26	26	-52.34	PASS

➤ VoLTE Test Results

<Codec Investigation>

Wireless Band / Bandwidth / Channel	Orientation	Codec Bites (Kbps)	Primary Group Contiguous Point Count	Secondary Group Contiguous Point Count	Secondary Group Max Longitudinal	Secondary Group Max Transverse	Frequency Response
LTE Band 2 / 20MHz/ 18900	Transversal (Y)	AMR-NB 4.75	401	582	26	26	PASS
		AMR-NB 12.20	392	570	26	26	PASS
		AMR-WB 6.60	397	576	26	26	PASS
		AMR-WB 12.65	408	573	26	26	PASS
		EVS-WB 5.9	393	593	26	26	PASS
		EVS-WB 24.4	412	588	26	26	PASS
		EVS-NB 5.9	406	596	26	26	PASS
		EVS-NB 24.4	404	584	26	26	PASS

Note: The worst codec of AMR-NB 12.2Kbps was selected for air interface Investigation.

<Radio Configuration Investigation>

Air Interface	Bandwidth (MHz)	Modulation	RB Offset	Probe Position	Primary Group Contiguous Point Count	Frequency Response
LTE Band 2	20	QPSK	1#0	Transversal (Y)	392	PASS
LTE Band 2	20	QPSK	100#0	Transversal (Y)	412	PASS
LTE Band 2	20	16QAM	1#0	Transversal (Y)	411	PASS
LTE Band 2	20	64QAM	1#0	Transversal (Y)	407	PASS
LTE Band 2	15	QPSK	1#0	Transversal (Y)	412	PASS
LTE Band 2	10	QPSK	1#0	Transversal (Y)	409	PASS
LTE Band 2	5	QPSK	1#0	Transversal (Y)	406	PASS



LTE Band 2	1.4	QPSK	1#0	Transversal (Y)	407	PASS
------------	-----	------	-----	-----------------	-----	------

Note: The worst radio configuration highlight about would be selected for other air interface measurement.

<Air Interface Investigation>

Air Interface	Mode	Channel	Primary Group Contiguous Point Count	Secondary Group Contiguous Point Count	Secondary Group Max Longitudinal	Secondary Group Max Transverse	Ambient Noise dB (A/m)	Frequency Response
LTE Band 2	QPSK/1#0	18900	392	570	26	26	-52.34	PASS
LTE Band 5	QPSK/1#0	20525	472	621	26	26	-52.34	PASS
LTE Band 7	QPSK/1#0	21100	310	546	26	26	-52.34	PASS
LTE Band 12	QPSK/1#0	23095	450	602	26	26	-52.34	PASS
LTE Band 13	QPSK/1#0	23230	439	599	26	26	-52.34	PASS
LTE Band 48	QPSK/1#0	55990	418	643	26	26	-52.34	PASS
LTE Band 66/4	QPSK/1#0	132322	392	540	26	26	-52.34	PASS

➤ VoWiFi Test Results

<Codec Investigation>

Wireless Band / Channel	Orientation	Codec Bites (Kbps)	Primary Group Contiguous Point Count	Secondary Group Contiguous Point Count	Secondary Group Max Longitudinal	Secondary Group Max Transverse	Frequency Response
WLAN 2.4GHz 6	Transversal (Y)	AMR-NB 4.75	425	607	26	26	PASS
		AMR-NB 12.20	402	595	26	26	PASS
		AMR-WB 6.60	428	616	26	26	PASS
		AMR-WB 12.65	407	601	26	26	PASS
		EVS-WB 5.9	404	614	26	26	PASS
		EVS-WB 24.4	409	604	26	26	PASS
		EVS-NB 5.9	421	628	26	26	PASS
		EVS-NB 24.4	411	600	26	26	PASS

Note: The worst codec of AMR-NB 12.2Kbps was selected for air interface Investigation.



<Radio Configuration Investigation>

Wireless Band	Air Interface	Data Rate	Channel	Probe Position	Primary Group Contiguous Point Count	Frequency Response
WLAN 2.4GHz	802.11b	1Mbps	6	Transversal (Y)	402	PASS
	802.11g	6Mbps	6	Transversal (Y)	395	PASS
	802.11n-HT20	MCS0	6	Transversal (Y)	395	PASS
	802.11n-HT40	MCS0	6	Transversal (Y)	399	PASS
WLAN 5.2GHz	802.11a	6Mbps	44	Transversal (Y)	408	PASS
WLAN 5.8GHz	802.11a	6Mbps	157	Transversal (Y)	335	PASS

Note: The worst radio configuration highlight about would be selected for other air interface measurement.

<Air Interface Investigation>

Wireless Band	Air Interface	Channel	Primary Group Contiguous Point Count	Secondary Group Contiguous Point Count	Secondary Group Max Longitudinal	Secondary Group Max Transverse	Ambient Noise dB (A/m)	Frequency Response
WLAN 2.4GHz	802.11b	6	402	595	26	26	-52.34	PASS
	802.11g	6	395	588	26	26	-52.34	PASS
	802.11n20	6	395	583	26	26	-52.34	PASS
	802.11n40	6	399	590	26	26	-52.34	PASS
WLAN 5.2GHz	802.11a	44	408	587	26	26	-52.34	PASS
WLAN 5.8GHz	802.11a	157	335	532	26	26	-52.34	PASS
	802.11n-20	157	337	567	26	26	-52.34	PASS
	802.11n40	159	364	591	26	26	-52.34	PASS
	802.11ac20	157	417	643	26	26	-52.34	PASS
	802.11ac40	159	441	668	26	26	-52.34	PASS
	802.11ac80	155	442	672	26	26	-52.34	PASS



9. Uncertainty Assessment

Uncertainty of Audio Band Magnetic Measurements							
Error Description	Uncertainty Value (±%)	Probe Distance	Div.	(Ci) ABMd	(Ci) ABMu	Standard Uncertainty (ABMd) (±%)	Standard Uncertainty (ABMu) (±%)
Probe Sensitivity							
Reference level	3.0	N	1	1	1	3.0	3.0
AMCC geometry	0.4	R	1.732	1	1	0.2	0.2
AMCC current	1.0	R	1.732	0.7	0.7	0.6	0.6
Probe positioning during calibrate	0.1	R	1.732	1	1	0.1	0.1
Noise contribution	0.7	R	1.732	0.0143	1	0.0	0.4
Frequency slope	5.9	R	1.732	0.1	1	0.3	3.5
Probe System							
Repeatability/drift	1.0	R	1.732	1	1	0.6	0.6
Linearity/dynamic range	0.6	R	1.732	1	1	0.4	0.4
Acoustic noise	1.0	R	1.732	0.1	1	0.1	0.6
Probe angle	1.0	R	1.732	1	1	0.6	0.6
Spectral processing	0.9	R	1.732	1	1	0.5	0.5
Integration time	0.6	N	1	1	5	0.6	3.0
Field disturbance	0.2	R	1.732	1	1	0.1	0.1
Test Signal							
Reference signal spectral response	0.6	R	1.732	0	1	0.0	0.4
Positioning							
Probe positioning	1.9	R	1.732	1	1	1.1	1.1
Phantom thickness	0.9	R	1.732	1	1	0.5	0.5
EUT positioning	1.9	N	1.732	1	1	1.1	1.1
External contributions							
RF interference	0.0	R	1.732	1	0.3	0.0	0.0
Test signal variation	2.0	R	1.732	1	1	1.2	1.2
Combined Std. Uncertainty							
Combined Std. Uncertainty (ABM Field)						3.9	6.0
Expanded STD Uncertainty							
						7.8	11.0



Annex A General Information

1. Identification of the Responsible Testing Laboratory

Laboratory Name:	Shenzhen Morlab Communications Technology Co., Ltd.
Laboratory Address:	FL.1-3, Building A, FeiYang Science Park, No.8 LongChang Road, Block 67, BaoAn District, ShenZhen, GuangDong Province, P. R. China
Telephone:	+86 755 36698555
Facsimile:	+86 755 36698525

2. Identification of the Responsible Testing Location

Name:	Shenzhen Morlab Communications Technology Co., Ltd.
Address:	FL.1-3, Building A, FeiYang Science Park, No.8 LongChang Road, Block 67, BaoAn District, ShenZhen, GuangDong Province, P. R. China



REPORT No.: SZ23080316S04

Annex B Test Setup Photos

The annex B will be submitted separately.

Annex C Plots of T-Coil Test Results

The annex C will be submitted separately.

Annex D DASY Calibration Certificate

The annex D will be submitted separately.

***** END OF MAIN REPORT *****