



TEST REPORT

No. I21Z60526-EMC01

for

Reliance Communications LLC

Orbic Myra

Model Name: R678L5

FCC ID: 2ABGH-R678L5

with

Hardware Version: V2.2

Software Version: ORB678L5_v1.0.42_BVZ

Issued Date: 2021-05-29

Note:

The test results in this test report relate only to the devices specified in this report. This report shall not be reproduced except in full without the written approval of CTTL.

The report must not be used by the client to claim product certification, approval, or endorsement by NVLAP, NIST, or any agency of the U.S. Government.

Test Laboratory:

CTTL, Telecommunication Technology Labs, CAICT

No. 52, Huayuan North Road, Haidian District, Beijing, P. R. China 100191.

Tel: +86(0)10-62304633-2512, Fax: +86(0)10-62304633-2504

Email: ctl_terminals@caict.ac.cn, website: www.caict.ac.cn



REPORT HISTORY

Report Number	Revision	Description	Issue Date
I21Z60526-EMC01	Rev.0	1 st edition	2021-05-29

Note: the latest revision of the test report supersedes all previous version.



CONTENTS

1. TEST LABORATORY	4
1.1. INTRODUCTION & ACCREDITATION	4
1.2. TESTING LOCATION	4
1.3. TESTING ENVIRONMENT	5
1.4. PROJECT DATA	5
1.5. SIGNATURE.....	5
2. CLIENT INFORMATION	6
2.1. APPLICANT INFORMATION.....	6
2.2. MANUFACTURER INFORMATION.....	6
3. EQUIPMENT UNDER TEST (EUT) AND ANCILLARY EQUIPMENT (AE)	7
3.1. ABOUT EUT.....	7
3.2. INTERNAL IDENTIFICATION OF EUT USED DURING THE TEST	7
3.3. INTERNAL IDENTIFICATION OF AE USED DURING THE TEST.....	7
4. REFERENCE DOCUMENTS.....	8
4.1. DOCUMENTS SUPPLIED BY APPLICANT.....	8
4.2. REFERENCE DOCUMENTS FOR TESTING.....	8
5. LABORATORY ENVIRONMENT.....	9
6. SUMMARY OF TEST RESULT	10
7. MEASUREMENT UNCERTAINTY	11
8. TEST EQUIPMENT UTILIZED	12
ANNEX A: MEASUREMENT RESULTS	14
A.1 RADIATED OUTPUT POWER.....	14
A.2 EMISSION LIMIT	25
A.3 FREQUENCY STABILITY	43
A.4 OCCUPIED BANDWIDTH.....	45
A.5 BAND EDGE COMPLIANCE	75
ANNEX B: CALIBRATION CERTIFICATES LIST	140



1. Test Laboratory

1.1. Introduction & Accreditation

Telecommunication Technology Labs, CAICT is an ISO/IEC 17025:2017 accredited test laboratory under NATIONAL VOLUNTARY LABORATORY ACCREDITATION PROGRAM (NVLAP) with lab code 600118-0 and is also an FCC accredited test laboratory (CN5017), and ISED accredited test laboratory (CN0066). The detail accreditation scope can be found on NVLAP website.

1.2. Testing Location

Location 1: CTTL (huayuan North Road)

Address: No. 52, Huayuan North Road, Haidian District, Beijing,
P. R. China 100191

1.3. Testing Environment

Normal Temperature: 15-35°C
Relative Humidity: 20-75%

1.4. Project Data

Testing Start Date: 2021-03-29
Testing End Date: 2021-05-07

1.5. Signature

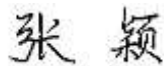

Zhang Ying
(Prepared this test report)



An Hui
(Reviewed this test report)



Zhang Xia
(Approved this test report)



2. Client Information

2.1. Applicant Information

Company Name: Reliance Communications LLC
Address /Post: 91 Colin Drive, Unit 1, HOLBROOK, New York 11741, United States
Contact: Saqib Ghouri
Email: Saqib.Ghouri@reliance.us
Telephone: +1 631-240-8400
Fax: /

2.2. Manufacturer Information

Company Name: ZJY RIGHT SOURCE INDIA PRIVATE LIMITED
Address /Post: MIDC industrial Area, Shiravane, Nerul,India
Contact: Winter
Email: Pmware@zjynet.com
Telephone: 186 8920 9065
Fax: /

3. Equipment Under Test (EUT) and Ancillary Equipment (AE)

3.1. About EUT

Description	Orbic Myra
Model Name	R678L5
FCC ID	2ABGH-R678L5
Antenna	Embedded
Output power	27.55dBm maximum EIRP measured for n260
Extreme vol. Limits	4.40VDC to 3.00VDC (nominal: 3.85VDC)
Extreme temp. Tolerance	-10°C to +50°C

Note: Components list, please refer to documents of the manufacturer; it is also included in the original test record of CTTL.

3.2. Internal Identification of EUT used during the test

EUT ID*	IMEI	HW Version	SW Version
UT01a	357758890004155	V2.2	ORB678L5_v1.0.42_BVZ

*EUT ID: is used to identify the test sample in the lab internally.

3.3. Internal Identification of AE used during the test

AE ID*	Description
AE1	Battery
AE1	
Model	BLE-5001
Manufacturer	HUIZHOU DXDRAGON INC
Capacitance	5000mAh
Rated Voltage	3.85V

*AE ID: is used to identify the test sample in the lab internally.



4. Reference Documents

4.1. Documents supplied by applicant

EUT parameters, referring to Annex A for detailed information, is supplied by the client or manufacturer, which is the basis of testing.

4.2. Reference Documents for testing

The following documents listed in this section are referred for testing.

Reference	Title	Version
FCC Part 30	UPPER MICROWAVE FLEXIBLE USE SERVICE	10-1-20 Edition
ANSI C63.26	American National Standard for Compliance Testing of Transmitters Used in Licensed Radio Services	2015
KDB 842590	Upper Microwave Flexible Use Service v01r01	April 3, 2020

5. Laboratory Environment

Semi/Full-anechoic chamber SAC-1 (23 meters × 17meters × 10meters) did not exceed following limits along the EMC testing:

Temperature	Min. = 15 °C, Max. = 35 °C
Relative humidity	Min. = 15 %, Max. = 75 %
Shielding effectiveness	0.014MHz - 1MHz, >60dB; 1MHz - 1000MHz, >90dB.
Electrical insulation	> 2 M
Ground system resistance	< 4
Normalised site attenuation (NSA)	< ± 4 dB, 3m/10m distance, from 30 to 1000 MHz
Site voltage standing-wave ratio (S_{VSWR})	Between 0 and 6 dB, from 1GHz to 18GHz

6. Summary Of Test Result

n260

Items	Test Name	Clause in FCC rules	Verdict
1	Output Power	2.1046, 30.202	Pass
2	Unwanted Emission	30.203	Pass
3	Frequency Stability	2.1055	Pass
4	Occupied Bandwidth	2.1049	Pass
5	Band Edge Compliance	2.1051, 30.203	Pass

n261

Items	Test Name	Clause in FCC rules	Verdict
1	Output Power	2.1046, 30.202	Pass
2	Unwanted Emission	30.203	Pass
3	Frequency Stability	2.1055	Pass
4	Occupied Bandwidth	2.1049	Pass
5	Band Edge Compliance	2.1051, 30.203	Pass

Terms used in Verdict column

P	Pass. The EUT complies with the essential requirements in the standard.
NP	Not Performed. The test was not performed by CTTL.
NA	Not Applicable. The test was not applicable.
BR	Re-use test data from basic model report.
F	Fail. The EUT does not comply with the essential requirements in the standard.

Explanation of worst-case configuration

The worst-case scenario for all measurements is based on the output power measurement investigation results. Output power was measured on QPSK, 16QAM and 64QAM modulations. If it was found that QPSK was the worst case. All testing was performed using QPSK modulations to represent the worst case unless otherwise stated. The test results shown in the following sections represent the worst case emission.

7. Measurement Uncertainty

Measurement Uncertainty:

Frequency Range	Uncertainty(dB) (k=2)
30MHz-1GHz	5.18
1GHz-18GHz	5.54
18GHz-40GHz	5.26
40GHz-60GHz	3.80
60GHz-75GHz	3.76
75GHz-110GHz	3.80

8. Test Equipment Utilized

NO.	NAME	TYPE	SERIES NUMBER	PRODUCER	CAL. DUE DATE	CAL. INTERVAL
1	Signal Generator	SMF100A	104940	R&S	2021-12-09	1 year
2	Signal Generator	E8257D (60GHz)	MY59140557	Keysight	2022-01-19	1 year
3	Antenna	VULB 9163	483	SCHWARZB ECK	2021-08-27	1 year
4	Antenna	3115	6914	ETS-Lindgre n	2022-02-03	1 year
5	Upconverter(50GHz-75G Hz)	SMZ-75	101309	R&S	2022-01-14	1 year
6	Upconverter(75GHz-110 GHz)	SMZ-110	101357	R&S	2022-01-14	1 year
7	Upconverter(110GHz-17 0GHz)/	82406B	ZEI00141	Ceyear	2022-02-04	1 year
8	Upconverter(170GHz-22 0GHz)/	82406C	ZEI00164	Ceyear	2022-02-04	1 year
9	Spectrum Analyzer	FSW67	103290	R&S	2022-02-04	1 year
10	(downconverter)Harmoni c Mixer(60GHz-90GHz)	FS-Z90	101655	R&S	2022-02-04	1 year
11	(downconverter)Harmoni c Mixer(75GHz-110GHz)	FS-Z110	101463	R&S	2022-01-19	1 year
12	(downconverter)Harmoni c Mixer(110GHz-170GHz)/	FS-Z170	101008	R&S	2022-02-17	1 year
13	(downconverter)Harmoni c Mixer(170GHz-220GHz)/	FS-Z220	101054	R&S	2021-12-14	1 year
14	Standard Gain Horn (40GHz-60GHz)	LB-19-25	J202024086	A-INFO	2022-01-14	1 year
15	Standard Gain Horn (40GHz-60GHz)	LB-19-25	J202024087	A-INFO	2022-01-14	1 year
16	Standard Gain Horn (60GHz-90GHz)	LB-12-25	J202062912	A-INFO	2022-02-17	1 year
17	Standard Gain Horn (50GHz-75GHz)	LB-15-25	J202062019	A-INFO	2021-12-14	1 year
18	Standard Gain Horn (75GHz-110GHz)	LB-10-25	J202023231	A-INFO	2022-01-27	1 year
19	Standard Gain Horn (75GHz-110GHz)	LB-10-25	J202023232	A-INFO	2022-01-27	1 year



I21Z60526-EMC01

24	DC power supply	PAS20-18	UH000695	Kikusui	2021-08-01	1 year
25	Incubator	SH-641	92009470	ESPEC	2022-02-14	1 year
26	Receiver	ESP40	100012	R&S	2022-01-03	1 year

Annex A: Measurement Results

A.1 Radiated Output Power

A.1.1 Summary

During the process of testing, the EUT was controlled via communication tester to ensure max power transmission and proper modulation.

In all cases, output power is within the specified limits.

30.202 (b) For mobile stations, the average power of the sum of all antenna elements is limited to a maximum EIRP of +43 dBm.

A.1.2.1 Method of Measurements

ANSI C63.26 chapter 5.5.2.1: Such radiated measurements shall use substitution methods unless a test site validated to ANSI C63.4 requirements is utilized, in which case, radiated fundamental and/or unwanted emissions can be measured using the direct radiated field strength method.

The EUT was set up for the max output power with pseudo random data modulation.

These measurements were done at 3 frequencies (bottom, middle and top of operational frequency range) for each bandwidth.

An average power meter is used to perform RF output power measurements, the fundamental condition that measurements be performed only over durations of active transmissions at maximum output power level applies. Thus, an average power meter can always be used to perform the measurement when the EUT can be configured to transmit continuously.

The EIRP measurement used integration method and the bandwidth is 100MHz.

The procedure of radiated spurious emissions is as follows:

Using the test configuration as follow, measure the radiated emissions directly from the EUT and convert the measured field strength or received power to ERP or EIRP, as required, for comparison to the applicable limits.

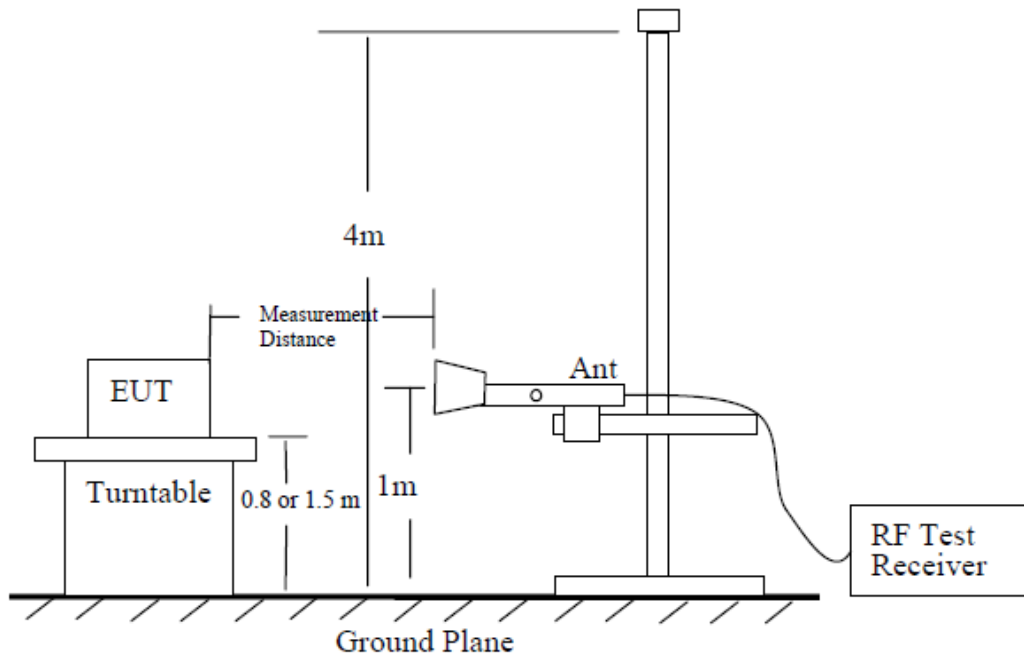
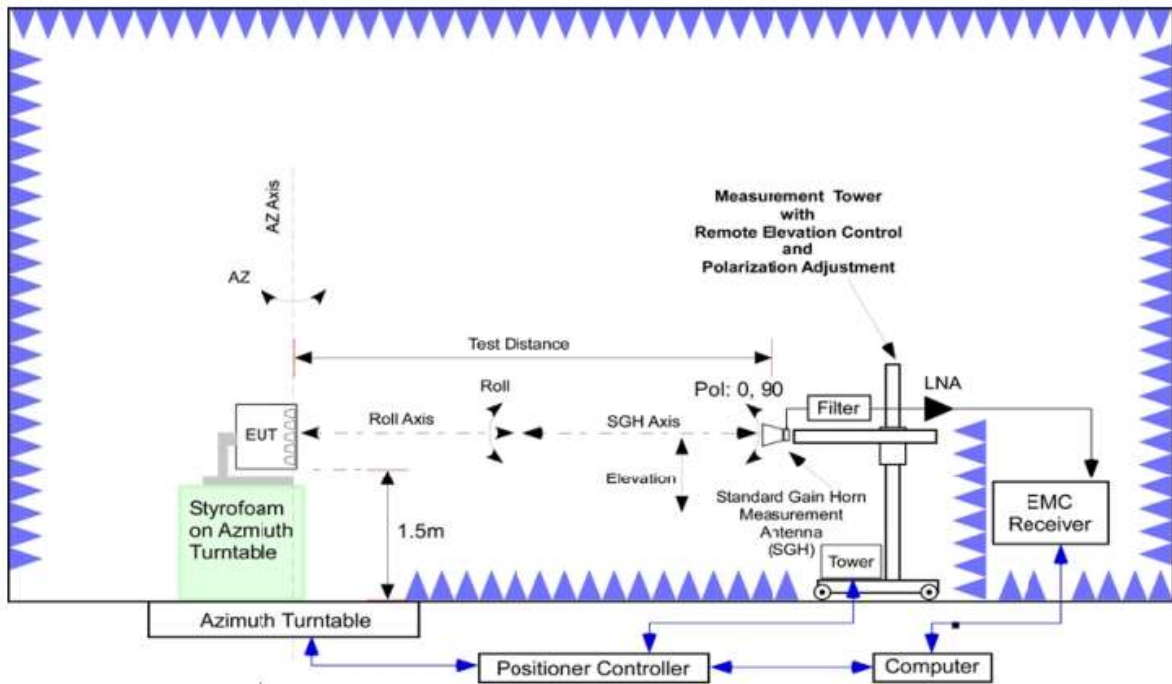

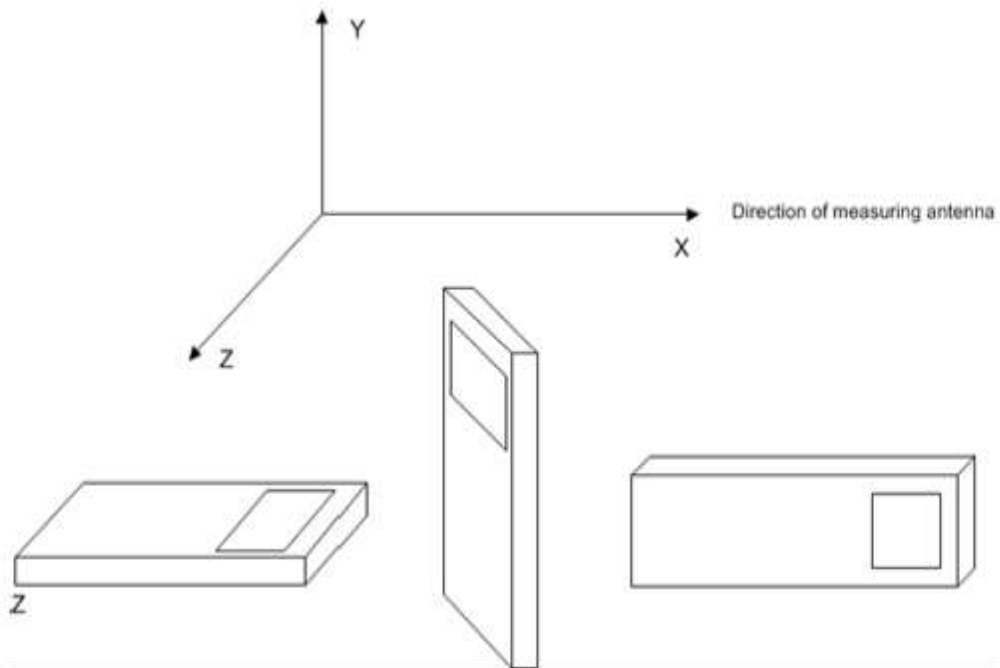

The emission characteristics of the EUT can be identified from the pre-scan measurement information.

Exploratory radiated measurements (pre-scans) may be performed to determine the general EUT radiated emissions characteristics and, when necessary, the EUT-to-measurement antenna orientation that produces the maximum emission amplitude. Pre-scans shall only be used to determine the emission frequencies (i.e., not amplitude levels). The information garnered from a pre-scan can then be used to perform final compliance measurements using either the substitution or direct field strength method.

For radiated emissions measurements performed at frequencies less than or equal to 1 GHz, the EUT shall be placed on a RF-transparent table or support at a nominal height of 80 cm above the reference ground plane. Radiated measurements shall be made with the measurement antenna positioned in both horizontal and vertical polarization. The measurement antenna shall be varied from 1 m to 4 m in height above the reference ground in a search for the relative positioning that produces the maximum radiated signal level (i.e., field strength or received power). When orienting the measurement antenna in vertical polarization, the minimum height of the lowest element of the antenna shall clear the site reference ground plane by at least 25 cm.

For radiated measurements performed at frequencies above 1 GHz, the EUT shall be placed on an RF transparent table or support at a nominal height of 1.5 m above the ground plane. When maximizing the emissions from the EUT for measurement, the EUT and its transmitting antenna(s) shall be rotated through 360°. For each mode of operation to be tested, the frequency spectrum (based on findings from exploratory measurements) shall be monitored.

Test Note:

The average EIRP reported below is calculated by:

$$\text{EIRP(dBm)} = \text{Spectrum Analyzer Channel Power Level(dBm)} - \text{Antenna Factor(dBi)} + \text{Cable Loss(dB)} + 20\log(F) + 20\log(D) - 27.56$$

Where:

F: frequency (MHz)

D: Distance(m) = 3m

A.1.2.2 Measurement Result

Note:

We choose the worst modulation by the EIRP of middle channel, the high channel and low channel measure the EIRP only with the worst modulation.

n260, Module0, Beam ID:33, SCS=120kHz, CP-OFDM					
Bandwidth	RB size/offset	Frequency (MHz)	Power (dBm)		
			QPSK	16QAM	64QAM
50MHz	100% RB	37025.04	16.13	/	/
		38499.96	14.59	14.51	14.32
		39975	15.27	/	/
	1RB	37025.04	/	/	13.76
		38499.96	14.16	14.08	14.69
		39975	/	/	12.95
100MHz	100% RB	37050	/	15.28	/
		38499.96	13.58	14.65	14.17
		39949.92	/	13.83	/
	1RB	37050	13.81	/	/
		38499.96	15.89	13.90	14.36
		39949.92	12.61	/	/

Note:

We choose the worst modulation by the EIRP of middle channel, the high channel and low channel measure the EIRP only with the worst modulation.

n260, Module0, Beam ID:33, SCS=120kHz,PUSCH DFT					
Bandwidth	RB size/offset	Frequency (MHz)	Power (dBm)		
			QPSK	16QAM	64QAM
50MHz	100% RB	37025.04	/	/	15.31
		38499.96	16.33	15.57	16.91
		39975	/	/	15.22
	1RB	37025.04	/	/	14.81
		38499.96	13.92	14.25	15.86
		39975	/	/	18.76
100MHz	100% RB	37050	/	/	15.55
		38499.96	20.02	18.72	20.44
		39949.92	/	/	24.03
	1RB	37050	/	15.81	/
		38499.96	19.99	20.85	18.86
		39949.92	/	14.15	/

Note: The worst modulation is 64QAM, and we test follow setups used 64QAM.

n260, Module1, Beam ID:29, SCS=120kHz,PUSCH DFT					
Bandwidth	RB size/offset	Frequency (MHz)	Power (dBm)		
			QPSK	16QAM	64QAM
100MHz	100% RB	37050	/	/	19.46
		38499.96	/	/	20.27
		39949.92	/	/	20.86

n260, Module2, Beam ID:39, SCS=120kHz,PUSCH DFT					
Bandwidth	RB size/offset	Frequency (MHz)	Power (dBm)		
			QPSK	16QAM	64QAM
100MHz	100% RB	37050	/	/	21.50
		38499.96	/	/	21.45
		39949.92	/	/	18.88

Note:

We choose the worst modulation by the EIRP of middle channel, the high channel and low channel measure the EIRP only with the worst modulation.

n260, Module0, Beam ID:161, SCS=120kHz,CP-OFDM					
Bandwidth	RB size/offset	Frequency (MHz)	Power (dBm)		
			QPSK	16QAM	64QAM
50MHz	100% RB	37025.04	11.53	/	/
		38499.96	13.90	13.64	12.36
		39975	15.59	/	/
	1RB	37025.04	14.15	/	/
		38499.96	18.95	18.15	17.45
		39975	22.14	/	/
100MHz	100% RB	37050	/	/	20.56
		38499.96	11.58	13.74	13.83
		39949.92	/	/	20.38
	1RB	37050	/	/	13.72
		38499.96	11.82	13.47	13.85
		39949.92	/	/	20.81

Note:

We choose the worst modulation by the EIRP of middle channel, the high channel and low channel measure the EIRP only with the worst modulation.

n260, Module0, Beam ID:161, SCS=120kHz,PUSCH DFT					
Bandwidth	RB size/offset	Frequency (MHz)	Power (dBm)		
			QPSK	16QAM	64QAM
50MHz	100% RB	37025.04	/	17.40	/
		38499.96	24.03	24.23	23.92
		39975	/	23.65	/
	1RB	37025.04	22.39	/	/
		38499.96	23.89	23.63	23.88
		39975	27.55	/	/
100MHz	100% RB	37050	18.41	/	/
		38499.96	24.92	24.61	24.05
		39949.92	23.97	/	/
	1RB	37050	/	/	18.08
		38499.96	24.05	23.90	24.40
		39949.92	/	/	22.11

Note: The worst modulation is QPSK, and we test follow setups used QPSK.



n260, Module1, Beam ID:157, SCS=120kHz,PUSCH DFT					
Bandwidth	RB size/offset	Frequency (MHz)	Power (dBm)		
			QPSK	16QAM	64QAM
50MHz	1RB	37025.04	18.99	/	/
		38499.96	20.65	/	/
		39975	21.74	/	/

n260, Module2, Beam ID:167, SCS=120kHz,PUSCH DFT					
Bandwidth	RB size/offset	Frequency (MHz)	Power (dBm)		
			QPSK	16QAM	64QAM
50MHz	1RB	37025.04	23.10	/	/
		38499.96	23.68	/	/
		39975	25.52	/	/

Note:

We choose the worst modulation by the EIRP of middle channel, the high channel and low channel measure the EIRP only with the worst modulation.

n261, Module0, Beam ID:47, SCS=120kHz,CP-OFDM					
Bandwidth	RB size/offset	Frequency (MHz)	Power (dBm)		
			QPSK	16QAM	64QAM
50MHz	100% RB	27525	/	11.13	/
		27924.96	9.98	10.97	8.35
		28324.92	/	6.37	/
	1RB	27525	/	/	9.52
		27924.96	8.52	8.46	8.76
		28324.92	/	/	6.76
100MHz	100% RB	27550.08	/	/	8.03
		27924.96	8.40	6.62	8.45
		28299.96	/	/	4.70
	1RB	27550.08	/	/	6.86
		27924.96	5.59	5.92	7.53
		28299.96	/	/	2.76

Note:

We choose the worst modulation by the EIRP of middle channel, the high channel and low channel measure the EIRP only with the worst modulation.

n261, Module0, Beam ID:47, SCS=120kHz,PUSCH DFT					
Bandwidth	RB size/offset	Frequency (MHz)	Power (dBm)		
			QPSK	16QAM	64QAM
50MHz	100% RB	27525	/	11.82	/
		27924.96	10.47	10.79	9.98
		28324.92	/	7.18	/
	1RB	27525	/	11.86	/
		27924.96	9.90	11.04	9.64
		28324.92	/	7.24	/
100MHz	100% RB	27550.08	17.44	/	/
		27924.96	16.81	16.69	15.90
		28299.96	14.27	/	/
	1RB	27550.08	16.98	/	/
		27924.96	17.25	16.69	16.88
		28299.96	13.08	/	/

Note: The worst modulation is QPSK, and we test follow setups used QPSK.

n261, Module1, Beam ID:29, SCS=120kHz,PUSCH DFT					
Bandwidth	RB size/offset	Frequency (MHz)	Power (dBm)		
			QPSK	16QAM	64QAM
100MHz	100% RB	27550.08	13.01	/	/
		27924.96	14.27	/	/
		28299.96	9.94	/	/

n261, Module2, Beam ID:52, SCS=120kHz,PUSCH DFT					
Bandwidth	RB size/offset	Frequency (MHz)	Power (dBm)		
			QPSK	16QAM	64QAM
100MHz	100% RB	27550.08	16.25	/	/
		27924.96	12.26	/	/
		28299.96	11.87	/	/

Note:

We choose the worst modulation by the EIRP of middle channel, the high channel and low channel measure the EIRP only with the worst modulation.

n261, Module0, Beam ID:175, SCS=120kHz,CP-OFDM					
Bandwidth	RB size/offset	Frequency (MHz)	Power (dBm)		
			QPSK	16QAM	64QAM
50MHz	100% RB	27525	/	19.66	/
		27924.96	17.12	20.17	18.08
		28324.92	/	15.46	/
	1RB	27525	16.69	/	/
		27924.96	18.83	17.35	18.20
		28324.92	15.68	/	/
100MHz	100% RB	27550.08	/	/	15.25
		27924.96	14.76	14.74	14.93
		28299.96	/	/	13.44
	1RB	27550.08	14.74	/	/
		27924.96	15.73	14.63	14.45
		28299.96	9.44	/	/

Note:

We choose the worst modulation by the EIRP of middle channel, the high channel and low channel measure the EIRP only with the worst modulation.

n261, Module0, Beam ID:175, SCS=120kHz,PUSCH DFT					
Bandwidth	RB size/offset	Frequency (MHz)	Power (dBm)		
			QPSK	16QAM	64QAM
50MHz	100% RB	27525	/	21.41	/
		27924.96	19.49	20.64	19.91
		28324.92	/	17.53	/
	1RB	27525	/	20.10	/
		27924.96	19.69	19.85	19.64
		28324.92	/	15.67	/
100MHz	100% RB	27550.08	/	15.34	/
		27924.96	14.80	18.76	17.02
		28299.96	/	15.42	/
	1RB	27550.08	/	/	16.93
		27924.96	15.38	16.07	17.62
		28299.96	/	/	15.33

Note: The worst modulation is 16QAM, and we test follow setups used 16QAM.



n261, Module1, Beam ID:157, SCS=120kHz,PUSCH DFT					
Bandwidth	RB size/offset	Frequency (MHz)	Power (dBm)		
			QPSK	16QAM	64QAM
50MHz	100% RB	27525	/	4.15	/
		27924.96	/	5.32	/
		28324.92	/	1.26	/

n261, Module2, Beam ID:180, SCS=120kHz,PUSCH DFT					
Bandwidth	RB size/offset	Frequency (MHz)	Power (dBm)		
			QPSK	16QAM	64QAM
50MHz	100% RB	27525	/	15.12	/
		27924.96	/	15.00	/
		28324.92	/	9.67	/

A.2 Emission Limit

A.2.1 Measurement Method

The measurement procedures in ANSI C63.26 are used.

The spectrum was scanned from 30 MHz to the 10th harmonic of the highest frequency generated within the equipment. The resolution bandwidth is set as outlined in Part 30.203.

The spectrum is scanned with the mobile station transmitting at carrier frequencies that pertain to low, mid and high channels of FR2 n260 and FR2 n261.

ANSI C63.26 chapter 5.5.2.1: Such radiated measurements shall use substitution methods unless a test site validated to ANSI C63.4 requirements is utilized, in which case, radiated fundamental and/or unwanted emissions can be measured using the direct radiated field strength method.

The procedure of radiated spurious emissions is as follows:

Using the test configuration as follow, measure the radiated emissions directly from the EUT and convert the measured field strength or received power to ERP or EIRP, as required, for comparison to the applicable limits.

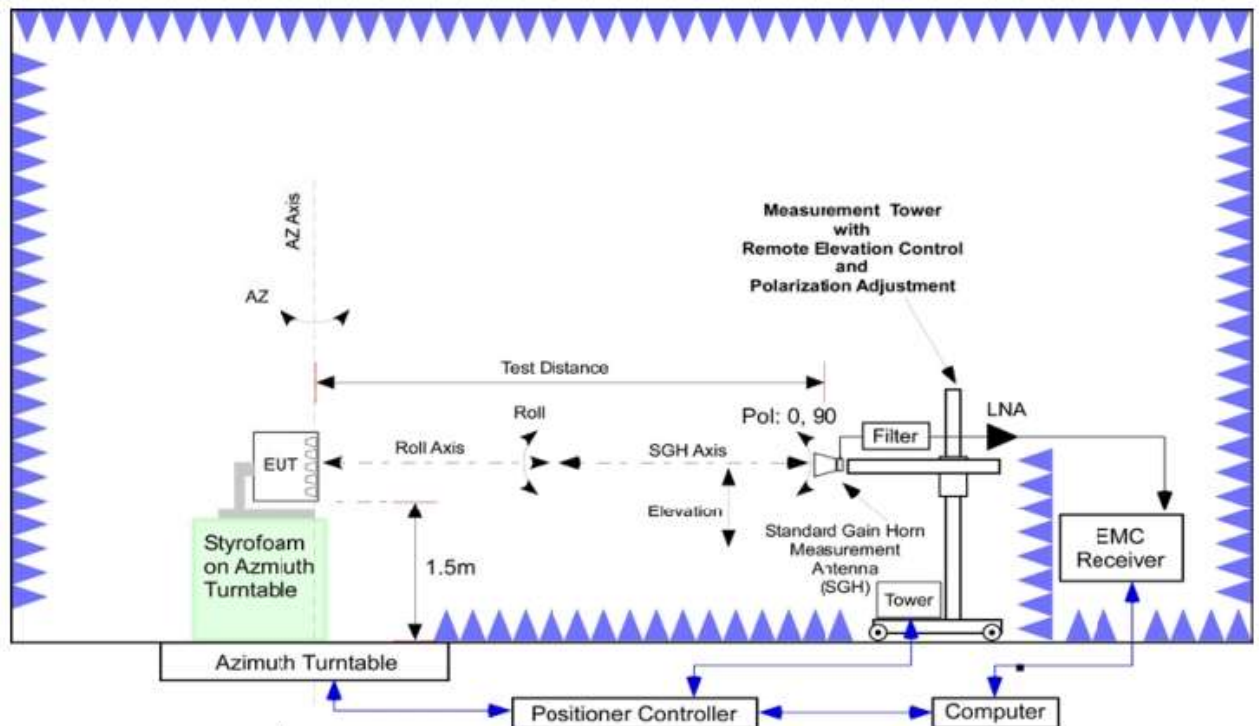

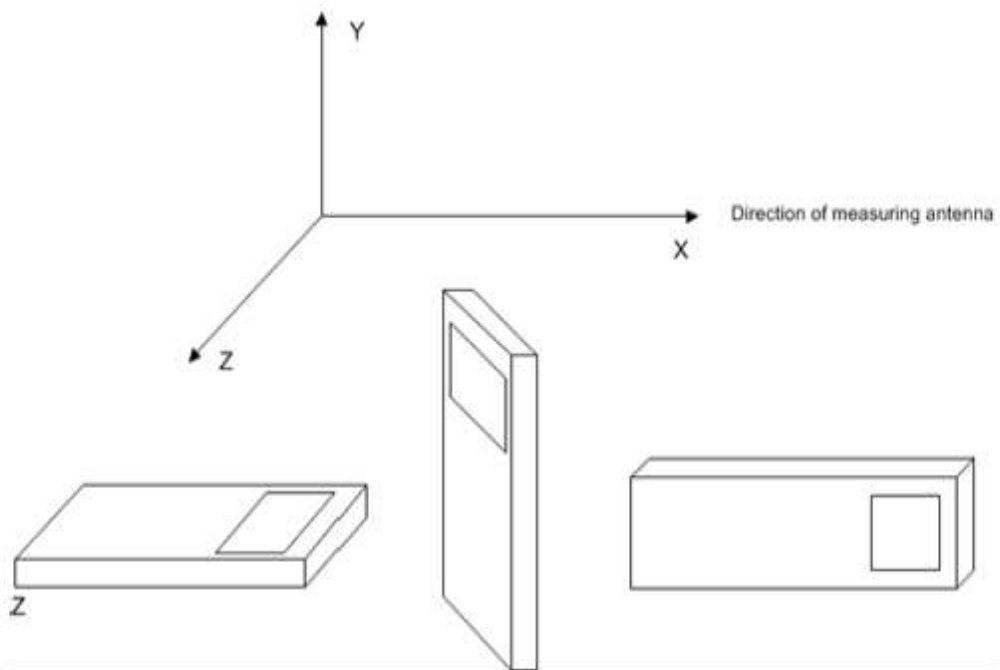
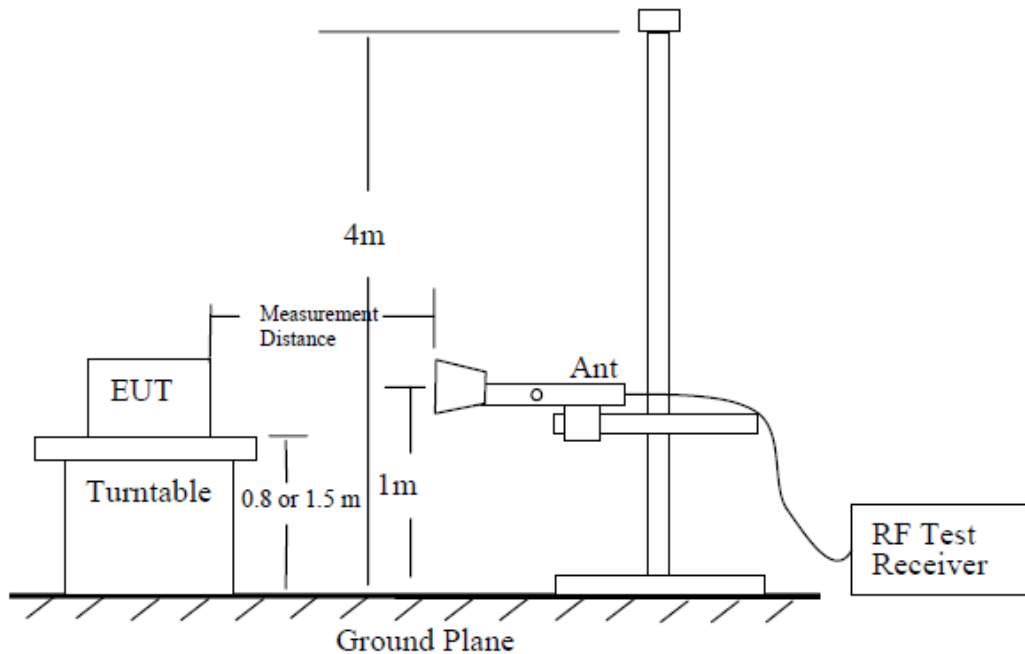

The emission characteristics of the EUT can be identified from the pre-scan measurement information.

Exploratory radiated measurements (pre-scans) may be performed to determine the general EUT radiated emissions characteristics and, when necessary, the EUT-to-measurement antenna orientation that produces the maximum emission amplitude. Pre-scans shall only be used to determine the emission frequencies (i.e., not amplitude levels). The information garnered from a pre-scan can then be used to perform final compliance measurements using either the substitution or direct field strength method.

For radiated emissions measurements performed at frequencies less than or equal to 1 GHz, the EUT shall be placed on a RF-transparent table or support at a nominal height of 80 cm above

the reference ground plane. Radiated measurements shall be made with the measurement antenna positioned in both horizontal and vertical polarization. The measurement antenna shall be varied from 1 m to 4 m in height above the reference ground in a search for the relative positioning that produces the maximum radiated signal level (i.e., field strength or received power). When orienting the measurement antenna in vertical polarization, the minimum height of the lowest element of the antenna shall clear the site reference ground plane by at least 25 cm.

The radiated emission measurements of all non-harmonic and harmonics of the transmit frequency through the 10th harmonic were measured with peak detector.

For radiated measurements performed at frequencies above 1 GHz, the EUT shall be placed on an RF transparent table or support at a nominal height of 1.5 m above the ground plane. When maximizing the emissions from the EUT for measurement, the EUT and its transmitting antenna(s) shall be rotated through 360°. For each mode of operation to be tested, the frequency spectrum (based on findings from exploratory measurements) shall be monitored.

Final measurements shall be performed for the worst case combination(s) of variable technical parameters that result in the maximum measured emission amplitude, record the frequency and amplitude of the highest fundamental emission (if applicable), and the frequency and amplitude data for the six highest-amplitude spurious emissions.

Test Setting:

Detector=RMS

Trace mode=trace average

Sweep time= auto couple

Number of sweep points $\geq 2 \times \text{span/RBW}$

The trace was allowed to stabilize

RBW=1MHz, VBW=3MHz

The average EIRP reported below is calculated by:

30M-1GHz:

$$\text{ERP(dBm)} = \text{Spectrum Analyzer Level(dBm)} + \text{Total loss(dB)} - 2.15$$

1GHz-18GHz:

$$\text{EIRP(dBm)} = \text{Spectrum Analyzer Level(dBm)} + \text{Total loss(dB)}$$

18GHz-60GHz:

$$\text{EIRP(dBm)} = \text{Spectrum Analyzer Level(dBm)} - \text{Antenna Factor(dBi)} + \text{Cable Loss(dB)} + 20\log(F) + 20\log(D) - 27.56$$

60GHz-110GHz:

$$\text{EIRP(dBm)} = \text{Spectrum Analyzer Level(dBm)} - \text{Antenna Factor(dBi)} + \text{converter Loss(dB)} + 20\log(F) + 20\log(D) - 27.56$$

Where:

F:frequency (MHz)

D:Distance(m)

Frequency Range	Distance(m)
30MHz-1GHz	3
1GHz-18GHz	3

18GHz-40GHz	3
40GHz-60GHz	3
60GHz-75GHz	3
75GHz-110GHz	3

A.2.2 Measurement Limit

Part 30.203 specify that the total radiated power of any emission outside a licensee's frequency block shall be -13 dBm/MHz or lower. However, in the bands immediately outside and adjacent to the licensee's frequency block, having a bandwidth equal to 10 percent of the channel bandwidth, the conductive power or the total radiated power of any emission shall be -5 dBm/MHz or lower.

A.2.3 Measurement Results

Radiated emissions measurements were made only at the upper, middle, and lower carrier frequencies of the FR2 n260 and n261. It was decided that measurements at these three carrier frequencies would be sufficient to demonstrate compliance with emissions limits because it was seen that all the significant spurs occur well outside the band and no radiation was seen from a carrier in one block of the FR2 n260 and n261 into any of the other blocks. The equipment must still, however, meet emissions requirements with the carrier at all frequencies over which it is capable of operating and it is the manufacturer's responsibility to verify this. The evaluated frequency range is from 30MHz to 100GHz for n261 and n260.

A.2.4 Measurement Results Table(worst case of all power)

Frequency	Antenna	Modulation	Bandwidth	Channel	Frequency Range	Result
n260	Module0 Beam ID:161	PUSCH DFT, QPSK	50MHz /1RB	Low	30MHz-110GHz	Pass
				Middle	30MHz-110GHz	Pass
				High	30MHz-110GHz	Pass
n261	Module0, Beam ID:175	PUSCH DFT, 16QAM	50MHz/ 100%RB	Low	30MHz-110GHz	Pass
				Middle	30MHz-110GHz	Pass
				High	30MHz-110GHz	Pass

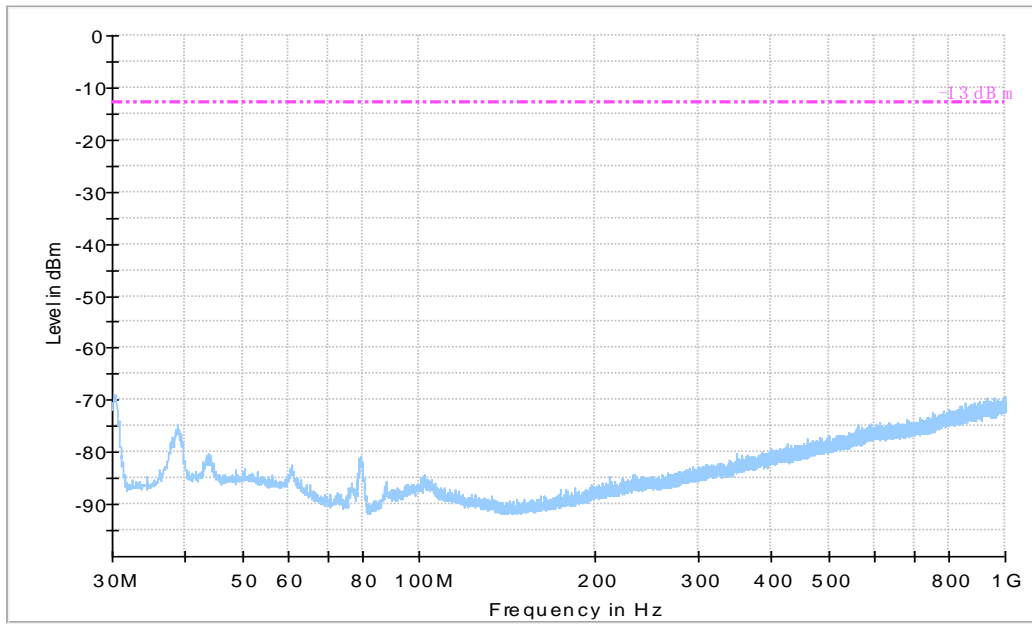

30MHz-1GHz

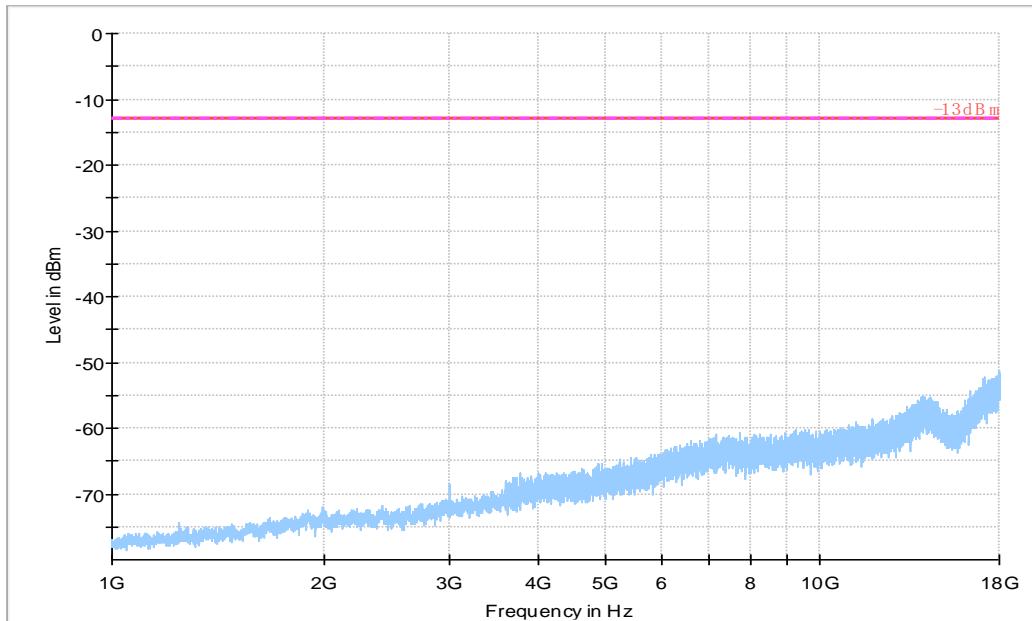

1GHz-18GHz

Full Spectrum

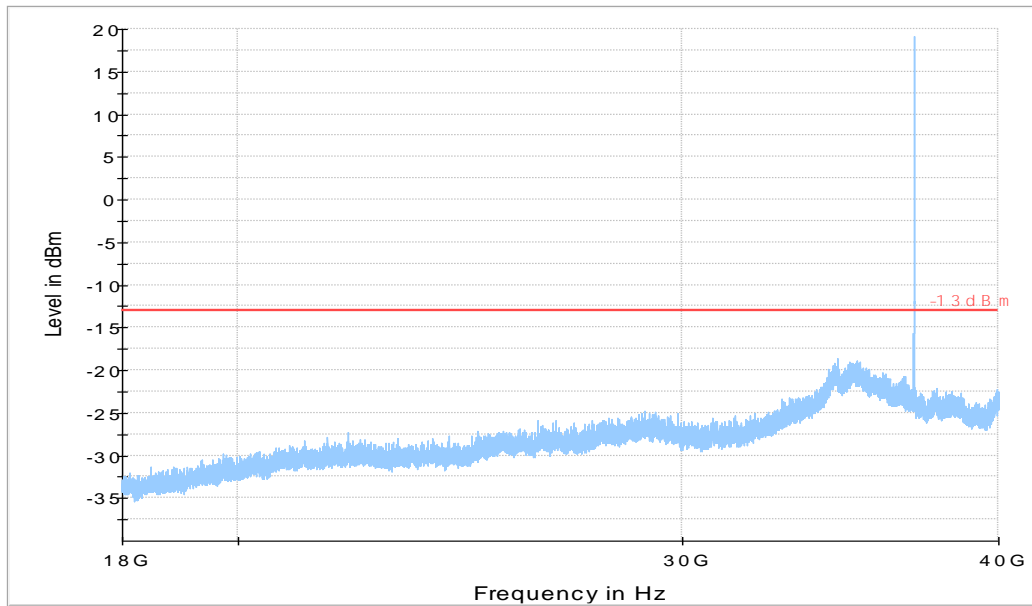

n260, Module0, Beam ID:161, 50MHz, PUSCH DFT, QPSK, 1RB, Low channel, 18GHz-40GHz

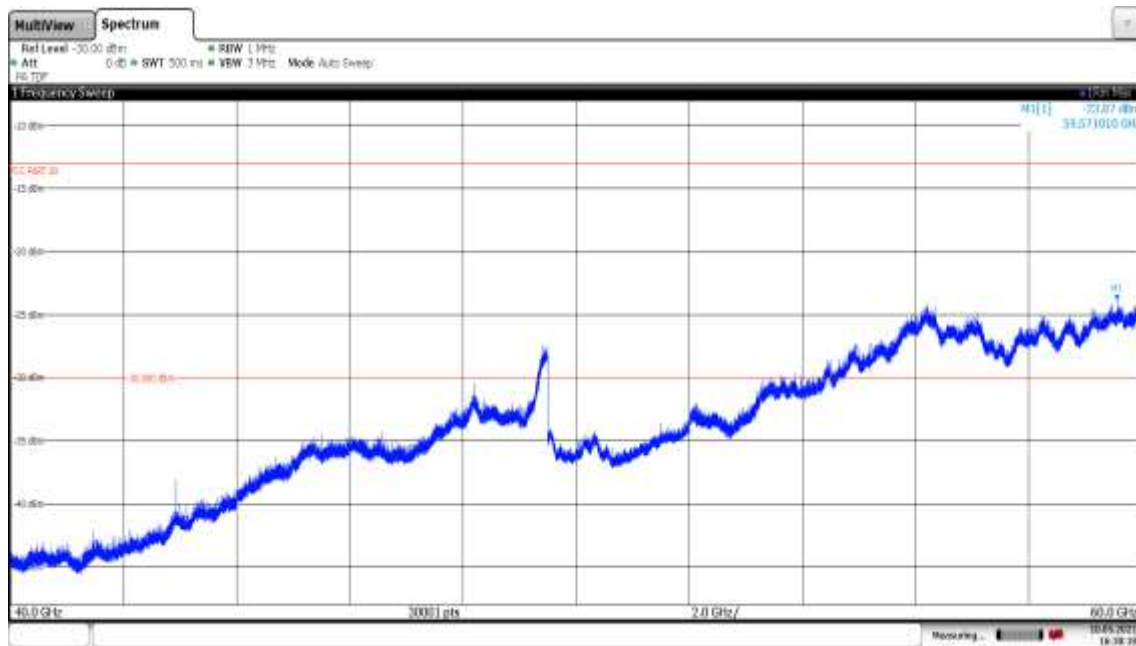

n260, Module0, Beam ID:161, 50MHz, PUSCH DFT, QPSK, 1RB, Low channel, 40GHz-60GHz

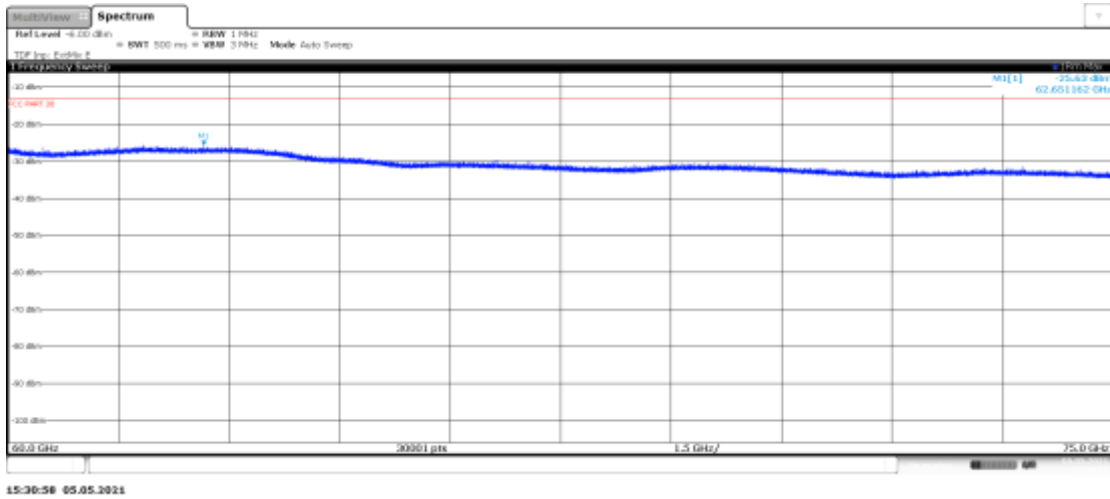

n260, Module0, Beam ID:161, 50MHz, PUSCH DFT, QPSK, 1RB, Low channel, 60GHz-75GHz

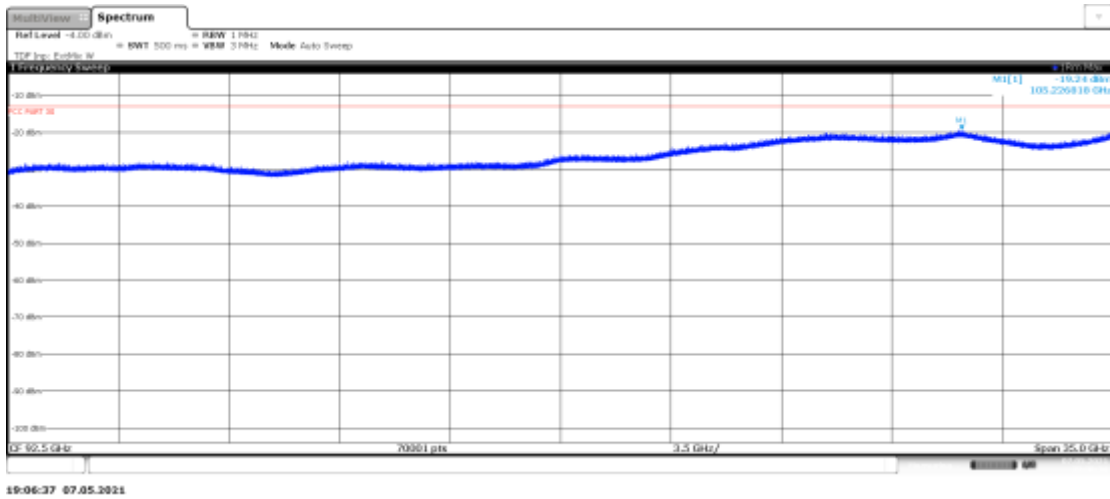

n260, Module0, Beam ID:161, 50MHz, PUSCH DFT, QPSK, 1RB, Low channel, 75GHz-110GHz

Full Spectrum

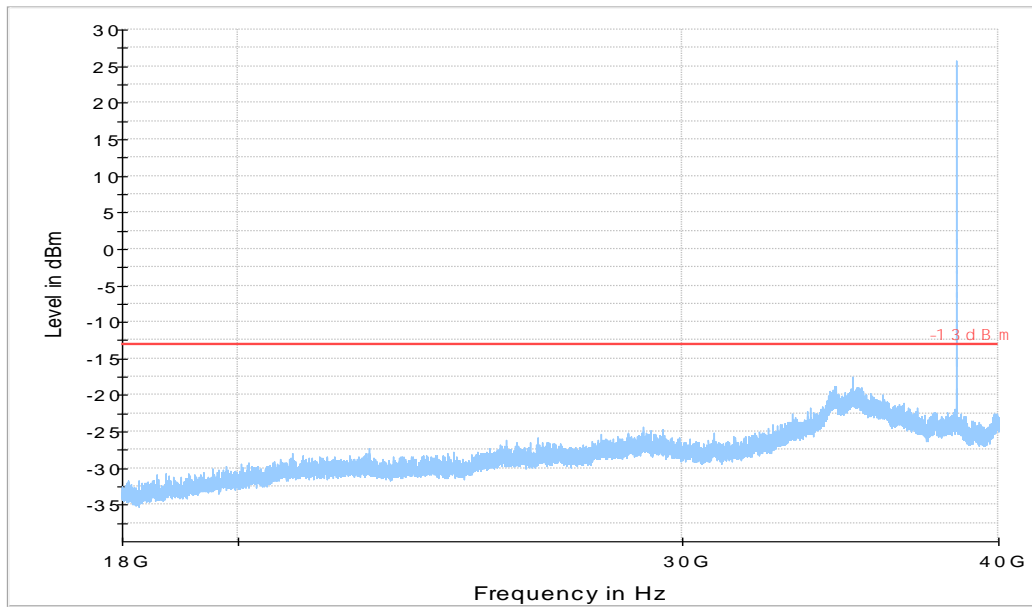

n260, Module0, Beam ID:161, 50MHz, PUSCH DFT, QPSK, 1RB, Mid channel, 18GHz-40GHz

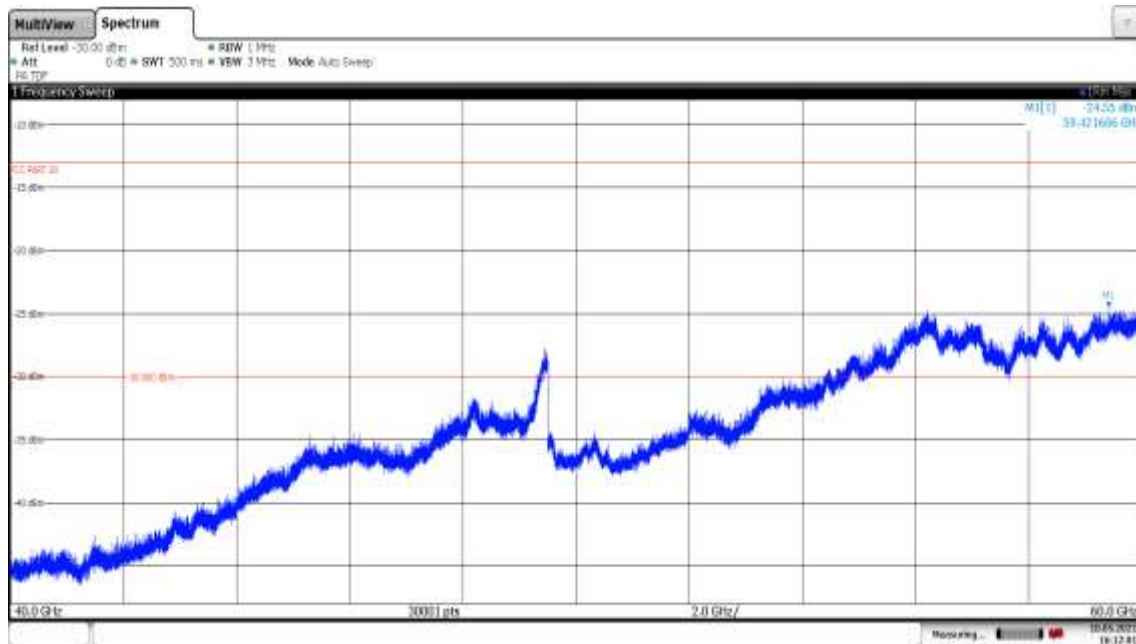

n260, Module0, Beam ID:161, 50MHz, PUSCH DFT, QPSK, 1RB, Mid channel, 40GHz-60GHz

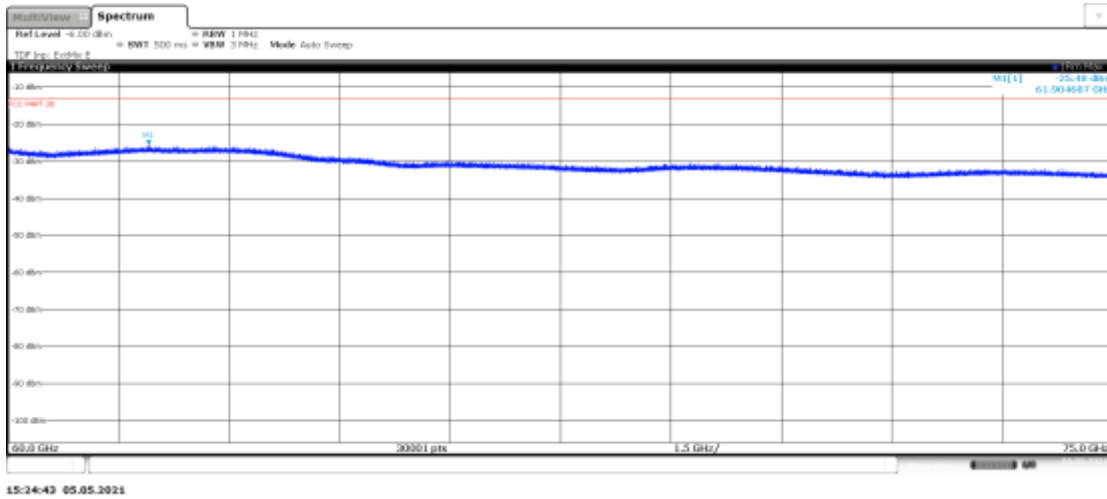

n260, Module0, Beam ID:161, 50MHz, PUSCH DFT, QPSK, 1RB, Mid channel, 60GHz-75GHz

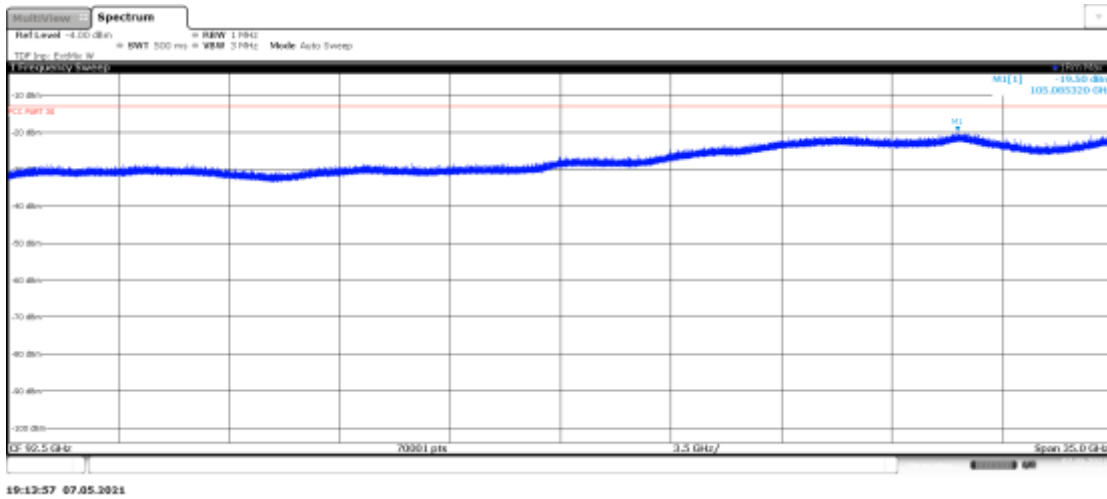

n260, Module0, Beam ID:161, 50MHz, PUSCH DFT, QPSK, 1RB, Mid channel, 75GHz-110GHz

Full Spectrum

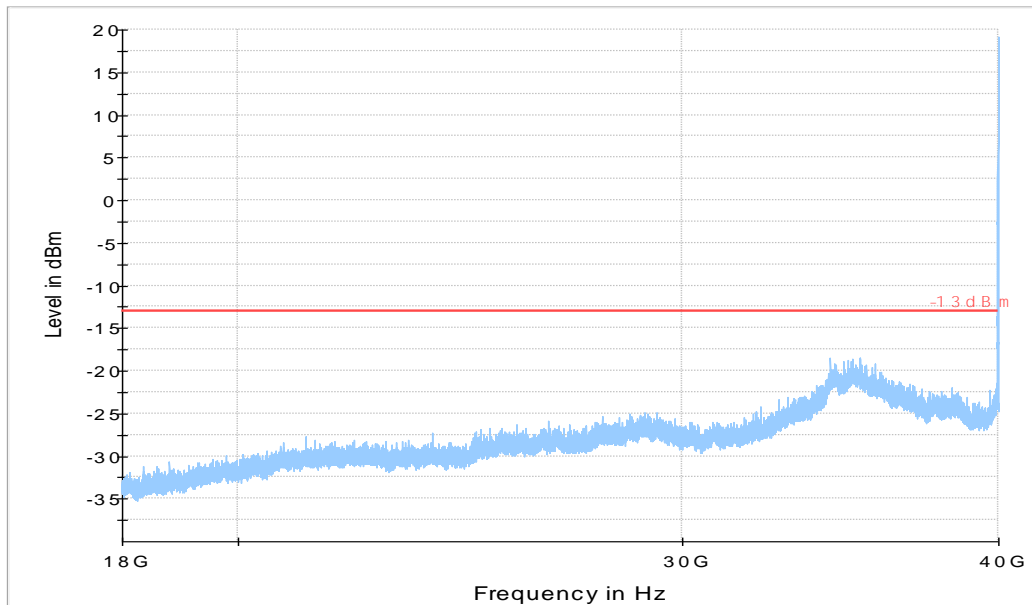

n260, Module0, Beam ID:161, 50MHz, PUSCH DFT, QPSK, 1RB, High channel, 18GHz-40GHz

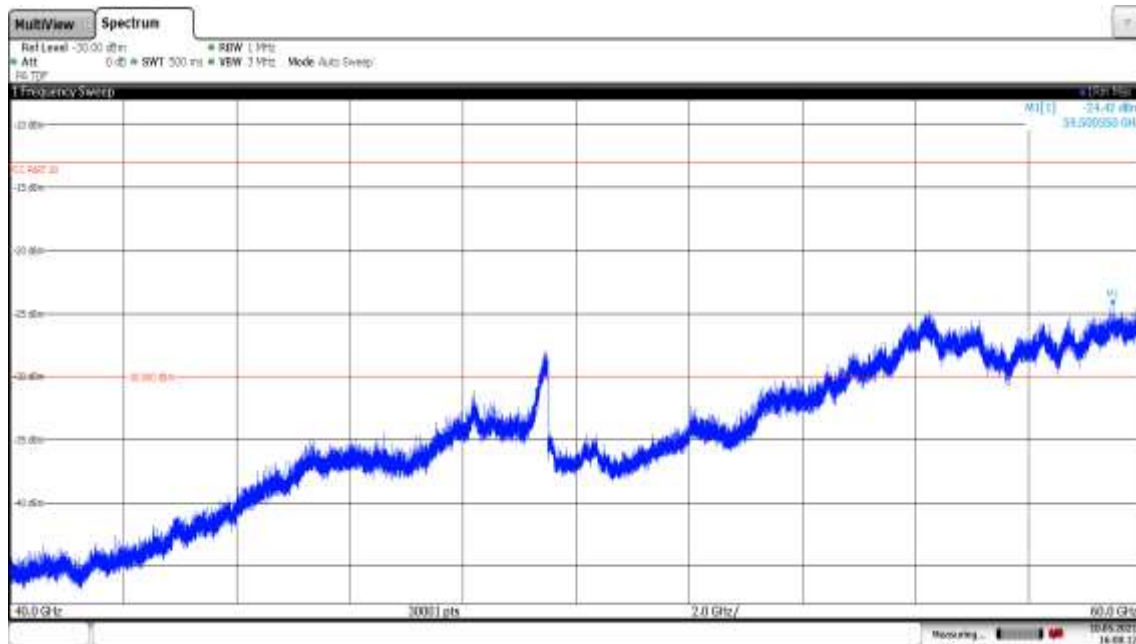

n260, Module0, Beam ID:161, 50MHz, PUSCH DFT, QPSK, 1RB, High channel, 40GHz-60GHz

Full Spectrum

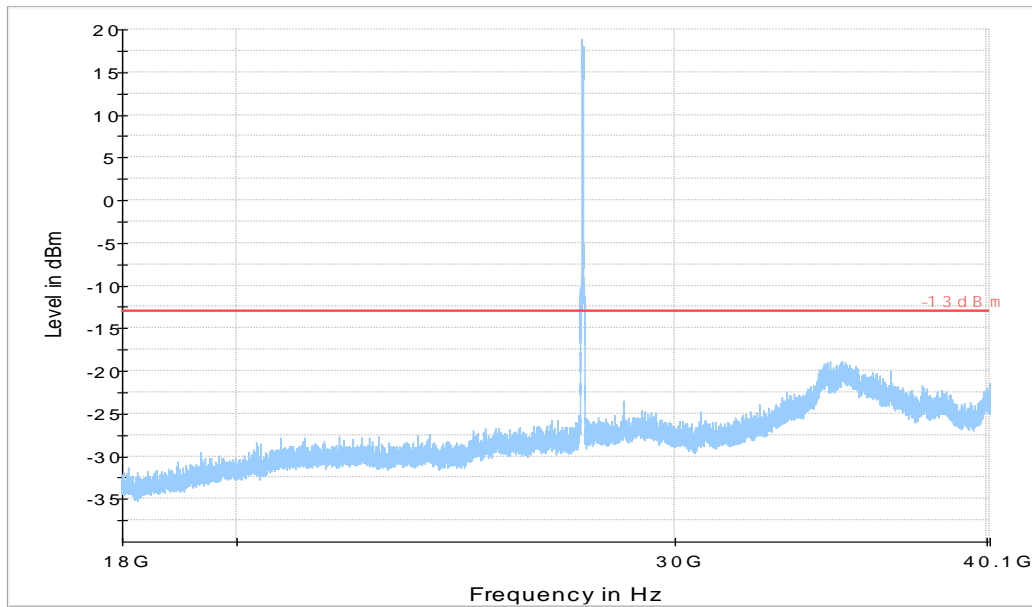

n261, Module0, Beam ID:175, 50MHz, PUSCH DFT, 16QAM, 100%RB, Low channel, 18GHz-40GHz

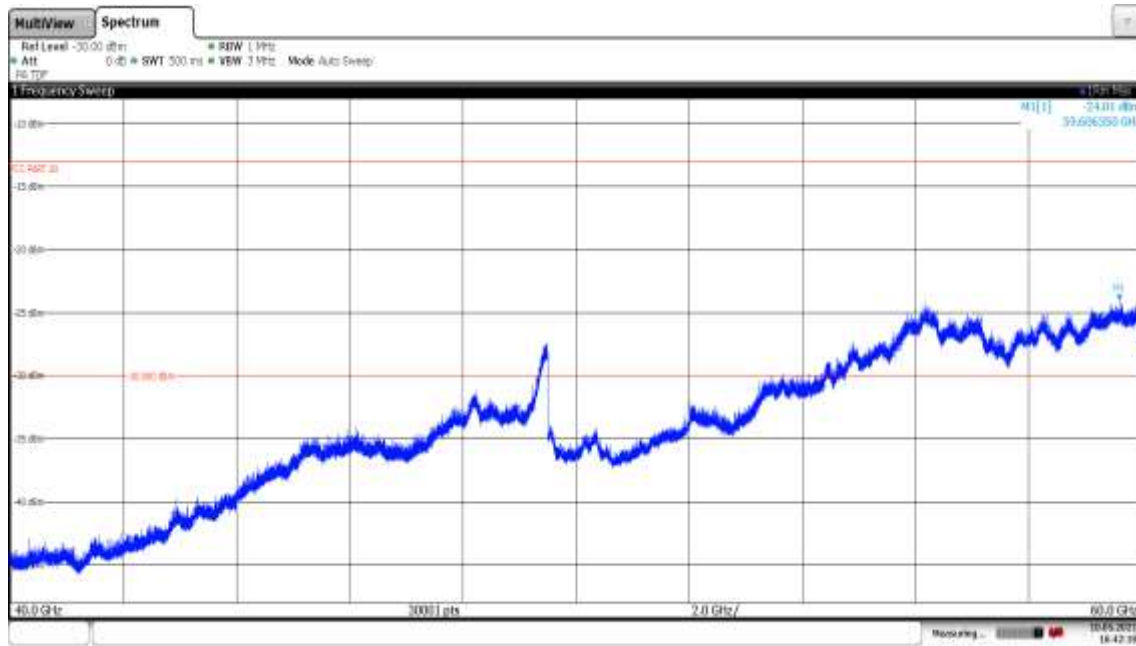

16:42:18 10.05.2021

n261, Module0, Beam ID:175, 50MHz, PUSCH DFT, 16QAM, 100%RB, Low channel, 40GHz-60GHz

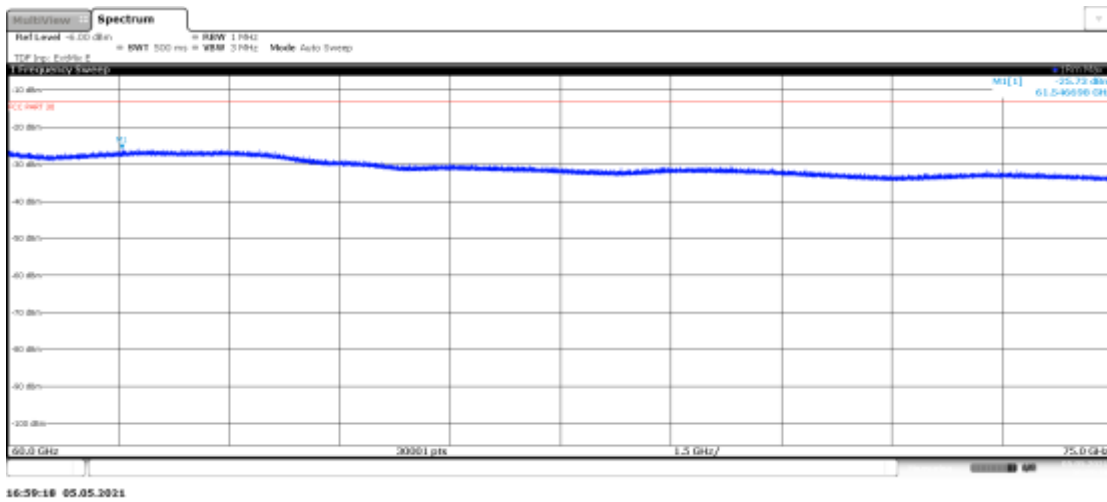

n261, Module0, Beam ID:175, 50MHz, PUSCH DFT, 16QAM, 100%RB, Low channel, 60GHz-75GHz

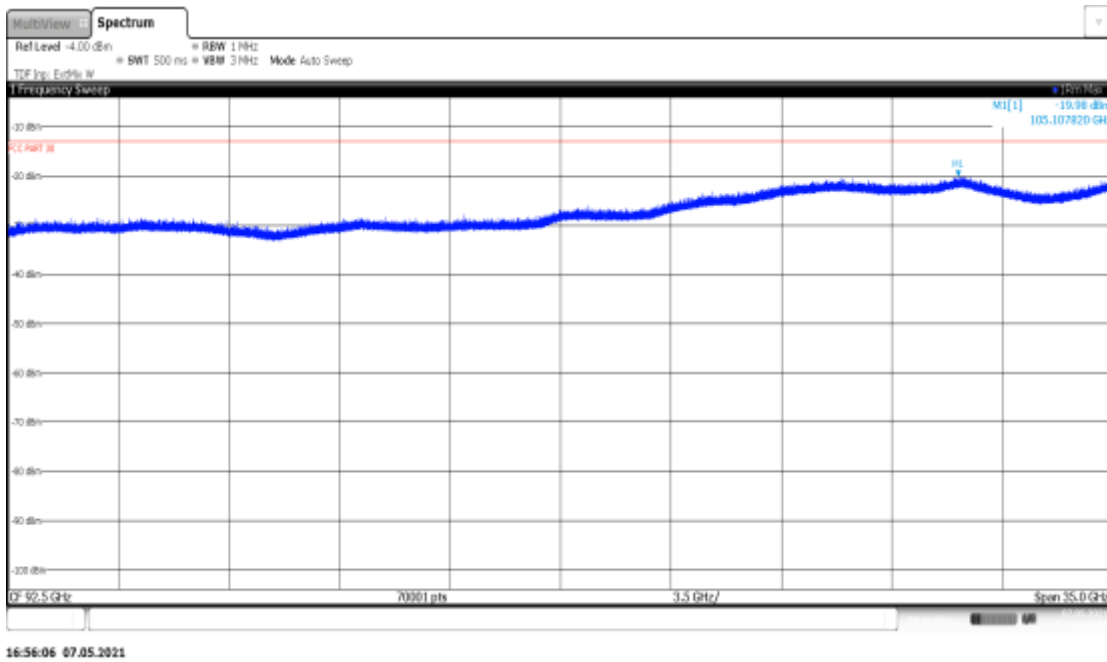

n261, Module0, Beam ID:175, 50MHz, PUSCH DFT, 16QAM, 100%RB, Low channel, 75GHz-110GHz

Full Spectrum

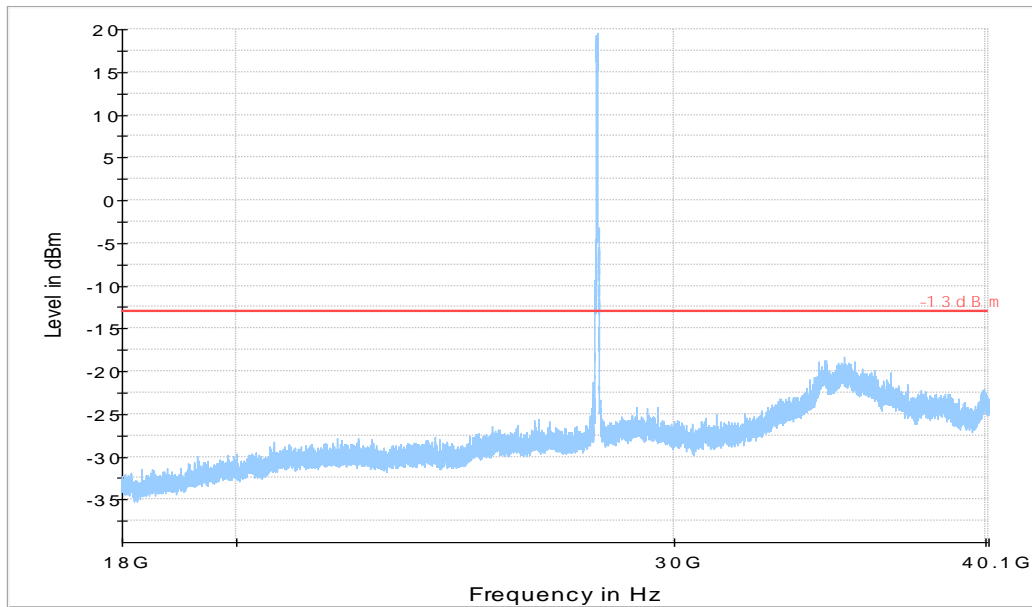

n261, Module0, Beam ID:175, 50MHz, PUSCH DFT, 16QAM, 100%RB, Mid channel, 18GHz-40GHz

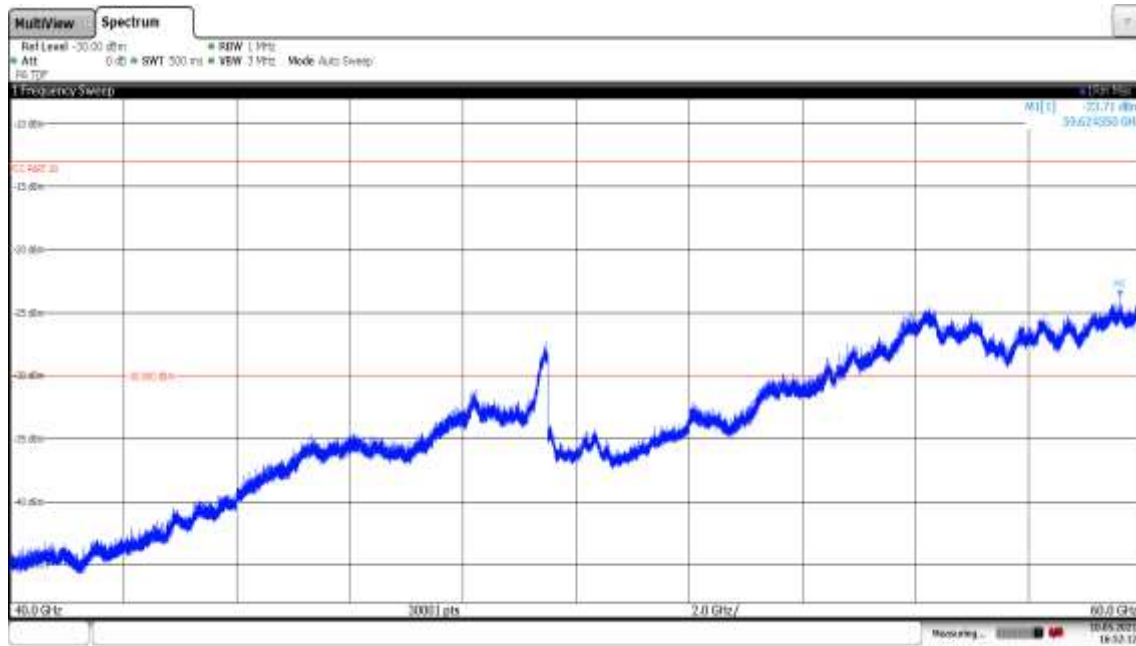

n261, Module0, Beam ID:175, 50MHz, PUSCH DFT, 16QAM, 100%RB, Mid channel, 40GHz-60GHz

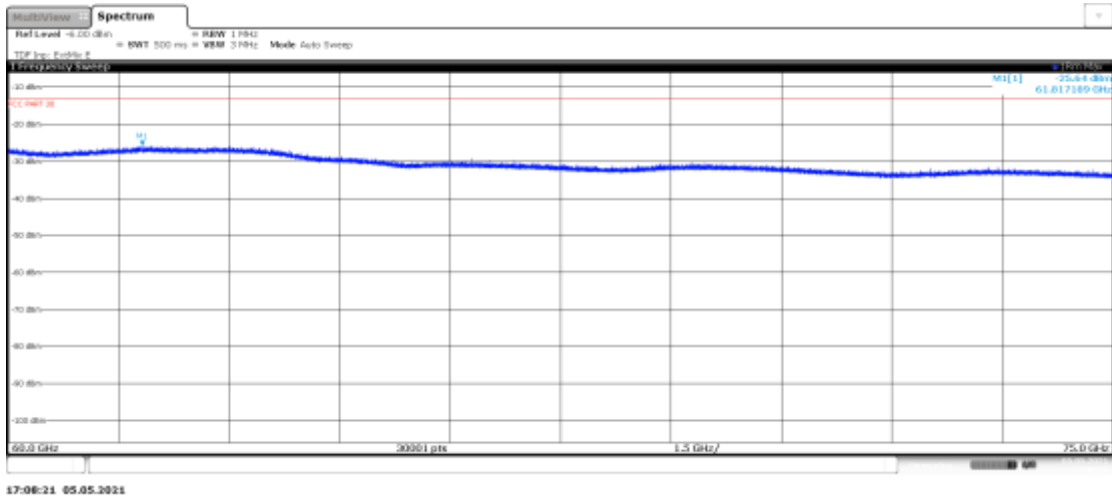

n261, Module0, Beam ID:175, 50MHz, PUSCH DFT, 16QAM, 100%RB, Mid channel, 60GHz-75GHz

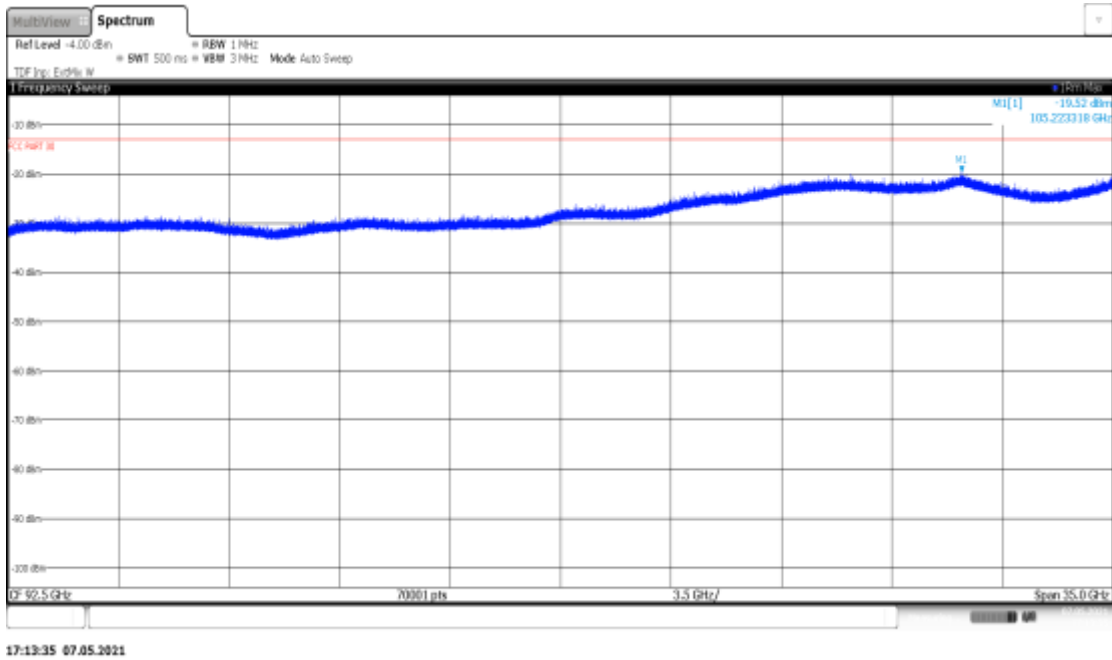

n261, Module0, Beam ID:175, 50MHz, PUSCH DFT, 16QAM, 100%RB, Mid channel, 75GHz-110GHz

Full Spectrum

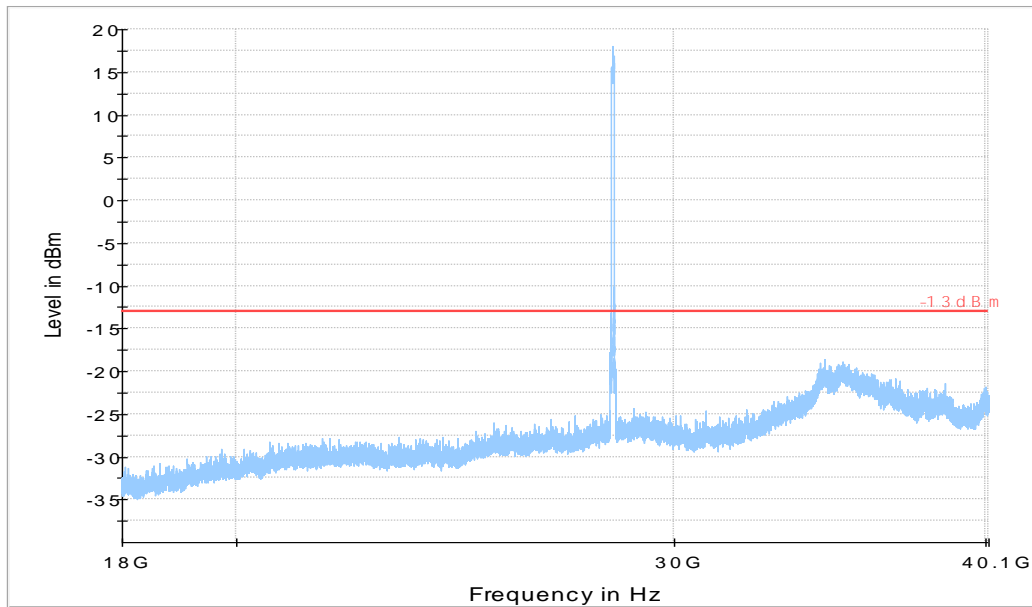

n261, Module0, Beam ID:175, 50MHz, PUSCH DFT, 16QAM, 100%RB, High channel, 18GHz-40GHz

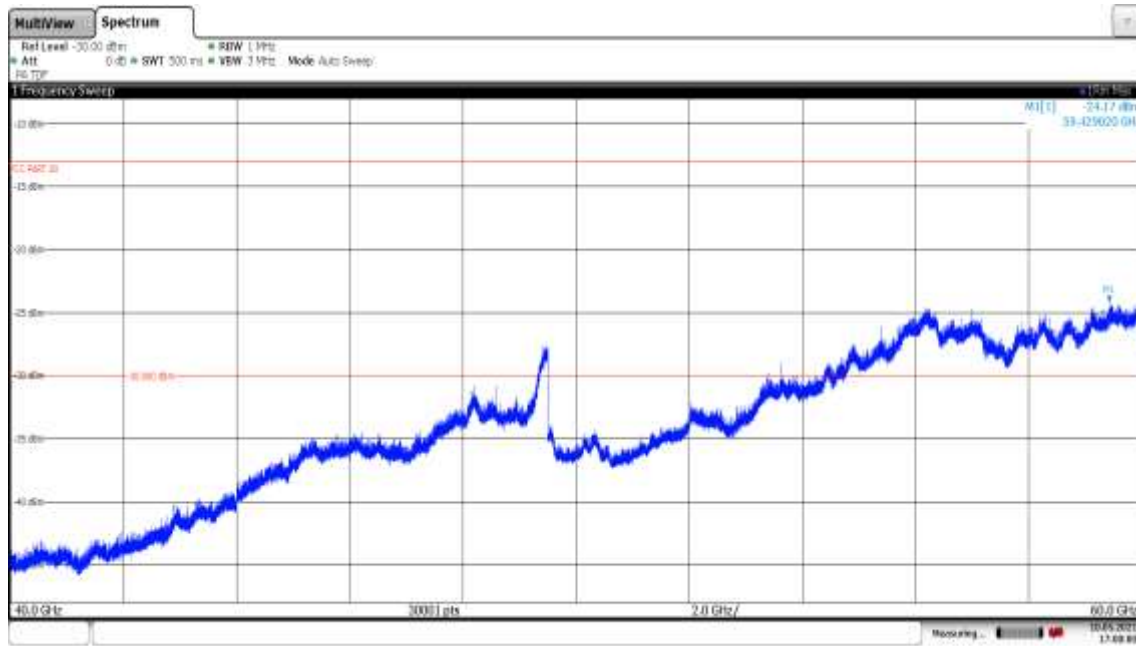

n261, Module0, Beam ID:175, 50MHz, PUSCH DFT, 16QAM, 100%RB, High channel, 40GHz-60GHz

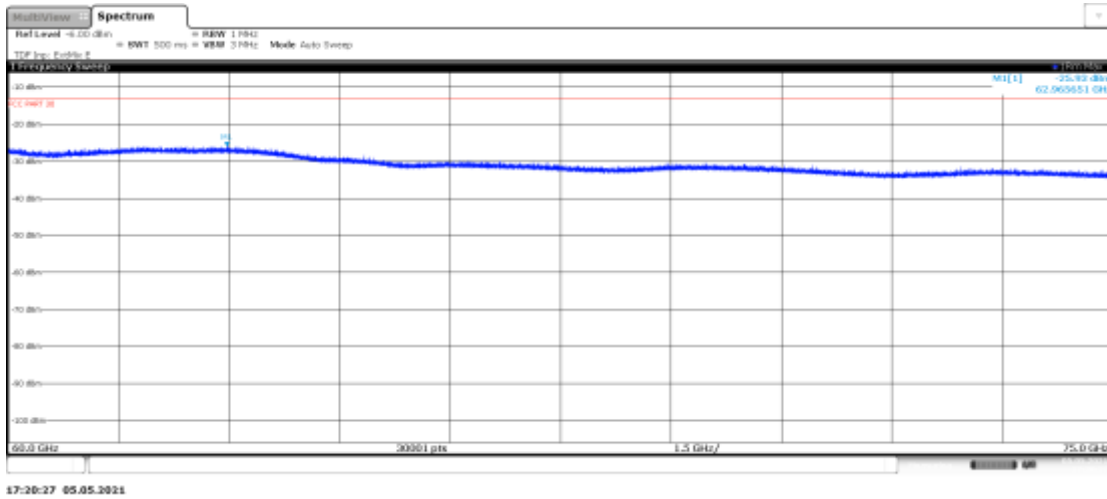

n261, Module0, Beam ID:175, 50MHz, PUSCH DFT, 16QAM, 100%RB, High channel, 60GHz-75GHz

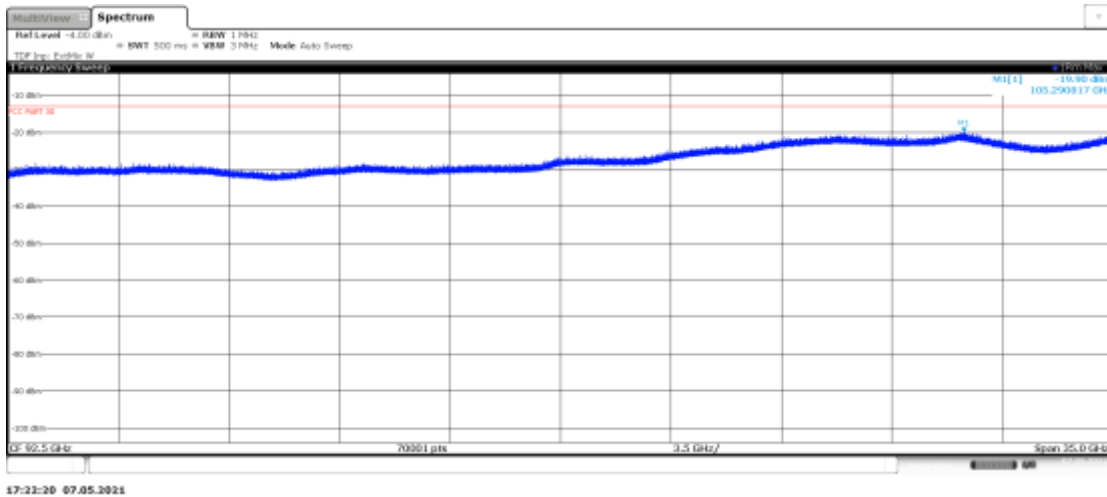

n261, Module0, Beam ID:175, 50MHz, PUSCH DFT, 16QAM, 100%RB, High channel, 75GHz-110GHz

A.3 Frequency Stability

\$2.1055

A.3.1 Method of Measurement

Frequency stability is a measure of the frequency drift due to temperature and supply voltage variations, with reference to the frequency measured at +20 °C and rated supply voltage. Two reference points are established at the applicable unwanted emissions limit using a RBW equal to the RBW required by the unwanted emissions specification of the applicable regulatory standard. These reference points measured using the lowest and highest channel of operation shall be identified as F_L and F_H respectively.

1. Measure the carrier frequency at room temperature.
2. Subject the EUT to overnight soak at -30°C.
3. With the EUT, powered via nominal voltage, connected to the CMW500, and in a simulated call on middle channel for each LTE band, measure the carrier frequency. These measurements should be made within 2 minutes of Powering up the EUT, to prevent significant self-warming.
4. Repeat the above measurements at 10°C increments from -30°C to +50°C. Allow at least 1.5 hours at each temperature, unpowered, before making measurements.
5. Re-measure carrier frequency at room temperature with nominal voltage. Vary supply voltage from minimum voltage to maximum voltage, in 0.1Volt increments re-measuring carrier frequency at each voltage. Pause at nominal voltage for 1.5 hours unpowered, to allow any self-heating to stabilize, before continuing.
6. Subject the EUT to overnight soak at +50°C.
7. With the EUT, powered via nominal voltage, connected to the CMW500 and in a simulated call on the center channel, measure the carrier frequency. These measurements should be made within 2 minutes of Powering up the EUT, to prevent significant self-warming.
8. Repeat the above measurements at 10 °C increments from -30°C to +50°C. Allow at least 1.5 hours at each temperature, unpowered, before making measurements.
9. At all temperature levels hold the temperature to +/- 0.5°C during the measurement procedure.

The frequency stability shall be sufficient to ensure that the fundamental emission stays within the authorized frequency block. As this transceiver is considered "Hand carried, battery powered equipment" Section 2.1055(d)(2) applies. This requires that the lower voltage for frequency stability testing be specified by the manufacturer. This transceiver is specified to operate with an input voltage of the lower, higher and nominal voltage. Operation above or below these voltage limits is prohibited by transceiver software in order to prevent improper operation as well as to protect components from overstress.

A.3.2 Measurement results

n260, PUSCH DFT QPSK, 1RB

Frequency Error vs Temperature

OPERATING FREQUENCY: 38499960000Hz

POWER (VDC)	TEMP (°C)	FREQUENCY (Hz)	Freq. Dev (Hz)	Deviation (%)
3.85	+20(REF)	38499200000	/	/
	-30	38499600000	400000	0.001039%
	-20	38499000000	-200000	-0.0005195%
	-10	38499000000	-200000	-0.0005195%
	+0	38499200000	0	0 %
	+10	38499000000	-200000	-0.0005195%
	+20	38499000000	-200000	-0.0005195%
	+30	38499000000	-200000	-0.0005195%
	+40	38498800000	-400000	-0.001039%
	+50	38499200000	0	0%
3.00	+20	38499200000	0	0%
4.40	+20	38499200000	0	0%

n261, PUSCH DFT QPSK, 1RB

Frequency Error vs Temperature

OPERATING FREQUENCY: 27924960000Hz

POWER (VDC)	TEMP (°C)	FREQUENCY (Hz)	Freq. Dev (Hz)	Deviation (%)
3.85	+20(REF)	27924200000	/	/
	-30	27924000000	-200000	-0.0007162%
	-20	27924200000	0	0 %
	-10	27924600000	400000	0.0014324%
	+0	27924600000	400000	0.0014324%
	+10	27924600000	400000	0.0014324%
	+20	27924200000	0	0%
	+30	27924600000	400000	0.0014324%
	+40	27924200000	0	0%
	+50	27924600000	400000	0.0014324%
3.00	+20	27924400000	200000	0.0007162%
4.40	+20	27924200000	0	0%

A.4 Occupied Bandwidth

Occupied bandwidth measurements are only provided for selected frequencies in order to reduce the amount of submitted data. Data were taken at the mid frequencies frequency. The table below lists the measured 99% BW. Spectrum analyzer plots are included on the following pages.

The measurement method is from ANSI C63.26:

- a) The spectrum analyzer center frequency is set to the nominal EUT channel center frequency. The frequency span for the spectrum analyzer shall be set wide enough to capture all modulation products including the emission skirts.
- b) The nominal IF filter 3 dB bandwidth (RBW) shall be in the range of 1% to 5% of the anticipated OBW, and the VBW shall be set $\geq 3 \times$ RBW.
- c) Set the reference level of the instrument as required to prevent the signal amplitude from exceeding the maximum spectrum analyzer input mixer level for linear operation.
- d) Set the detection mode to peak, and the trace mode to max-hold.

The average EIRP reported below is calculated by:

$EIRP(dBm) = \text{Spectrum Analyzer Channel Power Level}(dBm) - \text{Antenna Factor}(dBi) + \text{Cable Loss}(dB) + 20\log(F) + 20\log(D) - 27.56$

Where:

F:frequency (MHz)

D:Distance(m)=3m

n260, 50MHz (99%)

Module0, Beam ID:33, CP-OFDM			
Frequency(MHz)	Occupied Bandwidth (99%) (kHz)		
38499.96	QPSK	16QAM	64QAM
	45.91	49.80	48.96

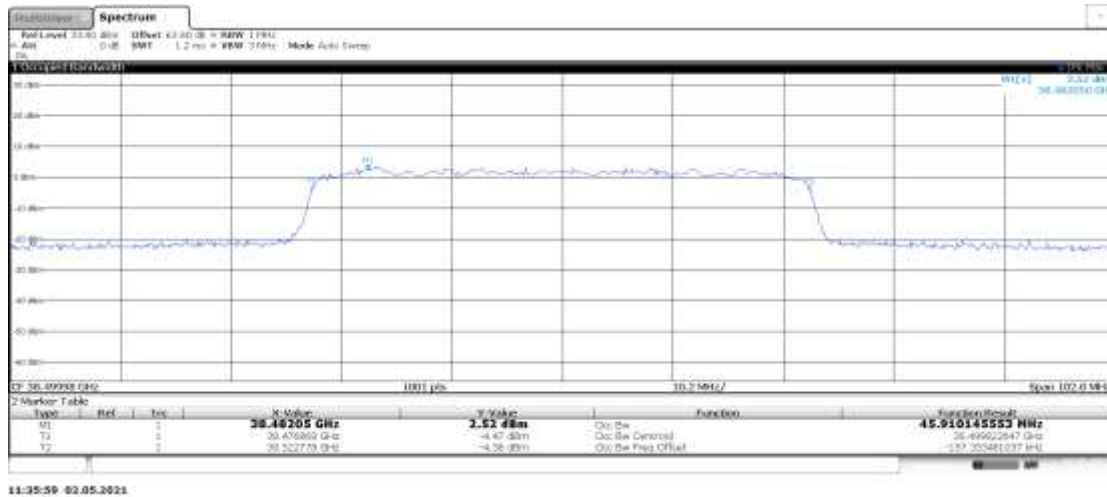
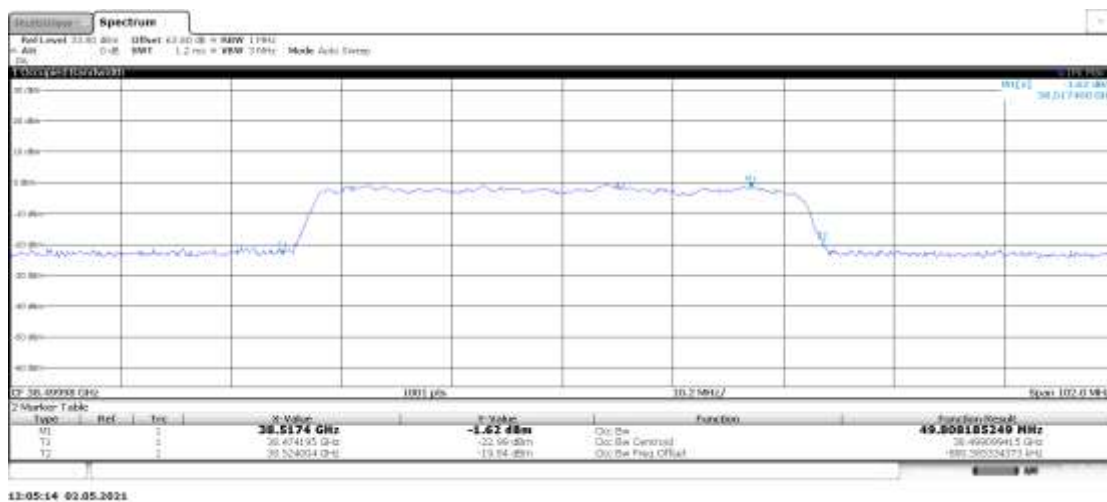
n260, 50MHz Bandwidth, QPSK (99% BW)

n260, 50MHz Bandwidth, 16QAM (99% BW)

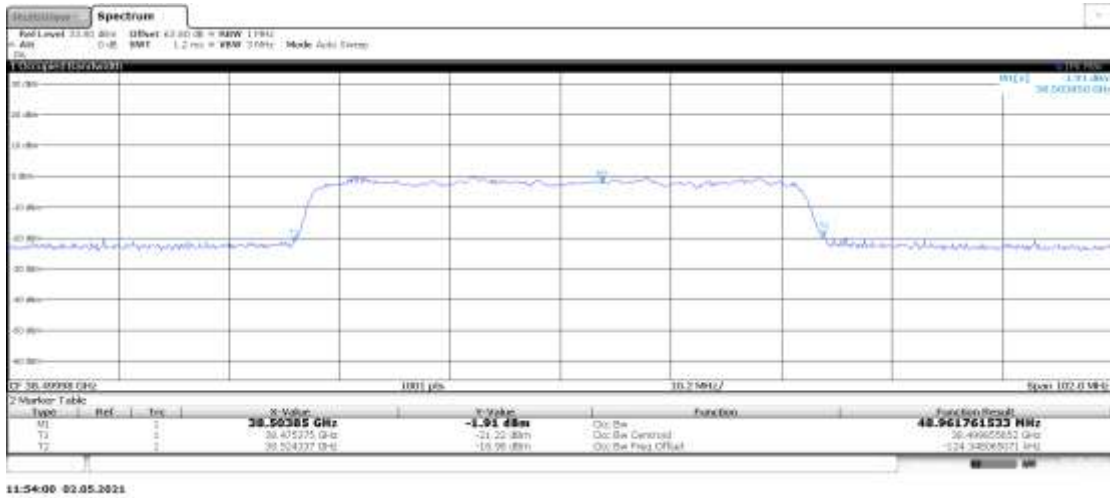
n260, 50MHz Bandwidth, 64QAM (99% BW)



n260, 100MHz (99%)

Module0, Beam ID:33, CP-OFDM			
Frequency(MHz)	Occupied Bandwidth (99%) (kHz)		
38499.96	QPSK	16QAM	64QAM
	92.92	93.03	92.81

n260, 100MHz Bandwidth, QPSK (99% BW)

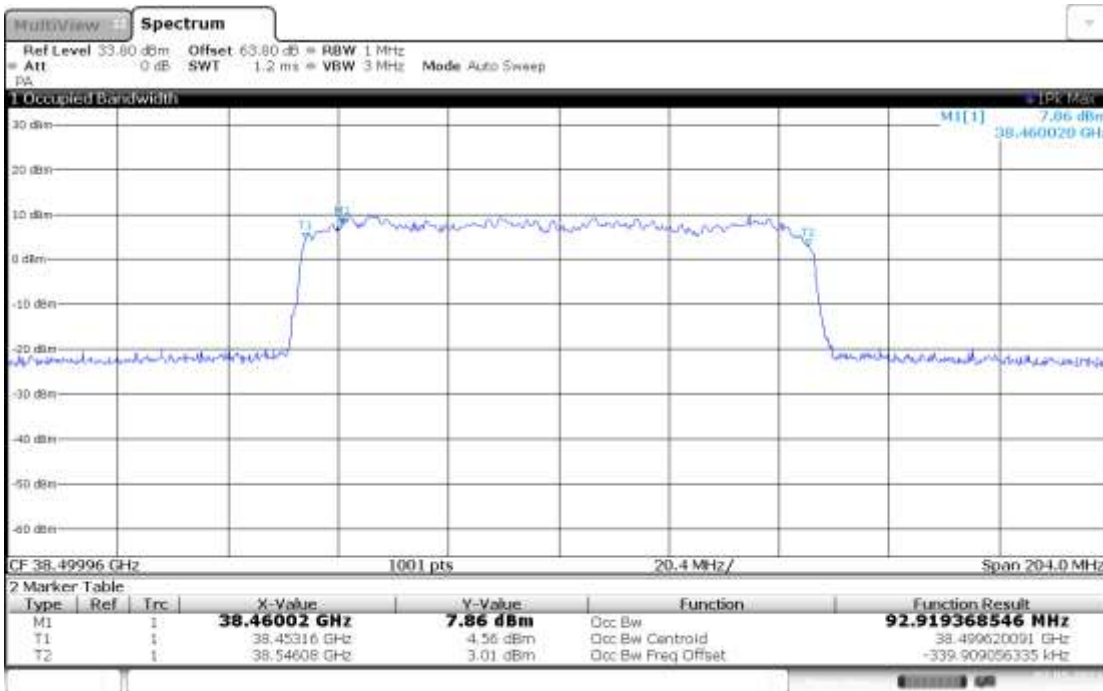

23:38:08 07.05.2021

n260, 100MHz Bandwidth, 16QAM (99% BW)

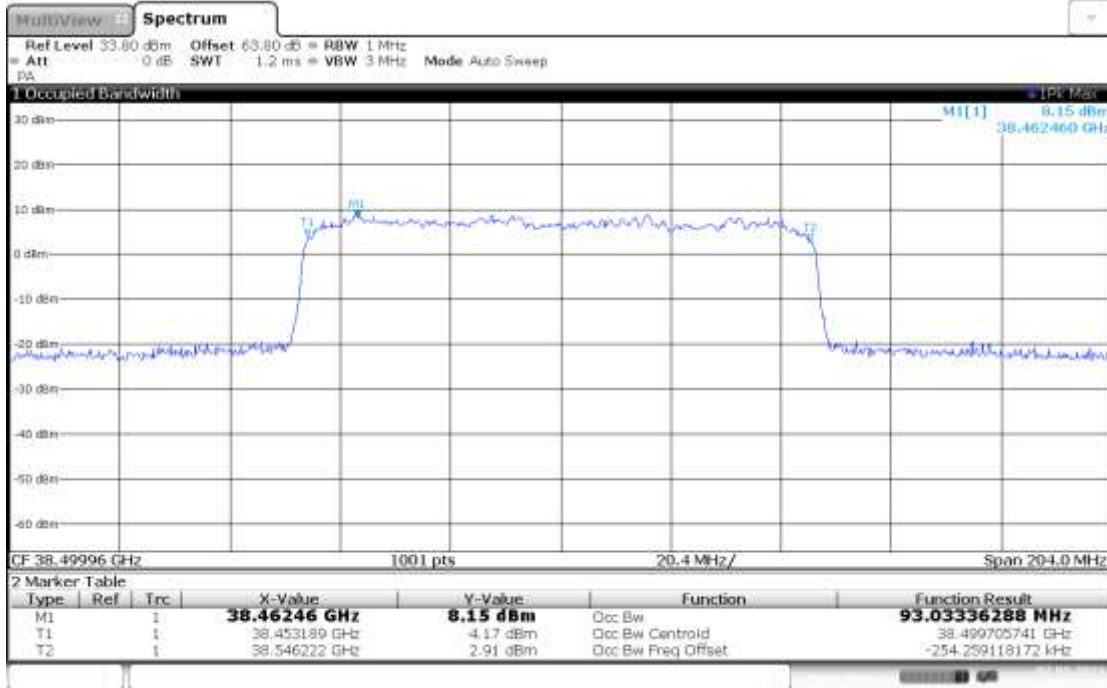

23:25:16 07.05.2021

n260, 100MHz Bandwidth, 64QAM (99% BW)

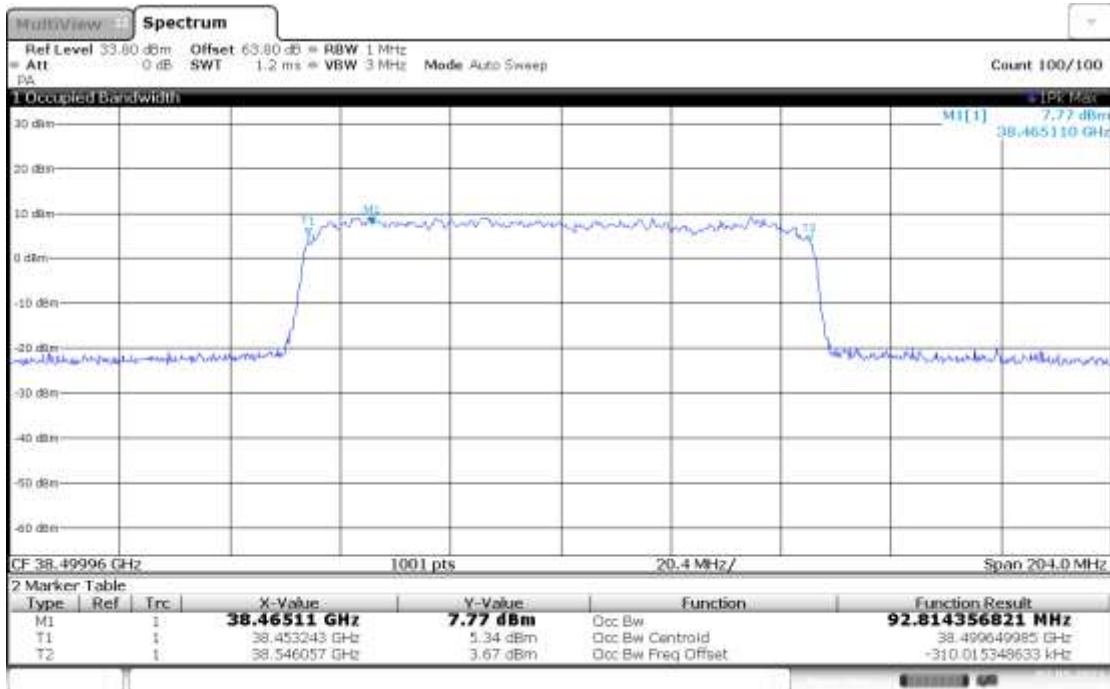

23:17:51 07.05.2021

n260, 50MHz (99%)

Module0, Beam ID:33, PUSCH DFT			
Frequency(MHz)	Occupied Bandwidth (99%) (kHz)		
38499.96	QPSK	16QAM	64QAM
	45.68	45.53	45.57

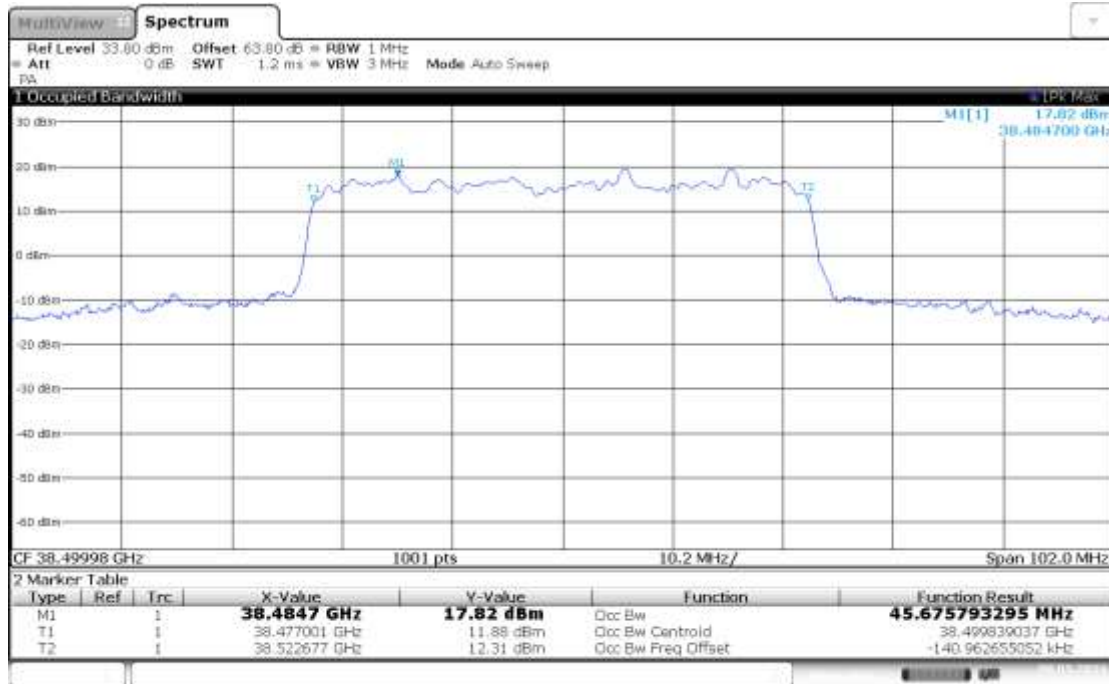
n260, 50MHz Bandwidth, QPSK (99% BW)

00:50:22 08.05.2021

n260,

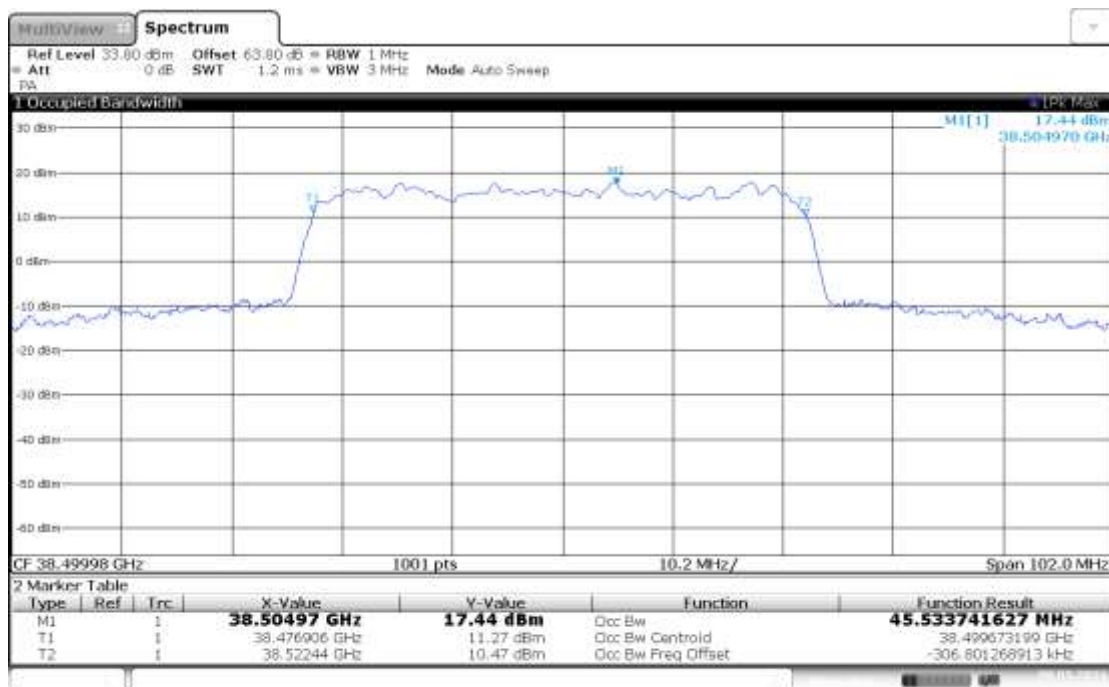
50MHz Bandwidth, 16QAM (99% BW)

00:57:39 08.05.2021

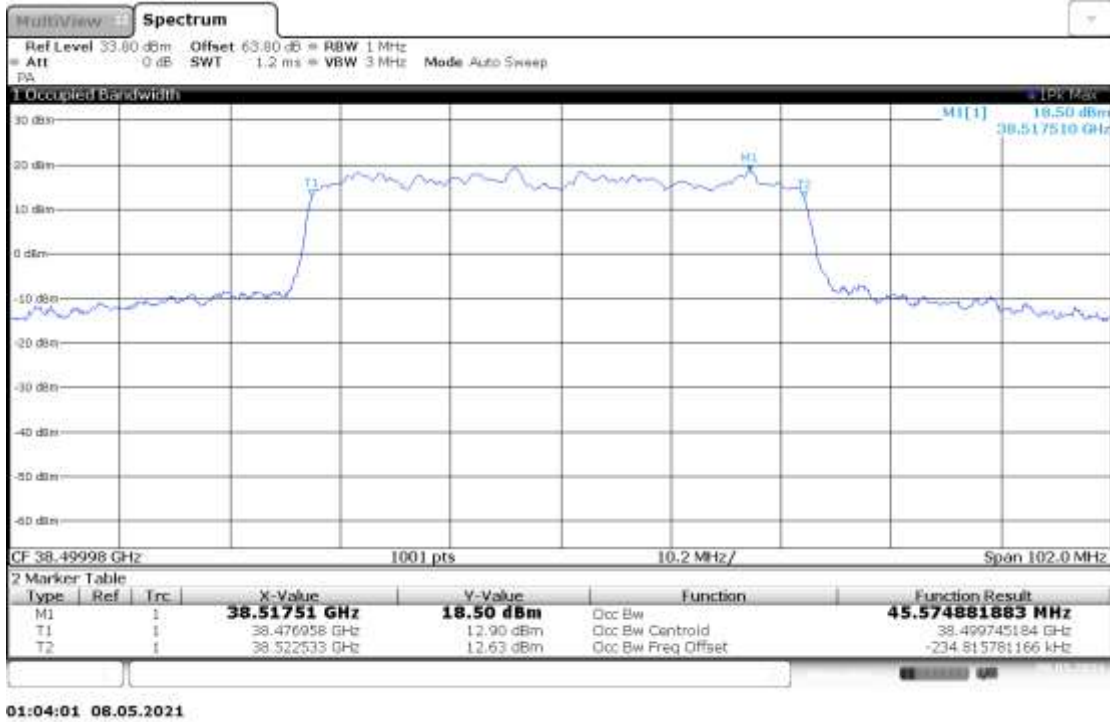
n260, 50MHz Bandwidth, 64QAM (99% BW)

n260, 100MHz (99%)

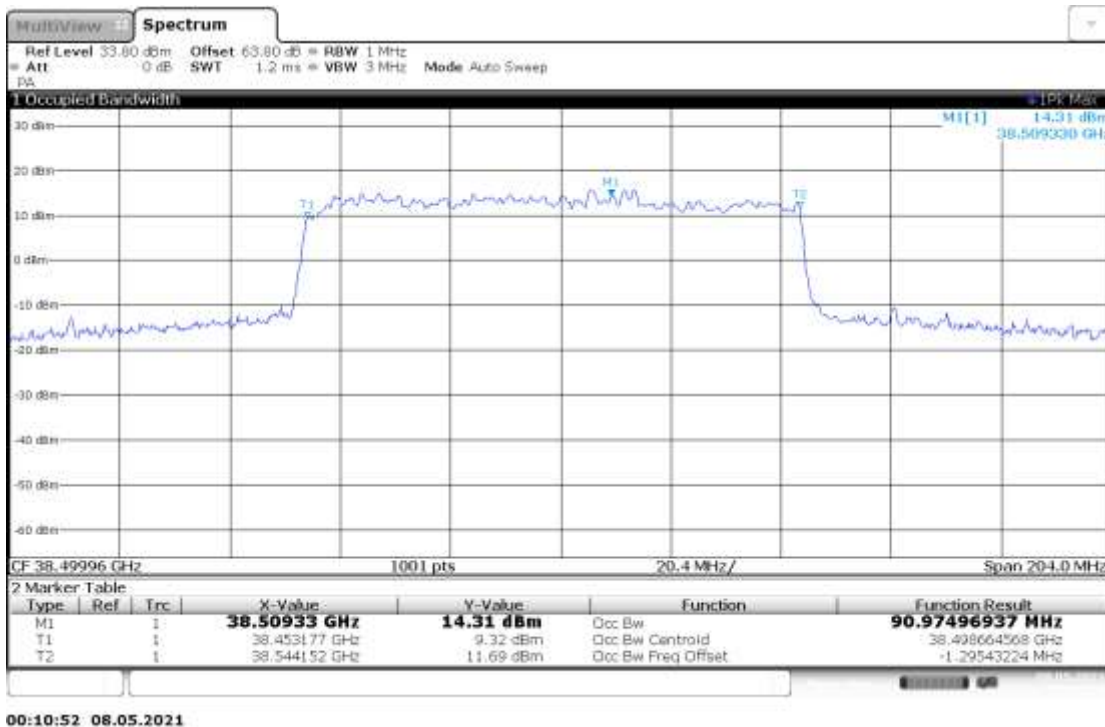
Module0, Beam ID:33, PUSCH DFT			
Frequency(MHz)	Occupied Bandwidth (99%) (kHz)		
38499.96	QPSK	16QAM	64QAM
	90.97	90.79	90.80

n260, 100MHz Bandwidth, QPSK (99% BW)

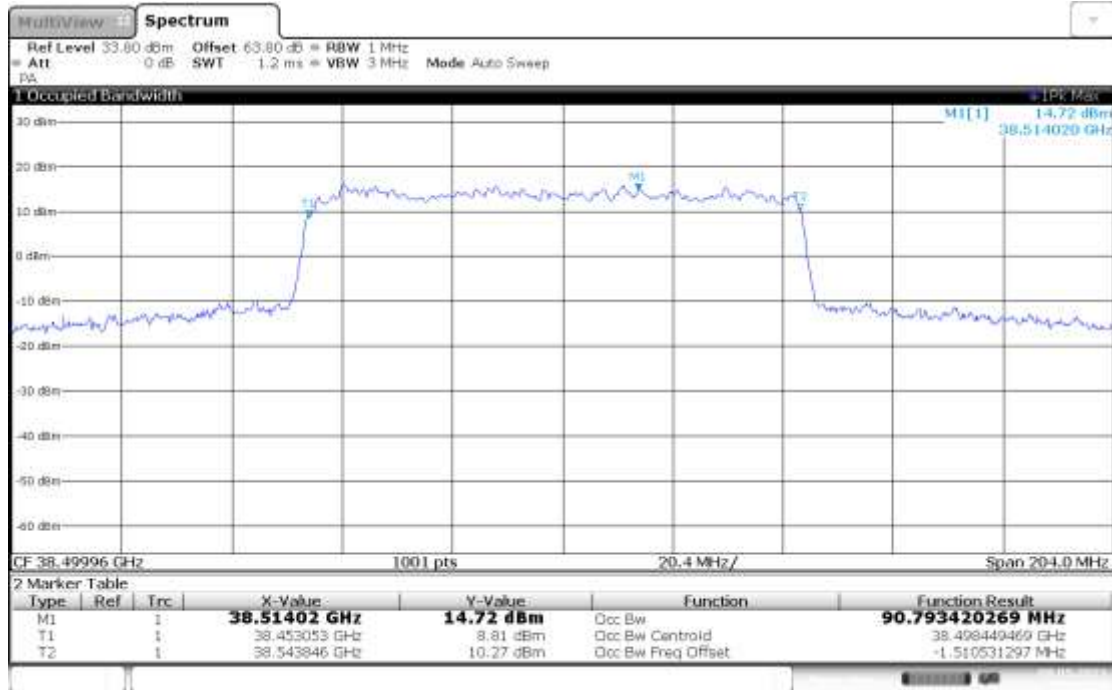
n260, 100MHz Bandwidth, 16QAM (99% BW)



00:18:24 08.05.2021

n260, 100MHz Bandwidth, 64QAM (99% BW)

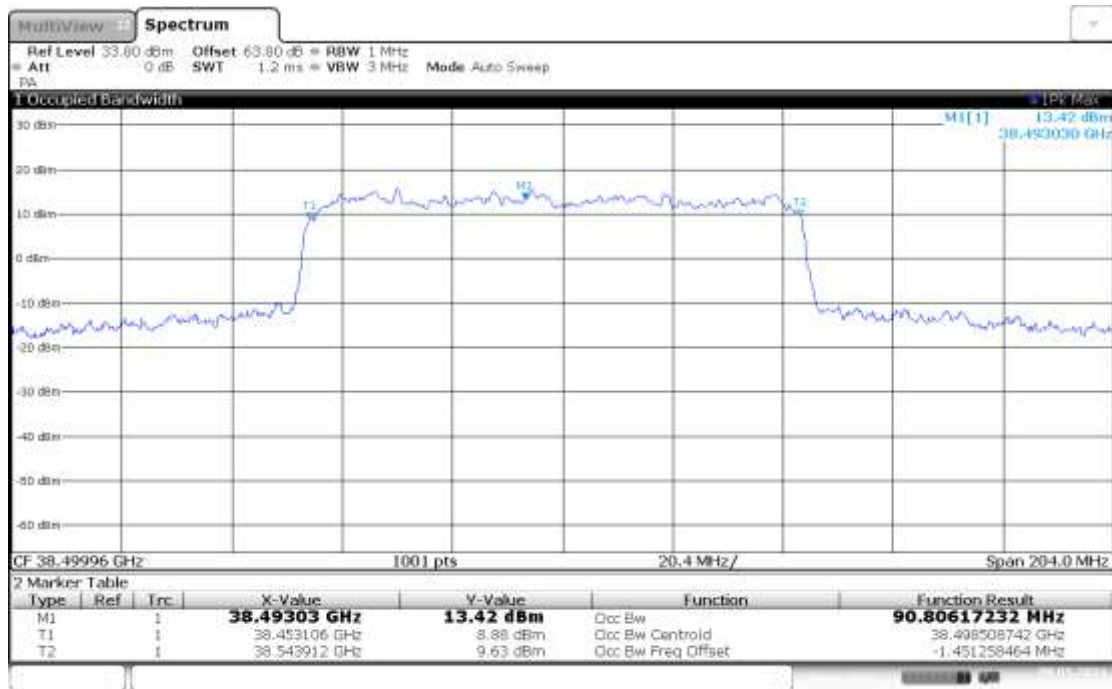

00:28:34 08.05.2021

n260, 100MHz (99%)

Module1, Beam ID:29, PUSCH DFT			
Frequency(MHz)	Occupied Bandwidth (99%) (kHz)		
38499.96	QPSK	16QAM	64QAM
			91.33

n260, 100MHz Bandwidth, 64QAM (99% BW)

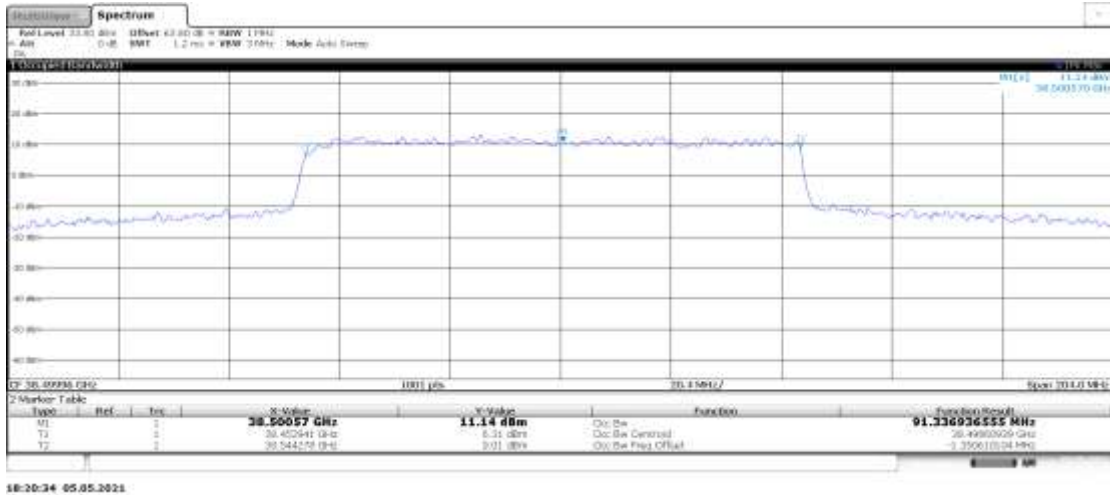

n260, 100MHz (99%)

Module2, Beam ID:39, PUSCH DFT			
Frequency(MHz)	Occupied Bandwidth (99%) (kHz)		
38499.96	QPSK	16QAM	64QAM
			90.79

n260, 100MHz Bandwidth, 64QAM (99% BW)

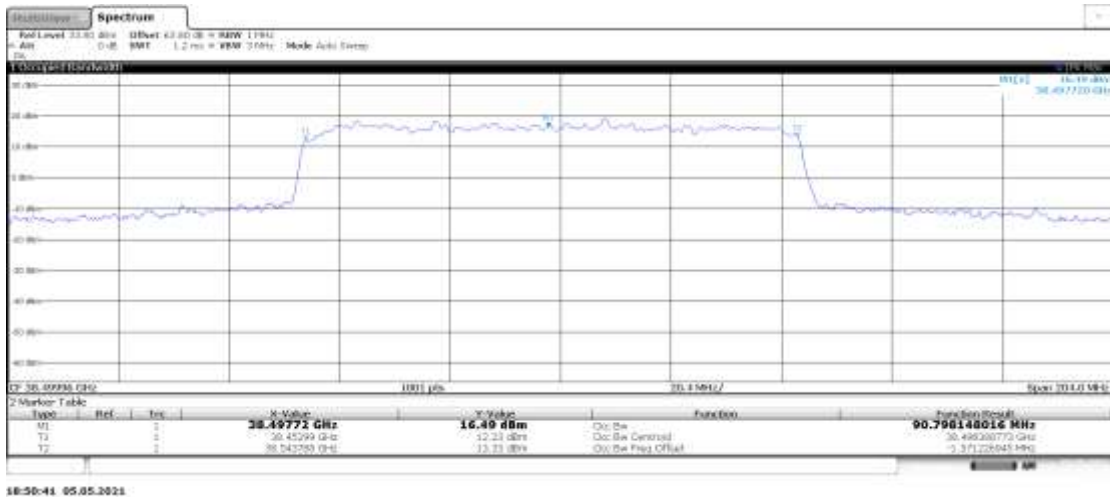

n260, 50MHz (99%)

Module0, Beam ID:161, CP-OFDM			
Frequency(MHz)	Occupied Bandwidth (99%) (kHz)		
38499.96	QPSK	16QAM	64QAM
	45.55	45.49	45.60

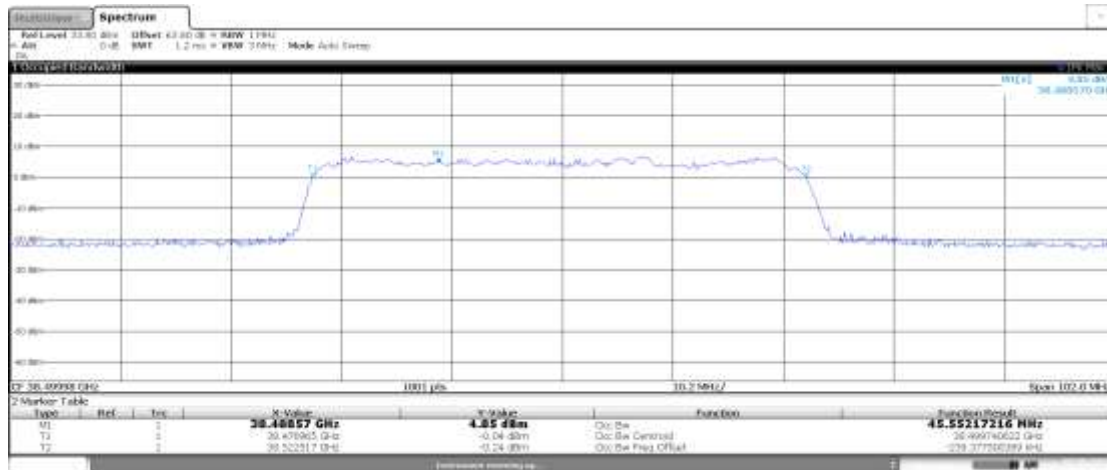
n260, 50MHz Bandwidth, QPSK (99% BW)

10:46:23 02.05.2021

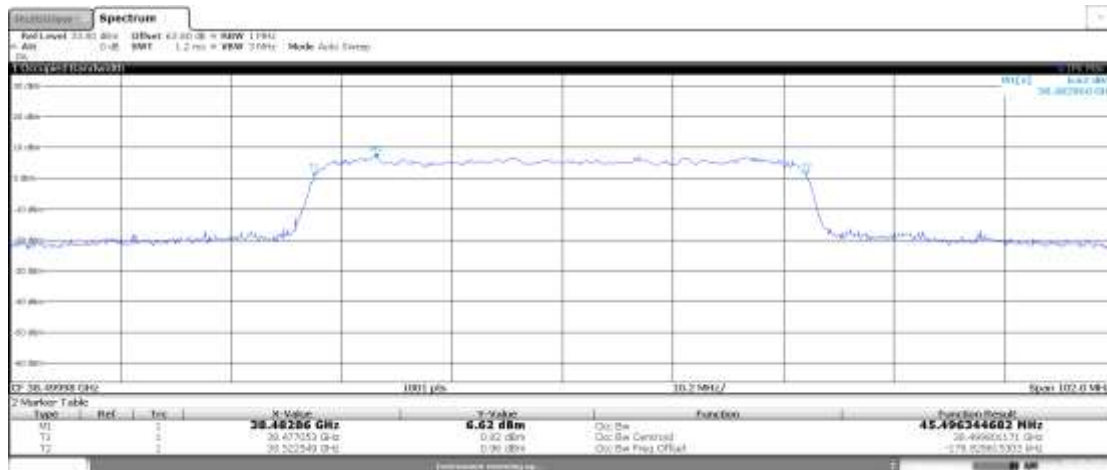
n260, 50MHz Bandwidth, 16QAM (99% BW)

10:54:56 02.05.2021

n260, 50MHz Bandwidth, 64QAM (99% BW)

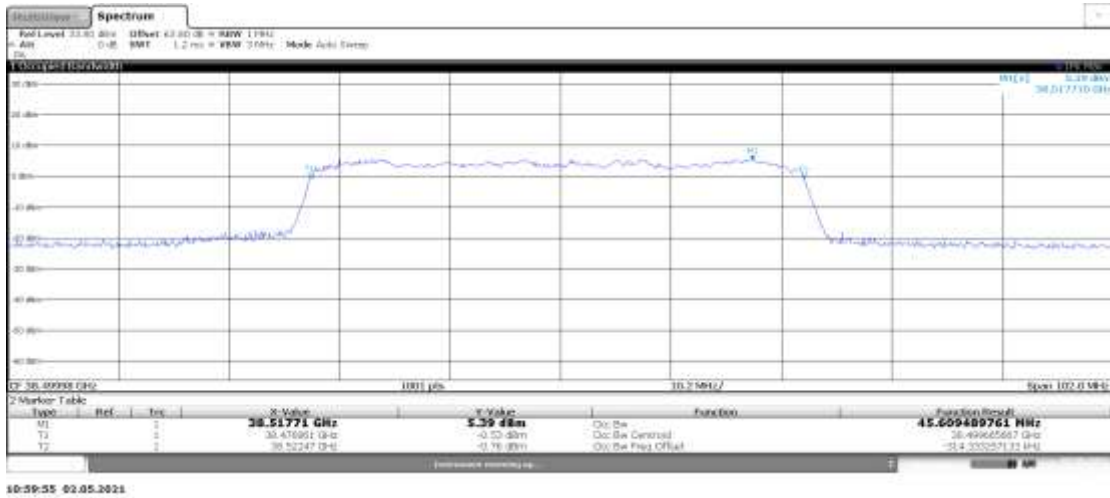

n260, 100MHz (99%)

Module0, Beam ID:161, CP-OFDM			
Frequency(MHz)	Occupied Bandwidth (99%) (kHz)		
38499.96	QPSK	16QAM	64QAM
	93. 71	93. 71	93. 30

n260, 100MHz Bandwidth, QPSK (99% BW)

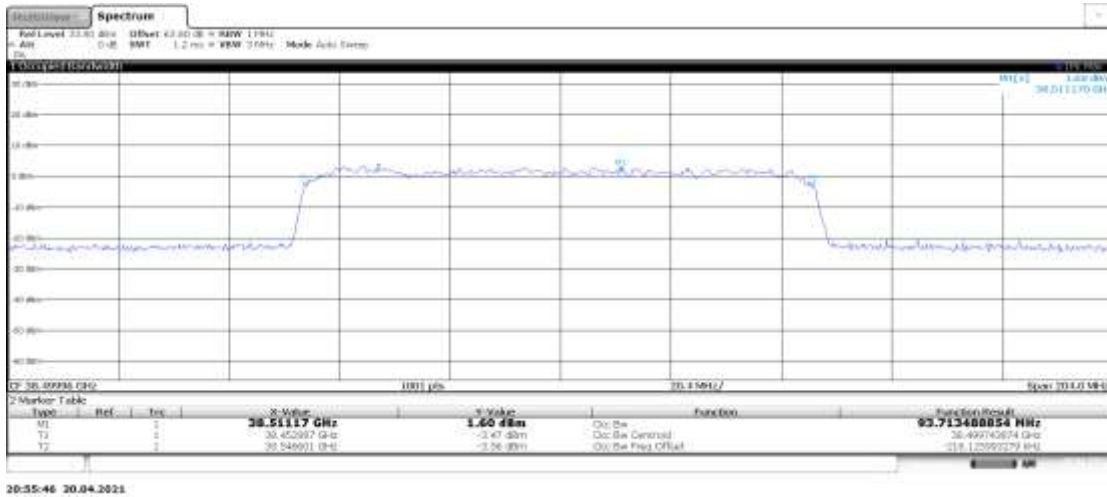

n260, 100MHz Bandwidth, 16QAM (99% BW)

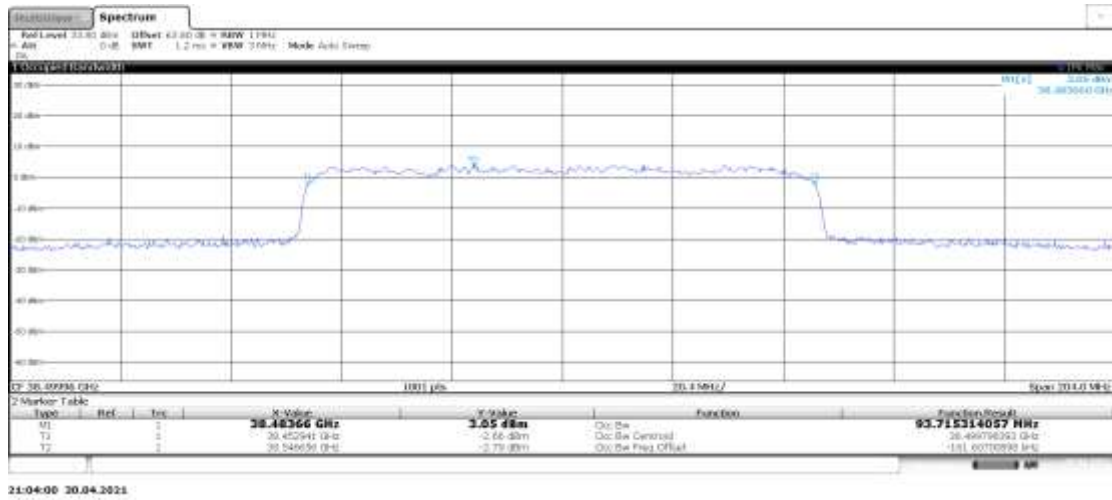

n260, 100MHz Bandwidth, 64QAM (99% BW)

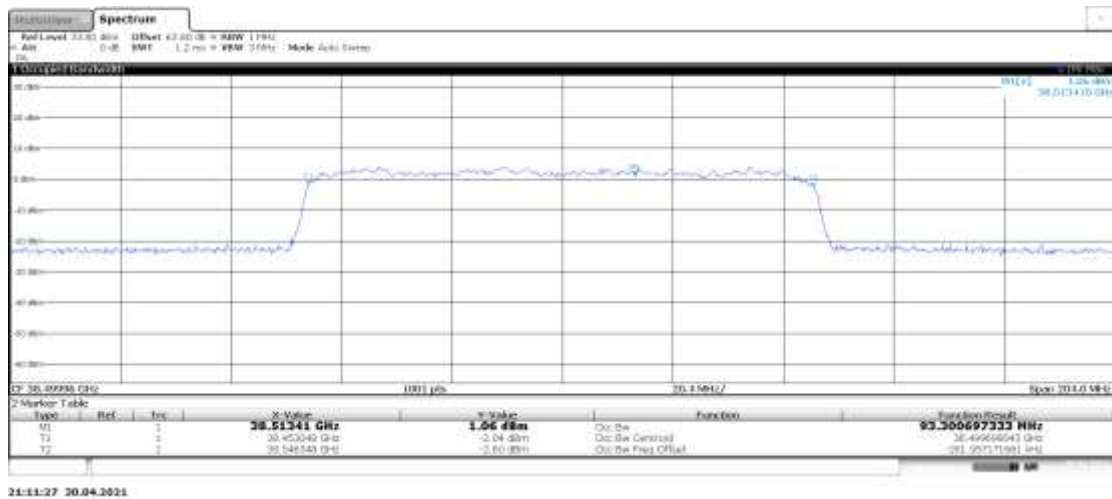

n260, 50MHz (99%)

Module0, Beam ID:161, PUSCH DFT			
Frequency(MHz)	Occupied Bandwidth (99%) (kHz)		
38499.96	QPSK	16QAM	64QAM
	46.02	46.60	46.03

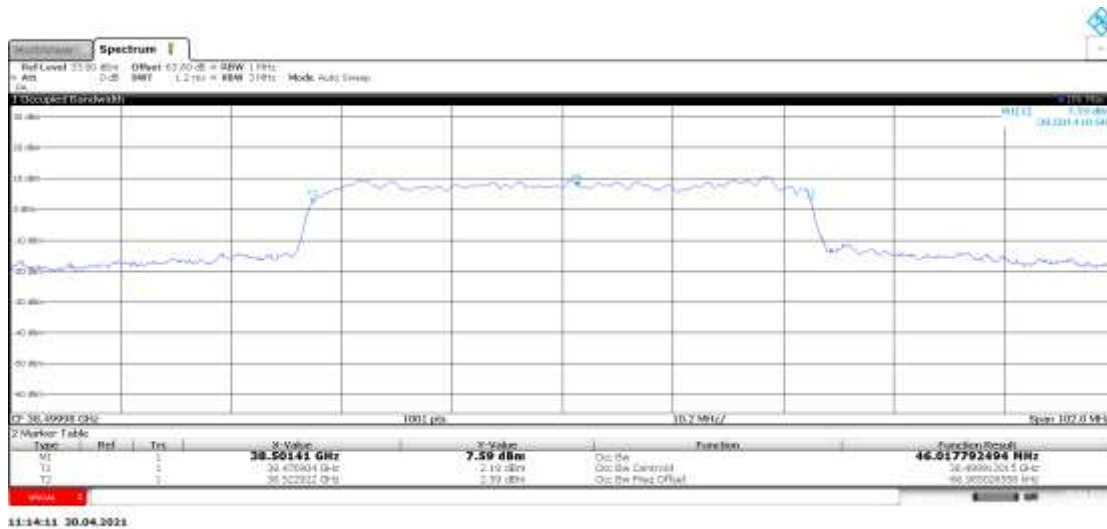
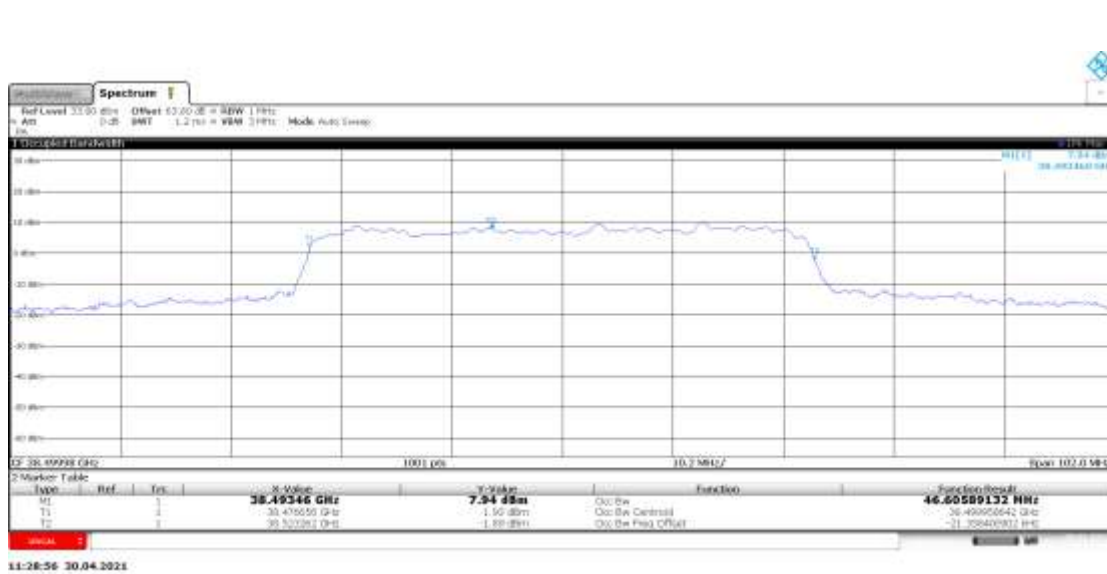
n260, 50MHz Bandwidth, QPSK (99% BW)

n260, 50MHz Bandwidth, 16QAM (99% BW)

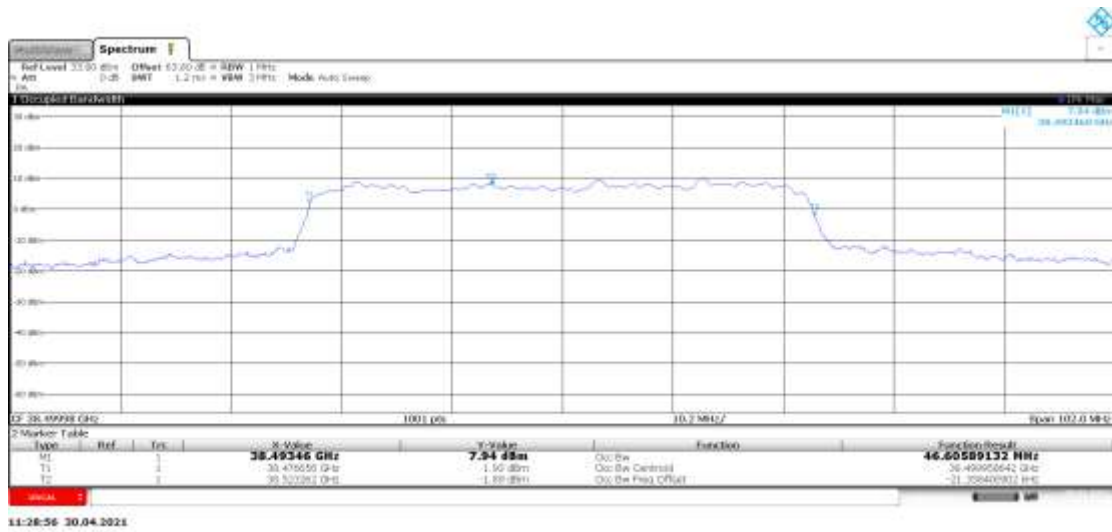
n260, 50MHz Bandwidth, 64QAM (99% BW)



n260, 100MHz (99%)

Module0, Beam ID:161, PUSCH DFT			
Frequency(MHz)	Occupied Bandwidth (99%) (kHz)		
38499.96	QPSK	16QAM	64QAM
	92.52	91.36	92.92

n260, 100MHz Bandwidth, QPSK (99% BW)

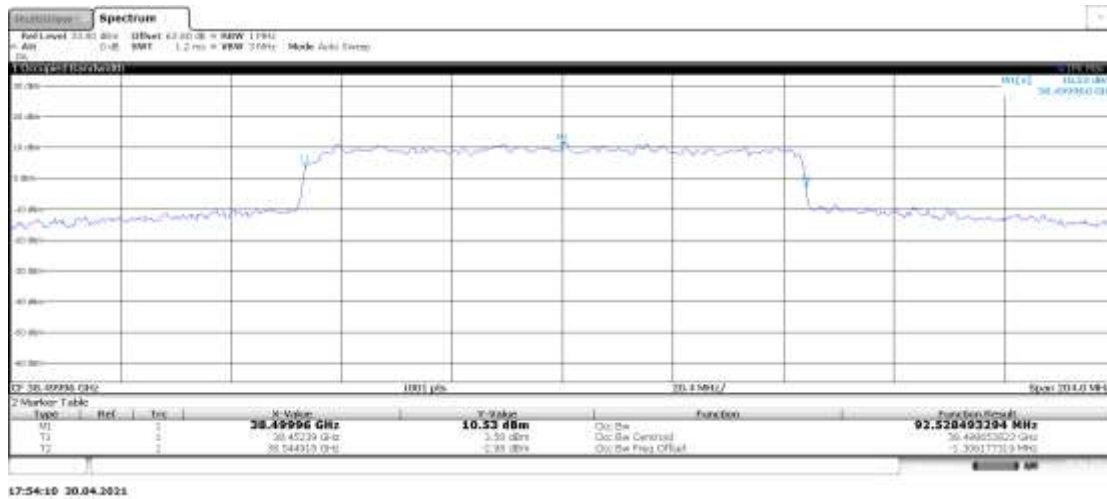

n260, 100MHz Bandwidth, 16QAM (99% BW)

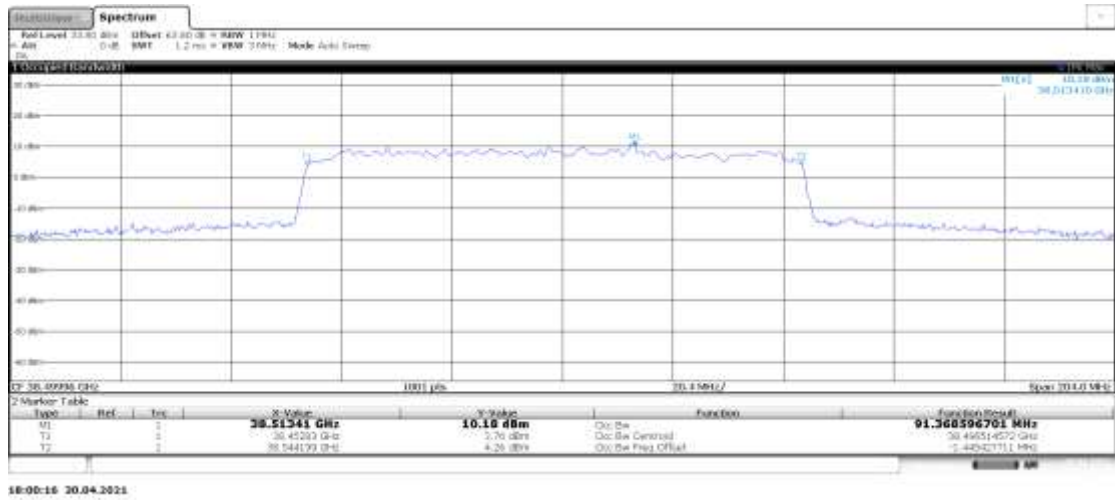

n260, 100MHz Bandwidth, 64QAM (99% BW)

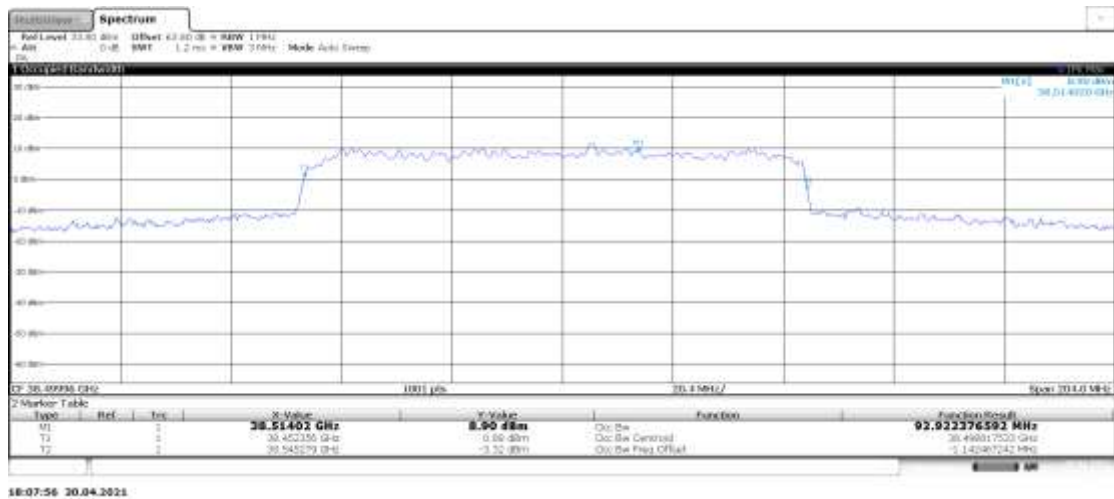

n260, 100MHz (99%)

Module1, Beam ID:157, PUSCH DFT			
Frequency(MHz)	Occupied Bandwidth (99%) (kHz)		
38499.96	QPSK	16QAM	64QAM
	90.54	/	/

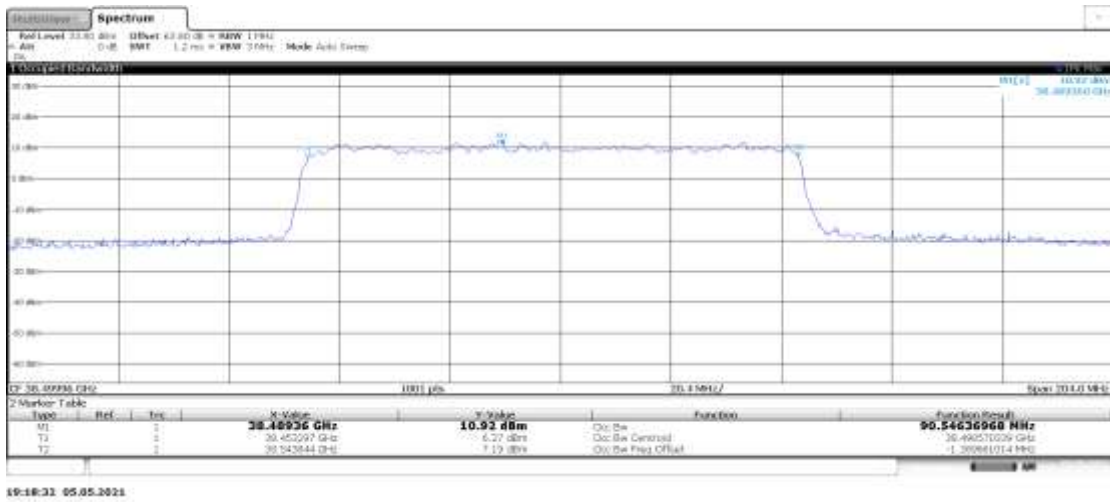
n260, 100MHz Bandwidth, QPSK (99% BW)

n260, 100MHz (99%)

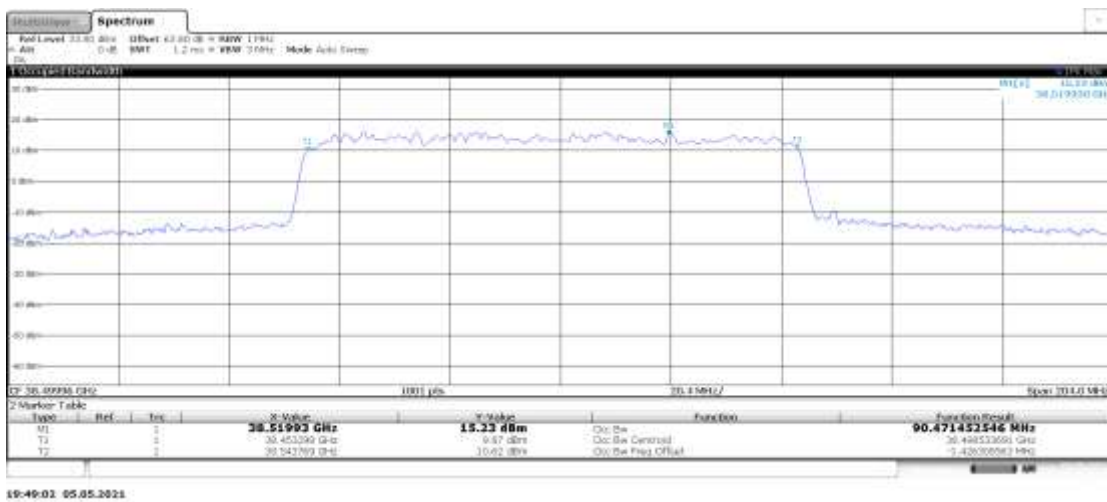
Module2, Beam ID:167, PUSCH DFT			
Frequency(MHz)	Occupied Bandwidth (99%) (kHz)		
38499.96	QPSK	16QAM	64QAM
	90.47	/	/

n260, 100MHz Bandwidth, QPSK (99% BW)

n261, 50MHz (99%)

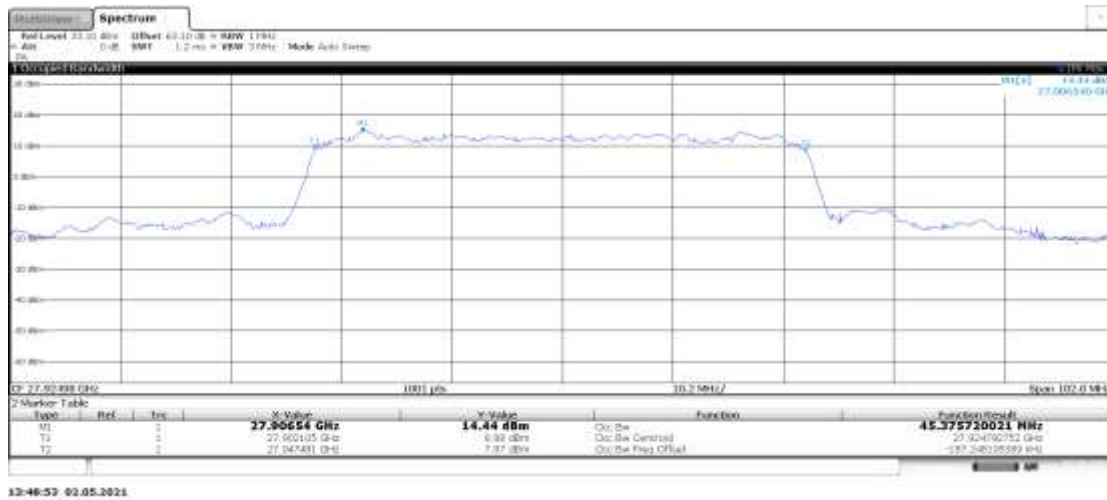
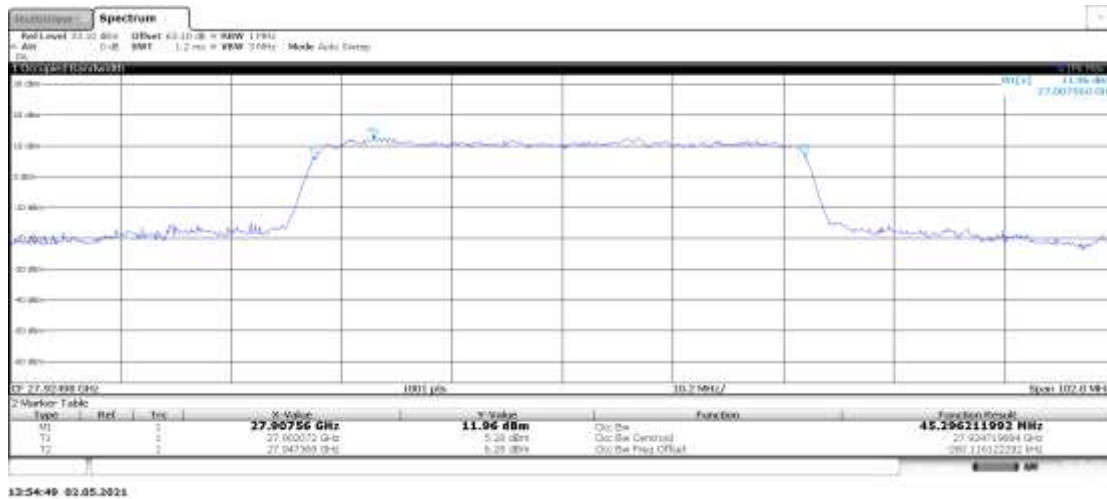
Module0, Beam ID:47, CP-OFDM			
Frequency(MHz)	Occupied Bandwidth (99%) (kHz)		
27924.96	QPSK	16QAM	64QAM
	45.37	45.29	45.54

n261, 50MHz Bandwidth, QPSK (99% BW)

n261, 50MHz Bandwidth, 16QAM (99% BW)

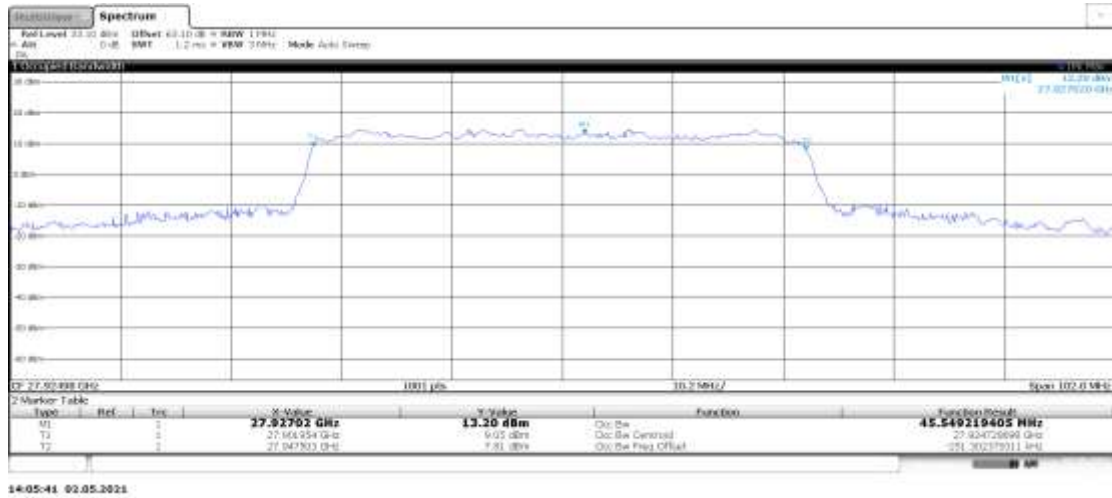
n261, 50MHz Bandwidth, 64QAM (99% BW)



n261, 100MHz (99%)

Module0, Beam ID:47, CP-OFDM			
Frequency(MHz)	Occupied Bandwidth (99%) (kHz)		
27924.96	QPSK	16QAM	64QAM
	93. 21	93. 17	93. 25

n261, 100MHz Bandwidth, QPSK (99% BW)

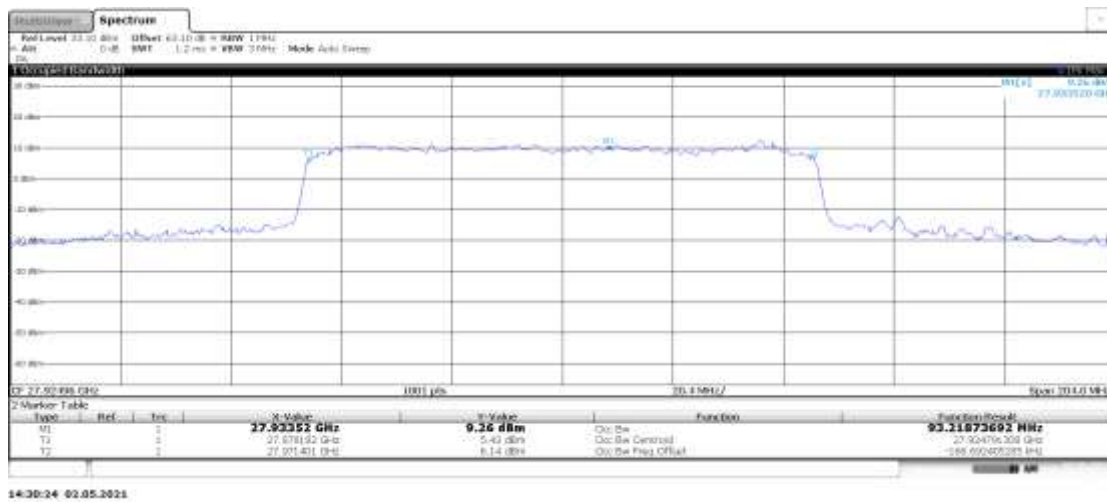

n261, 100MHz Bandwidth, 16QAM (99% BW)

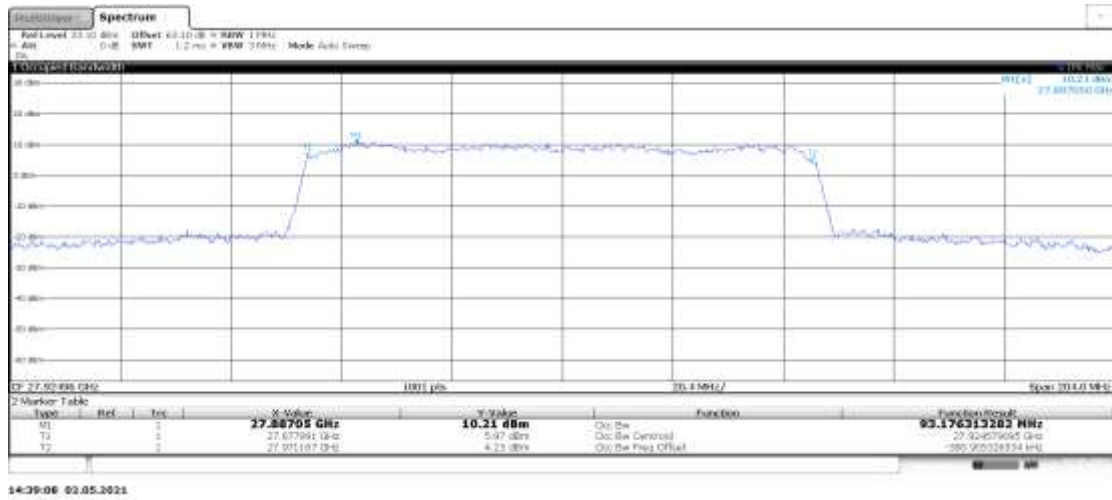

n261, 100MHz Bandwidth, 64QAM (99% BW)

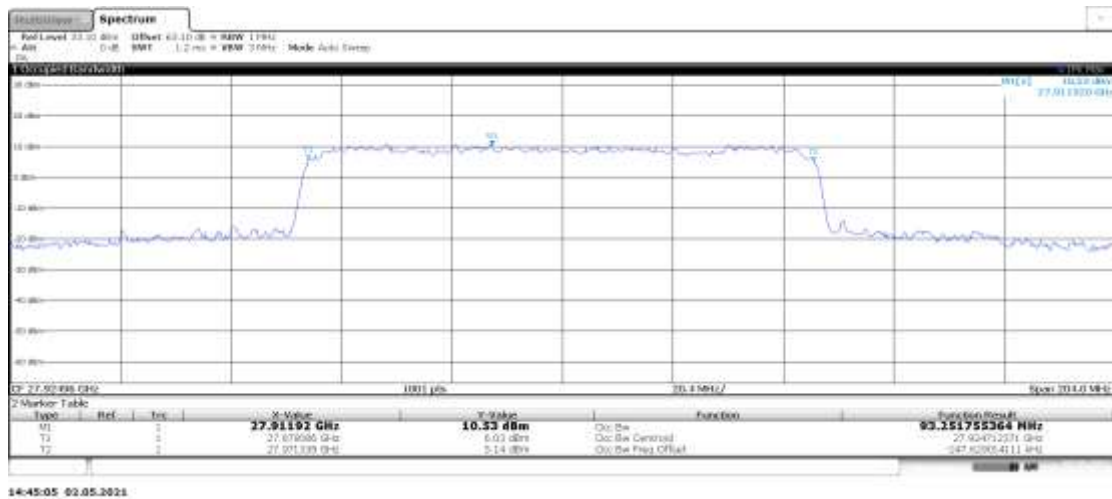

n261, 50MHz (99%)

Module0, Beam ID:47, PUSCH DFT			
Frequency(MHz)	Occupied Bandwidth (99%) (kHz)		
27924.96	QPSK	16QAM	64QAM
	46.38	46.66	46.03

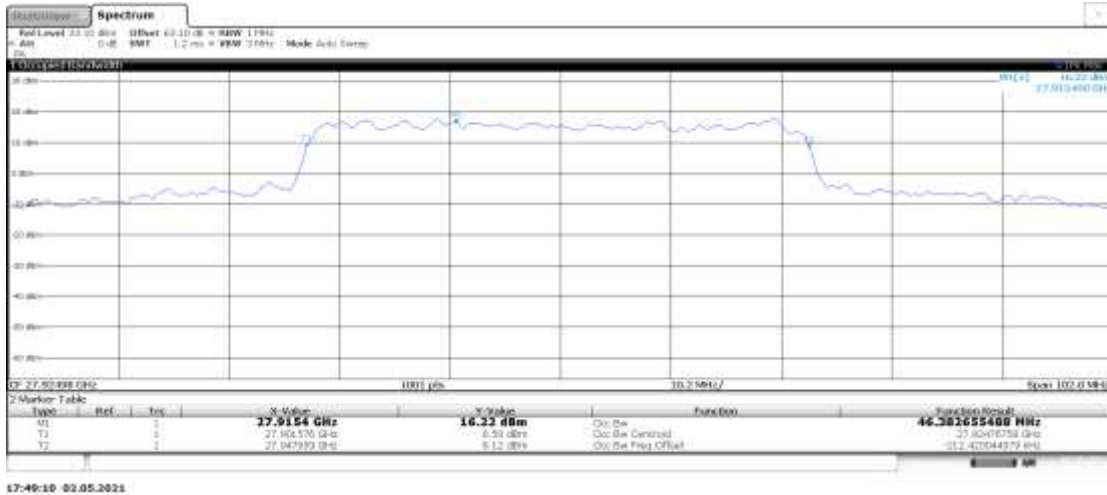
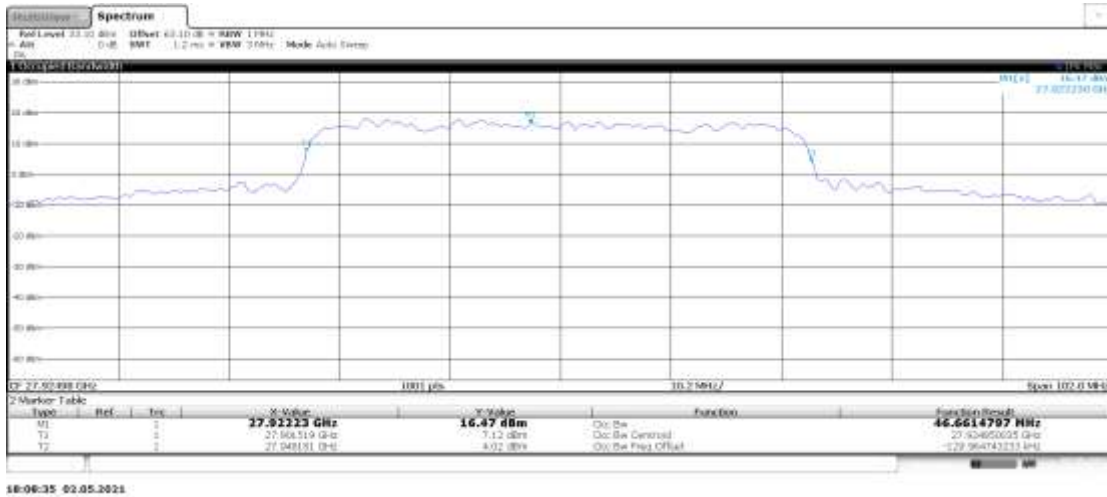
n261, 50MHz Bandwidth, QPSK (99% BW)

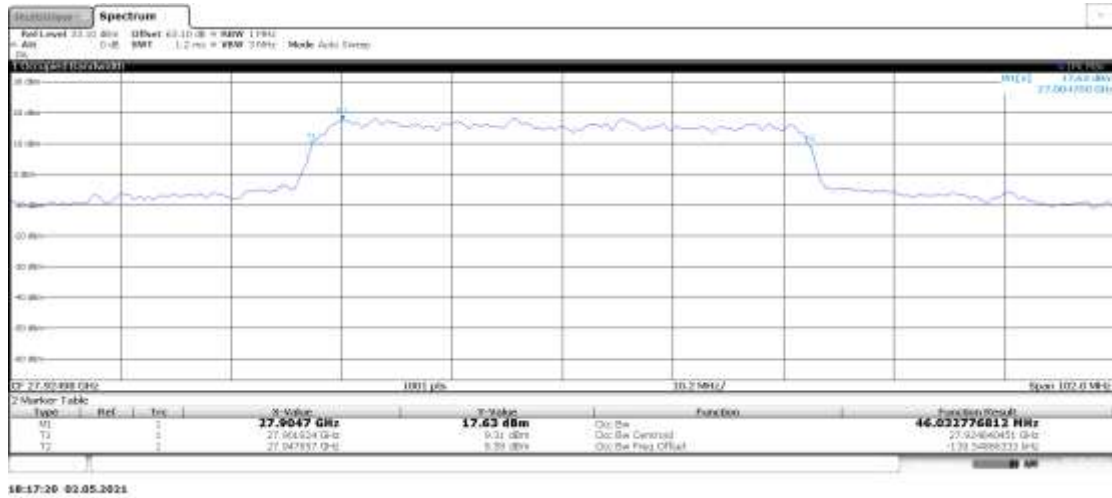
n261, 50MHz Bandwidth, 16QAM (99% BW)

n261, 50MHz Bandwidth, 64QAM (99% BW)

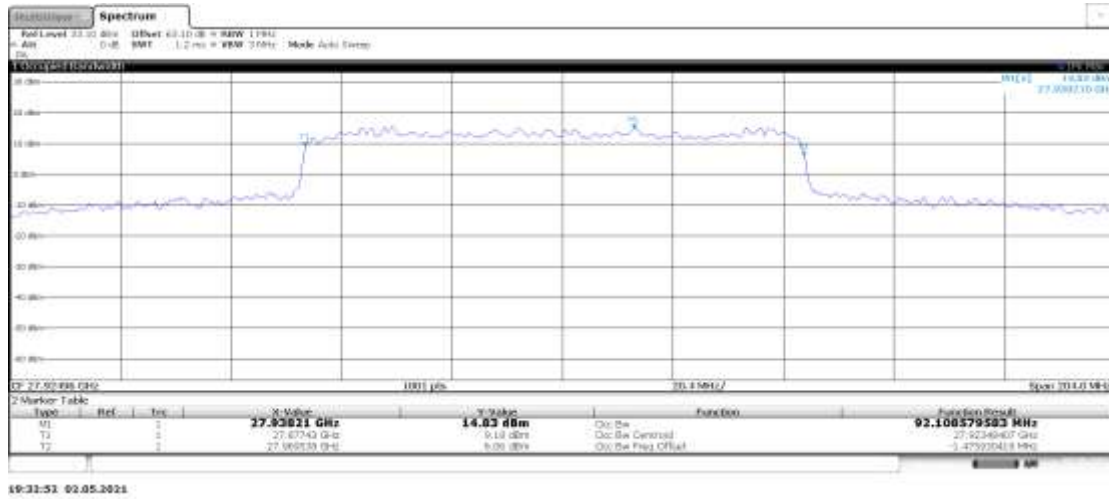
n261, 100MHz (99%)

Module0, Beam ID:47, PUSCH DFT			
Frequency(MHz)	Occupied Bandwidth (99%) (kHz)		
27924.96	QPSK	16QAM	64QAM
	92.10	92.03	93.79

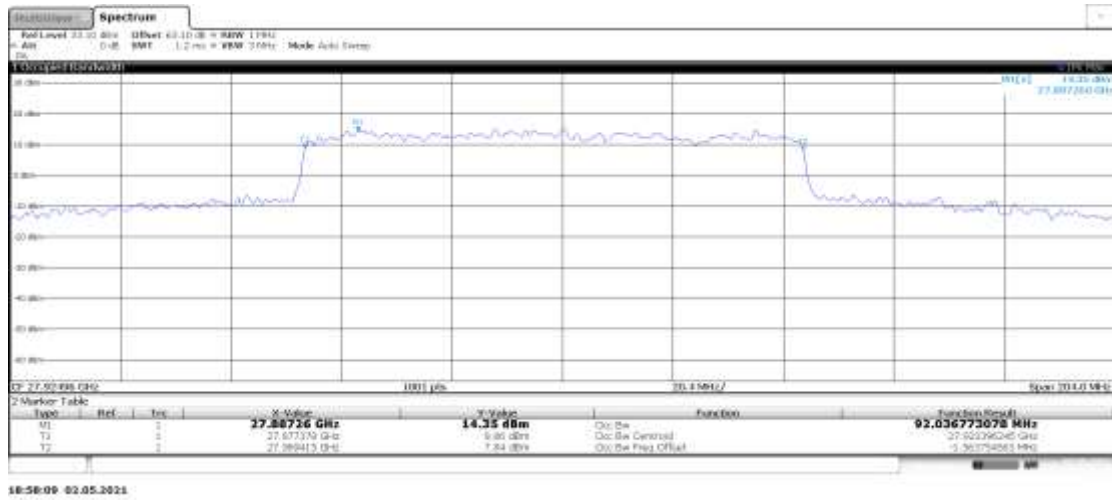
n261, 100MHz Bandwidth, QPSK (99% BW)

n261, 100MHz Bandwidth, 16QAM (99% BW)



n261, 100MHz Bandwidth, 64QAM (99% BW)

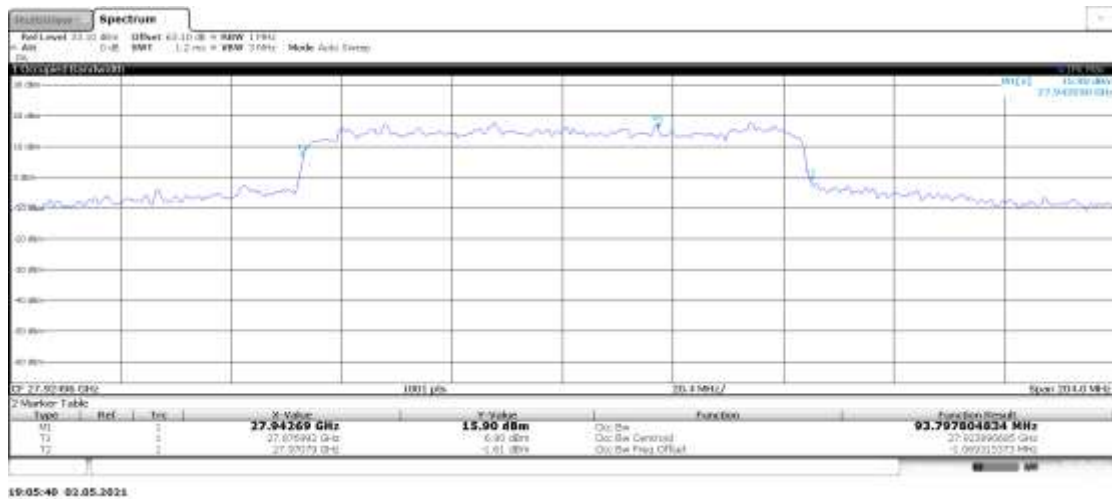

n261, 100MHz (99%)

Module1, Beam ID:29, PUSCH DFT			
Frequency(MHz)	Occupied Bandwidth (99%) (kHz)		
27924.96	QPSK	16QAM	64QAM
	90.94		

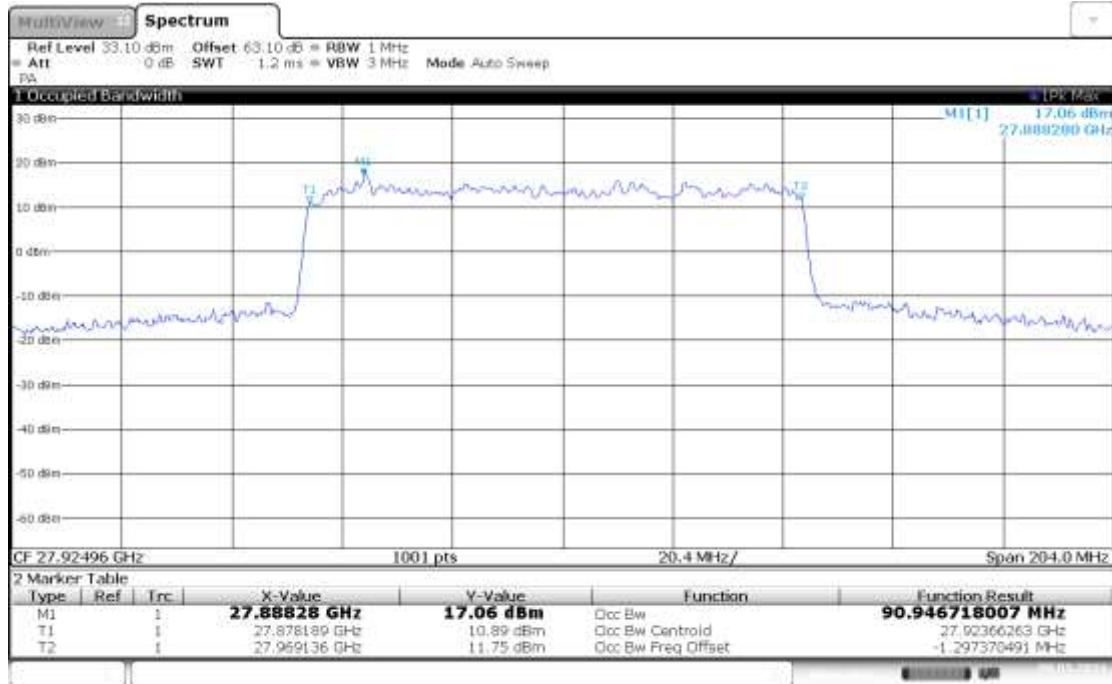
n261, 100MHz Bandwidth, 64QAM (99% BW)

02:36:05 08.05.2021

n261, 100MHz (99%)

Module2, Beam ID:52, PUSCH DFT			
Frequency(MHz)	Occupied Bandwidth (99%) (kHz)		
27924.96	QPSK	16QAM	64QAM
	90.80		

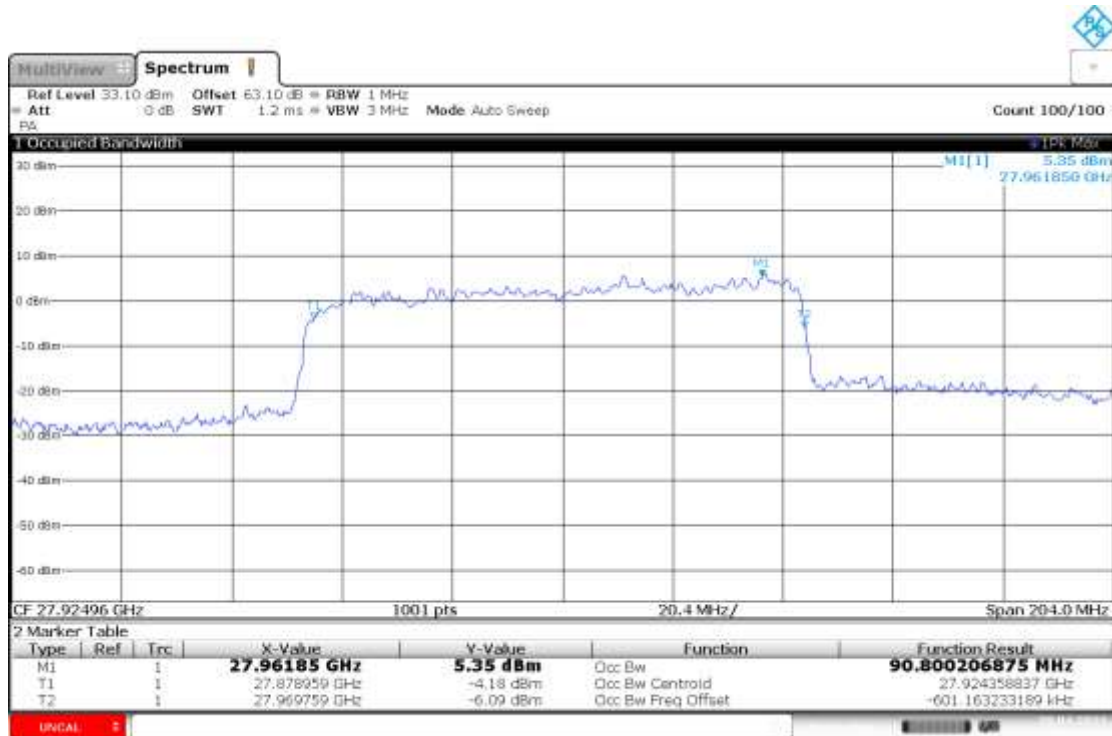
n261, 100MHz Bandwidth, 64QAM (99% BW)

09:10:40 30.04.2021

n261, 50MHz (99%)

Module0, Beam ID:175, CP-OFDM			
Frequency(MHz)	Occupied Bandwidth (99%) (kHz)		
27924.96	QPSK	16QAM	64QAM
	45.50	45.55	45.41

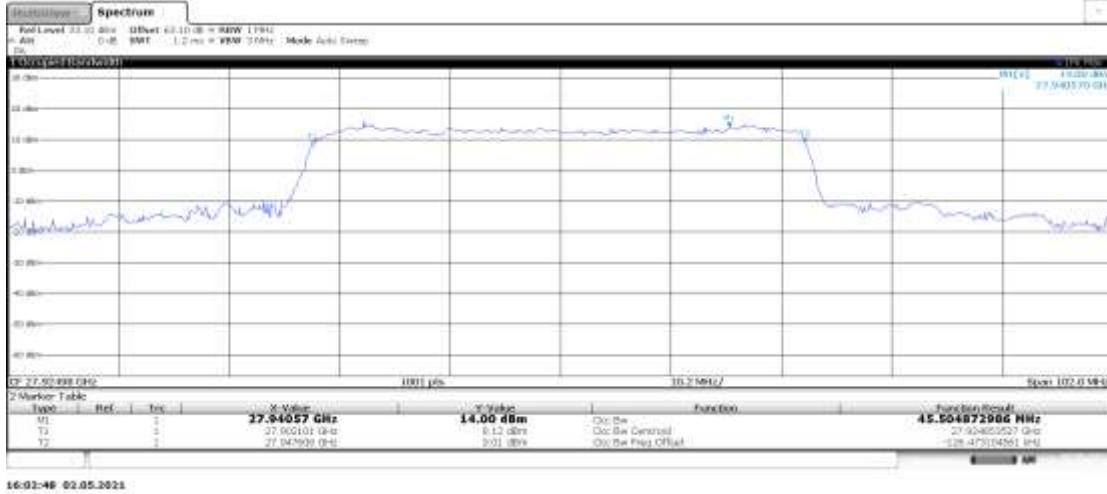
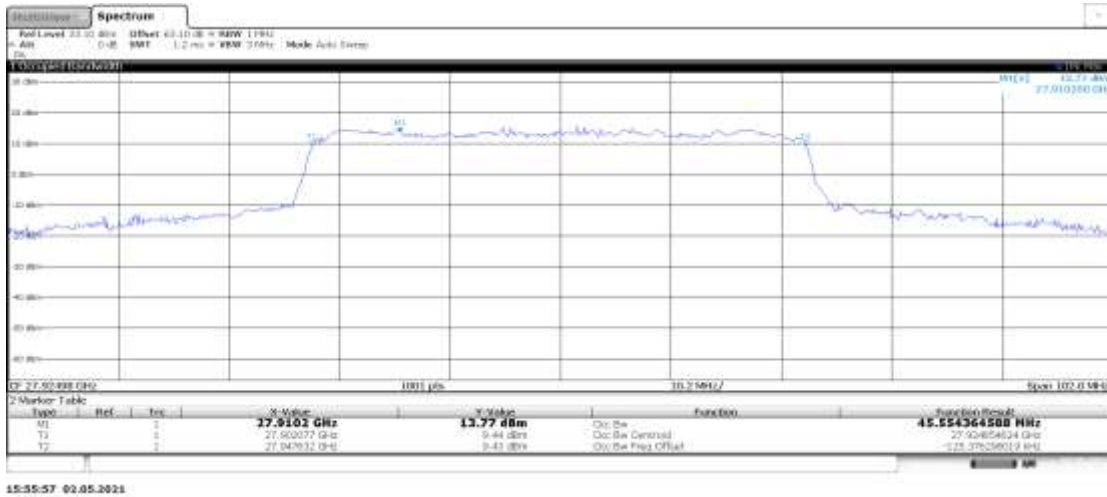
n261, 50MHz Bandwidth, QPSK (99% BW)

n261, 50MHz Bandwidth, 16QAM (99% BW)

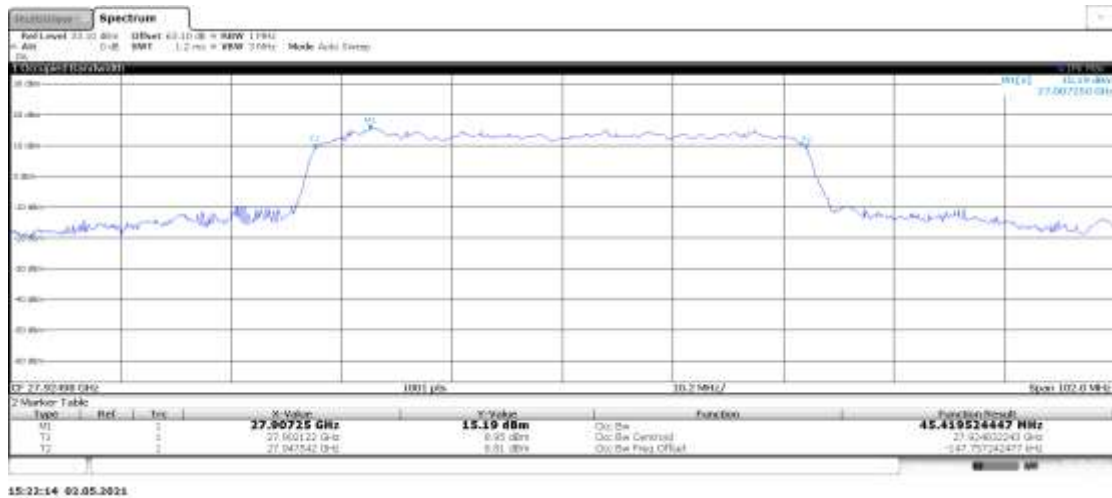
n261, 50MHz Bandwidth, 64QAM (99% BW)



n261, 100MHz (99%)

Module0, Beam ID:175, CP-OFDM			
Frequency(MHz)	Occupied Bandwidth (99%) (kHz)		
27924.96	QPSK	16QAM	64QAM
	93.17	92.95	93.03

n261, 100MHz Bandwidth, QPSK (99% BW)

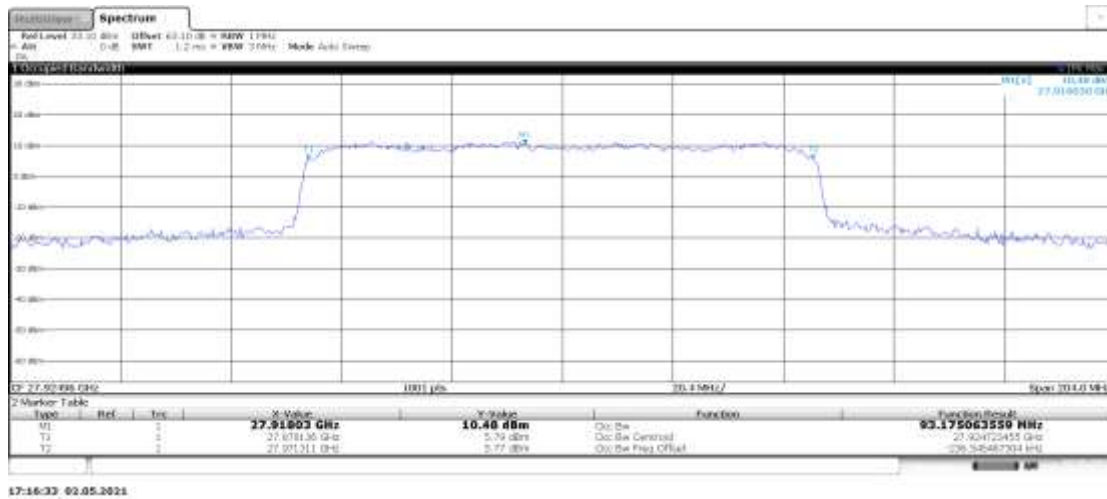

n261, 100MHz Bandwidth, 16QAM (99% BW)

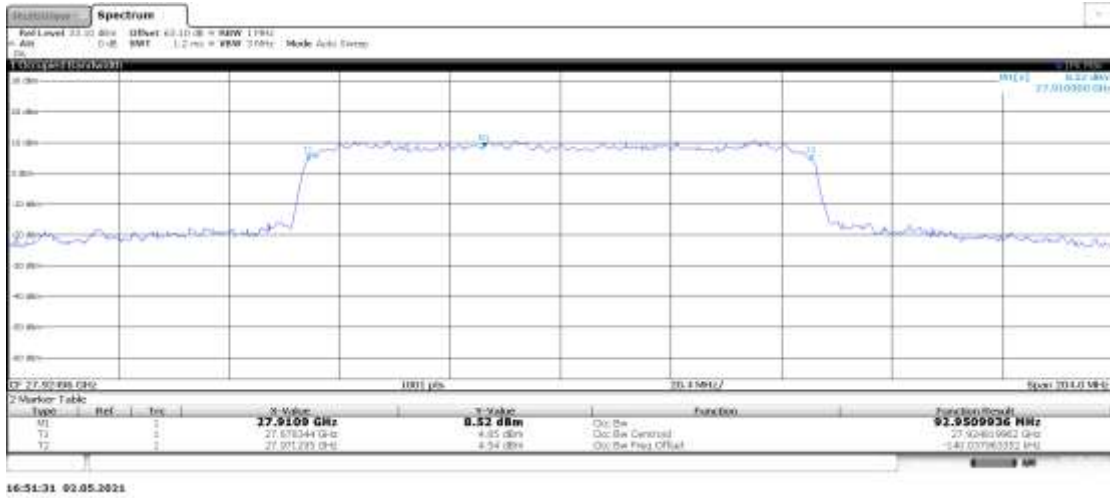

n261, 100MHz Bandwidth, 64QAM (99% BW)

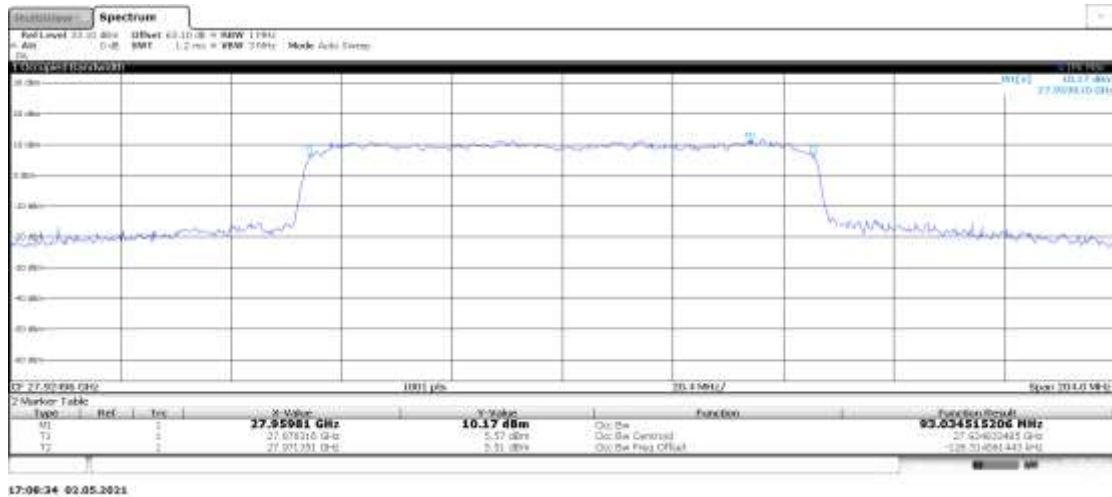

n261, 50MHz (99%)

Module0, Beam ID:175, PUSCH DFT			
Frequency(MHz)	Occupied Bandwidth (99%) (kHz)		
27924.96	QPSK	16QAM	64QAM
	46.64	46.67	46.87

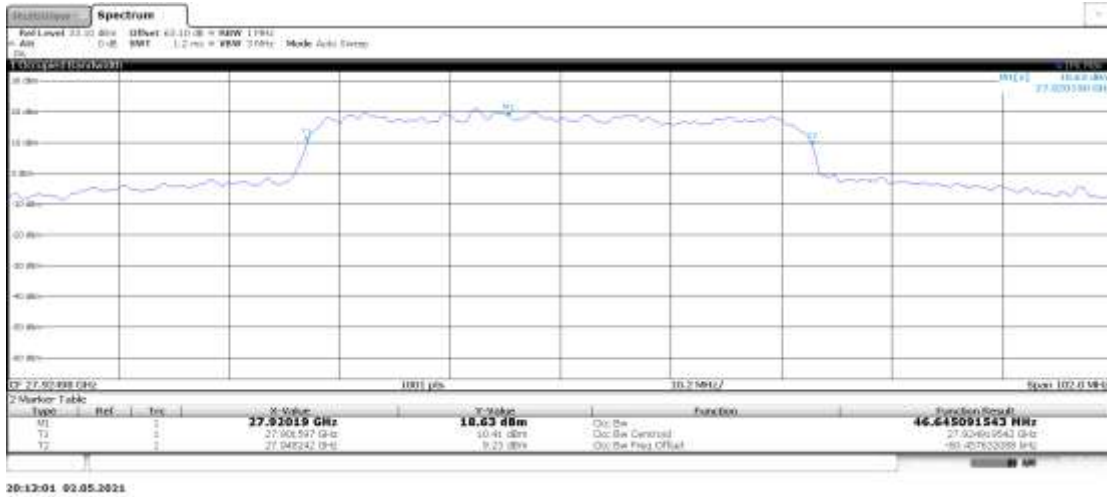
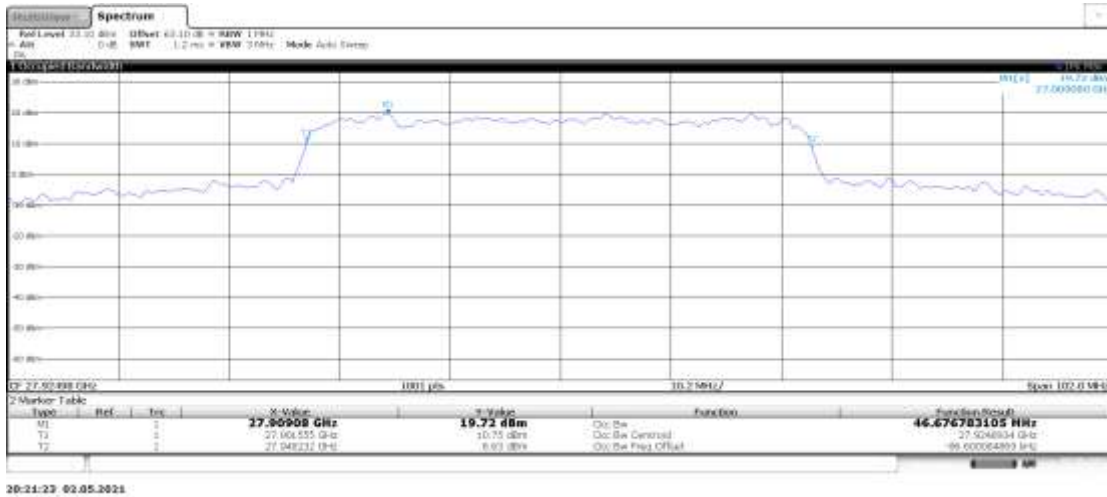
n261, 50MHz Bandwidth, QPSK (99% BW)

n261, 50MHz Bandwidth, 16QAM (99% BW)

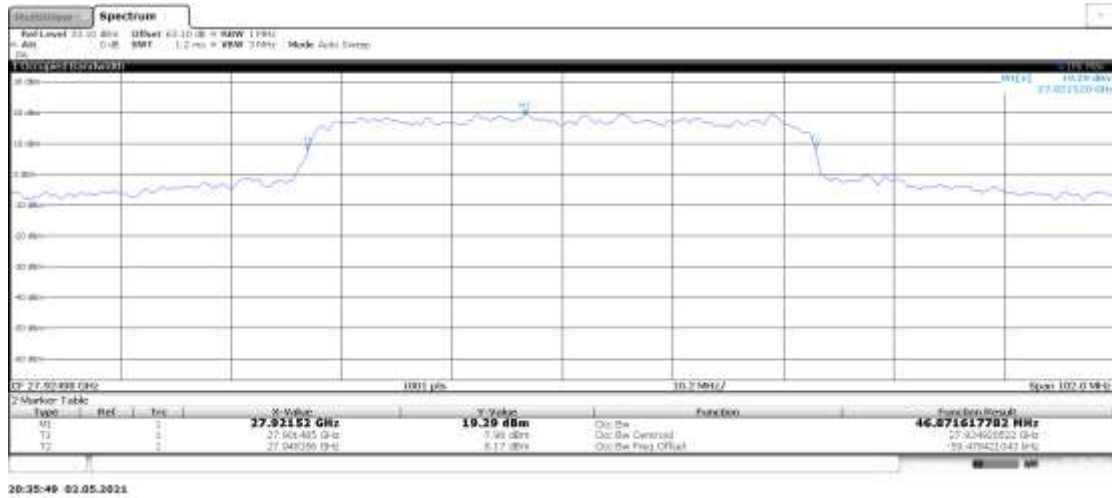
n261, 50MHz Bandwidth, 64QAM (99% BW)



n261, 100MHz (99%)

Module0, Beam ID:175, PUSCH DFT			
Frequency(MHz)	Occupied Bandwidth (99%) (kHz)		
27924.96	QPSK	16QAM	64QAM
	92.13	93.09	92.42

n261, 100MHz Bandwidth, QPSK (99% BW)

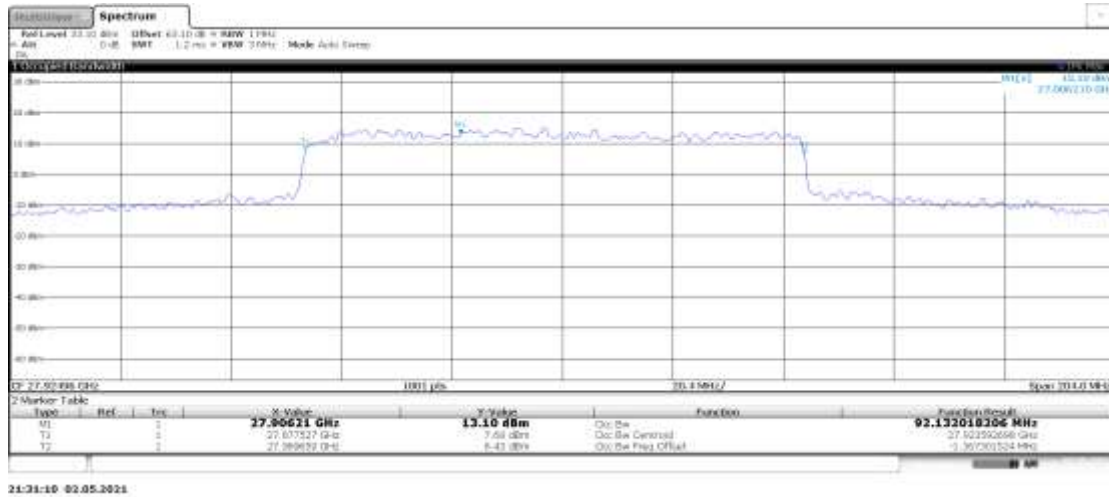

n261, 100MHz Bandwidth, 16QAM (99% BW)

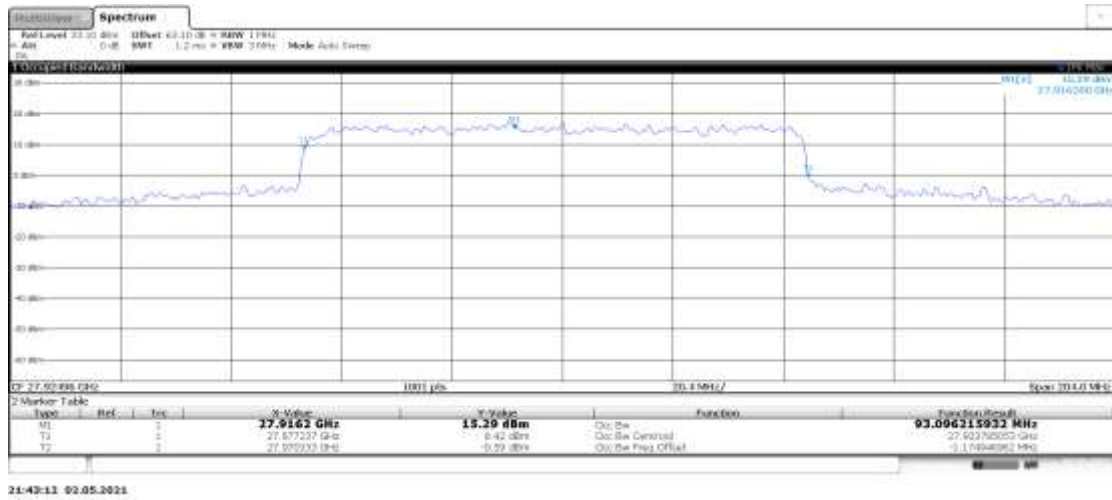

n261, 100MHz Bandwidth, 64QAM (99% BW)

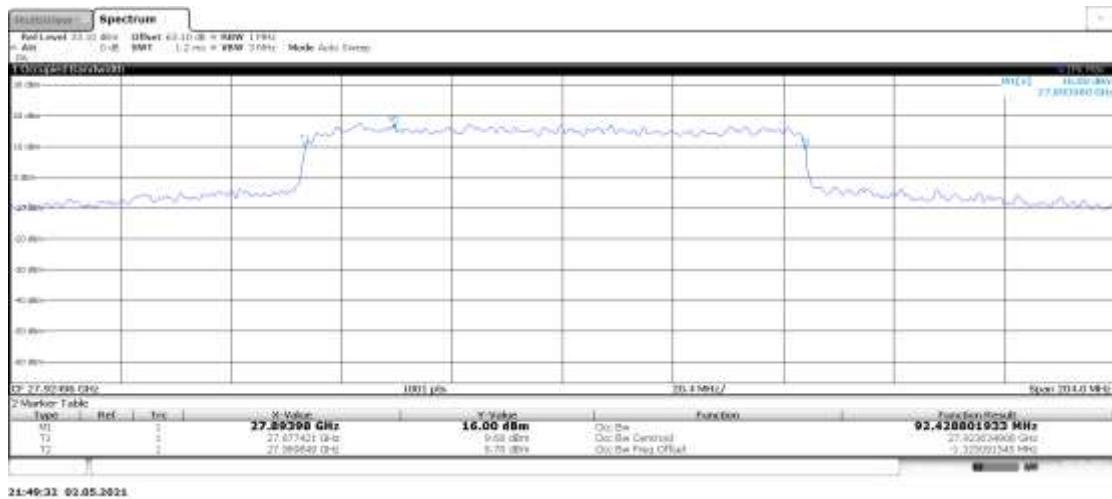

n261, 50MHz (99%)

Module1, Beam ID:157, PUSCH DFT			
Frequency(MHz)	Occupied Bandwidth (99%) (kHz)		
27924.96	QPSK	16QAM	64QAM
		47.06	

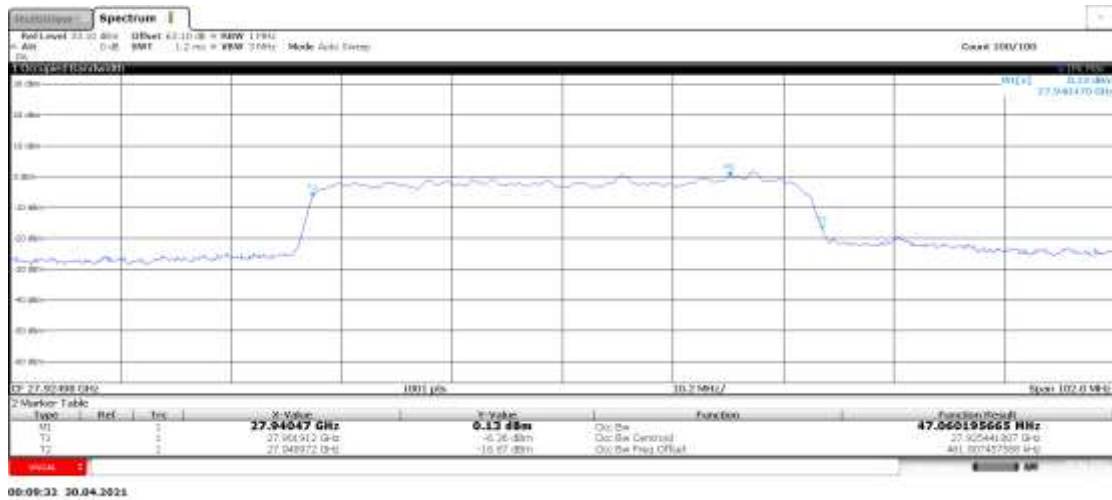
n261, 50MHz Bandwidth, QPSK (99% BW)

n261, 50MHz (99%)

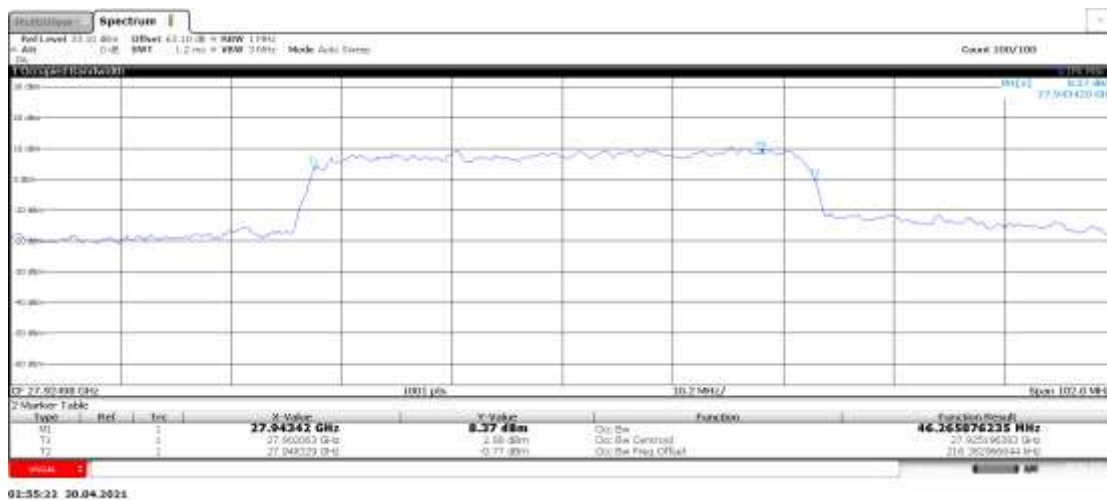
Module2, Beam ID:180, PUSCH DFT			
Frequency(MHz)	Occupied Bandwidth (99%) (kHz)		
27924.96	QPSK	16QAM	64QAM
		46.26	

n261, 50MHz Bandwidth, QPSK (99% BW)



A.5 Band Edge Compliance

A.5.1 Measurement limit

Part 30.203 the total radiated power of any emission outside a licensee's frequency block shall be -13 dBm/MHz or lower. However, in the bands immediately outside and adjacent to the licensee's frequency block, having a bandwidth equal to 10 percent of the channel bandwidth, the conductive power or the total radiated power of any emission shall be -5 dBm/MHz or lower.

A.5.2 Measurement result

Only the worst case result is given below

n260

LOW BAND EDGE BLOCK-50MHz-100%RB

Module0, Beam ID:33, CP-OFDM							
	BANDWIDTH	FREQUENCY (MHz)	CHANNEL	SCS	MODULATION	Peak (dBm)	Limit (dBm)
n260	50MHz	37025.04	LOW	120kHz	QPSK	-15.44	-5
n260	50MHz	37025.04	LOW	120kHz		-17.21	-13



15:47:53 13.04.2021

HIGH BAND EDGE BLOCK-50MHz-100%RB

Module0, Beam ID:33, CP-OFDM							
	BANDWID TH	FREQUENC Y (MHz)	CHAN NEL	SCS	MODULATI ON	Peak (dBm)	Limit (dBm)
n260	50MHz	39975	HIGH	120kHz	QPSK	-18.25	-5
n260	50MHz	39975	HIGH	120kHz		-19.45	-13

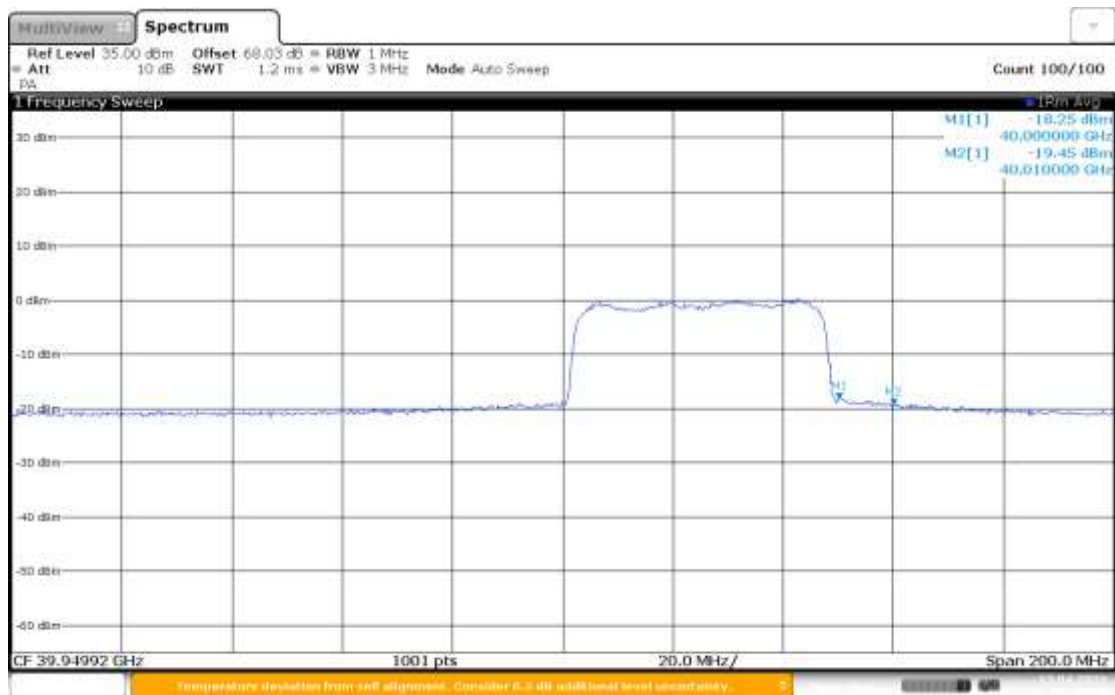

17:34:48 13.04.2021

LOW BAND EDGE BLOCK-50MHz-1RB

Module0, Beam ID:33, CP-OFDM							
	BANDWID TH	FREQUENC Y (MHz)	CHAN NEL	SCS	MODULATI ON	Peak (dBm)	Limit (dBm)
n260	50MHz	37025.04	LOW	120kHz	64QAM	-18.46	-5
n260	50MHz	37025.04	LOW	120kHz		-25.01	-13

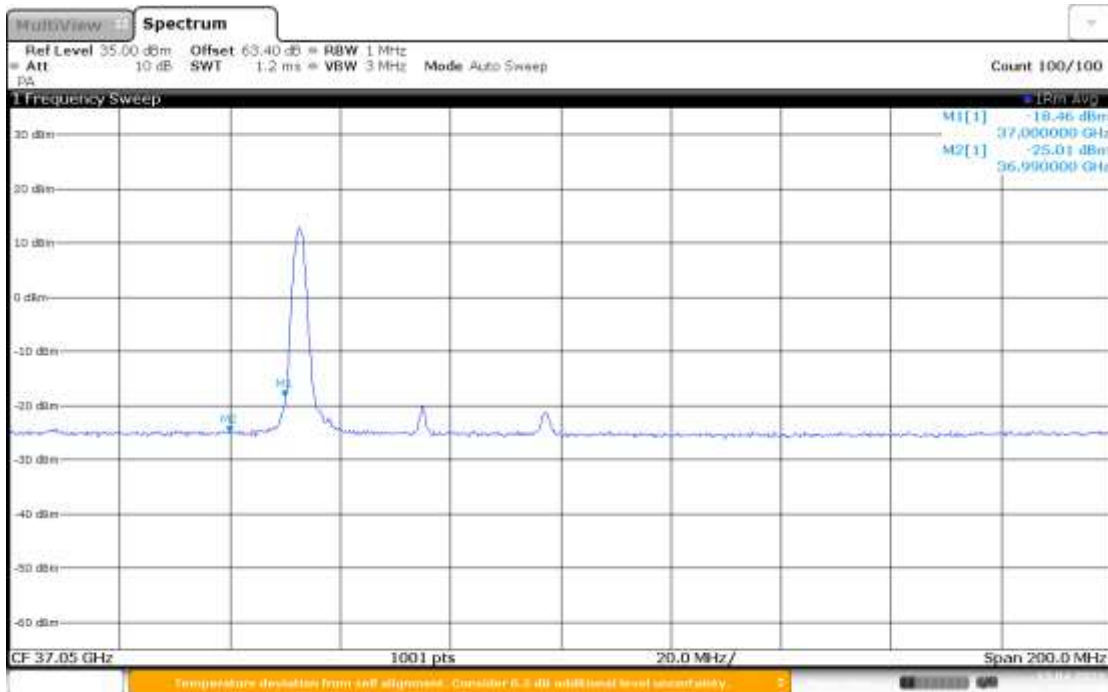

18:20:36 13.04.2021

HIGH BAND EDGE BLOCK-50MHz-1RB

Module0, Beam ID:33, CP-OFDM							
	BANDWIDTH	FREQUENCY (MHz)	CHANNEL	SCS	MODULATION	Peak (dBm)	Limit (dBm)
n260	50MHz	39975	HIGH	120kHz	64QAM	-13.25	-5
n260	50MHz	39975	HIGH	120kHz		-20.68	-13

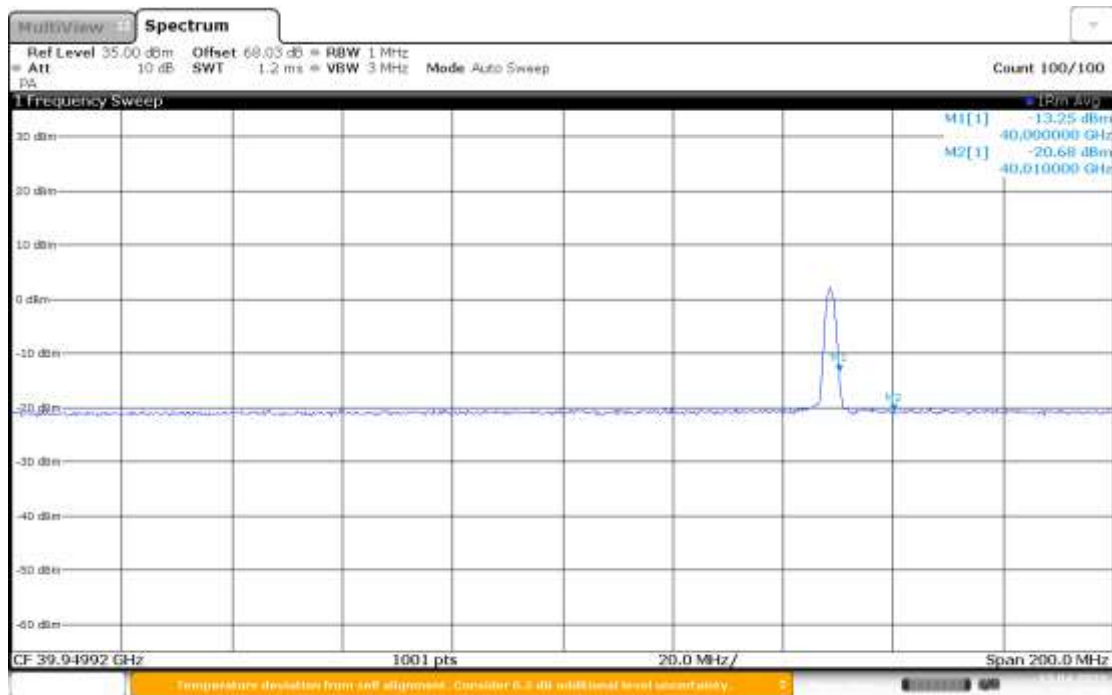

LOW BAND EDGE BLOCK-100MHz-100%RB

Module0, Beam ID:33, CP-OFDM							
	BANDWID TH	FREQUENC Y (MHz)	CHAN NEL	SCS	MODULATI ON	Peak (dBm)	Limit (dB m)
n260	100MHz	37050	LOW	120kHz	16QAM	-18.00	-5
n260	100MHz	37050	LOW	120kHz		-18.12	-13

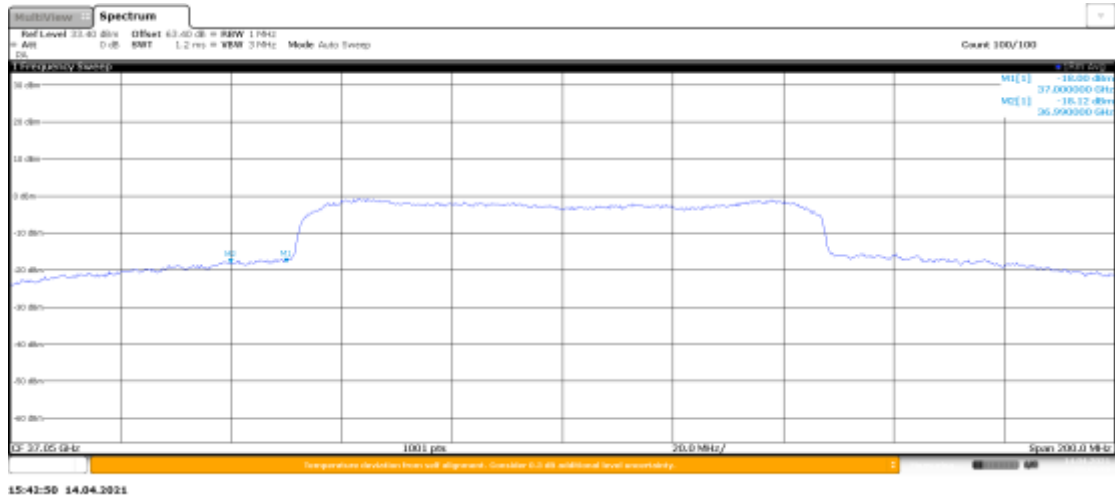

HIGH BAND EDGE BLOCK-100MHz-100%RB

Module0, Beam ID:33, CP-OFDM							
	BANDWID TH	FREQUENC Y (MHz)	CHAN NEL	SCS	MODULATI ON	Peak (dBm)	Limit (dB m)
n260	100MHz	39949.92	HIGH	120kHz	16QAM	-23.17	-5
n260	100MHz	39949.92	HIGH	120kHz		-23.92	-13

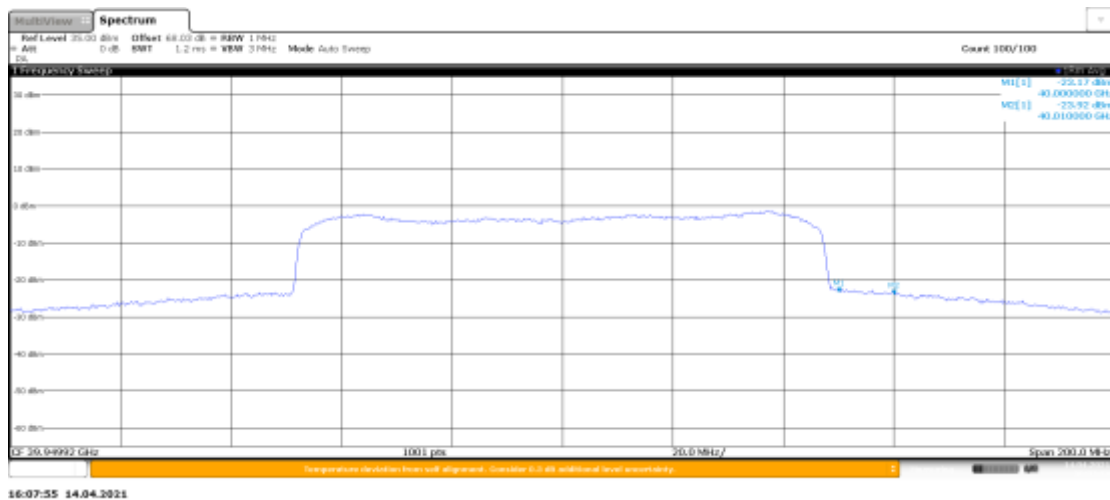

LOW BAND EDGE BLOCK-100MHz-1RB

Module0, Beam ID:33, CP-OFDM							
	BANDWIDTH	FREQUENCY	CHANNEL	SCS	MODULATION	Peak (dBm)	Limit (dBm)
n260	100MHz	37050	LOW	120kHz	QPSK	-20.40	-5
n260	100MHz	37050	LOW	120kHz		-25.07	-13

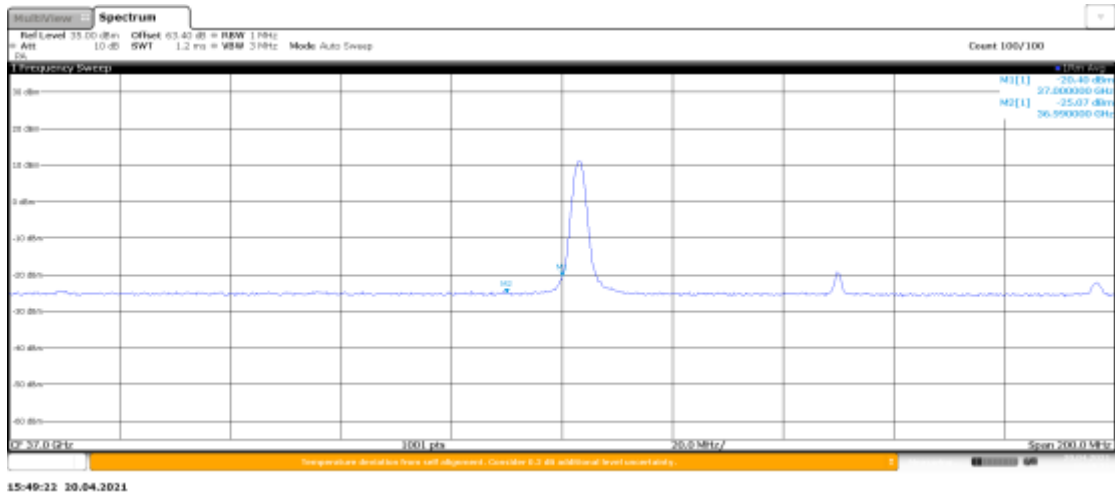

HIGH BAND EDGE BLOCK-100MHz-1RB

Module0, Beam ID:33, CP-OFDM							
	BANDWIDTH	FREQUENCY	CHANNEL	SCS	MODULATION	Peak (dBm)	Limit (dBm)
n260	100MHz	39949.92	HIGH	120kHz	QPSK	-17.11	-5
n260	100MHz	39949.92	HIGH	120kHz		-20.58	-13

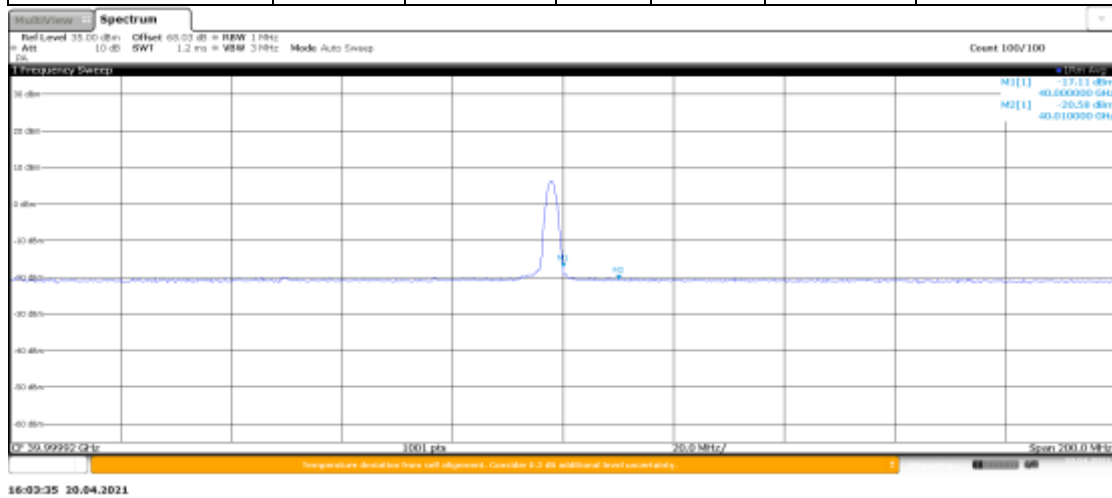

LOW BAND EDGE BLOCK-50MHz-100%RB

Module0, Beam ID:33, PUSCH DFT							
	BANDWID TH	FREQUENC Y (MHz)	CHAN NEL	SCS	MODULATI ON	Peak (dBm)	Limit (dBm)
n260	50MHz	37025.04	LOW	120kHz	16QAM	-14.45	-5
n260	50MHz	37025.04	LOW	120kHz		-15.05	-13



18:27:36 19.04.2021

HIGH BAND EDGE BLOCK-50MHz-100%RB

Module0, Beam ID:33, PUSCH DFT							
	BANDWID TH	FREQUENC Y (MHz)	CHAN NEL	SCS	MODULATI ON	Peak (dBm)	Limit (dBm)
n260	50MHz	39975	HIGH	120kHz	16QAM	-12.42	-5
n260	50MHz	39975	HIGH	120kHz		-13.35	-13



18:11:11 19.04.2021

LOW BAND EDGE BLOCK-50MHz-1RB

Module0, Beam ID:33, PUSCH DFT							
	BANDWIDTH	FREQUENCY (MHz)	CHANNEL	SCS	MODULATION	Peak (dBm)	Limit (dBm)
n260	50MHz	37025.04	LOW	120kHz	64QAM	-24.57	-5
n260	50MHz	37025.04	LOW	120kHz		-25.09	-13

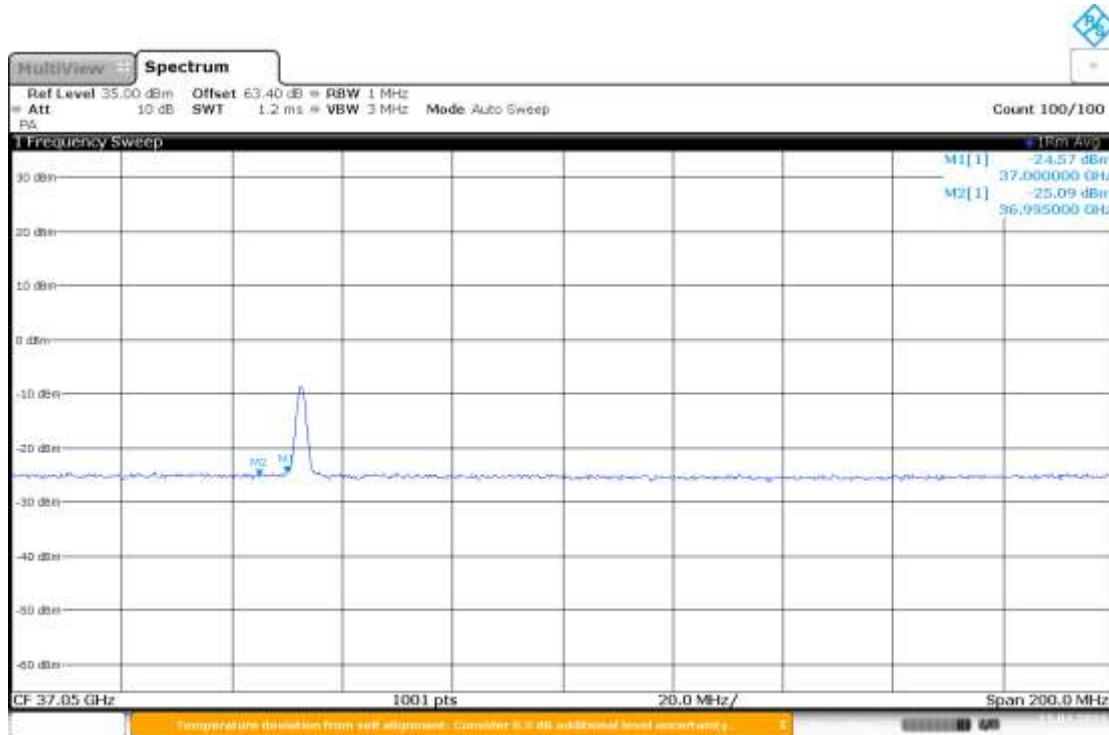

16:36:05 15.04.2021

HIGH BAND EDGE BLOCK-50MHz-1RB

Module0, Beam ID:33, PUSCH DFT							
	BANDWID TH	FREQUENC Y (MHz)	CHAN NEL	SCS	MODULATI ON	Peak (dBm)	Limit (dBm)
n260	50MHz	39975	HIGH	120kHz	64QAM	-9.11	-5
n260	50MHz	39975	HIGH	120kHz		-23.01	-13

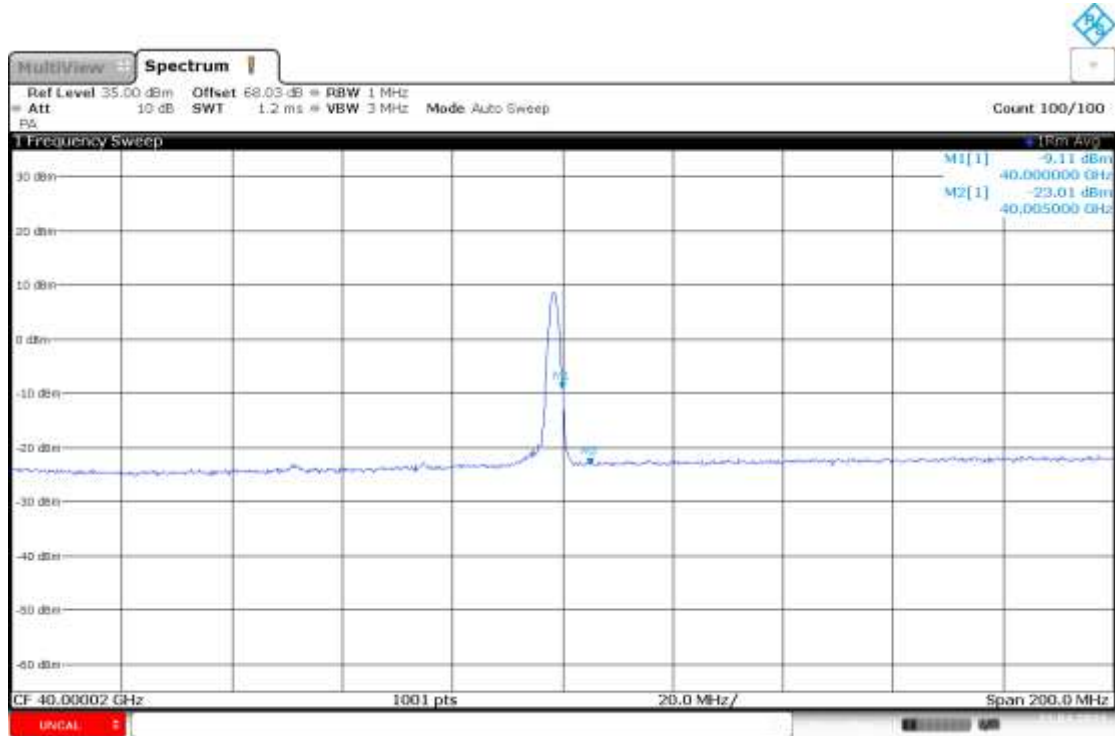

18:44:09 21.04.2021

LOW BAND EDGE BLOCK-100MHz-100%RB

Module0, Beam ID:33, PUSCH DFT							
	BANDWID TH	FREQUENC Y (MHz)	CHAN NEL	SCS	MODULATI ON	Peak (dBm)	Limit (dBm)
n260	100MHz	37050	LOW	120kHz	QPSK	-16.96	-5
n260	100MHz	37050	LOW	120kHz		-18.97	-13

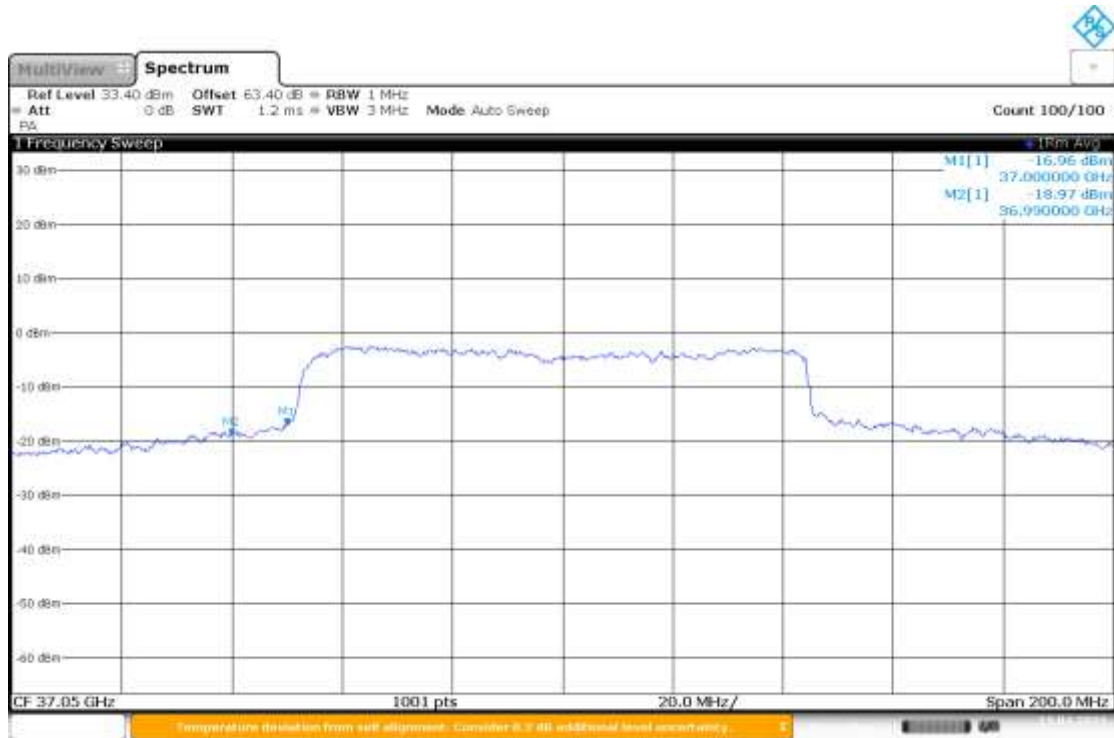

19:56:09 15.04.2021

HIGH BAND EDGE BLOCK-100MHz-100%RB

Module0, Beam ID:33, PUSCH DFT							
	BANDWID TH	FREQUENC Y (MHz)	CHAN NEL	SCS	MODULATI ON	Peak (dBm)	Limit (dBm)
n260	100MHz	39949.92	HIGH	120kHz	QPSK	-29.46	-5
n260	100MHz	39949.92	HIGH	120kHz		-29.67	-13

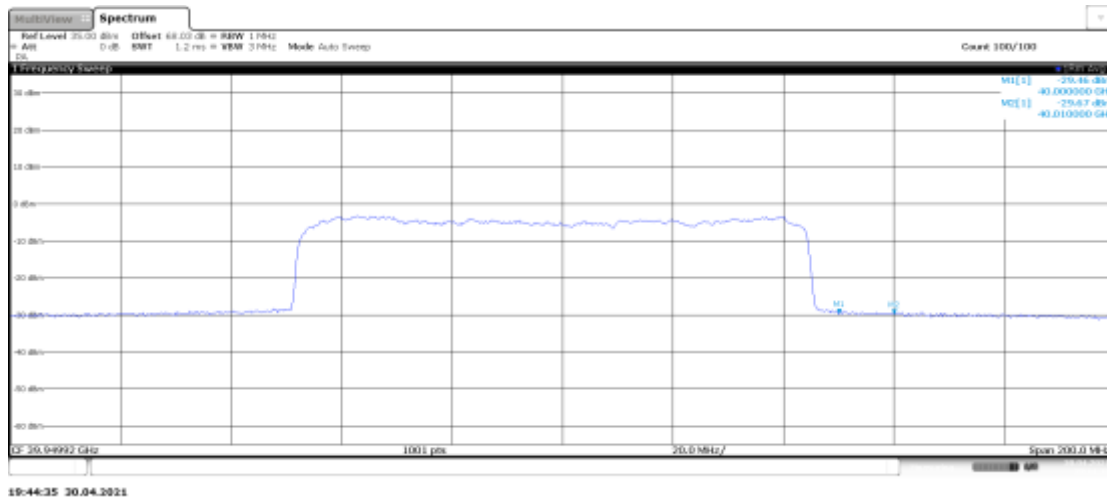

19:44:25 30.04.2021

LOW BAND EDGE BLOCK-50MHz-1RB

Module0, Beam ID:33, PUSCH DFT							
	BANDWID TH	FREQUENC Y (MHz)	CHAN NEL	SCS	MODULATI ON	Peak (dBm)	Limit (dB m)
n260	100MHz	37050	LOW	120kHz	16QAM	-15.42	-5
n260	100MHz	37050	LOW	120kHz		-24.57	-13

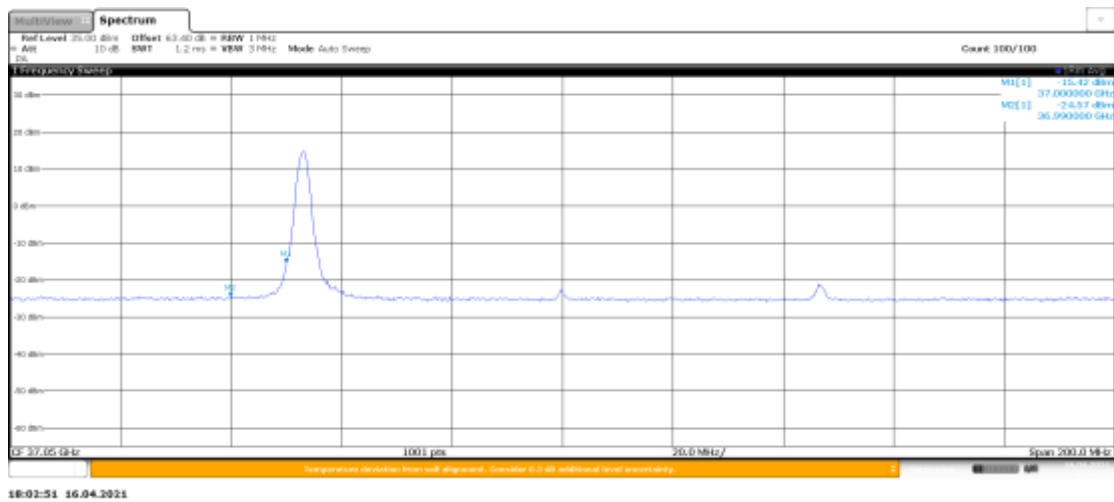

HIGH BAND EDGE BLOCK-100MHz-1RB

Module0, Beam ID:33, PUSCH DFT							
	BANDWID TH	FREQUENC Y (MHz)	CHAN NEL	SCS	MODULATI ON	Peak (dBm)	Limit (dB m)
n260	100MHz	39949.92	HIGH	120kHz	16QAM	-18.90	-5
n260	100MHz	39949.92	HIGH	120kHz		-20.47	-13

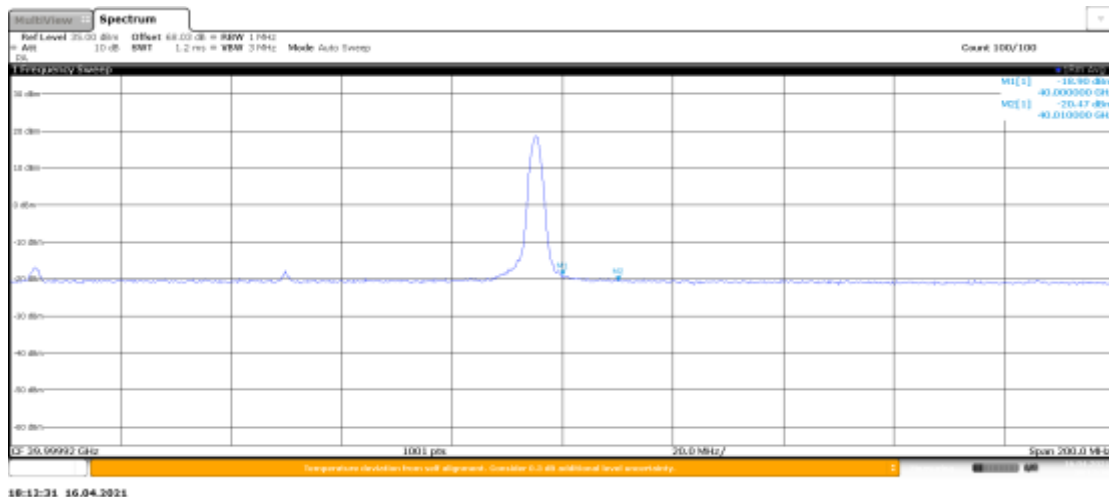

LOW BAND EDGE BLOCK-100MHz-100%RB

Module1, Beam ID:29, PUSCH DFT							
	BANDWIDTH	FREQUENCY (MHz)	CHANNEL	SCS	MODULATION	Peak (dBm)	Limit (dBm)
n260	100MHz	37050	LOW	120kHz	64QAM	-14.76	-5
n260	100MHz	37050	LOW	120kHz		-15.69	-13

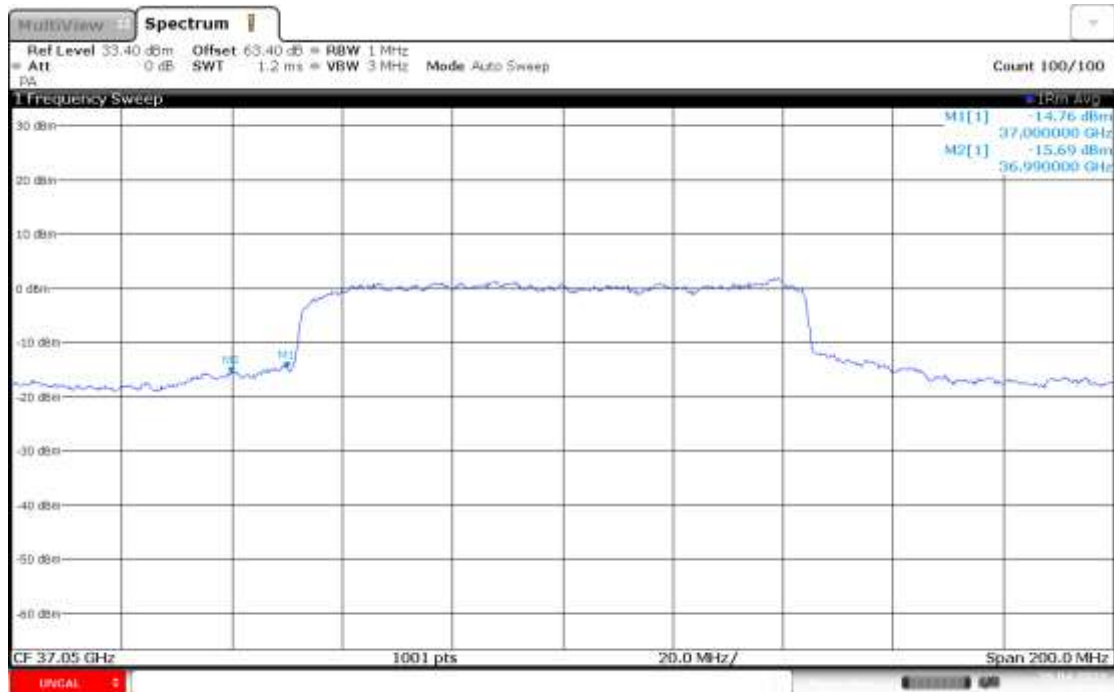

14:00:57 26.04.2021

HIGH BAND EDGE BLOCK-100MHz-100%RB

Module1, Beam ID:29, PUSCH DFT							
	BANDWIDTH	FREQUENCY (MHz)	CHANNEL	SCS	MODULATION	Peak (dBm)	Limit (dBm)
n260	100MHz	39949.92	HIGH	120kHz	64QAM	-13.57	-5
n260	100MHz	39949.92	HIGH	120kHz		-14.67	-13

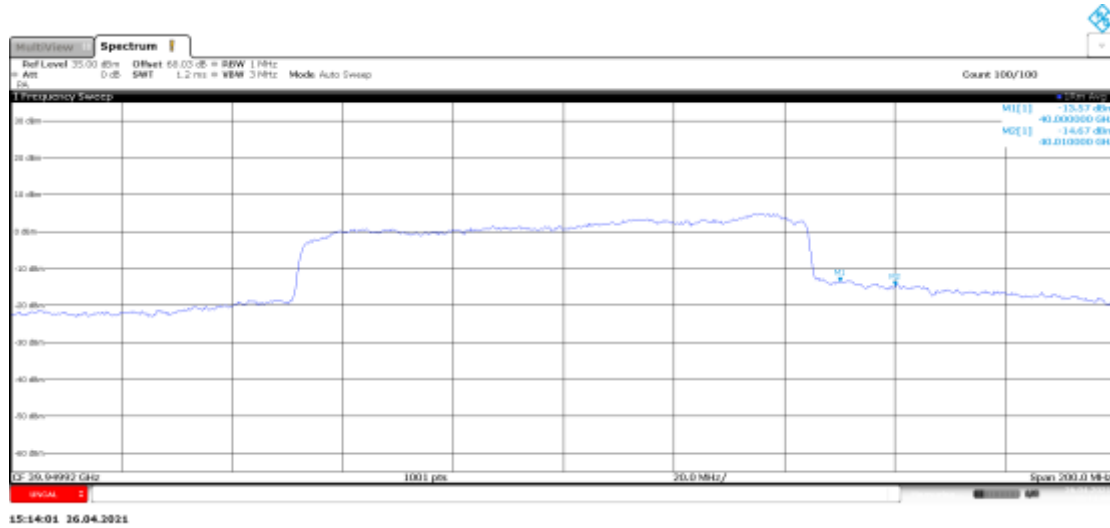

LOW BAND EDGE BLOCK-100MHz-100%RB

Module2, Beam ID:39, PUSCH DFT							
	BANDWIDTH	FREQUENCY (MHz)	CHANNEL	SCS	MODULATION	Peak (dBm)	Limit (dBm)
n260	100MHz	37050	LOW	120kHz	64QAM	-14.79	-5
n260	100MHz	37050	LOW	120kHz		-16.04	-13

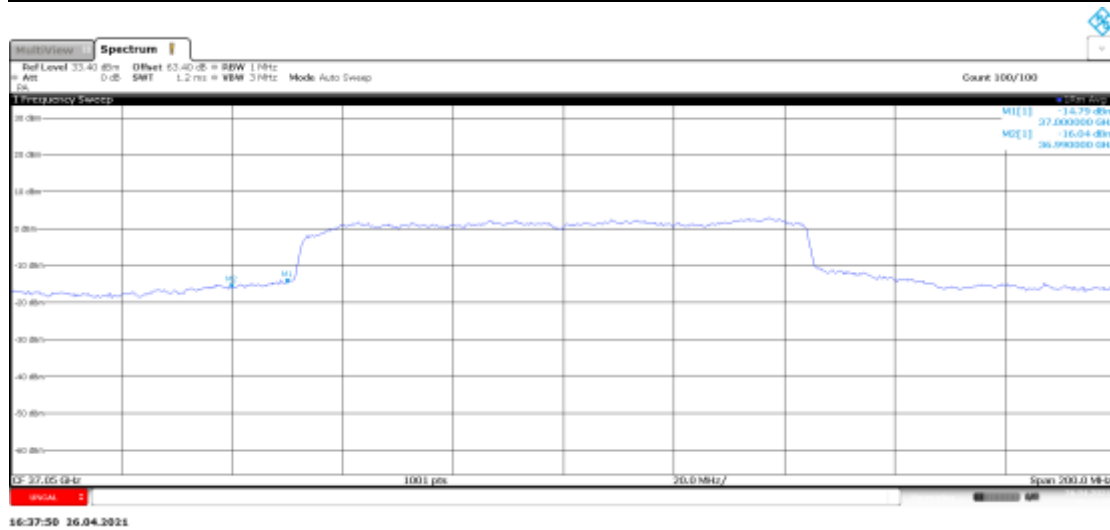

HIGH BAND EDGE BLOCK-100MHz-100%RB

Module2, Beam ID:39, PUSCH DFT							
	BANDWIDTH	FREQUENCY (MHz)	CHANNEL	SCS	MODULATION	Peak (dBm)	Limit (dBm)
n260	100MHz	39949.92	HIGH	120kHz	64QAM	-16.48	-5
n260	100MHz	39949.92	HIGH	120kHz		-16.89	-13

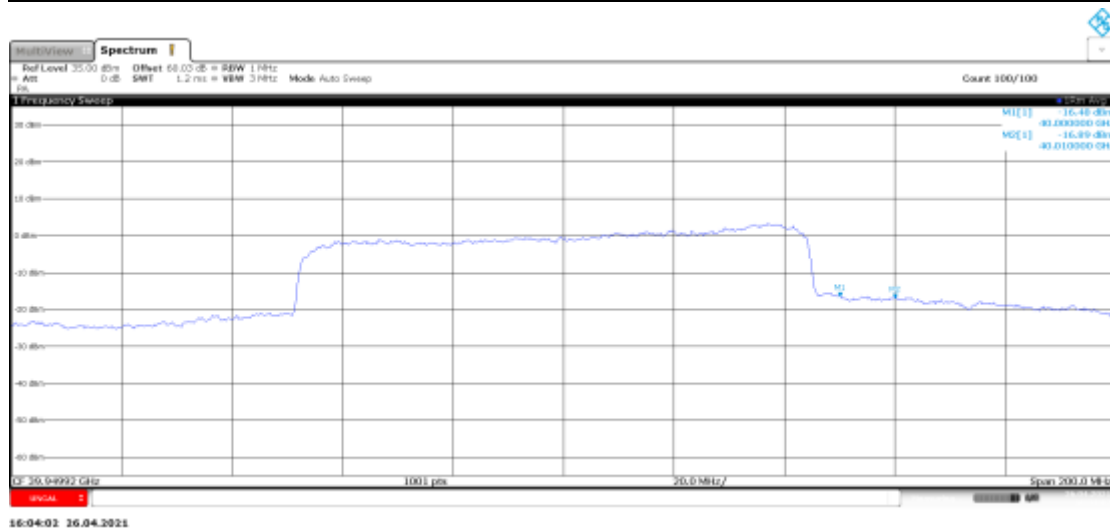

LOW BAND EDGE BLOCK-50MHz-100%RB

Module0, Beam ID:161, CP-OFDM							
	BANDWID TH	FREQUENC Y (MHz)	CHAN NEL	SCS	MODULATI ON	Peak (dBm)	Limit (dBm)
n260	50MHz	37025.04	LOW	120kHz	16QAM	-20.93	-5
n260	50MHz	37025.04	LOW	120kHz		-21.72	-13



16:23:51 19.04.2021

HIGH BAND EDGE BLOCK-50MHz-100%RB

Module0, Beam ID:161, CP-OFDM							
	BANDWID TH	FREQUENC Y (MHz)	CHAN NEL	SCS	MODULATI ON	Peak (dBm)	Limit (dBm)
n260	50MHz	39975	HIGH	120kHz	16QAM	-18.32	-5
n260	50MHz	39975	HIGH	120kHz		-19.17	-13

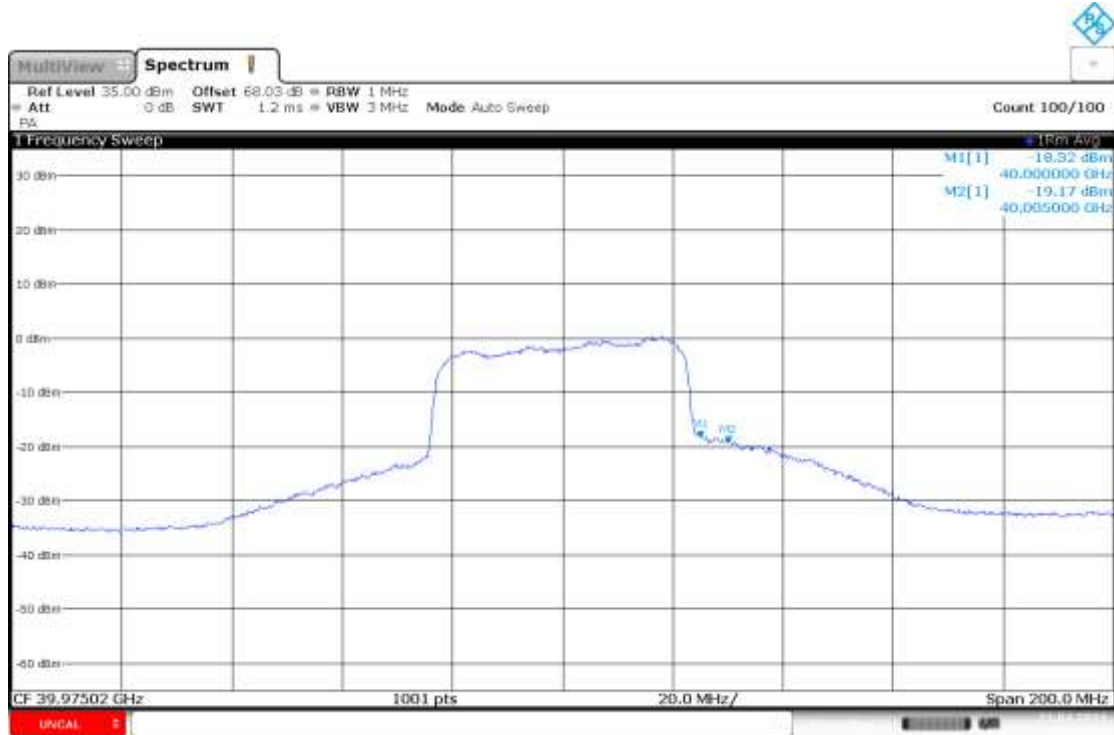

18:10:07 21.04.2021

LOW BAND EDGE BLOCK-50MHz-1RB

Module0, Beam ID:161, CP-OFDM							
	BANDWIDTH	FREQUENCY (MHz)	CHANNEL	SCS	MODULATION	Peak (dBm)	Limit (dBm)
n260	50MHz	37025.04	LOW	120kHz	QPSK	-23.53	-5
n260	50MHz	37025.04	LOW	120kHz		-25.18	-13

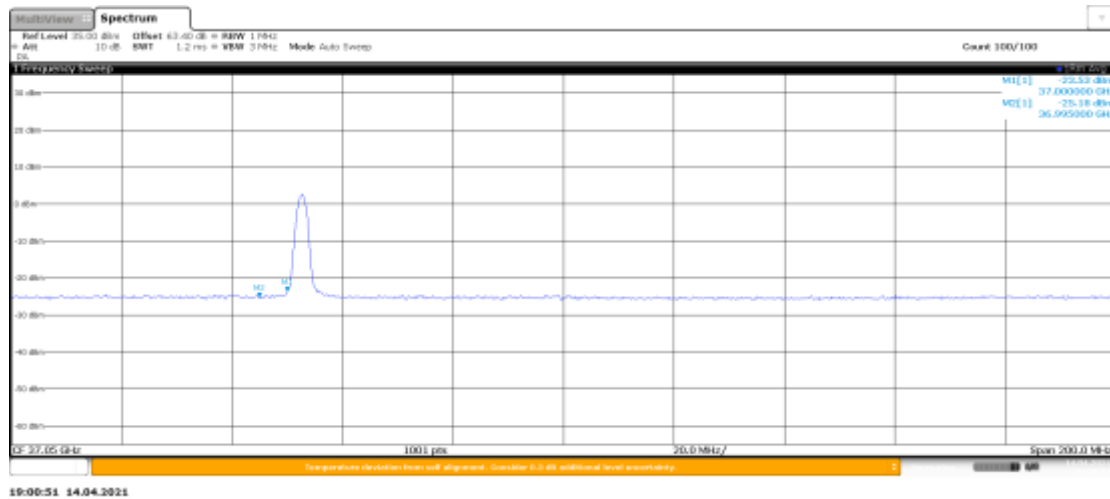

HIGH BAND EDGE BLOCK-50MHz-1RB

Module0, Beam ID:161, CP-OFDM							
	BANDWIDTH	FREQUENCY (MHz)	CHANNEL	SCS	MODULATION	Peak (dBm)	Limit (dBm)
n260	50MHz	39975	HIGH	120kHz	QPSK	-13.96	-5
n260	50MHz	39975	HIGH	120kHz		-20.58	-13



LOW BAND EDGE BLOCK-100MHz-100%RB

Module0, Beam ID:161, CP-OFDM							
	BANDWID TH	FREQUENC Y (MHz)	CHAN NEL	SCS	MODULATI ON	Peak (dBm)	Limit (dBm)
n260	100MHz	37050	LOW	120kHz	16QAM	-26.03	-5
n260	100MHz	37050	LOW	120kHz		-26.75	-13



17:04:27 19.04.2021

HIGH BAND EDGE BLOCK-100MHz-100%RB

Module0, Beam ID:161, CP-OFDM							
	BANDWID TH	FREQUENC Y (MHz)	CHAN NEL	SCS	MODULATI ON	Peak (dBm)	Limit (dBm)
n260	100MHz	39949.92	HIGH	120kHz	16QAM	-18.06	-5
n260	100MHz	39949.92	HIGH	120kHz		-19.08	-13



17:17:20 19.04.2021

LOW BAND EDGE BLOCK-100MHz-1RB

Module0, Beam ID:161, CP-OFDM							
	BANDWIDTH	FREQUENCY (MHz)	CHANNEL	SCS	MODULATION	Peak (dBm)	Limit (dBm)
n260	100MHz	37050	LOW	120kHz	64QAM	-21.55	-5
n260	100MHz	37050	LOW	120kHz		-25.16	-13

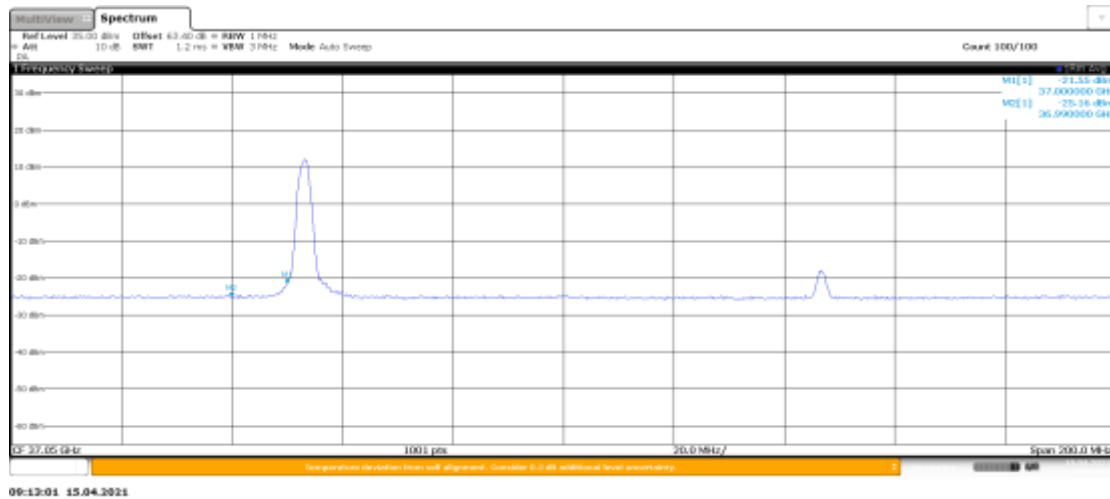

HIGH BAND EDGE BLOCK-100MHz-1RB

Module0, Beam ID:161, CP-OFDM							
	BANDWIDTH	FREQUENCY (MHz)	CHANNEL	SCS	MODULATION	Peak (dBm)	Limit (dBm)
n260	100MHz	39949.92	HIGH	120kHz	64QAM	-20.73	-5
n260	100MHz	39949.92	HIGH	120kHz		-20.59	-13

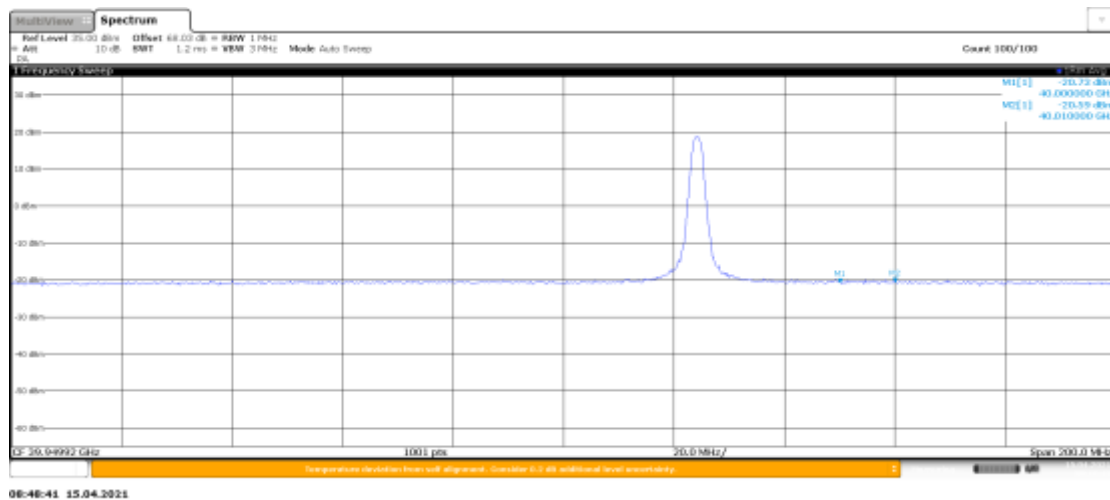

LOW BAND EDGE BLOCK-50MHz-100%RB

Module0, Beam ID:161, PUSCH DFT							
	BANDWID TH	FREQUENC Y (MHz)	CHAN NEL	SCS	MODULATI ON	Peak (dBm)	Limit (dBm)
n260	50MHz	37025.04	LOW	120kHz	16QAM	-14.46	-5
n260	50MHz	37025.04	LOW	120kHz		-14.85	-13



19:11:58 19.04.2021

HIGH BAND EDGE BLOCK-50MHz-100%RB

Module0, Beam ID:161, PUSCH DFT							
	BANDWID TH	FREQUENC Y (MHz)	CHAN NEL	SCS	MODULATI ON	Peak (dBm)	Limit (dBm)
n260	50MHz	39975	HIGH	120kHz	16QAM	-21.48	-5
n260	50MHz	39975	HIGH	120kHz		-22.68	-13

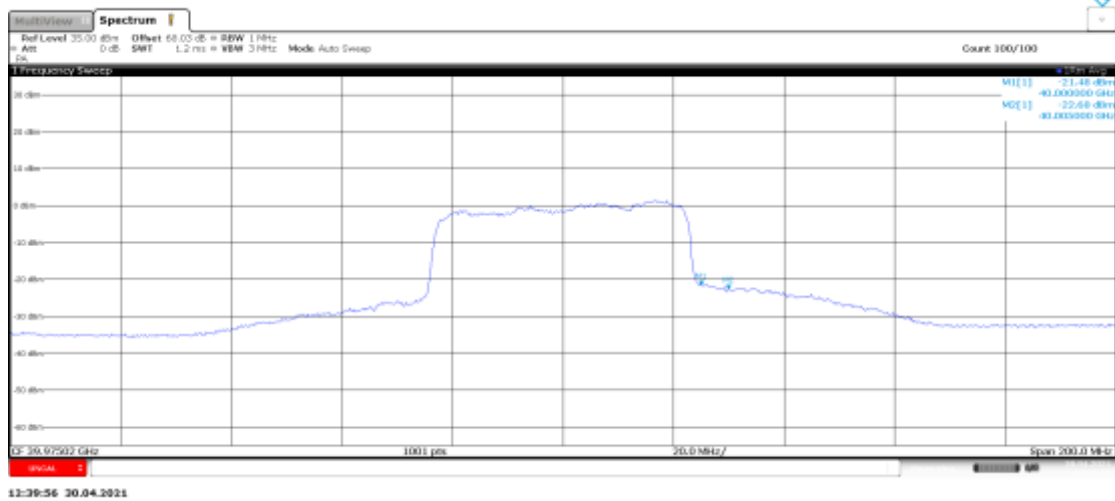

LOW BAND EDGE BLOCK-50MHz-1RB

Module0, Beam ID:161, PUSCH DFT							
	BANDWIDTH	FREQUENCY (MHz)	CHANNEL	SCS	MODULATION	Peak (dBm)	Limit (dBm)
n260	50MHz	37025.04	LOW	120kHz	QPSK	-17.01	-5
n260	50MHz	37025.04	LOW	120kHz		-24.56	-13

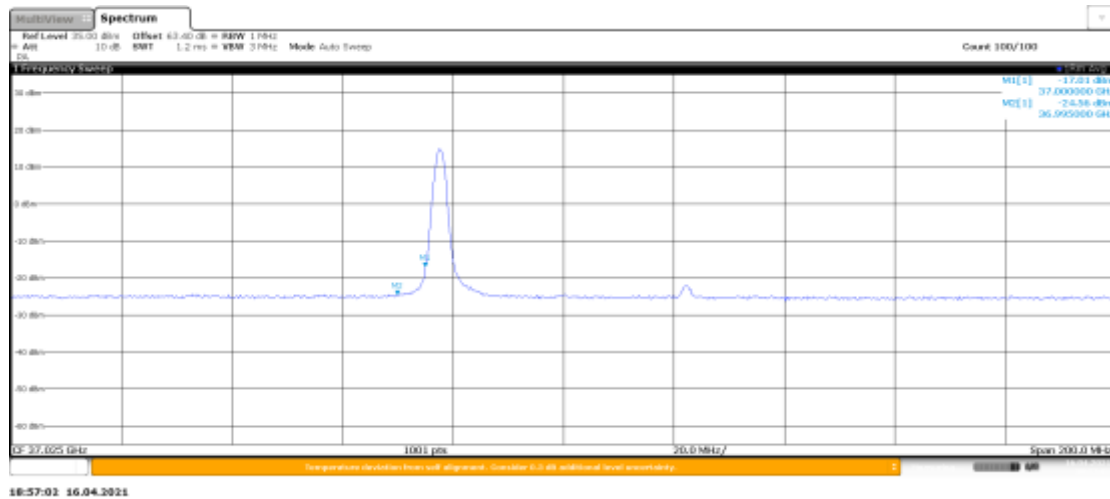

HIGH BAND EDGE BLOCK-50MHz-1RB

Module0, Beam ID:161, PUSCH DFT							
	BANDWIDTH	FREQUENCY (MHz)	CHANNEL	SCS	MODULATION	Peak (dBm)	Limit (dBm)
n260	50MHz	39975	HIGH	120kHz	QPSK	-6.11	-5
n260	50MHz	39975	HIGH	120kHz		-23.65	-13

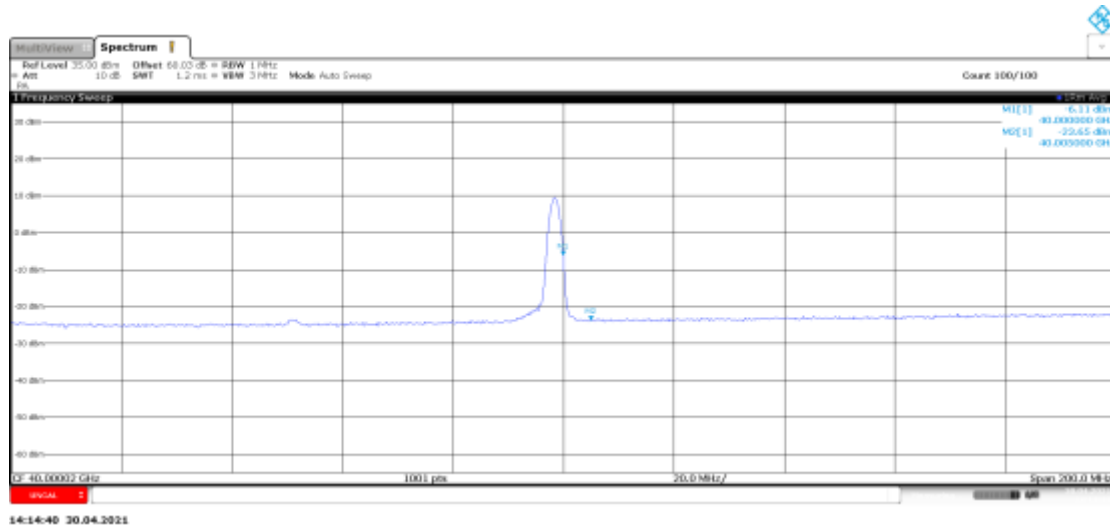

LOW BAND EDGE BLOCK-100MHz-100%RB

Module0, Beam ID:161, PUSCH DFT							
	BANDWID TH	FREQUENC Y (MHz)	CHAN NEL	SCS	MODULATI ON	Peak (dBm)	Limit (dBm)
n260	100MHz	37050	LOW	120kHz	64QAM	-23.33	-5
n260	100MHz	37050	LOW	120kHz		-24.79	-13

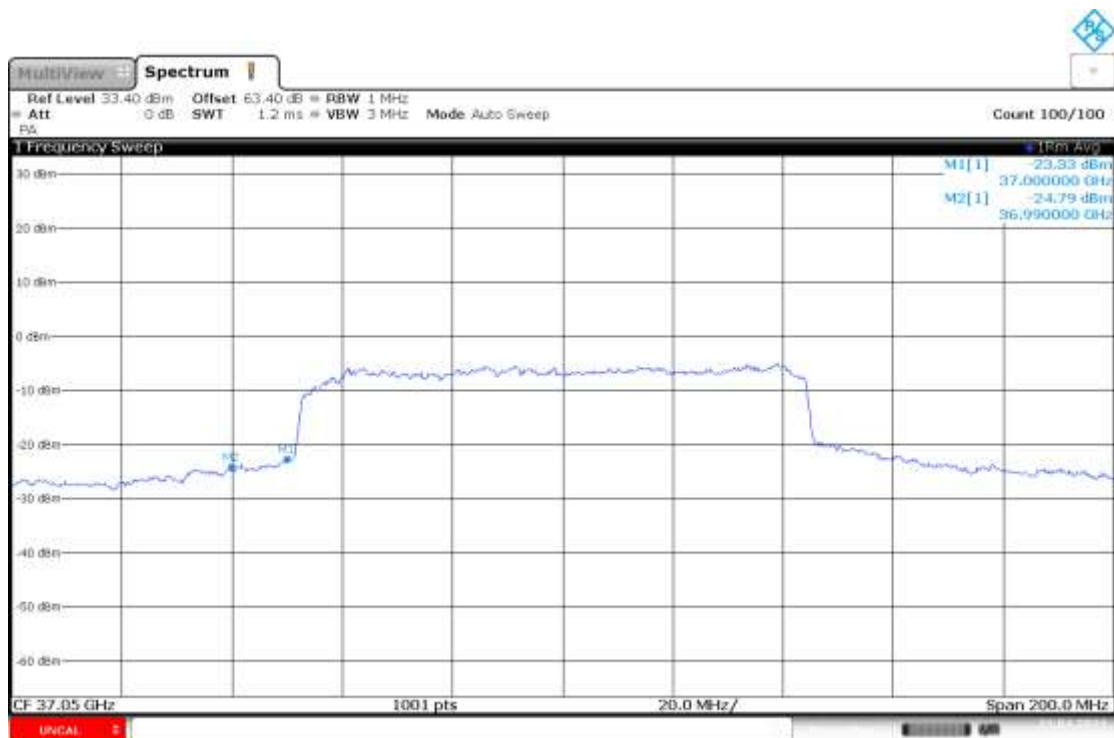

19:40:05 21.04.2021

HIGH BAND EDGE BLOCK-100MHz-100%RB

Module0, Beam ID:161, PUSCH DFT							
	BANDWID TH	FREQUENC Y (MHz)	CHAN NEL	SCS	MODULATI ON	Peak (dBm)	Limit (dBm)
n260	100MHz	39949.92	HIGH	120kHz	64QAM	-14.78	-5
n260	100MHz	39949.92	HIGH	120kHz		-14.28	-13

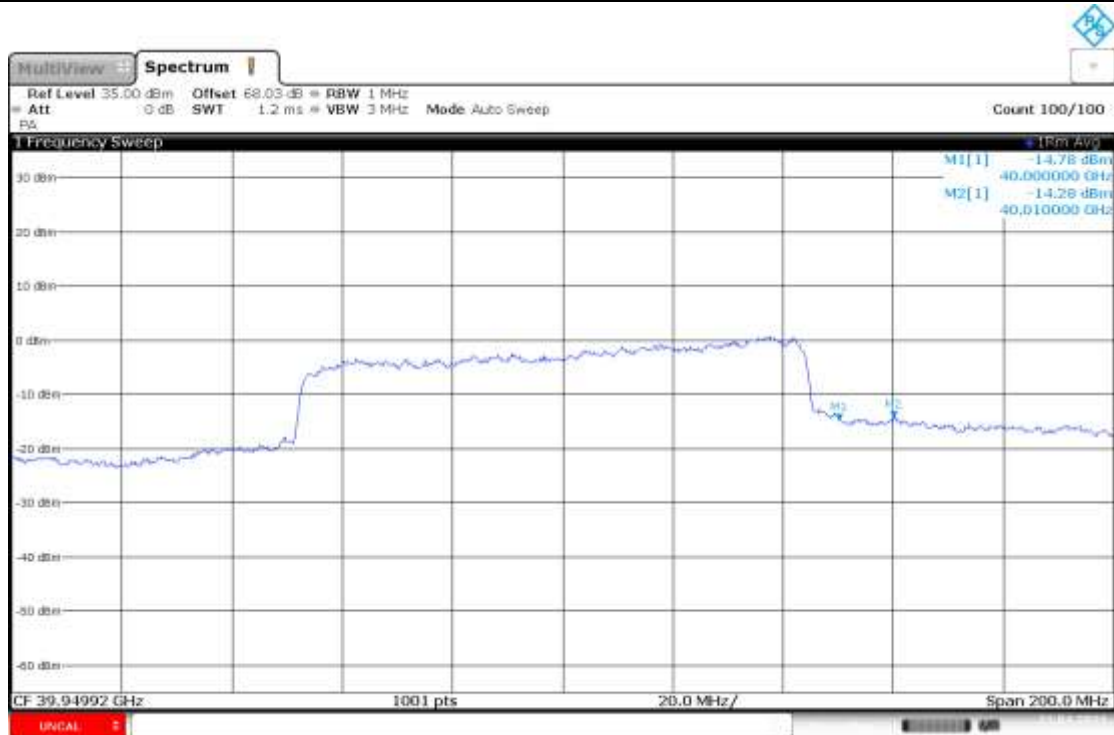

19:58:47 21.04.2021

LOW BAND EDGE BLOCK-100MHz-1RB

Module0, Beam ID:161, PUSCH DFT							
	BANDWIDTH	FREQUENCY (MHz)	CHANNEL	SCS	MODULATION	Peak (dBm)	Limit (dBm)
n260	100MHz	37050	LOW	120kHz	64QAM	-20.11	-5
n260	100MHz	37050	LOW	120kHz		-25.01	-13

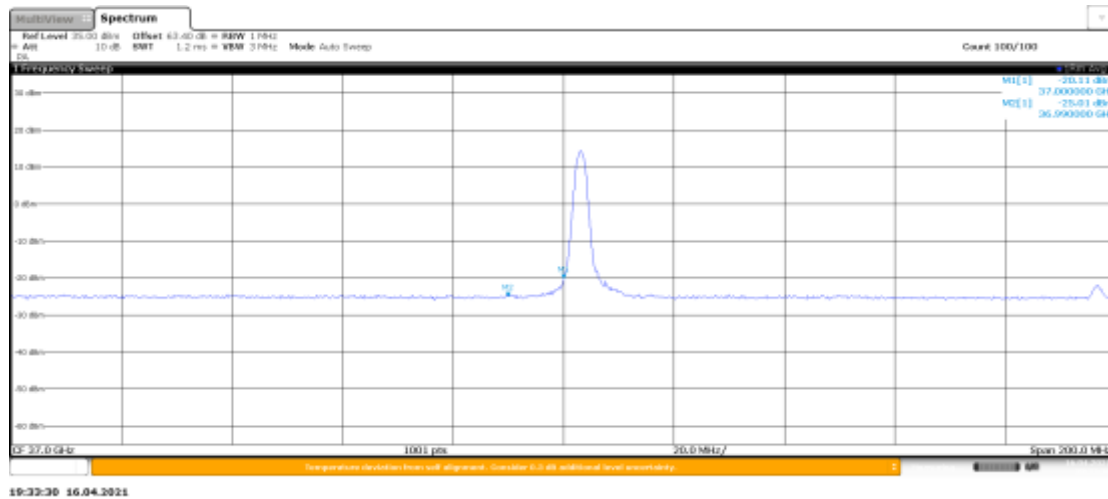

HIGH BAND EDGE BLOCK-100MHz-1RB

Module0, Beam ID:161, PUSCH DFT							
	BANDWIDTH	FREQUENCY (MHz)	CHANNEL	SCS	MODULATION	Peak (dBm)	Limit (dBm)
n260	100MHz	39949.92	HIGH	120kHz	64QAM	-17.58	-5
n260	100MHz	39949.92	HIGH	120kHz		-20.68	-13

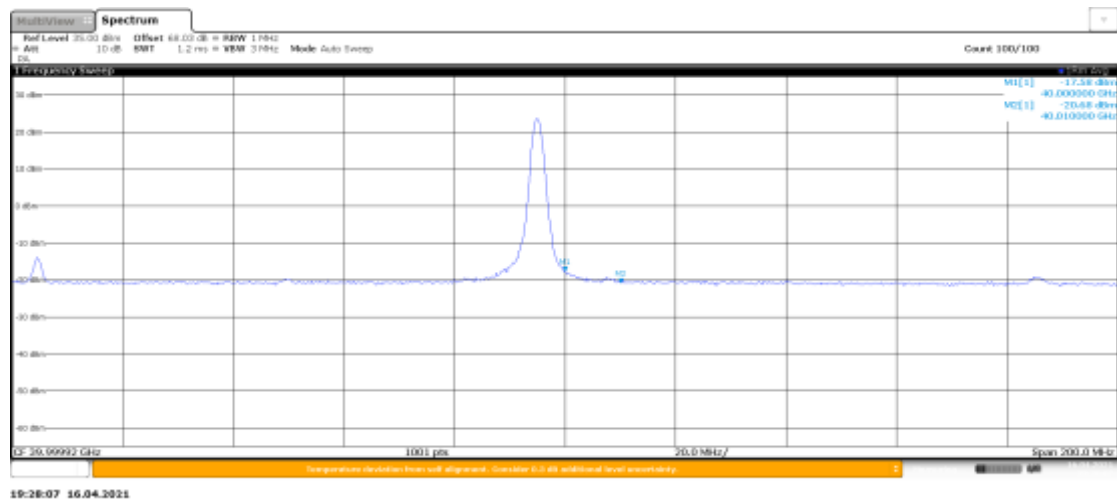

LOW BAND EDGE BLOCK-50MHz-100%RB

Module1, Beam ID:157, PUSCH DFT							
	BANDWID TH	FREQUENC Y (MHz)	CHAN NEL	SCS	MODULATI ON	Peak (dBm)	Limit (dBm)
n260	50MHz	37025.04	LOW	120kHz	QPSK	-13.04	-5
n260	50MHz	37025.04	LOW	120kHz		-28.00	-13

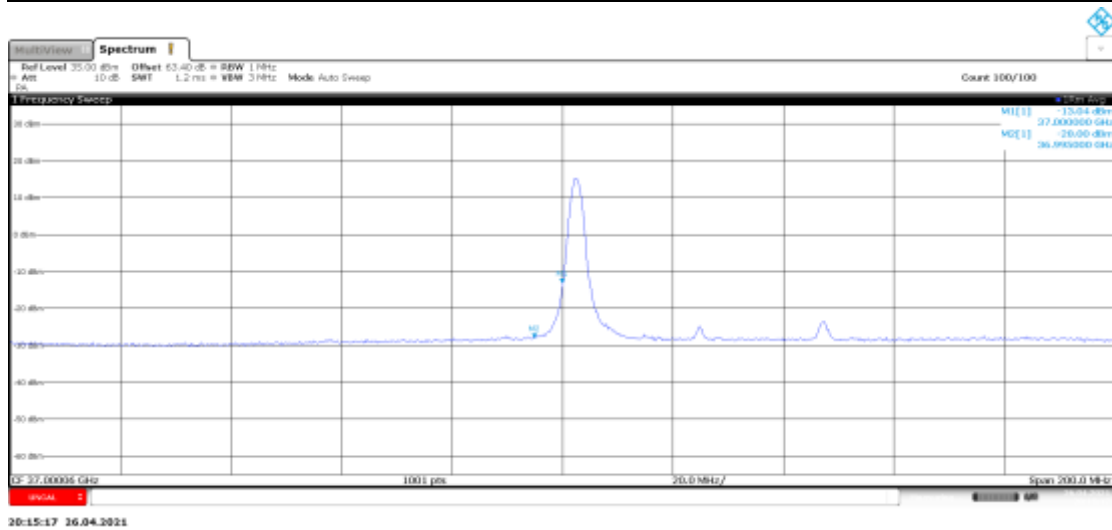

HIGH BAND EDGE BLOCK-50MHz-100%RB

Module1, Beam ID:157, PUSCH DFT							
	BANDWID TH	FREQUENC Y (MHz)	CHAN NEL	SCS	MODULATI ON	Peak (dBm)	Limit (dBm)
n260	50MHz	39975	HIGH	120kHz	QPSK	-6.07	-5
n260	50MHz	39975	HIGH	120kHz		-20.88	-13

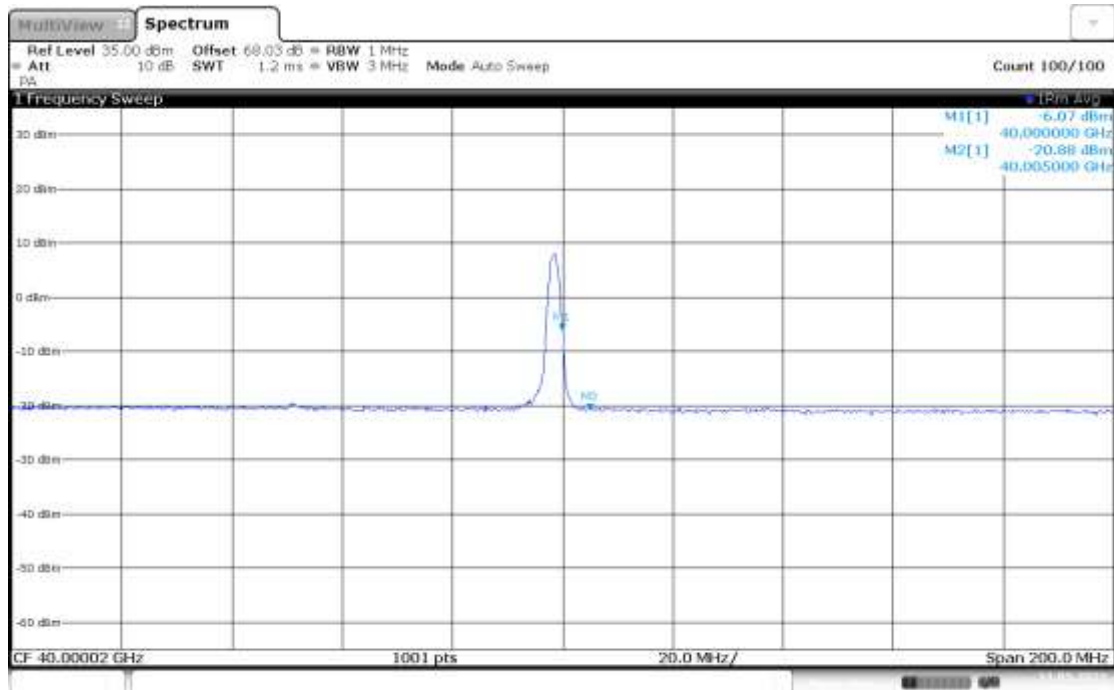

09:49:53 11.05.2021

LOW BAND EDGE BLOCK-50MHz-100%RB

Module2, Beam ID:167, PUSCH DFT							
	BANDWID TH	FREQUENC Y (MHz)	CHAN NEL	SCS	MODULATI ON	Peak (dBm)	Limit (dBm)
n260	50MHz	37025.04	LOW	120kHz	QPSK	-12.35	-5
n260	50MHz	37025.04	LOW	120kHz		-27.41	-13

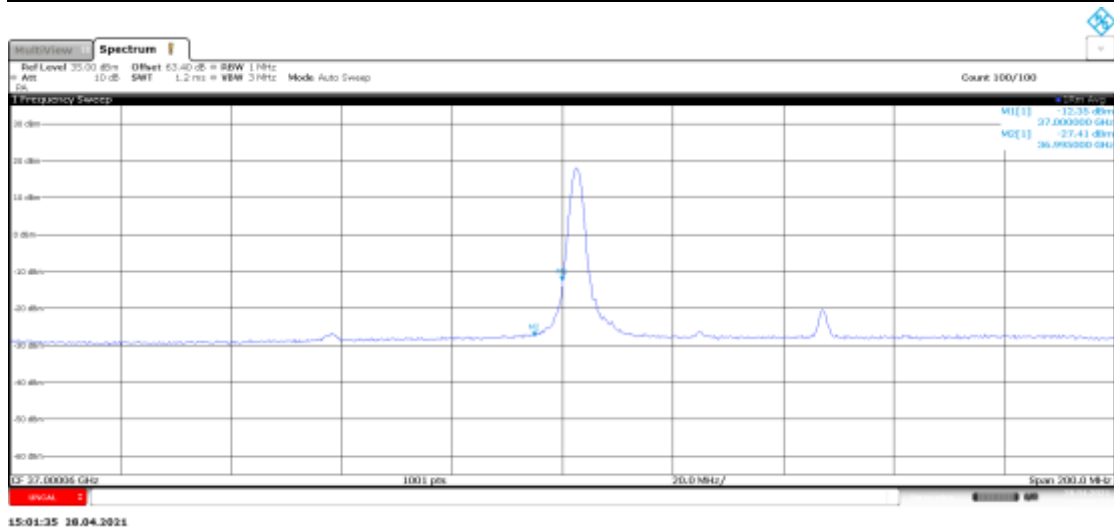

HIGH BAND EDGE BLOCK-50MHz-100%RB

Module2, Beam ID:167, PUSCH DFT							
	BANDWID TH	FREQUENC Y (MHz)	CHAN NEL	SCS	MODULATI ON	Peak (dBm)	Limit (dBm)
n260	50MHz	39975	HIGH	120kHz	QPSK	-8.04	-5
n260	50MHz	39975	HIGH	120kHz		-24.54	-13

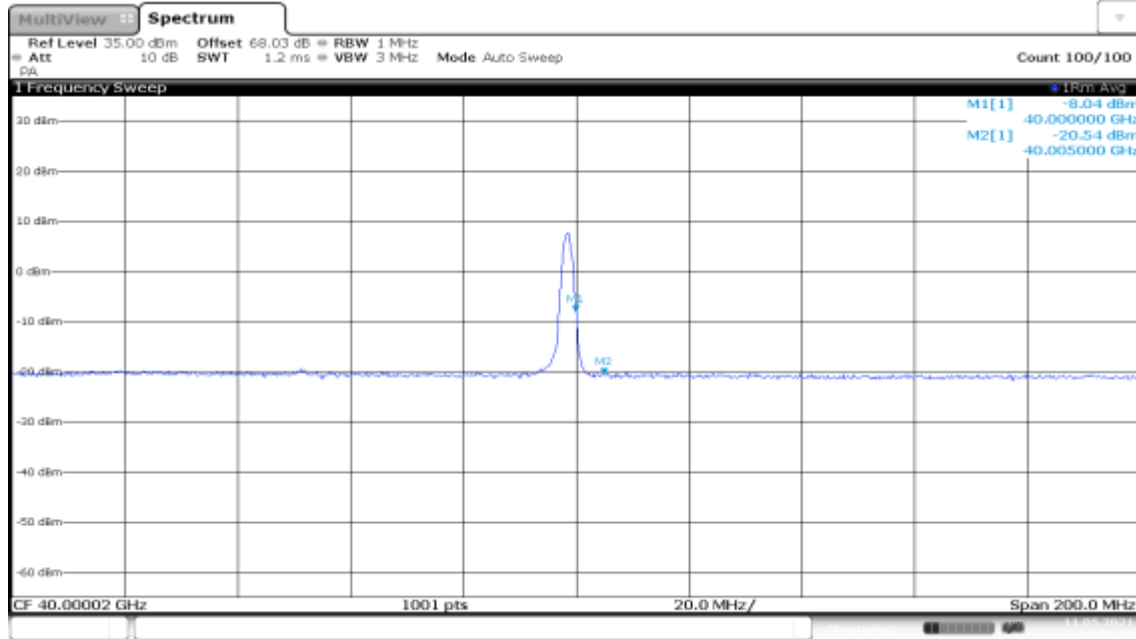

10:06:33 11.05.2021

n261
LOW BAND EDGE BLOCK-50MHz-100%RB

Module0, Beam ID:47, CP-OFDM							
	BANDWIDTH	FREQUENCY (MHz)	CHANNEL	SCS	MODULATION	Peak (dBm)	Limit (dBm)
n261	50MHz	27525	LOW	120kHz	16QAM	-24.56	-5
n261	50MHz	27525	LOW	120kHz		-26.13	-13

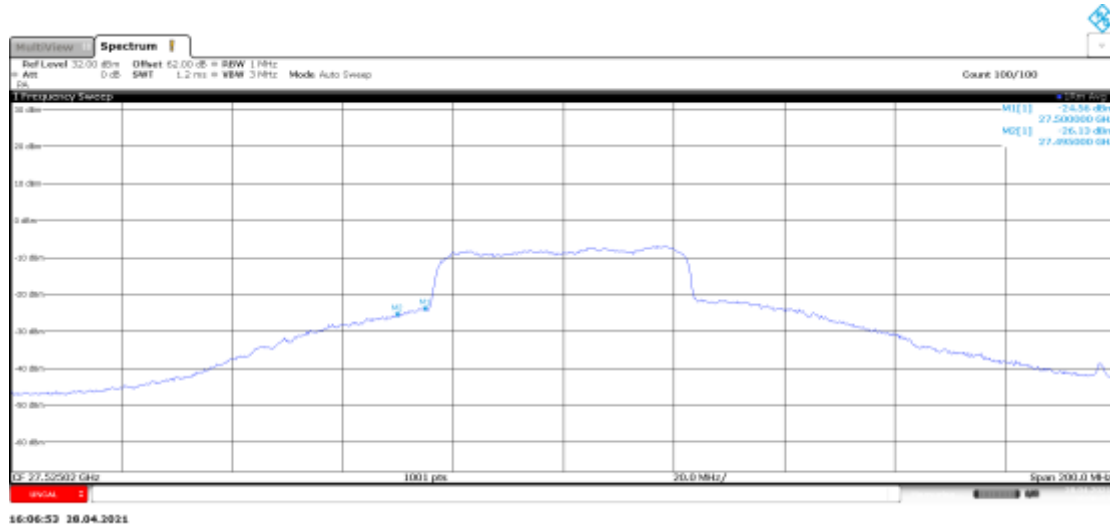

HIGH BAND EDGE BLOCK-50MHz-100%RB

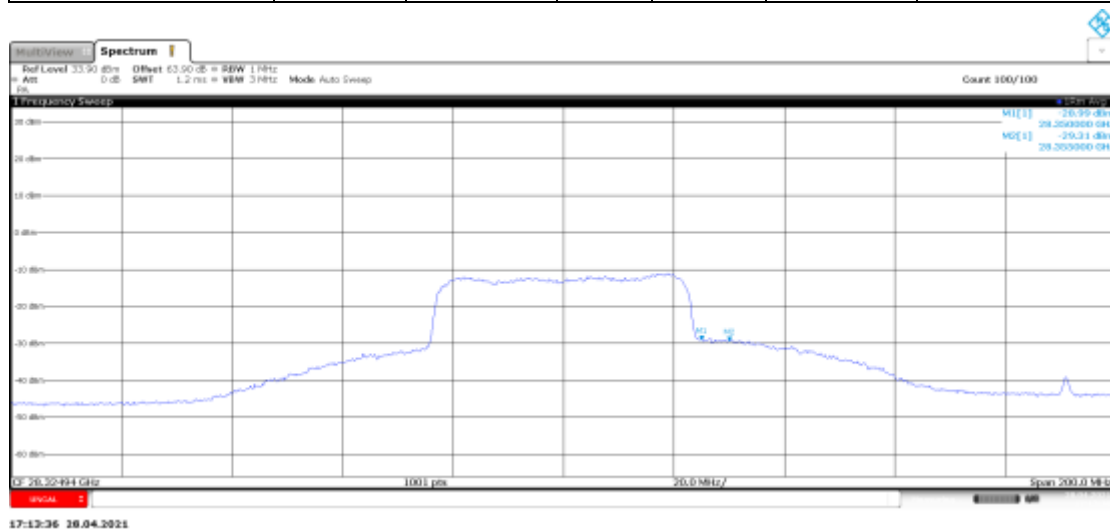
Module0, Beam ID:47, CP-OFDM							
	BANDWIDTH	FREQUENCY (MHz)	CHANNEL	SCS	MODULATION	Peak (dBm)	Limit (dBm)
n261	50MHz	28324.92	HIGH	120kHz	16QAM	-28.99	-5
n261	50MHz	28324.92	HIGH	120kHz		-29.31	-13

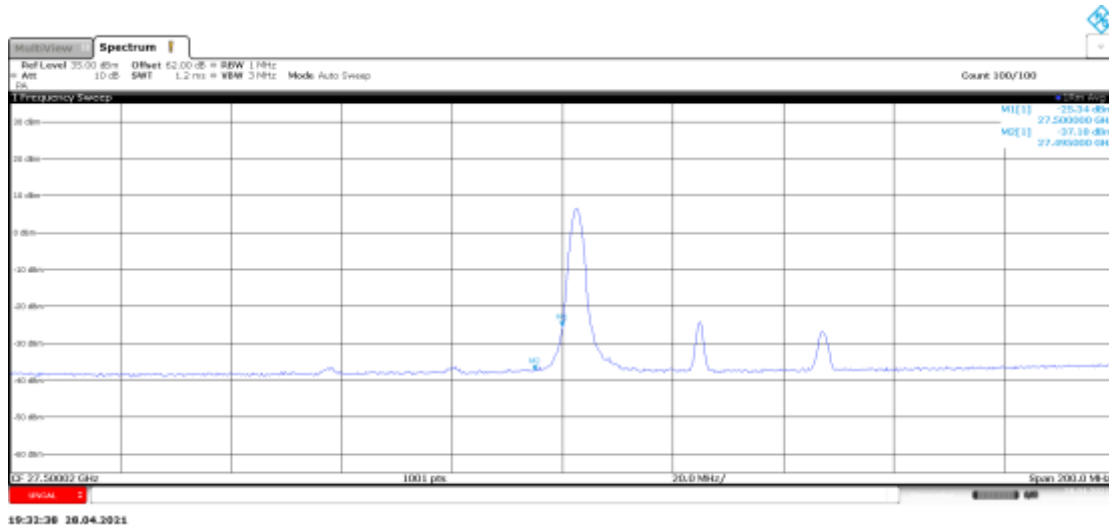

LOW BAND EDGE BLOCK-50MHz-1RB

Module0, Beam ID:47, CP-OFDM							
	BANDWIDTH	FREQUENCY (MHz)	CHANNEL	SCS	MODULATION	Peak (dBm)	Limit (dBm)
n261	50MHz	27525	LOW	120kHz	64QAM	-25.34	-5
n261	50MHz	27525	LOW	120kHz		-37.18	-13



HIGH BAND EDGE BLOCK-50MHz-1RB

Module0, Beam ID:47, CP-OFDM							
	BANDWIDTH	FREQUENCY (MHz)	CHANNEL	SCS	MODULATION	Peak (dBm)	Limit (dBm)
n261	50MHz	28324.92	HIGH	120kHz	64QAM	-15.68	-5
n261	50MHz	28324.92	HIGH	120kHz		-36.88	-13

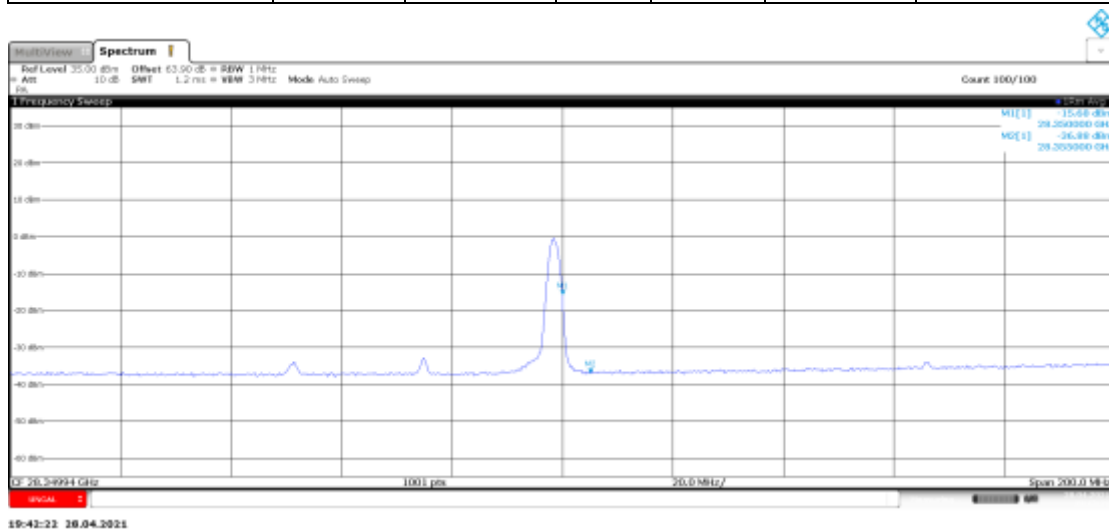

LOW BAND EDGE BLOCK-100MHz-100%RB

Module0, Beam ID:47, CP-OFDM							
	BANDWIDTH	FREQUENCY (MHz)	CHANNEL	SCS	MODULATION	Peak (dBm)	Limit (dBm)
n261	100MHz	27550.08	LOW	120kHz	QPSK	-25.97	-5
n261	100MHz	27550.08	LOW	120kHz		-27.41	-13

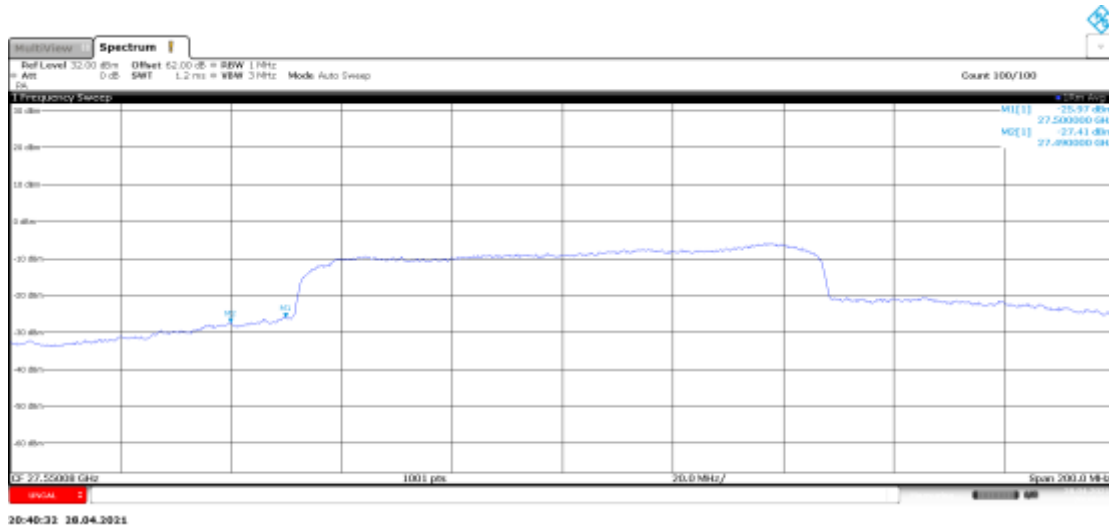

HIGH BAND EDGE BLOCK-100MHz-100%RB

Module0, Beam ID:47, CP-OFDM							
	BANDWIDTH	FREQUENCY (MHz)	CHANNEL	SCS	MODULATION	Peak (dBm)	Limit (dBm)
n261	100MHz	28299.96	HIGH	120kHz	QPSK	-33.86	-5
n261	100MHz	28299.96	HIGH	120kHz		-34.12	-13

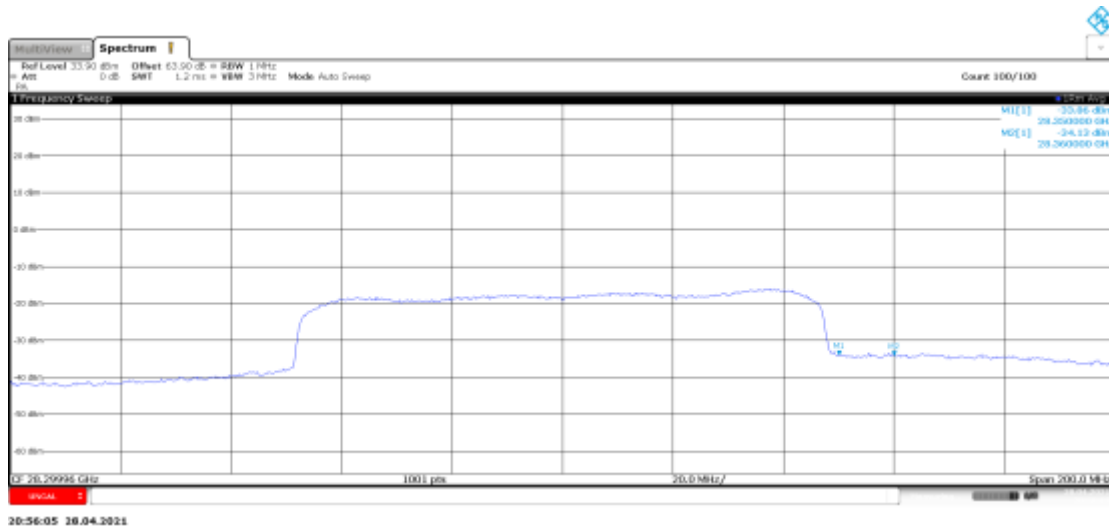

LOW BAND EDGE BLOCK-100MHz-1RB

Module0, Beam ID:47, CP-OFDM							
	BANDWID TH	FREQUENC Y (MHz)	CHAN NEL	SCS	MODULATI ON	Peak (dBm)	Limit (dB m)
n261	100MHz	27550.08	LOW	120kHz	64QAM	-24.45	-5
n261	100MHz	27550.08	LOW	120kHz		-30.51	-13

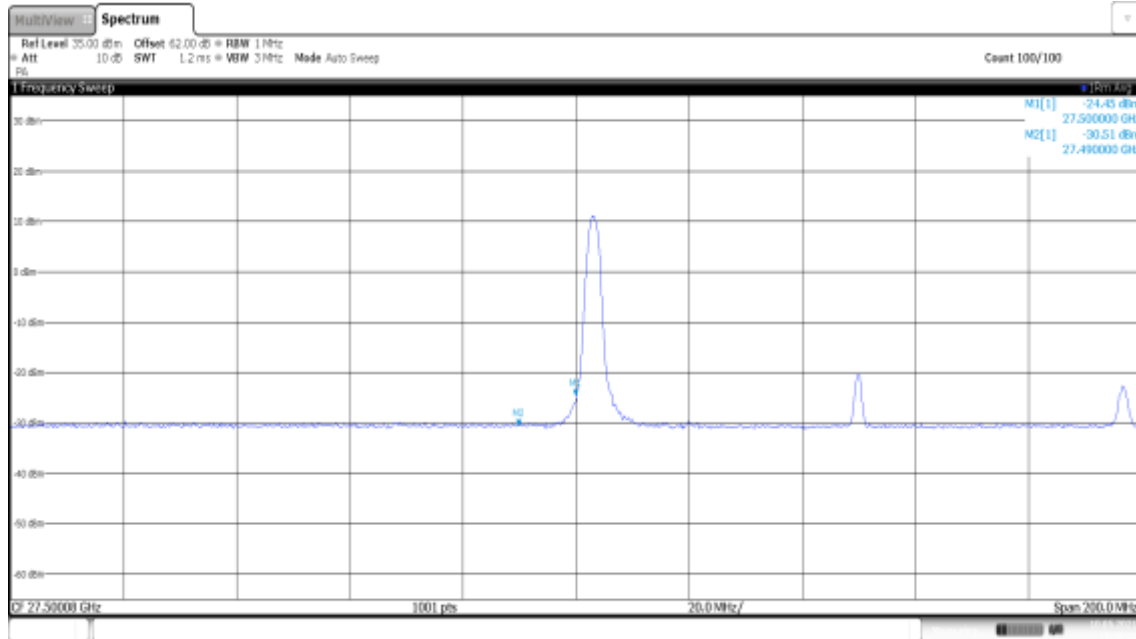

HIGH BAND EDGE BLOCK-100MHz-1RB

Module0, Beam ID:47, CP-OFDM							
	BANDWIDTH	FREQUENCY (MHz)	CHANNEL	SCS	MODULATION	Peak (dBm)	Limit (dBm)
n261	100MHz	28299.96	HIGH	120kHz	64QAM	-29.77	-5
n261	100MHz	28299.96	HIGH	120kHz		-36.63	-13

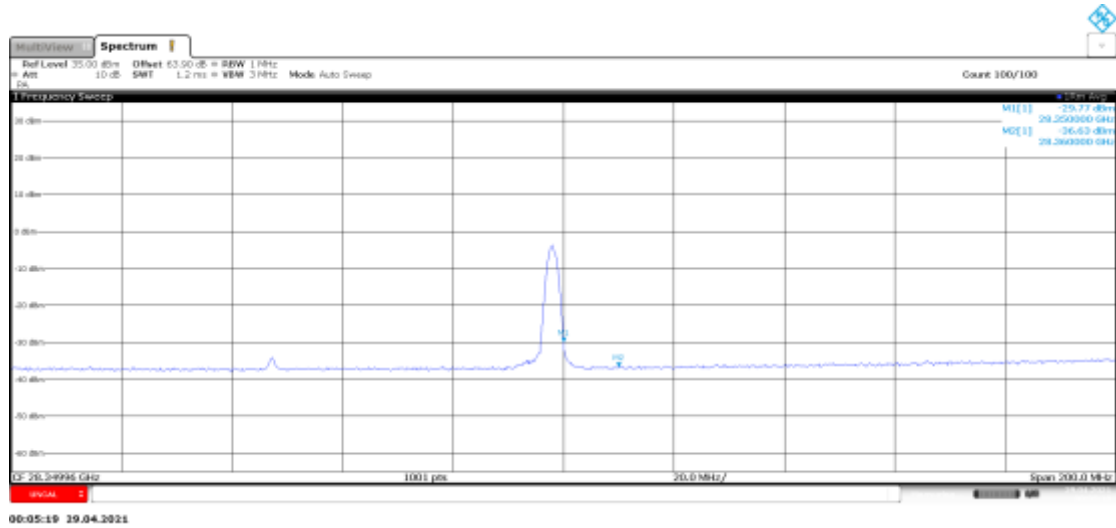

LOW BAND EDGE BLOCK-50MHz-100%RB

Module0, Beam ID:47, PUSCH DFT							
	BANDWID TH	FREQUENC Y (MHz)	CHAN NEL	SCS	MODULATI ON	Peak (dBm)	Limit (dBm)
n261	50MHz	27525	LOW	120kHz	64QAM	-19.33	-5
n261	50MHz	27525	LOW	120kHz		-19.92	-13



07:13:14 29.04.2021

HIGH BAND EDGE BLOCK-50MHz-100%RB

Module0, Beam ID:47, PUSCH DFT							
	BANDWID TH	FREQUENC Y (MHz)	CHAN NEL	SCS	MODULATI ON	Peak (dBm)	Limit (dBm)
n261	50MHz	28324.92	HIGH	120kHz	64QAM	-17.53	-5
n261	50MHz	28324.92	HIGH	120kHz		-17.27	-13

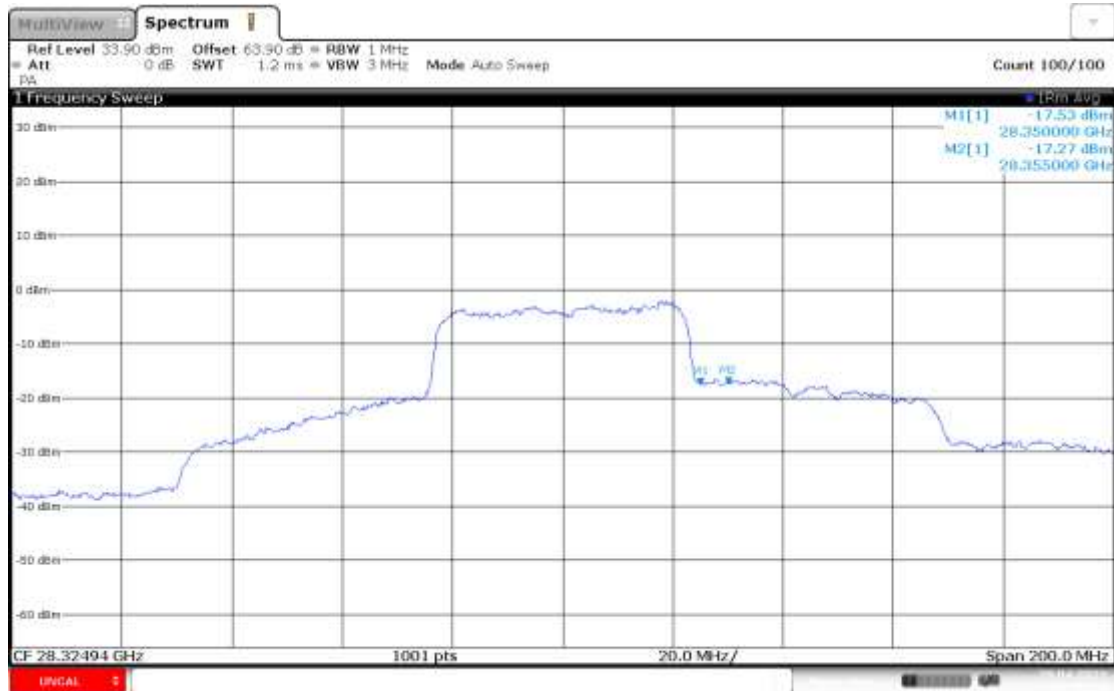

07:29:22 29.04.2021

LOW BAND EDGE BLOCK-50MHz-1RB

Module0, Beam ID:47, PUSCH DFT							
	BANDWIDTH	FREQUENCY	CHANNEL	SCS	MODULATION	Peak (dBm)	Limit (dBm)
n261	50MHz	27525	LOW	120kHz	16QAM	-13.32	-5
n261	50MHz	27525	LOW	120kHz		-32.41	-13

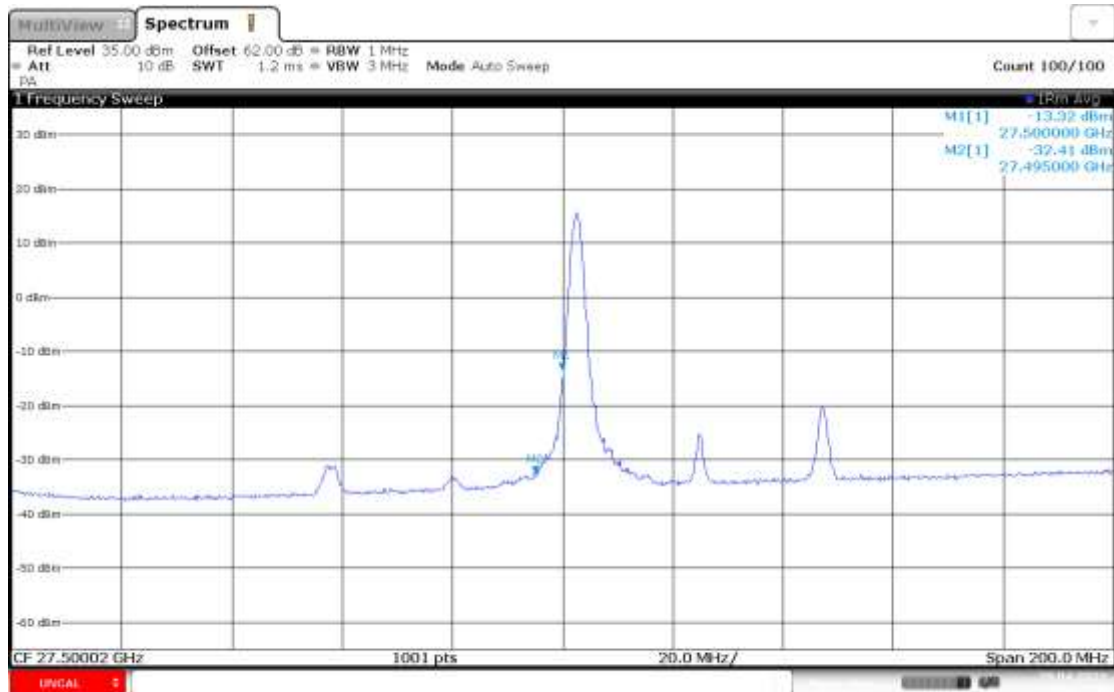

07:51:01 29.04.2021

HIGH BAND EDGE BLOCK-50MHz-1RB

Module0, Beam ID:47, PUSCH DFT							
	BANDWID TH	FREQUENC Y (MHz)	CHAN NEL	SCS	MODULATI ON	Peak (dBm)	Limit (dBm)
n261	50MHz	28324.92	HIGH	120kHz	16QAM	-5.01	-5
n261	50MHz	28324.92	HIGH	120kHz		-33.29	-13

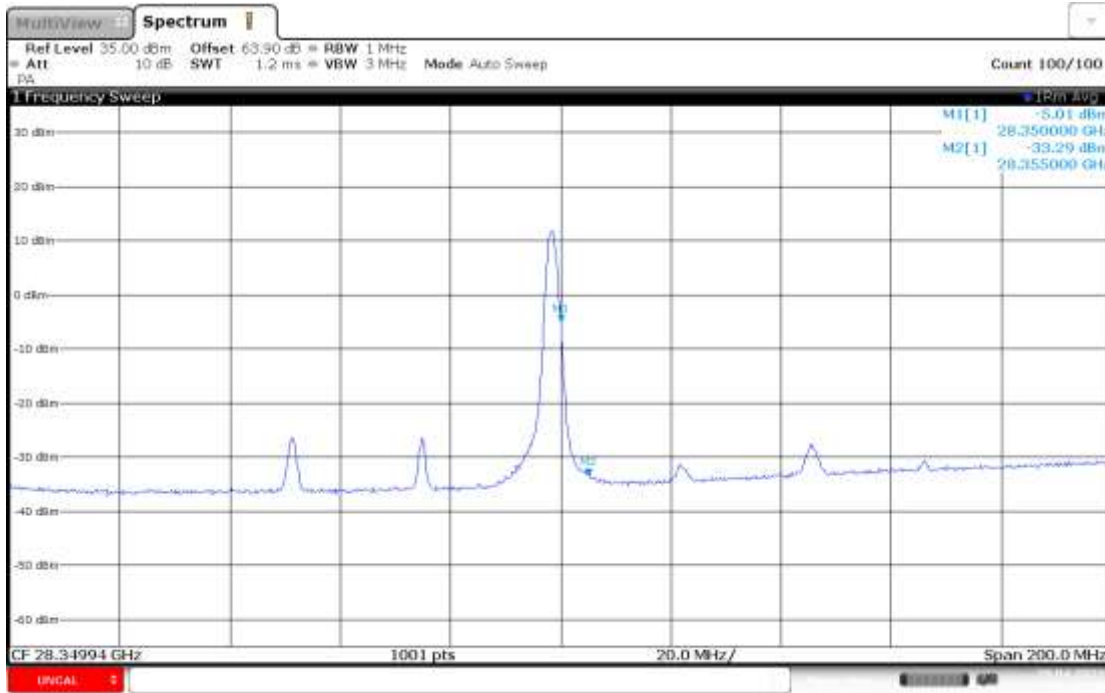

07:43:06 29.04.2021

LOW BAND EDGE BLOCK-100MHz-100%RB

Module0, Beam ID:47, PUSCH DFT							
	BANDWID TH	FREQUENC Y (MHz)	CHAN NEL	SCS	MODULATI ON	Peak (dBm)	Limit (dBm)
n261	100MHz	27550.08	LOW	120kHz	QPSK	-18.40	-5
n261	100MHz	27550.08	LOW	120kHz		-19.45	-13

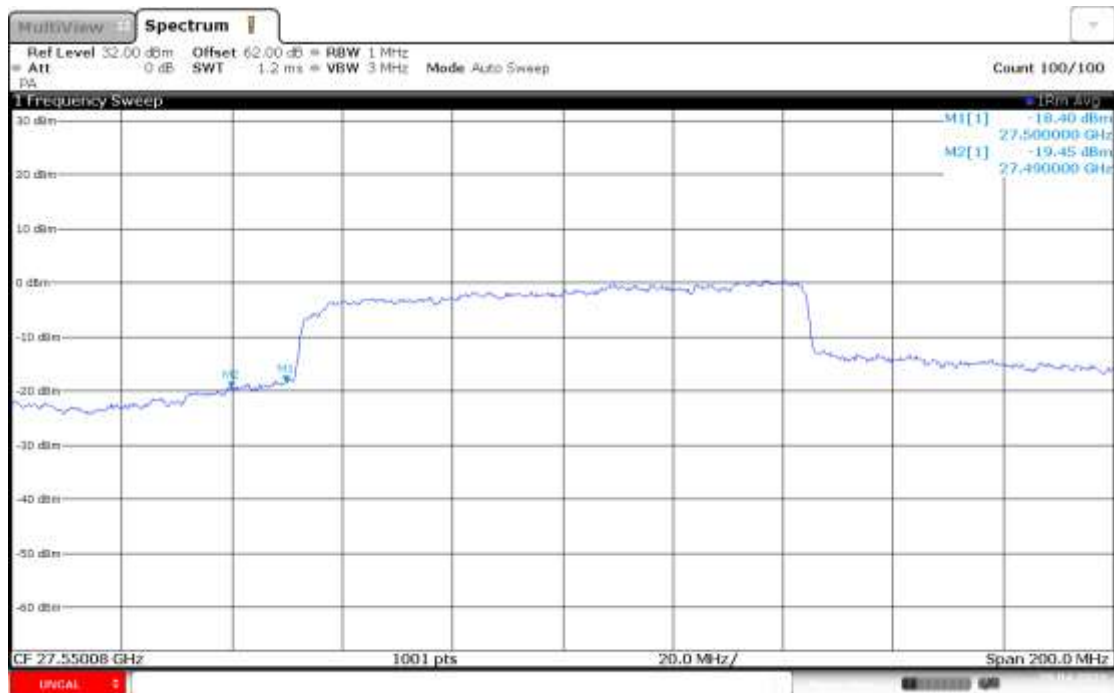

HIGH BAND EDGE BLOCK-100MHz-100%RB

Module0, Beam ID:47, PUSCH DFT							
	BANDWID TH	FREQUENC Y (MHz)	CHAN NEL	SCS	MODULATI ON	Peak (dBm)	Limit (dBm)
n261	100MHz	28299.96	HIGH	120kHz	QPSK	-18.09	-5
n261	100MHz	28299.96	HIGH	120kHz		-18.14	-13

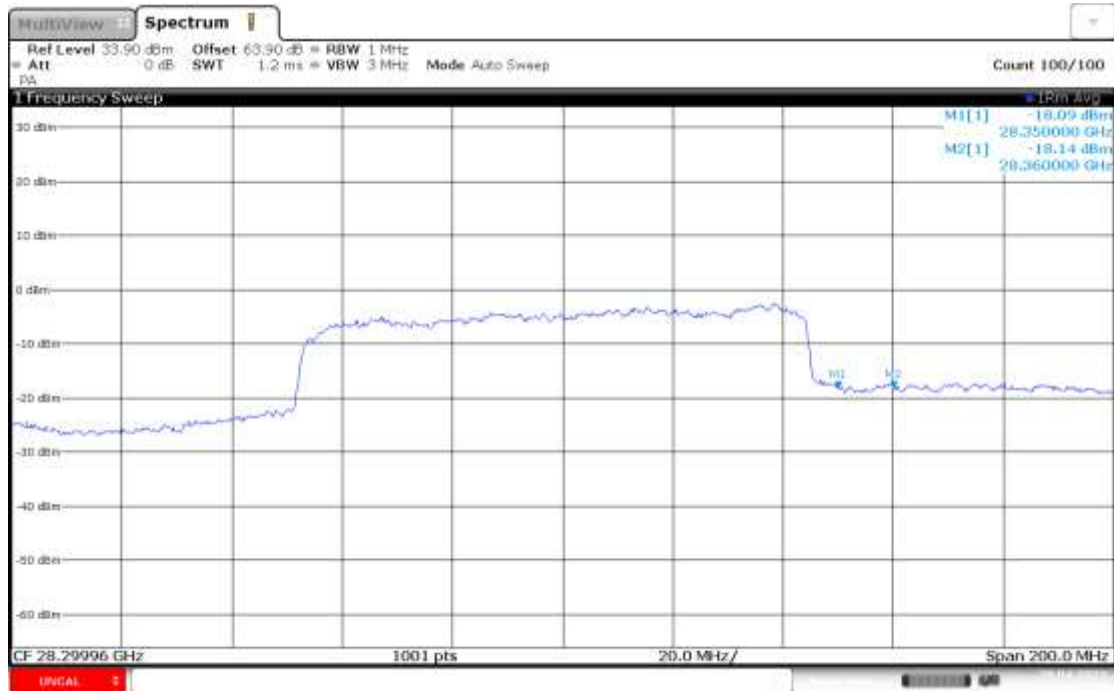

09:07:34 29.04.2021

LOW BAND EDGE BLOCK-50MHz-1RB

Module0, Beam ID:47, PUSCH DFT							
	BANDWID TH	FREQUENC Y (MHz)	CHAN NEL	SCS	MODULATI ON	Peak (dBm)	Limit (dB m)
n261	100MHz	27550.08	LOW	120kHz	QPSK	-18.63	-5
n261	100MHz	27550.08	LOW	120kHz		-33.82	-13

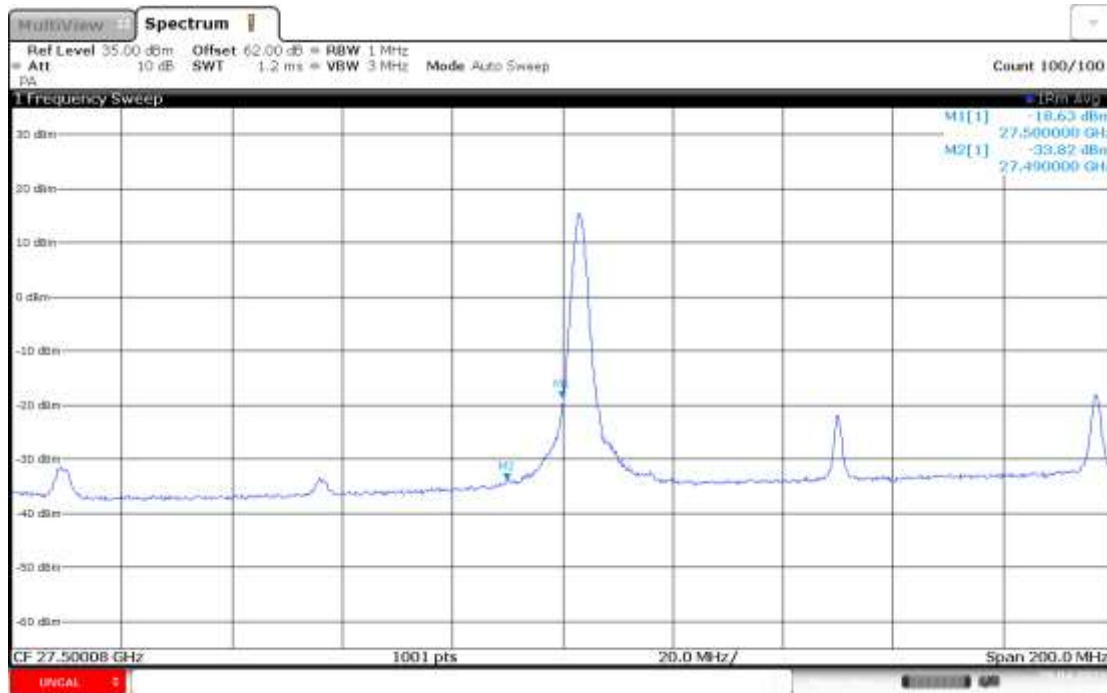

10:26:51 29.04.2021

HIGH BAND EDGE BLOCK-100MHz-1RB

Module0, Beam ID:47, PUSCH DFT							
	BANDWID TH	FREQUENC Y (MHz)	CHAN NEL	SCS	MODULATI ON	Peak (dBm)	Limit (dBm)
n261	100MHz	28299.96	HIGH	120kHz	QPSK	-31.74	-5
n261	100MHz	28299.96	HIGH	120kHz		-34.77	-13

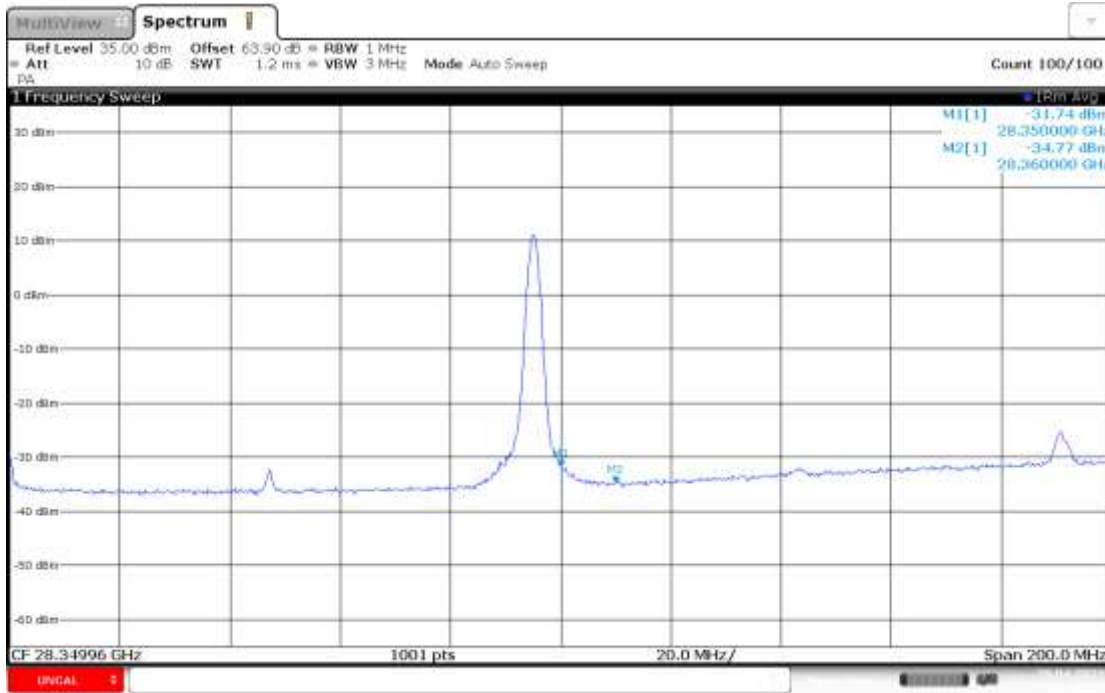

10:18:02 29.04.2021

LOW BAND EDGE BLOCK-100MHz-100%RB

Module1, Beam ID:29, PUSCH DFT							
	BANDWID TH	FREQUENC Y (MHz)	CHAN NEL	SCS	MODULATI ON	Peak (dBm)	Limit (dBm)
n261	100MHz	27550.08	LOW	120kHz	QPSK	-30.15	-5
n261	100MHz	27550.08	LOW	120kHz		-31.31	-13

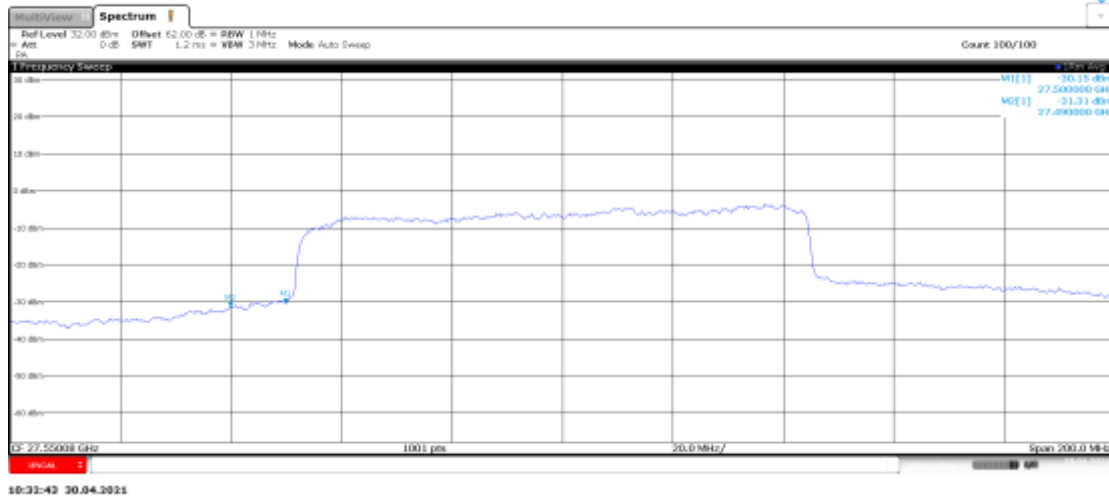

HIGH BAND EDGE BLOCK-100MHz-100%RB

Module1, Beam ID:29, PUSCH DFT							
	BANDWIDTH	FREQUENCY (MHz)	CHANNEL	SCS	MODULATION	Peak (dBm)	Limit (dBm)
n261	100MHz	28299.96	HIGH	120kHz	QPSK	-29.02	-5
n261	100MHz	28299.96	HIGH	120kHz		-29.32	-13

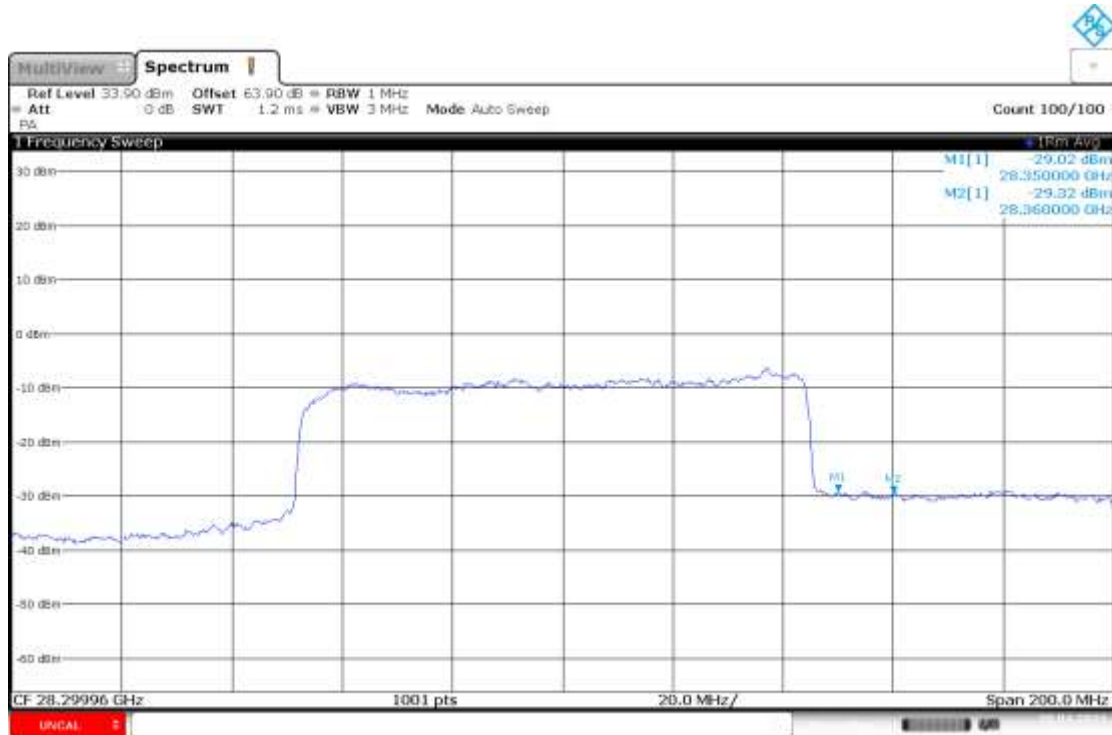

09:50:51 30.04.2021

LOW BAND EDGE BLOCK-100MHz-100%RB

Module2, Beam ID:52, PUSCH DFT							
	BANDWID TH	FREQUENC Y (MHz)	CHAN NEL	SCS	MODULATI ON	Peak (dBm)	Limit (dBm)
n261	100MHz	27550.08	LOW	120kHz	QPSK	-27.91	-5
n261	100MHz	27550.08	LOW	120kHz		-29.89	-13

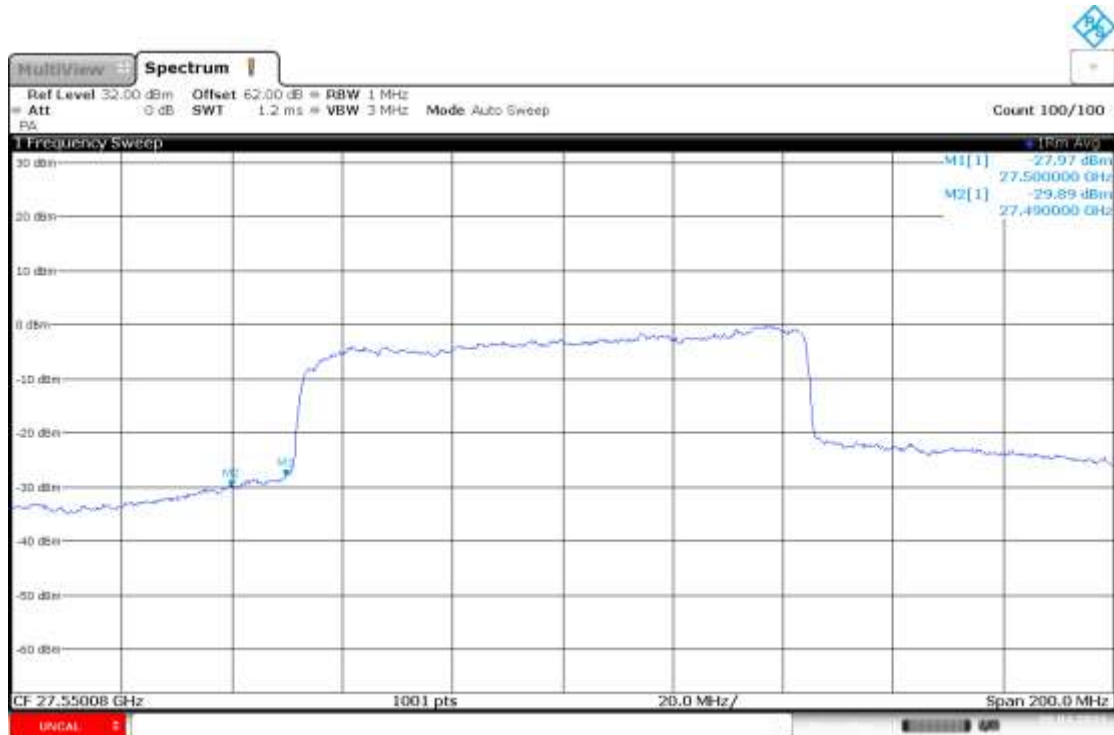

08:57:17 30.04.2021

HIGH BAND EDGE BLOCK-100MHz-100%RB

Module2, Beam ID:52, PUSCH DFT							
	BANDWIDTH	FREQUENCY (MHz)	CHANNEL	SCS	MODULATION	Peak (dBm)	Limit (dBm)
n261	100MHz	28299.96	HIGH	120kHz	QPSK	-16.48	-5
n261	100MHz	28299.96	HIGH	120kHz		-16.89	-13

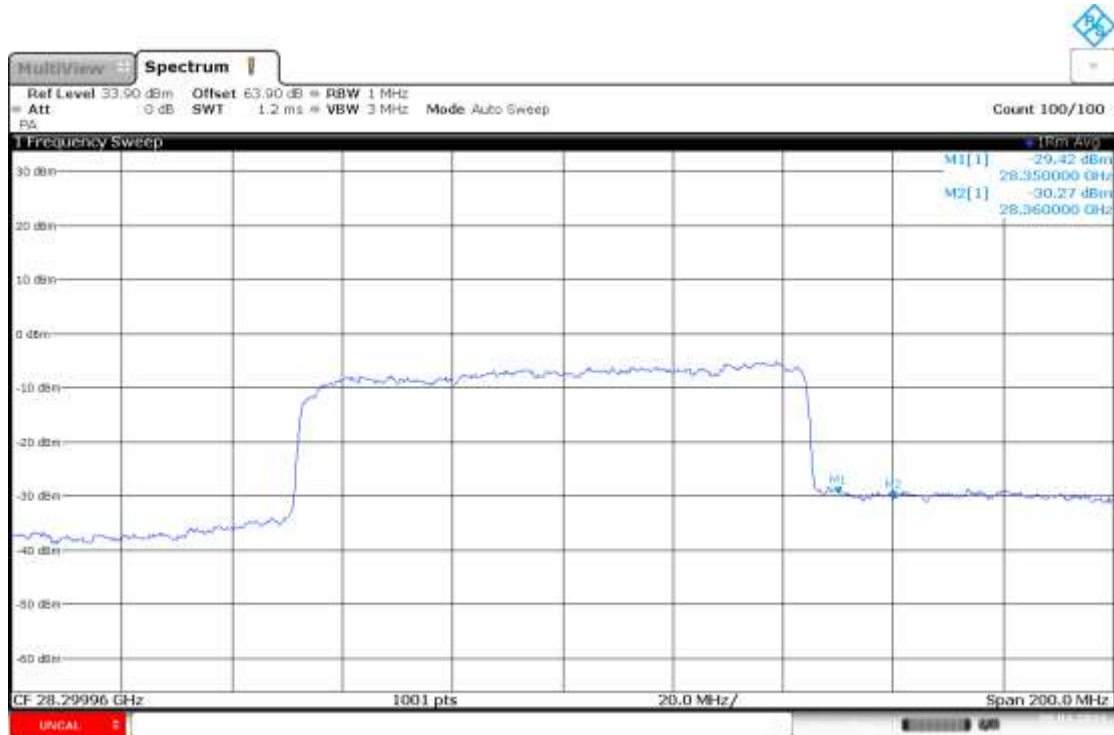

09:36:54 30.04.2021

LOW BAND EDGE BLOCK-50MHz-100%RB

Module0, Beam ID:175, CP-OFDM							
	BANDWID TH	FREQUENC Y (MHz)	CHAN NEL	SCS	MODULATI ON	Peak (dBm)	Limit (dBm)
n261	50MHz	27525	LOW	120kHz	16QAM	-19.44	-5
n261	50MHz	27525	LOW	120kHz		-17.50	-13

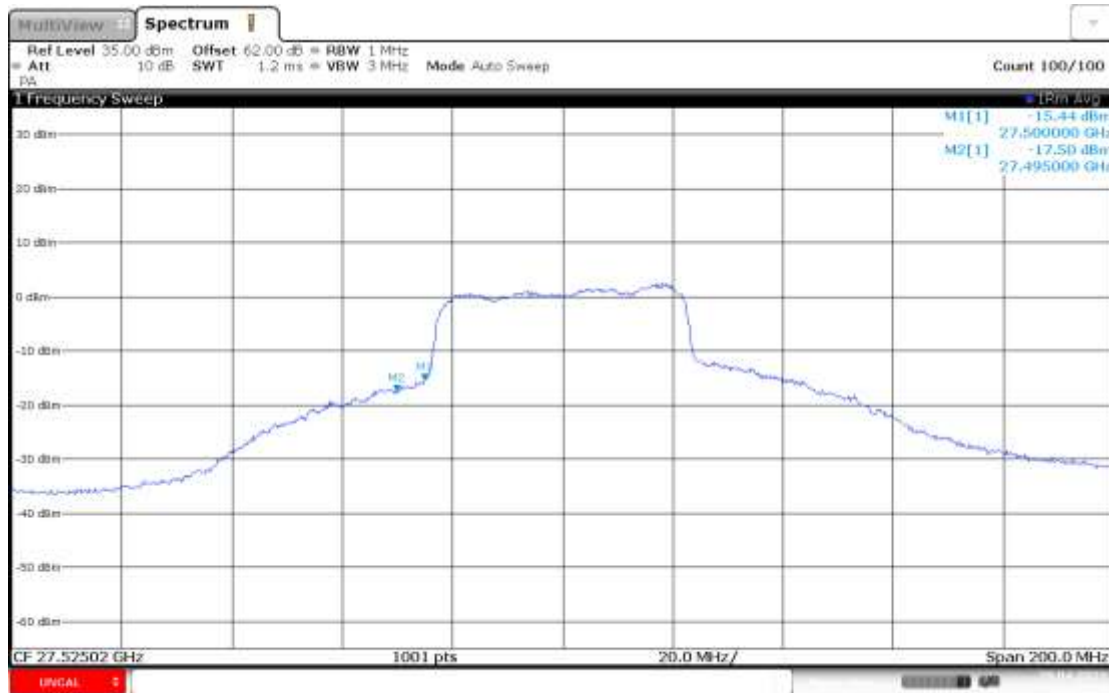

11:24:48 29.04.2021

HIGH BAND EDGE BLOCK-50MHz-100%RB

Module0, Beam ID:175, CP-OFDM							
	BANDWID TH	FREQUENC Y (MHz)	CHAN NEL	SCS	MODULATI ON	Peak (dBm)	Limit (dBm)
n261	50MHz	28324.92	HIGH	120kHz	16QAM	-19.46	-5
n261	50MHz	28324.92	HIGH	120kHz		-19.99	-13

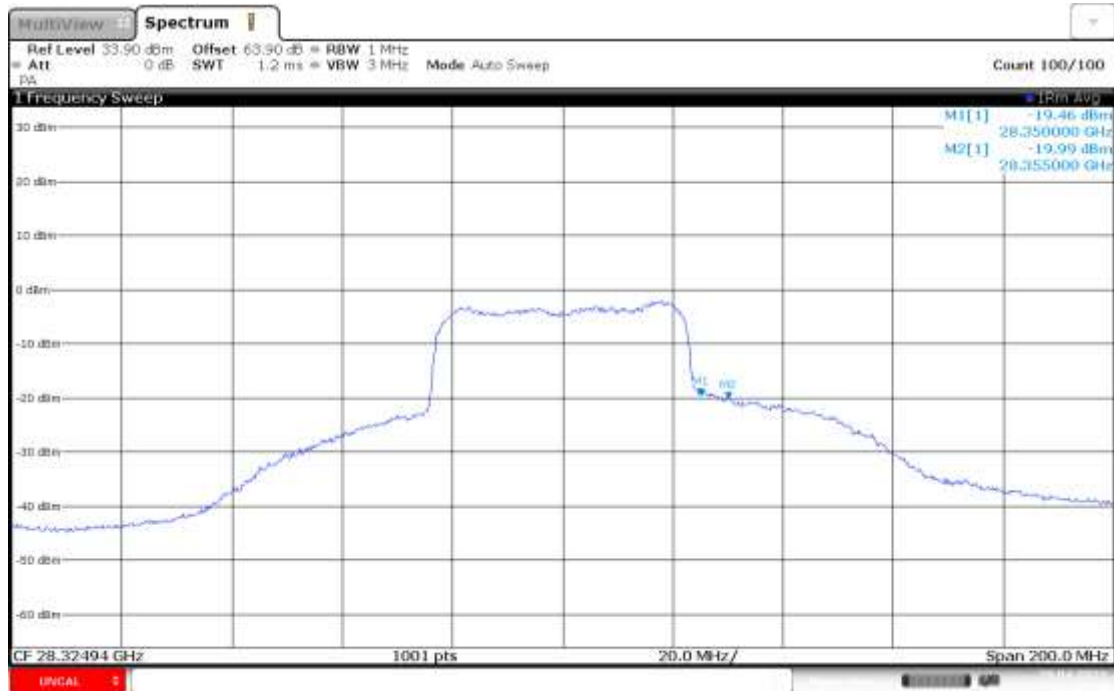

11:56:34 29.04.2021

LOW BAND EDGE BLOCK-50MHz-1RB

Module0, Beam ID:175, CP-OFDM							
	BANDWIDTH	FREQUENCY (MHz)	CHANNEL	SCS	MODULATION	Peak (dBm)	Limit (dBm)
n261	50MHz	27525	LOW	120kHz	QPSK	-20.46	-5
n261	50MHz	27525	LOW	120kHz		-34.25	-13

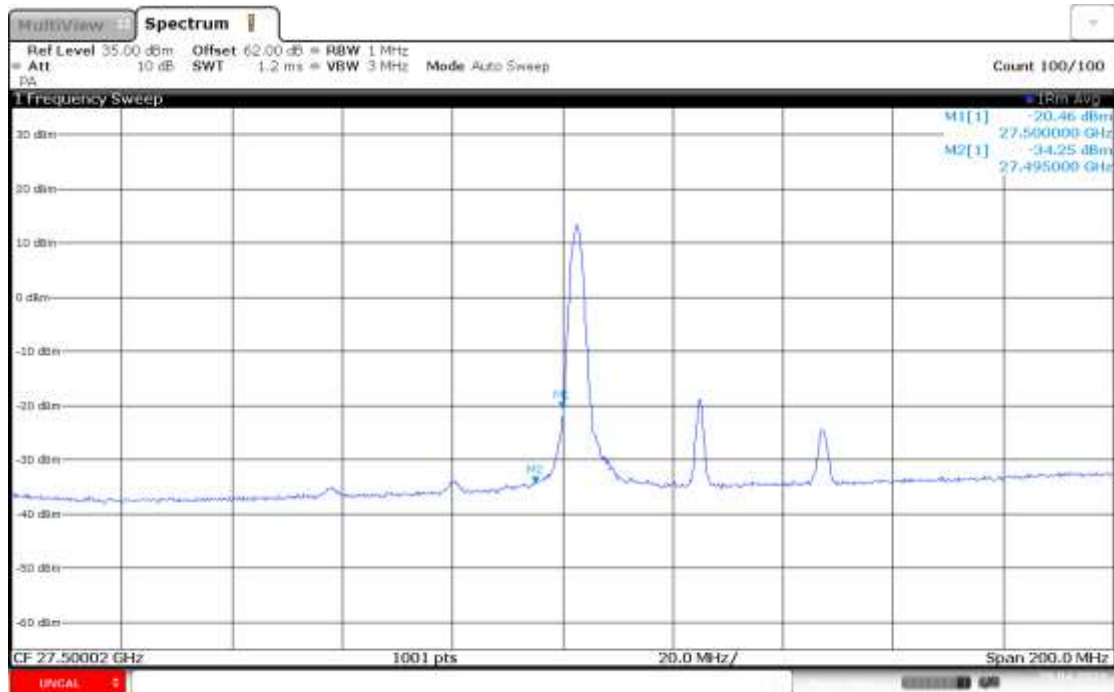

13:46:52 29.04.2021

HIGH BAND EDGE BLOCK-50MHz-1RB

Module0, Beam ID:175, CP-OFDM							
	BANDWID TH	FREQUENC Y (MHz)	CHAN NEL	SCS	MODULATI ON	Peak (dBm)	Limit (dBm)
n261	50MHz	28324.92	HIGH	120kHz	QPSK	-10.06	-5
n261	50MHz	28324.92	HIGH	120kHz		-34.85	-13

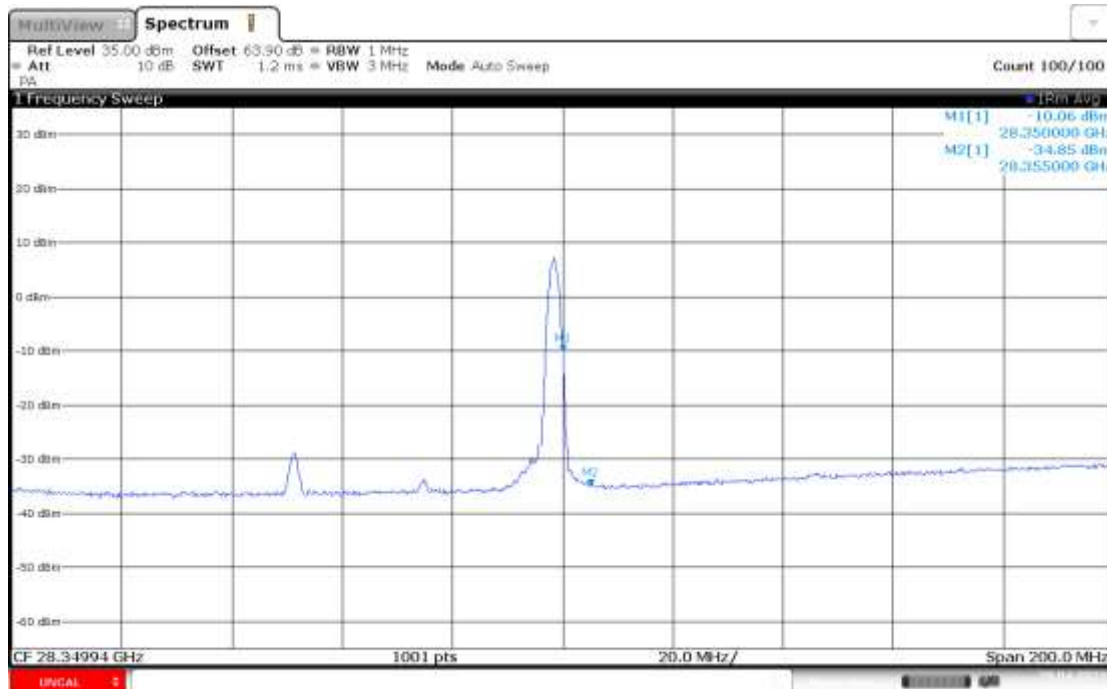

13:53:58 29.04.2021

LOW BAND EDGE BLOCK-100MHz-100%RB

Module0, Beam ID:175, CP-OFDM							
	BANDWID TH	FREQUENC Y (MHz)	CHAN NEL	SCS	MODULATI ON	Peak (dBm)	Limit (dBm)
n261	100MHz	27550.08	LOW	120kHz	QPSK	-21.31	-5
n261	100MHz	27550.08	LOW	120kHz		-22.92	-13

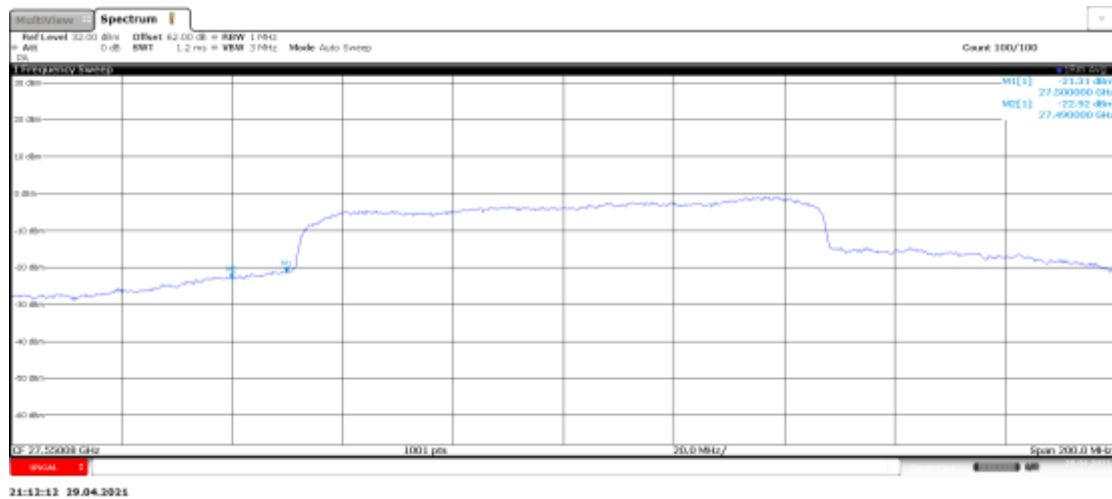

HIGH
BAND EDGE BLOCK-100MHz-100%RB

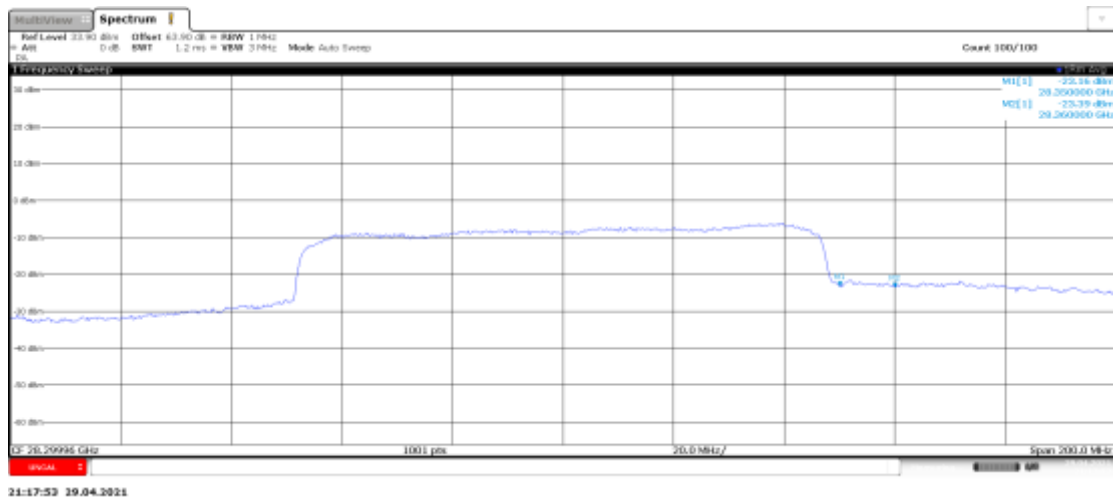
Module0, Beam ID:175, CP-OFDM							
	BANDWID TH	FREQUENC Y (MHz)	CHAN NEL	SCS	MODULATI ON	Peak (dBm)	Limit (dBm)
n261	100MHz	28299.96	HIGH	120kHz	QPSK	-23.16	-5
n261	100MHz	28299.96	HIGH	120kHz		-23.39	-13

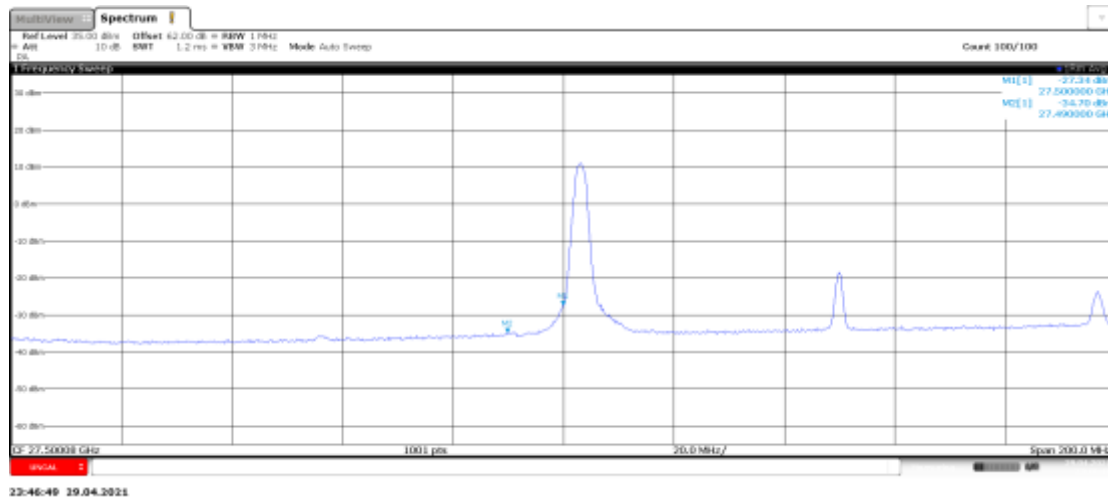

LOW BAND EDGE BLOCK-100MHz-1RB

Module0, Beam ID:175, CP-OFDM							
	BANDWIDTH	FREQUENCY (MHz)	CHANNEL	SCS	MODULATION	Peak (dBm)	Limit (dBm)
n261	100MHz	27550.08	LOW	120kHz	QPSK	-27.34	-5
n261	100MHz	27550.08	LOW	120kHz		-34.70	-13



HIGH BAND EDGE BLOCK-100MHz-1RB

Module0, Beam ID:175, CP-OFDM							
	BANDWIDTH	FREQUENCY (MHz)	CHANNEL	SCS	MODULATION	Peak (dBm)	Limit (dBm)
n261	100MHz	28299.96	HIGH	120kHz	QPSK	-20.73	-5
n261	100MHz	28299.96	HIGH	120kHz		-20.59	-13

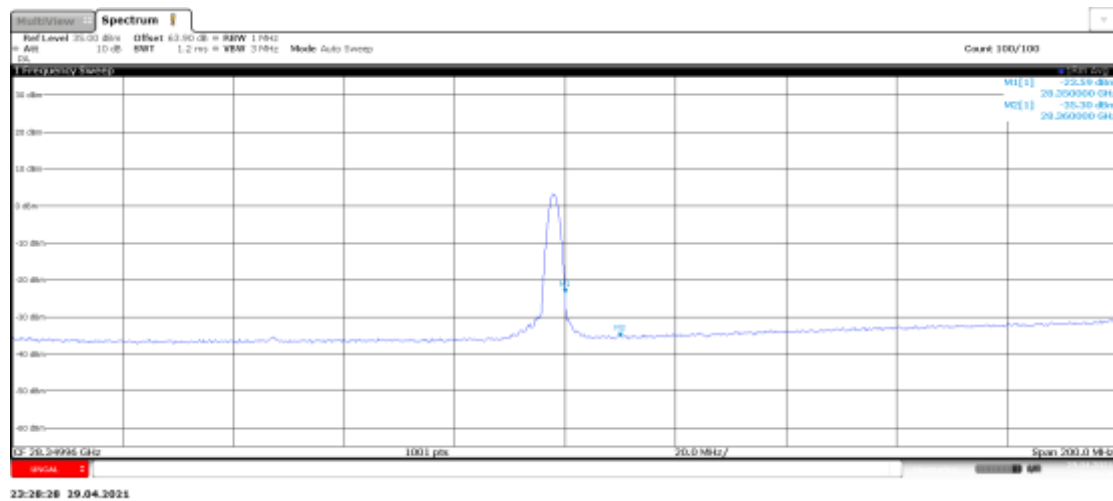

LOW BAND EDGE BLOCK-50MHz-100%RB

Module0, Beam ID:175, PUSCH DFT							
	BANDWID TH	FREQUENC Y (MHz)	CHAN NEL	SCS	MODULATI ON	Peak (dBm)	Limit (dBm)
n261	50MHz	27525	LOW	120kHz	64QAM	-14.37	-5
n261	50MHz	27525	LOW	120kHz		-14.80	-13

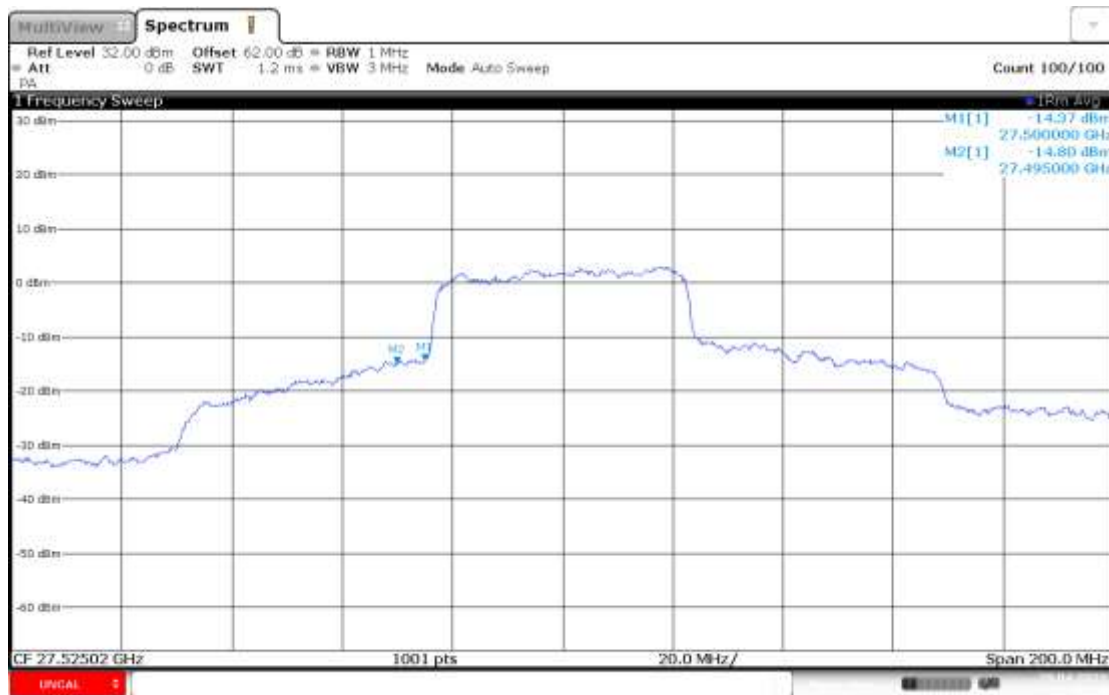

15:36:50 29.04.2021

HIGH BAND EDGE BLOCK-50MHz-100%RB

Module0, Beam ID:175, PUSCH DFT							
	BANDWID TH	FREQUENC Y (MHz)	CHAN NEL	SCS	MODULATI ON	Peak (dBm)	Limit (dBm)
n261	50MHz	28324.92	HIGH	120kHz	64QAM	-16.70	-5
n261	50MHz	28324.92	HIGH	120kHz		-16.83	-13

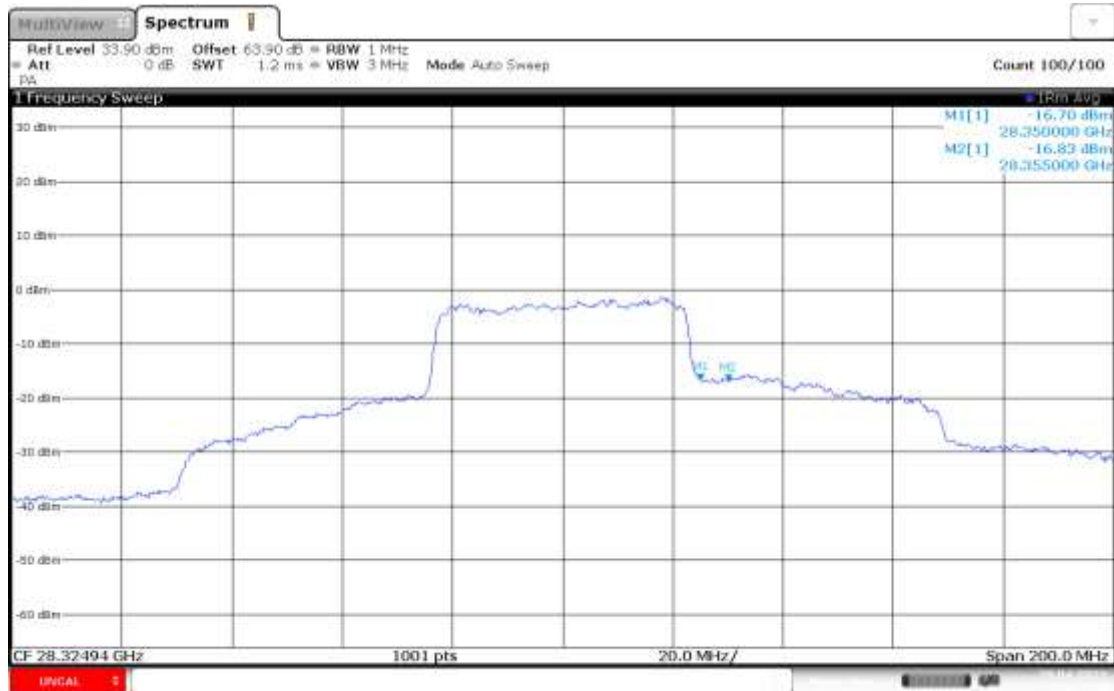

15:43:06 29.04.2021

LOW BAND EDGE BLOCK-50MHz-1RB

Module0, Beam ID:175, PUSCH DFT							
	BANDWIDTH	FREQUENCY	CHANNEL	SCS	MODULATION	Peak (dBm)	Limit (dBm)
n261	50MHz	27525	LOW	120kHz	16QAM	-15.65	-5
n261	50MHz	27525	LOW	120kHz		-33.79	-13

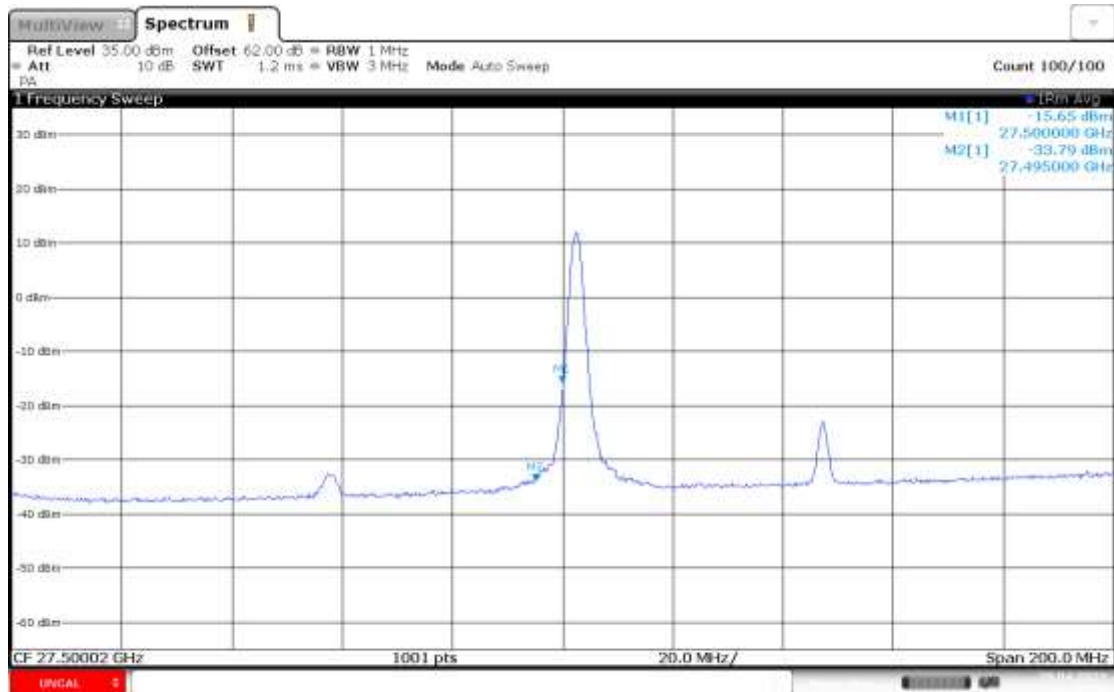

17:10:08 29.04.2021

HIGH BAND EDGE BLOCK-50MHz-1RB

Module0, Beam ID:175, PUSCH DFT							
	BANDWID TH	FREQUENC Y (MHz)	CHAN NEL	SCS	MODULATI ON	Peak (dBm)	Limit (dBm)
n261	50MHz	28324.92	HIGH	120kHz	16QAM	-5.51	-5
n261	50MHz	28324.92	HIGH	120kHz		-28.45	-13

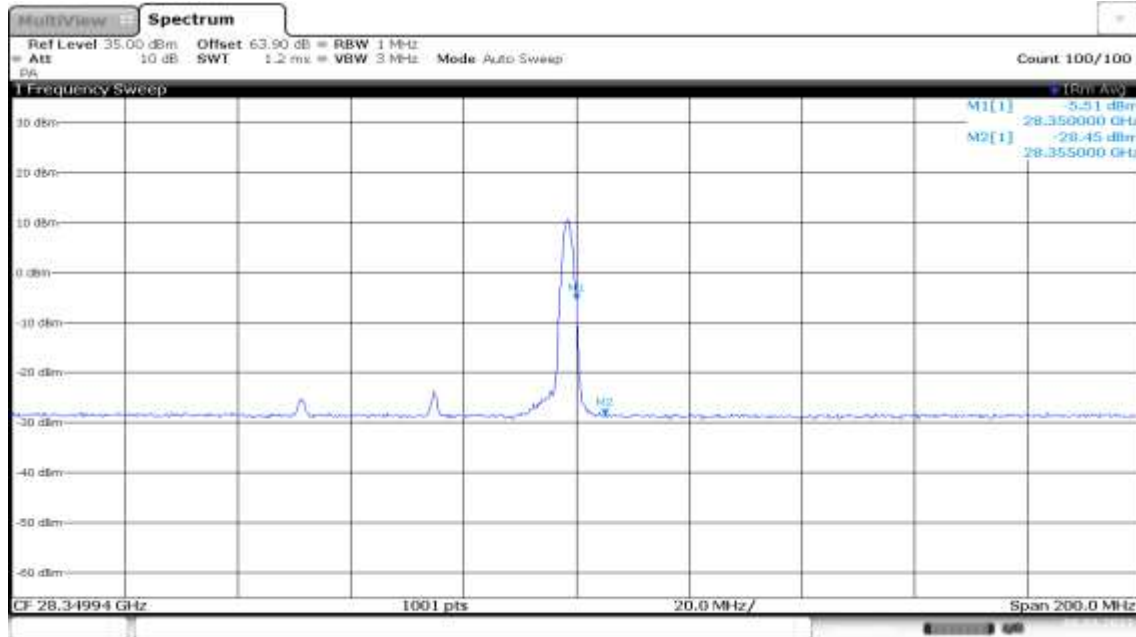

01:59:42 08.05.2021

LOW BAND EDGE BLOCK-100MHz-100%RB

Module0, Beam ID:175, PUSCH DFT							
	BANDWIDTH	FREQUENCY (MHz)	CHANNEL	SCS	MODULATION	Peak (dBm)	Limit (dBm)
n261	100MHz	27550.08	LOW	120kHz	16QAM	-19.87	-5
n261	100MHz	27550.08	LOW	120kHz		-21.26	-13

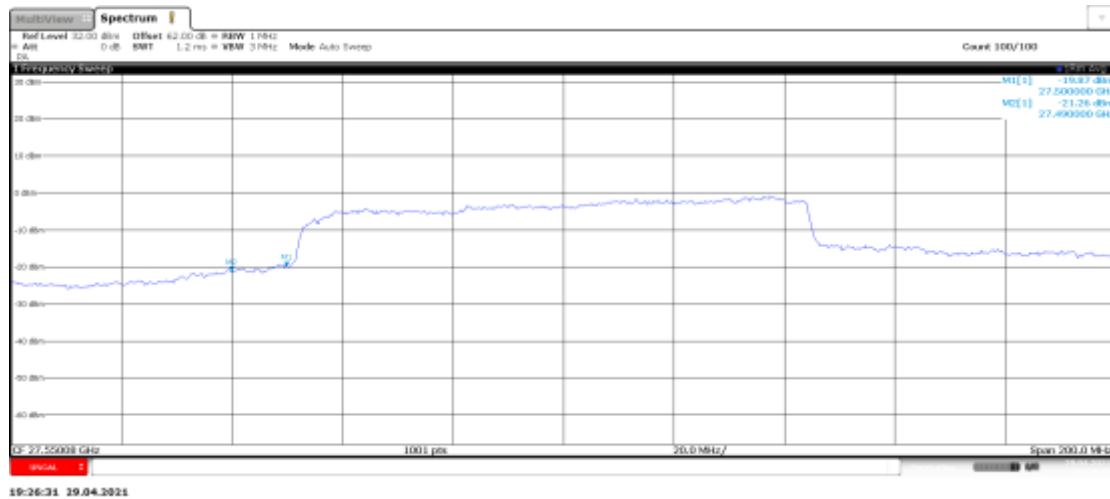

HIGH BAND EDGE BLOCK-100MHz-100%RB

Module0, Beam ID:175, PUSCH DFT							
	BANDWIDTH	FREQUENCY (MHz)	CHANNEL	SCS	MODULATION	Peak (dBm)	Limit (dBm)
n261	100MHz	28299.96	HIGH	120kHz	16QAM	-17.77	-5
n261	100MHz	28299.96	HIGH	120kHz		-17.29	-13

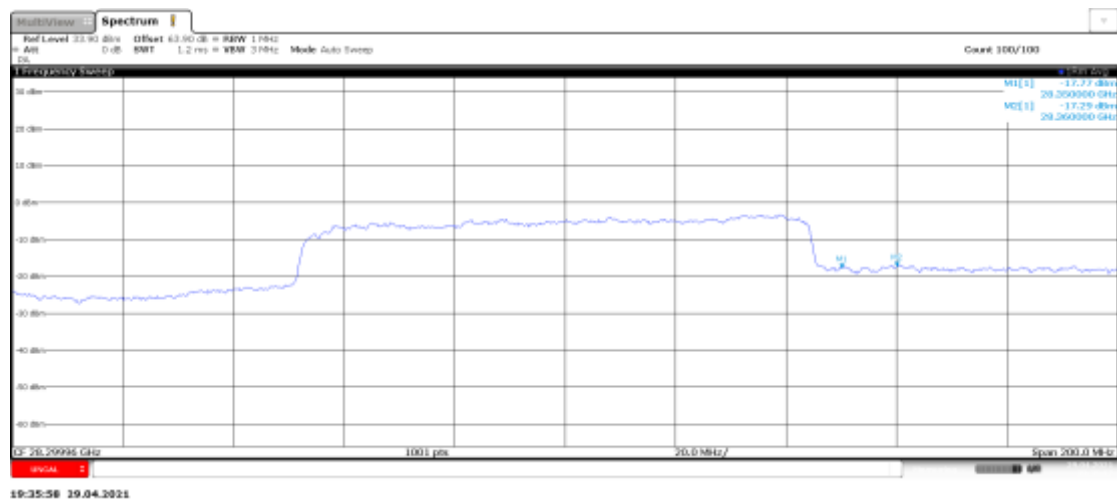

LOW BAND EDGE BLOCK-100MHz-1RB

Module0, Beam ID:175, PUSCH DFT							
	BANDWIDTH	FREQUENCY (MHz)	CHANNEL	SCS	MODULATION	Peak (dBm)	Limit (dBm)
n261	100MHz	27550.08	LOW	120kHz	64QAM	-22.46	-5
n261	100MHz	27550.08	LOW	120kHz		-35.23	-13

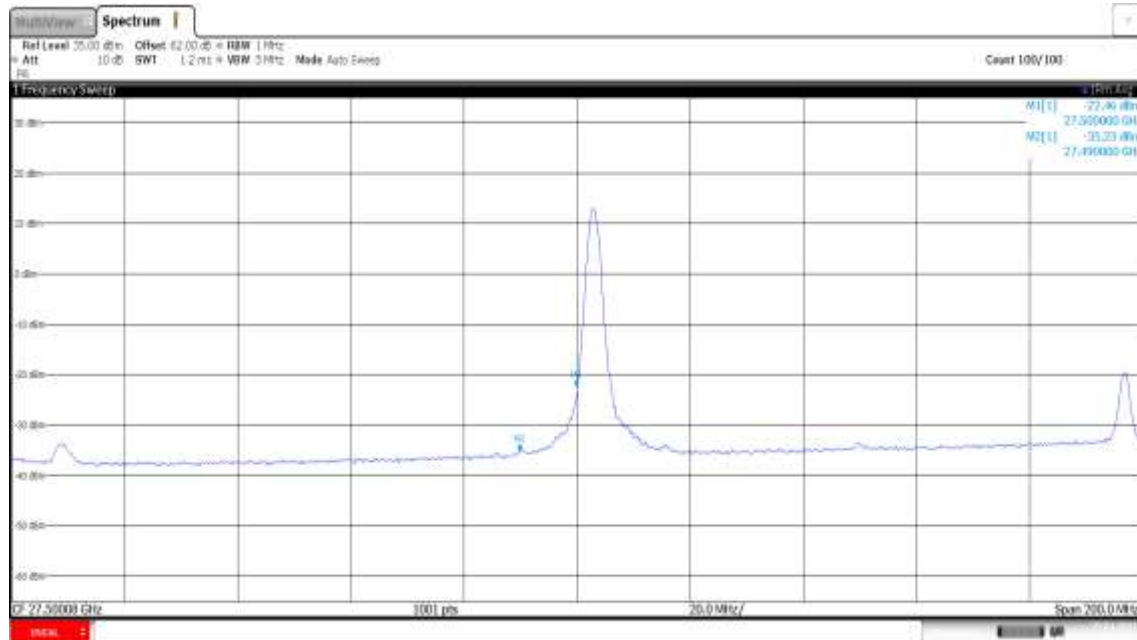

20:17:34 29.04.2021

LOW BAND EDGE BLOCK-50MHz-1%RB

Module1, Beam ID:157, PUSCH DFT							
	BANDWIDTH	FREQUENCY (MHz)	CHANNEL	SCS	MODULATION	Peak (dBm)	Limit (dBm)
n261	50MHz	27525	LOW	120kHz	16QAM	-32.10	-5
n261	50MHz	27525	LOW	120kHz		-35.62	-13

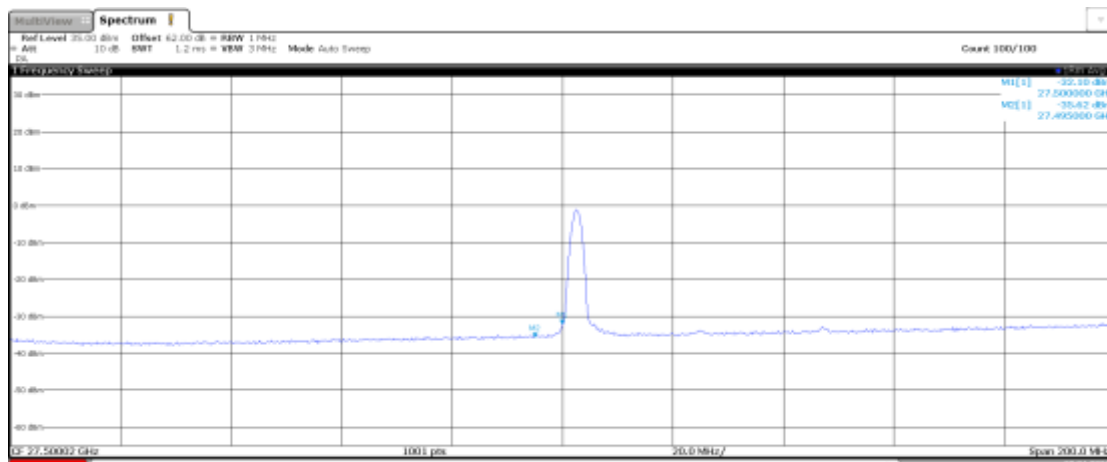

02:06:41 30.04.2021

HIGH BAND EDGE BLOCK-50MHz-1%RB

Module1, Beam ID:157, PUSCH DFT							
	BANDWIDTH	FREQUENCY (MHz)	CHANNEL	SCS	MODULATION	Peak (dBm)	Limit (dBm)
n261	50MHz	28324.92	HIGH	120kHz	16QAM	-21.55	-5
n261	50MHz	28324.92	HIGH	120kHz		-35.29	-13

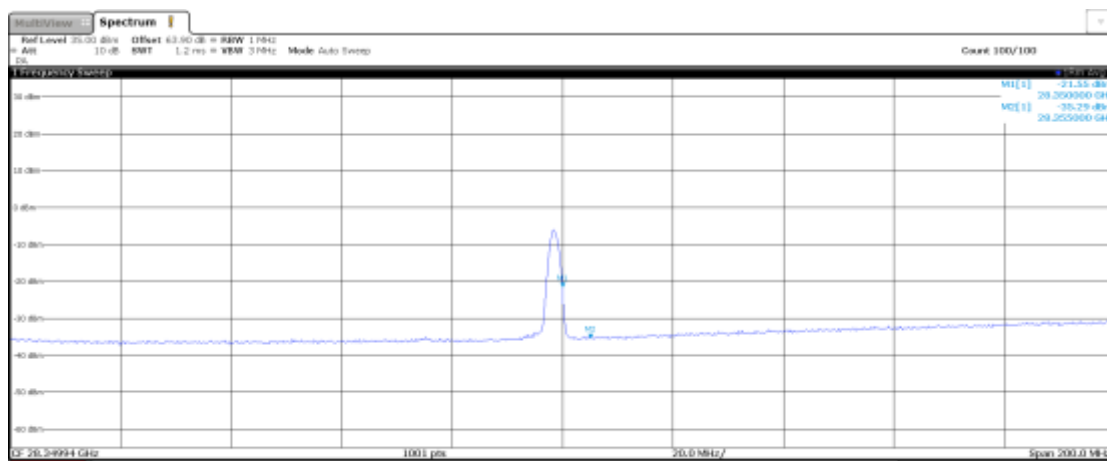

00:52:31 30.04.2021

LOW BAND EDGE BLOCK-50MHz-1RB

Module2, Beam ID:180, PUSCH DFT							
	BANDWIDTH	FREQUENCY (MHz)	CHANNEL	SCS	MODULATION	Peak (dBm)	Limit (dBm)
n261	50MHz	27525	LOW	120kHz	16QAM	-27.46	-5
n261	50MHz	27525	LOW	120kHz		-35.87	-13

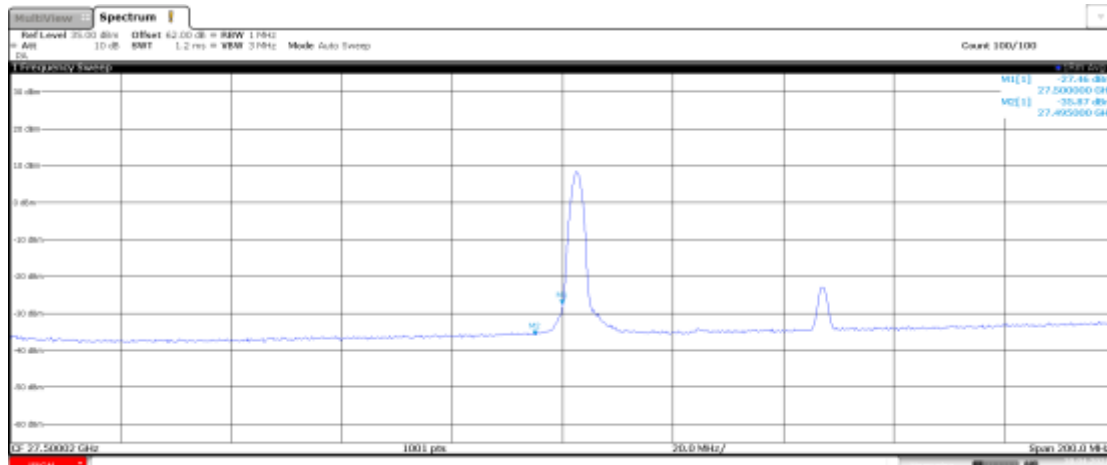

02:21:46 30.04.2021

HIGH BAND EDGE BLOCK-50MHz-1RB

Module2, Beam ID:180, PUSCH DFT							
	BANDWIDTH	FREQUENCY (MHz)	CHANNEL	SCS	MODULATION	Peak (dBm)	Limit (dBm)
n261	50MHz	28324.92	HIGH	120kHz	16QAM	-15.23	-5
n261	50MHz	28324.92	HIGH	120kHz		-35.55	-13

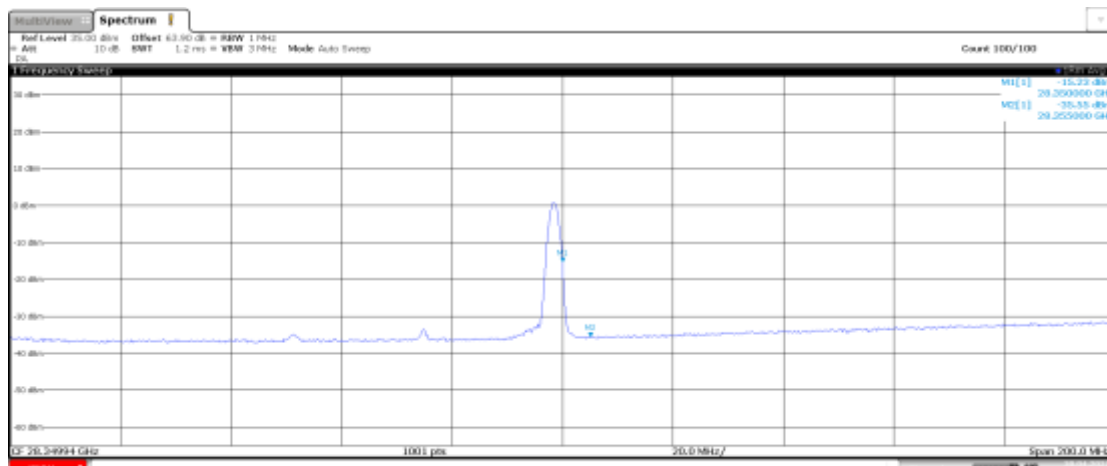

02:29:43 30.04.2021

Annex B: Calibration Certificates List

Signal Generator	SMF100A	104940	R&S	2021-12-09	1 year
------------------	---------	--------	-----	------------	--------



中国认可
国际互认
校准
CALIBRATION
CNAS L0570

校准证书

证书编号: J20X12055

客户名称 中国泰尔实验室
客户地址 北京市海淀区花园北路 52 号
器具名称 信号发生器
型号/规格 SMF100A
出厂编号 104940
制造单位 ROHDE&SCHWARZ 公司
校准日期 2020 年 12 月 10 日

所测数据符合该仪表说明书技术指标要求。



批准人: 国峰
核验员: 董修年
校准员: 成铭

地址: 北京海淀区花园北路 52 号通信计量中心

电话: +86-10-62301383

邮编: 100191

传真: +86-10-62304104

网址: www.chinattl.com

Email: cal@caict.ac.cn

Signal Generator	E8257D (60GHz)	MY59140557	Keysight	2022-01-19	1 year
------------------	----------------	------------	----------	------------	--------

No. RAG202101178

第 1 页 共 8 页
Page 1 This certificate include 8 Pages

北京无线电计量测试研究所

中国认可
校准
CALIBRATION
CNAS L1665

Beijing Institute of Radio Metrology and Measurement
中国航天科工集团第二研究院二〇三所
国防科技工业第二计量测试研究中心

校准证书

Certificate of Calibration

委托单位: 中国泰尔实验室
Customer

地址: 海淀区花园北路 52 号
Address

被测样品: 信号发生器
EUT/DUT

编号: MY59140557
No.

型号: E8257D
Type

制造商: 是德
Manufacturer

校准人: 
Operator

接收日期: 2021 年 1 月 18 日
Acceptance date Year Month Day

核验人: 
Inspector

校准日期: 2021 年 1 月 20 日
Calibration date Year Month Day

批准人: 
Approver

发证单位:
Issued by (stamp)

本实验室地址(Add): 北京市海淀区永定路 50 号
No.50 Yongding Road, Haidian District, Beijing

通信地址: 北京 142 信箱 408 分箱
P. O. Box: 3930, Beijing China

服务电话(Tel): 010-68385358

监督电话(Tel): 010-68387448

邮政编码(Post Code): 100854

传真(Fax): 86-10-68385470



Antenna	VULB 9163	483	SCHWARZBE CK	2021/8/27	1 year
---------	-----------	-----	-----------------	-----------	--------

中国计量科学研究院 

 **校准证书**
Calibration Certificate

证书编号 XDt_x2020-01130
Certificate No.

客户名称 Client	中国泰尔实验室
器具名称 Instrument	复合天线 Hybrid Antenna
型号/规格 Type/Model	VULB 9163
出厂编号 Serial No.	483
生产厂商 Manufacturer	SCHWARZBECK
联络信息 Contact Information	北京市海淀区花园北路 52 号
校准日期 Date of Calibration	2020-08-28
接收日期 Date of Receiving	2020-08-14

批准人: 刘科
Approved by

发布日期: 2020 年 8 月 28 日
Date of Issue

地址: 中国北京北三环东路 18 号 Address: No.18 Bei San Huan Dong Lu, Beijing, P.R.China	邮编: 100029 Post Code
电话: +86-10-64525569/74 Tel	传真: +86-10-64271948 Fax
网址: http://www.nim.ac.cn Website	电子邮箱: kehufuwu@nim.ac.cn Email

第1页共8页
Page of

2019-jz-R0520

中国计量科学研究院



证书编号 XDTx2020-01130
Certificate No.

校准结果 Calibration Results

四、数据曲线 Data Curves

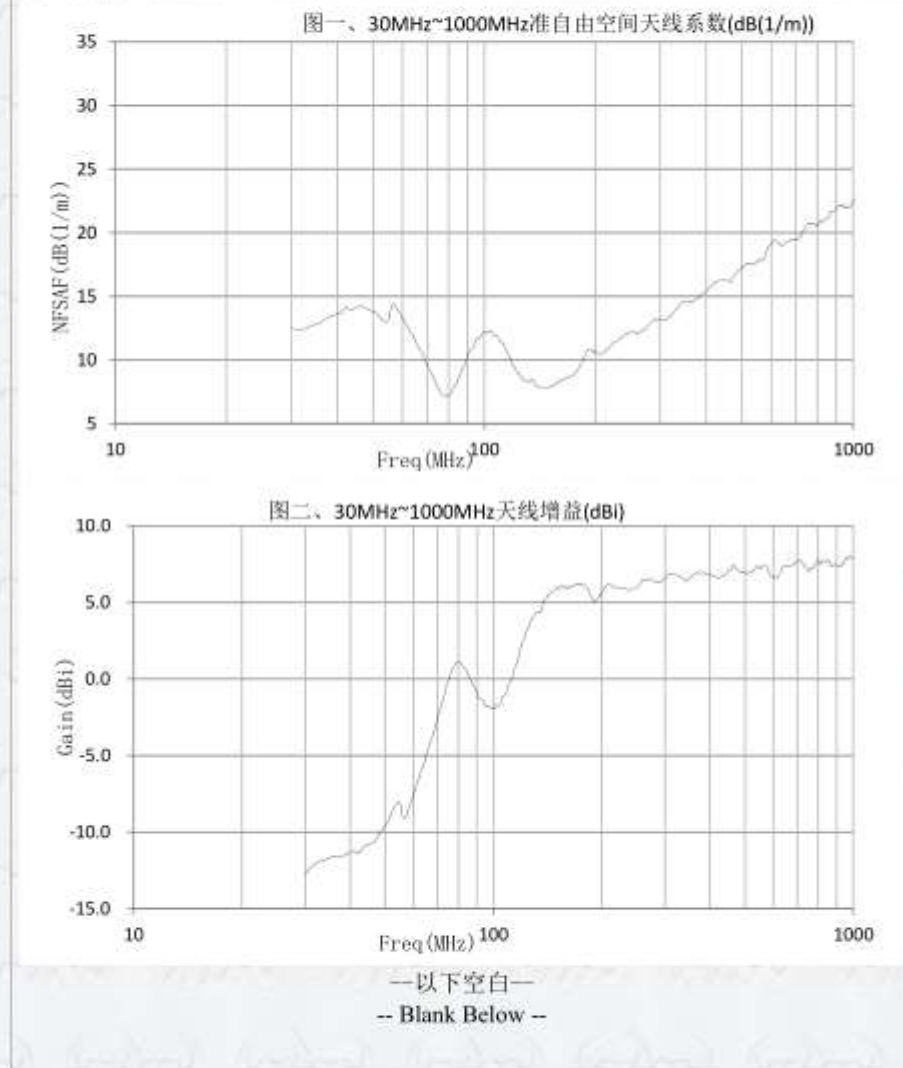

Antenna	3115	6914	ETS-Lindgren	2022/2/3	1 year
---------	------	------	--------------	----------	--------

中国计量科学研究院



中国认可
国际互认
校准
CALIBRATION
CNAS L0502

校准证书

Calibration Certificate

证书编号 XDtX2021-10054
Certificate No.

客户名称
Client 中国泰尔实验室

器具名称
Instrument 喇叭天线

型号/规格
Type/Model 3115

出厂编号
Serial No. 6914

生产厂商
Manufacturer ETS

联络信息
Contact Information 北京市海淀区花园北路 52 号

校准日期
Date of Calibration 2021-02-03

接收日期
Date of Receiving 2021-01-21

批准人：
Approved by 郭晓涛

发布日期： 2021 年 02 月 03 日
Date of Issue



地址：中国北京北三环东路 18 号
Address: No.18 Bei San Huan Dong Lu, Beijing, P.R.China

电话：+86-10-64525569/74
Tel

网址：http://www.nim.ac.cn
Website

邮编：100029
Post Code

传真：+86-10-64271948
Fax

电子邮箱：kehufuwu@nim.ac.cn
Email

中国计量科学研究院



证书编号 XDLx2021-10054
Certificate No.

校准结果 Calibration Results

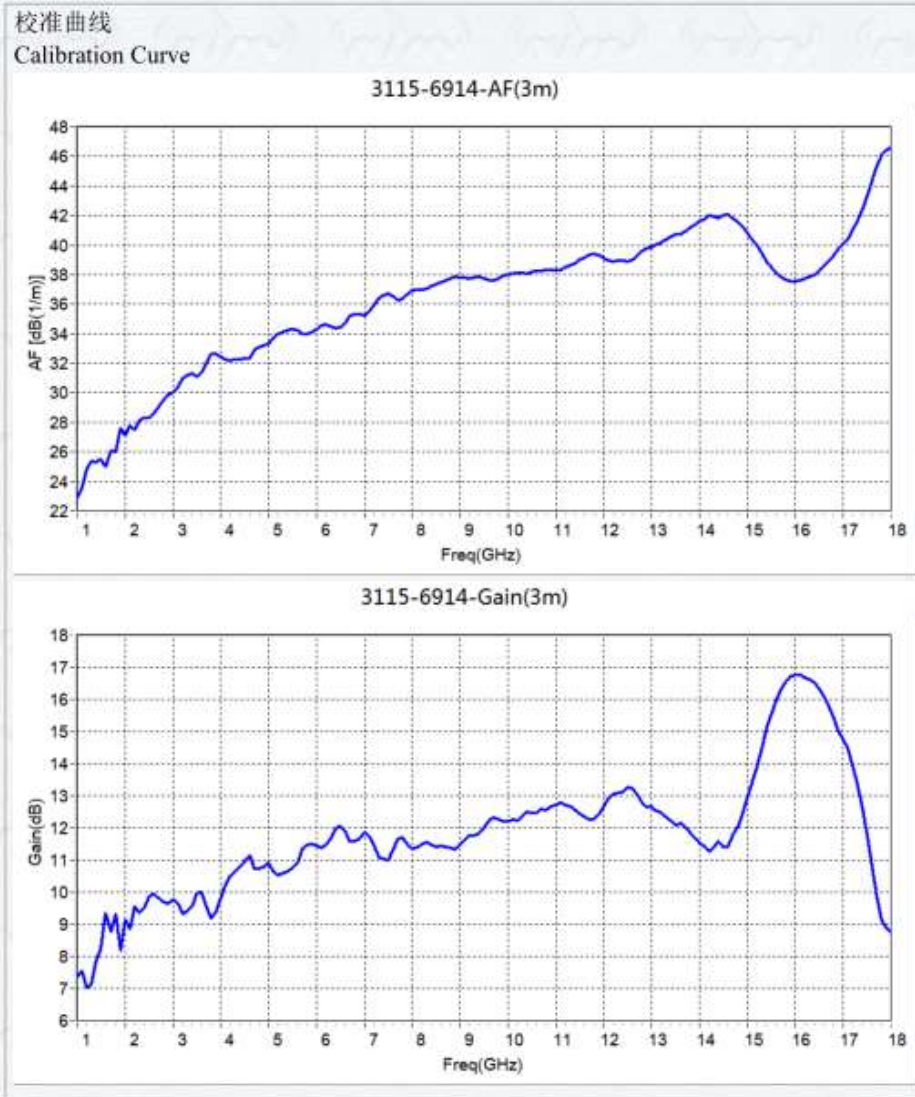

Upconverter(50GHz-75GHz)	SMZ-75	101309	R&S	2022-01-14	1 year
--------------------------	--------	--------	-----	------------	--------

中国计量科学研究院



中国认可
国际互认
校准
CALIBRATION
CNAS L0502

校准证书

证书编号 XDxh2021-10059

客户名称 中国泰尔实验室

器具名称 SMZ75 倍频源

型号/规格 SMZ75

出厂编号 101309

生产厂商 Rohde & Schwarz

联络信息 北京市海淀区花园北路 52 号

校准日期 2021-01-15

接收日期 2021-01-08

批准人:



发布日期: 2021 年 03 月 16 日

地址: 北京北三环东路 18 号

邮编: 100029

电话: 010-64525569/74

传真: 010-64271948

网址: <http://www.nim.ac.cn>

电子邮箱: kehufuwu@nim.ac.cn

2019-jz-R0520

第1页共4页

Upconverter(75GHz-110GHz)	SMZ-110	101357	R&S	2022-01-14	1 year
---------------------------	---------	--------	-----	------------	--------

中国计量科学研究院



中国认可
国际互认
校准
CALIBRATION
CNAS L0502

校准证书

证书编号 XDxh2021-10060

客户名称 中国泰尔实验室

器具名称 SMZ110 倍频源

型号/规格 SMZ110

出厂编号 101357

生产厂商 Rohde & Schwarz

联络信息 北京市海淀区花园北路 52 号

校准日期 2021-01-15

接收日期 2021-01-08

批准人：



发布日期： 2021 年 03 月 16 日

地址：北京北三环东路 18 号

邮编：100029

电话：010-64525569/74

传真：010-64271948

网址：<http://www.nim.ac.cn>

电子邮箱：kehufuwu@nim.ac.cn

2019-jz-R0520

第1页共4页

Upconverter(110GHz-170GHz)/	82406B	ZEI00141	Ceyear	2022-02-04	1 year
-----------------------------	--------	----------	--------	------------	--------

中国计量科学研究院



中国认可
国家互认
校准
CALIBRATION
CNAS L0902

校准证书

证书编号 XDgp2021-10237

客户名称 中国泰尔实验室

器具名称 信号源倍频器

型号/规格 82406B

出厂编号 ZEI00141

生产厂商 中电科仪器仪表有限公司

联络信息 北京市海淀区花园北路 52 号

校准日期 2021 年 02 月 05 日

接收日期 2021 年 01 月 08 日

批准人: 赵科佳



发布日期: 2021 年 02 月 08 日

地址: 北京北三环东路 18 号

邮编: 100029

电话: 010-64525569/74

传真: 010-64271948

网址: <http://www.nim.ac.cn>

电子邮箱: kehufuwu@nim.ac.cn

2019-jz-R0520

第1页共6页

Upconverter(170GHz-220GHz)/	82406C	ZEI00164	Ceyear	2022-02-04	1 year
-----------------------------	--------	----------	--------	------------	--------

中国计量科学研究院



中国认可
国际互认
校准
CALIBRATION
CNAS L0502

校准证书

证书编号 XDgp2021-10238

客户名称 中国泰尔实验室

器具名称 信号源倍频器

型号/规格 82406C

出厂编号 ZEI00164

生产厂商 中电科仪器仪表有限公司

联络信息 北京市海淀区花园北路 52 号

校准日期 2021 年 02 月 05 日

接收日期 2021 年 01 月 08 日

批准人: 赵科佳



发布日期: 2021 年 02 月 08 日

地址: 北京北三环东路 18 号

邮编: 100029

电话: 010-64525569/74

传真: 010-64271948

网址: <http://www.nim.ac.cn>

电子邮箱: kehufuwu@nim.ac.cn

2019-jz-R0520

第1页共5页

Spectrum Analyzer	FSW67	103290	R&S	2022-02-04	1 year
-------------------	-------	--------	-----	------------	--------

No. RSA202101150

第 1 页 共 11 页
Page 1 This certificate include 11 Pages

北京无线电计量测试研究所

Beijing Institute of Radio Metrology and Measurement

中国航天科工集团第二研究院二〇三所

国防科技工业第二计量测试研究中心

中国认可
校准

校准证书

CALIBRATION Certificate of Calibration

CNAS L1665

委托单位: 中国泰尔实验室
Customer地址: 海淀区花园北路 52 号
Address被测样品: 频谱分析仪
EUT/DUT编号: 103290
No.型号: FSW67
Type制造商: R/S
Manufacturer校准人: 武平
Operator接收日期: 2021 年 1 月 18 日
Acceptance date Year Month Day核验人: 吴远任
Inspector校准日期: 2021 年 1 月 20 日
Calibration date Year Month Day批准人: 陈云梅
Approver发证单位:
Issued by (stamp)本实验室地址(Add): 北京市海淀区永定路 50 号
No.50 Yongding Road, Haidian District, Beijing通信地址: 北京 142 信箱 408 分箱
P. O. Box: 3930, Beijing China

服务电话(Tel): 010-68385358

监督电话(Tel): 010-68387448

邮政编码(Post Code): 100854

传真(Fax): 86-10-68385470



(downconverter)Harmonic Mixer(60GHz-90GHz)	FS-Z90	101655	R&S	2022-02-04	1 year
--	--------	--------	-----	------------	--------

中国计量科学研究院



校准证书

证书编号 XDxh2021-10057

客户名称 中国泰尔实验室

器具名称 FS-Z90 混频器

型号/规格 FS-Z90

出厂编号 101655

生产厂商 Rohde & Schwarz

联络信息 北京市海淀区花园北路 52 号

校准日期 2021-01-15

接收日期 2021-01-08

批准人: 何昭



发布日期: 2021 年 01 月 20 日

地址: 北京北三环东路 18 号

邮编: 100029

电话: 010-64525569/74

传真: 010-64271948

网址: <http://www.nim.ac.cn>

电子邮箱: kehufuwu@nim.ac.cn

2019-jz-R0520

第1页共4页

(downconverter)Harmonic Mixer(75GHz-110GHz)	FS-Z110	101463	R&S	2022-01-19	1 year
---	---------	--------	-----	------------	--------

中国计量科学研究院
校准证书



证书编号 XDxh2021-10058

客户名称 中国泰尔实验室

器具名称 FS-Z110 混频器

型号/规格 FS-Z110

出厂编号 101463

生产厂商 Rohde & Schwarz

联络信息 北京市海淀区花园北路 52 号

校准日期 2021-01-15

接收日期 2021-01-08

批准人: 何明



发布日期: 2021 年 01 月 20 日

地址: 北京北三环东路 18 号

邮编: 100029

电话: 010-64525569/74

传真: 010-64271948

网址: <http://www.nim.ac.cn>

电子邮箱: kehufuwu@nim.ac.cn

2019-jz-R0520

第1页共4页

(downconverter)Harmonic Mixer(110GHz-170GHz)/	FS-Z170	101008	R&S	2022-02-17	1 year
---	---------	--------	-----	------------	--------



Calibration Certificate

Certificate Number **24-0170-101008-01**

Kalibrierschein

Zertifikatsnummer

Unit Data

Item **Harmonic Mixer, 110 GHz to 170 GHz**
Gegenstand

Manufacturer **RPG Radiometer-Physics GmbH**
Hersteller

Type **RPG FS-Z170**
Typ

Material Number **3622.0714.02** Serial Number **101008**
Materialnummer Seriennummer

Asset Number
Inventarnummer

This calibration certificate documents, that the named item is tested and measured against defined specifications. Measurement results are located usually in the corresponding interval with a probability of approx. 95% (coverage factor $k = 2$). Calibration is performed with test equipment and standards directly or indirectly traceable to the PTB/DKD or other national/international standards, which realize the physical units of measurement according to the International System of Units (SI). In all cases where no standards are available, measurements are referenced to standards of the R&S laboratories. Principles and methods of calibration correspond with EN ISO/IEC 17025. This calibration certificate may not be reproduced other than in full. Calibration certificates without signatures are not valid. The user is obliged to have the object recalibrated at appropriate intervals.

Order Data

Customer
Auftraggeber

Order Number
Bestellnummer

Date of Receipt
Eingangdatum

Performance

Place and Date of Calibration
Ort und Datum der Kalibrierung

Meckenheim, 2021-02-18

Scope of Calibration
Umfang der Kalibrierung

Standard Calibration

Statement of Compliance
(Incoming)
Konformitätsaussage
(Anlieferung)

New device

Statement of Compliance
(Outgoing)
Konformitätsaussage
(Auslieferung)

All measured values are within the data sheet specifications.

Extend of Calibration Documents
Umfang des Kalibrierdokuments

**2 pages Calibration Certificate
4 pages Outgoing Results**

Dieser Kalibrierschein dokumentiert, dass der genannte Gegenstand nach festgelegten Vorgaben geprüft und gemessen wurde. Die Messwerte lagen im Regelfall mit einer Wahrscheinlichkeit von annähernd 95% im zugeordneten Wertintervall (Erweiterte Messunsicherheit mit $k = 2$). Die Kalibrierung erfolgte mit Messmitteln und Normale, die direkt oder indirekt durch Ableitung mittels anerkannter Kalibriertechniken rückgeführt sind auf Normale der PTB/DKD oder anderer nationaler/internationaler Standards zur Darstellung der physikalischen Einheiten in Übereinstimmung mit dem internationalen Einheitensystem (SI). Wenn keine Normale existieren, erfolgt die Rückführung auf Bezugnormale der R&S-Laboratorien. Grundsätze und Verfahren der Kalibrierung beziehen sich auf EN ISO/IEC 17025. Dieser Kalibrierschein darf nur vollständig und unverändert weiterverbreitet werden. Kalibrierscheine ohne Unterschriften sind ungültig. Für die Einhaltung einer angemessenen Frist zur Wiederholung der Kalibrierung ist der Benutzer verantwortlich.

RPG Radiometer-Physics GmbH; Meckenheim

Date of Issue
Ausstellungsdatum

2021-02-22

Head of Laboratory
Laborleitung

Schulze

Person Responsible
Bearbeiter

Heinze

Page (Seite) 1/2
Vers2010-05-05/
RPG2014-02-28

(downconverter)Harmonic Mixer(170GHz-220GHz)/	FS-Z220	101054	R&S	2021-12-14	1 year
---	---------	--------	-----	------------	--------



Calibration Certificate

Kalibrierschein

Certificate Number **24-0220-101054-01**
Zertifikatsnummer

Unit Data

Item: **Harmonic Mixer, 140 GHz to 220 GHz**
Gegenstand

Manufacturer: **RPG Radiometer-Physics GmbH**
Hersteller

Type: **RPG FS-Z220**
Typ

Material Number: **3593.3250.02** Serial Number: **101054**
Materialnummer Seriennummer

Asset Number:
Inventarnummer

This calibration certificate documents, that the named item is tested and measured against defined specifications. Measurement results are located usually in the corresponding interval with a probability of approx. 95% (coverage factor $k = 2$). Calibration is performed with test equipment and standards directly or indirectly traceable by means of approved calibration techniques to the PTB/DKD or other national/international standards, which realize the physical units of measurement according to the International System of Units (SI). In all cases where no standards are available, measurements are referenced to standards of the R&S laboratories. Principles and methods of calibration correspond with EN ISO/IEC 17025. This calibration certificate may not be reproduced other than in full. Calibration certificates without signatures are not valid. The user is obliged to have the object recalibrated at appropriate intervals.

Order Data

Customer:
Auftraggeber

Order Number:
Bestellnummer

Date of Receipt:
Eingangsdatum

Performance

Place and Date of Calibration:
Ort und Datum der Kalibrierung

Scope of Calibration:
Umfang der Kalibrierung

Statement of Compliance (Incoming):
Konformitätsaussage (Anlieferung)

Statement of Compliance (Outgoing):
Konformitätsaussage (Auslieferung)

Extend of Calibration Documents:
Umfang des Kalibrierdokuments

Meckenheim, 2020-12-15

Standard Calibration

New device

All measured values are within the data sheet specifications.

**2 pages Calibration Certificate
4 pages Outgoing Results**

Dieser Kalibrierschein dokumentiert, dass der genannte Gegenstand nach festgelegten Vorgaben geprüft und gemessen wurde. Die Messwerte lagen im Regelfall mit einer Wahrscheinlichkeit von annähernd 95% im zugeordneten Wertintervall (Erweiterte Messunsicherheit mit $k = 2$). Die Kalibrierung erfolgte mit Messmitteln und Normalen, die direkt oder indirekt durch Ableitung mittels anerkannter Kalibriertechniken rückgeführt sind auf Normale der PTB/DKD oder anderer nationaler/internationaler Standards zur Darstellung der physikalischen Einheiten in Übereinstimmung mit dem internationalen Einheitensystem (SI). Wenn keine Normale existieren, erfolgt die Rückführung auf Bezugsnormale der R&S-Laboratorien. Grundsätze und Verfahren der Kalibrierung beziehen sich auf EN ISO/IEC 17025. Dieser Kalibrierschein darf nur vollständig und unverändert weiterverbreitet werden. Kalibrierscheine ohne Unterschriften sind ungültig. Für die Einhaltung einer angemessenen Frist zur Wiederholung der Kalibrierung ist der Benutzer verantwortlich.

RPG Radiometer-Physics GmbH; Meckenheim

Date of Issue:
Ausstellungsdatum

2020-12-17

Head of Laboratory:
Laborleitung

Schulze

Person Responsible:
Bearbeiter

Dick

Page (Seite) 1/2
Vers2010-05-05/
RPG2014-02-28

Standard Gain Horn (40GHz-60GHz)	LB-19-25	J202024086	A-INFO	2022-01-14	1 year
-------------------------------------	----------	------------	--------	------------	--------

A-INFO 英联微波

LB-19-25
40.0 - 60.0GHz 标准增益喇叭天线

技术指标



频率(GHz)	A 型, 波导输出	40.0 - 60.0
	C 型, 2.4mm-50K 输出	40.0 - 50.0
	C 型, 1.85mm-50K 输出	40.0 - 60.0
增益(dB)	25 典型值	
驻波	1.6 最大值	
3dB 波束宽度(°)	10 典型值	
波导型号	BJ500(WR19)	
材料	铜	
输出形式	A 型 FUGP500	
	C 型 2.4mm-50K 或 1.85mm-50K	
尺寸(mm) 宽 x 高 x 长	A 型, 波导输出	49x41x130
	C 型, 2.4mm-50K 输出	49x41x155
	C 型, 1.85mm-50K 输出	49x41x157
净重(Kg)	A 型, 波导输出	约 0.15
	C 型, 2.4mm-50K 输出	约 0.18
	C 型, 1.85mm-50K 输出	约 0.18

外形图 (尺寸: mm)

A 型

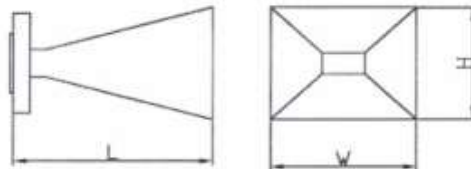

宽 x 高 x 长: 49x41x130

C 型

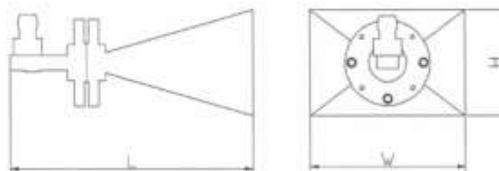

宽 x 高 x 长: 49x41x157

英联微波

第 1 页 / 共 7 页

北京 电话: 010-6266-7326 或 010-6266-7327
成都 电话: 028-8519-2786 或 028-8519-3047

传真: 010-6266-7379
传真: 028-8519-3068

网址: www.ainfoinc.com
www.ainfoinc.cn

测试报告仅供参考, 详情请咨询: Sales@ainfoinc.com

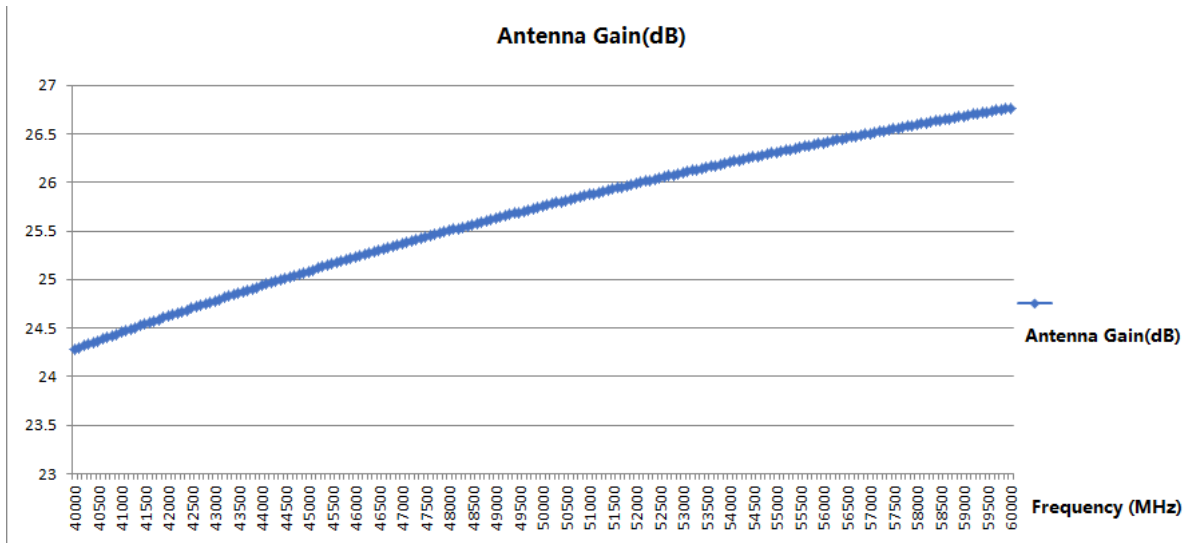

Standard Gain Horn (40GHz-60GHz)	LB-19-25	J202024087	A-INFO	2022-01-14	1 year
-------------------------------------	----------	------------	--------	------------	--------

A-INFO 英联微波

LB-19-25
40.0 - 60.0GHz 标准增益喇叭天线

技术指标



频率(GHz)	A 型, 波导输出	40.0 - 60.0
	C 型, 2.4mm-50K 输出	40.0 - 50.0
	C 型, 1.85mm-50K 输出	40.0 - 60.0
增益(dB)	25 典型值	
驻波	1.6 最大值	
3dB 波束宽度(°)	10 典型值	
波导型号	BJ500(WR19)	
材料	铜	
输出形式	A 型	FUGP500
	C 型	2.4mm-50K 或 1.85mm-50K
尺寸(mm) 宽 x 高 x 长	A 型, 波导输出	49x41x130
	C 型, 2.4mm-50K 输出	49x41x155
	C 型, 1.85mm-50K 输出	49x41x157
净重(Kg)	A 型, 波导输出	约 0.15
	C 型, 2.4mm-50K 输出	约 0.18
	C 型, 1.85mm-50K 输出	约 0.18

外形图 (尺寸: mm)

A 型

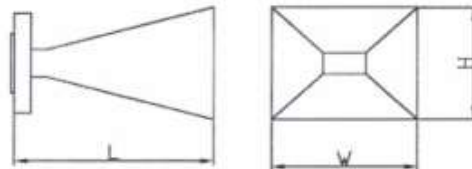

宽 x 高 x 长: 49x41x130

C 型

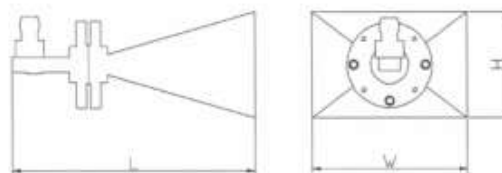

宽 x 高 x 长: 49x41x157

英联微波

第 1 页 / 共 7 页

北京 电话: 010-6266-7326 或 010-6266-7327
成都 电话: 028-8519-2786 或 028-8519-3047

传真: 010-6266-7379
传真: 028-8519-3068

网址: www.ainfoinc.com
www.ainfoinc.cn

测试报告仅供参考。详情请咨询: Sales@ainfoinc.com

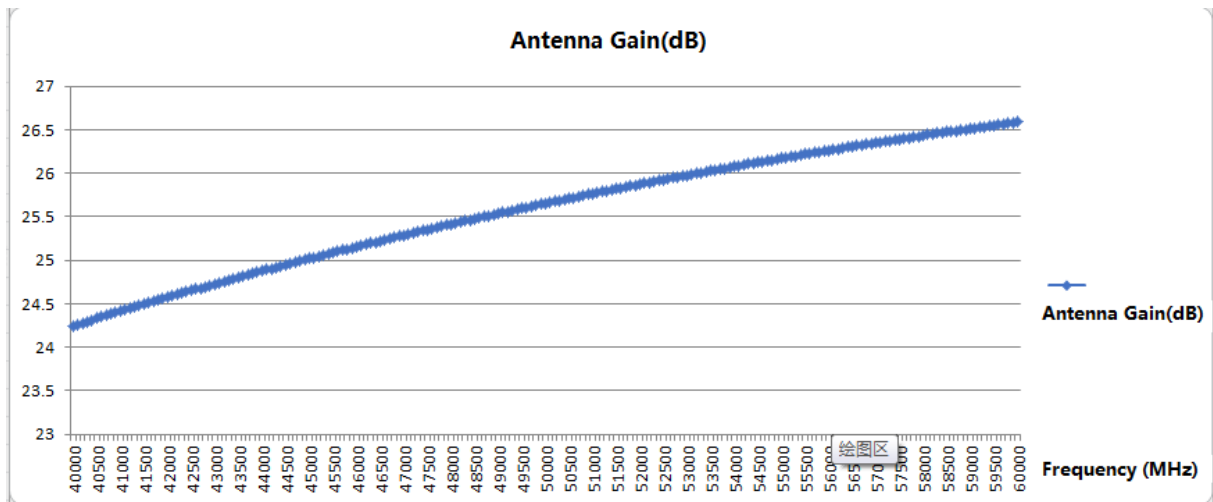

Standard Gain Horn (50GHz-75GHz)	LB-15-25	J202062019	A-INFO	2021-12-14	1 year
-------------------------------------	----------	------------	--------	------------	--------

A-INFO 英联微波

LB-15-25
50.0 - 75.0GHz 标准增益喇叭天线

技术指标



频率(GHz)	A 型, 波导输出	50.0 - 75.0
	C 型, 1.85mm-50K 输出	50.0 - 65.0
增益(dB)	25 典型值	
驻波	1.6 最大值	
3dB 波束宽度(°)	10 典型值	
波导型号	BJ620(WR15)	
材料	铜	
输出形式	A 型	FUGP620
	C 型	1.85mm-50K
尺寸(mm) 宽 x 高 x 长	A 型, 波导输出	38x31x91.4
	C 型, 1.85mm-50K 输出	38x32.6x118.4
净重(Kg)	A 型, 波导输出	约 0.07
	C 型, 1.85mm-50K 输出	约 0.10

外形图 (尺寸: mm)

A 型(FUGP620 法兰输出)

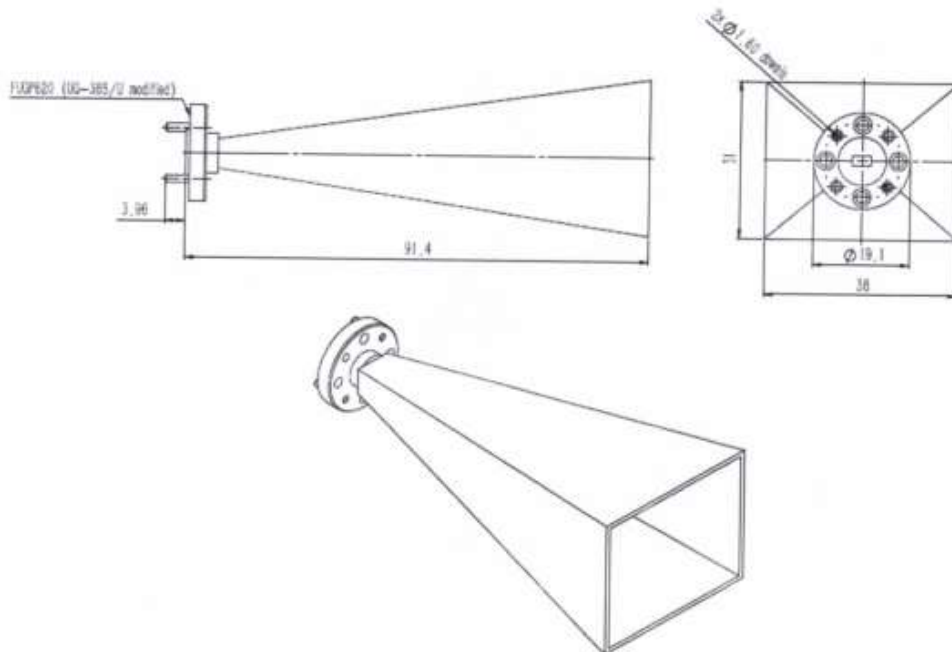

英联微波

第 1 页 / 共 8 页

北京 电话: 010-6266-7326 或 010-6266-7327

传真: 010-6266-7379

网址: www.ainfoinc.com

成都 电话: 028-8519-2786 或 028-8519-3047

传真: 028-8519-3068

www.ainfoinc.cn

测试报告仅供参考, 详情请咨询: Sales@ainfoinc.com

A-INFO 英联微波

LB-15-25
50.0 - 75.0GHz 标准增益喇叭天线

C型(1.85mm-50K 输出)

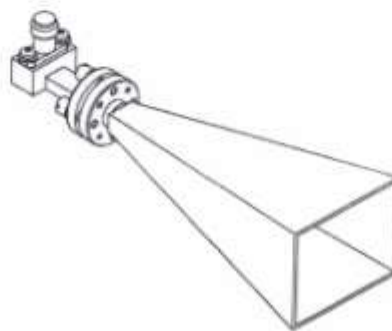
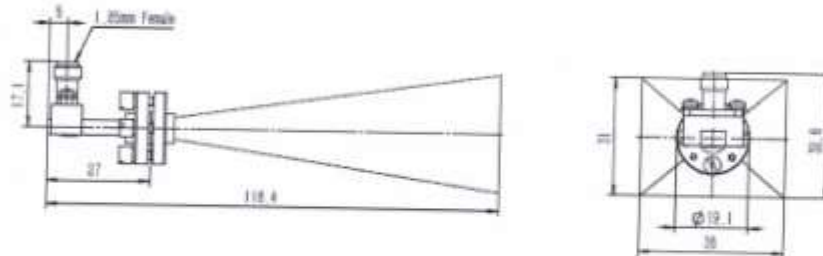

C型(1.85mm-50K 输出, 配圆形背夹)

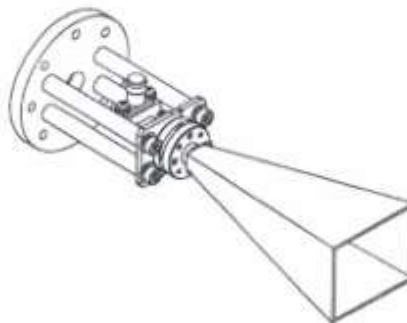
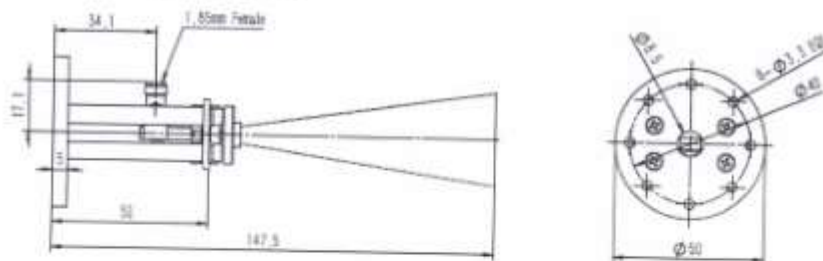

英联微波

第 2 页 / 共 8 页

北京 电话: 010-6266-7326 或 010-6266-7327

传真: 010-6266-7379

网址: www.ainfoinc.com

成都 电话: 028-8519-2786 或 028-8519-3047

传真: 028-8519-3068

www.ainfoinc.cn

测试报告仅供参考, 详情请咨询: Sales@ainfoinc.com

A-INFO 英联微波

LB-15-25
50.0 - 75.0GHz 标准增益喇叭天线

C型(1.85mm-50K 输出, 配L形背夹)

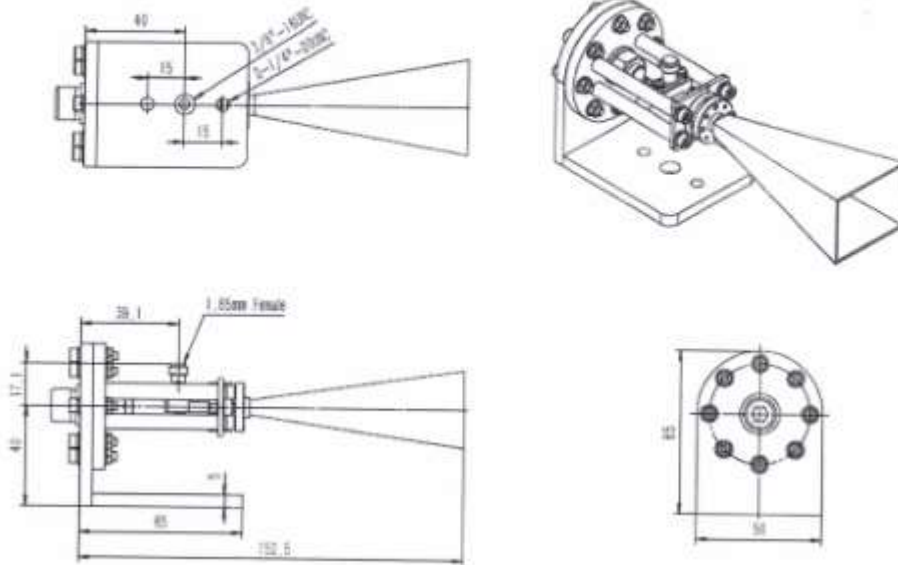

A型(配天线罩)

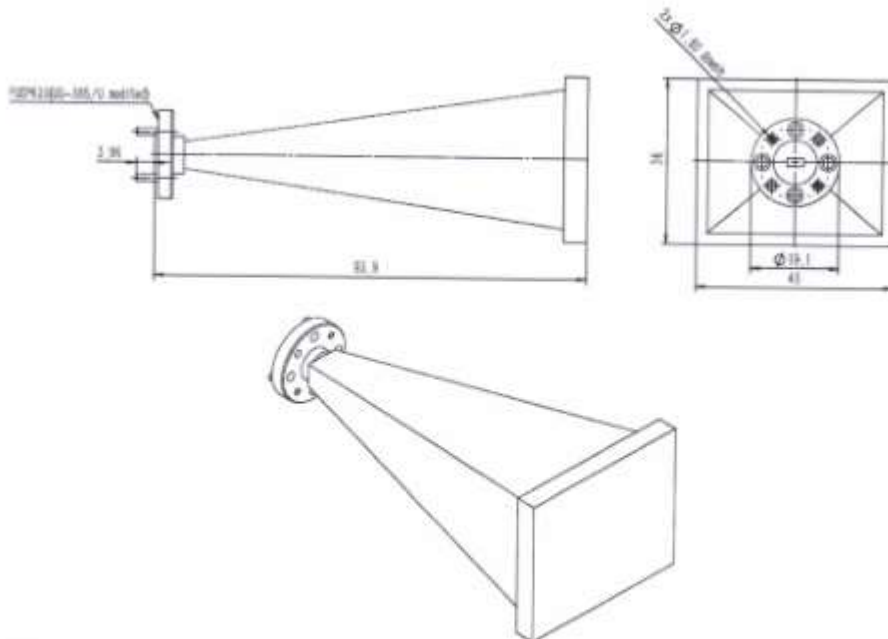

英联微波

第3页 / 共8页

北京 电话: 010-6266-7326 或 010-6266-7327 传真: 010-6266-7379
成都 电话: 028-8519-2786 或 028-8519-3047 传真: 028-8519-3068

网址: www.ainfoinc.com
www.ainfoinc.cn

测试报告仅供参考, 详情请咨询: Sales@ainfoinc.com

A-INFO 英联微波

LB-15-25
50.0 - 75.0GHz 标准增益喇叭天线

C型(1.85mm-50K 输出, 配圆形背夹和天线罩)

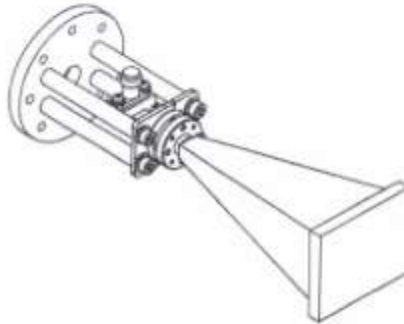
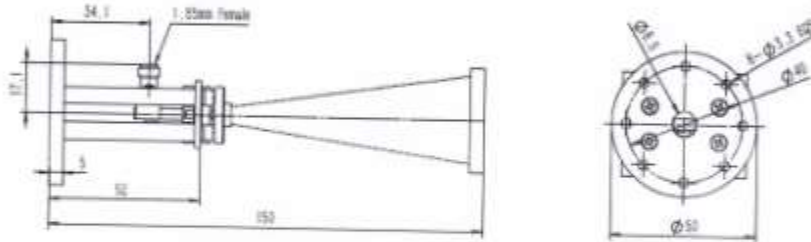

C型(1.85mm-50K 输出, 配 L 形背夹和天线罩)

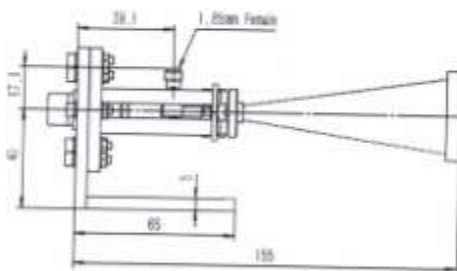
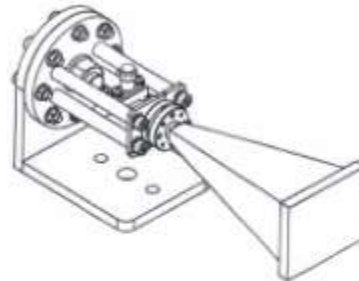
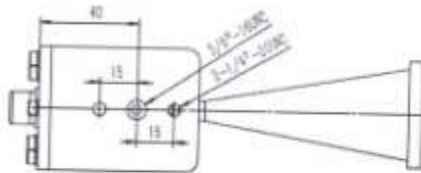

英联微波

第 4 页 / 共 8 页

北京 电话: 010-6266-7326 或 010-6266-7327
成都 电话: 028-8519-2786 或 028-8519-3047

传真: 010-6266-7379
传真: 028-8519-3068

网址: www.ainfoinc.com
www.ainfoinc.cn

测试报告仅供参考, 详情请咨询: Sales@ainfoinc.com

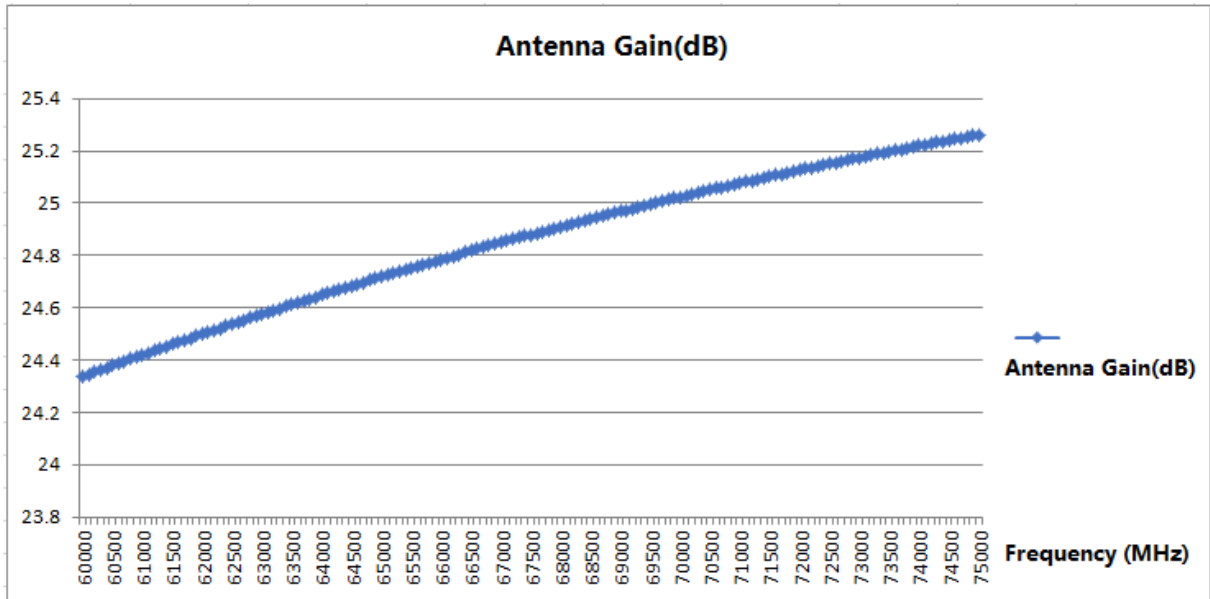

Standard Gain Horn (60GHz-90GHz)	LB-12-25	J202062912	A-INFO	2022-02-17	1 year
-------------------------------------	----------	------------	--------	------------	--------

A-INFO 英联微波

LB-12-25
60.0 - 90.0GHz 标准增益喇叭天线

技术指标



频率(GHz)	60.0 - 90.0
增益(dBi)	25 典型值
驻波	1.6 最大值
3dB 波束宽度(°)	10 典型值
波导型号	BJ740(WR12)
材料	铜
输出形式	A 型: FUGP740
尺寸(mm) 宽 x 高 x 长	A 型: 32x26x82
净重(Kg)	A 型: 约 0.05

外形图 (尺寸: mm)

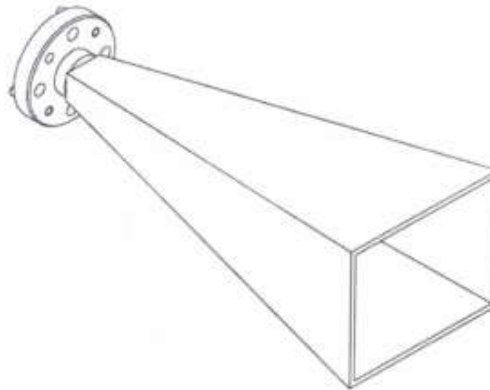
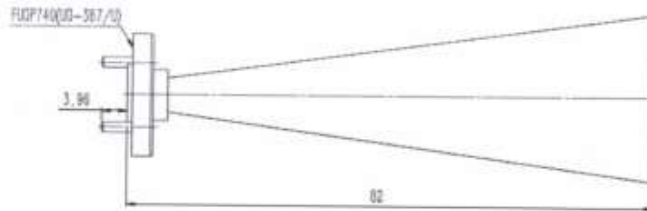
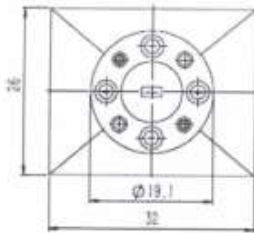

英联微波

第 1 页 / 共 4 页

北京 电话: 010-6266-7326 或 010-6266-7327

传真: 010-6266-7379

网址: www.ainfoinc.com

成都 电话: 028-8519-2786 或 028-8519-3047

传真: 028-8519-3068

www.ainfoinc.cn

测试报告仅供参考。详情请咨询: Sales@ainfoinc.com

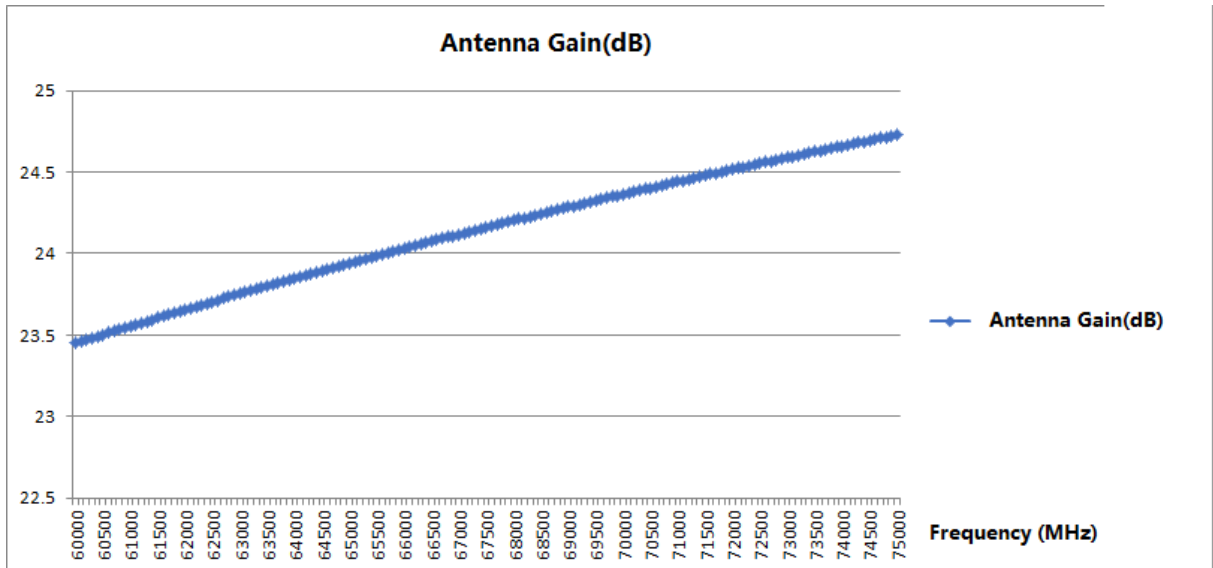

Standard Gain Horn (75GHz-110GHz)	LB-10-25	J202023231	A-INFO	2022-01-27	1 year
--------------------------------------	----------	------------	--------	------------	--------

A-INFO 英联微波

LB-10-25
75.0 - 110.0GHz 标准增益喇叭天线

技术指标



频率(GHz)	75.0 - 110.0
增益(dB)	25 典型值
驻波	1.6 最大值
3dB 波束宽度(°)	10 典型值
波导型号	BJ900(WR10)
材料	铜
输出形式	A 型: FUGP900
尺寸(mm) 宽 x 高 x 长	A 型: 28x22x70
净重(Kg)	A 型: 约 0.05

外形图 (尺寸: mm)

A 型

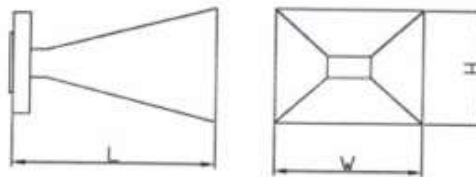

宽 x 高 x 长: 28x22x70

法兰外形图 (尺寸: mm)

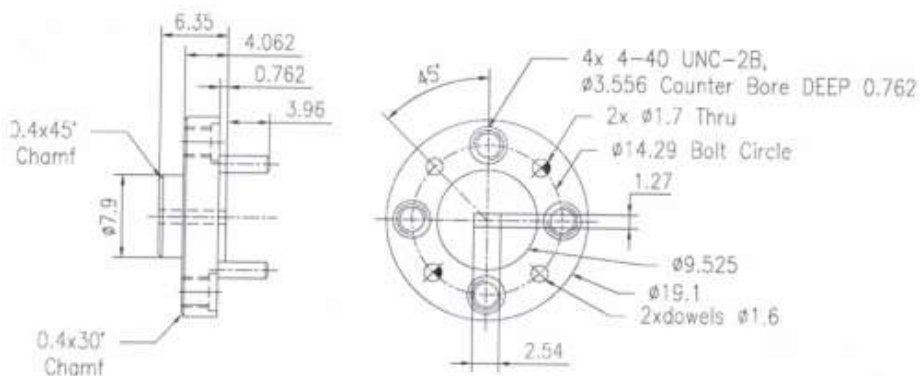

FUGP900
(equivalent to UG-387/U modified)

英联微波

第 1 页 / 共 6 页

北京 电话: 010-6266-7326 或 010-6266-7327
成都 电话: 028-8519-2786 或 028-8519-3047

传真: 010-6266-7379
传真: 028-8519-3068

网址: www.ainfoinc.com
www.ainfoinc.cn

测试报告仅供参考, 详情请咨询: Sales@ainfoinc.com

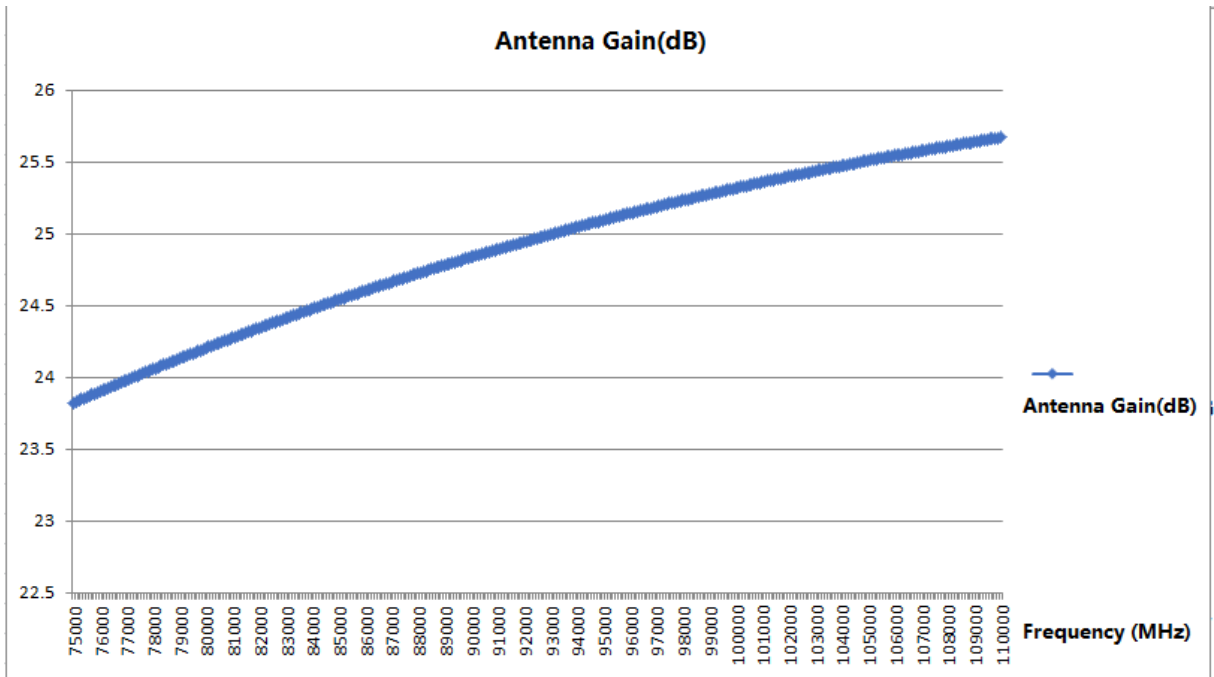

Standard Gain Horn (75GHz-110GHz)	LB-10-25	J202023232	A-INFO	2022-01-27	1 year
--------------------------------------	----------	------------	--------	------------	--------

A-INFO 英联微波

LB-10-25
75.0 - 110.0GHz 标准增益喇叭天线

技术指标



频率(GHz)	75.0 - 110.0
增益(dB)	25 典型值
驻波	1.6 最大值
3dB 波束宽度(°)	10 典型值
波导型号	BJ900(WR10)
材料	铜
输出形式	A 型: FUGP900
尺寸(mm) 宽 x 高 x 长	A 型: 28x22x70
净重(Kg)	A 型: 约 0.05

外形图 (尺寸: mm)

A 型

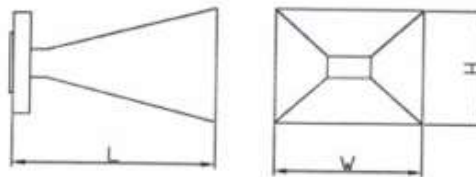

宽 x 高 x 长: 28x22x70

法兰外形图 (尺寸: mm)

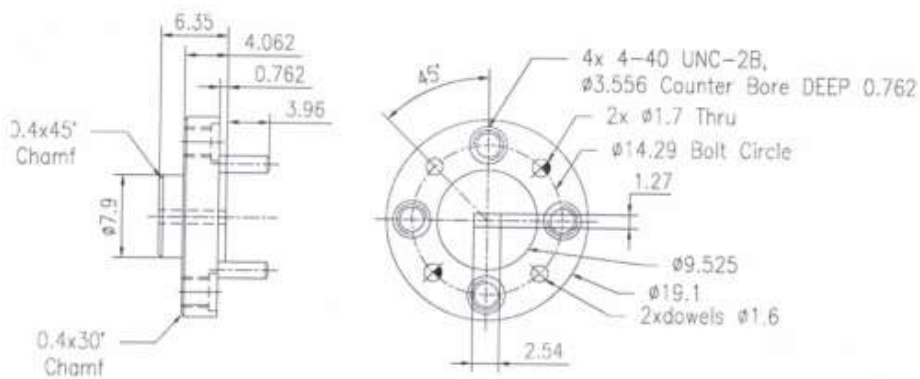

FUGP900
(equivalent to UG-387/U modified)

英联微波

第 1 页 / 共 6 页

北京 电话: 010-6266-7326 或 010-6266-7327
成都 电话: 028-8519-2786 或 028-8519-3047

传真: 010-6266-7379
传真: 028-8519-3068

网址: www.ainfoinc.com
www.ainfoinc.cn

测试报告仅供参考, 详情请咨询: Sales@ainfoinc.com

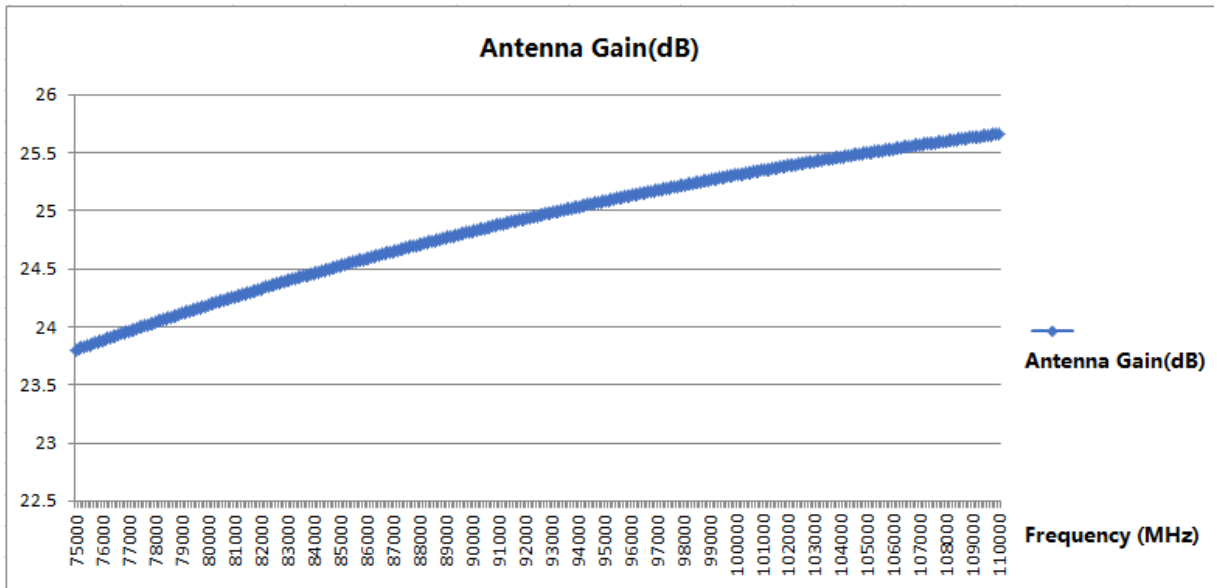

*****END OF REPORT*****