



RF EXPOSURE REPORT

(Part 2: Test Under Dynamic Transmission Condition)

APPLICANT : Reliance Communications LLC
PRODUCT NAME : Orbic Trophy 5G UW
MODEL NAME : R667L5U
BRAND NAME : Orbic
FCC ID : 2ABGH-R667L5U
STANDARD : IEC/IEEE 62209-1528
RECEIPT DATE : 2024-03-28
TEST DATE : 2024-04-01 to 2024-04-08
ISSUE DATE : 2024-04-18



Edited by :

Xie Yiyun

Xie Yiyun (Rapporteur)

Approved by:

Gan Yue ming

Gan Yueming (Supervisor)

NOTE: This document is issued by Shenzhen Morlab Communications Technology Co., the test report shall not be reproduced except in full without prior written permission of the company. The test results apply only to the particular sample(s) tested and to the specific tests carried out which is available on request for validation and information confirmed at our website.



DIRECTORY

- 1. Introduction 4
- 2. Equipment under Test (EUT) Description..... 5
- 3. Tx Varying Transmission Test Cases and Test Proposal 7
- 4. Tx Varying Transmission Test Cases and Test Proposal 10
 - 4.1. Test Sequence Determination for Validation 10
 - 4.2. Test Configuration Selection Criteria for Validating Smart Transmit Feature 10
 - 4.2.1. Test Configuration Selection for Time-varying Tx power Transmission..... 11
 - 4.2.2. Test Configuration Selection for Change in Call 11
 - 4.2.3. Test Configuration Selection for Change in Technology/Band 11
 - 4.2.4. Test Configuration Selection for Change in Antenna 12
 - 4.2.5. Test Configuration Selection for Change in DSI 12
 - 4.2.6. Test Configuration Selection for SAR Exposure Switching 12
 - 4.3. Test Procedures for Conducted Power Measurements..... 13
 - 4.3.1. Time-varying Tx Power Transmission Scenario 13
 - 4.3.2. Change in Call Scenario 15
 - 4.3.3. Change in Technology and Band 16
 - 4.3.4. Change in Antenna 17
 - 4.3.5. Change in DSI 17
 - 4.3.6. Change in Time Window 17
 - 4.3.7. SAR Exposure Switching 19
 - 4.4. Test Procedure for Time-varying SAR Measurements 20
- 5. Test Configurations 22
- 6. Conducted Power Test Results for Sub-6 Smart Transmit Feature Validation 25
 - 6.1. Measurement Setup 25
 - 6.2. Plimit and Pmax Measurement Results 27
 - 6.3. Time-varying Tx Power Measurement Results 28



7. SAR Test Results for Sub-6 Smart Transmit Feature 41

7.1. Measurement Setup 41

7.2. SAR Measurement Results for Time-varying Tx power Transmission scenario · 42

8. Conclusions 48

Annex A Test Sequences 49

Annex B Test Procedure for Sub6 Simultaneous Transmission Scenarios 52

Annex C Test Equipments List 54

Annex D Antenna Information 55

Annex E General Information 56

Annex F Antenna Location & Test Setup Photos 57

Annex G DASYS Calibration Certificate 57

Changed History		
Version	Date	Reason for Change
1.0	2024-04-18	First edition



1. Introduction

The equipment under test (EUT) is a Orbic Trophy 5G UW. It contains the Qualcomm modem supporting 2G/3G/4G technologies. These modems enable Qualcomm Smart Transmit feature to control and manage transmitting power in real time and to ensure at all times the time-averaged RF exposure is in compliance with the FCC requirement.

This purpose of this report is to demonstrate the EUT complies with FCC RF exposure requirement under Tx varying transmission scenarios, thereby validity of Qualcomm Smart Transmit feature for FCC equipment authorization.

The P_{limit} used in this report is determined in Part 1 reports.

The Part 1 report please refer to *SZ23040391S01*.



2. Equipment under Test (EUT) Description

Product Name:	Orbic Trophy 5G UW
EUT IMEI:	351352440001279
Hardware Version:	V1.0
Software Version:	R667L5U_v1.1.2_BVZ
Frequency Bands:	GSM 850: 824 MHz ~ 849 MHz GSM 1900: 1850 MHz ~ 1910 MHz WCDMA Band II: 1850 MHz ~ 1910 MHz WCDMA Band IV: 1710 MHz ~ 1755 MHz WCDMA Band V: 824 MHz ~ 849 MHz LTE Band 2: 1850 MHz ~ 1910 MHz LTE Band 4: 1710 MHz ~ 1755 MHz LTE Band 5: 824 MHz ~ 849 MHz LTE Band 7: 2500 MHz ~ 2570 MHz LTE Band 12: 699 MHz ~ 716 MHz LTE Band 13: 777 MHz ~ 787 MHz LTE Band 48: 3550 MHz ~ 3700 MHz LTE Band 66: 1710 MHz ~ 1780 MHz 5G NR n2 (NSA): 1850 MHz ~ 1910 MHz 5G NR n5 (NSA): 824 MHz ~ 849 MHz 5G NR n66 (NSA): 1710 MHz ~ 1780 MHz 5G NR n77 (NSA): 3450 MHz ~ 3550 MHz; 3700 MHz ~ 3980 MHz WLAN 2.4GHz: 2412 MHz ~ 2462 MHz WLAN 5.2GHz: 5180 MHz ~ 5240 MHz WLAN 5.3GHz: 5260 MHz ~ 5320 MHz WLAN 5.5GHz: 5500 MHz ~ 5720 MHz WLAN 5.8GHz: 5745 MHz ~ 5825 MHz Bluetooth: 2402 MHz ~ 2480 MHz NFC: 13.56 MHz
Modulation Mode:	GSM/GPRS: GMSK EDGE: 8PSK WCDMA: QPSK, 16QAM LTE: QPSK, 16QAM, 64QAM 5G NR: DFT-s-OFDM/CP-OFDM, PI/2 BPSK QPSK, 16QAM, 64QAM, 256QAM 802.11b: DSSS 802.11a/g/n-HT20/HT40/ac-VHT20/40/80: OFDM BR+EDR: GFSK(1Mbps), $\pi/4$ -DQPSK(2Mbps), 8-DPSK(3Mbps) Bluetooth LE: GFSK(1Mbps, 2Mbps) NFC: ASK



Multi-slot Class:	GPRS: Multi-slot Class 12 EDGE: Multi-slot Class 12	
Operation Class:	Class B	
Carrier Aggregation:	Uplink & Downlink	
VoLTE Mode:	Support	
VoWi-Fi Mode:	Support	
Hotspot Mode:	Support (5G WLAN only for B1 & B4)	
Antenna Type:	WWAN: PIFA Antenna WLAN: PIFA Antenna Bluetooth: PIFA Antenna NFC: Loop Antenna	
SIM Cards Description:	SIM 1	GSM+WCDMA+LTE+5G NR
	SIM 2	GSM+WCDMA+LTE+5G NR

Note: For more detailed description, please refer to specification or user manual supplied by the applicant and/or manufacturer.



3. Tx Varying Transmission Test Cases and Test Proposal

To validate time averaging feature and demonstrate the compliance in Tx varying transmission conditions, the following transmission scenarios are covered in Part 2 test:

1. During a time-varying Tx power transmission: To prove that the Smart Transmit feature accounts for Tx power variations in time accurately.
2. During a call disconnect and re-establish scenario: To prove that the Smart Transmit feature accounts for history of past Tx power transmissions accurately.
3. During technology/band handover: To prove that the Smart Transmit feature functions correctly during transitions in technology/band.
4. During DSI (Device State Index) change: To prove that the Smart Transmit feature functions correctly during transition from one device state (DSI) to another.
5. During antenna (or beam) switch: To prove that the Smart Transmit feature functions correctly during transitions in antenna (such as AsDiv scenario) or beams (different antenna array configurations).
6. During time window switch: To prove that the Smart Transmit feature correctly handles the transition from one time window to another specified by FCC, and maintains the normalized time-averaged RF exposure to be less than normalized FCC limit of 1.0 at all times.
7. SAR exposure switching between two active radios (radio1 and radio2): To prove that the Smart Transmit feature functions correctly and ensures total RF exposure compliance when exposure varies among SAR_radio1 only, SAR_radio1 + SAR_radio2, and SAR_radio2 only scenarios.

As described in Part 1 report, the RF exposure is proportional to the Tx power for a SAR wireless device. Thus, feature validation in Part 2 can be effectively performed through conducted (for $f < 6\text{GHz}$) and radiated (for $f \geq 6\text{GHz}$) power measurement. Therefore, the compliance demonstration under dynamic transmission conditions and feature validation are done in conducted/radiated power measurement setup for transmission scenario 1 through 8.

The strategy for testing in Tx varying transmission condition is outlined as follows:

- Demonstrate the total RF exposure averaged over FCC defined time windows does not exceed FCC's SAR and PD limits, through time-averaged power measurements
 - Measure conducted Tx power (for $f < 6\text{GHz}$) versus time, and radiated Tx power (EIRP for $f > 10\text{GHz}$) versus time.
 - Convert it into RF exposure and divide by respective FCC limits to get normalized exposure versus time.
 - Perform running time-averaging over FCC defined time windows.
 - Demonstrate that the total normalized time-averaged RF exposure is less than 1 for all transmission scenarios (i.e., transmission scenarios 1, 2, 3, 4, 5, 6, 7, and 8) at all times.

Mathematical expression:

- For sub-6 transmission only:

$$1g_or_10gSAR(t) = \frac{conducted_Tx_power(t)}{conducted_Tx_power_P_{limit}} * 1g_or_10gSAR_P_{limit} \quad (1a)$$

$$\frac{\frac{1}{T_{SAR}} \int_{t-T_{SAR}}^t 1g_or_10gSAR(t) dt}{FCC\ SAR\ limit} \leq 1 \quad (1b)$$

- For sub-6+mmW transmission:

$$1g_or_10gSAR(t) = \frac{conducted_Tx_power(t)}{conducted_Tx_power_P_{limit}} * 1g_or_10gSAR_P_{limit} \quad (2a)$$

$$4cm^2PD(t) = \frac{radiated_Tx_power(t)}{radiated_Tx_power_input.power.limit} * 4cm^2PD_input.power.limit \quad (2b)$$

$$\frac{\frac{1}{T_{SAR}} \int_{t-T_{SAR}}^t 1g_or_10gSAR(t) dt}{FCC\ SAR\ limit} + \frac{\frac{1}{T_{PD}} \int_{t-T_{PD}}^t 4cm^2PD(t) dt}{FCC\ 4cm^2\ PD\ limit} \leq 1 \quad (2c)$$

where, $conducted_Tx_power(t)$, $conducted_Tx_power_P_{limit}$, and $1g_or_10gSAR_P_{limit}$ correspond to the measured instantaneous conducted Tx power, measured conducted Tx power at P_{limit} , and measured $1gSAR$ or $10gSAR$ values at P_{limit} corresponding to sub-6 transmission. Similarly, $radiated_Tx_power(t)$, $radiated_Tx_power_input.power.limit$, and $4cm^2PD_input.power.limit$ correspond to the measured instantaneous radiated Tx power, radiated Tx power at $input.power.limit$ (i.e., radiated power limit), and $4cm^2PD$ value at $input.power.limit$ corresponding to mmW transmission. Both P_{limit} and $input.power.limit$ are the parameters pre-defined in Part 0 and loaded via Embedded File System (EFS) onto the EUT. T_{SAR} is the FCC defined time window for sub-6 radio; T_{PD} is the FCC defined time window for mmW radio.

- Demonstrate the total RF exposure averaged over FCC defined time windows does not exceed FCC's SAR and PD limits, through time-averaged SAR and PD measurements. Note as mentioned earlier, this measurement is performed for transmission scenario 1 only.

- For sub-6 transmission only, measure instantaneous SAR versus time; for LTE+sub6 NR transmission, request low power (or all-down bits) on LTE so that measured SAR predominantly corresponds to sub6 NR.
- For LTE + mmW transmission, measure instantaneous E-field versus time for mmW radio and instantaneous conducted power versus time for LTE radio.
- Convert it into RF exposure and divide by respective FCC limits to obtain normalized exposure versus time.
- Perform time averaging over FCC defined time window.
- Demonstrate that the total normalized time-averaged RF exposure is less than 1 for transmission scenario 1 at all times.

Mathematical expression:

- For sub-6 transmission only:

$$1g_or_10gSAR(t) = \frac{pointSAR(t)}{pointSAR_P_{limit}} * 1g_or_10gSAR(t)_P_{limit} \quad (3a)$$

$$\frac{\frac{1}{T_{SAR}} \int_{t-T_{SAR}}^t 1g_or_10gSAR(t) dt}{FCC\ SAR\ limit} \leq 1 \quad (3b)$$

- For LTE+mmW transmission:

$$1g_or_10gSAR(t) = \frac{conducted_Tx_power(t)}{conducted_Tx_power_P_{limit}} * 1g_or_10gSAR_P_{limit} \quad (4a)$$

$$4cm^2PD(t) = \frac{[pointE(t)]^2}{[pointE_input.power.limit]^2} * 4cm^2PD_input.power.limit \quad (4b)$$

$$\frac{\frac{1}{T_{SAR}} \int_{t-T_{SAR}}^t 1g_or_10gSAR(t) dt}{FCC\ SAR\ limit} + \frac{\frac{1}{T_{PD}} \int_{t-T_{PD}}^t 4cm^2PD(t) dt}{FCC\ 4cm^2PD\ limit} \leq 1 \quad (4c)$$

where, $pointSAR(t)$, $pointSAR_P_{limit}$, and $1g_or_10gSAR_P_{limit}$ correspond to the measured instantaneous point SAR, measured point SAR at P_{limit} , and measured $1gSAR$ or $10gSAR$ values at P_{limit} corresponding to sub-6 transmission. Similarly, $pointE(t)$, $pointE_input.power.limit$, and $4cm^2PD_input.power.limit$ correspond to the measured instantaneous E-field, E-field at $input.power.limit$, and $4cm^2PD$ value at $input.power.limit$ corresponding to mmW transmission.

NOTE: cDASY6 measurement system by Schmid & Partner Engineering AG (SPEAG) of Zurich, Switzerland measures relative E-field, and provides ratio of

$$\frac{[pointE(t)]^2}{[pointE_input.power.limit]^2} \text{ versus time.}$$

4. Tx Varying Transmission Test Cases and Test Proposal

This chapter provides the test plan and test procedure for validating Qualcomm Smart Transmit feature for sub-6 transmission. The 360 seconds time window for operating $f < 3\text{GHz}$ is used as an example to detail the test procedures in this chapter. The same test plan and test procedures described in this chapter apply to 60 seconds time window for operating $f \geq 3\text{GHz}$.

4.1. Test Sequence Determination for Validation

Following the FCC recommendation, two test sequences having time-variation in Tx power are predefined for sub-6 ($f < 6\text{GHz}$) validation:

- Test sequence 1: request EUT's Tx power to be at maximum power, measured P_{max} †, for 80s, then requesting for half of the maximum power, i.e., measured $P_{max}/2$, for the rest of the time.
- Test sequence 2: request EUT's Tx power to vary with time. This sequence is generated relative to measured P_{max} , measured P_{limit} and calculated $P_{reserve}$ (= measured P_{limit} in dBm - $Reserve_power_margin$ in dB) of EUT based on measured P_{limit} .

The details for generating these two test sequences is described and listed in Appendix A.

Note: For test sequence generation, “measured P_{limit} ” and “measured P_{max} ” are used instead of the “ P_{limit} ” specified in EFS entry and “ P_{max} ” specified for the device, because Smart Transmit feature operates against the actual power level of the “ P_{limit} ” that was calibrated for the EUT. The “measured P_{limit} ” accurately reflects what the feature is referencing to, therefore, it should be used during feature validation testing. The RF tune up and device-to-device variation are already considered in Part 0 report prior to determining P_{limit} .

4.2. Test Configuration Selection Criteria for Validating Smart Transmit Feature

For validating Smart Transmit feature, this section provides a general guidance to select test cases. In practice, an adjustment can be made in test case selection. The justification/clarification may be provided.

4.2.1. Test Configuration Selection for Time-varying Tx power Transmission

The Smart Transmit time averaging feature operation is independent of bands, modes, and channels for a given technology. Hence, validation of Smart Transmit in one band/mode/channel per technology is sufficient. Two bands per technology are proposed and selected for this testing to provide high confidence in this validation.

The criteria for the selection are based on the *Plimit* values determined in Part 0 report. Select two bands* in each supported technology that correspond to least** and highest*** *Plimit* values that are less than *Pmax* for validating Smart Transmit.

* If one *Plimit* level applies to all the bands within a technology, then only one band needs to be tested. In this case, within the bands having the same *Plimit*, the radio configuration (e.g., # of RBs, channel#) and device position that correspond to the highest *measured 1g SAR at Plimit* shown in Part 1 report is selected.

** In case of multiple bands having the same least *Plimit* within the technology, then select the band having the highest *measured 1g SAR at Plimit*.

*** The band having a higher *Plimit* needs to be properly selected so that the power limiting enforced by Smart Transmit can be validated using the pre-defined test sequences. If the highest *Plimit* in a technology is too high where the power limiting enforcement is not needed when testing with the pre-defined test sequences, then the next highest level is checked. This process is continued within the technology until the second band for validation testing is determined.

4.2.2. Test Configuration Selection for Change in Call

The criteria to select a test configuration for call-drop measurement is:

- Select technology/band with least *Plimit* among all supported technologies/bands, and select the radio configuration (e.g., # of RBs, channel#) in this technology/band that corresponds to the highest *measured*

10g SAR at *Plimit* listed in Part 1 report.

- In case of multiple bands having same least *Plimit*, then select the band having the highest *measured 1g SAR at Plimit* in Part 1 report.

This test is performed with the EUT's Tx power requested to be at maximum power, the above band selection will result in Tx power enforcement (i.e., EUT forced to have Tx power at *Preserve*) for longest duration in one FCC defined time window. The call change (call drop/reestablish) is performed during the Tx power enforcement duration (i.e., during the time when EUT is forced to have Tx power at *Preserve*). One test is sufficient as the feature operation is independent of technology and band.

4.2.3. Test Configuration Selection for Change in Technology/Band

The selection criteria for this measurement is, for a given antenna, to have EUT switch from a technology/band with lowest *Plimit* within the technology group (in case of multiple bands having the same *Plimit*, then select the band with highest *measured 1g SAR at Plimit*) to a technology/band with



highest *Plimit* within the technology group, in case of multiple bands having the same *Plimit*, then select the band with lowest *measured 1g SAR at Plimit* in Part 1 report, or vice versa.

This test is performed with the EUT's Tx power requested to be at maximum power, the technology/band switch is performed during Tx power enforcement duration (i.e., during the time when EUT is forced to have Tx power at *Preserve*).

4.2.4. Test Configuration Selection for Change in Antenna

The criteria to select a test configuration for antenna switch measurement is:

- Whenever possible and supported by the EUT, first select antenna switch configuration within the same technology/band (i.e., same technology and band combination).
- Then, select any technology/band that supports multiple Tx antennas, and has the highest difference in *Plimit* among all supported antennas.
- In case of multiple bands having same difference in *Plimit* among supported antennas, then select the band having the highest *measured 1g SAR at Plimit* in Part 1 report.

This test is performed with the EUT's Tx power requested to be at maximum power in selected technology/band, and antenna change is conducted during Tx power enforcement duration (i.e., during the time when EUT is forced to have Tx power at *Preserve*).

4.2.5. Test Configuration Selection for Change in DSI

The criteria to select a test configuration for DSI change test is:

- Select a technology/band having the $Plimit < Pmax$ within any technology and DSI group, and for the same technology/band having a different *Plimit* in any other DSI group. Note that the selected DSI transition needs to be supported by the device.

This test is performed with the EUT's Tx power requested to be at maximum power in selected technology/band, and DSI change is conducted during Tx power enforcement duration (i.e., during the time when EUT is forced to have Tx power at *Preserve*).

4.2.6. Test Configuration Selection for SAR Exposure Switching

If supported, the test configuration for SAR exposure switching should cover:

1. SAR exposure switch when two active radios are in the same time window.
2. SAR exposure switch when two active radios are in different time windows. One test with two active radios in any two different time windows is sufficient as Smart Transmit operation is the same for RF exposure switch in any combination of two different time windows. For device supporting LTE + mmW NR, this test is covered in Section 8.2.3 and 8.2.4.

The Smart Transmit time averaging operation is independent of the source of SAR exposure (for example, LTE vs. Sub6 NR) and ensures total time-averaged RF exposure compliance. Hence, validation of Smart Transmit in any one simultaneous SAR transmission scenario (i.e., one combination for LTE + Sub6 NR transmission) is sufficient, where the SAR exposure varies among SARradio1 only, SARradio1 + SARradio2, and SARradio2 only scenarios.



The criteria to select a test configuration for validating Smart Transmit feature during SAR exposure switching scenarios is:

- Select any two < 6GHz technologies/bands that the EUT supports simultaneous transmission (for example, LTE+Sub6 NR).
- Among all supported simultaneous transmission configurations, the selection order is:
 1. Select one configuration where both P_{limit} of radio1 and radio2 is less than their corresponding P_{max} , preferably, with different P_{limits} . If this configuration is not available, select one configuration that has P_{limit} less than its P_{max} for at least one radio. If this cannot be found, then, select one configuration that has P_{limit} of radio1 and radio2 greater than P_{max} but with least $(P_{limit} - P_{max})_{\Delta}$.
 2. Test for one simultaneous transmission scenario is sufficient as the feature operation is the same.

4.3. Test Procedures for Conducted Power Measurements

This section provides general conducted power measurement procedures to perform compliance test under dynamic transmission scenarios described in Section 2. In practice, an adjustment can be made in these procedures. The justification/clarification may be provided.

4.3.1. Time-varying Tx Power Transmission Scenario

This test is performed with the two pre-defined test sequences described in Section 3.1 for all the technologies and bands selected in Section 3.2.1. The purpose of the test is to demonstrate the effectiveness of power limiting enforcement and that the time-averaged SAR (corresponding time-averaged Tx power) does not exceed the FCC limit at all times (see Eq. (1a) and (1b)).

Test procedure

1. P_{max} , measure P_{limit} and calculate $Reserve (= \text{measured } P_{limit} \text{ in dBm} - Reserve_power_margin \text{ in dB})$ and follow Section 3.1 to generate the test sequences for all the technologies and bands selected in Section 3.2.1. Both test sequence 1 and test sequence 2 are created based on measured P_{max} and measured P_{limit} of the EUT. Test condition to measure P_{max} and P_{limit} is:
 - Measure P_{max} with Smart Transmit disabled and callbox set to request maximum power.
 - Measure P_{limit} with Smart Transmit enabled and $Reserve_power_margin$ set to 0 dB; callbox set to request maximum power.
2. Set $Reserve_power_margin$ to actual (intended) value (3dB for this EUT based on Part 1 report) and reset power on EUT to enable Smart Transmit, establish radio link in desired radio configuration, with callbox requesting the EUT's Tx power to be at pre-defined test sequence 1,

measure and record Tx power versus time, and then convert the conducted Tx power into 1g SAR or 1g SAR value (see Eq. (1a)) using measured P_{limit} from above Step 1. Perform running time average to determine time-averaged power and 1g SAR or 1g SAR versus time as illustrated in Figure 3-1 where using 100-seconds time window as an example.

Note 1: In Eq.(1a), instantaneous Tx power is converted into instantaneous 1g SAR or 1g SAR value by applying the measured worst-case 1g SAR or 1g SAR value at P_{limit} for the corresponding technology/band/antenna/DSI reported in Part 1 report.

Note 2: For an easier computation of the running time average, 0 dBm can be added at the beginning of the test sequences the length of the responding time window, for example, add 0dBm for 100-seconds so the running time average can be directly performed starting with the first 100-seconds data using excel spreadsheet. This technique applies to all tests performed in this Part 2 report for easier time-averaged computation using excel spreadsheet.

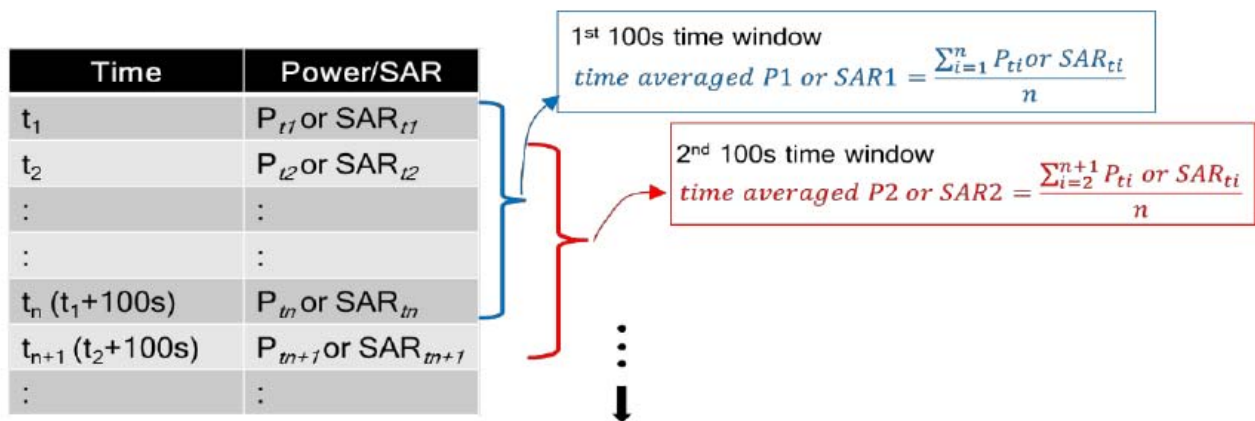

Figure 4-1 100s running average illustration

3. Make one plot containing:
 - a. Instantaneous Tx power versus time measured in Step 2,
 - b. Requested Tx power used in Step 2 (test sequence 1),
 - c. Computed time-averaged power versus time determined in Step 2,
 - d. Time-averaged power limit (corresponding to FCC SAR limit of 1.6 W/kg for 1g SAR or 2.0W/kg for 1g SAR) given by:

$$Time\ averaged\ power\ limit = meas.P_{limit} + 10 \times \log\left(\frac{FCC\ SAR\ limit}{meas.SAR_P_{limit}}\right) \quad (5a)$$

where

meas. P_{limit} and meas. SAR_P_{limit} correspond to measured power at P_{limit} and measured SAR at P_{limit}.

4. Make another plot containing:



- a. Amputated time-averaged 1g SAR or 1g SAR versus time determined in Step 2
 - b. SAR limit of 2.0W/kg or FCC 1g SAR limit of 2.0W/kg.
5. Repeat Steps 2 ~ 4 for pre-defined test sequence 2 and replace the requested Tx power (test sequence 1) in Step 2 with test sequence 2.
6. Repeat Steps 2 ~ 5 for all the selected technologies and bands.

The validation criteria are, at all times, the time-averaged power versus time shown in Step 3 plot shall not exceed the time-averaged power limit (defined in Eq. (5a)), in turn, the time-averaged 10g SAR or 1g SAR versus time shown in Step 4 plot shall not exceed the FCC limit of 1.6 W/kg for 1g SAR or 1.6 W/kg for 1g SAR (i.e., Eq. (1b)).

4.3.2. Change in Call Scenario

This test is to demonstrate that Smart Transmit feature accurately accounts for the past Tx powers during time-averaging when a new call is established.

The call disconnects and re-establishment needs to be performed during power limit enforcement, i.e., when the EUT's Tx power is at *Preserve* level, to demonstrate the continuity of RF exposure management and limiting in call change scenario. In other words, the RF exposure averaged over any FCC defined time window (including the time windows containing the call change) doesn't exceed FCC limit of 1.6 W/kg for 1g SAR or 1.6 W/kg for 1g SAR.

Test procedure

1. Measure P_{limit} for the technology/band selected in Section 3.2.2. Measure P_{limit} with Smart Transmit enabled and Reserve_power_margin set to 0 dB; callbox set to request maximum power.
2. Set Reserve_power_margin to actual (intended) value and reset power on EUT to enable Smart Transmit.
3. Establish radio link with callbox in the selected technology/band.
4. Request EUT's Tx power at 0 dBm for at least one time window specified for the selected technology/band, followed by requesting EUT's Tx power to be at maximum power for about ~60 seconds, and then drop the call for ~10 seconds. Afterwards, re-establish another call in the same radio configuration (i.e., same technology/band/channel) and continue callbox requesting EUT's Tx power to be at maximum power for the remaining time of at least another full duration of the specified time window. Measure and record Tx power versus time. Once the measurement is done, extract instantaneous Tx power versus time, convert the measured conducted Tx power into 1g SAR or 1g SAR value using Eq. (1a), and then perform the running time average to determine time-averaged power and 1g SAR or 1g SAR versus time.

Note: In Eq.(1a), instantaneous Tx power is converted into instantaneous 1g SAR or 1g SAR value by applying the measured worst-case 1g SAR or 1g SAR value at P_{limit} for the corresponding technology/band/antenna/DSI reported in Part 1 report.

5. Make one plot containing: (a) instantaneous Tx power versus time, (b) requested power, (c) computed time-averaged power, (d) time-averaged power limit calculated using Eq.(5a).
6. Make another plot containing: (a) computed time-averaged 1g SAR or 1g SAR versus time, and (b) FCC limit of 1.6 W/kg for 1g SAR or 1.6 W/kg for 1g SAR. The validation criteria are, at all times, the time-averaged power versus time shall not exceed the time- averaged power limit (defined in Eq.(5a)), in turn, the time-averaged 1g SAR or 1g SAR versus time shall not exceed the FCC limit of 1.6 W/kg for 1g SAR or 1.6 W/kg for 1g SAR (i.e., Eq. (1b)).

4.3.3.Change in Technology and Band

This test is to demonstrate the correct power control by Smart Transmit during technology switches and/or band handovers.

Similar to the change in call test in Section 3.3.2, to validate the continuity of RF exposure limiting during the transition, the technology and band handover needs to be performed when EUT's Tx power is at *Preserve* level (i.e., during Tx power enforcement) to make sure that the EUT's Tx power from previous *Preserve* level to the new *Preserve* level (corresponding to new technology/band). Since the *Plimit* could vary with technology and band, Eq. (1a) can be written as follows to convert the instantaneous Tx power in 1g SAR or 1g SAR exposure for the two given radios, respectively:

$$1g_or_10gSAR_1(t) = \frac{conducted_Tx_power_1(t)}{conducted_Tx_power_Plimit_1} * 1g_or_10gSAR_Plimit_1 \quad (6a)$$

$$1g_or_10gSAR_2(t) = \frac{conducted_Tx_power_2(t)}{conducted_Tx_power_Plimit_2} * 1g_or_10gSAR_Plimit_2 \quad (6b)$$

$$\frac{1}{T_{SAR}} \left[\int_{t-T_{SAR}}^{t_1} \frac{1g_or_10gSAR_1(t)}{FCC\ SAR\ limit} dt + \int_{t-T_{SAR}}^t \frac{1g_or_10gSAR_2(t)}{FCC\ SAR\ limit} dt \right] \leq 1 \quad (6c)$$

where, *conducted_Tx_power_1(t)*, *conducted_Tx_power_Plimit_1*, and *1g_or_10g SAR_Plimit_1* correspond to the measured instantaneous conducted Tx power, measured conducted Tx power at *Plimit*, and measured 1g SAR or 1g SAR value at *Plimit* of technology1/band1; *conducted_Tx_power_2(t)*, *conducted_Tx_power_Plimit_2(t)*, and *1g_or_10g SAR_Plimit_2* correspond to the measured instantaneous conducted Tx power, measured conducted Tx power at *Plimit*, and measured 1g SAR or 1g SAR value at *Plimit* of technology2/band2. Transition from technology1/band1 to the technology2/band2 happens at time- instant 't1'.

Test procedure

1. Measure *Plimit* for both the technologies and bands selected in Section 3.2.3. Measure *Plimit* with Smart Transmit enabled and *Reserve_power_margin* set to 0 dB; callbox set to request maximum power.
2. Set *Reserve_power_margin* to actual (intended) value and reset power on EUT to enable Smart Transmit
3. Establish radio link with callbox in first technology/band selected.



4. Request EUT's Tx power at 0 dBm for at least one time window specified for the selected technology/band, followed by requesting EUT's Tx power to be at maximum power for about 60 seconds, and then switch to second technology/band selected. Continue with callbox requesting EUT's Tx power to be at maximum power for the remaining time of at least another full duration of the specified time window. Measure and record Tx power versus time for the full duration of the test.
5. Once the measurement is done, extract instantaneous Tx power versus time, and convert the conducted Tx power into 1g SAR or 1g SAR value using Eq. (6a) and (6b) and corresponding measured P_{limit} values from Step 1 of this section. Perform the running time average to determine time-averaged power and 1g SAR or 1g SAR versus time.

Note: In Eq.(6a) & (6b), instantaneous Tx power is converted into instantaneous 1g SAR or 1g SAR value by applying the measured worst-case 1g SAR or 1g SAR value at P_{limit} for the corresponding technology/band/antenna/DSI reported in Part 1 report.

6. Make one plot containing: (a) instantaneous Tx power versus time, (b) requested power, (c) computed time-averaged power, (d) time-averaged power limit calculated using Eq.(5a).
7. Make another plot containing: (a) computed time-averaged 1g SAR or 1g SAR versus time, and (b) FCC limit of 1.6 W/kg for 1g SAR or 1.6 W/kg for 1g SAR. The validation criteria are, at all times, the time-averaged 1g SAR or 1g SAR versus time shall not exceed the FCC limit of 1.6 W/kg for 1g SAR or 1.6 W/kg for 1g SAR (i.e., Eq. (6c)).

4.3.4.Change in Antenna

This test is to demonstrate the correct power control by Smart Transmit during antenna switches from one antenna to another. The test procedure is identical to Section 3.3.3, by replacing technology/band switch operation with antenna switch. The validation criteria are, at all times, the time-averaged 1g SAR or 1g SAR versus time shall not exceed FCC limit of 1.6 W/kg for 1g SAR.

Note: If the EUT does not support antenna switch within the same technology/band, but has multiple antennas to support different frequency bands, then the antenna switch test is included as part of change in technology and band (Section 3.3.3) test.

4.3.5.Change in DSI

This test is to demonstrate the correct power control by Smart Transmit during DSI switches from one DSI to another. The test procedure is identical to Section 3.3.3, by replacing technology/band switch operation with DSI switch. The validation criteria are, at all times, the time-averaged 1g SAR or 1g SAR versus time shall not exceed FCC limit of 1.6 W/kg for 1g SAR or 4.0 W/kg for 10g SAR.

4.3.6.Change in Time Window

This test is to demonstrate the correct power control by Smart Transmit during the change in

averaging time window when a specific band handover occurs. FCC specifies time-averaging windows of 100s for Tx frequency < 3GHz, and 60s for Tx frequency between 3GHz and 6GHz. To validate the continuity of RF exposure limiting during the transition, the band handover test needs to be performed when EUT handovers from operation band less than 3GHz to greater than 3GHz and vice versa. The equations (3a) and (3b) in Section 2 can be written as follows for transmission scenario having change in time window,

$$1gSAR_1(t) = \frac{\text{conducted_Tx_power_1}(t)}{\text{conducted_Tx_power_Plimit_1}} * 1g_or\ 10g_SAR_Plimit_1 \quad (7a)$$

$$1gSAR_2(t) = \frac{\text{conducted_Tx_power_2}(t)}{\text{conducted_Tx_power_Plimit_2}} * 1g_or\ 10g_SAR_Plimit_2 \quad (7b)$$

$$\frac{1}{T1_{SAR}} \left[\int_{t-T1_{SAR}}^{t_1} \frac{1g_or\ 10g_SAR_1(t)}{FCC\ SAR\ limit} dt \right] + \frac{1}{T2_{SAR}} \left[\int_{t-T2_{SAR}}^t \frac{1g_or\ 10g_SAR_2(t)}{FCC\ SAR\ limit} dt \right] \leq 1 \quad (7c)$$

where, *conducted_Tx_power_1(t)*, *conducted_Tx_power_Plimit_1(t)*, and *1g_or 10g_SAR_Plimit_1* correspond to the instantaneous Tx power, conducted Tx power at P_{limit} , and compliance *1g_or 10g_SAR* values at P_{limit_1} of band1 with time-averaging window ' $T1_{SAR}$ '; *conducted_Tx_power_2(t)*, *conducted_Tx_power_Plimit_2(t)*, and *1g_or 10g_SAR_Plimit_2* correspond to the instantaneous Tx power, conducted Tx power at P_{limit} , and compliance *1g_or 10g_SAR* values at P_{limit_2} of band2 with time-averaging window ' $T2_{SAR}$ '. One of the two bands is less than 3GHz, another is greater than 3GHz. Transition from first band with time-averaging window ' $T1_{SAR}$ ' to the second band with time-averaging window ' $T2_{SAR}$ ' happens at time-instant ' t_1 '.

Test procedure

8. Measure P_{limit} for both the technologies and bands selected in Section 3.2.6. Measure P_{limit} with Smart Transmit enabled and Reserve_power_margin set to 0 dB, callbox set to request maximum power.
9. Set Reserve_power_margin to actual (intended) value and enable Smart Transmit

Transition from 360s time window to 60s time window, and vice versa

10. Establish radio link with callbox in the technology/band having 360s time window selected in Section 3.2.6.
11. Request EUT's Tx power to be at 0 dBm for at least 100 seconds, followed by requesting EUT's Tx power to be at maximum power for about ~140 seconds, and then switch to second technology/band (having 60s time window) selected in Section 3.2.6. Continue with callbox requesting EUT's Tx power to be at maximum power for about ~60s in this second technology/band, and then switch back to the first technology/band. Continue with callbox requesting EUT's Tx power to be at maximum power for at least another 360s. Measure and record Tx power versus time for the entire duration of the test.

Once the measurement is done, extract instantaneous Tx power versus time, and convert the conducted Tx power into 1gSAR or 10gSAR value (see Eq. (7a) and (7b)) using corresponding



technology/band Step 1 result, and then perform 360s running average to determine time-averaged 1g SAR or 1gSAR versus time. Note that in Eq.(7a) & (7b), instantaneous Tx power is converted into instantaneous 1gSAR or 1gSAR value by playing the worst-case 1gSAR or 1gSAR value tested in Part 1 for the selected technologies/bands at Plimit.

12. Make one plot containing: (a) instantaneous Tx power versus time measured in Step 4.
13. Make another plot containing: (a) instantaneous 1gSAR versus time determined in Step 5, (b) computed time-averaged 1gSAR versus time determined in Step 5, and (c) corresponding regulatory 1gSAR limit of 2.0W/kg.

Transition from 60s time window to 360s time window, and vice versa

14. Establish radio link with callbox in the technology/band having 60s time window selected in Section 3.2.6.
15. Request EUT's Tx power to be at 0 dBm for at least 60 seconds, followed by requesting EUT's Tx power to be at maximum power for about ~80 seconds, and then switch to second technology/band (having 360s time window) selected in Section 3.2.6. Continue with callbox requesting EUT's Tx power to be at maximum power for about ~360s in this second technology/band, and then switch back to the first technology/band. Continue with callbox requesting EUT's Tx power to be at maximum power for the remaining time for a total test time of 500 seconds. Measure and record Tx power versus time for the entire duration of the test.

16. Repeat above Step 5~7 to generate the plots

The validation criteria is, at all times, the time-averaged 1gSAR or 1gSAR versus time shall not exceed the regulatory 1gSAR limit of 2.0W/kg.

4.3.7.SAR Exposure Switching

This test is to demonstrate that Smart Transmit feature is accurately accounts for switching in exposures among SAR from radio1 only, SAR from both radio1 and radio2, and SAR from radio2 only scenarios, and ensures total time-averaged RF exposure complies with the FCC limit. Here, radio1 represents primary radio (for example, LTE anchor in a NR non-standalone mode call) and radio2 represents secondary radio (for example, sub6 NR or mmW NR). The detailed test procedure for SAR exposure switching in the case of LTE+Sub6 NR non-standalone mode transmission scenario is provided in Appendix B.2.

Test procedure

1. Measure conducted Tx power corresponding to Plimit for radio1 and radio2 in selected band. Test condition to measure conducted Plimit is:
 - Establish device in call with the callbox for radio1 technology/band. Measure conducted Tx power corresponding to radio1 *Plimit* with Smart Transmit enabled and *Reserve_power_margin* set to 0 dB, callbox set to request maximum power.
 - repeat above step to measure conducted Tx power corresponding to radio2 Plimit. If radio2 is dependent on radio1 (for example, non-standalone mode of Sub6 NR requiring radio1 LTE as anchor), then establish radio1 + radio2 call with callbox, and request all down bits for radio1 LTE. In this scenario, with callbox requesting maximum power from radio2 Sub6 NR, measured



conducted Tx power corresponds to radio2 P_{limit} (as radio1 LTE is at all-down bits)

2. Set Reserve_power_margin to actual (intended) value, with EUT setup for radio1 + radio2 call. In this description, it is assumed that radio2 has lower priority than radio1. Establish device in radio1+radio2 call, and request all-down bits or low power on radio1, with callbox requesting EUT's Tx power to be at maximum power in radio2 for at least one time window. After one time window, set callbox to request EUT's Tx power to be at maximum power on radio1, i.e., all-up bits. Continue radio1+radio2 call with both radios at maximum power for at least one time window, and drop (or request all-down bits on) radio2. Continue radio1 at maximum power for at least one time window. Record the conducted Tx power for both radio1 and radio2 for the entire duration of this test.
3. Once the measurement is done, extract instantaneous Tx power versus time for both radio1 and radio2 links. Convert the conducted Tx power for both these radios into 1g SAR or 1g SAR value (see Eq. (6a) and (6b)) using corresponding technology/band P_{limit} measured in Step 1, and then perform the running time average to determine time-averaged 1g SAR or 1g SAR versus time.
4. Make one plot containing: (a) instantaneous Tx power versus time measured in Step 2.
5. Make another plot containing: (a) instantaneous 1g SAR versus time determined in Step 3, (b) computed time-averaged 1g SAR versus time determined in Step 3, and (c) corresponding regulatory 1g SAR limit of 2.0W/kg or 1g SAR limit of 2.0W/kg.

The validation criteria is, at all times, the time-averaged 1g SAR or 1g SAR versus time shall not exceed the regulatory 1g SAR_{limit} of 2.0W/kg or 1g SAR_{limit} of 2.0W/kg

4.4. Test Procedure for Time-varying SAR Measurements

This section provides general time-varying SAR measurement procedures to perform compliance test under dynamic transmission scenarios described in Section 2. In practice, an adjustment can be made in these procedures. The justification/clarification may be provided.

To perform the validation through SAR measurement for transmission scenario 1 described in Section 2, the "path loss" between callbox antenna and EUT needs to be calibrated to ensure that the EUT Tx power reacts to the requested power from callbox in a radiated call. It should be noted that when signaling in closed loop mode, protocol-level power control is in play, resulting in EUT not solely following callbox TPC (Tx power control) commands. In other words, EUT response has many dependencies (RSSI, quality of signal, path loss variation, fading, etc.,) other than just TPC commands. These dependencies have less impact in conducted setup (as it is a controlled environment and the path loss can be very well calibrated) but have significant impact on radiated testing in an uncontrolled environment, such as SAR test setup. Therefore, the deviation in EUT Tx power from callbox requested power is expected, however the time-averaged SAR should not exceed FCC SAR requirement at all times as Smart Transmit controls Tx power at EUT.

The following steps are for time averaging feature validation through SAR measurement:

1. “Path Loss” calibration: Place the EUT against the phantom in the worst-case position determined based on Section 3.2.1. For each band selected, prior to SAR measurement, perform “path loss” calibration between callbox antenna and EUT. Since the SAR test environment is not controlled and well calibrated for OTA (Over the Air) test, extreme care needs to be taken to avoid the influence from reflections. The test setup is described in Section 6.1.
2. Time averaging feature validation:
 - I. For a given radio configuration (technology/band) selected in Section 3.2.1, enable Smart Transmit and set *Reserve_power_margin* to 0 dB, with callbox to request maximum power, perform area scan, conduct pointSAR measurement at peak location of the area scan. This point SAR value, *point SAR_Plimit*, corresponds to point SAR at the measured *Plimit* (i.e., measured *Plimit* from the EUT in Step 1 of Section 3.3.1).
 - II. Set *Reserve_power_margin* to actual (intended) value and reset power on EUT to enable Smart Transmit. Note, if *Reserve_power_margin* cannot be set wirelessly, care must be taken to re-position the EUT in the exact same position relative to the SAM phantom as in above Step 2.i. Establish radio link in desired radio configuration, with callbox requesting the EUT’s Tx power at power levels described by test sequence 1 generated in Step 1 of Section 3.3.1, conduct point SAR measurement versus time at peak location of the area scan determined in Step 2.i of this section. Once the measurement is done, extract instantaneous point SAR vs time data, point SAR(t), and convert it into instantaneous 1g SAR or 1g SAR vs. time using Eq. (3a), rewritten below:

$$1g_or_10gSAR(t) = \frac{pointSAR(t)}{pointSAR_Plimit} * 1g_or_10gSAR_Plimit$$

where, *pointSAR_Plimit* is the value determined in Step 2.i, and *pointSAR(t)* is the instantaneous point SAR measured in Step 2.ii, *1g_or_10gSAR_Plimit* is the measured 1g SAR or 1g SAR value listed in Part 1 report.

- III. Perform 360s running average to determine time-averaged 1g SAR versus time.
- IV. Make one plot containing: (a) time-averaged 1g SAR or 1g SAR versus time determined in Step 2.III of this section, (b) FCC limit of 1.6 W/kg for 1g SAR. Repeat 2.II ~ 2.IV for test sequence 2 generated in Step 1 of Section 3.3.1.
- V. Repeat 2.i ~ 2.v for all the technologies and bands selected in Section 3.2.1.

The time-averaging validation criteria for SAR measurement is that, at all times, the time-averaged 1g SAR versus time shall not exceed FCC limit of 1.6 W/kg for 1g SAR (i.e., Eq. (3b)).



5. Test Configurations

WWAN (sub-6) Transmission

The P_{limit} values, corresponding to SAR_design_target, for technologies and bands supported by EUT are derived in Part 0 report and summarized in Table 4-1. Note all P_{limit} power levels entered in Table 4-1 correspond to average power levels after accounting for duty cycle in the case of TDD modulation schemes (for e.g., GSM, LTE TDD & Sub6 NR TDD).

The frequency bands corresponding to DSI grades and their power states are as follows:

DSI	Body/Head	Power	Scenario
0	/	full Power	SAR sensor OFF, WLAN OFF;
1	Body	single band	receiver OFF, SAR sensor ON, WLAN OFF;
2	Body	WLAN simultaneously	receiver OFF, SAR sensor ON,WLAN ON;
3	body/head	BT simultaneously	BT ON, WWAN ON;
4	Head	single band	receiver ON, WLAN OFF;
5	Head	WLAN simultaneously	receiver ON, WLAN ON;

Table 5-1 P_{limit} for supported technologies and bands (P_{limit} in EFS file)

Bands	Antenna	1TX	1TX	2TX	2TX	1TX	2TX
		DSI=0	DSI=1	DSI=2	DSI=3	DSI=4	DSI=5
GSM 850	1	33	33	31	33	33	31
GSM 1900	3	30	30	30	30	30	30
WCDMA Band II	3	24	24	24	24	24	24
WCDMA Band IV	3	24	24	24	24	24	24
WCDMA Band V	1	24	24	22	24	24	23
LTE Band 2	3	24	24	24	24	24	24
LTE Band 2	7	24	24	20	24	24	20
LTE Band 4	3	24	24	24	24	24	24
LTE Band 4	7	24	24	20	24	24	20
LTE Band 5	1	24	24	23	24	24	23
LTE Band 7	3	24	24	19	24	24	20
LTE Band 7	7	24	24	19	24	24	20
LTE Band 12	1	24	24	24	24	24	23
LTE Band 13	1	24	24	24	24	24	23
LTE Band 66	3	24	24	24	24	24	24
LTE Band 66	7	24	24	20	24	24	20
LTE Band 48	4	23	23	20	23	20	20
LTE Band 48	10	23	23	20	23	20	20
5G NR n2 (NSA)	3	24	24	20	24	24	24
5G NR n2 (NSA)	7	24	24	20	24	24	20



5G NR n5 (NSA)	1	24	24	23	24	24	23
5G NR n66 (NSA)	3	24	24	20	24	24	24
5G NR n66 (NSA)	7	24	24	20	24	24	20
5G NR n77 (NSA)	4	26	26	17	26	17	17
5G NR n77 (NSA)	10	26	26	20	26	18	18
5G NR n77 (NSA)	2	26	26	20	26	18	18
5G NR n77 (NSA)	3	26	26	20	26	18	18

Note: Maximum tune up target power, P_{max} , is configured in NV settings in EUT to limit maximum transmitting power. This power is converted into peak power in NV settings for TDD schemes. The EUT maximum allowed output power is equal to P_{max} + device uncertainty. Based on selection criteria described in Section 3.2.1, the selected technologies/bands for testing time-varying test sequences are listed in Table 4-1. During Part 2 testing, the *Reserve_power_margin* (dB) for this EUT is set to 3dB in EFS.

The radio configurations used in Part 2 test for selected technologies, bands, DSIs and antennas are listed in Table 4-2. The corresponding worst-case radio configuration 1g SAR values for selected technology/band/DSI are extracted from Part 1 report and are listed in the last column of Table 4-2.

Based on equations (1a), (2a), (3a) and (4a), it is clear that Part 2 testing outcome is normalized quantity, which implies that it can be applied to any radio configuration within a selected technology/band/DSI. Thus, as long as applying the worst-case SAR obtained from the worst radio configuration in Part 1 testing to calculate time-varying SAR exposure in equations (1a), (2a), (3a) and (4a), the accuracy in compliance demonstration remains the same.

Table 5-2: Radio configurations selected for Part 2 test

Test Case	Test Scenario	Tech	Band	Ant	DSI	Channel	Fre. (MHz)	Position	Plim EFS Setting (dBm)	Target Pmax (dBm)	Part 1 1g Worst-case radio configuration (W/kg)
1	Time-varying Tx Power Transmission	GSM	850	Ant 1	2	189	836.4	Front Side	23.8	25	0.346
2		WCDMA	Band 5	Ant 1	2	4182	836.4	Front Side	23.8	25.3	0.623
3		LTE	Band 5	Ant 1	2	20525	836.5	Back Side	23.8	24.8	0.55
4		LTE	Band 7	Ant 3	2	21100	2535	Left Side	18.8	23.8	0.597
5	Call Drop	LTE	Band 7	Ant 3	2	21100	2535	Left Side	18.8	23.8	0.597
6	Tech/Band Switch	WCDMA	Band 5	Ant 1	2	4182	836.4	Front Side	23.8	25.3	0.623
7		LTE	Band 5	Ant 1	2	20525	836.5	Back Side	23.8	24.8	0.55
8	DSI Switch	LTE	Band 7	Ant 3	2	21100	2535	Left Side	18.8	23.8	0.597

Note that the EUT has multiple DSI state to manage power for different RF exposure conditions, detail DSI states and trigger conditions shown on the following table, the maximum 1g SAR/or 10g SAR among all exposure scenarios is used in Smart Transmit feature for time averaging operation. The Plimit of simultaneous transmission is the same as single transmission.

DSI	2
scenario	Default
SAR sensor	Close to receiver

Based on the selection criteria described in Section 3.2, the radio configurations for the Tx varying transmission test cases listed in Section 2 are:

1. Technologies and bands for time-varying Tx power transmission: The test case 1~4 listed in



Table 4-2 are selected to test with the test sequences defined in Section 3.1 in both time-varying conducted power measurement and time-varying SAR measurement.

2. Technology and band for change in call test: The test case 5 listed in Table 4-2 is selected for performing the call drop test in LTE in conducted power setup.
3. Technologies and bands for change in technology/band test: The test case 6 listed in Table 4-2 is selected for handover test from a technology/band to another technology/band, in conducted power setup.
4. Technologies and bands for switch in SAR exposure: The test case 7 listed in Table 4-2 are selected for SAR exposure switching test in one of the supported simultaneous WWAN transmission scenario, in conducted power setup.

6. Conducted Power Test Results for Sub-6 Smart Transmit Feature Validation

6.1. Measurement Setup

The Rohde & Schwarz CMW500 callbox is used in this test. The test setup picture and schematic are shown in Figures 6-1a & 6-1c for measurements with a single antenna of EUT, and in Figures 6-1b & 6-1d for measurements involving antenna switch. For single antenna measurement, one port (RF1 COM) of the callbox is connected to the RF port of the EUT using a directional coupler. For antenna & technology switch measurement, two ports (RF1 COM and RF3 COM) of the callbox used for signaling two different technologies are connected to a combiner, which is in turn connected to a directional coupler. The other end of the directional coupler is connected to a splitter to connect to two RF ports of the EUT corresponding to the two antennas of interest. In both the setups, power meter is used to tap the directional coupler for measuring the conducted output power of the EUT. For time averaging validation test (Section 4.3.1), call drop test (Section 4.3.2), and DSI switch test (Section 4.3.5), only RF1 COM port of the callbox is used to communicate with the EUT. For technology/band switch measurement (Section. 4.3.3), both RF1 COM and RF3 COM port of callbox are used to switch from one technology communicating on RF1 COM port to another technology communicating on RF3 COM port. Note that for this EUT, antenna switch test (Section 4.3.4) is included within time-window switch test (Section 4.3.6) as the selected technology/band combinations for the time-window switch test are on two different antennas. All the path losses from RF port of EUT to the callbox RF COM port and to the power meter are calibrated and automatically entered as offsets in the callbox and the power meter via test scripts on the PC used to control callbox and power meter.

LTE+Sub6 NR test setup:

If LTE conducted port and Sub6 NR conducted port are same on this EUT (i.e., they share the same antenna), then low-/high-pass filter is used to separate LTE and Sub6 NR signals for power meter measurement via directional couplers, as shown in below Figures 6-1a, 6-1b & 6-1c.

Please refer to Attachment F for the test setup picture.

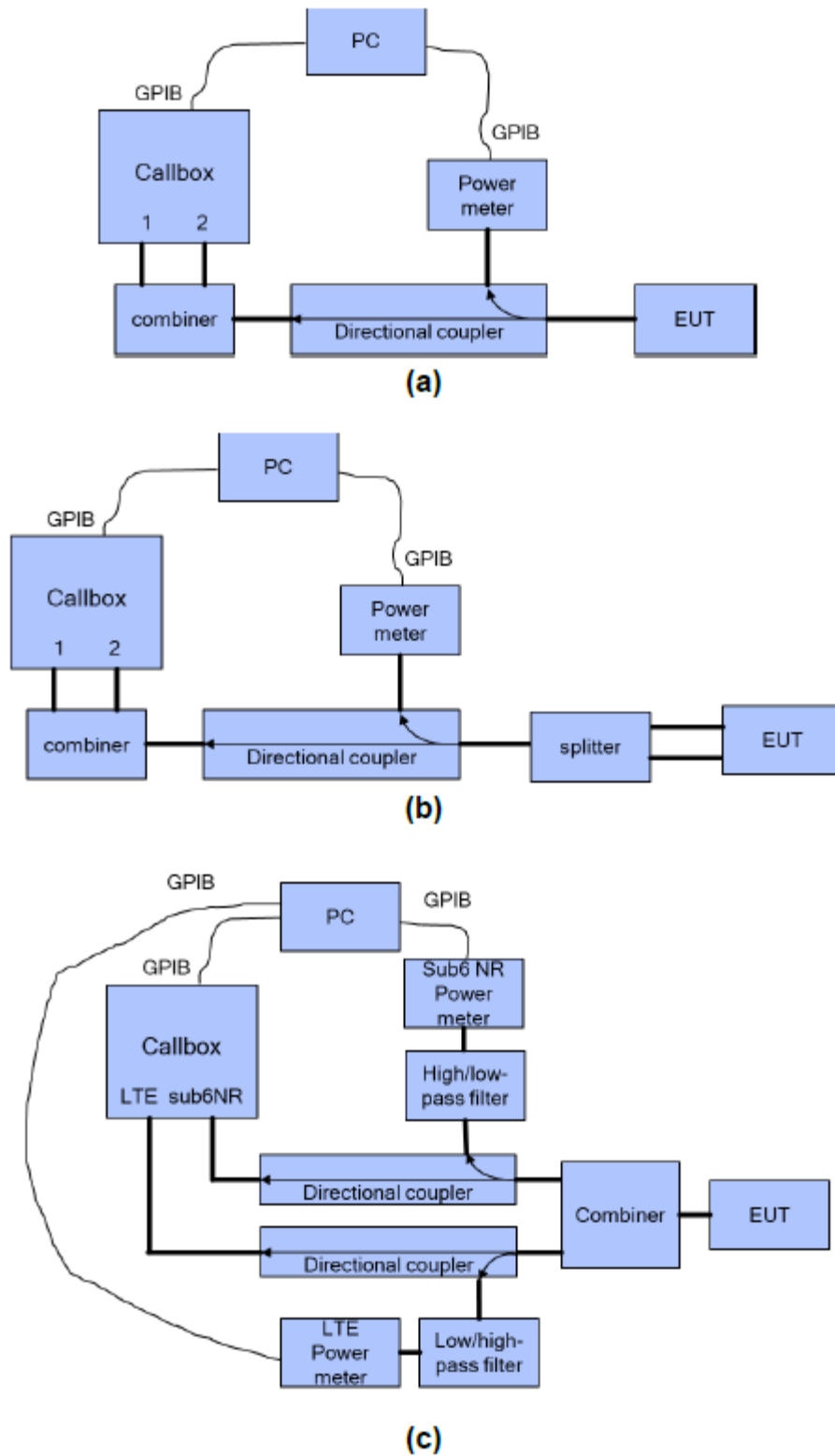

Figure 6-1 Example conducted power measurement setup



Both the callbox and power meter are connected to the PC using GPIB cables. Two test scripts are custom made for automation, and the test duration set in the test scripts is 500 seconds.

For time-varying Tx power measurement, the PC runs the 1st test script to send GPIB commands to control the callbox's requested power versus time, while at the same time to record the conducted power measured at EUT RF port using the power meter. The commands sent to the callbox to request power are:

- 0dBm for 100 seconds
- Test sequence 1 or test sequence 2 (defined in Section 3.1 and generated in Section 3.2.1), for 360 seconds
- Stay at the last power level of test sequence 1 or test sequence 2 for the remaining time. Power meter readings are periodically recorded every 100ms. A running average of this measured Tx power over 100 seconds is performed in the post-data processing to determine the 360s-time averaged power.

For call drop, technology/band/antenna switch, after the call is established, the callbox is set to request the EUT's Tx power at 0dBm for 100 seconds while simultaneously starting the 2nd test script runs at the same time to start recording the Tx power measured at EUT RF port using the power meter. After the initial 100 seconds since starting the Tx power recording, the callbox is set to request maximum power from the EUT for the rest of the test. Note that the call drop/re-establish, or technology/band/antenna switch is manually performed when the Tx power of EUT is at *Preserve* level. See Section 3.3 for detailed test procedure of call drop test, technology/band/antenna switch test.

6.2. Plimit and Pmax Measurement Results

The measured Plimit for all the selected radio configurations given in Table 5-1 are listed in below Table 5-1. Pmax was also measured for radio configurations selected for testing time-varying Tx power transmission scenarios in order to generate test sequences following the test procedures in Section 4.1.

Table 6-1: Measured P_{limit} and P_{max} of selected radio configurations

Test Case	Test Scenario	Tech	Band	Ant	DSI	Channel	Fre. (MHz)	Position	Plim EFS Setting (dBm)	Target Pmax (dBm)	Measured Plim (dBm)	Measured Pmax (dBm)
1	Time-varying Tx Power Transmission	GSM	850	Ant 1	2	189	836.4	Front Side	23.8	25	22.417	23.503
2		WCDMA	Band 5	Ant 1	2	4182	836.4	Front Side	23.8	25.3	22.64	23.48
3		LTE	Band 5	Ant 1	2	20525	836.5	Back Side	23.8	24.8	22.405	23.477
4		LTE	Band 7	Ant 3	2	21100	2535	Left Side	18.8	23.8	18.572	22.743
5	Call Drop	LTE	Band 7	Ant 3	2	21100	2535	Left Side	18.8	23.8	18.572	22.743
6	Tech/Band Switch	WCDMA	Band 5	Ant 1	2	4182	836.4	Front Side	23.8	25.3	22.64	23.48
7		LTE	Band 5	Ant 1	2	20525	836.5	Back Side	23.8	24.8	22.405	23.477
8	DSI Switch	LTE	Band 7	Ant 3	2	21100	2535	Left Side	18.8	23.8	18.572	22.743

Note: the device uncertainty of P_{max} is $+1dB/-1dB$ as provided by manufacturer.

6.3. Time-varying Tx Power Measurement Results

The measurement setup is shown in Figures 6-1(a) and 6-1(c). The purpose of the time-varying Tx power measurement is to demonstrate the effectiveness of power limiting enforcement and that the time- averaged Tx power when represented in time-averaged 1g SAR or 1g SAR values does not exceed FCC limit as shown in Eq. (1a) and (1b), rewritten below:

$$1g_or_10gSAR(t) = \frac{conducted_Tx_power(t)}{conducted_Tx_power_P_{limit}} * 1g_or_10gSAR_P_{limit} \quad (1a)$$

$$\frac{\frac{1}{T_{SAR}} \int_{t-T_{SAR}}^t 1g_or_10gSAR(t) dt}{FCC\ SAR\ limit} \leq 1 \quad (1b)$$

where, $conducted_Tx_power(t)$, $conducted_Tx_power_P_{limit}$, and $1g_or_10gSAR_P_{limit}$ correspond to the measured instantaneous conducted Tx power, measured conducted Tx power at P_{limit} , and measured 1g SAR and 1g SAR values at P_{limit} reported in Part 1 test (listed in Table 5-2 of this report as well).

Following the test procedure in Section 4.3, the conducted Tx power measurement for all selected configurations are reported in this section. In all the conducted Tx power plots, the dotted line represents the requested power by callbox (test sequence 1 or test sequence 2), the blue curve represents the instantaneous conducted Tx power measured using power meter, the green curve represents time- averaged power and red line represents the conducted power limit that corresponds to FCC limit of 1.6 W/kg for 1g SAR or 1.6 W/kg for 1g SAR. Similarly, in all the 1g or 1g SAR plots (when converted using Eq. (1a)), the green curve represents the 360s/60s-time averaged 1g SAR or 1g SAR value calculated based on instantaneous 1g SAR or 1g SAR ; and the red line limit represents the FCC limit of 1.6 W/kg for 1g SAR or 1.6 W/kg for 1g SAR .



➤ **GSM 850(Test Case 1)**

Test result for test sequence 1:

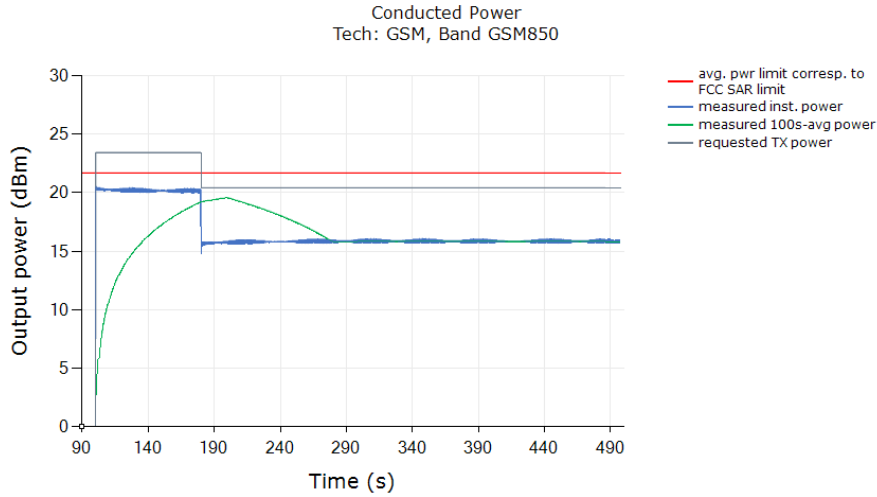

Above time-averaged conducted Tx power is converted/calculated into time-averaged 1g SAR using Equation (1a) and plotted below to demonstrate that the time-averaged 1g SAR versus time does not exceed the FCC limit of 1.6 W/kg for 1g SAR:

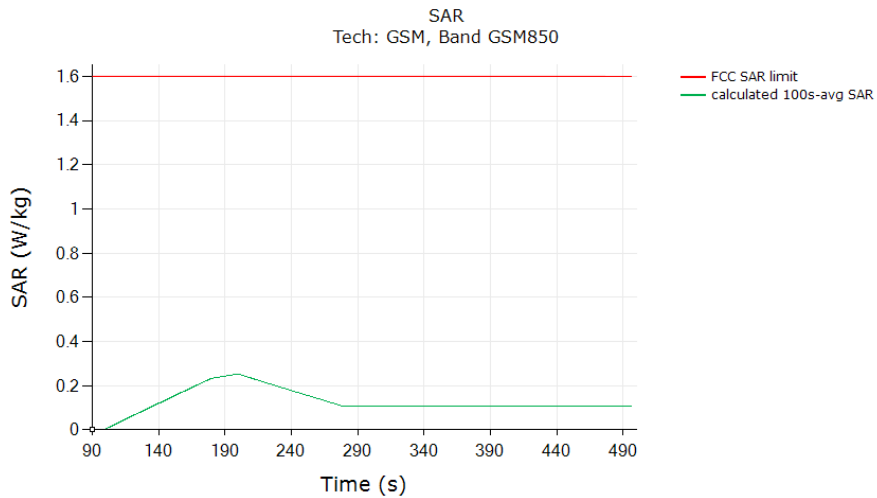

λ	(W/kg)
FCC 1g SAR limit	1.6
Max 100s-time averaged 1gSAR (green curve)	0.253
Validated: Max time averaged SAR (green curve) is within device uncertainty of measured SAR at Plimit	

The test result validated the continuity of power limiting in call change scenario.



Test result for test sequence 2:

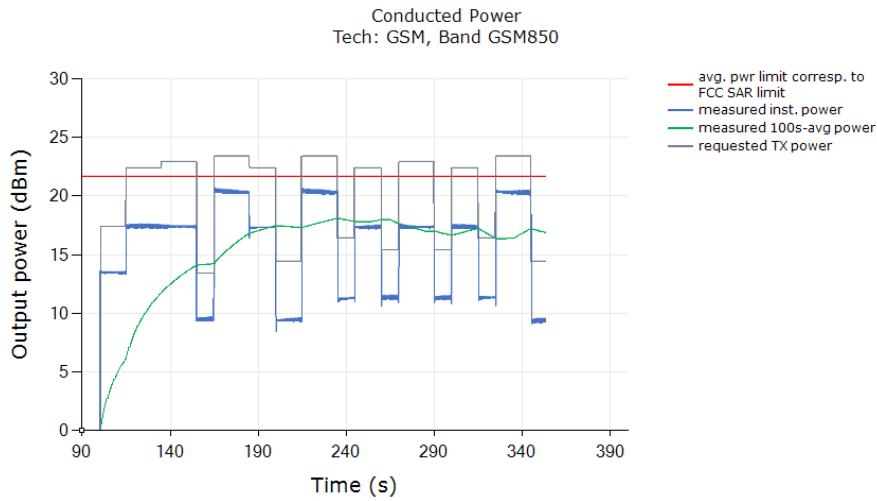

Above time-averaged conducted Tx power is converted/calculated into time-averaged 1g SAR using Equation (1a) and plotted below to demonstrate that the time-averaged 1g SAR versus time does not exceed the FCC limit of 1.6 W/kg for 1g SAR:

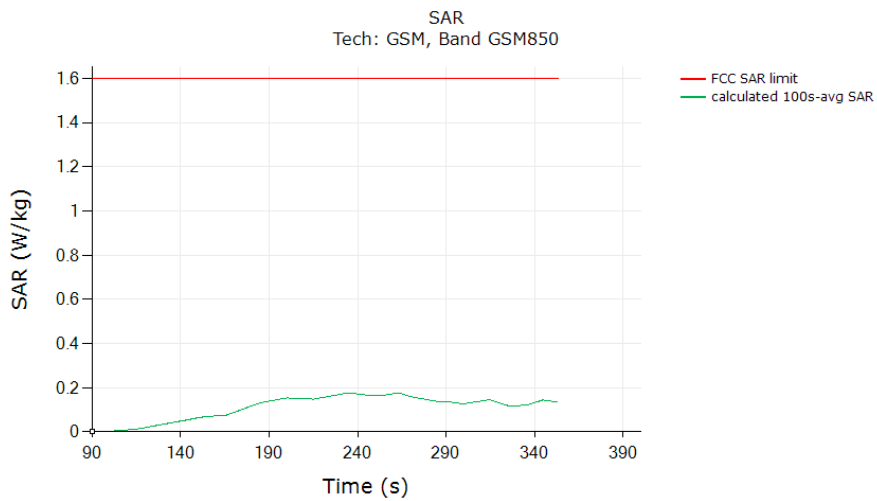

λ	(W/kg)
FCC 1g SAR limit	1.6
Max 100s-time averaged 1gSAR (green curve)	0.177
Validated: Max time averaged SAR (green curve) is within device uncertainty of measured SAR at Plimit	

The test result validated the continuity of power limiting in call change scenario.



➤ **WCDMA Band V (Test Case 2)**

Test result for test sequence 1:

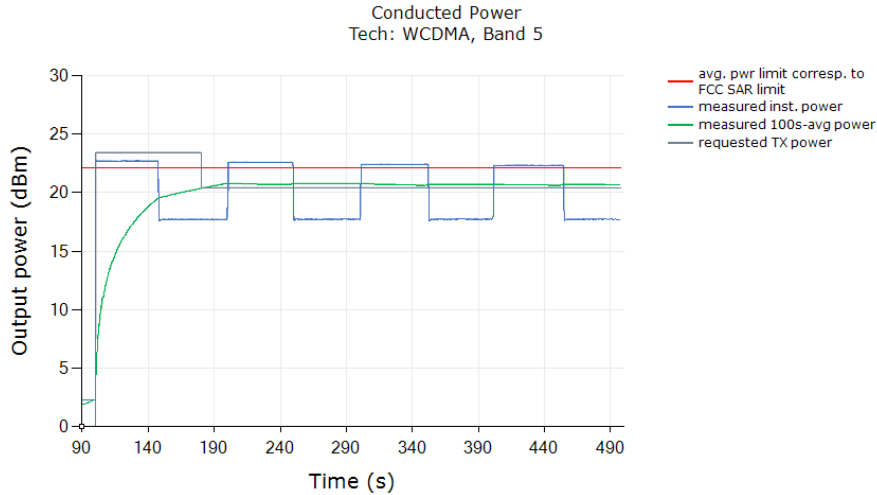

Above time-averaged conducted Tx power is converted/calculated into time-averaged 1g SAR using Equation (1a) and plotted below to demonstrate that the time-averaged 1g SAR versus time does not exceed the FCC limit of 1.6 W/kg for 1g SAR:

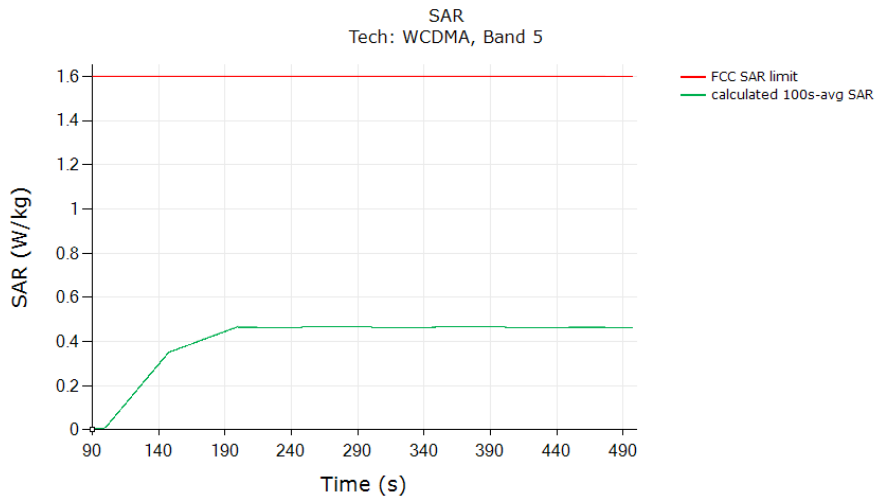

λ	(W/kg)
FCC 1g SAR limit	1.6
Max 100s-time averaged 1gSAR (green curve)	0.466
Validated: Max time averaged SAR (green curve) is within device uncertainty of measured SAR at P _{limit}	

The test result validated the continuity of power limiting in call change scenario.



Test result for test sequence 2:

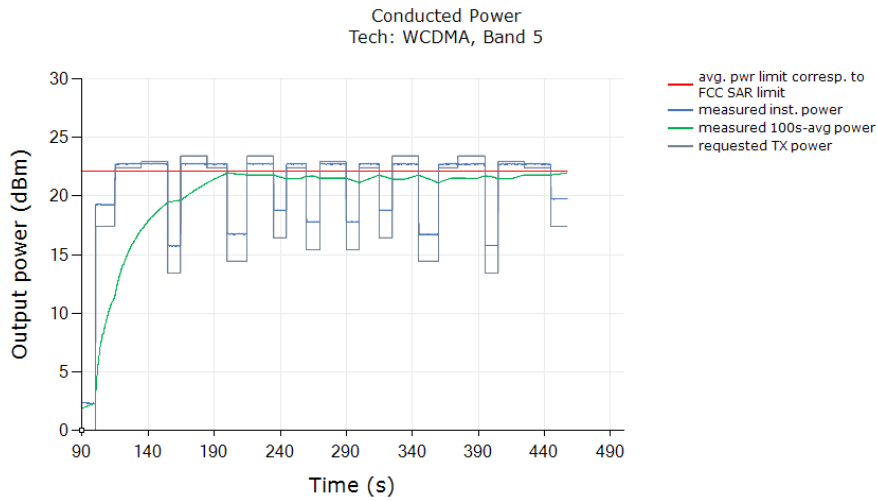

Above time-averaged conducted Tx power is converted/calculated into time-averaged 1g SAR using Equation (1a) and plotted below to demonstrate that the time-averaged 1g SAR versus time does not exceed the FCC limit of 1.6 W/kg for 1g SAR:

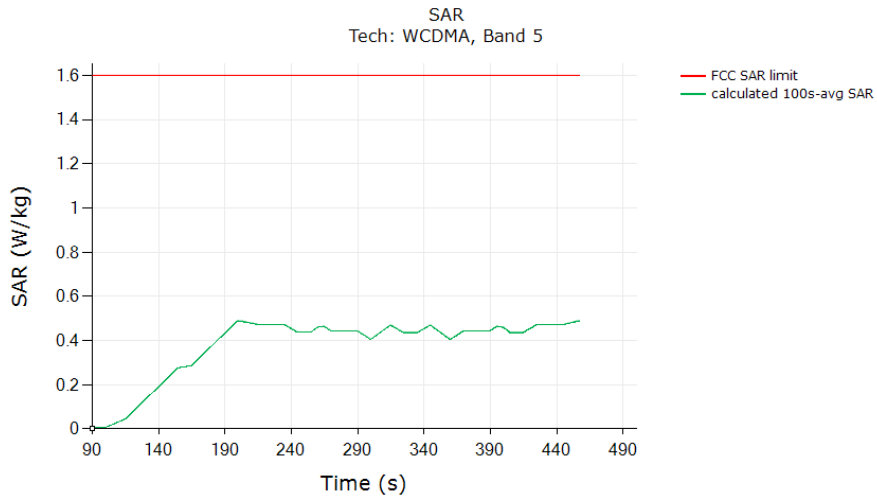

λ	(W/kg)
FCC 1g SAR limit	1.6
Max 100s-time averaged 1gSAR (green curve)	0.489
Validated: Max time averaged SAR (green curve) is within device uncertainty of measured SAR at Plimit	

The test result validated the continuity of power limiting in call change scenario.

➤ **LTE Band 5 (Test Case 3)**

Test result for test sequence 1:

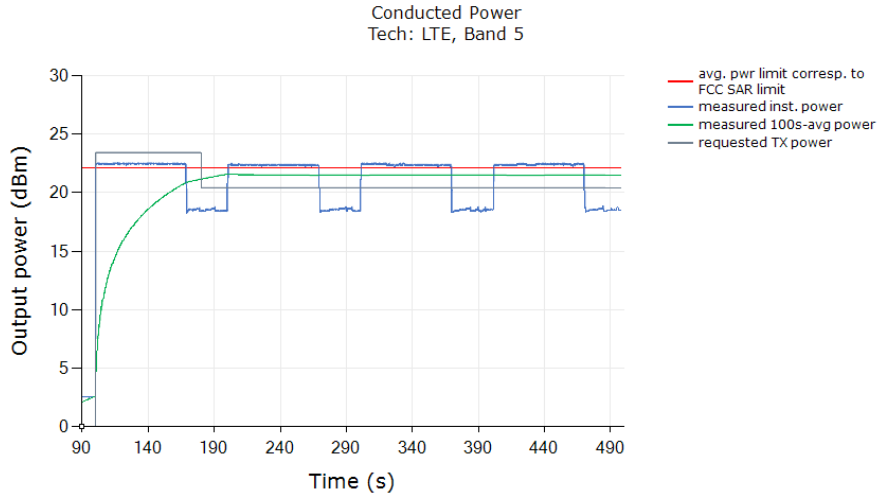

Above time-averaged conducted Tx power is converted/calculated into time-averaged 1g SAR using Equation (1a) and plotted below to demonstrate that the time-averaged 1g SAR versus time does not exceed the FCC limit of 1.6 W/kg for 1g SAR:

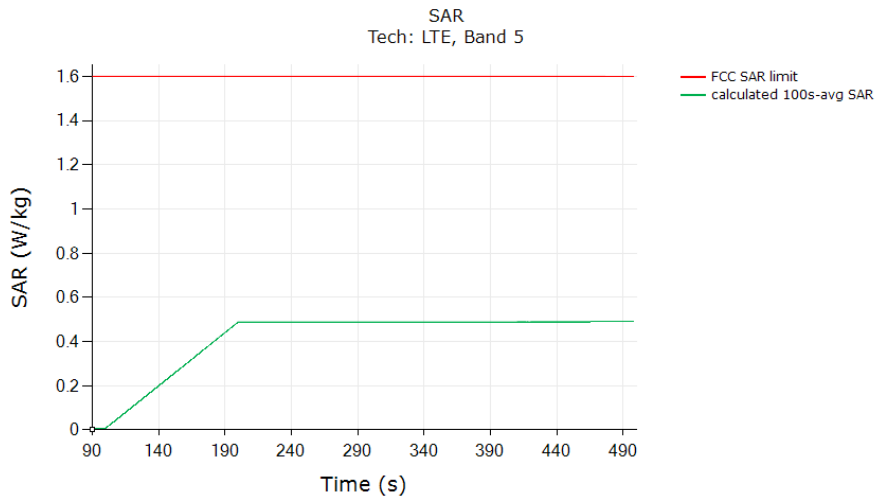

λ	(W/kg)
FCC 1g SAR limit	1.6
Max 100s-time averaged 1gSAR (green curve)	0.489
Validated: Max time averaged SAR (green curve) is within device uncertainty of measured SAR at P _{limit}	

The test result validated the continuity of power limiting in call change scenario.



Test result for test sequence 2:

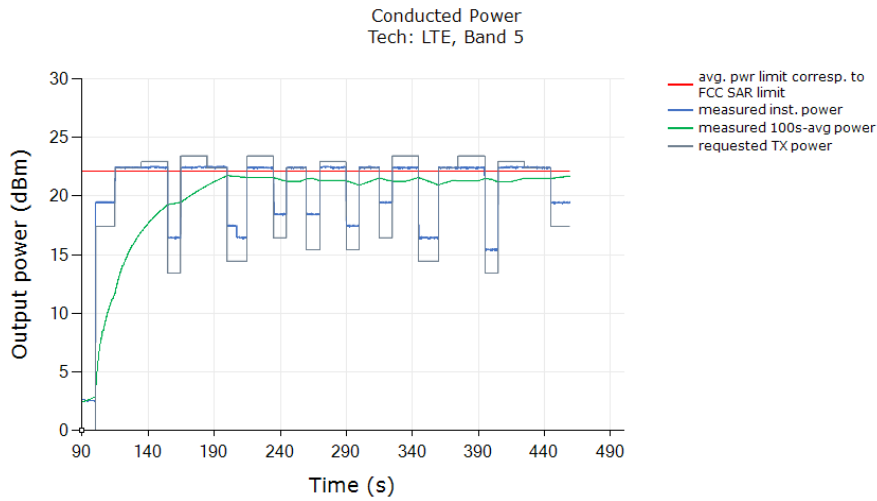

Above time-averaged conducted Tx power is converted/calculated into time-averaged 1g SAR using Equation (1a) and plotted below to demonstrate that the time-averaged 1g SAR versus time does not exceed the FCC limit of 1.6 W/kg for 1g SAR:

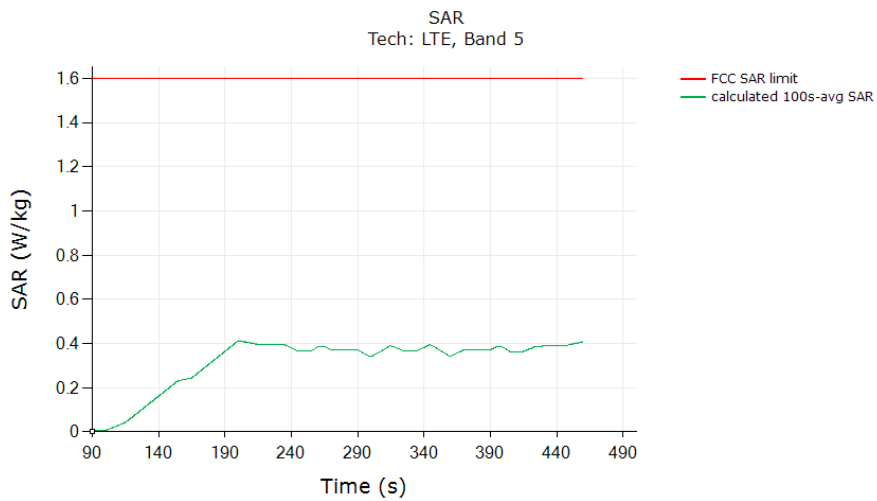

λ	(W/kg)
FCC 1g SAR limit	1.6
Max 100s-time averaged 1gSAR (green curve)	0.410
Validated: Max time averaged SAR (green curve) is within device uncertainty of measured SAR at Plimit	

The test result validated the continuity of power limiting in call change scenario.

➤ **LTE Band 7 (Test Case 4)**

Test result for test sequence 1:

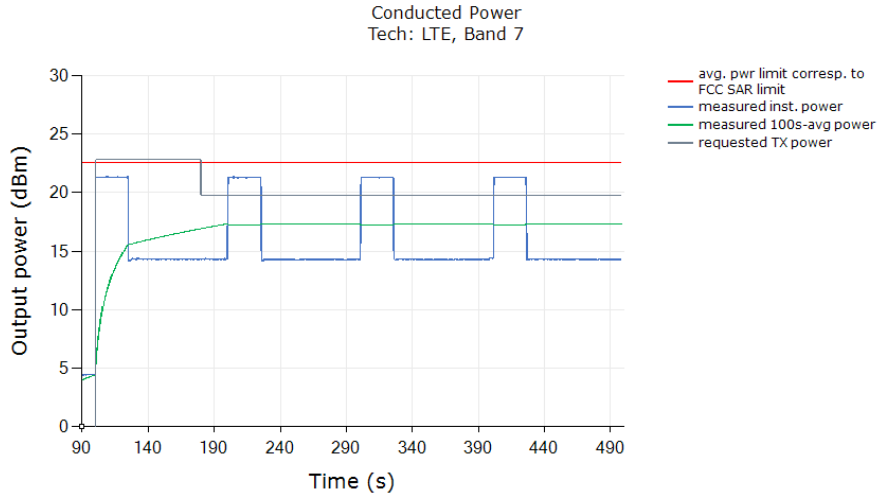

Above time-averaged conducted Tx power is converted/calculated into time-averaged 1g SAR using Equation (1a) and plotted below to demonstrate that the time-averaged 1g SAR versus time does not exceed the FCC limit of 1.6 W/kg for 1g SAR:

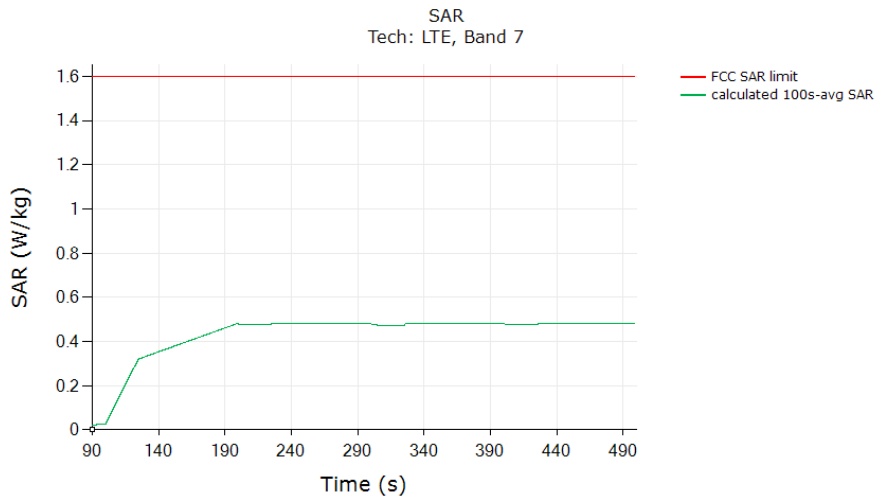

λ	(W/kg)
FCC 1g SAR limit	1.6
Max 100s-time averaged 1gSAR (green curve)	0.482
Validated: Max time averaged SAR (green curve) is within device uncertainty of measured SAR at P _{limit}	

The test result validated the continuity of power limiting in call change scenario.



Test result for test sequence 2:

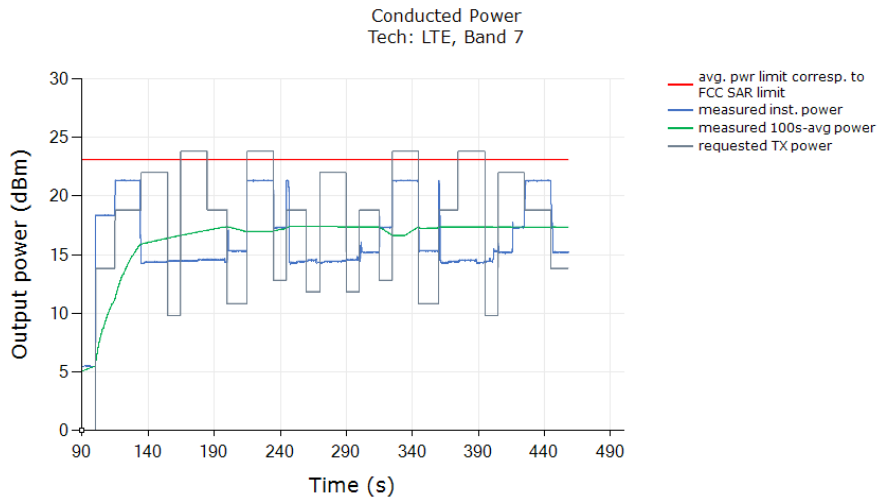

Above time-averaged conducted Tx power is converted/calculated into time-averaged 1g SAR using Equation (1a) and plotted below to demonstrate that the time-averaged 1g SAR versus time does not exceed the FCC limit of 1.6 W/kg for 1g SAR:

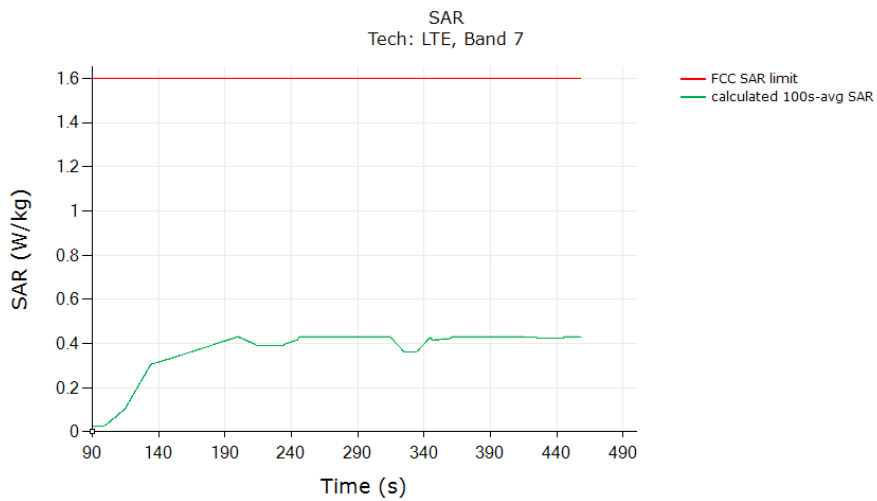

λ	(W/kg)
FCC 1g SAR limit	1.6
Max 100s-time averaged 1gSAR (green curve)	0.430
Validated: Max time averaged SAR (green curve) is within device uncertainty of measured SAR at Plimit	

The test result validated the continuity of power limiting in call change scenario.

➤ **Change in Call Drop Test Results (Test Case 5)**

This test was measured with LTE Band 7 and with callbox requesting maximum power. The call drop was manually performed when the EUT is transmitting at Preserve level as shown in the plot below (dotted black region). The measurement setup is shown in Figure 6-1(a) and (c). The detailed test procedure is described in Section 3.3.2.

Call drop test result:

Plot 1: Measured Tx power (dBm) versus time shows that the transmitting power kept the same Preserve level of LTE Band 7 after the call was re-established:

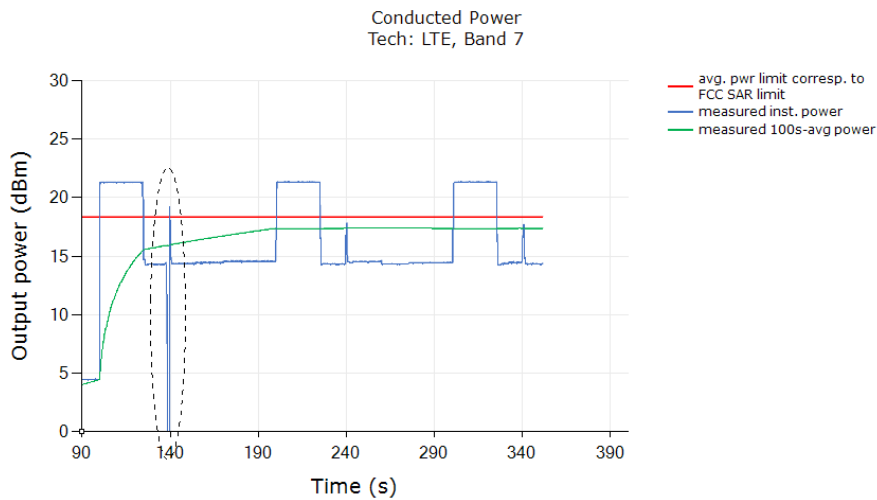

Above time-averaged conducted Tx power is converted/calculated into time-averaged 1g SAR using Equation (1a) and plotted below to demonstrate that the time-averaged 1g SAR versus time does not exceed the FCC limit of 1.6 W/kg for 1g SAR:

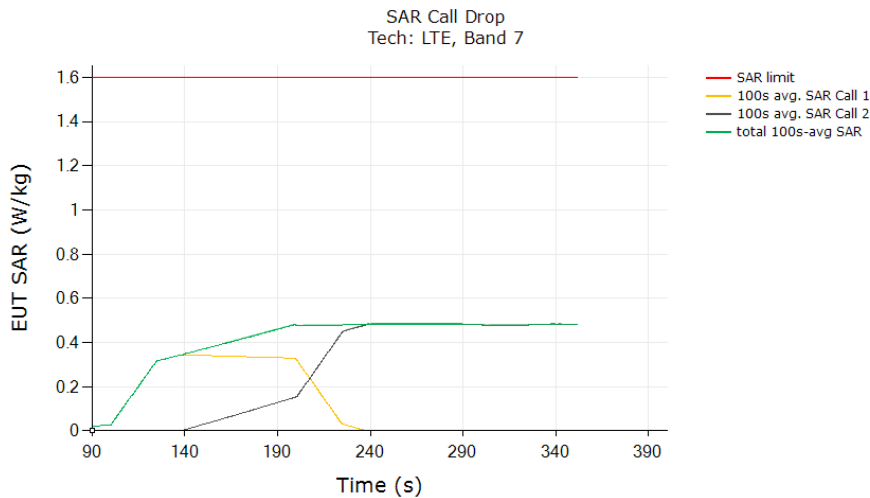

λ	(W/kg)
FCC 1g SAR limit	1.6
Max 100s-time averaged 1gSAR (green curve)	0.484
Validated: Max time averaged SAR (green curve) is within device uncertainty of measured SAR at Plimit	

The test result validated the continuity of power limiting in call change scenario.

➤ **Change in Technology/Band/Antenna Switch Test Results (Test case 6)**

This test was conducted with callbox requesting maximum power, and with antenna & technology switch from LTE Band 5, DSI=2 to WCDMA Band V, DSI=2. Following procedure detailed in Section 3.3.3, and using the measurement setup shown in Figure 5-1(a) and (c), the technology/band switch was performed when the EUT is transmitting at Preserve level as shown in the plot below (dotted black region).

Test result for change in technology/band:

Plot 1: Measured Tx power (dBm) versus time shows that the transmitting power changed from LTE Band 5, DSI=2 $P_{reserve}$ level to WCDMA Band V, DSI=2 (within device uncertainty):

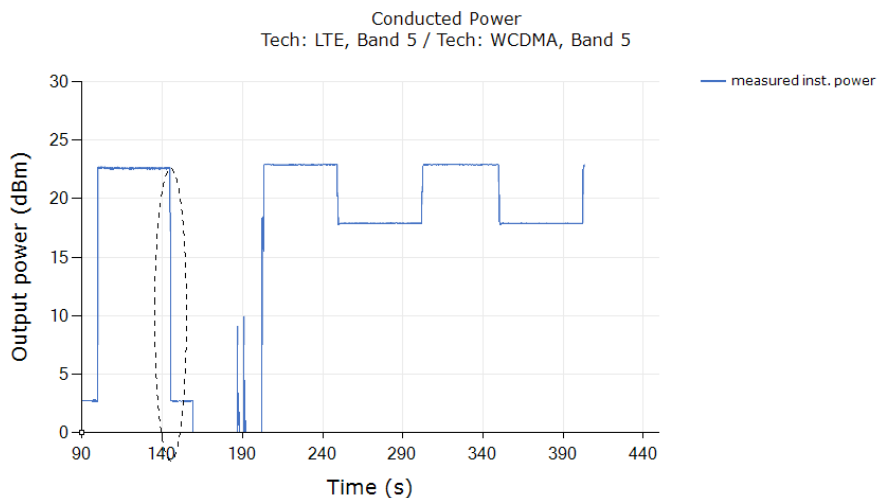

Plot 2: All the time-averaged conducted Tx power measurement results were converted into time-averaged normalized SAR values using Equation (6a), (6b) and (6c), and plotted below to demonstrate that the time- averaged normalized SAR versus time does not exceed the normalized FCC limit of 1.0:

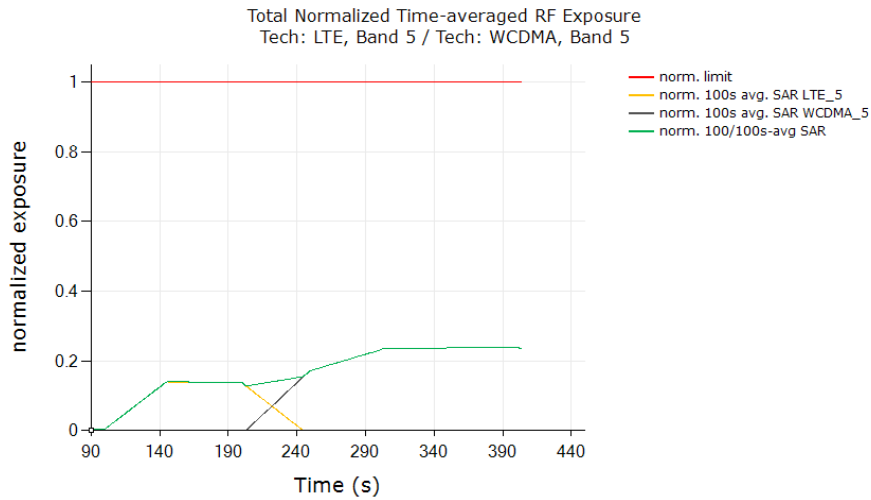

\	(W/kg)
FCC 1g SAR limit	1.6
Max 100s-time averaged 1gSAR (green curve)	0.238
Validated: Max time averaged SAR (green curve) is within device uncertainty of measured SAR at Plimit	

The test result validated the continuity of power limiting in call change scenario.

➤ **Change in DSI Switch Test Results (Test case 7)**

This test was conducted with callbox requesting maximum power, and with DSI switch from LTE Band 7, DSI=0 to DSI=2. Following procedure detailed in Section 3.3.5, and using the measurement setup shown in Figure 5-1(a) and (c), the technology/band switch was performed when the EUT is transmitting at $P_{reserve}$ level as shown in the plot below (dotted black region).

Test result for change in technology/band:

Plot 1: Measured Tx power (dBm) versus time shows that the transmitting power changed from DSI=0 switches to DSI=2 (within device uncertainty):

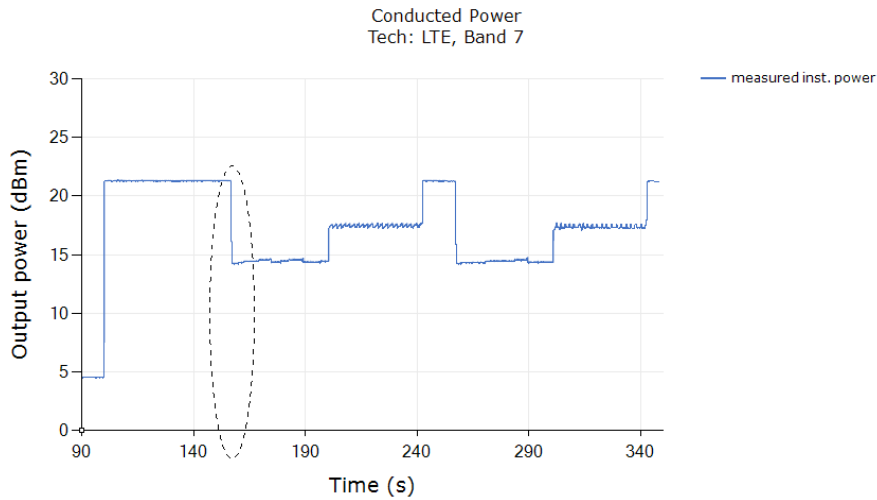

Plot 2: All the time-averaged conducted Tx power measurement results were converted into time-averaged normalized SAR values using Equation (6a), (6b) and (6c), and plotted below to demonstrate that the time- averaged normalized SAR versus time does not exceed the normalized FCC limit of 1.0:

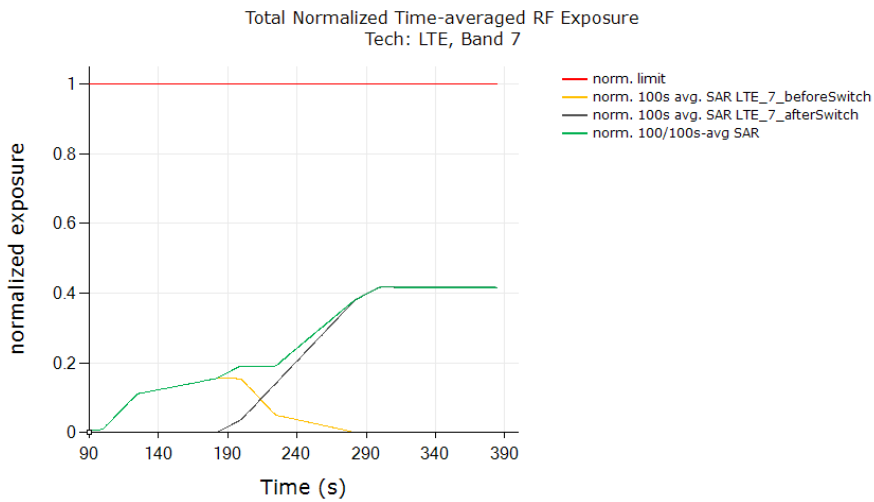

λ	(W/kg)
FCC 1g SAR limit	1.6
Max 100s-time averaged 1gSAR (green curve)	0.417
Validated: Max time averaged SAR (green curve) is within device uncertainty of measured SAR at Plimit	

The test result validated the continuity of power limiting in call change scenario.



7. SAR Test Results for Sub-6 Smart Transmit Feature

7.1. Measurement Setup

The measurement setup is similar to normal SAR measurements. The difference in SAR measurement setup for time averaging feature validation is that the callbox is signaling in close loop power control mode (instead of requesting maximum power in open loop control mode) and callbox is connected to the PC using GPIB so that the test script executed on PC can send GPIB commands to control the callbox's requested power over time (test sequence). The same test script used in conducted setup for time-varying Tx power measurements is also used in this section for running the test sequences during SAR measurements, and the recorded values from the disconnected power meter by the test script were discarded.

As mentioned in Section 4.4, for EUT to follow TPC command sent from the callbox wirelessly, the "path loss" between callbox antenna and the EUT needs to be very well calibrated. Since the SAR chamber is in uncontrolled environment, precautions must be taken to minimize the environmental influences on "path loss". Similarly, in the case of time-varying SAR measurements in LTE, "path loss" between callbox antenna and the EUT needs to be carefully calibrated for both LTE link as well as for Sub6 NR link.

The EUT is placed in worst-case position according to Table 4-2, EUT test setup photos please refers to Annex F.



7.2. SAR Measurement Results for Time-varying Tx power

Transmission scenario

Following Section 4.4 procedure, time-averaged SAR measurements are conducted using EX3DV4 probe at peak location of area scan over 500 seconds. cDASY6 system verification for SAR measurement is provided in Appendix C, and the associated SPEAG FCC rtificates are attached in Appendix D.

SAR probe integration times depend on the communication signal being tested. Integration times used by SPEAG for their probe calibrations can be downloaded from here (integration time is listed on the bottom of the first page for each tech):

<https://www.speag.com/assets/downloads/services/cs/UIDSummary171205.pdf>

Since the sampling rate used by cDASY6 for point SAR measurements is not in user control, the number of points in 360s or 60s interval is determined from the scan duration setting in cDASY6 time-average point SAR measurement by (360s or 60s / cDASY6_scan_duration * total number of point SAR values recorded). Running average is performed over these number of points in excel spreadsheet to obtain 360s-/60s-averaged point SAR.

Following Section 4.4, for each of selected technology/band (listed in Table 5-2):

5. With Reserve_power_margin set to 0 dB, area scan is performed at P_{limit}, and time-averaged point SAR measurements are conducted to determine the point SAR at P_{limit} at peak location, denoted as point SAR P_{limit}.
6. With Reserve_power_margin set to actual (intended) value, two more time-averaged point SAR measurements are performed at the same peak location for test sequences 1 and 2. To demonstrate compliance, all the pointSAR measurement results were converted into 1gSAR or 10gSAR values by using Equation (3a), rewritten below:

$$1g_or_10gSAR(t) = \frac{pointSAR(t)}{pointSAR_{P_{limit}}} * 1g_or_10gSAR_{P_{limit}} \quad (3a)$$

where, $pointSAR(t)$, $pointSAR_{P_{limit}}$, and $1g_or_10gSAR_{P_{limit}}$ correspond to the measured instantaneous point SAR, measured point SAR at P_{limit} from above step 1 and 2, and measured 1gSAR or 10gSAR values at P_{limit} obtained from Part 1 report and listed in Table 5-2 in Section 5 of this report.



➤ **GSM 850 SAR Test Results (Test case 1)**

SAR test result for test sequence 1:

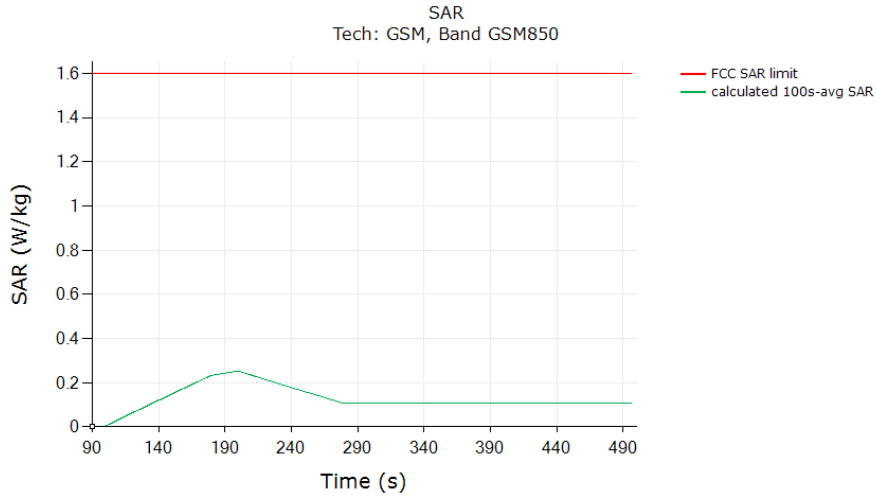

λ	(W/kg)
FCC 1gSAR limit	1.6
Max 360s-time averaged 1gSAR (green curve)	0.253
Validated: Max time averaged SAR (green curve) is within device uncertainty of measured SAR at Plimit	

Test result for test sequence 2:

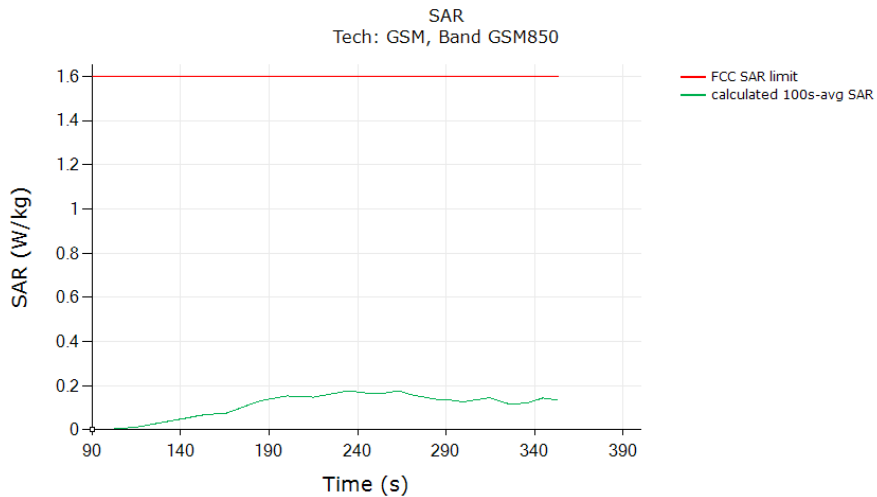

λ	(W/kg)
FCC 1gSAR limit	1.6
Max 100s-time averaged 1gSAR (green curve)	0.177



Validated: Max time averaged SAR (green curve) is within device uncertainty of measured SAR at Plimit

➤ **WCDMA Band V SAR Test Results (Test case 2)**

SAR test result for test sequence 1:

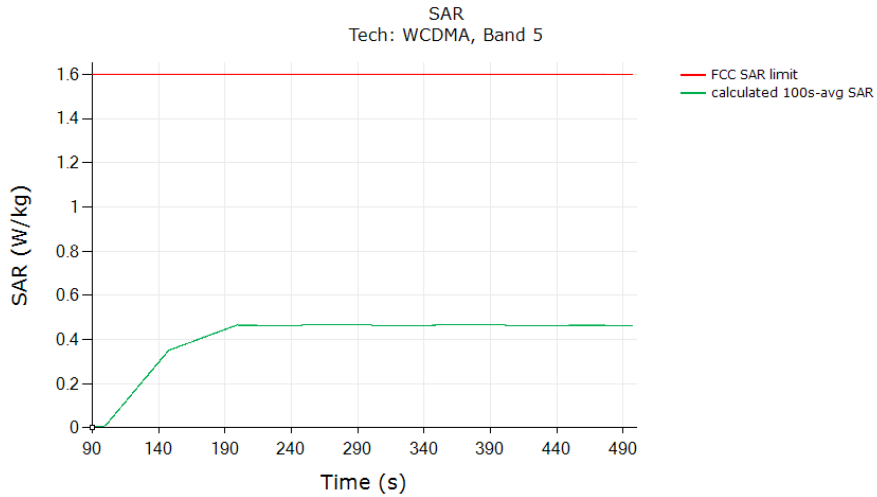

λ	(W/kg)
FCC 1gSAR limit	1.6
Max 360s-time averaged 1gSAR (green curve)	0.466
Validated: Max time averaged SAR (green curve) is within device uncertainty of measured SAR at Plimit	

Test result for test sequence 2:

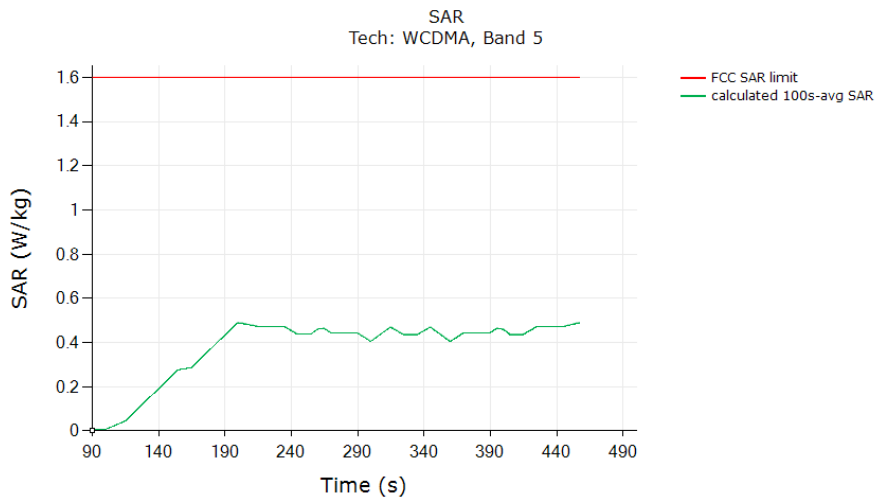



λ	(W/kg)
FCC 1gSAR limit	1.6
Max 100s-time averaged 1gSAR (green curve)	0.489
Validated: Max time averaged SAR (green curve) is within device uncertainty of measured SAR at Plimit	

➤ **LTE Band 5 SAR Test Results (Test case 3)**

SAR test result for test sequence 1:

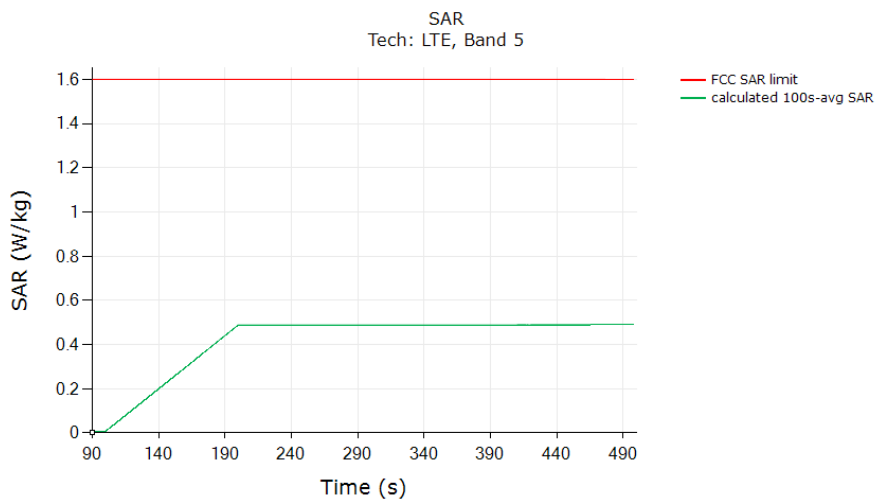

λ	(W/kg)
FCC 1gSAR limit	1.6
Max 360s-time averaged 1gSAR (green curve)	0.489
Validated: Max time averaged SAR (green curve) is within device uncertainty of measured SAR at Plimit	

Test result for test sequence 2:

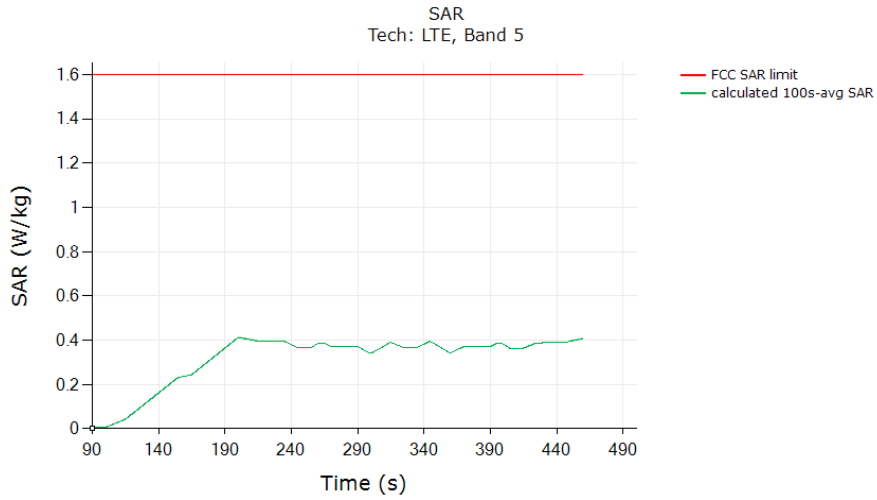

\	(W/kg)
FCC 1gSAR limit	1.6
Max 100s-time averaged 1gSAR (green curve)	0.410
Validated: Max time averaged SAR (green curve) is within device uncertainty of measured SAR at Plimit	

➤ **LTE Band 7 SAR Test Results (Test case 4)**

SAR test result for test sequence 1:

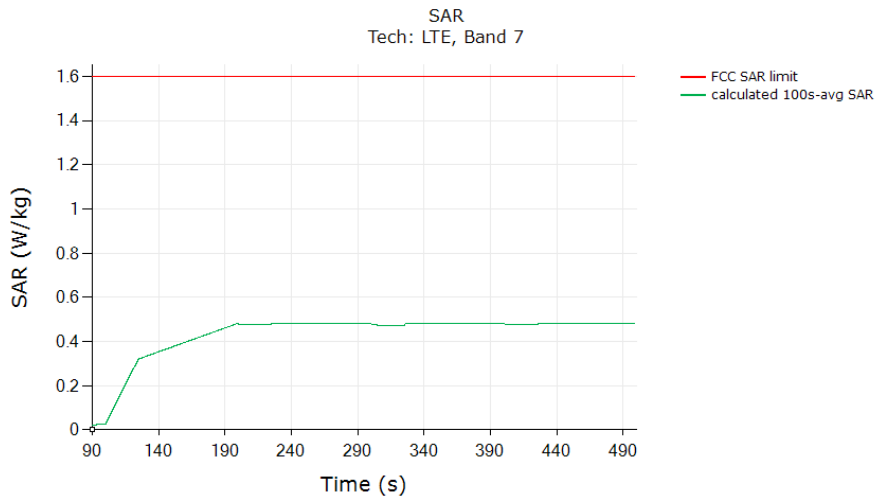

\	(W/kg)
FCC 1gSAR limit	1.6
Max 360s-time averaged 1gSAR (green curve)	0.482



Validated: Max time averaged SAR (green curve) is within device uncertainty of measured SAR at Plimit

Test result for test sequence 2:

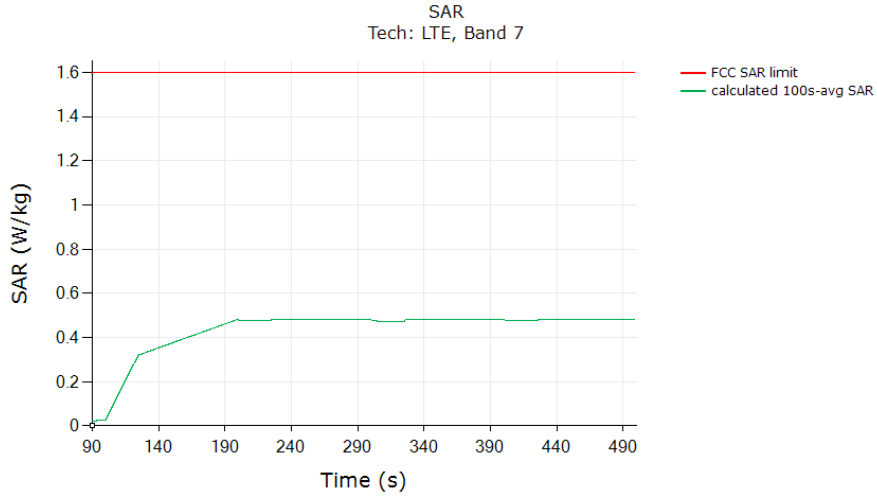

\	(W/kg)
FCC 1gSAR limit	1.6
Max 100s-time averaged 1gSAR (green curve)	0.430

Validated: Max time averaged SAR (green curve) is within device uncertainty of measured SAR at Plimit



8. Conclusions

Qualcomm Smart Transmit feature employed has been validated through the conducted/radiated power measurement, as well as SAR measurement as demonstrated in this report, the power limiting enforcement is effective and the total normalized time-averaged RF exposure does not exceed 1.0 for all the transmission scenarios described in Section 3. Therefore, the EUT complies with FCC RF exposure requirement

Annex A Test Sequences

7. Test sequence is generated based on below parameters of the EUT:
 - a. Measured maximum power (Pmax)
 - b. Measured Tx_power_at_SAR_design_target (Plimit)
 - c. Reserve_power_margin (dB)
 - Preserve (dBm) = measured Plimit (dBm) – Reserve_power_margin (dB)
 - d. SAR_time_window (100s for FCC)

8. Test Sequence 1 Waveform:

Based on the parameters above, the Test Sequence 1 is generated with one transition between high and low Tx powers. Here, high power = Pmax; low power = Pmax/2, and the transition occurs after 80 seconds at high power Pmax. As long as the power enforcement is taking into effective during one 360s/60s time window, the validation test with this defined test sequence 1 is valid, otherwise, select other radio configuration (band/DSI within the same technology group) having lower Plimit for this test. The Test sequence 1 waveform is shown

below:

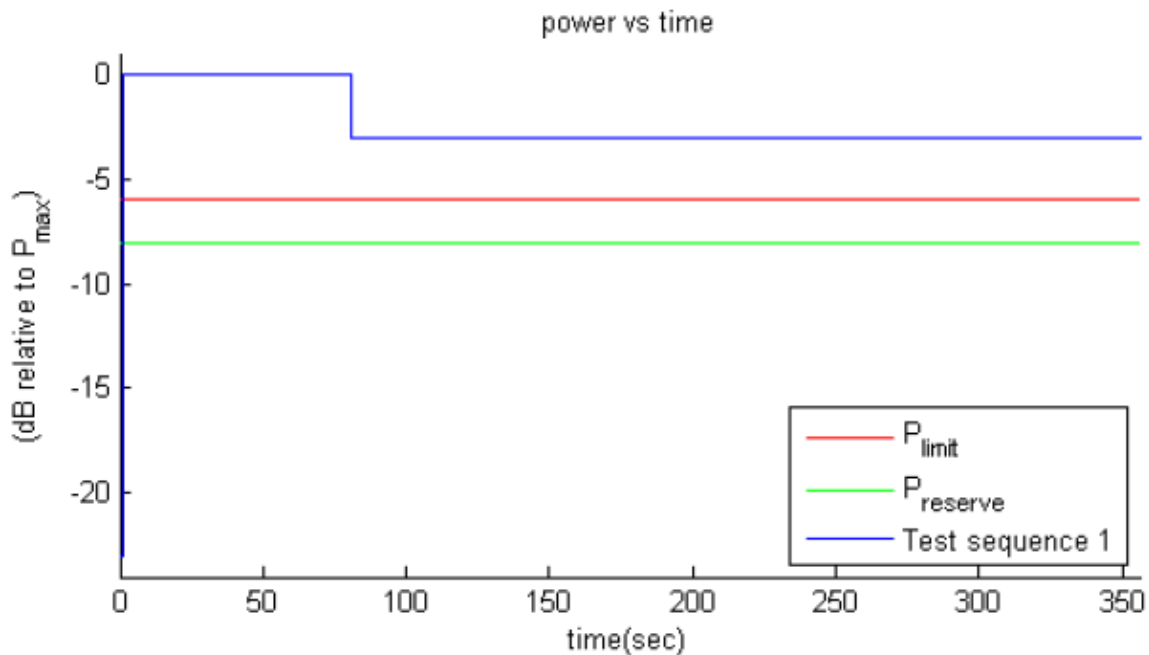

Figure A-1 Test sequence 1 waveform



9. Test Sequence 2 Waveform:

Based on the parameters in A-1, the Test Sequence 2 is generated as described in Table 10-1, which contains two 170 second-long sequences (yellow and green highlighted rows) that are mirrored around the FCCnter row of 20s, resulting in a total duration of 360 seconds:

Table A-1 Test Sequence 2

Time duration (seconds)	dB relative to P_{limit} or $P_{reserve}$
15	$P_{reserve} - 2$
20	P_{limit}
20	$(P_{limit} + P_{max})/2$ averaged in mW and rounded to nearest 0.1 dB step
10	$P_{reserve} - 6$
20	P_{max}
15	P_{limit}
15	$P_{reserve} - 5$
20	P_{max}
10	$P_{reserve} - 3$
15	P_{limit}
10	$P_{reserve} - 4$
20	$(P_{limit} + P_{max})/2$ averaged in mW and rounded to nearest 0.1 dB step
10	$P_{reserve} - 4$
15	P_{limit}
10	$P_{reserve} - 3$
20	P_{max}
15	$P_{reserve} - 5$
15	P_{limit}
20	P_{max}
10	$P_{reserve} - 6$
20	$(P_{limit} + P_{max})/2$ averaged in mW and rounded to nearest 0.1 dB step
20	P_{limit}
15	$P_{reserve} - 2$

The Test Sequence 2 waveform is shown in Figure A-2.

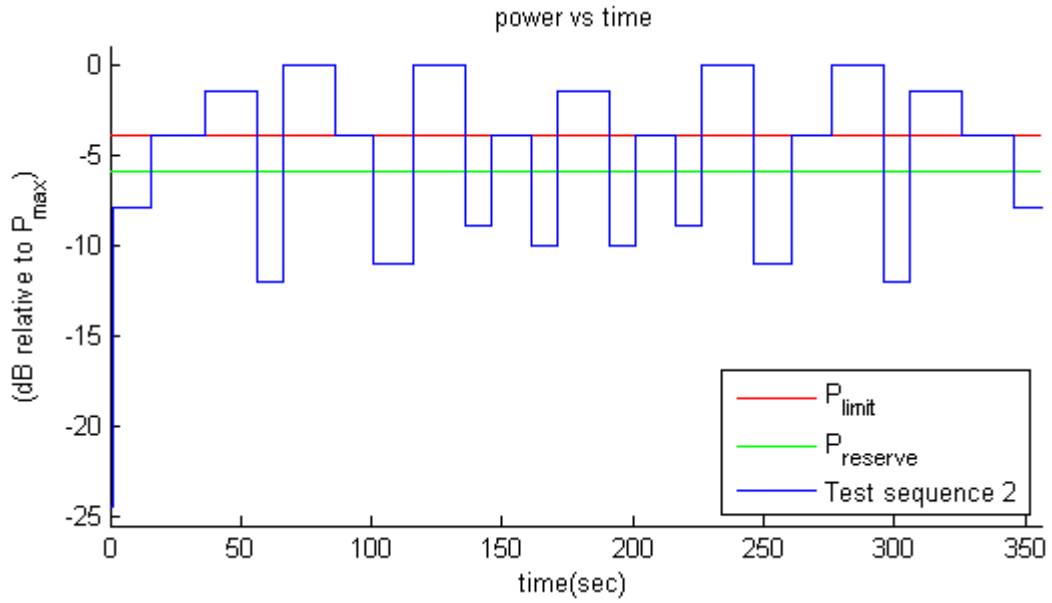

Annex B Test Procedure for Sub6 Simultaneous Transmission Scenarios

Appendix B provides the test procedures for validating Qualcomm Smart Transmit feature for LTE + Sub6 NR non-standalone (NSA) mode transmission scenario, where sub-6GHz LTE link acts as an anchor.

➤ Time-varying Tx power test for sub6 NR in NSA mode

Following Section 6.2 to select test configurations for time-varying test. This test is performed with two pre-defined test sequences (described in Section 6.3) applied to Sub6 NR (with LTE on all-down bits for the entire test after establishing the LTE+Sub6 NR call with the callbox). Following the test procedures described in Section 5 to demonstrate the effectiveness of power limiting enforcement and that the time averaged Tx power of Sub6 NR when converted into 1gSAR values does not exceed the regulatory limit at all times (see Eq. (3a) and (3b)). Sub6 NR response to test sequence 1 and test sequence 2 will be similar to other technologies (say, LTE) shown in Section 6.3 and 7.2.

➤ Switch in SAR exposure between LTE vs. Sub6 NR during transmission

This test is to demonstrate that Smart Transmit feature accurately accounts for switching in exposures among SAR for LTE radio only, SAR from both LTE radio and sub6 NR, and SAR from sub6 NR only scenarios, and ensures total time-averaged RF exposure compliance with FCC limit.

Test procedure:

1. Measure conducted Tx power corresponding to P_{limit} for LTE and sub6 NR in selected band. Test condition to measure conducted P_{limit} is:
 - Establish device in call with the callbox for LTE in desired band. Measure conducted Tx power corresponding to LTE P_{limit} with Smart Transmit enabled and *Reserve_power_margin* set to 0 dB, callbox set to request maximum power.
 - Repeat above step to measure conducted Tx power corresponding to Sub6 NR P_{limit} . If testing LTE+Sub6 NR in non-standalone mode, then establish LTE+Sub6 NR call with callbox and request all down bits for radio1 LTE. In this scenario, with callbox requesting maximum power from Sub6 NR, measured conducted Tx power corresponds to radio 2 P_{limit} (as radio1 LTE is at all-down bits)
2. Set *Reserve_power_margin* to actual (intended) value, with EUT setup for LTE + Sub6 NR call. First, establish LTE connection with the callbox, and then add Sub6 NR connection. As soon as the Sub6 NR connection is established, request all-down bits (or low power) on LTE link and then request UE to transmit at maximum power in Sub6 NR. Continue LTE (all-down bits)+Sub6 NR transmission for more than one time-window duration to test predominantly



Sub6 NR SAR exposure scenario (as SAR exposure is negligible from all-down bits in LTE). After at least one time-window, request LTE to go all-up bits to test LTE SAR and Sub6 NR SAR exposure scenario. After at least one more time-window, drop (or request all-down bits) Sub6 NR transmission to test predominantly LTE SAR exposure scenario. Continue the test for at least one more time-window. Record the conducted Tx powers for both LTE and Sub6 NR for the entire duration of this test.

3. Once the measurement is done, extract instantaneous Tx power versus time for both LTE and Sub6 NR links. Similar to technology/band switch test in Section 4.3.3, convert the conducted Tx power for both these radios into 1g_or_10gSAR value and using corresponding technology/band P_{limit} measured in Step 1, and then perform 100s running average to determine time-averaged 1g_or_10gSAR versus time as illustrated in Figure 4-1. Divide this by regulatory 1g_or_10gSAR limit to obtain normalized time-averaged 1g_or_10gSAR versus time. Note that here it is assumed both radios have Tx frequencies < 3GHz, otherwise, 60s running average should be performed for radios having Tx frequency between 3GHz and 6GHz.
4. Make one plot containing: (a) computed normalized time-averaged 1g_or_10gSAR for LTE versus time determined in Step 3, (b) computed normalized time-averaged 1g_or_10gSAR for Sub6 NR versus time determined in Step 3, (c) computed total normalized time-averaged 1g_or_10gSAR versus time (sum of Steps (4.a) and (4.b)) determined in Step 3, and (d) corresponding normalized regulatory 1g_or_10gSAR_{limit} of 1.0.

The validation criteria is, at all times, the time-averaged 1g_or_10gSAR versus time shall not exceed the regulatory 1g_or_10gSAR_{limit}.



Annex C Test Equipments List

Manufacturer	Name of Equipment	Type/Model	Serial Number	Calibration	
				Last Cal.	Due Date
SPEAG	DOSIMETRIC ASSESSMENT SYSTEM Software	cDASY6	16.0.0.116	NCR	NCR
SPEAG	Dosimetric E-Field Probe	EX3DV4	3823	2023.09.14	2024.09.13
SPEAG	Data Acquisition Electronics	DAE4	480	2023.09.19	2024.09.18
SPEAG	900MHz System Validation Kit	D900V2	1d064	2021.12.17	2024.12.16
SPEAG	2600MHz System Validation Kit	D2600V2	1198	2022.08.17	2025.08.16
SPEAG	Twin-SAM	QD 000 P41 Ax	2020	NCR	NCR
Agilent	Signal Generator	N5182B	MY53050509	2023.09.19	2024.09.18
Agilent	Power Meter	E4416A	MY45102093	2023.09.19	2024.09.18
Anritsu	Power Meter	E4418B	GB43318055	2023.06.21	2024.06.20
Agilent	Dual Directional Coupler	778D	50422	NA	NA
R&S	Network Emulator	CMW500	165755	2024.01.25	2025.01.24
mini-circuits	Amplifier	ZHL-42W+	608501717	NCR	NCR
Agilent	Dual Directional Coupler	778D	50422	NA	NA



Annex D Antenna Information

The antenna location was shown in annex F.

ANT 1:

TRX: GSM 850, WCDMA Band V, LTE Band 5/12/13, 5G NR n5 (NSA)

PRX MIMO: LTE Band 2/4/7/66, 5G NR n2/66

ANT 2: PRX: LTE Band 48, 5G NR n77

ANT3: TRX: GSM 1900, WCDMA Band II/IV, LTE Band 2/4/7/66, 5G NR n2/66 (NSA)

DRX2: LTE Band 48, 5G NR n77

ANT4: TRX0: LTE Band 48, 5G NR n77(NSA)

ANT5: DRX: GSM 850/1900, WCDMA Band II/IV/V, LTE Band 2/4/5/7/12/13/66, 5G NR n2/5/66

ANT 7: ENDC TX: LTE Band 2/66

DRX: LTE Band 2/4/7/66, 5G NR n2/66 (NSA)

ANT 8: TX/RX: WLAN 2.4GHz/5GHz CH0, Bluetooth

RX: GPS

ANT9: TX/RX: WLAN 2.4GHz/5GHz CH1

ANT 10: TRX1(for ENDC): LTE Band 48, 5G NR n77(NSA)

NFC

Module: 5G n260/n261



Annex E General Information

1. Identification of the Responsible Testing Laboratory

Laboratory Name:	Shenzhen Morlab Communications Technology Co., Ltd.
Laboratory Address:	FL.3, Building A, FeiYang Science Park, No.8 LongChang Road, Block 67, BaoAn District, ShenZhen, Guangdong Province, P. R. China
Telephone:	+86 755 36698555
Facsimile:	+86 755 36698525

2. Identification of the Responsible Testing Location

Name:	Shenzhen Morlab Communications Technology Co., Ltd.
Address:	FL.3, Building A, FeiYang Science Park, No.8 LongChang Road, Block 67, BaoAn District, ShenZhen, Guangdong Province, P. R. China

3. Facilities and Accreditations

The FCC designation number is CN1192, the test firm registration number is 226174.



REPORT No.: SZ23040391S03

Annex F Antenna Location & Test Setup Photos

The antenna location & test setup photos was shown in annex F.

Annex G DASY Calibration Certificate

The certification reports of testing equipments will be applied separately.

***** END OF REPORT *****