



TEST REPORT

APPLICANT : Reliance Communications, LLC
PRODUCT NAME : Orbic Speed X 5G
MODEL NAME : R562L5
BRAND NAME : Orbic
FCC ID : 2ABGH-R562L5
STANDARD(S) : 47 CFR Part 15 Subpart E
RECEIPT DATE : 2023-09-26
TEST DATE : 2023-10-07 to 2024-01-16
ISSUE DATE : 2024-04-08



Edited by: Peng Mi
Peng Mi (Rapporteur)
Approved by: Shen Junsheng
Shen Junsheng (Supervisor)

NOTE: This document is issued by Shenzhen Morlab Communications Technology Co., Ltd., the test report shall not be reproduced except in full without prior written permission of the company. The test results apply only to the particular sample(s) tested and to the specific tests carried out which is available on request for validation and information confirmed at our website.





DIRECTORY

- 1. Summary of Test Result4
- 1.1. Testing Applied Standards5
- 1.2. Test Equipment List6
- 1.3. Measurement Uncertainty8
- 1.4. Testing Laboratory8
- 2. General Description9
- 2.1. Information of Applicant and Manufacturer9
- 2.2. Information of EUT9
- 2.3. Channel List of EUT 11
- 2.4. Test Configuration of EUT 12
- 2.5. 802.11ax RU Allocation 13
- 2.6. Test Conditions 14
- 2.7. Test Setup Layout Diagram 14
- 3. Test Results 18
- 3.1. Antenna Requirement 18
- 3.2. Duty Cycle of Test Signal 19
- 3.3. Maximum Conducted Output Power 20
- 3.4. Emission Bandwidth 22
- 3.5. Peak Power Spectral Density 24
- 3.6. Frequency Stability 25
- 3.7. Dynamic Frequency Selection 26
- 3.8. Conducted Emission 31
- 3.9. Restricted Frequency Bands 32
- 3.10. Radiated Emission 34
- Annex A Test Data and Result 36



Change History		
Version	Date	Reason for change
1.0	2024-04-08	First edition

1. Summary of Test Result

No.	Section	Description	Test Date	Test Engineer	Result	Method Determination /Remark
1	15.203	Antenna Requirement	N/A	N/A	PASS	No deviation
2	ANSI C63.10	Duty Cycle of the Test Signal	Oct. 23, 2023	He Yuyang	PASS	No deviation
3	15.407(a)	Maximum Conducted Output Power	Oct. 23, 2023	He Yuyang	PASS	No deviation
4	15.407(a)(e)	Emission Bandwidth	Oct. 23, 2023	He Yuyang	PASS	No deviation
5	15.407(a)	Peak Power Spectral Density	Nov. 02, 2023	He Yuyang	PASS	No deviation
6	15.407(g)	Frequency Stability	Oct. 30, 2023	He Yuyang	PASS	No deviation
7	15.407(h)	DFS	Feb. 24, 2023	He Yuyang	PASS	No deviation
8	15.207	Conducted Emission	Dec. 15, 2023	Wang Deyong	PASS	No deviation
9	15.407(b)	Restricted Frequency Bands	Dec. 12 to 27, 2023	Li Hanbin	PASS	No deviation
10	15.407(b)	Radiated Emission	Dec. 12 to 27, 2023	Li Hanbin	PASS	No deviation

Note 1: All test items are tested and evaluated in the worse mode with reference to output power results.

Note 2: The tests of Conducted Emission and Radiated Emission were performed according to the method of measurements prescribed in ANSI C63.10 2013.

Note 3: These RF tests were performed according to the method of measurements prescribed in KDB 789033 D02 v02r01.

Note 4: These RF tests were performed according to the method of measurements prescribed in KDB 905462 D02 UNII DFS Compliance Procedures New Rules v02.

Note 5: Additions to, deviation, or exclusions from the method shall be judged in the "method determination" column of add, deviate or exclude from the specific method shall be explained in the "Remark" of the above table.



Note 6: When the test result is a critical value, we will use the measurement uncertainty give the judgment result based on the 95% confidence intervals.

1.1. Testing Applied Standards

According to the specifications of the manufacturer, the EUT must comply with the requirements of the following standards:

- 47 CFR Part 15 Subpart E Radio Frequency Devices



1.2. Test Equipment List

1.2.1 Conducted Test Equipments

Equipment Name	Serial No.	Type	Manufacturer	Cal. Date	Due Date
EXA Signal Analyzer	MY5347083 6	N9010A	Agilent	2023.02.27	2024.02.26
USB Wideband Power Sensor	MY5418000 8	U2021XA	Agilent	2022.10.11	2023.10.10
				2023.10.17	2024.10.16
Temperature Chamber	12108015	DTL-003S101	YOMA	2023.09.19	2024.09.18
RF Cable (30MHz-26GHz)	CB01	RF01	Morlab	N/A	N/A
Coaxial Cable	CB02	RF02	Morlab	N/A	N/A
SMA Connector	CN01	RF03	HUBER-SUHNER	N/A	N/A
Attenuator	MTJ6004-10	10dB	MTJ cooperation	N/A	N/A

1.2.2 Conducted Emission Test Equipments

Equipment Name	Serial No.	Type	Manufacturer	Cal. Date	Due Date
Receiver	MY5640009 3	N9038A	KEYSIGHT	2023.02.09	2024.02.08
LISN	8127449	NSLK 8127	Schwarzbeck	2023.02.21	2024.02.20
Pulse Limiter (10dB)	VTSD 9561 F-B #206	VTSD 9561-F	Schwarzbeck	2023.06.27	2024.06.26
RF Coaxial Cable (DC-100MHz)	BNC	MRE04	Qualwave	N/A	N/A

1.2.3 List of Software Used

Description	Manufacturer	Software Version
Test System	MaiWei	2.0.0.0
Morlab EMCR	Morlab	V1.2
TS+ -[JS32-CE]	Tonscend	V2.5.0.0

**1.2.4 Radiated Test Equipments**

Equipment Name	Serial No.	Type	Manufacturer	Cal. Date	Due Date
Receiver	MY54130016	N9038A	Agilent	2023.06.21	2024.06.20
Test Antenna - Bi-Log	9163-519	VULB 9163	Schwarzbeck	2023.07.01	2024.06.30
Test Antenna - Loop	1519-022	FMZB1519	Schwarzbeck	2023.06.26	2024.06.25
Test Antenna – Horn	01774	BBHA 9120D	Schwarzbeck	2023.07.01	2024.06.30
Test Antenna – Horn	BBHA9170 #773	BBHA9170	Schwarzbeck	2023.07.01	2024.06.30
Preamplifier (10MHz-6GHz)	46732	S10M100L38 02	LUCIX CORP.	2023.06.27	2024.06.26
Preamplifier (2GHz-18GHz)	61171/61172	S020180L32 03	LUCIX CORP.	2023.06.27	2024.06.26
Preamplifier (18GHz-40GHz)	DS77209	DCLNA0118-40C-S	Decentest	2023.07.04	2024.07.03
RF Coaxial Cable (DC-18GHz)	MRE001	PE330	Pasternack	2023.06.27	2024.06.26
RF Coaxial Cable (DC-18GHz)	MRE002	CLU18	Pasternack	2023.06.27	2024.06.26
RF Coaxial Cable (DC-18GHz)	MRE003	CLU18	Pasternack	2023.06.27	2024.06.26
RF Coaxial Cable (DC-40GHz)	22290045	QA360-40-KK-0.5	Qualwave	2023.07.04	2024.07.03
RF Coaxial Cable (DC-40GHz)	22290046	QA360-40-KKF-2	Qualwave	2023.07.04	2024.07.03
RF Coaxial Cable (DC-18GHz)	22120181	QA500-18-NN-5	Qualwave	2023.07.04	2024.07.03
Notch Filter	N/A	WRCG-5150-5350	Wainwright	N/A	N/A
Notch Filter	N/A	WRCG-5470-5725	Wainwright	N/A	N/A
Notch Filter	N/A	WRCG-5725-5850	Wainwright	N/A	N/A
Anechoic Chamber	N/A	9m*6m*6m	CRT	2022.05.10	2025.05.09



1.3. Measurement Uncertainty

Test Items	Uncertainty	Remark
Peak Output Power	±2.22dB	Confidence levels of 95%
Power Spectral Density	±2.22dB	Confidence levels of 95%
Bandwidth	±5%	Confidence levels of 95%
Restricted Frequency Bands	±5%	Confidence levels of 95%
Radiated Emission	±2.95dB	Confidence levels of 95%
Conducted Emission	±2.44dB	Confidence levels of 95%

1.4. Testing Laboratory

Laboratory Name	Shenzhen Morlab Communications Technology Co., Ltd.
Laboratory Address	FL.3, Building A, FeiYang Science Park, No.8 LongChang Road, Block 67, BaoAn District, ShenZhen, GuangDong Province, P. R. China
Telephone	+86 755 36698555
Facsimile	+86 755 36698525
FCC Designation Number	CN1192
FCC Test Firm Registration Number	226174



2. General Description

2.1. Information of Applicant and Manufacturer

Applicant	Reliance Communications, LLC
Applicant Address	555 Wireless Blvd. Hauppauge, NY 11788, USA
Manufacturer	MeiG Smart Technology Co., Ltd
Manufacturer Address	2nd Floor,Office Building,No.5 Lingxia Road,Fenghuang,Fuyong Street,Bao'an District,Shenzhen

2.2. Information of EUT

Product Name:	Orbic Speed X 5G	
Sample No.:	4#	
Hardware Version:	SPEEDVZ_V1.02_PCB	
Software Version:	R562L5_8.222.41_EQ103	
Modulation Technology:	OFDM, OFDMA	
Modulation Mode:	802.11a, 802.11n (HT20), 802.11n (HT40) 802.11ac (VHT20), 802.11ac (VHT40), 802.11ac (VHT80), 802.11ac (VHT160) 802.11ax (HEW20), 802.11ax (HEW40), 802.11ax (HEW80), 802.11ax (HEW160)	
Operating Frequency Range:	5180MHz-5240MHz; 5260MHz-5320MHz; 5500MHz-5720MHz; 5745MHz-5825MHz	
Antenna Type:	PIFA Antenna	
Antenna Gain:	ANT 1: 2.11dBi; ANT 2: 2.23dBi	
Directional Gain:	5.18dBi _{Note 2}	
Accessory Information:	Battery	
	Brand Name:	Orbic
	Model No.:	R562L5
	Serial No.:	N/A
	Rated Capacity:	5000mAh
	Rated Voltage:	3.85V
	Charge Limit:	4.4V
Manufacturer:	Shenzhen Aerospace Electronic Co.,Ltd	



Accessory Information:	AC Adapter	
	Brand Name:	Orbic
	Model No.:	OACH023US1
	Serial No.:	N/A
	Rated Output:	5V=3A or 9V=2A or 12V=1.5A
	Rated Input:	100-240V~50/60Hz, 0.5A
	Manufacturer 1:	WATAI ELECTRONICS PRIVATE LIMITED
	Manufacturer 2:	KANGYIN ELECTRONIC TECHNOLOGY CO.,LTD
	USB Cable	
	Model No.:	OAUC023US1
	Manufacturer:	KANGYIN ELECTRONIC TECHNOLOGY CO.,LTD

Note 1: The EUT supports a MIMO function. Physically, the EUT provides two completed transmitters and two receivers for 802.11n, 802.11ac and 802.11ax modulation mode.

Modulation Mode:	TX Function
802.11a	1TX
802.11n	2TX
802.11ac	2TX
802.11ax	2TX

Note 2: According to KDB 662911 D01, the directional gain = $G_{ANT} + 10\log(N_{ANT})$ dBi, where G_{ANT} is the maximum antenna gain in dBi, N_{ANT} is the number of outputs.

Note 3: All radiation test items for 802.11n, 802.11ac and 802.11ax modulation mode operate at MIMO mode during the test. Other modulation mode operate at SISO mode, both of the two antennas were tested separately, we only recorded the worst test result(ANT 1) in this report.

Note 4: We use the dedicated software to control the EUT continuous transmission.

Note 5: For a more detailed description, please refer to Specification or User’s Manual supplied by the applicant and/or manufacturer.

2.3. Channel List of EUT

(U-NII-1) 5180MHz-5240MHz				
Bandwidth	Channel	Frequency (MHz)	Channel	Frequency (MHz)
20MHz	36	5180	40	5200
	44	5220	48	5240
40MHz	38	5190	46	5230
80MHz	42	5210		
(U-NII-2A) 5260MHz-5320MHz				
Bandwidth	Channel	Frequency (MHz)	Channel	Frequency (MHz)
20MHz	52	5260	56	5280
	60	5300	64	5320
40MHz	54	5270	62	5310
80MHz	58	5290		
160MHz	40	5250		
(U-NII-2C) 5500MHz-5720MHz				
Bandwidth	Channel	Frequency (MHz)	Channel	Frequency (MHz)
20MHz	100	5500	105	5520
			112	5560
			120	5600
			128	5640
			136	5680
			144	5720
40MHz	102	5510	110	5550
			126	5630
			142	5710
80MHz	106	5530	122	5610
	138	5690		
160MHz	114	5570		
(U-NII-3) 5745MHz-5825MHz				
Bandwidth	Channel	Frequency (MHz)	Channel	Frequency (MHz)
20MHz	149	5745	153	5765
	157	5785	161	5805
	165	5825		
40MHz	151	5775	159	5795
80MHz	155	5775		

Note 1: The black bold channels were selected for test.



2.4. Test Configuration of EUT

2.4.1. Modulation Type and Data Rate of EUT

Mode	Bandwidth (MHz)	Modulation Technology	Modulation Type	Data Rate	RU Size
802.11a	20	OFDM	BPSK	6/9/12/18/24/36/48/54Mbps	N/A
			QPSK		
			16QAM		
			64QAM		
802.11n	20/40 (HT20/40)	OFDM	BPSK	MCS0~MCS7	N/A
			QPSK		
			16QAM		
			64QAM		
802.11ac	20/40/80/160 (VHT20/40/80/160)	OFDM	BPSK	MCS0~MCS9	N/A
			QPSK		
			16QAM		
			64QAM		
			256QAM		
802.11ax	20/40/80/160 (HEW20/40/80/160)	OFDM/ OFDMA	BPSK	MCS0~MCS11	26/52/106/242/ 484/996
			QPSK		
			16QAM		
			64QAM		
			256QAM		
			1024QAM		

Note1: The worst-case mode (bold face) in all data rates has been determined during the pre-scan, only the test data of the worst-case were recorded in this report.



2.5.802.11ax RU Allocation

Bandwidth (MHz)	RU Size		User	RU Offset	
	Full (Tone)	Partial			
		(Tone)			Bandwidth (MHz)
20	242	26	2	9	@0/1/2/3/4/5/6/7/8
		52	4	4	@37/38/39/40
		106	8	2	@53/54
		242	20	1	@61
40	484	26	2	18	@0/1/2.....15/16/17
		52	4	8	@37/38/39/40/41/42/43/44
		106	8	4	@53/54/55/56
		242	20	2	@61/62
		484	40	1	@65
80	996	26	2	37	@0/1/2.....35/36
		52	4	16	@37/38/39.....50/51/52
		106	8	8	@53/54/55/56/57/58/59/60
		242	20	4	@61/62/63/64
		484	40	2	@65/66
		996	80	1	@67
160	996x2	26	2	74	@0/1/2.....35/36 S0/S1.....S35/S36
		52	4	32	@37/38/39.....50/51/52 S37/S38.....S51/S52
		106	8	16	@53/54/55/56/57/58/59/60 S53//S54.....S59/S60
		242	20	8	@61/62/63/64 S61/S62/S63/S64
		484	40	4	@65/66/S65/S66
		996	80	2	@67/S67
		996x2	160	1	@S68

2.6. Test Conditions

Temperature (°C)	15-35
Relative Humidity (%)	30-60
Atmospheric Pressure (kPa)	86-106

2.7. Test Setup Layout Diagram

2.7.1. Conducted Measurement

For power item that BW below 80MHz system:

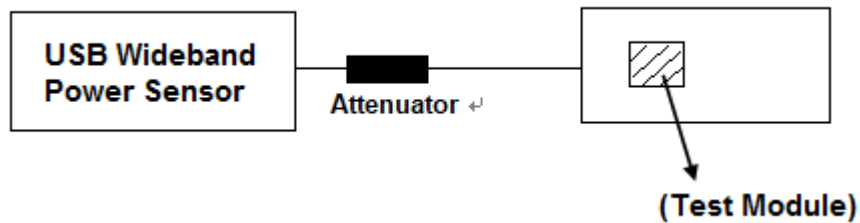

For power item that BW equal or above 80MHz and other items:

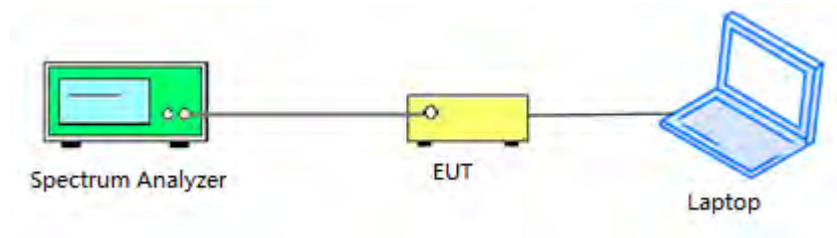

2.7.2. Conducted Emission Measurement

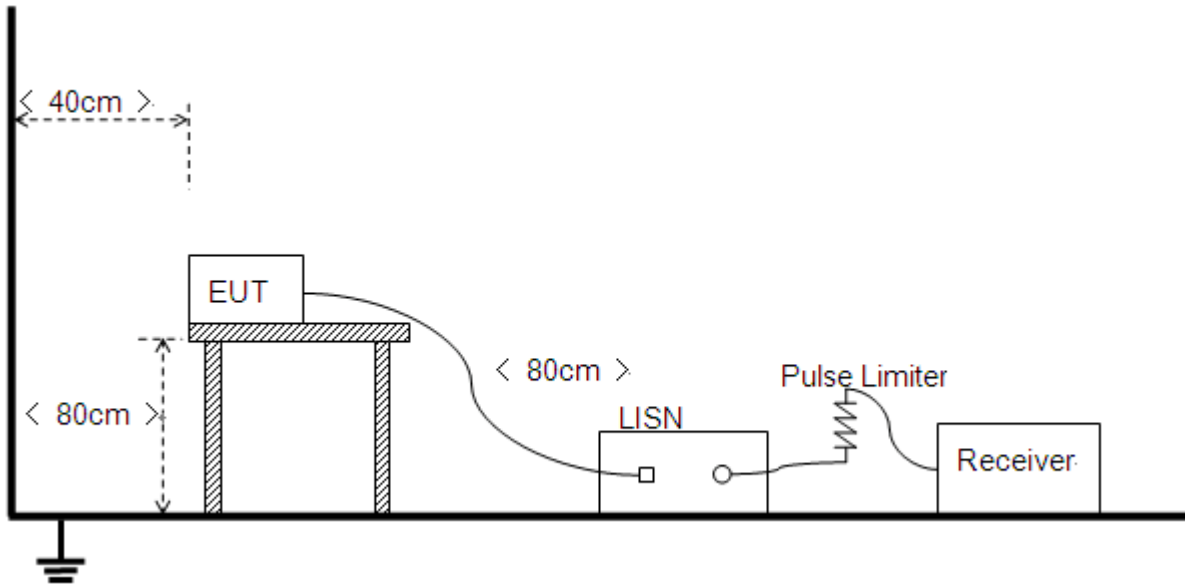

2.7.3. Radiation Measurement

1) For radiated emissions from 9kHz to 30MHz

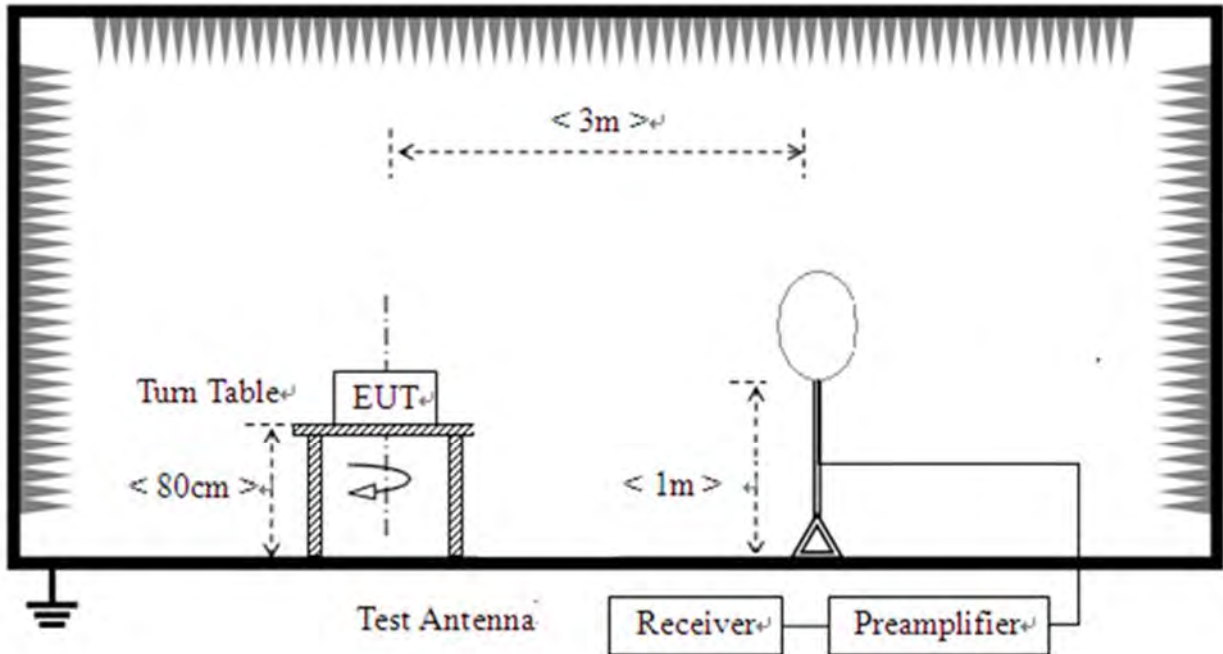

2) For radiated emissions from 30MHz to 1GHz

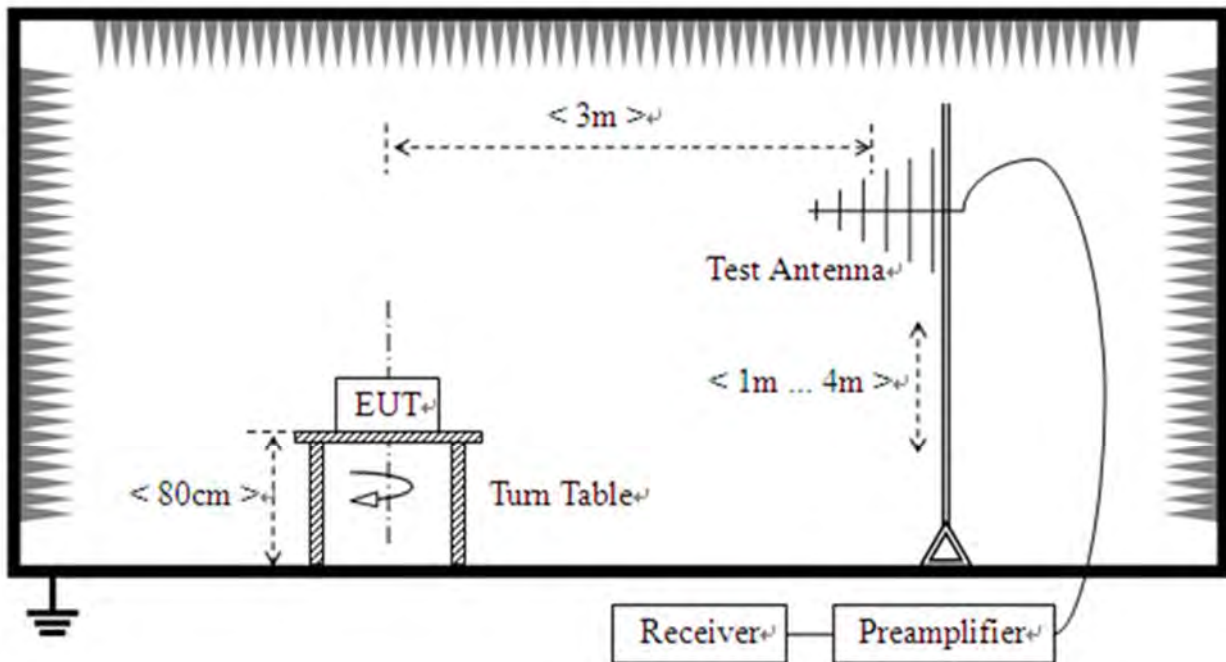

3) For radiated emissions above 1GHz

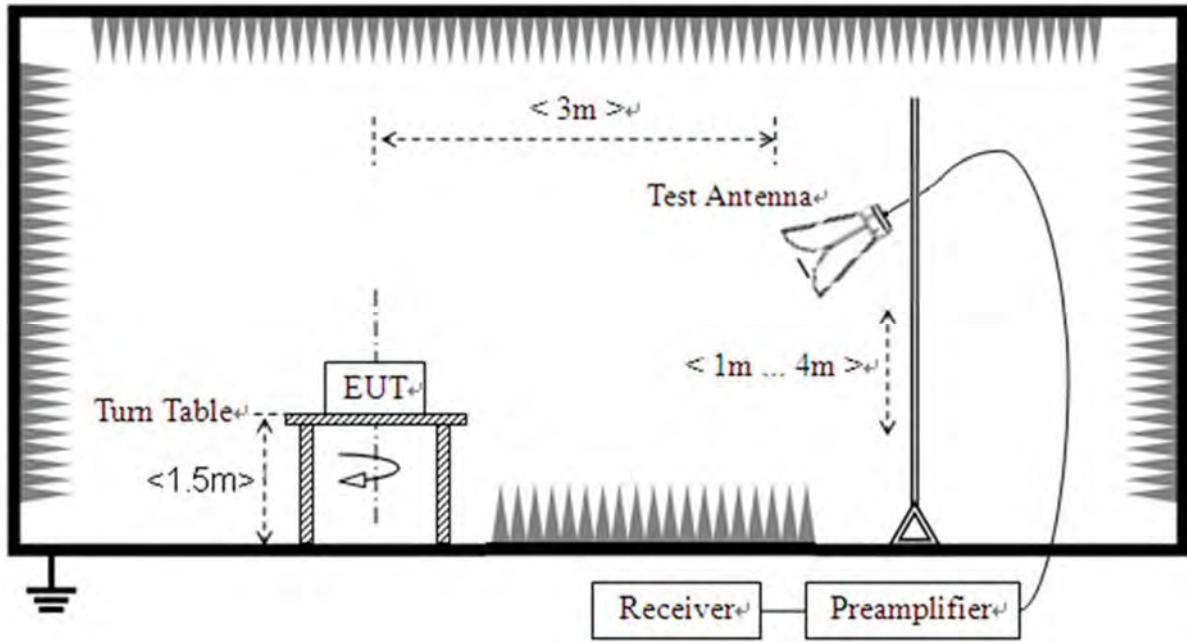



3. Test Results

3.1. Antenna Requirement

3.1.1. Requirement

According to FCC 15.203, an intentional radiator shall be designed to ensure that no antenna other than that furnished by the responsible party shall be used with the device. The use of a permanently attached antenna or of an antenna that uses a unique coupling to the intentional radiator shall be considered sufficient to comply with the provisions of this section.

3.1.2. Test Result

Inside of the EUT has a PIFA antenna coupled with the metal shrapnel. Please refer to the EUT internal photos.



3.2. Duty Cycle of Test Signal

3.2.1. Requirement

Preferably, all measurements of maximum conducted (average) output power will be performed with the EUT transmitting continuously (i.e., with a duty cycle of greater than or equal to 98%). When continuous operation cannot be realized, then the use of sweep triggering/signal gating techniques can be used to ensure that measurements are made only during transmissions at the maximum power control level. Such sweep triggering/signal gating techniques will require knowledge of the minimum transmission duration (T) over which the transmitter is on and is transmitting at its maximum power control level for the tested mode of operation. Sweep triggering/signal gating techniques can then be used if the measurement/sweep time of the analyzer can be set such that it does not exceed T at any time that data are being acquired (i.e., no transmitter OFF-time is to be considered).

When continuous transmission cannot be achieved and sweep triggering/signal gating cannot be implemented, alternative procedures are provided that can be used to measure the average power; however, they will require an additional measurement of the transmitter duty cycle (D). Within this sub clause, the duty cycle refers to the fraction of time over which the transmitter is ON and is transmitting at its maximum power control level. The duty cycle is considered to be constant if variations are less than $\pm 2\%$; otherwise, the duty cycle is considered to be non constant.

3.2.2. Test Result

Refer to Annex A.1 in this report.



3.3. Maximum Conducted Output Power

3.3.1. Requirement

(1) For client devices in the 5.15-5.25 GHz band, the maximum conducted output power over the frequency band of operation shall not exceed 250mW provided the maximum antenna gain does not exceed 6dBi.

(2) For the 5.25-5.35 GHz and 5.47-5.725 GHz bands, the maximum conducted output power over the frequency bands of operation shall not exceed the lesser of 250mW or $11\text{dBm} + 10 \log B$, where B is the 26 dB emission bandwidth in megahertz.

(3) For the band 5.725-5.85 GHz, the maximum conducted output power over the frequency band of operation shall not exceed 1 W.

If transmitting antennas of directional gain greater than 6dBi are used, the maximum conducted output power shall be reduced by the amount in dB that the directional gain of the antenna exceeds 6dBi.

(4) According to KDB662911D01 Measure-and-sum technique, the conducted emission level (e.g., transmit power or power in specified bandwidth) is measured at each antenna port. The measured results at the various antenna ports are then summed mathematically to determine the total emission level from the device. Summing is performed in units that are directly proportional to power.

(5) According to KDB 662911 D01, the directional gain = $G_{\text{ANT}} + 10\log(N_{\text{ANT}})\text{dBi}$, where G_{ANT} is the antenna gain in dBi, N_{ANT} is the number of outputs.

3.3.2. Test Procedures

The EUT (Equipment under the test) which is coupled to the USB Wideband Power Sensor; the RF load attached to the EUT antenna terminal is 50Ohm; the path loss as the factor is calibrated to correct the reading, all test result in USB Wideband Power Sensor.

For ac (VHT80) mode power

The EUT (Equipment under the test) is coupled to the Spectrum analyzer; the RF load attached to the EUT antenna terminal is 50Ohm; the path loss as the factor is calibrated to correct the reading, all test result in Spectrum analyzer.



3.3.3. Test Setup Layout

Refer to chapter 2.6.1 in this report.

3.3.4. Test Result

Refer to Annex A.2 in this report.



3.4. Emission Bandwidth

3.4.1. Requirement

For purposes of this subpart the emission bandwidth shall be determined by measuring the width of the signal between two points, one below the carrier center frequency and one above the carrier center frequency, that are 26 dB down relative to the maximum level of the modulated carrier. Determination of the emissions bandwidth is based on the use of measurement instrumentation employing a peak detector function with an instrument resolution bandwidth approximately equal to 1.0 percent of the emission bandwidth of the device under measurement. Within the 5.725-5.85 GHz band, the minimum 6 dB bandwidth of U-NII devices shall be at least 500 kHz.

3.4.1. Test Procedures

1. KDB 789033 Section C) 1) Emission Bandwidth was used in order to prove compliance

a) Set RBW = approximately 1% of the emission bandwidth.

b) Set VBW > RBW.

c) Detector = Peak.

d) Trace mode = max hold.

e) Measure the maximum width of the emission that is 26 dB down from the peak of the emission. Compare this with the RBW setting of the analyzer. Readjust RBW and repeat measurement as needed until the RBW/EBW ratio is approximately 1%.

2. KDB 789033 Section C) 2) minimum emission bandwidth for the band 5.725-5.85GHz was used in order to prove compliance.

Section 15.407(e) specifies the minimum 6 dB emission bandwidth of at least 500 KHz for the band 5.715-5.85 GHz. The following procedure shall be used for measuring this bandwidth:

a) Set RBW = 100 kHz.

b) Set video bandwidth (VBW) $\geq 3 \times$ RBW.

c) Detector = Peak.

d) Trace mode = max hold.

e) Sweep = auto couple.

f) Allow the trace to stabilize.

g) Measure the maximum width of the emission that is constrained by the frequencies associated with the two outermost amplitude points (upper and lower frequencies) that are attenuated by 6 dB relative to the maximum level measured in the fundamental emission.



3.4.2. Test Setup Layout

Refer to chapter 2.6.1 in this report.

3.4.3. Test Result

Refer to Annex A.3 in this report.



3.5. Peak Power Spectral Density

3.5.1. Requirement

(1) For client devices in the 5.15-5.25 GHz band, the maximum power spectral density shall not exceed 11dBm in any 1 megahertz band.

(2) For the 5.25-5.35 GHz and 5.47-5.725 GHz bands, the maximum power spectral density shall not exceed 11dBm in any 1 megahertz band.

(3) For the band 5.725-5.85 GHz, the maximum power spectral density shall not exceed 30dBm in any 500kHz band.

If transmitting antennas of directional gain greater than 6dBi are used, the maximum power spectral density shall be reduced by the amount in dB that the directional gain of the antenna exceeds 6dBi.

(4) According to KDB662911D01 Measure-and-sum technique, the conducted emission level (e.g., transmit power or power in specified bandwidth) is measured at each antenna port. The measured results at the various antenna ports are then summed mathematically to determine the total emission level from the device. Summing is performed in units that are directly proportional to power.

(5) According to KDB 662911 D01, the directional gain = $G_{ANT} + 10\log(N_{ANT})$ dBi, where G_{ANT} is the antenna gain in dBi, N_{ANT} is the number of outputs.

3.5.2. Test Procedures

KDB 789033 Section F) Maximum Power Spectral Density (PSD) Method SA-3 was used in order to prove compliance

- 1) Set span to encompass the entire 26-dB emission bandwidth
 - 2) Set RBW = 1MHz. Set VBW \geq 3MHz
 - 3) Number of points in sweep \geq 2 Span / RBW. Sweep time = auto
 - 4) Detector = Average
 - 5) Trace mode=Max hold
- Record the max value

3.5.3. Test Setup Layout

Refer to chapter 2.6.1 in this report.

3.5.4. Test Result

Refer to Annex A.4 in this report.



3.6. Frequency Stability

3.6.1. Requirement

Manufacturers of U-NII devices are responsible for ensuring frequency stability such that an emission is maintained within the band of operation under all conditions of normal operation as specified in the user's manual.

3.6.2. Test Procedures

The EUT was placed inside of an environmental chamber as the temperature in the chamber was varied between 5°C to 40°C. The temperature was incremented by 10° intervals and the unit was allowed to stabilize at each temperature before each measurement. The center frequency of the transmitting channel was evaluated at each temperature and the frequency deviation from the channel's center frequency was recorded. Data for the worst case channel is shown below.

3.6.3. Test Result

Refer to Annex A.5 in this report.



3.7. Dynamic Frequency Selection

3.7.1. Requirement

According to FCC section 15.407(h), (1) Transmit power control (TPC). U-NII devices operating in the 5.25-5.35 GHz band and the 5.47-5.725 GHz band shall employ a TPC mechanism. The U-NII device is required to have the capability to operate at least 6 dB below the mean EIRP value of 30 dBm. A TPC mechanism is not required for systems with an e.i.r.p. of less than 500 mW. (2) Radar Detection Function of Dynamic Frequency Selection (DFS). U-NII devices operating with any part of its 26 dB emission bandwidth in the 5.25-5.35 GHz and 5.47-5.725 GHz bands shall employ a DFS radar detection mechanism to detect the presence of radar systems and to avoid co-channel operation with radar systems. Operators shall only use equipment with a DFS mechanism that is turned on when operating in these bands. The device must sense for radar signals at 100 percent of its emission bandwidth. The minimum DFS detection threshold for devices with a maximum e.i.r.p. of 200 mW to 1 W is -64 dBm. For devices that operate with less than 200 mW e.i.r.p. and a power spectral density of less than 10 dBm in a 1 MHz band, the minimum detection threshold is -62 dBm. The detection threshold is the received power averaged over 1 microsecond referenced to a 0 dBi antenna. For the initial channel setting, the manufacturers shall be permitted to provide for either random channel selection or manual channel selection.

A U-NII network will employ a DFS function to detect signals from radar systems and to avoid co-channel operation with these systems. This applies to the 5250-5350 MHz and/or 5470-5725 MHz bands.1

Within the context of the operation of the DFS function, a U-NII device will operate in either Master Mode or Client Mode. U-NII devices operating in Client Mode can only operate in a network controlled by a U-NII device operating in Master Mode.2

Tables 1 and 2 shown below summarize the information contained in sections 5.1.1 and 5.1.2.

Table 1: Applicability of DFS Requirements Prior to Use of a Channel

Requirement	Operational Mode		
	Master	Client Without Radar Detection	Client With Radar Detection
Non-Occupancy Period	Yes	Not required	Yes
DFS Detection Threshold	Yes	Not required	Yes
Channel Availability Check Time	Yes	Not required	Not required
U-NII Detection Bandwidth	Yes	Not required	Yes

Table 2: Applicability of DFS requirements during normal operation

Requirement	Operational Mode
-------------	------------------



	Master	Client Without Radar Detection
DFS Detection Threshold	Yes	Not required
Channel Closing Transmission Time	Yes	Yes
Channel Move Time	Yes	Yes
U-NII Detection Bandwidth	Yes	Not required

Additional requirements for devices with multiple bandwidth modes	Master Device or Client with Radar Detection	Client Without Radar Detection
U-NII Detection Bandwidth and Statistical Performance Check	All BW modes must be tested	Not required
Channel Move Time and Channel Closing Transmission Time	Test using widest BW mode available	Test using the widest BW mode available for the link
All other tests	Any single BW mode	Not required
Note: Frequencies selected for statistical performance check (Section 7.8.4) should include several frequencies within the radar detection bandwidth and frequencies near the edge of the radar detection bandwidth. For 802.11 devices it is suggested to select frequencies in each of the bonded 20 MHz channels and the channel center frequency.		

The operational behavior and individual DFS requirements that are associated with these modes are as follows:

Master Devices

- a) The Master Device will use DFS in order to detect Radar Waveforms with received signal strength above the DFS Detection Threshold in the 5250 – 5350 MHz and 5470 – 5725 MHz bands. DFS is not required in the 5150 – 5250 MHz or 5725 – 5825 MHz bands.
- b) Before initiating a network on a Channel, the Master Device will perform a Channel Availability Check for specified time duration (Channel Availability Check Time) to ensure that there is no radar system operating on the Channel, using DFS described under subsection a) above.
- c) The Master Device initiates a U-NII network by transmitting control signals that will enable other U-NII devices to Associate with the Master Device.
- d) During normal operation, the Master Device will monitor the Channel (In-Service Monitoring) to ensure that there is no radar system operating on the Channel, using DFS described under a).
- e) If the Master Device has detected a Radar Waveform during In-Service Monitoring as described under d), the Operating Channel of the U-NII network is no longer an Available Channel. The Master Device will instruct all associated Client Device(s) to stop transmitting on this Channel within the Channel Move Time. The transmissions during the Channel Move Time will be limited to the Channel Closing Transmission Time.
- f) Once the Master Device has detected a Radar Waveform it will not utilize the Channel for the duration of the Non-Occupancy Period. 3.



g) If the Master Device delegates the In-Service Monitoring to a Client Device, then the combination will be tested to the requirements described under d) through f) above.

Client Devices

a) A Client Device will not transmit before having received appropriate control signals from a Master Device.

b) A Client Device will stop all its transmissions whenever instructed by a Master Device to which it is associated and will meet the Channel Move Time and Channel Closing Transmission Time requirements. The Client Device will not resume any transmissions until it has again received control signals from a Master Device.

c) If a Client Device is performing In-Service Monitoring and detects a Radar Waveform above the DFS Detection Threshold, it will inform the Master Device. This is equivalent to the Master Device detecting the Radar Waveform and d) through f) of section 5.1.1 apply.

d) Irrespective of Client Device or Master Device detection the Channel Move Time and Channel Closing Transmission Time requirements remain the same.

e) The client test frequency must be monitored to ensure no transmission of any type has occurred for 30 minutes. Note: If the client moves with the master, the device is considered compliant if nothing appears in the client non-occupancy period test. For devices that shut down (rather than moving channels), no beacons should appear.

DFS Detection Thresholds

Table 3 below provides the DFS Detection Thresholds for Master Devices as well as Client Devices incorporating In-Service Monitoring.

Table 3: DFS Detection Thresholds for Master Devices and Client Devices with Radar Detection

Maximum Transmit Power	Value (See Notes 1, 2, and 3)
EIRP \geq 200 mill watt	-64 dBm
EIRP < 200 mill watt and power spectral density < 10 dBm/MHz	-62 dBm
EIRP < 200 mill watt that do not meet the power spectral density requirement	-64 dBm

Note 1: This is the level at the input of the receiver assuming a 0 dBi receive antenna.
 Note 2: Throughout these test procedures an additional 1 dB has been added to the amplitude of the test transmission waveforms to account for variations in measurement equipment. This will ensure that the test signal is at or above the detection threshold level to trigger a DFS response.
 Note3: EIRP is based on the highest antenna gain. For MIMO devices refer to KDB Publication 662911 D01.

Response Requirements

Table 4 provides the response requirements for Master and Client Devices incorporating DFS.

Table 4: DFS Response Requirement Values

Parameter	Value
Non-occupancy period	Minimum 30 minutes
Channel Availability Check Time	60 seconds
Channel Move Time	10 seconds See Note 1.
Channel Closing Transmission Time	200 milliseconds + an aggregate of 60 milliseconds over remaining 10 second period. See Notes 1 and 2.
U-NII Detection Bandwidth	Minimum 100% of the U-NII 99% transmission power bandwidth. See Note 3.

Note 1: Channel Move Time and the Channel Closing Transmission Time should be performed with Radar Type 0. The measurement timing begins at the end of the Radar Type 0 burst.

Note 2: The Channel Closing Transmission Time is comprised of 200 milliseconds starting at the beginning of the Channel Move Time plus any additional intermittent control signals required to facilitate a Channel move (an aggregate of 60 milliseconds) during the remainder of the 10 second period. The aggregate duration of control signals will not count quiet periods in between transmissions.

Note 3: During the U-NII Detection Bandwidth detection test, radar type 0 should be used. For each frequency step the minimum percentage of detection is 90 percent. Measurements are performed with no data traffic.

3.7.2. Test Description

According to Section 7.2 of KDB 905462 D02 V01R01

1. Setup for Master with injection at the Master

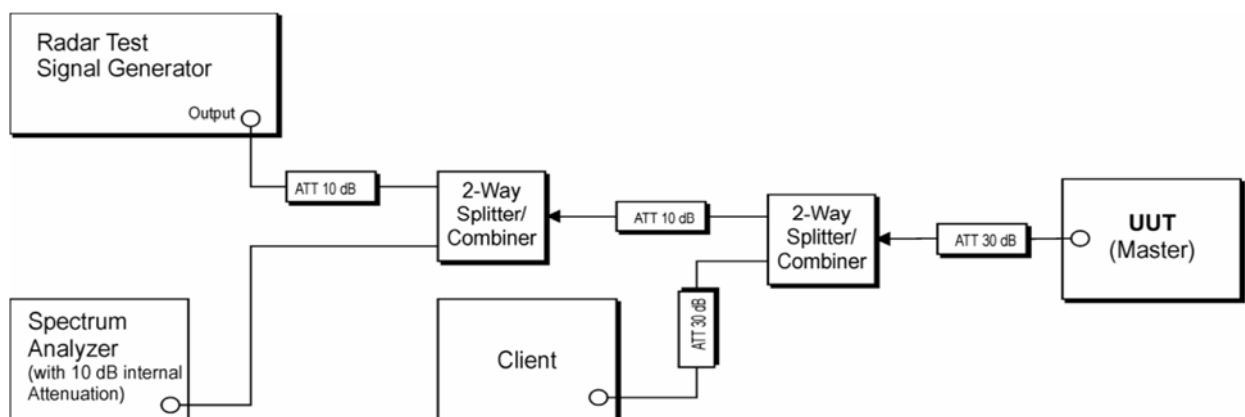

(Example Conducted Setup where UUT is a Master and Radar Test Waveforms are injected into the Master)

2. Setup for Client with injection at the Master

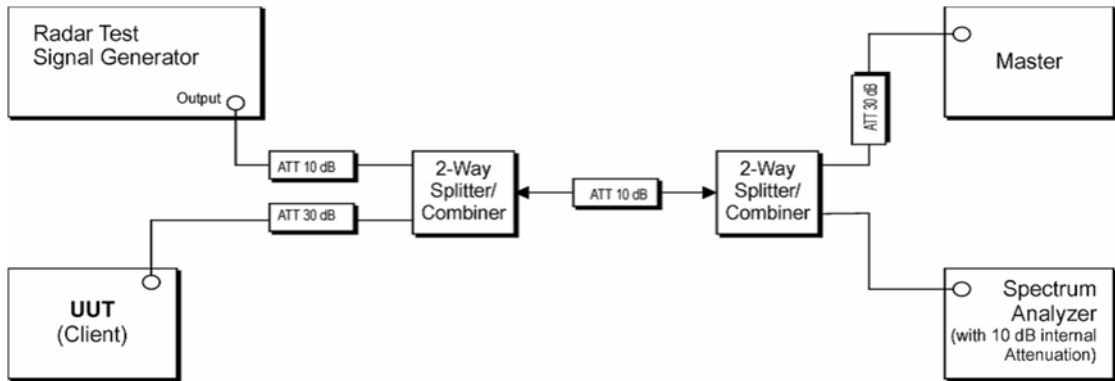

(Example Conducted Setup where UUT is a Client and Radar Test Waveforms are injected into the Master)

3. Setup for Client with injection at the Client

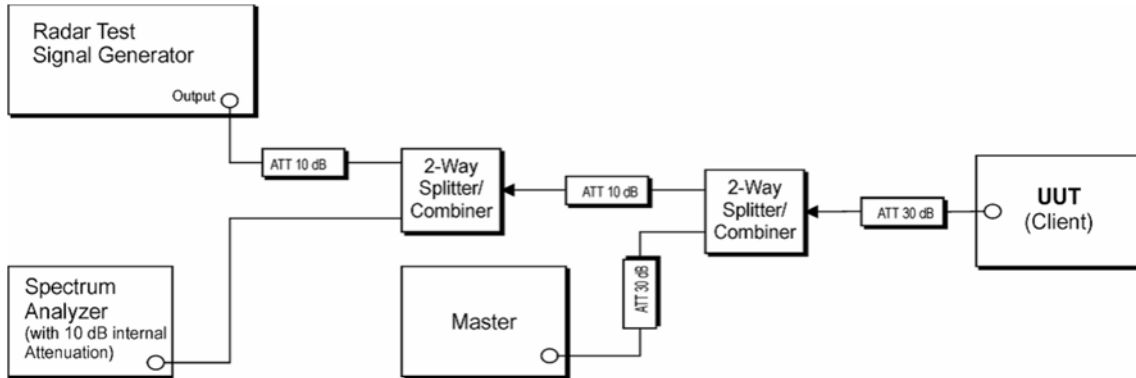

(Example Conducted Setup where UUT is a Client and Radar Test Waveforms are injected into the Client)

3.7.3. Information of Companion Device

Product Name:	Router
Manufacturer:	ASUS
FCC ID:	MSQ-RTAXJF00
Device Type:	Master Device
Operating Mode:	Master Mode
Serial No:	M3IAJF201046
Antenna Gain:	2.0dBi

3.7.4. Test Result

Refer to Annex A.6 in this report.



3.8. Conducted Emission

3.8.1. Requirement

According to FCC section 15.207, for an intentional radiator that is designed to be connected to the public utility (AC) power line, the radio frequency voltage that is conducted back onto the AC power line on any frequency within the band 150kHz to 30MHz shall not exceed the limits in the following table, as measured using a 50μH/50Ω line impedance stabilization network (LISN).

Frequency Range (MHz)	Conducted Limit (dBμV)	
	Quai-peak	Average
0.15 - 0.50	66 to 56	56 to 46
0.50 - 5	56	46
5 - 30	60	50

Note:

- (a) The lower limit shall apply at the band edges.
- (b) The limit decreases linearly with the logarithm of the frequency in the range 0.15 - 0.50MHz.

3.8.2. Test Procedures

The Table-top EUT was placed upon a non-metallic table 0.8m above the horizontal metal reference ground plane. EUT was connected to LISN and LISN was connected to reference Ground Plane. EUT was 80cm from LISN. The set-up and test methods were according to ANSI C63.10: 2013.

3.8.3. Test Setup Layout

Refer to chapter 2.6.2 in this report.

3.8.4. Test Result

Refer to Annex A.7 in this report.



3.9. Restricted Frequency Bands

3.9.1. Requirement

The peak emissions outside of the frequency bands of operation shall be attenuated in accordance with the following limits:

- (1) For transmitters operating in the 5.15–5.25 GHz band: all emissions outside of the 5.15–5.35 GHz band shall not exceed an EIRP of -27dBm/MHz.
- (2) For transmitters operating in the 5.25–5.35 GHz band: all emissions outside of the 5.15–5.35 GHz band shall not exceed an EIRP of -27dBm/MHz.
- (3) For transmitters operating in the 5.47–5.725 GHz band: all emissions outside of the 5.47–5.725 GHz band shall not exceed an EIRP of -27dBm/MHz.
- (4) For transmitters operating in the 5.725-5.85 GHz band:
 - (i) All emissions shall be limited to a level of -27 dBm/MHz at 75 MHz or more above or below the band edge increasing linearly to 10 dBm/MHz at 25 MHz above or below the band edge, and from 25 MHz above or below the band edge increasing linearly to a level of 15.6 dBm/MHz at 5 MHz above or below the band edge, and from 5 MHz above or below the band edge increasing linearly to a level of 27 dBm/MHz at the band edge.

The following formula is used to convert the equipment isotropic radiated power(e.i.r.p.) to field strength (dBμV/m);

$$E = 1000000 \times \sqrt{30P} / 3 \mu\text{V/m}$$

where P is the EIRP in Watts

Therefore: -27 dBm/MHz = 68.23 dBuV/m



Unwanted emissions below 1 GHz must comply with the general field strength limits set forth in § 15.209. According to FCC section 15.209 (a), except as provided elsewhere in this subpart, the emissions from an intentional radiator shall not exceed the field strength levels specified in the following table:

Frequency (MHz)	Field Strength (µV/m)	Measurement Distance (m)
0.009 - 0.490	2400/F(kHz)	300
0.490 - 1.705	24000/F(kHz)	30
1.705 - 30.0	30	30
30 - 88	100	3
88 - 216	150	3
216 - 960	200	3
Above 960	500	3

For Above 1000MHz, the emission limit in this paragraph is based on measurement instrumentation employing an average detector, measurement using instrumentation with a peak detector function, corresponding to 20dB above the maximum permitted average limit. In addition, radiated emissions which fall in the restricted bands, as defined in Section 15.205(a), also should comply with the radiated emission limits specified in Section 15.209(a)(above table).

3.9.2.Test Procedures

The EUT is located in a 3m Semi-Anechoic Chamber; the antenna factors, cable loss and so on of the site as factors are calculated to correct the reading.

KDB 789033 Section H) 3)5)6(d)) was used in order to prove compliance

For the Test Antenna:

Test Antenna is 3m away from the EUT. Test Antenna height is varied from 1m to 4m above the ground to determine the maximum value of the field strength.

3.9.3.Test Setup Layout

Refer to chapter 2.6.3 in this report.

3.9.4.Test Result

Refer to Annex A.8 in this report.

3.10. Radiated Emission

3.10.1.Requirement

The peak emissions outside of the frequency bands of operation shall be attenuated in accordance with the following limits:

- (1) For transmitters operating in the 5.15–5.25 GHz band: all emissions outside of the 5.15–5.35 GHz band shall not exceed an EIRP of -27dBm/MHz.
- (2) For transmitters operating in the 5.25–5.35 GHz band: all emissions outside of the 5.15–5.35 GHz band shall not exceed an EIRP of -27dBm/MHz.
- (3) For transmitters operating in the 5.47–5.725 GHz band: all emissions outside of the 5.47–5.725 GHz band shall not exceed an EIRP of -27dBm/MHz.
- (4) For transmitters operating in the 5.725-5.85 GHz band: All emissions within the frequency range from the band edge to 10 MHz above or below the band edge shall not exceed an e.i.r.p. of -17 dBm/MHz; for frequencies 10 MHz or greater above or below the band edge, emissions shall not exceed an e.i.r.p. of -27 dBm/MHz.

The following formula is used to convert the equipment isotropic radiated power(e.i.r.p.) to field strength (dBμV/m);

$$E = 1000000 \times \sqrt{\frac{30P}{3}} \mu\text{V/m}$$

where P is the EIRP in Watts

Therefore: -27 dBm/MHz = 68.23 dBuV/m

Unwanted emissions below 1 GHz must comply with the general field strength limits set forth in § 15.209. According to FCC section 15.209 (a), except as provided elsewhere in this subpart, the emissions from an intentional radiator shall not exceed the field strength levels specified in the following table:

Frequency (MHz)	Field Strength (μV/m)	Measurement Distance (m)
0.009 - 0.490	2400/F(kHz)	300
0.490 - 1.705	24000/F(kHz)	30
1.705 - 30.0	30	30
30 - 88	100	3
88 - 216	150	3
216 - 960	200	3
Above 960	500	3



For Above 1000MHz, the emission limit in this paragraph is based on measurement instrumentation employing an average detector, measurement using instrumentation with a peak detector function, corresponding to 20dB above the maximum permitted average limit. In addition, radiated emissions which fall in the restricted bands, as defined in Section 15.205(a), also should comply with the radiated emission limits specified in Section 15.209(a)(above table).

3.10.2.Test Procedures

The EUT is placed on a non-conducting table 80 cm above the ground plane for measurement below 1GHz; 1.5 m above the ground plane for measurement above 1GHz.The antenna to EUT distance is 3meters. The EUT is configured in accordance with ANSI C63.10. The EUT is set to transmit in a continuous mode.

For measurements below 30MHz, the emission limits shown in the above table are based on measurements employing a CISPR quasi-peak detector except for the frequency bands 9kHz-90 kHz, 110kHz-490 kHz. Radiated emission limits in these two bands are based on measurements employing an average detector.

For measurements below 1GHz the resolution bandwidth is set to 100kHz for peak detection measurements or 120kHz for quasi-peak detection measurements. Peak detection is used unless otherwise noted as quasi-peak.

For measurements above 1GHz the resolution bandwidth is set to 1MHz, the video band width is set to 3MHz for peak measurements and as applicable for average measurements.

The EUT is rotated through 360 degrees to maximize emissions received. The antenna is scanned from 1 to 4 meters above the ground plane to further maximize the emission. Measurements are made with the antenna polarized in both the vertical and the horizontal positions. For measurements above 1 GHz, keeping the measurement antenna aimed at the source of emissions at each frequency of significant emissions, with polarization oriented for maximum response.

3.10.3.Test Setup Layout

Refer to chapter 2.6.3 in this report.

3.10.4.Test Result

Refer to Annex A.9 in this report.

Annex A Test Data and Result

A.1. Duty Cycle of Test Signal

Condition	Mode	Frequency (MHz)	Antenna	Duty Cycle (%)	Correction Factor (dB)	1/T (kHz)
NVNT	a SISO	5180	Ant1	99.15	0.04	0.48
NVNT	a SISO	5220	Ant1	99.15	0.04	0.48
NVNT	a SISO	5240	Ant1	99.24	0.03	0.48
NVNT	a SISO	5260	Ant1	99.15	0.04	0.48
NVNT	a SISO	5300	Ant1	99.24	0.03	0.48
NVNT	a SISO	5320	Ant1	99.15	0.04	0.48
NVNT	a SISO	5500	Ant1	99.15	0.04	0.48
NVNT	a SISO	5580	Ant1	99.24	0.03	0.48
NVNT	a SISO	5600	Ant1	99.15	0.04	0.48
NVNT	a SISO	5720	Ant1	99.24	0.03	0.48
NVNT	a SISO	5745	Ant1	99.24	0.03	0.48
NVNT	a SISO	5785	Ant1	99.24	0.03	0.48
NVNT	a SISO	5825	Ant1	99.15	0.04	0.48
NVNT	a SISO	5180	Ant2	99.24	0.03	0.48
NVNT	a SISO	5220	Ant2	99.24	0.03	0.48
NVNT	a SISO	5240	Ant2	99.24	0.03	0.48
NVNT	a SISO	5260	Ant2	99.15	0.04	0.48
NVNT	a SISO	5300	Ant2	99.24	0.03	0.48
NVNT	a SISO	5320	Ant2	99.24	0.03	0.48
NVNT	a SISO	5500	Ant2	99.24	0.03	0.48
NVNT	a SISO	5580	Ant2	99.15	0.04	0.48
NVNT	a SISO	5600	Ant2	99.15	0.04	0.48
NVNT	a SISO	5720	Ant2	99.15	0.04	0.48
NVNT	a SISO	5745	Ant2	99.15	0.04	0.48
NVNT	a SISO	5785	Ant2	99.24	0.03	0.48
NVNT	a SISO	5825	Ant2	99.15	0.04	0.48
NVNT	n20 SISO	5180	Ant1	99.71	0.01	0.18
NVNT	n20 SISO	5220	Ant1	99.71	0.01	0.18
NVNT	n20 SISO	5240	Ant1	99.71	0.01	0.18
NVNT	n20 SISO	5260	Ant1	99.71	0.01	0.18
NVNT	n20 SISO	5300	Ant1	99.67	0.01	0.18
NVNT	n20 SISO	5320	Ant1	99.71	0.01	0.18



NVNT	n20 SISO	5500	Ant1	99.67	0.01	0.18
NVNT	n20 SISO	5580	Ant1	99.71	0.01	0.18
NVNT	n20 SISO	5600	Ant1	99.71	0.01	0.18
NVNT	n20 SISO	5720	Ant1	99.71	0.01	0.18
NVNT	n20 SISO	5745	Ant1	99.71	0.01	0.18
NVNT	n20 SISO	5785	Ant1	99.71	0.01	0.18
NVNT	n20 SISO	5825	Ant1	99.71	0.01	0.18
NVNT	n20 SISO	5180	Ant2	99.67	0.01	0.18
NVNT	n20 SISO	5220	Ant2	99.71	0.01	0.18
NVNT	n20 SISO	5240	Ant2	99.67	0.01	0.18
NVNT	n20 SISO	5260	Ant2	99.67	0.01	0.18
NVNT	n20 SISO	5300	Ant2	99.71	0.01	0.18
NVNT	n20 SISO	5320	Ant2	99.71	0.01	0.18
NVNT	n20 SISO	5500	Ant2	99.71	0.01	0.18
NVNT	n20 SISO	5580	Ant2	99.71	0.01	0.18
NVNT	n20 SISO	5600	Ant2	99.67	0.01	0.18
NVNT	n20 SISO	5720	Ant2	99.71	0.01	0.18
NVNT	n20 SISO	5745	Ant2	99.71	0.01	0.18
NVNT	n20 SISO	5785	Ant2	99.67	0.01	0.18
NVNT	n20 SISO	5825	Ant2	99.67	0.01	0.18
NVNT	n20 MIMO	5180	Sum	99.71	0.01	0.18
NVNT	n20 MIMO	5220	Sum	99.67	0.01	0.18
NVNT	n20 MIMO	5240	Sum	99.71	0.01	0.18
NVNT	n20 MIMO	5260	Sum	99.71	0.01	0.18
NVNT	n20 MIMO	5300	Sum	99.67	0.01	0.18
NVNT	n20 MIMO	5320	Sum	99.71	0.01	0.18
NVNT	n20 MIMO	5500	Sum	99.67	0.01	0.18
NVNT	n20 MIMO	5580	Sum	99.67	0.01	0.18
NVNT	n20 MIMO	5600	Sum	99.67	0.01	0.18
NVNT	n20 MIMO	5720	Sum	99.71	0.01	0.18
NVNT	n20 MIMO	5745	Sum	99.67	0.01	0.18
NVNT	n20 MIMO	5785	Sum	99.67	0.01	0.18
NVNT	n20 MIMO	5825	Sum	99.71	0.01	0.18
NVNT	n40 SISO	5190	Ant1	99.71	0.01	0.18
NVNT	n40 SISO	5230	Ant1	99.71	0.01	0.18
NVNT	n40 SISO	5270	Ant1	99.67	0.01	0.18
NVNT	n40 SISO	5310	Ant1	99.71	0.01	0.18
NVNT	n40 SISO	5510	Ant1	99.71	0.01	0.18



NVNT	n40 SISO	5550	Ant1	99.71	0.01	0.18
NVNT	n40 SISO	5630	Ant1	99.71	0.01	0.18
NVNT	n40 SISO	5710	Ant1	99.71	0.01	0.18
NVNT	n40 SISO	5755	Ant1	99.71	0.01	0.18
NVNT	n40 SISO	5795	Ant1	99.71	0.01	0.18
NVNT	n40 SISO	5190	Ant2	99.71	0.01	0.18
NVNT	n40 SISO	5230	Ant2	99.67	0.01	0.18
NVNT	n40 SISO	5270	Ant2	99.67	0.01	0.18
NVNT	n40 SISO	5310	Ant2	99.71	0.01	0.18
NVNT	n40 SISO	5510	Ant2	99.67	0.01	0.18
NVNT	n40 SISO	5550	Ant2	99.71	0.01	0.18
NVNT	n40 SISO	5630	Ant2	99.71	0.01	0.18
NVNT	n40 SISO	5710	Ant2	99.67	0.01	0.18
NVNT	n40 SISO	5755	Ant2	99.71	0.01	0.18
NVNT	n40 SISO	5795	Ant2	99.71	0.01	0.18
NVNT	n40 MIMO	5190	Sum	99.71	0.01	0.18
NVNT	n40 MIMO	5230	Sum	99.71	0.01	0.18
NVNT	n40 MIMO	5270	Sum	99.71	0.01	0.18
NVNT	n40 MIMO	5310	Sum	99.71	0.01	0.18
NVNT	n40 MIMO	5510	Sum	99.71	0.01	0.18
NVNT	n40 MIMO	5550	Sum	99.71	0.01	0.18
NVNT	n40 MIMO	5630	Sum	99.71	0.01	0.18
NVNT	n40 MIMO	5710	Sum	99.67	0.01	0.18
NVNT	n40 MIMO	5755	Sum	99.71	0.01	0.18
NVNT	n40 MIMO	5795	Sum	99.71	0.01	0.18
NVNT	ac20 SISO	5180	Ant1	99.71	0.01	0.18
NVNT	ac20 SISO	5220	Ant1	99.67	0.01	0.18
NVNT	ac20 SISO	5240	Ant1	99.67	0.01	0.18
NVNT	ac20 SISO	5260	Ant1	99.67	0.01	0.18
NVNT	ac20 SISO	5300	Ant1	99.67	0.01	0.18
NVNT	ac20 SISO	5320	Ant1	99.67	0.01	0.18
NVNT	ac20 SISO	5500	Ant1	99.67	0.01	0.18
NVNT	ac20 SISO	5580	Ant1	99.67	0.01	0.18
NVNT	ac20 SISO	5600	Ant1	99.67	0.01	0.18
NVNT	ac20 SISO	5720	Ant1	99.67	0.01	0.18
NVNT	ac20 SISO	5745	Ant1	99.71	0.01	0.18
NVNT	ac20 SISO	5785	Ant1	99.67	0.01	0.18
NVNT	ac20 SISO	5825	Ant1	99.67	0.01	0.18



NVNT	ac20 SISO	5180	Ant2	99.67	0.01	0.18
NVNT	ac20 SISO	5220	Ant2	99.67	0.01	0.18
NVNT	ac20 SISO	5240	Ant2	99.71	0.01	0.18
NVNT	ac20 SISO	5260	Ant2	99.71	0.01	0.18
NVNT	ac20 SISO	5300	Ant2	99.67	0.01	0.18
NVNT	ac20 SISO	5320	Ant2	99.71	0.01	0.18
NVNT	ac20 SISO	5500	Ant2	99.71	0.01	0.18
NVNT	ac20 SISO	5580	Ant2	99.71	0.01	0.18
NVNT	ac20 SISO	5600	Ant2	99.67	0.01	0.18
NVNT	ac20 SISO	5720	Ant2	99.67	0.01	0.18
NVNT	ac20 SISO	5745	Ant2	99.67	0.01	0.18
NVNT	ac20 SISO	5785	Ant2	99.67	0.01	0.18
NVNT	ac20 SISO	5825	Ant2	99.71	0.01	0.18
NVNT	ac20 MIMO	5180	Sum	99.67	0.01	0.18
NVNT	ac20 MIMO	5220	Sum	99.71	0.01	0.18
NVNT	ac20 MIMO	5240	Sum	99.71	0.01	0.18
NVNT	ac20 MIMO	5260	Sum	99.67	0.01	0.18
NVNT	ac20 MIMO	5300	Sum	99.71	0.01	0.18
NVNT	ac20 MIMO	5320	Sum	99.67	0.01	0.18
NVNT	ac20 MIMO	5500	Sum	99.71	0.01	0.18
NVNT	ac20 MIMO	5580	Sum	99.67	0.01	0.18
NVNT	ac20 MIMO	5600	Sum	99.71	0.01	0.18
NVNT	ac20 MIMO	5720	Sum	99.71	0.01	0.18
NVNT	ac20 MIMO	5745	Sum	99.71	0.01	0.18
NVNT	ac20 MIMO	5785	Sum	99.71	0.01	0.18
NVNT	ac20 MIMO	5825	Sum	99.67	0.01	0.18
NVNT	ac40 SISO	5190	Ant1	99.71	0.01	0.18
NVNT	ac40 SISO	5230	Ant1	99.71	0.01	0.18
NVNT	ac40 SISO	5270	Ant1	99.71	0.01	0.18
NVNT	ac40 SISO	5310	Ant1	99.71	0.01	0.18
NVNT	ac40 SISO	5510	Ant1	99.71	0.01	0.18
NVNT	ac40 SISO	5550	Ant1	99.71	0.01	0.18
NVNT	ac40 SISO	5630	Ant1	99.71	0.01	0.18
NVNT	ac40 SISO	5710	Ant1	99.71	0.01	0.18
NVNT	ac40 SISO	5755	Ant1	99.71	0.01	0.18
NVNT	ac40 SISO	5795	Ant1	99.71	0.01	0.18
NVNT	ac40 SISO	5190	Ant2	99.71	0.01	0.18
NVNT	ac40 SISO	5230	Ant2	99.71	0.01	0.18



NVNT	ac40 SISO	5270	Ant2	99.71	0.01	0.18
NVNT	ac40 SISO	5310	Ant2	99.71	0.01	0.18
NVNT	ac40 SISO	5510	Ant2	99.71	0.01	0.18
NVNT	ac40 SISO	5550	Ant2	99.71	0.01	0.18
NVNT	ac40 SISO	5630	Ant2	99.71	0.01	0.18
NVNT	ac40 SISO	5710	Ant2	99.71	0.01	0.18
NVNT	ac40 SISO	5755	Ant2	99.71	0.01	0.18
NVNT	ac40 SISO	5795	Ant2	99.71	0.01	0.18
NVNT	ac40 MIMO	5190	Sum	99.71	0.01	0.18
NVNT	ac40 MIMO	5230	Sum	99.71	0.01	0.18
NVNT	ac40 MIMO	5270	Sum	99.71	0.01	0.18
NVNT	ac40 MIMO	5310	Sum	99.71	0.01	0.18
NVNT	ac40 MIMO	5510	Sum	99.67	0.01	0.18
NVNT	ac40 MIMO	5550	Sum	99.71	0.01	0.18
NVNT	ac40 MIMO	5630	Sum	99.71	0.01	0.18
NVNT	ac40 MIMO	5710	Sum	99.71	0.01	0.18
NVNT	ac40 MIMO	5755	Sum	99.71	0.01	0.18
NVNT	ac40 MIMO	5795	Sum	99.71	0.01	0.18
NVNT	ac80 SISO	5210	Ant1	99.71	0.01	0.18
NVNT	ac80 SISO	5290	Ant1	99.71	0.01	0.18
NVNT	ac80 SISO	5530	Ant1	99.71	0.01	0.18
NVNT	ac80 SISO	5610	Ant1	99.71	0.01	0.18
NVNT	ac80 SISO	5690	Ant1	99.71	0.01	0.18
NVNT	ac80 SISO	5775	Ant1	99.71	0.01	0.18
NVNT	ac80 SISO	5210	Ant2	99.71	0.01	0.18
NVNT	ac80 SISO	5290	Ant2	99.71	0.01	0.18
NVNT	ac80 SISO	5530	Ant2	99.71	0.01	0.18
NVNT	ac80 SISO	5610	Ant2	99.71	0.01	0.18
NVNT	ac80 SISO	5690	Ant2	99.71	0.01	0.18
NVNT	ac80 SISO	5775	Ant2	99.71	0.01	0.18
NVNT	ac80 MIMO	5210	Sum	99.71	0.01	0.18
NVNT	ac80 MIMO	5290	Sum	99.71	0.01	0.18
NVNT	ac80 MIMO	5530	Sum	99.74	0.01	0.18
NVNT	ac80 MIMO	5610	Sum	99.71	0.01	0.18
NVNT	ac80 MIMO	5690	Sum	99.71	0.01	0.18
NVNT	ac80 MIMO	5775	Sum	99.71	0.01	0.18
NVNT	ac160 SISO	5250	Ant1	99.71	0.01	0.18
NVNT	ac160 SISO	5570	Ant1	99.71	0.01	0.18



NVNT	ac160 SISO	5250	Ant2	99.71	0.01	0.18
NVNT	ac160 SISO	5570	Ant2	99.71	0.01	0.18
NVNT	ac160 MIMO	5250	Sum	99.71	0.01	0.18
NVNT	ac160 MIMO	5570	Sum	99.71	0.01	0.18
NVNT	ax20 SISO	5180	Ant1	99.67	0.01	0.18
NVNT	ax20 SISO	5220	Ant1	99.67	0.01	0.18
NVNT	ax20 SISO	5240	Ant1	99.67	0.01	0.18
NVNT	ax20 SISO	5260	Ant1	99.67	0.01	0.18
NVNT	ax20 SISO	5300	Ant1	99.67	0.01	0.18
NVNT	ax20 SISO	5320	Ant1	99.67	0.01	0.18
NVNT	ax20 SISO	5500	Ant1	99.71	0.01	0.18
NVNT	ax20 SISO	5580	Ant1	99.67	0.01	0.18
NVNT	ax20 SISO	5600	Ant1	99.71	0.01	0.18
NVNT	ax20 SISO	5720	Ant1	99.67	0.01	0.18
NVNT	ax20 SISO	5745	Ant1	99.67	0.01	0.18
NVNT	ax20 SISO	5785	Ant1	99.71	0.01	0.18
NVNT	ax20 SISO	5825	Ant1	99.67	0.01	0.18
NVNT	ax20 SISO	5180	Ant2	99.67	0.01	0.18
NVNT	ax20 SISO	5220	Ant2	99.67	0.01	0.18
NVNT	ax20 SISO	5240	Ant2	99.67	0.01	0.18
NVNT	ax20 SISO	5260	Ant2	99.67	0.01	0.18
NVNT	ax20 SISO	5300	Ant2	99.67	0.01	0.18
NVNT	ax20 SISO	5320	Ant2	99.71	0.01	0.18
NVNT	ax20 SISO	5500	Ant2	99.67	0.01	0.18
NVNT	ax20 SISO	5580	Ant2	99.67	0.01	0.18
NVNT	ax20 SISO	5600	Ant2	99.67	0.01	0.18
NVNT	ax20 SISO	5720	Ant2	99.71	0.01	0.18
NVNT	ax20 SISO	5745	Ant2	99.71	0.01	0.18
NVNT	ax20 SISO	5785	Ant2	99.71	0.01	0.18
NVNT	ax20 SISO	5825	Ant2	99.71	0.01	0.18
NVNT	ax20 MIMO	5180	Sum	99.71	0.01	0.18
NVNT	ax20 MIMO	5220	Sum	99.71	0.01	0.18
NVNT	ax20 MIMO	5240	Sum	99.71	0.01	0.18
NVNT	ax20 MIMO	5260	Sum	99.67	0.01	0.18
NVNT	ax20 MIMO	5300	Sum	99.71	0.01	0.18
NVNT	ax20 MIMO	5320	Sum	99.71	0.01	0.18
NVNT	ax20 MIMO	5500	Sum	99.67	0.01	0.18
NVNT	ax20 MIMO	5580	Sum	99.67	0.01	0.18



NVNT	ax20 MIMO	5600	Sum	99.71	0.01	0.18
NVNT	ax20 MIMO	5720	Sum	99.67	0.01	0.18
NVNT	ax20 MIMO	5745	Sum	99.67	0.01	0.18
NVNT	ax20 MIMO	5785	Sum	99.67	0.01	0.18
NVNT	ax20 MIMO	5825	Sum	99.67	0.01	0.18
NVNT	ax40 SISO	5190	Ant1	99.71	0.01	0.18
NVNT	ax40 SISO	5230	Ant1	99.71	0.01	0.18
NVNT	ax40 SISO	5270	Ant1	99.71	0.01	0.18
NVNT	ax40 SISO	5310	Ant1	99.71	0.01	0.18
NVNT	ax40 SISO	5510	Ant1	99.71	0.01	0.18
NVNT	ax40 SISO	5550	Ant1	99.71	0.01	0.18
NVNT	ax40 SISO	5630	Ant1	99.71	0.01	0.18
NVNT	ax40 SISO	5710	Ant1	99.71	0.01	0.18
NVNT	ax40 SISO	5755	Ant1	99.67	0.01	0.18
NVNT	ax40 SISO	5795	Ant1	99.71	0.01	0.18
NVNT	ax40 SISO	5190	Ant2	99.71	0.01	0.18
NVNT	ax40 SISO	5230	Ant2	99.71	0.01	0.18
NVNT	ax40 SISO	5270	Ant2	99.71	0.01	0.18
NVNT	ax40 SISO	5310	Ant2	99.71	0.01	0.18
NVNT	ax40 SISO	5510	Ant2	99.71	0.01	0.18
NVNT	ax40 SISO	5550	Ant2	99.71	0.01	0.18
NVNT	ax40 SISO	5630	Ant2	99.71	0.01	0.18
NVNT	ax40 SISO	5710	Ant2	99.71	0.01	0.18
NVNT	ax40 SISO	5755	Ant2	99.71	0.01	0.18
NVNT	ax40 SISO	5795	Ant2	99.71	0.01	0.18
NVNT	ax40 MIMO	5190	Sum	99.71	0.01	0.18
NVNT	ax40 MIMO	5230	Sum	99.71	0.01	0.18
NVNT	ax40 MIMO	5270	Sum	99.71	0.01	0.18
NVNT	ax40 MIMO	5310	Sum	99.71	0.01	0.18
NVNT	ax40 MIMO	5510	Sum	99.71	0.01	0.18
NVNT	ax40 MIMO	5550	Sum	99.71	0.01	0.18
NVNT	ax40 MIMO	5630	Sum	99.71	0.01	0.18
NVNT	ax40 MIMO	5710	Sum	99.71	0.01	0.18
NVNT	ax40 MIMO	5755	Sum	99.71	0.01	0.18
NVNT	ax40 MIMO	5795	Sum	99.71	0.01	0.18
NVNT	ax80 SISO	5210	Ant1	99.71	0.01	0.18
NVNT	ax80 SISO	5290	Ant1	99.71	0.01	0.18
NVNT	ax80 SISO	5530	Ant1	99.71	0.01	0.18



NVNT	ax80 SISO	5610	Ant1	99.71	0.01	0.18
NVNT	ax80 SISO	5690	Ant1	99.71	0.01	0.18
NVNT	ax80 SISO	5775	Ant1	99.71	0.01	0.18
NVNT	ax80 SISO	5210	Ant2	99.71	0.01	0.18
NVNT	ax80 SISO	5290	Ant2	99.71	0.01	0.18
NVNT	ax80 SISO	5530	Ant2	99.71	0.01	0.18
NVNT	ax80 SISO	5610	Ant2	99.71	0.01	0.18
NVNT	ax80 SISO	5690	Ant2	99.71	0.01	0.18
NVNT	ax80 SISO	5775	Ant2	99.71	0.01	0.18
NVNT	ax80 MIMO	5210	Sum	99.71	0.01	0.18
NVNT	ax80 MIMO	5290	Sum	99.71	0.01	0.18
NVNT	ax80 MIMO	5530	Sum	99.71	0.01	0.18
NVNT	ax80 MIMO	5610	Sum	99.71	0.01	0.18
NVNT	ax80 MIMO	5690	Sum	99.71	0.01	0.18
NVNT	ax80 MIMO	5775	Sum	99.71	0.01	0.18
NVNT	ax160 SISO	5250	Ant1	99.71	0.01	0.18
NVNT	ax160 SISO	5570	Ant1	99.71	0.01	0.18
NVNT	ax160 SISO	5250	Ant2	99.71	0.01	0.18
NVNT	ax160 SISO	5570	Ant2	99.74	0.01	0.18
NVNT	ax160 MIMO	5250	Sum	99.71	0.01	0.18
NVNT	ax160 MIMO	5570	Sum	99.71	0.01	0.18
NVNT	ax20 26@0 SISO	5180	Ant1	99.69	0.01	0.2
NVNT	ax20 26@0 SISO	5220	Ant1	99.65	0.02	0.2
NVNT	ax20 26@0 SISO	5240	Ant1	99.65	0.02	0.2
NVNT	ax20 26@0 SISO	5260	Ant1	99.69	0.01	0.2
NVNT	ax20 26@0 SISO	5300	Ant1	99.69	0.01	0.2
NVNT	ax20 26@0 SISO	5320	Ant1	99.69	0.01	0.2
NVNT	ax20 26@0 SISO	5500	Ant1	99.69	0.01	0.2
NVNT	ax20 26@0 SISO	5580	Ant1	99.69	0.01	0.2
NVNT	ax20 26@0 SISO	5600	Ant1	99.69	0.01	0.2
NVNT	ax20 26@0 SISO	5720	Ant1	99.69	0.01	0.2
NVNT	ax20 26@0 SISO	5745	Ant1	99.65	0.02	0.2
NVNT	ax20 26@0 SISO	5785	Ant1	99.69	0.01	0.2
NVNT	ax20 26@0 SISO	5825	Ant1	99.65	0.02	0.2
NVNT	ax20 26@0 SISO	5180	Ant2	99.69	0.01	0.2
NVNT	ax20 26@0 SISO	5220	Ant2	99.65	0.02	0.2
NVNT	ax20 26@0 SISO	5240	Ant2	99.69	0.01	0.2
NVNT	ax20 26@0 SISO	5260	Ant2	99.65	0.02	0.2



NVNT	ax20 26@0 SISO	5300	Ant2	99.65	0.02	0.2
NVNT	ax20 26@0 SISO	5320	Ant2	99.65	0.02	0.2
NVNT	ax20 26@0 SISO	5500	Ant2	99.69	0.01	0.2
NVNT	ax20 26@0 SISO	5580	Ant2	99.69	0.01	0.2
NVNT	ax20 26@0 SISO	5600	Ant2	99.65	0.02	0.2
NVNT	ax20 26@0 SISO	5720	Ant2	99.65	0.02	0.2
NVNT	ax20 26@0 SISO	5745	Ant2	99.69	0.01	0.2
NVNT	ax20 26@0 SISO	5785	Ant2	99.69	0.01	0.2
NVNT	ax20 26@0 SISO	5825	Ant2	99.65	0.02	0.2
NVNT	ax20 26@0 MIMO	5180	Sum	99.69	0.01	0.2
NVNT	ax20 26@0 MIMO	5220	Sum	99.65	0.02	0.2
NVNT	ax20 26@0 MIMO	5240	Sum	99.65	0.02	0.2
NVNT	ax20 26@0 MIMO	5260	Sum	99.69	0.01	0.2
NVNT	ax20 26@0 MIMO	5300	Sum	99.69	0.01	0.2
NVNT	ax20 26@0 MIMO	5320	Sum	99.69	0.01	0.2
NVNT	ax20 26@0 MIMO	5500	Sum	99.69	0.01	0.2
NVNT	ax20 26@0 MIMO	5580	Sum	99.69	0.01	0.2
NVNT	ax20 26@0 MIMO	5600	Sum	99.69	0.01	0.2
NVNT	ax20 26@0 MIMO	5720	Sum	99.65	0.02	0.2
NVNT	ax20 26@0 MIMO	5745	Sum	99.65	0.02	0.2
NVNT	ax20 26@0 MIMO	5785	Sum	99.65	0.02	0.2
NVNT	ax20 26@0 MIMO	5825	Sum	99.69	0.01	0.2
NVNT	ax20 52@37 SISO	5180	Ant1	99.69	0.01	0.2
NVNT	ax20 52@37 SISO	5220	Ant1	99.69	0.01	0.2
NVNT	ax20 52@37 SISO	5240	Ant1	99.69	0.01	0.2
NVNT	ax20 52@37 SISO	5260	Ant1	99.69	0.01	0.2
NVNT	ax20 52@37 SISO	5300	Ant1	99.65	0.02	0.2
NVNT	ax20 52@37 SISO	5320	Ant1	99.69	0.01	0.2
NVNT	ax20 52@37 SISO	5500	Ant1	99.69	0.01	0.2
NVNT	ax20 52@37 SISO	5580	Ant1	99.65	0.02	0.2
NVNT	ax20 52@37 SISO	5600	Ant1	99.69	0.01	0.2
NVNT	ax20 52@37 SISO	5720	Ant1	99.69	0.01	0.2
NVNT	ax20 52@37 SISO	5745	Ant1	99.69	0.01	0.2
NVNT	ax20 52@37 SISO	5785	Ant1	99.65	0.02	0.2
NVNT	ax20 52@37 SISO	5825	Ant1	99.65	0.02	0.2
NVNT	ax20 52@37 SISO	5180	Ant2	99.69	0.01	0.2
NVNT	ax20 52@37 SISO	5220	Ant2	99.69	0.01	0.2
NVNT	ax20 52@37 SISO	5240	Ant2	99.69	0.01	0.2



NVNT	ax20 52@37 SISO	5260	Ant2	99.69	0.01	0.2
NVNT	ax20 52@37 SISO	5300	Ant2	99.69	0.01	0.2
NVNT	ax20 52@37 SISO	5320	Ant2	99.65	0.02	0.2
NVNT	ax20 52@37 SISO	5500	Ant2	99.65	0.02	0.2
NVNT	ax20 52@37 SISO	5580	Ant2	99.65	0.02	0.2
NVNT	ax20 52@37 SISO	5600	Ant2	99.69	0.01	0.2
NVNT	ax20 52@37 SISO	5720	Ant2	99.69	0.01	0.2
NVNT	ax20 52@37 SISO	5745	Ant2	99.69	0.01	0.2
NVNT	ax20 52@37 SISO	5785	Ant2	99.65	0.02	0.2
NVNT	ax20 52@37 SISO	5825	Ant2	99.69	0.01	0.2
NVNT	ax20 52@37 MIMO	5180	Sum	99.65	0.02	0.2
NVNT	ax20 52@37 MIMO	5220	Sum	99.69	0.01	0.2
NVNT	ax20 52@37 MIMO	5240	Sum	99.69	0.01	0.2
NVNT	ax20 52@37 MIMO	5260	Sum	99.69	0.01	0.2
NVNT	ax20 52@37 MIMO	5300	Sum	99.65	0.02	0.2
NVNT	ax20 52@37 MIMO	5320	Sum	99.69	0.01	0.2
NVNT	ax20 52@37 MIMO	5500	Sum	99.69	0.01	0.2
NVNT	ax20 52@37 MIMO	5580	Sum	99.69	0.01	0.2
NVNT	ax20 52@37 MIMO	5600	Sum	99.69	0.01	0.2
NVNT	ax20 52@37 MIMO	5720	Sum	99.65	0.02	0.2
NVNT	ax20 52@37 MIMO	5745	Sum	99.65	0.02	0.2
NVNT	ax20 52@37 MIMO	5785	Sum	99.69	0.01	0.2
NVNT	ax20 52@37 MIMO	5825	Sum	99.65	0.02	0.2
NVNT	ax20 106@53 SISO	5180	Ant1	99.62	0.02	0.21
NVNT	ax20 106@53 SISO	5220	Ant1	99.67	0.01	0.21
NVNT	ax20 106@53 SISO	5240	Ant1	99.67	0.01	0.21
NVNT	ax20 106@53 SISO	5260	Ant1	99.67	0.01	0.21
NVNT	ax20 106@53 SISO	5300	Ant1	99.67	0.01	0.21
NVNT	ax20 106@53 SISO	5320	Ant1	99.67	0.01	0.21
NVNT	ax20 106@53 SISO	5500	Ant1	99.62	0.02	0.21
NVNT	ax20 106@53 SISO	5580	Ant1	99.67	0.01	0.21
NVNT	ax20 106@53 SISO	5600	Ant1	99.67	0.01	0.21
NVNT	ax20 106@53 SISO	5720	Ant1	99.62	0.02	0.21
NVNT	ax20 106@53 SISO	5745	Ant1	99.67	0.01	0.21
NVNT	ax20 106@53 SISO	5785	Ant1	99.67	0.01	0.21
NVNT	ax20 106@53 SISO	5825	Ant1	99.67	0.01	0.21
NVNT	ax20 106@53 SISO	5180	Ant2	99.67	0.01	0.21
NVNT	ax20 106@53 SISO	5220	Ant2	99.67	0.01	0.21



NVNT	ax20 106@53 SISO	5240	Ant2	99.62	0.02	0.21
NVNT	ax20 106@53 SISO	5260	Ant2	99.67	0.01	0.21
NVNT	ax20 106@53 SISO	5300	Ant2	99.67	0.01	0.21
NVNT	ax20 106@53 SISO	5320	Ant2	99.62	0.02	0.21
NVNT	ax20 106@53 SISO	5500	Ant2	99.67	0.01	0.21
NVNT	ax20 106@53 SISO	5580	Ant2	99.67	0.01	0.21
NVNT	ax20 106@53 SISO	5600	Ant2	99.62	0.02	0.21
NVNT	ax20 106@53 SISO	5720	Ant2	99.67	0.01	0.21
NVNT	ax20 106@53 SISO	5745	Ant2	99.67	0.01	0.21
NVNT	ax20 106@53 SISO	5785	Ant2	99.62	0.02	0.21
NVNT	ax20 106@53 SISO	5825	Ant2	99.67	0.01	0.21
NVNT	ax20 106@53 MIMO	5180	Sum	99.67	0.01	0.21
NVNT	ax20 106@53 MIMO	5220	Sum	99.62	0.02	0.21
NVNT	ax20 106@53 MIMO	5240	Sum	99.67	0.01	0.21
NVNT	ax20 106@53 MIMO	5260	Sum	99.67	0.01	0.21
NVNT	ax20 106@53 MIMO	5300	Sum	99.67	0.01	0.21
NVNT	ax20 106@53 MIMO	5320	Sum	99.67	0.01	0.21
NVNT	ax20 106@53 MIMO	5500	Sum	99.67	0.01	0.21
NVNT	ax20 106@53 MIMO	5580	Sum	99.62	0.02	0.21
NVNT	ax20 106@53 MIMO	5600	Sum	99.67	0.01	0.21
NVNT	ax20 106@53 MIMO	5720	Sum	99.62	0.02	0.21
NVNT	ax20 106@53 MIMO	5745	Sum	99.67	0.01	0.21
NVNT	ax20 106@53 MIMO	5785	Sum	99.67	0.01	0.21
NVNT	ax20 106@53 MIMO	5825	Sum	99.67	0.01	0.21
NVNT	ax40 242@61 SISO	5190	Ant1	99.42	0.03	0.37
NVNT	ax40 242@61 SISO	5230	Ant1	99.42	0.03	0.37
NVNT	ax40 242@61 SISO	5270	Ant1	99.42	0.03	0.37
NVNT	ax40 242@61 SISO	5310	Ant1	99.42	0.03	0.37
NVNT	ax40 242@61 SISO	5510	Ant1	99.42	0.03	0.37
NVNT	ax40 242@61 SISO	5550	Ant1	99.42	0.03	0.37
NVNT	ax40 242@61 SISO	5630	Ant1	99.42	0.03	0.37
NVNT	ax40 242@61 SISO	5710	Ant1	99.42	0.03	0.37
NVNT	ax40 242@61 SISO	5755	Ant1	99.42	0.03	0.37
NVNT	ax40 242@61 SISO	5795	Ant1	99.42	0.03	0.37
NVNT	ax40 242@61 SISO	5190	Ant2	99.42	0.03	0.37
NVNT	ax40 242@61 SISO	5230	Ant2	99.42	0.03	0.37
NVNT	ax40 242@61 SISO	5270	Ant2	99.42	0.03	0.37
NVNT	ax40 242@61 SISO	5310	Ant2	99.42	0.03	0.37



NVNT	ax40 242@61 SISO	5510	Ant2	99.42	0.03	0.37
NVNT	ax40 242@61 SISO	5550	Ant2	99.42	0.03	0.37
NVNT	ax40 242@61 SISO	5630	Ant2	99.42	0.03	0.37
NVNT	ax40 242@61 SISO	5710	Ant2	99.42	0.03	0.37
NVNT	ax40 242@61 SISO	5755	Ant2	99.42	0.03	0.37
NVNT	ax40 242@61 SISO	5795	Ant2	99.42	0.03	0.37
NVNT	ax40 242@61 MIMO	5190	Sum	99.42	0.03	0.37
NVNT	ax40 242@61 MIMO	5230	Sum	99.42	0.03	0.37
NVNT	ax40 242@61 MIMO	5270	Sum	99.42	0.03	0.37
NVNT	ax40 242@61 MIMO	5310	Sum	99.42	0.03	0.37
NVNT	ax40 242@61 MIMO	5510	Sum	99.42	0.03	0.37
NVNT	ax40 242@61 MIMO	5550	Sum	99.42	0.03	0.37
NVNT	ax40 242@61 MIMO	5630	Sum	99.42	0.03	0.37
NVNT	ax40 242@61 MIMO	5710	Sum	99.42	0.03	0.37
NVNT	ax40 242@61 MIMO	5755	Sum	99.42	0.03	0.37
NVNT	ax40 242@61 MIMO	5795	Sum	99.42	0.03	0.37
NVNT	ax80 484@65 SISO	5210	Ant1	98.87	0.05	0.71
NVNT	ax80 484@65 SISO	5290	Ant1	98.87	0.05	0.71
NVNT	ax80 484@65 SISO	5530	Ant1	98.87	0.05	0.71
NVNT	ax80 484@65 SISO	5610	Ant1	98.87	0.05	0.71
NVNT	ax80 484@65 SISO	5690	Ant1	98.87	0.05	0.71
NVNT	ax80 484@65 SISO	5775	Ant1	98.87	0.05	0.71
NVNT	ax80 484@65 SISO	5210	Ant2	98.87	0.05	0.71
NVNT	ax80 484@65 SISO	5290	Ant2	98.87	0.05	0.71
NVNT	ax80 484@65 SISO	5530	Ant2	98.87	0.05	0.71
NVNT	ax80 484@65 SISO	5610	Ant2	98.87	0.05	0.71
NVNT	ax80 484@65 SISO	5690	Ant2	98.87	0.05	0.71
NVNT	ax80 484@65 SISO	5775	Ant2	98.87	0.05	0.71
NVNT	ax80 484@65 MIMO	5210	Sum	98.87	0.05	0.71
NVNT	ax80 484@65 MIMO	5290	Sum	98.87	0.05	0.71
NVNT	ax80 484@65 MIMO	5530	Sum	98.87	0.05	0.71
NVNT	ax80 484@65 MIMO	5610	Sum	98.87	0.05	0.71
NVNT	ax80 484@65 MIMO	5690	Sum	98.87	0.05	0.71
NVNT	ax80 484@65 MIMO	5775	Sum	99.01	0.04	0.71
NVNT	ax160 996@67 SISO	5250	Ant1	14.05	8.52	4.9
NVNT	ax160 996@67 SISO	5570	Ant1	14.15	8.49	4.9
NVNT	ax160 996@67 SISO	5250	Ant2	14.23	8.47	4.9
NVNT	ax160 996@67 SISO	5570	Ant2	14.05	8.52	4.9



NVNT	ax160 996@67 MIMO	5250	Sum	14.15	8.49	4.9
NVNT	ax160 996@67 MIMO	5570	Sum	14.05	8.52	4.9



A.2. Maximum Conducted Output Power

Condition	Mode	Frequency (MHz)	Antenna	Total Conducted Power (dBm)	Total Conducted Power (W)	Limit Conducted (dBm)	Verdict
NVNT	a SISO	5180	Ant1	13.26	0.02118	30	Pass
NVNT	a SISO	5220	Ant1	13.49	0.02234	30	Pass
NVNT	a SISO	5240	Ant1	13.17	0.02075	30	Pass
NVNT	a SISO	5260	Ant1	13.09	0.02037	24	Pass
NVNT	a SISO	5300	Ant1	13.01	0.02	24	Pass
NVNT	a SISO	5320	Ant1	12.71	0.01866	23.99	Pass
NVNT	a SISO	5500	Ant1	14.14	0.02594	24	Pass
NVNT	a SISO	5580	Ant1	14.05	0.02541	24	Pass
NVNT	a SISO	5600	Ant1	13.96	0.02489	24	Pass
NVNT	a SISO	5720	Ant1	11.66	0.01466	23.97	Pass
NVNT	a SISO	5745	Ant1	13.98	0.025	30	Pass
NVNT	a SISO	5785	Ant1	13.11	0.02046	30	Pass
NVNT	a SISO	5825	Ant1	12.38	0.0173	30	Pass
NVNT	a SISO	5180	Ant2	14.23	0.02649	30	Pass
NVNT	a SISO	5220	Ant2	13.95	0.02483	30	Pass
NVNT	a SISO	5240	Ant2	13.72	0.02355	30	Pass
NVNT	a SISO	5260	Ant2	13.78	0.02388	23.98	Pass
NVNT	a SISO	5300	Ant2	13.27	0.02123	24	Pass
NVNT	a SISO	5320	Ant2	13.32	0.02148	24	Pass
NVNT	a SISO	5500	Ant2	13.34	0.02158	23.98	Pass
NVNT	a SISO	5580	Ant2	13.74	0.02366	23.96	Pass
NVNT	a SISO	5600	Ant2	13.48	0.02228	23.84	Pass
NVNT	a SISO	5720	Ant2	11.36	0.01368	23.83	Pass
NVNT	a SISO	5745	Ant2	13.29	0.02133	30	Pass
NVNT	a SISO	5785	Ant2	12.8	0.01905	30	Pass
NVNT	a SISO	5825	Ant2	12.32	0.01706	30	Pass
NVNT	n20 SISO	5180	Ant1	13.5	0.02239	30	Pass
NVNT	n20 SISO	5220	Ant1	13.39	0.02183	30	Pass
NVNT	n20 SISO	5240	Ant1	13.02	0.02004	30	Pass
NVNT	n20 SISO	5260	Ant1	13.49	0.02234	24	Pass
NVNT	n20 SISO	5300	Ant1	13.44	0.02208	24	Pass
NVNT	n20 SISO	5320	Ant1	13.17	0.02075	24	Pass
NVNT	n20 SISO	5500	Ant1	14.14	0.02594	24	Pass



NVNT	n20 SISO	5580	Ant1	14.06	0.02547	24	Pass
NVNT	n20 SISO	5600	Ant1	13.93	0.02472	24	Pass
NVNT	n20 SISO	5720	Ant1	11.63	0.01455	24	Pass
NVNT	n20 SISO	5745	Ant1	13.92	0.02466	30	Pass
NVNT	n20 SISO	5785	Ant1	13.06	0.02023	30	Pass
NVNT	n20 SISO	5825	Ant1	12.33	0.0171	30	Pass
NVNT	n20 SISO	5180	Ant2	13.57	0.02275	30	Pass
NVNT	n20 SISO	5220	Ant2	13.28	0.02128	30	Pass
NVNT	n20 SISO	5240	Ant2	12.92	0.01959	30	Pass
NVNT	n20 SISO	5260	Ant2	14.01	0.02518	24	Pass
NVNT	n20 SISO	5300	Ant2	13.27	0.02123	24	Pass
NVNT	n20 SISO	5320	Ant2	13.3	0.02138	24	Pass
NVNT	n20 SISO	5500	Ant2	12.95	0.01972	24	Pass
NVNT	n20 SISO	5580	Ant2	12.96	0.01977	24	Pass
NVNT	n20 SISO	5600	Ant2	12.72	0.01871	24	Pass
NVNT	n20 SISO	5720	Ant2	11.41	0.01384	24	Pass
NVNT	n20 SISO	5745	Ant2	13.57	0.02275	30	Pass
NVNT	n20 SISO	5785	Ant2	13.23	0.02104	30	Pass
NVNT	n20 SISO	5825	Ant2	12.71	0.01866	30	Pass
NVNT	n20 MIMO	5180	Ant1	13.26	0.02118	30	Pass
NVNT	n20 MIMO	5180	Ant2	14.5	0.02818	30	Pass
NVNT	n20 MIMO	5180	Sum	16.93	0.04937	29.99	Pass
NVNT	n20 MIMO	5220	Ant1	13.17	0.02075	30	Pass
NVNT	n20 MIMO	5220	Ant2	14.04	0.02535	30	Pass
NVNT	n20 MIMO	5220	Sum	16.64	0.0461	29.99	Pass
NVNT	n20 MIMO	5240	Ant1	12.83	0.01919	30	Pass
NVNT	n20 MIMO	5240	Ant2	13.84	0.02421	30	Pass
NVNT	n20 MIMO	5240	Sum	16.37	0.0434	29.99	Pass
NVNT	n20 MIMO	5260	Ant1	13.01	0.02	24	Pass
NVNT	n20 MIMO	5260	Ant2	12.26	0.01683	24	Pass
NVNT	n20 MIMO	5260	Sum	15.66	0.03683	23.99	Pass
NVNT	n20 MIMO	5300	Ant1	12.91	0.01954	24	Pass
NVNT	n20 MIMO	5300	Ant2	11.73	0.01489	24	Pass
NVNT	n20 MIMO	5300	Sum	15.37	0.03444	23.99	Pass
NVNT	n20 MIMO	5320	Ant1	12.63	0.01832	24	Pass
NVNT	n20 MIMO	5320	Ant2	11.82	0.01521	24	Pass
NVNT	n20 MIMO	5320	Sum	15.25	0.03353	23.99	Pass
NVNT	n20 MIMO	5500	Ant1	14.93	0.03112	24	Pass



NVNT	n20 MIMO	5500	Ant2	11.3	0.01349	24	Pass
NVNT	n20 MIMO	5500	Sum	16.49	0.04461	23.99	Pass
NVNT	n20 MIMO	5580	Ant1	14.9	0.0309	24	Pass
NVNT	n20 MIMO	5580	Ant2	11.85	0.01531	24	Pass
NVNT	n20 MIMO	5580	Sum	16.65	0.04621	23.99	Pass
NVNT	n20 MIMO	5600	Ant1	14.81	0.03027	24	Pass
NVNT	n20 MIMO	5600	Ant2	11.58	0.01439	24	Pass
NVNT	n20 MIMO	5600	Sum	16.5	0.04466	23.99	Pass
NVNT	n20 MIMO	5720	Ant1	12.54	0.01795	24	Pass
NVNT	n20 MIMO	5720	Ant2	9.42	0.00875	24	Pass
NVNT	n20 MIMO	5720	Sum	14.27	0.0267	23.99	Pass
NVNT	n20 MIMO	5745	Ant1	14.8	0.0302	30	Pass
NVNT	n20 MIMO	5745	Ant2	11.56	0.01432	30	Pass
NVNT	n20 MIMO	5745	Sum	16.49	0.04452	29.99	Pass
NVNT	n20 MIMO	5785	Ant1	14.02	0.02523	30	Pass
NVNT	n20 MIMO	5785	Ant2	11.22	0.01324	30	Pass
NVNT	n20 MIMO	5785	Sum	15.85	0.03848	29.99	Pass
NVNT	n20 MIMO	5825	Ant1	13.29	0.02133	30	Pass
NVNT	n20 MIMO	5825	Ant2	10.77	0.01194	30	Pass
NVNT	n20 MIMO	5825	Sum	15.22	0.03327	29.99	Pass
NVNT	n40 SISO	5190	Ant1	9.41	0.00873	30	Pass
NVNT	n40 SISO	5230	Ant1	12.77	0.01892	30	Pass
NVNT	n40 SISO	5270	Ant1	13.73	0.0236	24	Pass
NVNT	n40 SISO	5310	Ant1	10.78	0.01197	24	Pass
NVNT	n40 SISO	5510	Ant1	12.41	0.01742	24	Pass
NVNT	n40 SISO	5550	Ant1	13.37	0.02173	24	Pass
NVNT	n40 SISO	5630	Ant1	13.38	0.02178	24	Pass
NVNT	n40 SISO	5710	Ant1	11.73	0.01489	24	Pass
NVNT	n40 SISO	5755	Ant1	13.91	0.0246	30	Pass
NVNT	n40 SISO	5795	Ant1	12.83	0.01919	30	Pass
NVNT	n40 SISO	5190	Ant2	10.01	0.01002	30	Pass
NVNT	n40 SISO	5230	Ant2	13.61	0.02296	30	Pass
NVNT	n40 SISO	5270	Ant2	13.57	0.02275	24	Pass
NVNT	n40 SISO	5310	Ant2	9.91	0.00979	24	Pass
NVNT	n40 SISO	5510	Ant2	8.05	0.00638	24	Pass
NVNT	n40 SISO	5550	Ant2	12.06	0.01607	24	Pass
NVNT	n40 SISO	5630	Ant2	12.67	0.01849	24	Pass
NVNT	n40 SISO	5710	Ant2	11.43	0.0139	24	Pass



NVNT	n40 SISO	5755	Ant2	13.09	0.02037	30	Pass
NVNT	n40 SISO	5795	Ant2	12.82	0.01914	30	Pass
NVNT	n40 MIMO	5190	Ant1	9.39	0.00869	30	Pass
NVNT	n40 MIMO	5190	Ant2	10.4	0.01096	30	Pass
NVNT	n40 MIMO	5190	Sum	12.93	0.01965	30	Pass
NVNT	n40 MIMO	5230	Ant1	13.17	0.02075	30	Pass
NVNT	n40 MIMO	5230	Ant2	14.41	0.02761	30	Pass
NVNT	n40 MIMO	5230	Sum	16.84	0.04835	29.99	Pass
NVNT	n40 MIMO	5270	Ant1	14.19	0.02624	24	Pass
NVNT	n40 MIMO	5270	Ant2	14.44	0.0278	24	Pass
NVNT	n40 MIMO	5270	Sum	17.33	0.05404	23.99	Pass
NVNT	n40 MIMO	5310	Ant1	10.74	0.01186	24	Pass
NVNT	n40 MIMO	5310	Ant2	10.06	0.01014	24	Pass
NVNT	n40 MIMO	5310	Sum	13.42	0.022	24	Pass
NVNT	n40 MIMO	5510	Ant1	12.33	0.0171	24	Pass
NVNT	n40 MIMO	5510	Ant2	8.57	0.00719	24	Pass
NVNT	n40 MIMO	5510	Sum	13.85	0.02429	24	Pass
NVNT	n40 MIMO	5550	Ant1	14.3	0.02692	24	Pass
NVNT	n40 MIMO	5550	Ant2	10.74	0.01186	24	Pass
NVNT	n40 MIMO	5550	Sum	15.88	0.03877	23.99	Pass
NVNT	n40 MIMO	5630	Ant1	14.29	0.02685	24	Pass
NVNT	n40 MIMO	5630	Ant2	11.4	0.0138	24	Pass
NVNT	n40 MIMO	5630	Sum	16.09	0.04066	23.99	Pass
NVNT	n40 MIMO	5710	Ant1	12.63	0.01832	24	Pass
NVNT	n40 MIMO	5710	Ant2	9.82	0.00959	24	Pass
NVNT	n40 MIMO	5710	Sum	14.46	0.02792	23.99	Pass
NVNT	n40 MIMO	5755	Ant1	14.75	0.02985	30	Pass
NVNT	n40 MIMO	5755	Ant2	11.82	0.01521	30	Pass
NVNT	n40 MIMO	5755	Sum	16.54	0.04506	29.99	Pass
NVNT	n40 MIMO	5795	Ant1	13.71	0.0235	30	Pass
NVNT	n40 MIMO	5795	Ant2	11.47	0.01403	30	Pass
NVNT	n40 MIMO	5795	Sum	15.74	0.03752	29.99	Pass
NVNT	ac20 SISO	5180	Ant1	13.61	0.02296	30	Pass
NVNT	ac20 SISO	5220	Ant1	13.42	0.02198	30	Pass
NVNT	ac20 SISO	5240	Ant1	13.08	0.02032	30	Pass
NVNT	ac20 SISO	5260	Ant1	13.57	0.02275	24	Pass
NVNT	ac20 SISO	5300	Ant1	13.54	0.02259	24	Pass
NVNT	ac20 SISO	5320	Ant1	13.23	0.02104	24	Pass



NVNT	ac20 SISO	5500	Ant1	14.11	0.02576	24	Pass
NVNT	ac20 SISO	5580	Ant1	14.08	0.02559	24	Pass
NVNT	ac20 SISO	5600	Ant1	13.95	0.02483	24	Pass
NVNT	ac20 SISO	5720	Ant1	11.64	0.01459	24	Pass
NVNT	ac20 SISO	5745	Ant1	13.95	0.02483	30	Pass
NVNT	ac20 SISO	5785	Ant1	13.07	0.02028	30	Pass
NVNT	ac20 SISO	5825	Ant1	12.36	0.01722	30	Pass
NVNT	ac20 SISO	5180	Ant2	13.98	0.025	30	Pass
NVNT	ac20 SISO	5220	Ant2	13.6	0.02291	30	Pass
NVNT	ac20 SISO	5240	Ant2	13.29	0.02133	30	Pass
NVNT	ac20 SISO	5260	Ant2	13.3	0.02138	24	Pass
NVNT	ac20 SISO	5300	Ant2	12.55	0.01799	24	Pass
NVNT	ac20 SISO	5320	Ant2	12.56	0.01803	24	Pass
NVNT	ac20 SISO	5500	Ant2	13	0.01995	24	Pass
NVNT	ac20 SISO	5580	Ant2	13	0.01995	24	Pass
NVNT	ac20 SISO	5600	Ant2	12.74	0.01879	24	Pass
NVNT	ac20 SISO	5720	Ant2	11.44	0.01393	24	Pass
NVNT	ac20 SISO	5745	Ant2	13.62	0.02301	30	Pass
NVNT	ac20 SISO	5785	Ant2	13.28	0.02128	30	Pass
NVNT	ac20 SISO	5825	Ant2	12.75	0.01884	30	Pass
NVNT	ac20 MIMO	5180	Ant1	13.38	0.02178	30	Pass
NVNT	ac20 MIMO	5180	Ant2	14.78	0.03006	30	Pass
NVNT	ac20 MIMO	5180	Sum	17.15	0.05184	29.99	Pass
NVNT	ac20 MIMO	5220	Ant1	13.19	0.02084	30	Pass
NVNT	ac20 MIMO	5220	Ant2	14.39	0.02748	30	Pass
NVNT	ac20 MIMO	5220	Sum	16.84	0.04832	29.99	Pass
NVNT	ac20 MIMO	5240	Ant1	12.82	0.01914	30	Pass
NVNT	ac20 MIMO	5240	Ant2	14.13	0.02588	30	Pass
NVNT	ac20 MIMO	5240	Sum	16.53	0.04502	29.99	Pass
NVNT	ac20 MIMO	5260	Ant1	12.97	0.01982	24	Pass
NVNT	ac20 MIMO	5260	Ant2	12.55	0.01799	24	Pass
NVNT	ac20 MIMO	5260	Sum	15.77	0.0378	23.99	Pass
NVNT	ac20 MIMO	5300	Ant1	12.88	0.01941	24	Pass
NVNT	ac20 MIMO	5300	Ant2	12	0.01585	24	Pass
NVNT	ac20 MIMO	5300	Sum	15.47	0.03526	23.99	Pass
NVNT	ac20 MIMO	5320	Ant1	12.57	0.01807	24	Pass
NVNT	ac20 MIMO	5320	Ant2	12.05	0.01603	24	Pass
NVNT	ac20 MIMO	5320	Sum	15.33	0.0341	23.99	Pass



NVNT	ac20 MIMO	5500	Ant1	14.85	0.03055	24	Pass
NVNT	ac20 MIMO	5500	Ant2	11.48	0.01406	24	Pass
NVNT	ac20 MIMO	5500	Sum	16.49	0.04461	23.99	Pass
NVNT	ac20 MIMO	5580	Ant1	14.77	0.02999	24	Pass
NVNT	ac20 MIMO	5580	Ant2	12	0.01585	24	Pass
NVNT	ac20 MIMO	5580	Sum	16.61	0.04584	23.99	Pass
NVNT	ac20 MIMO	5600	Ant1	14.71	0.02958	24	Pass
NVNT	ac20 MIMO	5600	Ant2	11.75	0.01496	24	Pass
NVNT	ac20 MIMO	5600	Sum	16.49	0.04454	23.99	Pass
NVNT	ac20 MIMO	5720	Ant1	12.49	0.01774	24	Pass
NVNT	ac20 MIMO	5720	Ant2	9.64	0.0092	24	Pass
NVNT	ac20 MIMO	5720	Sum	14.31	0.02695	23.99	Pass
NVNT	ac20 MIMO	5745	Ant1	14.74	0.02979	30	Pass
NVNT	ac20 MIMO	5745	Ant2	11.74	0.01493	30	Pass
NVNT	ac20 MIMO	5745	Sum	16.5	0.04471	29.99	Pass
NVNT	ac20 MIMO	5785	Ant1	13.93	0.02472	30	Pass
NVNT	ac20 MIMO	5785	Ant2	11.44	0.01393	30	Pass
NVNT	ac20 MIMO	5785	Sum	15.87	0.03865	29.99	Pass
NVNT	ac20 MIMO	5825	Ant1	13.26	0.02118	30	Pass
NVNT	ac20 MIMO	5825	Ant2	10.92	0.01236	30	Pass
NVNT	ac20 MIMO	5825	Sum	15.26	0.03354	29.99	Pass
NVNT	ac40 SISO	5190	Ant1	12.98	0.01986	30	Pass
NVNT	ac40 SISO	5230	Ant1	12.79	0.01901	30	Pass
NVNT	ac40 SISO	5270	Ant1	13.78	0.02388	24	Pass
NVNT	ac40 SISO	5310	Ant1	13.69	0.02339	24	Pass
NVNT	ac40 SISO	5510	Ant1	13.82	0.0241	24	Pass
NVNT	ac40 SISO	5550	Ant1	13.4	0.02188	24	Pass
NVNT	ac40 SISO	5630	Ant1	13.43	0.02203	24	Pass
NVNT	ac40 SISO	5710	Ant1	11.74	0.01493	24	Pass
NVNT	ac40 SISO	5755	Ant1	13.93	0.02472	30	Pass
NVNT	ac40 SISO	5795	Ant1	12.82	0.01914	30	Pass
NVNT	ac40 SISO	5190	Ant2	13.93	0.02472	30	Pass
NVNT	ac40 SISO	5230	Ant2	13.58	0.0228	30	Pass
NVNT	ac40 SISO	5270	Ant2	13.56	0.0227	24	Pass
NVNT	ac40 SISO	5310	Ant2	13.03	0.02009	24	Pass
NVNT	ac40 SISO	5510	Ant2	12.9	0.0195	24	Pass
NVNT	ac40 SISO	5550	Ant2	12.08	0.01614	24	Pass
NVNT	ac40 SISO	5630	Ant2	12.67	0.01849	24	Pass



NVNT	ac40 SISO	5710	Ant2	11.44	0.01393	24	Pass
NVNT	ac40 SISO	5755	Ant2	13.1	0.02042	30	Pass
NVNT	ac40 SISO	5795	Ant2	12.6	0.0182	30	Pass
NVNT	ac40 MIMO	5190	Ant1	12.99	0.01991	30	Pass
NVNT	ac40 MIMO	5190	Ant2	14.59	0.02877	30	Pass
NVNT	ac40 MIMO	5190	Sum	16.87	0.04868	29.99	Pass
NVNT	ac40 MIMO	5230	Ant1	12.76	0.01888	30	Pass
NVNT	ac40 MIMO	5230	Ant2	14.19	0.02624	30	Pass
NVNT	ac40 MIMO	5230	Sum	16.54	0.04512	29.99	Pass
NVNT	ac40 MIMO	5270	Ant1	12.59	0.01816	24	Pass
NVNT	ac40 MIMO	5270	Ant2	12.44	0.01754	24	Pass
NVNT	ac40 MIMO	5270	Sum	15.53	0.03569	23.99	Pass
NVNT	ac40 MIMO	5310	Ant1	12.75	0.01884	24	Pass
NVNT	ac40 MIMO	5310	Ant2	12.1	0.01622	24	Pass
NVNT	ac40 MIMO	5310	Sum	15.45	0.03505	23.99	Pass
NVNT	ac40 MIMO	5510	Ant1	14.71	0.02958	24	Pass
NVNT	ac40 MIMO	5510	Ant2	11.3	0.01349	24	Pass
NVNT	ac40 MIMO	5510	Sum	16.34	0.04307	23.99	Pass
NVNT	ac40 MIMO	5550	Ant1	14.19	0.02624	24	Pass
NVNT	ac40 MIMO	5550	Ant2	10.73	0.01183	24	Pass
NVNT	ac40 MIMO	5550	Sum	15.81	0.03807	23.99	Pass
NVNT	ac40 MIMO	5630	Ant1	14.2	0.0263	24	Pass
NVNT	ac40 MIMO	5630	Ant2	11.39	0.01377	24	Pass
NVNT	ac40 MIMO	5630	Sum	16.03	0.04007	23.99	Pass
NVNT	ac40 MIMO	5710	Ant1	12.58	0.01811	24	Pass
NVNT	ac40 MIMO	5710	Ant2	9.78	0.00951	24	Pass
NVNT	ac40 MIMO	5710	Sum	14.41	0.02762	23.99	Pass
NVNT	ac40 MIMO	5755	Ant1	14.72	0.02965	30	Pass
NVNT	ac40 MIMO	5755	Ant2	11.76	0.015	30	Pass
NVNT	ac40 MIMO	5755	Sum	16.5	0.04465	29.99	Pass
NVNT	ac40 MIMO	5795	Ant1	13.69	0.02339	30	Pass
NVNT	ac40 MIMO	5795	Ant2	11.43	0.0139	30	Pass
NVNT	ac40 MIMO	5795	Sum	15.72	0.03729	29.99	Pass
NVNT	ac80 SISO	5210	Ant1	9.35	0.00861	30	Pass
NVNT	ac80 SISO	5290	Ant1	10.83	0.01211	24	Pass
NVNT	ac80 SISO	5530	Ant1	12.2	0.0166	24	Pass
NVNT	ac80 SISO	5610	Ant1	13.76	0.02377	24	Pass
NVNT	ac80 SISO	5690	Ant1	12.08	0.01614	24	Pass



NVNT	ac80 SISO	5775	Ant1	13.36	0.02168	30	Pass
NVNT	ac80 SISO	5210	Ant2	9.96	0.00991	30	Pass
NVNT	ac80 SISO	5290	Ant2	9.95	0.00989	24	Pass
NVNT	ac80 SISO	5530	Ant2	7.51	0.00564	24	Pass
NVNT	ac80 SISO	5610	Ant2	13.35	0.02163	24	Pass
NVNT	ac80 SISO	5690	Ant2	11.91	0.01552	24	Pass
NVNT	ac80 SISO	5775	Ant2	13.03	0.02009	30	Pass
NVNT	ac80 MIMO	5210	Ant1	9.48	0.00887	30	Pass
NVNT	ac80 MIMO	5210	Ant2	10.29	0.01069	30	Pass
NVNT	ac80 MIMO	5210	Sum	12.91	0.01956	30	Pass
NVNT	ac80 MIMO	5290	Ant1	10.86	0.01219	24	Pass
NVNT	ac80 MIMO	5290	Ant2	10.15	0.01035	24	Pass
NVNT	ac80 MIMO	5290	Sum	13.53	0.02254	24	Pass
NVNT	ac80 MIMO	5530	Ant1	12.17	0.01648	24	Pass
NVNT	ac80 MIMO	5530	Ant2	8.01	0.00632	24	Pass
NVNT	ac80 MIMO	5530	Sum	13.58	0.02281	24	Pass
NVNT	ac80 MIMO	5610	Ant1	14.54	0.02844	24	Pass
NVNT	ac80 MIMO	5610	Ant2	11.64	0.01459	24	Pass
NVNT	ac80 MIMO	5610	Sum	16.34	0.04303	23.99	Pass
NVNT	ac80 MIMO	5690	Ant1	12.95	0.01972	24	Pass
NVNT	ac80 MIMO	5690	Ant2	10.32	0.01076	24	Pass
NVNT	ac80 MIMO	5690	Sum	14.84	0.03049	23.99	Pass
NVNT	ac80 MIMO	5775	Ant1	14.18	0.02618	30	Pass
NVNT	ac80 MIMO	5775	Ant2	11.55	0.01429	30	Pass
NVNT	ac80 MIMO	5775	Sum	16.07	0.04047	29.99	Pass
NVNT	ac160 SISO	5250	Ant1	9.51	0.00893	24	Pass
NVNT	ac160 SISO	5570	Ant1	11.79	0.0151	24	Pass
NVNT	ac160 SISO	5250	Ant2	9.74	0.00942	24	Pass
NVNT	ac160 SISO	5570	Ant2	6.92	0.00492	24	Pass
NVNT	ac160 MIMO	5250	Ant1	9.4	0.00871	24	Pass
NVNT	ac160 MIMO	5250	Ant2	10.14	0.01033	24	Pass
NVNT	ac160 MIMO	5250	Sum	12.8	0.01904	24	Pass
NVNT	ac160 MIMO	5570	Ant1	11.67	0.01469	24	Pass
NVNT	ac160 MIMO	5570	Ant2	7.45	0.00556	24	Pass
NVNT	ac160 MIMO	5570	Sum	13.06	0.02025	24	Pass
NVNT	ax20 SISO	5180	Ant1	13.21	0.02094	30	Pass
NVNT	ax20 SISO	5220	Ant1	13.08	0.02032	30	Pass
NVNT	ax20 SISO	5240	Ant1	12.75	0.01884	30	Pass



NVNT	ax20 SISO	5260	Ant1	13.23	0.02104	24	Pass
NVNT	ax20 SISO	5300	Ant1	13.16	0.0207	24	Pass
NVNT	ax20 SISO	5320	Ant1	12.9	0.0195	24	Pass
NVNT	ax20 SISO	5500	Ant1	13.82	0.0241	24	Pass
NVNT	ax20 SISO	5580	Ant1	13.77	0.02382	24	Pass
NVNT	ax20 SISO	5600	Ant1	13.68	0.02333	24	Pass
NVNT	ax20 SISO	5720	Ant1	11.42	0.01387	24	Pass
NVNT	ax20 SISO	5745	Ant1	13.65	0.02317	30	Pass
NVNT	ax20 SISO	5785	Ant1	12.78	0.01897	30	Pass
NVNT	ax20 SISO	5825	Ant1	12.05	0.01603	30	Pass
NVNT	ax20 SISO	5180	Ant2	13.67	0.02328	30	Pass
NVNT	ax20 SISO	5220	Ant2	13.32	0.02148	30	Pass
NVNT	ax20 SISO	5240	Ant2	13	0.01995	30	Pass
NVNT	ax20 SISO	5260	Ant2	13	0.01995	24	Pass
NVNT	ax20 SISO	5300	Ant2	12.25	0.01679	24	Pass
NVNT	ax20 SISO	5320	Ant2	12.3	0.01698	24	Pass
NVNT	ax20 SISO	5500	Ant2	12.72	0.01871	24	Pass
NVNT	ax20 SISO	5580	Ant2	12.72	0.01871	24	Pass
NVNT	ax20 SISO	5600	Ant2	12.47	0.01766	24	Pass
NVNT	ax20 SISO	5720	Ant2	11.07	0.01279	24	Pass
NVNT	ax20 SISO	5745	Ant2	13.31	0.02143	30	Pass
NVNT	ax20 SISO	5785	Ant2	12.98	0.01986	30	Pass
NVNT	ax20 SISO	5825	Ant2	12.46	0.01762	30	Pass
NVNT	ax20 MIMO	5180	Ant1	12.98	0.01986	30	Pass
NVNT	ax20 MIMO	5180	Ant2	14.38	0.02742	30	Pass
NVNT	ax20 MIMO	5180	Sum	16.75	0.04728	29.99	Pass
NVNT	ax20 MIMO	5220	Ant1	12.86	0.01932	30	Pass
NVNT	ax20 MIMO	5220	Ant2	14.04	0.02535	30	Pass
NVNT	ax20 MIMO	5220	Sum	16.5	0.04467	29.99	Pass
NVNT	ax20 MIMO	5240	Ant1	12.54	0.01795	30	Pass
NVNT	ax20 MIMO	5240	Ant2	13.8	0.02399	30	Pass
NVNT	ax20 MIMO	5240	Sum	16.23	0.04194	29.99	Pass
NVNT	ax20 MIMO	5260	Ant1	12.69	0.01858	24	Pass
NVNT	ax20 MIMO	5260	Ant2	12.21	0.01663	24	Pass
NVNT	ax20 MIMO	5260	Sum	15.47	0.03521	23.99	Pass
NVNT	ax20 MIMO	5300	Ant1	12.63	0.01832	24	Pass
NVNT	ax20 MIMO	5300	Ant2	11.65	0.01462	24	Pass
NVNT	ax20 MIMO	5300	Sum	15.18	0.03294	23.99	Pass



NVNT	ax20 MIMO	5320	Ant1	12.32	0.01706	24	Pass
NVNT	ax20 MIMO	5320	Ant2	11.73	0.01489	24	Pass
NVNT	ax20 MIMO	5320	Sum	15.04	0.03195	23.99	Pass
NVNT	ax20 MIMO	5500	Ant1	14.58	0.02871	24	Pass
NVNT	ax20 MIMO	5500	Ant2	11.24	0.0133	24	Pass
NVNT	ax20 MIMO	5500	Sum	16.23	0.04201	23.99	Pass
NVNT	ax20 MIMO	5580	Ant1	14.51	0.02825	24	Pass
NVNT	ax20 MIMO	5580	Ant2	11.7	0.01479	24	Pass
NVNT	ax20 MIMO	5580	Sum	16.34	0.04304	23.99	Pass
NVNT	ax20 MIMO	5600	Ant1	14.41	0.02761	24	Pass
NVNT	ax20 MIMO	5600	Ant2	11.46	0.014	24	Pass
NVNT	ax20 MIMO	5600	Sum	16.19	0.0416	23.99	Pass
NVNT	ax20 MIMO	5720	Ant1	12.21	0.01663	24	Pass
NVNT	ax20 MIMO	5720	Ant2	9.29	0.00849	24	Pass
NVNT	ax20 MIMO	5720	Sum	14	0.02513	23.99	Pass
NVNT	ax20 MIMO	5745	Ant1	14.47	0.02799	30	Pass
NVNT	ax20 MIMO	5745	Ant2	11.48	0.01406	30	Pass
NVNT	ax20 MIMO	5745	Sum	16.24	0.04205	29.99	Pass
NVNT	ax20 MIMO	5785	Ant1	13.61	0.02296	30	Pass
NVNT	ax20 MIMO	5785	Ant2	11.05	0.01274	30	Pass
NVNT	ax20 MIMO	5785	Sum	15.53	0.0357	29.99	Pass
NVNT	ax20 MIMO	5825	Ant1	12.98	0.01986	30	Pass
NVNT	ax20 MIMO	5825	Ant2	10.67	0.01167	30	Pass
NVNT	ax20 MIMO	5825	Sum	14.99	0.03153	29.99	Pass
NVNT	ax40 SISO	5190	Ant1	10.11	0.01026	30	Pass
NVNT	ax40 SISO	5230	Ant1	12.76	0.01888	30	Pass
NVNT	ax40 SISO	5270	Ant1	13.73	0.0236	24	Pass
NVNT	ax40 SISO	5310	Ant1	10.98	0.01253	24	Pass
NVNT	ax40 SISO	5510	Ant1	12.86	0.01932	24	Pass
NVNT	ax40 SISO	5550	Ant1	13.32	0.02148	24	Pass
NVNT	ax40 SISO	5630	Ant1	13.4	0.02188	24	Pass
NVNT	ax40 SISO	5710	Ant1	11.74	0.01493	24	Pass
NVNT	ax40 SISO	5755	Ant1	13.88	0.02443	30	Pass
NVNT	ax40 SISO	5795	Ant1	12.79	0.01901	30	Pass
NVNT	ax40 SISO	5190	Ant2	10.32	0.01076	30	Pass
NVNT	ax40 SISO	5230	Ant2	13.99	0.02506	30	Pass
NVNT	ax40 SISO	5270	Ant2	13.94	0.02477	24	Pass
NVNT	ax40 SISO	5310	Ant2	10.05	0.01012	24	Pass



NVNT	ax40 SISO	5510	Ant2	8.5	0.00708	24	Pass
NVNT	ax40 SISO	5550	Ant2	12.57	0.01807	24	Pass
NVNT	ax40 SISO	5630	Ant2	13.12	0.02051	24	Pass
NVNT	ax40 SISO	5710	Ant2	11.71	0.01483	24	Pass
NVNT	ax40 SISO	5755	Ant2	13.58	0.0228	30	Pass
NVNT	ax40 SISO	5795	Ant2	13.05	0.02018	30	Pass
NVNT	ax40 MIMO	5190	Ant1	9.96	0.00991	30	Pass
NVNT	ax40 MIMO	5190	Ant2	10.81	0.01205	30	Pass
NVNT	ax40 MIMO	5190	Sum	13.42	0.02196	30	Pass
NVNT	ax40 MIMO	5230	Ant1	13.17	0.02075	30	Pass
NVNT	ax40 MIMO	5230	Ant2	14.48	0.02805	30	Pass
NVNT	ax40 MIMO	5230	Sum	16.88	0.0488	29.99	Pass
NVNT	ax40 MIMO	5270	Ant1	13.02	0.02004	24	Pass
NVNT	ax40 MIMO	5270	Ant2	12.81	0.0191	24	Pass
NVNT	ax40 MIMO	5270	Sum	15.93	0.03914	23.99	Pass
NVNT	ax40 MIMO	5310	Ant1	10.95	0.01245	24	Pass
NVNT	ax40 MIMO	5310	Ant2	10.42	0.01102	24	Pass
NVNT	ax40 MIMO	5310	Sum	13.7	0.02346	24	Pass
NVNT	ax40 MIMO	5510	Ant1	12.72	0.01871	24	Pass
NVNT	ax40 MIMO	5510	Ant2	9	0.00794	24	Pass
NVNT	ax40 MIMO	5510	Sum	14.26	0.02665	24	Pass
NVNT	ax40 MIMO	5550	Ant1	14.48	0.02805	24	Pass
NVNT	ax40 MIMO	5550	Ant2	10.93	0.01239	24	Pass
NVNT	ax40 MIMO	5550	Sum	16.07	0.04044	23.99	Pass
NVNT	ax40 MIMO	5630	Ant1	14.6	0.02884	24	Pass
NVNT	ax40 MIMO	5630	Ant2	11.68	0.01472	24	Pass
NVNT	ax40 MIMO	5630	Sum	16.39	0.04356	23.99	Pass
NVNT	ax40 MIMO	5710	Ant1	12.99	0.01991	24	Pass
NVNT	ax40 MIMO	5710	Ant2	10.32	0.01076	24	Pass
NVNT	ax40 MIMO	5710	Sum	14.87	0.03067	23.99	Pass
NVNT	ax40 MIMO	5755	Ant1	15.13	0.03258	30	Pass
NVNT	ax40 MIMO	5755	Ant2	12.13	0.01633	30	Pass
NVNT	ax40 MIMO	5755	Sum	16.89	0.04891	29.99	Pass
NVNT	ax40 MIMO	5795	Ant1	14.09	0.02564	30	Pass
NVNT	ax40 MIMO	5795	Ant2	11.75	0.01496	30	Pass
NVNT	ax40 MIMO	5795	Sum	16.09	0.04061	29.99	Pass
NVNT	ax80 SISO	5210	Ant1	8.7	0.00741	30	Pass
NVNT	ax80 SISO	5290	Ant1	9.83	0.00962	24	Pass



NVNT	ax80 SISO	5530	Ant1	11.55	0.01429	24	Pass
NVNT	ax80 SISO	5610	Ant1	13.91	0.0246	24	Pass
NVNT	ax80 SISO	5690	Ant1	12.25	0.01679	24	Pass
NVNT	ax80 SISO	5775	Ant1	13.54	0.02259	30	Pass
NVNT	ax80 SISO	5210	Ant2	9.54	0.00899	30	Pass
NVNT	ax80 SISO	5290	Ant2	9.19	0.0083	24	Pass
NVNT	ax80 SISO	5530	Ant2	6.81	0.0048	24	Pass
NVNT	ax80 SISO	5610	Ant2	13.55	0.02265	24	Pass
NVNT	ax80 SISO	5690	Ant2	12.1	0.01622	24	Pass
NVNT	ax80 SISO	5775	Ant2	13.19	0.02084	30	Pass
NVNT	ax80 MIMO	5210	Ant1	8.69	0.0074	30	Pass
NVNT	ax80 MIMO	5210	Ant2	9.94	0.00986	30	Pass
NVNT	ax80 MIMO	5210	Sum	12.37	0.01726	30	Pass
NVNT	ax80 MIMO	5290	Ant1	9.76	0.00946	24	Pass
NVNT	ax80 MIMO	5290	Ant2	9.93	0.00984	24	Pass
NVNT	ax80 MIMO	5290	Sum	12.86	0.0193	24	Pass
NVNT	ax80 MIMO	5530	Ant1	11.48	0.01406	24	Pass
NVNT	ax80 MIMO	5530	Ant2	7.33	0.00541	24	Pass
NVNT	ax80 MIMO	5530	Sum	12.89	0.01947	24	Pass
NVNT	ax80 MIMO	5610	Ant1	14.68	0.02938	24	Pass
NVNT	ax80 MIMO	5610	Ant2	11.82	0.01521	24	Pass
NVNT	ax80 MIMO	5610	Sum	16.49	0.04458	23.99	Pass
NVNT	ax80 MIMO	5690	Ant1	13.08	0.02032	24	Pass
NVNT	ax80 MIMO	5690	Ant2	10.59	0.01146	24	Pass
NVNT	ax80 MIMO	5690	Sum	15.02	0.03178	23.99	Pass
NVNT	ax80 MIMO	5775	Ant1	14.34	0.02716	30	Pass
NVNT	ax80 MIMO	5775	Ant2	11.66	0.01466	30	Pass
NVNT	ax80 MIMO	5775	Sum	16.21	0.04182	29.99	Pass
NVNT	ax160 SISO	5250	Ant1	9.26	0.00843	24	Pass
NVNT	ax160 SISO	5570	Ant1	11.61	0.01449	24	Pass
NVNT	ax160 SISO	5250	Ant2	9.51	0.00893	24	Pass
NVNT	ax160 SISO	5570	Ant2	6.82	0.00481	24	Pass
NVNT	ax160 MIMO	5250	Ant1	9.2	0.00832	24	Pass
NVNT	ax160 MIMO	5250	Ant2	10.01	0.01002	24	Pass
NVNT	ax160 MIMO	5250	Sum	12.63	0.01834	24	Pass
NVNT	ax160 MIMO	5570	Ant1	11.49	0.01409	24	Pass
NVNT	ax160 MIMO	5570	Ant2	7.32	0.0054	24	Pass
NVNT	ax160 MIMO	5570	Sum	12.9	0.01949	24	Pass



NVNT	ax20 26@0 SISO	5180	Ant1	13.41	0.02193	30	Pass
NVNT	ax20 26@0 SISO	5220	Ant1	13.31	0.02143	30	Pass
NVNT	ax20 26@0 SISO	5240	Ant1	13.04	0.02014	30	Pass
NVNT	ax20 26@0 SISO	5260	Ant1	13.1	0.02042	24	Pass
NVNT	ax20 26@0 SISO	5300	Ant1	13.17	0.02075	24	Pass
NVNT	ax20 26@0 SISO	5320	Ant1	12.88	0.01941	23.89	Pass
NVNT	ax20 26@0 SISO	5500	Ant1	13.06	0.02023	24	Pass
NVNT	ax20 26@0 SISO	5580	Ant1	13.14	0.02061	24	Pass
NVNT	ax20 26@0 SISO	5600	Ant1	12.98	0.01986	23.73	Pass
NVNT	ax20 26@0 SISO	5720	Ant1	10.78	0.01197	24	Pass
NVNT	ax20 26@0 SISO	5745	Ant1	13.02	0.02004	30	Pass
NVNT	ax20 26@0 SISO	5785	Ant1	12.23	0.01671	30	Pass
NVNT	ax20 26@0 SISO	5825	Ant1	11.51	0.01416	30	Pass
NVNT	ax20 26@0 SISO	5180	Ant2	14.14	0.02594	30	Pass
NVNT	ax20 26@0 SISO	5220	Ant2	13.9	0.02455	30	Pass
NVNT	ax20 26@0 SISO	5240	Ant2	13.62	0.02301	30	Pass
NVNT	ax20 26@0 SISO	5260	Ant2	13.67	0.02328	24	Pass
NVNT	ax20 26@0 SISO	5300	Ant2	13.15	0.02065	23.91	Pass
NVNT	ax20 26@0 SISO	5320	Ant2	13.24	0.02109	23.84	Pass
NVNT	ax20 26@0 SISO	5500	Ant2	12.91	0.01954	24	Pass
NVNT	ax20 26@0 SISO	5580	Ant2	13.24	0.02109	23.77	Pass
NVNT	ax20 26@0 SISO	5600	Ant2	13.13	0.02056	24	Pass
NVNT	ax20 26@0 SISO	5720	Ant2	7.47	0.00558	23.87	Pass
NVNT	ax20 26@0 SISO	5745	Ant2	13.01	0.02	30	Pass
NVNT	ax20 26@0 SISO	5785	Ant2	12.45	0.01758	30	Pass
NVNT	ax20 26@0 SISO	5825	Ant2	11.98	0.01578	30	Pass
NVNT	ax20 26@0 MIMO	5180	Ant1	13.65	0.02317	30	Pass
NVNT	ax20 26@0 MIMO	5180	Ant2	14.58	0.02871	30	Pass
NVNT	ax20 26@0 MIMO	5180	Sum	17.15	0.05188	29.99	Pass
NVNT	ax20 26@0 MIMO	5220	Ant1	13.61	0.02296	30	Pass
NVNT	ax20 26@0 MIMO	5220	Ant2	14.23	0.02649	30	Pass
NVNT	ax20 26@0 MIMO	5220	Sum	16.94	0.04945	29.99	Pass
NVNT	ax20 26@0 MIMO	5240	Ant1	13.33	0.02153	30	Pass
NVNT	ax20 26@0 MIMO	5240	Ant2	13.97	0.02495	30	Pass
NVNT	ax20 26@0 MIMO	5240	Sum	16.67	0.04647	29.99	Pass
NVNT	ax20 26@0 MIMO	5260	Ant1	13.25	0.02113	24	Pass
NVNT	ax20 26@0 MIMO	5260	Ant2	12.4	0.01738	24	Pass
NVNT	ax20 26@0 MIMO	5260	Sum	15.86	0.03851	23.99	Pass



NVNT	ax20 26@0 MIMO	5300	Ant1	13.24	0.02109	24	Pass
NVNT	ax20 26@0 MIMO	5300	Ant2	11.8	0.01514	24	Pass
NVNT	ax20 26@0 MIMO	5300	Sum	15.59	0.03622	23.99	Pass
NVNT	ax20 26@0 MIMO	5320	Ant1	12.99	0.01991	24	Pass
NVNT	ax20 26@0 MIMO	5320	Ant2	11.95	0.01567	24	Pass
NVNT	ax20 26@0 MIMO	5320	Sum	15.51	0.03557	23.99	Pass
NVNT	ax20 26@0 MIMO	5500	Ant1	15.12	0.03251	24	Pass
NVNT	ax20 26@0 MIMO	5500	Ant2	11.58	0.01439	24	Pass
NVNT	ax20 26@0 MIMO	5500	Sum	16.71	0.0469	23.99	Pass
NVNT	ax20 26@0 MIMO	5580	Ant1	15.12	0.03251	24	Pass
NVNT	ax20 26@0 MIMO	5580	Ant2	12.12	0.01629	24	Pass
NVNT	ax20 26@0 MIMO	5580	Sum	16.88	0.0488	23.99	Pass
NVNT	ax20 26@0 MIMO	5600	Ant1	14.97	0.03141	24	Pass
NVNT	ax20 26@0 MIMO	5600	Ant2	11.89	0.01545	24	Pass
NVNT	ax20 26@0 MIMO	5600	Sum	16.71	0.04686	23.99	Pass
NVNT	ax20 26@0 MIMO	5720	Ant1	10.93	0.01239	24	Pass
NVNT	ax20 26@0 MIMO	5720	Ant2	7.78	0.006	24	Pass
NVNT	ax20 26@0 MIMO	5720	Sum	12.65	0.01839	24	Pass
NVNT	ax20 26@0 MIMO	5745	Ant1	15.02	0.03177	30	Pass
NVNT	ax20 26@0 MIMO	5745	Ant2	11.66	0.01466	30	Pass
NVNT	ax20 26@0 MIMO	5745	Sum	16.67	0.04642	29.99	Pass
NVNT	ax20 26@0 MIMO	5785	Ant1	14.32	0.02704	30	Pass
NVNT	ax20 26@0 MIMO	5785	Ant2	11.24	0.0133	30	Pass
NVNT	ax20 26@0 MIMO	5785	Sum	16.06	0.04034	29.99	Pass
NVNT	ax20 26@0 MIMO	5825	Ant1	13.67	0.02328	30	Pass
NVNT	ax20 26@0 MIMO	5825	Ant2	10.82	0.01208	30	Pass
NVNT	ax20 26@0 MIMO	5825	Sum	15.49	0.03536	29.99	Pass
NVNT	ax20 52@37 SISO	5180	Ant1	13.17	0.02075	30	Pass
NVNT	ax20 52@37 SISO	5220	Ant1	13.09	0.02037	30	Pass
NVNT	ax20 52@37 SISO	5240	Ant1	12.78	0.01897	30	Pass
NVNT	ax20 52@37 SISO	5260	Ant1	12.85	0.01928	24	Pass
NVNT	ax20 52@37 SISO	5300	Ant1	12.9	0.0195	24	Pass
NVNT	ax20 52@37 SISO	5320	Ant1	12.63	0.01832	24	Pass
NVNT	ax20 52@37 SISO	5500	Ant1	12.8	0.01905	24	Pass
NVNT	ax20 52@37 SISO	5580	Ant1	12.83	0.01919	24	Pass
NVNT	ax20 52@37 SISO	5600	Ant1	12.74	0.01879	24	Pass
NVNT	ax20 52@37 SISO	5720	Ant1	10.63	0.01156	24	Pass
NVNT	ax20 52@37 SISO	5745	Ant1	12.78	0.01897	30	Pass



NVNT	ax20 52@37 SISO	5785	Ant1	12.02	0.01592	30	Pass
NVNT	ax20 52@37 SISO	5825	Ant1	11.27	0.0134	30	Pass
NVNT	ax20 52@37 SISO	5180	Ant2	13.97	0.02495	30	Pass
NVNT	ax20 52@37 SISO	5220	Ant2	13.72	0.02355	30	Pass
NVNT	ax20 52@37 SISO	5240	Ant2	13.42	0.02198	30	Pass
NVNT	ax20 52@37 SISO	5260	Ant2	13.49	0.02234	24	Pass
NVNT	ax20 52@37 SISO	5300	Ant2	12.98	0.01986	24	Pass
NVNT	ax20 52@37 SISO	5320	Ant2	13.06	0.02023	24	Pass
NVNT	ax20 52@37 SISO	5500	Ant2	12.58	0.01811	24	Pass
NVNT	ax20 52@37 SISO	5580	Ant2	12.98	0.01986	23.8	Pass
NVNT	ax20 52@37 SISO	5600	Ant2	12.87	0.01936	24	Pass
NVNT	ax20 52@37 SISO	5720	Ant2	10.57	0.0114	24	Pass
NVNT	ax20 52@37 SISO	5745	Ant2	12.66	0.01845	30	Pass
NVNT	ax20 52@37 SISO	5785	Ant2	12.14	0.01637	30	Pass
NVNT	ax20 52@37 SISO	5825	Ant2	11.61	0.01449	30	Pass
NVNT	ax20 52@37 MIMO	5180	Ant1	13.36	0.02168	30	Pass
NVNT	ax20 52@37 MIMO	5180	Ant2	14.33	0.0271	30	Pass
NVNT	ax20 52@37 MIMO	5180	Sum	16.88	0.04878	29.99	Pass
NVNT	ax20 52@37 MIMO	5220	Ant1	13.31	0.02143	30	Pass
NVNT	ax20 52@37 MIMO	5220	Ant2	14.05	0.02541	30	Pass
NVNT	ax20 52@37 MIMO	5220	Sum	16.71	0.04684	29.99	Pass
NVNT	ax20 52@37 MIMO	5240	Ant1	13	0.01995	30	Pass
NVNT	ax20 52@37 MIMO	5240	Ant2	13.77	0.02382	30	Pass
NVNT	ax20 52@37 MIMO	5240	Sum	16.41	0.04378	29.99	Pass
NVNT	ax20 52@37 MIMO	5260	Ant1	13.03	0.02009	24	Pass
NVNT	ax20 52@37 MIMO	5260	Ant2	12.18	0.01652	24	Pass
NVNT	ax20 52@37 MIMO	5260	Sum	15.64	0.03661	23.99	Pass
NVNT	ax20 52@37 MIMO	5300	Ant1	12.95	0.01972	24	Pass
NVNT	ax20 52@37 MIMO	5300	Ant2	11.58	0.01439	24	Pass
NVNT	ax20 52@37 MIMO	5300	Sum	15.33	0.03411	23.99	Pass
NVNT	ax20 52@37 MIMO	5320	Ant1	12.7	0.01862	24	Pass
NVNT	ax20 52@37 MIMO	5320	Ant2	11.66	0.01466	24	Pass
NVNT	ax20 52@37 MIMO	5320	Sum	15.22	0.03328	23.99	Pass
NVNT	ax20 52@37 MIMO	5500	Ant1	14.95	0.03126	24	Pass
NVNT	ax20 52@37 MIMO	5500	Ant2	11.3	0.01349	24	Pass
NVNT	ax20 52@37 MIMO	5500	Sum	16.51	0.04475	23.99	Pass
NVNT	ax20 52@37 MIMO	5580	Ant1	14.91	0.03097	23.8	Pass
NVNT	ax20 52@37 MIMO	5580	Ant2	11.8	0.01514	23.8	Pass



NVNT	ax20 52@37 MIMO	5580	Sum	16.64	0.04611	23.79	Pass
NVNT	ax20 52@37 MIMO	5600	Ant1	14.87	0.03069	24	Pass
NVNT	ax20 52@37 MIMO	5600	Ant2	11.66	0.01466	24	Pass
NVNT	ax20 52@37 MIMO	5600	Sum	16.57	0.04535	23.99	Pass
NVNT	ax20 52@37 MIMO	5720	Ant1	12.75	0.01884	24	Pass
NVNT	ax20 52@37 MIMO	5720	Ant2	9.48	0.00887	24	Pass
NVNT	ax20 52@37 MIMO	5720	Sum	14.43	0.02771	23.99	Pass
NVNT	ax20 52@37 MIMO	5745	Ant1	14.8	0.0302	30	Pass
NVNT	ax20 52@37 MIMO	5745	Ant2	11.47	0.01403	30	Pass
NVNT	ax20 52@37 MIMO	5745	Sum	16.46	0.04423	29.99	Pass
NVNT	ax20 52@37 MIMO	5785	Ant1	14.09	0.02564	30	Pass
NVNT	ax20 52@37 MIMO	5785	Ant2	11	0.01259	30	Pass
NVNT	ax20 52@37 MIMO	5785	Sum	15.82	0.03823	29.99	Pass
NVNT	ax20 52@37 MIMO	5825	Ant1	13.44	0.02208	30	Pass
NVNT	ax20 52@37 MIMO	5825	Ant2	10.6	0.01148	30	Pass
NVNT	ax20 52@37 MIMO	5825	Sum	15.26	0.03356	29.99	Pass
NVNT	ax20 106@53 SISO	5180	Ant1	13.09	0.02037	30	Pass
NVNT	ax20 106@53 SISO	5220	Ant1	13.06	0.02023	30	Pass
NVNT	ax20 106@53 SISO	5240	Ant1	12.74	0.01879	30	Pass
NVNT	ax20 106@53 SISO	5260	Ant1	12.83	0.01919	24	Pass
NVNT	ax20 106@53 SISO	5300	Ant1	12.86	0.01932	24	Pass
NVNT	ax20 106@53 SISO	5320	Ant1	12.56	0.01803	24	Pass
NVNT	ax20 106@53 SISO	5500	Ant1	12.74	0.01879	24	Pass
NVNT	ax20 106@53 SISO	5580	Ant1	12.76	0.01888	24	Pass
NVNT	ax20 106@53 SISO	5600	Ant1	12.67	0.01849	24	Pass
NVNT	ax20 106@53 SISO	5720	Ant1	10.63	0.01156	24	Pass
NVNT	ax20 106@53 SISO	5745	Ant1	12.69	0.01858	30	Pass
NVNT	ax20 106@53 SISO	5785	Ant1	11.9	0.01549	30	Pass
NVNT	ax20 106@53 SISO	5825	Ant1	11.19	0.01315	30	Pass
NVNT	ax20 106@53 SISO	5180	Ant2	13.9	0.02455	30	Pass
NVNT	ax20 106@53 SISO	5220	Ant2	13.62	0.02301	30	Pass
NVNT	ax20 106@53 SISO	5240	Ant2	13.37	0.02173	30	Pass
NVNT	ax20 106@53 SISO	5260	Ant2	13.44	0.02208	24	Pass
NVNT	ax20 106@53 SISO	5300	Ant2	12.92	0.01959	24	Pass
NVNT	ax20 106@53 SISO	5320	Ant2	13.01	0.02	24	Pass
NVNT	ax20 106@53 SISO	5500	Ant2	12.48	0.0177	24	Pass
NVNT	ax20 106@53 SISO	5580	Ant2	12.9	0.0195	24	Pass
NVNT	ax20 106@53 SISO	5600	Ant2	12.73	0.01875	24	Pass



NVNT	ax20 106@53 SISO	5720	Ant2	10.5	0.01122	24	Pass
NVNT	ax20 106@53 SISO	5745	Ant2	12.54	0.01795	30	Pass
NVNT	ax20 106@53 SISO	5785	Ant2	12.04	0.016	30	Pass
NVNT	ax20 106@53 SISO	5825	Ant2	11.51	0.01416	30	Pass
NVNT	ax20 106@53 MIMO	5180	Ant1	13.13	0.02056	30	Pass
NVNT	ax20 106@53 MIMO	5180	Ant2	14.37	0.02735	30	Pass
NVNT	ax20 106@53 MIMO	5180	Sum	16.8	0.04791	29.99	Pass
NVNT	ax20 106@53 MIMO	5220	Ant1	13.08	0.02032	30	Pass
NVNT	ax20 106@53 MIMO	5220	Ant2	14.07	0.02553	30	Pass
NVNT	ax20 106@53 MIMO	5220	Sum	16.61	0.04585	29.99	Pass
NVNT	ax20 106@53 MIMO	5240	Ant1	12.7	0.01862	30	Pass
NVNT	ax20 106@53 MIMO	5240	Ant2	13.75	0.02371	30	Pass
NVNT	ax20 106@53 MIMO	5240	Sum	16.27	0.04233	29.99	Pass
NVNT	ax20 106@53 MIMO	5260	Ant1	12.81	0.0191	24	Pass
NVNT	ax20 106@53 MIMO	5260	Ant2	12.22	0.01667	24	Pass
NVNT	ax20 106@53 MIMO	5260	Sum	15.54	0.03577	23.99	Pass
NVNT	ax20 106@53 MIMO	5300	Ant1	12.79	0.01901	24	Pass
NVNT	ax20 106@53 MIMO	5300	Ant2	11.69	0.01476	24	Pass
NVNT	ax20 106@53 MIMO	5300	Sum	15.29	0.03377	23.99	Pass
NVNT	ax20 106@53 MIMO	5320	Ant1	12.57	0.01807	24	Pass
NVNT	ax20 106@53 MIMO	5320	Ant2	11.8	0.01514	24	Pass
NVNT	ax20 106@53 MIMO	5320	Sum	15.21	0.03321	23.99	Pass
NVNT	ax20 106@53 MIMO	5500	Ant1	14.85	0.03055	24	Pass
NVNT	ax20 106@53 MIMO	5500	Ant2	11.47	0.01403	24	Pass
NVNT	ax20 106@53 MIMO	5500	Sum	16.49	0.04458	23.99	Pass
NVNT	ax20 106@53 MIMO	5580	Ant1	14.83	0.03041	24	Pass
NVNT	ax20 106@53 MIMO	5580	Ant2	11.96	0.0157	24	Pass
NVNT	ax20 106@53 MIMO	5580	Sum	16.64	0.04611	23.99	Pass
NVNT	ax20 106@53 MIMO	5600	Ant1	14.74	0.02979	24	Pass
NVNT	ax20 106@53 MIMO	5600	Ant2	11.77	0.01503	24	Pass
NVNT	ax20 106@53 MIMO	5600	Sum	16.51	0.04482	23.99	Pass
NVNT	ax20 106@53 MIMO	5720	Ant1	12.59	0.01816	24	Pass
NVNT	ax20 106@53 MIMO	5720	Ant2	9.66	0.00925	24	Pass
NVNT	ax20 106@53 MIMO	5720	Sum	14.38	0.0274	23.99	Pass
NVNT	ax20 106@53 MIMO	5745	Ant1	14.71	0.02958	30	Pass
NVNT	ax20 106@53 MIMO	5745	Ant2	11.67	0.01469	30	Pass
NVNT	ax20 106@53 MIMO	5745	Sum	16.46	0.04427	29.99	Pass
NVNT	ax20 106@53 MIMO	5785	Ant1	13.96	0.02489	30	Pass



NVNT	ax20 106@53 MIMO	5785	Ant2	11.26	0.01337	30	Pass
NVNT	ax20 106@53 MIMO	5785	Sum	15.83	0.03825	29.99	Pass
NVNT	ax20 106@53 MIMO	5825	Ant1	13.22	0.02099	30	Pass
NVNT	ax20 106@53 MIMO	5825	Ant2	10.78	0.01197	30	Pass
NVNT	ax20 106@53 MIMO	5825	Sum	15.18	0.03296	29.99	Pass
NVNT	ax40 242@61 SISO	5190	Ant1	12.93	0.01963	30	Pass
NVNT	ax40 242@61 SISO	5230	Ant1	12.78	0.01897	30	Pass
NVNT	ax40 242@61 SISO	5270	Ant1	13.56	0.0227	24	Pass
NVNT	ax40 242@61 SISO	5310	Ant1	13.65	0.02317	24	Pass
NVNT	ax40 242@61 SISO	5510	Ant1	12.54	0.01795	24	Pass
NVNT	ax40 242@61 SISO	5550	Ant1	12.17	0.01648	24	Pass
NVNT	ax40 242@61 SISO	5630	Ant1	12.2	0.0166	24	Pass
NVNT	ax40 242@61 SISO	5710	Ant1	10.93	0.01239	24	Pass
NVNT	ax40 242@61 SISO	5755	Ant1	12.75	0.01884	30	Pass
NVNT	ax40 242@61 SISO	5795	Ant1	11.68	0.01472	30	Pass
NVNT	ax40 242@61 SISO	5190	Ant2	13.84	0.02421	30	Pass
NVNT	ax40 242@61 SISO	5230	Ant2	13.47	0.02223	30	Pass
NVNT	ax40 242@61 SISO	5270	Ant2	13.48	0.02228	24	Pass
NVNT	ax40 242@61 SISO	5310	Ant2	12.89	0.01945	24	Pass
NVNT	ax40 242@61 SISO	5510	Ant2	12.2	0.0166	24	Pass
NVNT	ax40 242@61 SISO	5550	Ant2	11.51	0.01416	24	Pass
NVNT	ax40 242@61 SISO	5630	Ant2	12.16	0.01644	24	Pass
NVNT	ax40 242@61 SISO	5710	Ant2	10.75	0.01189	24	Pass
NVNT	ax40 242@61 SISO	5755	Ant2	12.48	0.0177	30	Pass
NVNT	ax40 242@61 SISO	5795	Ant2	11.97	0.01574	30	Pass
NVNT	ax40 242@61 MIMO	5190	Ant1	13.24	0.02109	30	Pass
NVNT	ax40 242@61 MIMO	5190	Ant2	14.77	0.02999	30	Pass
NVNT	ax40 242@61 MIMO	5190	Sum	17.08	0.05108	29.99	Pass
NVNT	ax40 242@61 MIMO	5230	Ant1	12.97	0.01982	30	Pass
NVNT	ax40 242@61 MIMO	5230	Ant2	14.33	0.0271	30	Pass
NVNT	ax40 242@61 MIMO	5230	Sum	16.71	0.04692	29.99	Pass
NVNT	ax40 242@61 MIMO	5270	Ant1	12.63	0.01832	24	Pass
NVNT	ax40 242@61 MIMO	5270	Ant2	12.67	0.01849	24	Pass
NVNT	ax40 242@61 MIMO	5270	Sum	15.66	0.03682	23.99	Pass
NVNT	ax40 242@61 MIMO	5310	Ant1	12.67	0.01849	24	Pass
NVNT	ax40 242@61 MIMO	5310	Ant2	12.1	0.01622	24	Pass
NVNT	ax40 242@61 MIMO	5310	Sum	15.4	0.03471	23.99	Pass
NVNT	ax40 242@61 MIMO	5510	Ant1	14.79	0.03013	24	Pass



NVNT	ax40 242@61 MIMO	5510	Ant2	11.65	0.01462	24	Pass
NVNT	ax40 242@61 MIMO	5510	Sum	16.51	0.04475	23.99	Pass
NVNT	ax40 242@61 MIMO	5550	Ant1	14.39	0.02748	24	Pass
NVNT	ax40 242@61 MIMO	5550	Ant2	11.03	0.01268	24	Pass
NVNT	ax40 242@61 MIMO	5550	Sum	16.04	0.04016	23.99	Pass
NVNT	ax40 242@61 MIMO	5630	Ant1	14.43	0.02773	24	Pass
NVNT	ax40 242@61 MIMO	5630	Ant2	11.63	0.01455	24	Pass
NVNT	ax40 242@61 MIMO	5630	Sum	16.26	0.04229	23.99	Pass
NVNT	ax40 242@61 MIMO	5710	Ant1	12.83	0.01919	24	Pass
NVNT	ax40 242@61 MIMO	5710	Ant2	10.36	0.01086	24	Pass
NVNT	ax40 242@61 MIMO	5710	Sum	14.78	0.03005	23.99	Pass
NVNT	ax40 242@61 MIMO	5755	Ant1	14.88	0.03076	30	Pass
NVNT	ax40 242@61 MIMO	5755	Ant2	12.07	0.01611	30	Pass
NVNT	ax40 242@61 MIMO	5755	Sum	16.71	0.04687	29.99	Pass
NVNT	ax40 242@61 MIMO	5795	Ant1	13.86	0.02432	30	Pass
NVNT	ax40 242@61 MIMO	5795	Ant2	11.7	0.01479	30	Pass
NVNT	ax40 242@61 MIMO	5795	Sum	15.92	0.03911	29.99	Pass
NVNT	ax80 484@65 SISO	5210	Ant1	12.84	0.01923	30	Pass
NVNT	ax80 484@65 SISO	5290	Ant1	13.58	0.0228	24	Pass
NVNT	ax80 484@65 SISO	5530	Ant1	12.51	0.01782	24	Pass
NVNT	ax80 484@65 SISO	5610	Ant1	12.9	0.0195	24	Pass
NVNT	ax80 484@65 SISO	5690	Ant1	11.36	0.01368	24	Pass
NVNT	ax80 484@65 SISO	5775	Ant1	12.49	0.01774	30	Pass
NVNT	ax80 484@65 SISO	5210	Ant2	13.86	0.02432	30	Pass
NVNT	ax80 484@65 SISO	5290	Ant2	13.25	0.02113	24	Pass
NVNT	ax80 484@65 SISO	5530	Ant2	12.9	0.0195	24	Pass
NVNT	ax80 484@65 SISO	5610	Ant2	13.68	0.02333	24	Pass
NVNT	ax80 484@65 SISO	5690	Ant2	12.21	0.01663	24	Pass
NVNT	ax80 484@65 SISO	5775	Ant2	13.15	0.02065	30	Pass
NVNT	ax80 484@65 MIMO	5210	Ant1	12.96	0.01977	30	Pass
NVNT	ax80 484@65 MIMO	5210	Ant2	14.54	0.02844	30	Pass
NVNT	ax80 484@65 MIMO	5210	Sum	16.83	0.04821	29.99	Pass
NVNT	ax80 484@65 MIMO	5290	Ant1	12.54	0.01795	24	Pass
NVNT	ax80 484@65 MIMO	5290	Ant2	12.28	0.0169	24	Pass
NVNT	ax80 484@65 MIMO	5290	Sum	15.42	0.03485	23.99	Pass
NVNT	ax80 484@65 MIMO	5530	Ant1	14.74	0.02979	24	Pass
NVNT	ax80 484@65 MIMO	5530	Ant2	11.45	0.01396	24	Pass
NVNT	ax80 484@65 MIMO	5530	Sum	16.41	0.04375	23.99	Pass



NVNT	ax80 484@65 MIMO	5610	Ant1	14.82	0.03034	24	Pass
NVNT	ax80 484@65 MIMO	5610	Ant2	12.2	0.0166	24	Pass
NVNT	ax80 484@65 MIMO	5610	Sum	16.71	0.04693	23.99	Pass
NVNT	ax80 484@65 MIMO	5690	Ant1	13.3	0.02138	24	Pass
NVNT	ax80 484@65 MIMO	5690	Ant2	11.17	0.01309	24	Pass
NVNT	ax80 484@65 MIMO	5690	Sum	15.37	0.03447	23.99	Pass
NVNT	ax80 484@65 MIMO	5775	Ant1	14.54	0.02844	30	Pass
NVNT	ax80 484@65 MIMO	5775	Ant2	11.98	0.01578	30	Pass
NVNT	ax80 484@65 MIMO	5775	Sum	16.46	0.04422	29.99	Pass
NVNT	ax160 996@67 SISO	5250	Ant1	8.31	0.00678	24	Pass
NVNT	ax160 996@67 SISO	5570	Ant1	8.73	0.00746	24	Pass
NVNT	ax160 996@67 SISO	5250	Ant2	8.96	0.00787	24	Pass
NVNT	ax160 996@67 SISO	5570	Ant2	4.49	0.00281	24	Pass
NVNT	ax160 996@67 MIMO	5250	Ant1	8.3	0.00676	24	Pass
NVNT	ax160 996@67 MIMO	5250	Ant2	9.01	0.00796	24	Pass
NVNT	ax160 996@67 MIMO	5250	Sum	11.68	0.01472	24	Pass
NVNT	ax160 996@67 MIMO	5570	Ant1	8.7	0.00741	24	Pass
NVNT	ax160 996@67 MIMO	5570	Ant2	4.55	0.00285	24	Pass
NVNT	ax160 996@67 MIMO	5570	Sum	10.11	0.01026	24	Pass

**A.3. Emission Bandwidth**

Condition	Mode	Frequency (MHz)	Antenna	-26 dB Bandwidth (MHz)
NVNT	a SISO	5180	Ant1	19.777
NVNT	a SISO	5220	Ant1	18.932
NVNT	a SISO	5240	Ant1	19.248
NVNT	a SISO	5260	Ant1	20.783
NVNT	a SISO	5300	Ant1	22.737
NVNT	a SISO	5320	Ant1	19.912
NVNT	a SISO	5500	Ant1	29.918
NVNT	a SISO	5580	Ant1	29.698
NVNT	a SISO	5600	Ant1	28.65
NVNT	a SISO	5720	Ant1	19.812
NVNT	a SISO	5180	Ant2	22.942
NVNT	a SISO	5220	Ant2	22.055
NVNT	a SISO	5240	Ant2	21.168
NVNT	a SISO	5260	Ant2	19.862
NVNT	a SISO	5300	Ant2	21.205
NVNT	a SISO	5320	Ant2	20.744
NVNT	a SISO	5500	Ant2	19.847
NVNT	a SISO	5580	Ant2	19.779
NVNT	a SISO	5600	Ant2	19.222
NVNT	a SISO	5720	Ant2	19.19
NVNT	n20 SISO	5180	Ant1	20.318
NVNT	n20 SISO	5220	Ant1	19.942
NVNT	n20 SISO	5240	Ant1	20.252
NVNT	n20 SISO	5260	Ant1	20.459
NVNT	n20 SISO	5300	Ant1	20.921
NVNT	n20 SISO	5320	Ant1	21.056
NVNT	n20 SISO	5500	Ant1	20.667
NVNT	n20 SISO	5580	Ant1	21.088
NVNT	n20 SISO	5600	Ant1	20.778
NVNT	n20 SISO	5720	Ant1	20.619
NVNT	n20 SISO	5180	Ant2	22.945
NVNT	n20 SISO	5220	Ant2	21.924
NVNT	n20 SISO	5240	Ant2	22.215
NVNT	n20 SISO	5260	Ant2	23.812
NVNT	n20 SISO	5300	Ant2	22.31
NVNT	n20 SISO	5320	Ant2	21.346



NVNT	n20 SISO	5500	Ant2	20.584
NVNT	n20 SISO	5580	Ant2	20.41
NVNT	n20 SISO	5600	Ant2	20.766
NVNT	n20 SISO	5720	Ant2	20.547
NVNT	n20 MIMO	5180	Ant1	20.475
NVNT	n20 MIMO	5180	Ant2	21.07
NVNT	n20 MIMO	5220	Ant1	20.56
NVNT	n20 MIMO	5220	Ant2	20.007
NVNT	n20 MIMO	5240	Ant1	20.107
NVNT	n20 MIMO	5240	Ant2	20.365
NVNT	n20 MIMO	5260	Ant1	20.659
NVNT	n20 MIMO	5260	Ant2	20.673
NVNT	n20 MIMO	5300	Ant1	20.376
NVNT	n20 MIMO	5300	Ant2	21.402
NVNT	n20 MIMO	5320	Ant1	20.889
NVNT	n20 MIMO	5320	Ant2	20.991
NVNT	n20 MIMO	5500	Ant1	20.316
NVNT	n20 MIMO	5500	Ant2	20.912
NVNT	n20 MIMO	5580	Ant1	20.605
NVNT	n20 MIMO	5580	Ant2	20.871
NVNT	n20 MIMO	5600	Ant1	20.894
NVNT	n20 MIMO	5600	Ant2	20.535
NVNT	n20 MIMO	5720	Ant1	20.66
NVNT	n20 MIMO	5720	Ant2	20.001
NVNT	n40 SISO	5190	Ant1	39.435
NVNT	n40 SISO	5230	Ant1	39.644
NVNT	n40 SISO	5270	Ant1	39.84
NVNT	n40 SISO	5310	Ant1	40.219
NVNT	n40 SISO	5510	Ant1	55.628
NVNT	n40 SISO	5550	Ant1	39.146
NVNT	n40 SISO	5630	Ant1	40.903
NVNT	n40 SISO	5710	Ant1	39.975
NVNT	n40 SISO	5190	Ant2	50.251
NVNT	n40 SISO	5230	Ant2	49.281
NVNT	n40 SISO	5270	Ant2	42.805
NVNT	n40 SISO	5310	Ant2	40.995
NVNT	n40 SISO	5510	Ant2	40.136
NVNT	n40 SISO	5550	Ant2	39.159



NVNT	n40 SISO	5630	Ant2	40.054
NVNT	n40 SISO	5710	Ant2	39.631
NVNT	n40 MIMO	5190	Ant1	39.559
NVNT	n40 MIMO	5190	Ant2	39.612
NVNT	n40 MIMO	5230	Ant1	40.116
NVNT	n40 MIMO	5230	Ant2	40.202
NVNT	n40 MIMO	5270	Ant1	39.59
NVNT	n40 MIMO	5270	Ant2	39.444
NVNT	n40 MIMO	5310	Ant1	40.236
NVNT	n40 MIMO	5310	Ant2	39.874
NVNT	n40 MIMO	5510	Ant1	40.233
NVNT	n40 MIMO	5510	Ant2	39.644
NVNT	n40 MIMO	5550	Ant1	39.569
NVNT	n40 MIMO	5550	Ant2	38.966
NVNT	n40 MIMO	5630	Ant1	39.82
NVNT	n40 MIMO	5630	Ant2	39.467
NVNT	n40 MIMO	5710	Ant1	40.019
NVNT	n40 MIMO	5710	Ant2	39.874
NVNT	ac20 SISO	5180	Ant1	20.436
NVNT	ac20 SISO	5220	Ant1	20.121
NVNT	ac20 SISO	5240	Ant1	20.614
NVNT	ac20 SISO	5260	Ant1	20.703
NVNT	ac20 SISO	5300	Ant1	20.56
NVNT	ac20 SISO	5320	Ant1	21.188
NVNT	ac20 SISO	5500	Ant1	20.639
NVNT	ac20 SISO	5580	Ant1	21.572
NVNT	ac20 SISO	5600	Ant1	21.232
NVNT	ac20 SISO	5720	Ant1	20.752
NVNT	ac20 SISO	5180	Ant2	23.996
NVNT	ac20 SISO	5220	Ant2	22.845
NVNT	ac20 SISO	5240	Ant2	21.766
NVNT	ac20 SISO	5260	Ant2	23.042
NVNT	ac20 SISO	5300	Ant2	21.667
NVNT	ac20 SISO	5320	Ant2	20.528
NVNT	ac20 SISO	5500	Ant2	20.773
NVNT	ac20 SISO	5580	Ant2	21.21
NVNT	ac20 SISO	5600	Ant2	20.735
NVNT	ac20 SISO	5720	Ant2	20.433



NVNT	ac20 MIMO	5180	Ant1	20.536
NVNT	ac20 MIMO	5180	Ant2	20.128
NVNT	ac20 MIMO	5220	Ant1	20.381
NVNT	ac20 MIMO	5220	Ant2	20.863
NVNT	ac20 MIMO	5240	Ant1	20.352
NVNT	ac20 MIMO	5240	Ant2	20.684
NVNT	ac20 MIMO	5260	Ant1	20.833
NVNT	ac20 MIMO	5260	Ant2	20.829
NVNT	ac20 MIMO	5300	Ant1	20.264
NVNT	ac20 MIMO	5300	Ant2	20.456
NVNT	ac20 MIMO	5320	Ant1	20.327
NVNT	ac20 MIMO	5320	Ant2	20.18
NVNT	ac20 MIMO	5500	Ant1	20.674
NVNT	ac20 MIMO	5500	Ant2	20.776
NVNT	ac20 MIMO	5580	Ant1	20.182
NVNT	ac20 MIMO	5580	Ant2	20.721
NVNT	ac20 MIMO	5600	Ant1	20.894
NVNT	ac20 MIMO	5600	Ant2	20.699
NVNT	ac20 MIMO	5720	Ant1	20.324
NVNT	ac20 MIMO	5720	Ant2	20.691
NVNT	ac40 SISO	5190	Ant1	39.383
NVNT	ac40 SISO	5230	Ant1	39.927
NVNT	ac40 SISO	5270	Ant1	39.761
NVNT	ac40 SISO	5310	Ant1	40.174
NVNT	ac40 SISO	5510	Ant1	40.305
NVNT	ac40 SISO	5550	Ant1	39.523
NVNT	ac40 SISO	5630	Ant1	40.186
NVNT	ac40 SISO	5710	Ant1	40.44
NVNT	ac40 SISO	5190	Ant2	50.247
NVNT	ac40 SISO	5230	Ant2	51.193
NVNT	ac40 SISO	5270	Ant2	49.775
NVNT	ac40 SISO	5310	Ant2	40.597
NVNT	ac40 SISO	5510	Ant2	40.53
NVNT	ac40 SISO	5550	Ant2	39.662
NVNT	ac40 SISO	5630	Ant2	39.909
NVNT	ac40 SISO	5710	Ant2	39.761
NVNT	ac40 MIMO	5190	Ant1	39.831
NVNT	ac40 MIMO	5190	Ant2	39.818



NVNT	ac40 MIMO	5230	Ant1	40.042
NVNT	ac40 MIMO	5230	Ant2	40.1
NVNT	ac40 MIMO	5270	Ant1	39.905
NVNT	ac40 MIMO	5270	Ant2	39.696
NVNT	ac40 MIMO	5310	Ant1	39.97
NVNT	ac40 MIMO	5310	Ant2	39.906
NVNT	ac40 MIMO	5510	Ant1	40.227
NVNT	ac40 MIMO	5510	Ant2	39.711
NVNT	ac40 MIMO	5550	Ant1	38.975
NVNT	ac40 MIMO	5550	Ant2	39.054
NVNT	ac40 MIMO	5630	Ant1	39.444
NVNT	ac40 MIMO	5630	Ant2	39.371
NVNT	ac40 MIMO	5710	Ant1	40.054
NVNT	ac40 MIMO	5710	Ant2	39.984
NVNT	ac80 SISO	5210	Ant1	81.117
NVNT	ac80 SISO	5290	Ant1	81.123
NVNT	ac80 SISO	5530	Ant1	94.995
NVNT	ac80 SISO	5610	Ant1	82.286
NVNT	ac80 SISO	5690	Ant1	79.605
NVNT	ac80 SISO	5210	Ant2	91.964
NVNT	ac80 SISO	5290	Ant2	83.554
NVNT	ac80 SISO	5530	Ant2	80.988
NVNT	ac80 SISO	5610	Ant2	81.414
NVNT	ac80 SISO	5690	Ant2	81.58
NVNT	ac80 MIMO	5210	Ant1	81.257
NVNT	ac80 MIMO	5210	Ant2	81.176
NVNT	ac80 MIMO	5290	Ant1	80.692
NVNT	ac80 MIMO	5290	Ant2	82.055
NVNT	ac80 MIMO	5530	Ant1	82.514
NVNT	ac80 MIMO	5530	Ant2	81.289
NVNT	ac80 MIMO	5610	Ant1	81.531
NVNT	ac80 MIMO	5610	Ant2	81.878
NVNT	ac80 MIMO	5690	Ant1	80.938
NVNT	ac80 MIMO	5690	Ant2	80.774
NVNT	ac160 SISO	5250	Ant1	167.912
NVNT	ac160 SISO	5570	Ant1	168.35
NVNT	ac160 SISO	5250	Ant2	167.885
NVNT	ac160 SISO	5570	Ant2	167.537



NVNT	ac160 MIMO	5250	Ant1	167.094
NVNT	ac160 MIMO	5250	Ant2	167.291
NVNT	ac160 MIMO	5570	Ant1	167.301
NVNT	ac160 MIMO	5570	Ant2	168.08
NVNT	ax20 SISO	5180	Ant1	20.824
NVNT	ax20 SISO	5220	Ant1	20.734
NVNT	ax20 SISO	5240	Ant1	20.785
NVNT	ax20 SISO	5260	Ant1	21.138
NVNT	ax20 SISO	5300	Ant1	21.418
NVNT	ax20 SISO	5320	Ant1	20.901
NVNT	ax20 SISO	5500	Ant1	21.452
NVNT	ax20 SISO	5580	Ant1	20.591
NVNT	ax20 SISO	5600	Ant1	21.179
NVNT	ax20 SISO	5720	Ant1	20.834
NVNT	ax20 SISO	5180	Ant2	25.228
NVNT	ax20 SISO	5220	Ant2	22.564
NVNT	ax20 SISO	5240	Ant2	21.391
NVNT	ax20 SISO	5260	Ant2	21.089
NVNT	ax20 SISO	5300	Ant2	21.09
NVNT	ax20 SISO	5320	Ant2	21.161
NVNT	ax20 SISO	5500	Ant2	21.072
NVNT	ax20 SISO	5580	Ant2	21.065
NVNT	ax20 SISO	5600	Ant2	21.049
NVNT	ax20 SISO	5720	Ant2	21.001
NVNT	ax20 MIMO	5180	Ant1	20.528
NVNT	ax20 MIMO	5180	Ant2	21.109
NVNT	ax20 MIMO	5220	Ant1	20.818
NVNT	ax20 MIMO	5220	Ant2	21.441
NVNT	ax20 MIMO	5240	Ant1	20.713
NVNT	ax20 MIMO	5240	Ant2	20.883
NVNT	ax20 MIMO	5260	Ant1	20.843
NVNT	ax20 MIMO	5260	Ant2	22
NVNT	ax20 MIMO	5300	Ant1	20.679
NVNT	ax20 MIMO	5300	Ant2	21.538
NVNT	ax20 MIMO	5320	Ant1	20.822
NVNT	ax20 MIMO	5320	Ant2	21.178
NVNT	ax20 MIMO	5500	Ant1	20.944
NVNT	ax20 MIMO	5500	Ant2	21.002



NVNT	ax20 MIMO	5580	Ant1	20.616
NVNT	ax20 MIMO	5580	Ant2	21.279
NVNT	ax20 MIMO	5600	Ant1	20.567
NVNT	ax20 MIMO	5600	Ant2	20.897
NVNT	ax20 MIMO	5720	Ant1	20.801
NVNT	ax20 MIMO	5720	Ant2	20.645
NVNT	ax40 SISO	5190	Ant1	40.133
NVNT	ax40 SISO	5230	Ant1	39.993
NVNT	ax40 SISO	5270	Ant1	39.799
NVNT	ax40 SISO	5310	Ant1	39.766
NVNT	ax40 SISO	5510	Ant1	59.302
NVNT	ax40 SISO	5550	Ant1	50.94
NVNT	ax40 SISO	5630	Ant1	40.277
NVNT	ax40 SISO	5710	Ant1	39.893
NVNT	ax40 SISO	5190	Ant2	47.826
NVNT	ax40 SISO	5230	Ant2	43.083
NVNT	ax40 SISO	5270	Ant2	43.902
NVNT	ax40 SISO	5310	Ant2	41.067
NVNT	ax40 SISO	5510	Ant2	40.266
NVNT	ax40 SISO	5550	Ant2	39.883
NVNT	ax40 SISO	5630	Ant2	40.389
NVNT	ax40 SISO	5710	Ant2	40.048
NVNT	ax40 MIMO	5190	Ant1	40.042
NVNT	ax40 MIMO	5190	Ant2	40.028
NVNT	ax40 MIMO	5230	Ant1	40.015
NVNT	ax40 MIMO	5230	Ant2	40.212
NVNT	ax40 MIMO	5270	Ant1	40.165
NVNT	ax40 MIMO	5270	Ant2	40.654
NVNT	ax40 MIMO	5310	Ant1	40.29
NVNT	ax40 MIMO	5310	Ant2	40.366
NVNT	ax40 MIMO	5510	Ant1	40.293
NVNT	ax40 MIMO	5510	Ant2	39.993
NVNT	ax40 MIMO	5550	Ant1	39.6
NVNT	ax40 MIMO	5550	Ant2	39.879
NVNT	ax40 MIMO	5630	Ant1	40.223
NVNT	ax40 MIMO	5630	Ant2	40.601
NVNT	ax40 MIMO	5710	Ant1	40.524
NVNT	ax40 MIMO	5710	Ant2	40.166



NVNT	ax80 SISO	5210	Ant1	80.963
NVNT	ax80 SISO	5290	Ant1	82.232
NVNT	ax80 SISO	5530	Ant1	81.503
NVNT	ax80 SISO	5610	Ant1	81.784
NVNT	ax80 SISO	5690	Ant1	81.322
NVNT	ax80 SISO	5210	Ant2	99.876
NVNT	ax80 SISO	5290	Ant2	83.098
NVNT	ax80 SISO	5530	Ant2	81.972
NVNT	ax80 SISO	5610	Ant2	81.878
NVNT	ax80 SISO	5690	Ant2	81.388
NVNT	ax80 MIMO	5210	Ant1	82.281
NVNT	ax80 MIMO	5210	Ant2	81.456
NVNT	ax80 MIMO	5290	Ant1	81.411
NVNT	ax80 MIMO	5290	Ant2	82.415
NVNT	ax80 MIMO	5530	Ant1	81.855
NVNT	ax80 MIMO	5530	Ant2	81.566
NVNT	ax80 MIMO	5610	Ant1	81.763
NVNT	ax80 MIMO	5610	Ant2	81.762
NVNT	ax80 MIMO	5690	Ant1	81.269
NVNT	ax80 MIMO	5690	Ant2	81.446
NVNT	ax160 SISO	5250	Ant1	168.469
NVNT	ax160 SISO	5570	Ant1	167.453
NVNT	ax160 SISO	5250	Ant2	167.372
NVNT	ax160 SISO	5570	Ant2	168.18
NVNT	ax160 MIMO	5250	Ant1	169.264
NVNT	ax160 MIMO	5250	Ant2	167.203
NVNT	ax160 MIMO	5570	Ant1	168.776
NVNT	ax160 MIMO	5570	Ant2	167.43
NVNT	ax20 26@0 SISO	5180	Ant1	20.964
NVNT	ax20 26@0 SISO	5220	Ant1	21.084
NVNT	ax20 26@0 SISO	5240	Ant1	20.21
NVNT	ax20 26@0 SISO	5260	Ant1	20.928
NVNT	ax20 26@0 SISO	5300	Ant1	20.839
NVNT	ax20 26@0 SISO	5320	Ant1	19.463
NVNT	ax20 26@0 SISO	5500	Ant1	21.114
NVNT	ax20 26@0 SISO	5580	Ant1	20.154
NVNT	ax20 26@0 SISO	5600	Ant1	18.733
NVNT	ax20 26@0 SISO	5720	Ant1	20.686



NVNT	ax20 26@0 SISO	5180	Ant2	20.258
NVNT	ax20 26@0 SISO	5220	Ant2	21.385
NVNT	ax20 26@0 SISO	5240	Ant2	20.191
NVNT	ax20 26@0 SISO	5260	Ant2	20.746
NVNT	ax20 26@0 SISO	5300	Ant2	19.526
NVNT	ax20 26@0 SISO	5320	Ant2	19.245
NVNT	ax20 26@0 SISO	5500	Ant2	20.767
NVNT	ax20 26@0 SISO	5580	Ant2	18.911
NVNT	ax20 26@0 SISO	5600	Ant2	19.932
NVNT	ax20 26@0 SISO	5720	Ant2	19.371
NVNT	ax20 26@0 MIMO	5180	Ant1	14.978
NVNT	ax20 26@0 MIMO	5180	Ant2	20.403
NVNT	ax20 26@0 MIMO	5220	Ant1	20.364
NVNT	ax20 26@0 MIMO	5220	Ant2	20.291
NVNT	ax20 26@0 MIMO	5240	Ant1	20.015
NVNT	ax20 26@0 MIMO	5240	Ant2	20.205
NVNT	ax20 26@0 MIMO	5260	Ant1	20.232
NVNT	ax20 26@0 MIMO	5260	Ant2	19.922
NVNT	ax20 26@0 MIMO	5300	Ant1	21.328
NVNT	ax20 26@0 MIMO	5300	Ant2	19.656
NVNT	ax20 26@0 MIMO	5320	Ant1	20.591
NVNT	ax20 26@0 MIMO	5320	Ant2	18.199
NVNT	ax20 26@0 MIMO	5500	Ant1	21.007
NVNT	ax20 26@0 MIMO	5500	Ant2	20.565
NVNT	ax20 26@0 MIMO	5580	Ant1	20.064
NVNT	ax20 26@0 MIMO	5580	Ant2	17.487
NVNT	ax20 26@0 MIMO	5600	Ant1	20.11
NVNT	ax20 26@0 MIMO	5600	Ant2	19.681
NVNT	ax20 26@0 MIMO	5720	Ant1	19.481
NVNT	ax20 26@0 MIMO	5720	Ant2	20.184
NVNT	ax20 52@37 SISO	5180	Ant1	21.486
NVNT	ax20 52@37 SISO	5220	Ant1	21.215
NVNT	ax20 52@37 SISO	5240	Ant1	21.164
NVNT	ax20 52@37 SISO	5260	Ant1	21.306
NVNT	ax20 52@37 SISO	5300	Ant1	21.6
NVNT	ax20 52@37 SISO	5320	Ant1	21.534
NVNT	ax20 52@37 SISO	5500	Ant1	21.36
NVNT	ax20 52@37 SISO	5580	Ant1	20.115



NVNT	ax20 52@37 SISO	5600	Ant1	20.372
NVNT	ax20 52@37 SISO	5720	Ant1	20.653
NVNT	ax20 52@37 SISO	5180	Ant2	24.472
NVNT	ax20 52@37 SISO	5220	Ant2	22.036
NVNT	ax20 52@37 SISO	5240	Ant2	24.909
NVNT	ax20 52@37 SISO	5260	Ant2	20.985
NVNT	ax20 52@37 SISO	5300	Ant2	21.31
NVNT	ax20 52@37 SISO	5320	Ant2	21.968
NVNT	ax20 52@37 SISO	5500	Ant2	21.264
NVNT	ax20 52@37 SISO	5580	Ant2	19.075
NVNT	ax20 52@37 SISO	5600	Ant2	20.546
NVNT	ax20 52@37 SISO	5720	Ant2	20.909
NVNT	ax20 52@37 MIMO	5180	Ant1	19.737
NVNT	ax20 52@37 MIMO	5180	Ant2	21.673
NVNT	ax20 52@37 MIMO	5220	Ant1	19.033
NVNT	ax20 52@37 MIMO	5220	Ant2	22.053
NVNT	ax20 52@37 MIMO	5240	Ant1	20.406
NVNT	ax20 52@37 MIMO	5240	Ant2	20.733
NVNT	ax20 52@37 MIMO	5260	Ant1	20.788
NVNT	ax20 52@37 MIMO	5260	Ant2	20.258
NVNT	ax20 52@37 MIMO	5300	Ant1	21.424
NVNT	ax20 52@37 MIMO	5300	Ant2	18.409
NVNT	ax20 52@37 MIMO	5320	Ant1	19.614
NVNT	ax20 52@37 MIMO	5320	Ant2	19.969
NVNT	ax20 52@37 MIMO	5500	Ant1	20.407
NVNT	ax20 52@37 MIMO	5500	Ant2	20.766
NVNT	ax20 52@37 MIMO	5580	Ant1	19.074
NVNT	ax20 52@37 MIMO	5580	Ant2	16.537
NVNT	ax20 52@37 MIMO	5600	Ant1	21.36
NVNT	ax20 52@37 MIMO	5600	Ant2	18.736
NVNT	ax20 52@37 MIMO	5720	Ant1	19.046
NVNT	ax20 52@37 MIMO	5720	Ant2	20.456
NVNT	ax20 106@53 SISO	5180	Ant1	20.458
NVNT	ax20 106@53 SISO	5220	Ant1	22.655
NVNT	ax20 106@53 SISO	5240	Ant1	21.544
NVNT	ax20 106@53 SISO	5260	Ant1	23.749
NVNT	ax20 106@53 SISO	5300	Ant1	24.316
NVNT	ax20 106@53 SISO	5320	Ant1	23.889



NVNT	ax20 106@53 SISO	5500	Ant1	26.308
NVNT	ax20 106@53 SISO	5580	Ant1	24.758
NVNT	ax20 106@53 SISO	5600	Ant1	21.98
NVNT	ax20 106@53 SISO	5720	Ant1	21.13
NVNT	ax20 106@53 SISO	5180	Ant2	25.859
NVNT	ax20 106@53 SISO	5220	Ant2	25.519
NVNT	ax20 106@53 SISO	5240	Ant2	23.127
NVNT	ax20 106@53 SISO	5260	Ant2	24.34
NVNT	ax20 106@53 SISO	5300	Ant2	26.418
NVNT	ax20 106@53 SISO	5320	Ant2	23.814
NVNT	ax20 106@53 SISO	5500	Ant2	21.8
NVNT	ax20 106@53 SISO	5580	Ant2	21.361
NVNT	ax20 106@53 SISO	5600	Ant2	21.305
NVNT	ax20 106@53 SISO	5720	Ant2	22.02
NVNT	ax20 106@53 MIMO	5180	Ant1	21.562
NVNT	ax20 106@53 MIMO	5180	Ant2	22.919
NVNT	ax20 106@53 MIMO	5220	Ant1	21.93
NVNT	ax20 106@53 MIMO	5220	Ant2	23.474
NVNT	ax20 106@53 MIMO	5240	Ant1	21.73
NVNT	ax20 106@53 MIMO	5240	Ant2	21.471
NVNT	ax20 106@53 MIMO	5260	Ant1	21.816
NVNT	ax20 106@53 MIMO	5260	Ant2	23.929
NVNT	ax20 106@53 MIMO	5300	Ant1	21.258
NVNT	ax20 106@53 MIMO	5300	Ant2	22.761
NVNT	ax20 106@53 MIMO	5320	Ant1	21.07
NVNT	ax20 106@53 MIMO	5320	Ant2	22.768
NVNT	ax20 106@53 MIMO	5500	Ant1	24.678
NVNT	ax20 106@53 MIMO	5500	Ant2	17.659
NVNT	ax20 106@53 MIMO	5580	Ant1	19.426
NVNT	ax20 106@53 MIMO	5580	Ant2	21.15
NVNT	ax20 106@53 MIMO	5600	Ant1	21.792
NVNT	ax20 106@53 MIMO	5600	Ant2	15.743
NVNT	ax20 106@53 MIMO	5720	Ant1	18.993
NVNT	ax20 106@53 MIMO	5720	Ant2	21.108
NVNT	ax40 242@61 SISO	5190	Ant1	43.921
NVNT	ax40 242@61 SISO	5230	Ant1	51.042
NVNT	ax40 242@61 SISO	5270	Ant1	44.911
NVNT	ax40 242@61 SISO	5310	Ant1	49.287



NVNT	ax40 242@61 SISO	5510	Ant1	47.283
NVNT	ax40 242@61 SISO	5550	Ant1	45.157
NVNT	ax40 242@61 SISO	5630	Ant1	44.128
NVNT	ax40 242@61 SISO	5710	Ant1	37.045
NVNT	ax40 242@61 SISO	5190	Ant2	53.816
NVNT	ax40 242@61 SISO	5230	Ant2	50.569
NVNT	ax40 242@61 SISO	5270	Ant2	48.745
NVNT	ax40 242@61 SISO	5310	Ant2	48.18
NVNT	ax40 242@61 SISO	5510	Ant2	42.411
NVNT	ax40 242@61 SISO	5550	Ant2	42.929
NVNT	ax40 242@61 SISO	5630	Ant2	41.533
NVNT	ax40 242@61 SISO	5710	Ant2	41.514
NVNT	ax40 242@61 MIMO	5190	Ant1	42.116
NVNT	ax40 242@61 MIMO	5190	Ant2	42.056
NVNT	ax40 242@61 MIMO	5230	Ant1	42.253
NVNT	ax40 242@61 MIMO	5230	Ant2	42.414
NVNT	ax40 242@61 MIMO	5270	Ant1	40.526
NVNT	ax40 242@61 MIMO	5270	Ant2	39.04
NVNT	ax40 242@61 MIMO	5310	Ant1	42.595
NVNT	ax40 242@61 MIMO	5310	Ant2	42.856
NVNT	ax40 242@61 MIMO	5510	Ant1	49.033
NVNT	ax40 242@61 MIMO	5510	Ant2	42.144
NVNT	ax40 242@61 MIMO	5550	Ant1	44.486
NVNT	ax40 242@61 MIMO	5550	Ant2	41.364
NVNT	ax40 242@61 MIMO	5630	Ant1	42.579
NVNT	ax40 242@61 MIMO	5630	Ant2	41.361
NVNT	ax40 242@61 MIMO	5710	Ant1	42.59
NVNT	ax40 242@61 MIMO	5710	Ant2	42.008
NVNT	ax80 484@65 SISO	5210	Ant1	89.918
NVNT	ax80 484@65 SISO	5290	Ant1	97.535
NVNT	ax80 484@65 SISO	5530	Ant1	86.191
NVNT	ax80 484@65 SISO	5610	Ant1	85.428
NVNT	ax80 484@65 SISO	5690	Ant1	86.028
NVNT	ax80 484@65 SISO	5210	Ant2	105.602
NVNT	ax80 484@65 SISO	5290	Ant2	96.289
NVNT	ax80 484@65 SISO	5530	Ant2	86.148
NVNT	ax80 484@65 SISO	5610	Ant2	87.565
NVNT	ax80 484@65 SISO	5690	Ant2	86.348



NVNT	ax80 484@65 MIMO	5210	Ant1	86.389
NVNT	ax80 484@65 MIMO	5210	Ant2	83.521
NVNT	ax80 484@65 MIMO	5290	Ant1	87.318
NVNT	ax80 484@65 MIMO	5290	Ant2	85.806
NVNT	ax80 484@65 MIMO	5530	Ant1	82.083
NVNT	ax80 484@65 MIMO	5530	Ant2	80.35
NVNT	ax80 484@65 MIMO	5610	Ant1	86.833
NVNT	ax80 484@65 MIMO	5610	Ant2	81.737
NVNT	ax80 484@65 MIMO	5690	Ant1	87.35
NVNT	ax80 484@65 MIMO	5690	Ant2	85.706
NVNT	ax160 996@67 SISO	5250	Ant1	168.397
NVNT	ax160 996@67 SISO	5570	Ant1	173.123
NVNT	ax160 996@67 SISO	5250	Ant2	170.478
NVNT	ax160 996@67 SISO	5570	Ant2	166.744
NVNT	ax160 996@67 MIMO	5250	Ant1	170.197
NVNT	ax160 996@67 MIMO	5250	Ant2	168.657
NVNT	ax160 996@67 MIMO	5570	Ant1	173.47
NVNT	ax160 996@67 MIMO	5570	Ant2	167.34



Condition	Mode	Frequency (MHz)	Antenna	-6 dB Bandwidth (MHz)	Limit -6 dB Bandwidth (MHz)	Verdict
NVNT	a SISO	5745	Ant1	14.4	0.5	Pass
NVNT	a SISO	5785	Ant1	13.883	0.5	Pass
NVNT	a SISO	5825	Ant1	12.887	0.5	Pass
NVNT	a SISO	5745	Ant2	15.533	0.5	Pass
NVNT	a SISO	5785	Ant2	15.311	0.5	Pass
NVNT	a SISO	5825	Ant2	13.742	0.5	Pass
NVNT	n20 SISO	5745	Ant1	12.534	0.5	Pass
NVNT	n20 SISO	5785	Ant1	16.268	0.5	Pass
NVNT	n20 SISO	5825	Ant1	17.171	0.5	Pass
NVNT	n20 SISO	5745	Ant2	12.495	0.5	Pass
NVNT	n20 SISO	5785	Ant2	13.844	0.5	Pass
NVNT	n20 SISO	5825	Ant2	16.008	0.5	Pass
NVNT	n20 MIMO	5745	Ant1	12.542	0.5	Pass
NVNT	n20 MIMO	5745	Ant2	15.269	0.5	Pass
NVNT	n20 MIMO	5785	Ant1	14.972	0.5	Pass
NVNT	n20 MIMO	5785	Ant2	15.073	0.5	Pass
NVNT	n20 MIMO	5825	Ant1	16.726	0.5	Pass
NVNT	n20 MIMO	5825	Ant2	11.927	0.5	Pass
NVNT	n40 SISO	5755	Ant1	35.032	0.5	Pass
NVNT	n40 SISO	5795	Ant1	35.578	0.5	Pass
NVNT	n40 SISO	5755	Ant2	32.78	0.5	Pass
NVNT	n40 SISO	5795	Ant2	35.411	0.5	Pass
NVNT	n40 MIMO	5755	Ant1	34.442	0.5	Pass
NVNT	n40 MIMO	5755	Ant2	34.01	0.5	Pass
NVNT	n40 MIMO	5795	Ant1	34.038	0.5	Pass
NVNT	n40 MIMO	5795	Ant2	33.415	0.5	Pass
NVNT	ac20 SISO	5745	Ant1	17.28	0.5	Pass
NVNT	ac20 SISO	5785	Ant1	13.211	0.5	Pass
NVNT	ac20 SISO	5825	Ant1	15.066	0.5	Pass
NVNT	ac20 SISO	5745	Ant2	16.894	0.5	Pass
NVNT	ac20 SISO	5785	Ant2	15.001	0.5	Pass
NVNT	ac20 SISO	5825	Ant2	17.065	0.5	Pass
NVNT	ac20 MIMO	5745	Ant1	17.549	0.5	Pass
NVNT	ac20 MIMO	5745	Ant2	16.788	0.5	Pass
NVNT	ac20 MIMO	5785	Ant1	15.349	0.5	Pass



NVNT	ac20 MIMO	5785	Ant2	15.037	0.5	Pass
NVNT	ac20 MIMO	5825	Ant1	12.276	0.5	Pass
NVNT	ac20 MIMO	5825	Ant2	16.899	0.5	Pass
NVNT	ac40 SISO	5755	Ant1	35.677	0.5	Pass
NVNT	ac40 SISO	5795	Ant1	34.813	0.5	Pass
NVNT	ac40 SISO	5755	Ant2	35.527	0.5	Pass
NVNT	ac40 SISO	5795	Ant2	33.741	0.5	Pass
NVNT	ac40 MIMO	5755	Ant1	34.923	0.5	Pass
NVNT	ac40 MIMO	5755	Ant2	33.861	0.5	Pass
NVNT	ac40 MIMO	5795	Ant1	32.259	0.5	Pass
NVNT	ac40 MIMO	5795	Ant2	34.751	0.5	Pass
NVNT	ac80 SISO	5775	Ant1	39.821	0.5	Pass
NVNT	ac80 SISO	5775	Ant2	70.048	0.5	Pass
NVNT	ac80 MIMO	5775	Ant1	68.777	0.5	Pass
NVNT	ac80 MIMO	5775	Ant2	66.329	0.5	Pass
NVNT	ax20 SISO	5745	Ant1	14.257	0.5	Pass
NVNT	ax20 SISO	5785	Ant1	13.995	0.5	Pass
NVNT	ax20 SISO	5825	Ant1	13.617	0.5	Pass
NVNT	ax20 SISO	5745	Ant2	16.6	0.5	Pass
NVNT	ax20 SISO	5785	Ant2	17.134	0.5	Pass
NVNT	ax20 SISO	5825	Ant2	16.236	0.5	Pass
NVNT	ax20 MIMO	5745	Ant1	18.538	0.5	Pass
NVNT	ax20 MIMO	5745	Ant2	14.743	0.5	Pass
NVNT	ax20 MIMO	5785	Ant1	18.55	0.5	Pass
NVNT	ax20 MIMO	5785	Ant2	18.23	0.5	Pass
NVNT	ax20 MIMO	5825	Ant1	15.938	0.5	Pass
NVNT	ax20 MIMO	5825	Ant2	14.843	0.5	Pass
NVNT	ax40 SISO	5755	Ant1	33.093	0.5	Pass
NVNT	ax40 SISO	5795	Ant1	30.974	0.5	Pass
NVNT	ax40 SISO	5755	Ant2	33.677	0.5	Pass
NVNT	ax40 SISO	5795	Ant2	37.158	0.5	Pass
NVNT	ax40 MIMO	5755	Ant1	37.127	0.5	Pass
NVNT	ax40 MIMO	5755	Ant2	37.091	0.5	Pass
NVNT	ax40 MIMO	5795	Ant1	36.949	0.5	Pass
NVNT	ax40 MIMO	5795	Ant2	34.521	0.5	Pass
NVNT	ax80 SISO	5775	Ant1	63.723	0.5	Pass
NVNT	ax80 SISO	5775	Ant2	48.826	0.5	Pass
NVNT	ax80 MIMO	5775	Ant1	67.641	0.5	Pass



NVNT	ax80 MIMO	5775	Ant2	49.998	0.5	Pass
NVNT	ax20 26@0 SISO	5745	Ant1	3.288	0.5	Pass
NVNT	ax20 26@0 SISO	5785	Ant1	2.107	0.5	Pass
NVNT	ax20 26@0 SISO	5825	Ant1	2.051	0.5	Pass
NVNT	ax20 26@0 SISO	5745	Ant2	2.087	0.5	Pass
NVNT	ax20 26@0 SISO	5785	Ant2	2.138	0.5	Pass
NVNT	ax20 26@0 SISO	5825	Ant2	2.03	0.5	Pass
NVNT	ax20 26@0 MIMO	5745	Ant1	2.036	0.5	Pass
NVNT	ax20 26@0 MIMO	5745	Ant2	2.067	0.5	Pass
NVNT	ax20 26@0 MIMO	5785	Ant1	2.023	0.5	Pass
NVNT	ax20 26@0 MIMO	5785	Ant2	2.041	0.5	Pass
NVNT	ax20 26@0 MIMO	5825	Ant1	2.074	0.5	Pass
NVNT	ax20 26@0 MIMO	5825	Ant2	2.009	0.5	Pass
NVNT	ax20 52@37 SISO	5745	Ant1	14.548	0.5	Pass
NVNT	ax20 52@37 SISO	5785	Ant1	17.075	0.5	Pass
NVNT	ax20 52@37 SISO	5825	Ant1	15.832	0.5	Pass
NVNT	ax20 52@37 SISO	5745	Ant2	13.298	0.5	Pass
NVNT	ax20 52@37 SISO	5785	Ant2	12.062	0.5	Pass
NVNT	ax20 52@37 SISO	5825	Ant2	4.035	0.5	Pass
NVNT	ax20 52@37 MIMO	5745	Ant1	17.075	0.5	Pass
NVNT	ax20 52@37 MIMO	5745	Ant2	15.838	0.5	Pass
NVNT	ax20 52@37 MIMO	5785	Ant1	17.022	0.5	Pass
NVNT	ax20 52@37 MIMO	5785	Ant2	4.04	0.5	Pass
NVNT	ax20 52@37 MIMO	5825	Ant1	17.018	0.5	Pass
NVNT	ax20 52@37 MIMO	5825	Ant2	14.549	0.5	Pass
NVNT	ax20 106@53 SISO	5745	Ant1	18.104	0.5	Pass
NVNT	ax20 106@53 SISO	5785	Ant1	18.073	0.5	Pass
NVNT	ax20 106@53 SISO	5825	Ant1	12.086	0.5	Pass
NVNT	ax20 106@53 SISO	5745	Ant2	15.899	0.5	Pass
NVNT	ax20 106@53 SISO	5785	Ant2	17.056	0.5	Pass
NVNT	ax20 106@53 SISO	5825	Ant2	16.069	0.5	Pass
NVNT	ax20 106@53 MIMO	5745	Ant1	17.076	0.5	Pass
NVNT	ax20 106@53 MIMO	5745	Ant2	15.821	0.5	Pass
NVNT	ax20 106@53 MIMO	5785	Ant1	15.217	0.5	Pass
NVNT	ax20 106@53 MIMO	5785	Ant2	12.094	0.5	Pass
NVNT	ax20 106@53 MIMO	5825	Ant1	15.205	0.5	Pass
NVNT	ax20 106@53 MIMO	5825	Ant2	16.811	0.5	Pass
NVNT	ax40 242@61 SISO	5755	Ant1	35.364	0.5	Pass



NVNT	ax40 242@61 SISO	5795	Ant1	37.669	0.5	Pass
NVNT	ax40 242@61 SISO	5755	Ant2	36.612	0.5	Pass
NVNT	ax40 242@61 SISO	5795	Ant2	35.31	0.5	Pass
NVNT	ax40 242@61 MIMO	5755	Ant1	34.37	0.5	Pass
NVNT	ax40 242@61 MIMO	5755	Ant2	36.661	0.5	Pass
NVNT	ax40 242@61 MIMO	5795	Ant1	35.355	0.5	Pass
NVNT	ax40 242@61 MIMO	5795	Ant2	32.82	0.5	Pass
NVNT	ax80 484@65 SISO	5775	Ant1	76.616	0.5	Pass
NVNT	ax80 484@65 SISO	5775	Ant2	75.365	0.5	Pass
NVNT	ax80 484@65 MIMO	5775	Ant1	76.643	0.5	Pass
NVNT	ax80 484@65 MIMO	5775	Ant2	76.586	0.5	Pass



Test Graphs

-26dB Bandwidth NVNT a 5180MHz Ant1 SISO



-26dB Bandwidth NVNT a 5220MHz Ant1 SISO





-26dB Bandwidth NVNT a 5240MHz Ant1 SISO



-26dB Bandwidth NVNT a 5260MHz Ant1 SISO





-26dB Bandwidth NVNT a 5300MHz Ant1 SISO



-26dB Bandwidth NVNT a 5320MHz Ant1 SISO





-26dB Bandwidth NVNT a 5500MHz Ant1 SISO

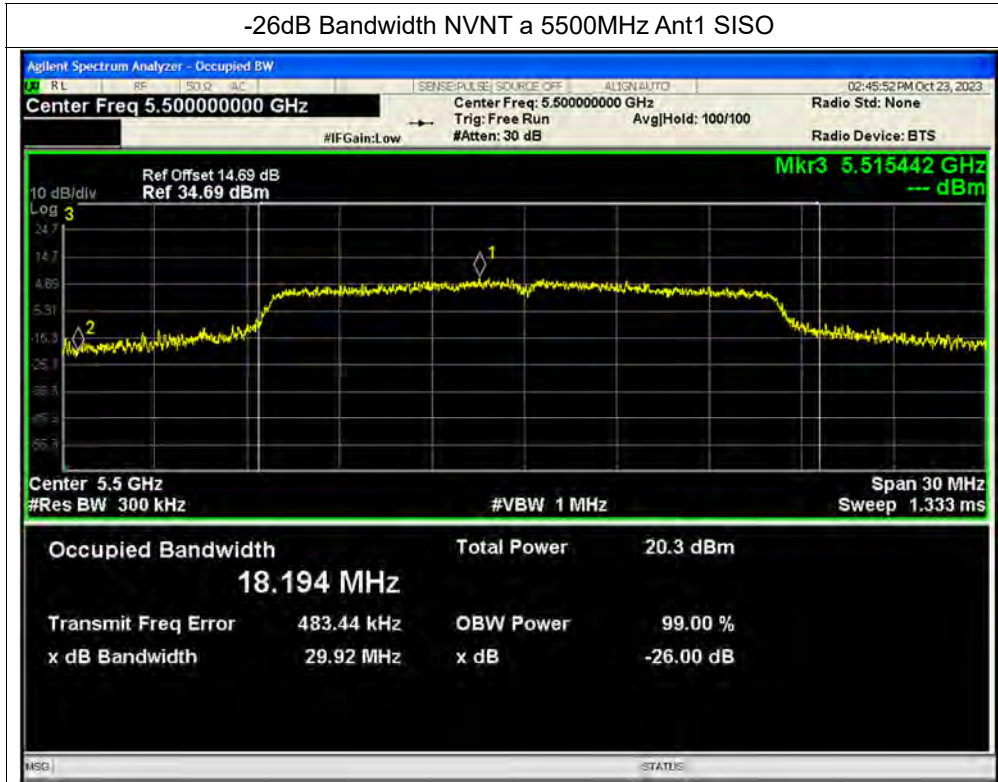

-26dB Bandwidth NVNT a 5580MHz Ant1 SISO





-26dB Bandwidth NVNT a 5600MHz Ant1 SISO



-26dB Bandwidth NVNT a 5720MHz Ant1 SISO





-26dB Bandwidth NVNT a 5180MHz Ant2 SISO

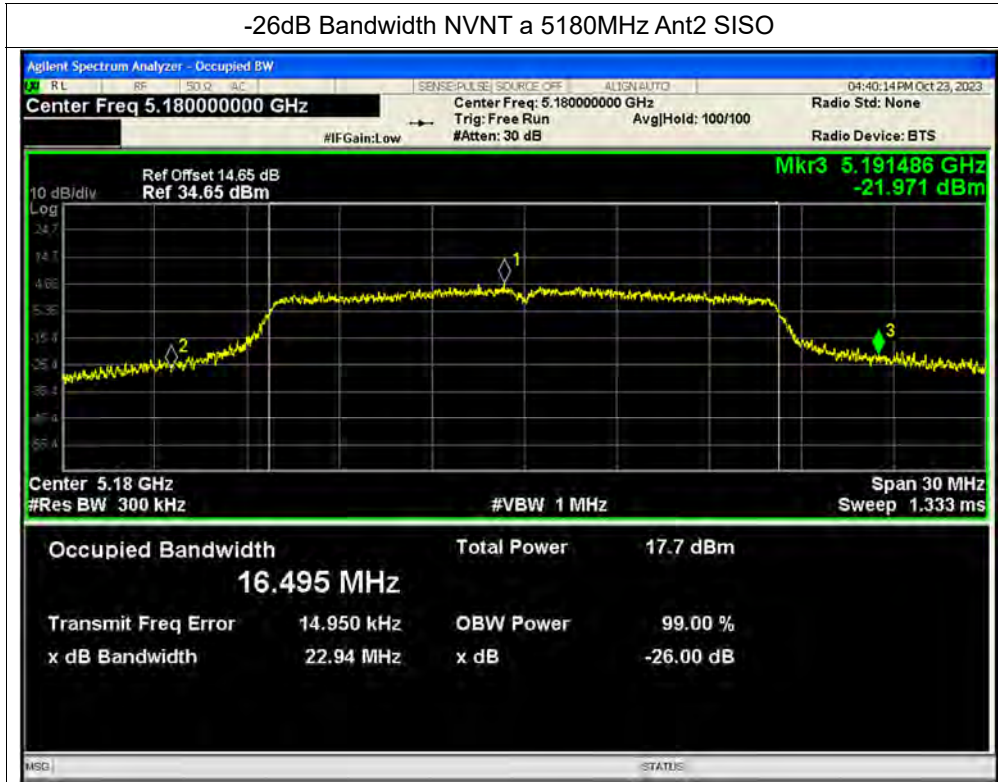

-26dB Bandwidth NVNT a 5220MHz Ant2 SISO



-26dB Bandwidth NVNT a 5240MHz Ant2 SISO



-26dB Bandwidth NVNT a 5260MHz Ant2 SISO





-26dB Bandwidth NVNT a 5300MHz Ant2 SISO



-26dB Bandwidth NVNT a 5320MHz Ant2 SISO

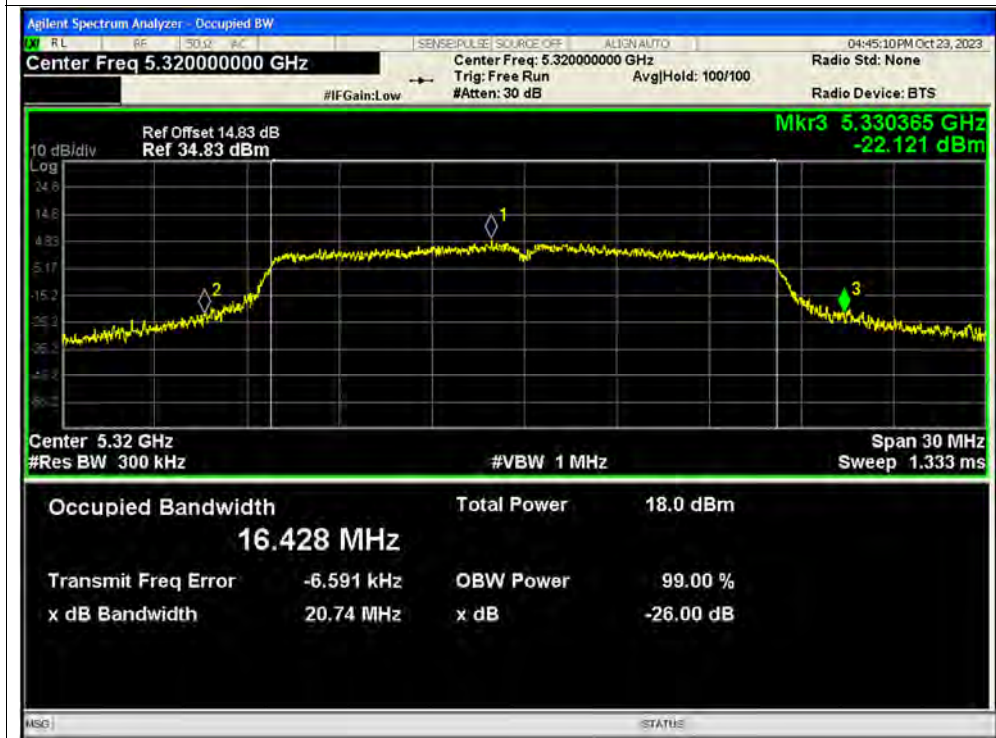



-26dB Bandwidth NVNT a 5500MHz Ant2 SISO



-26dB Bandwidth NVNT a 5580MHz Ant2 SISO





-26dB Bandwidth NVNT a 5600MHz Ant2 SISO



-26dB Bandwidth NVNT a 5720MHz Ant2 SISO

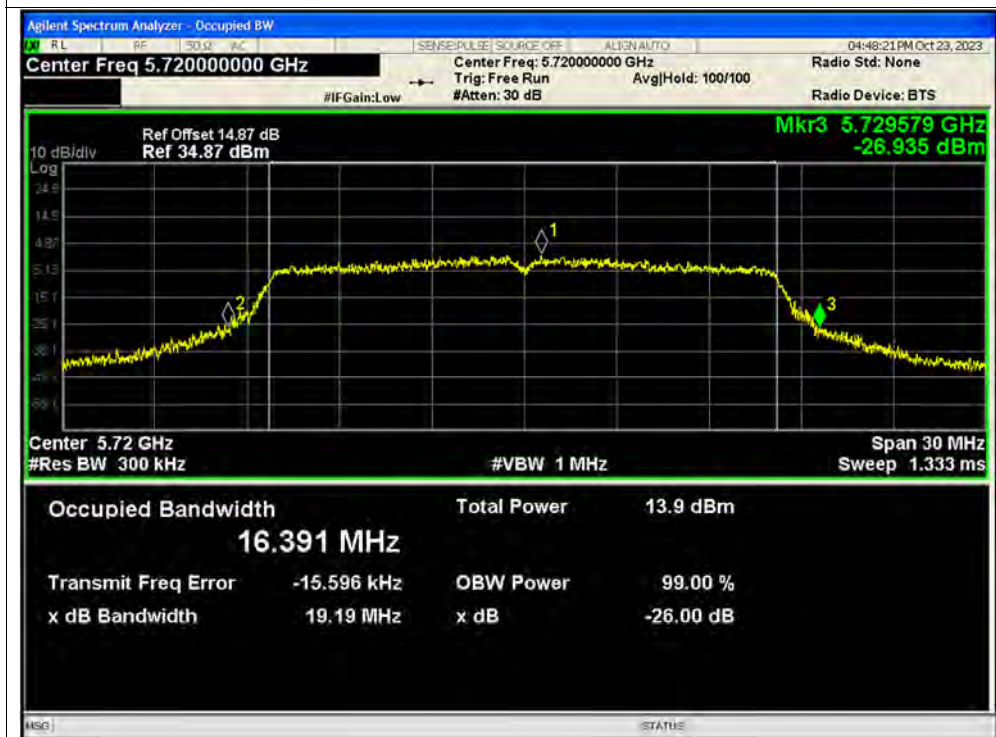



-26dB Bandwidth NVNT n20 5180MHz Ant1 SISO

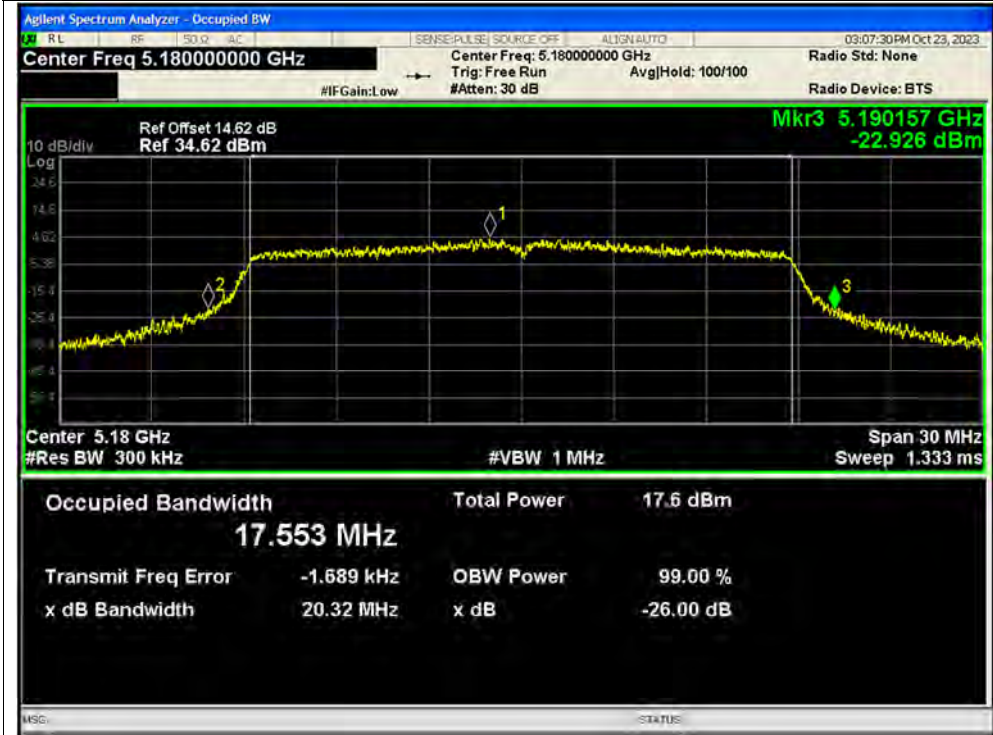

-26dB Bandwidth NVNT n20 5220MHz Ant1 SISO





-26dB Bandwidth NVNT n20 5240MHz Ant1 SISO

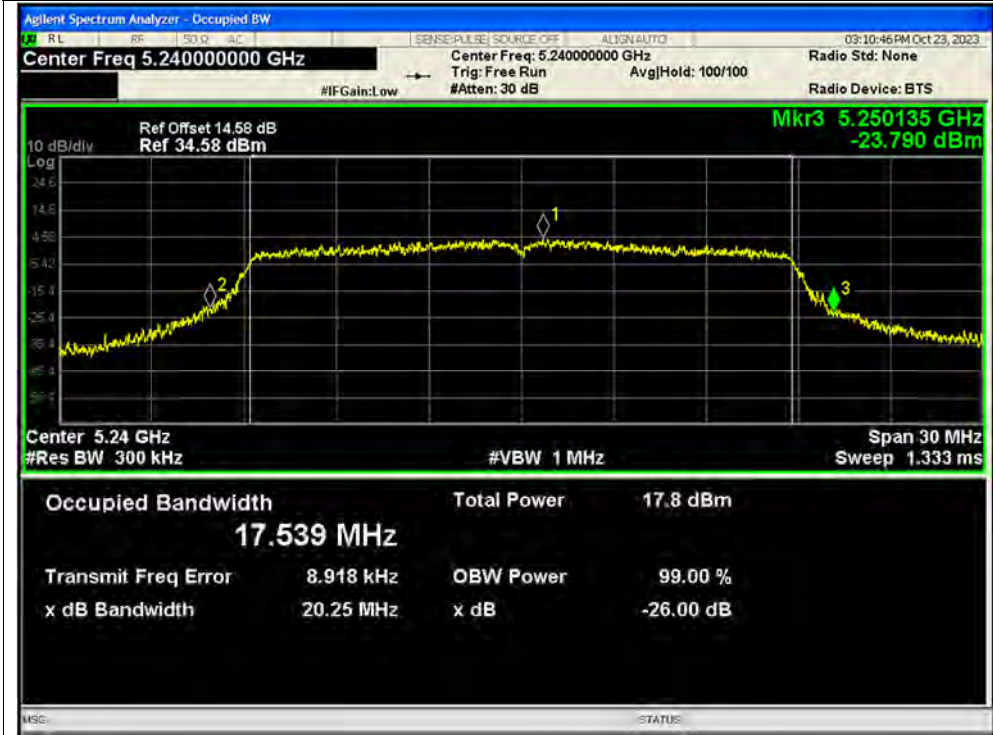

-26dB Bandwidth NVNT n20 5260MHz Ant1 SISO

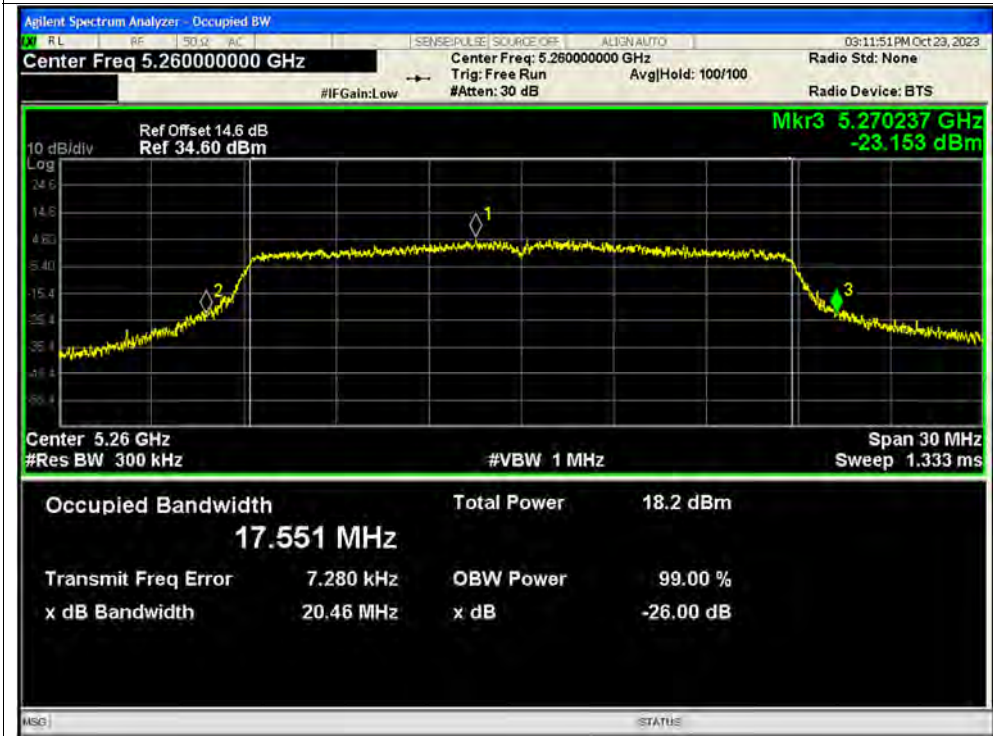



-26dB Bandwidth NVNT n20 5300MHz Ant1 SISO



-26dB Bandwidth NVNT n20 5320MHz Ant1 SISO





-26dB Bandwidth NVNT n20 5500MHz Ant1 SISO

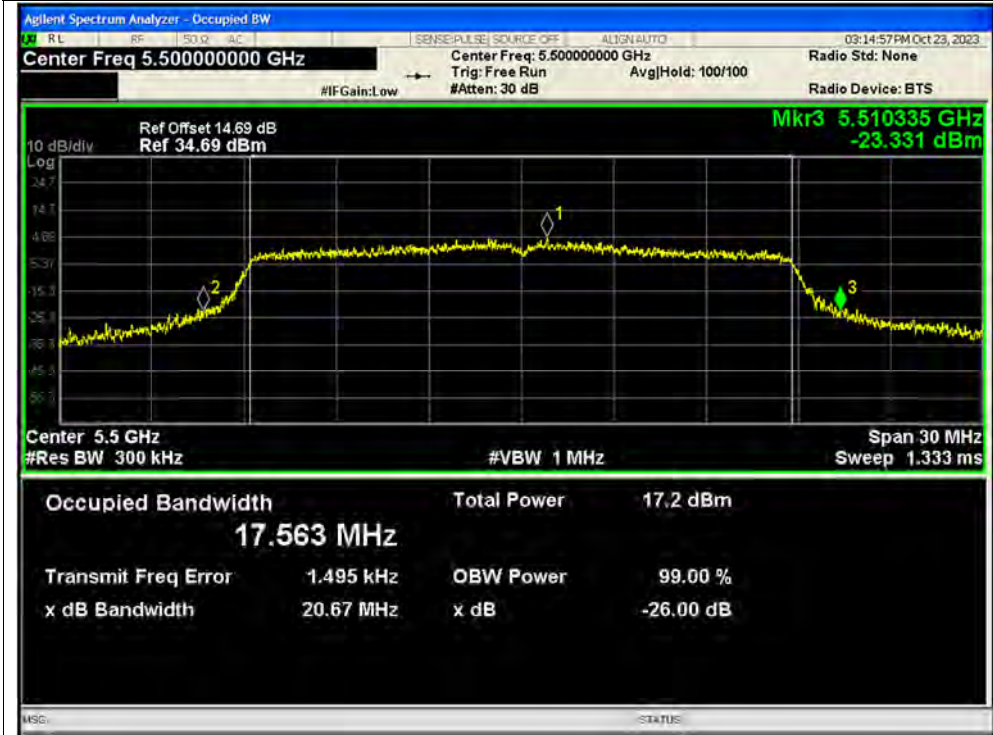

-26dB Bandwidth NVNT n20 5580MHz Ant1 SISO





-26dB Bandwidth NVNT n20 5600MHz Ant1 SISO

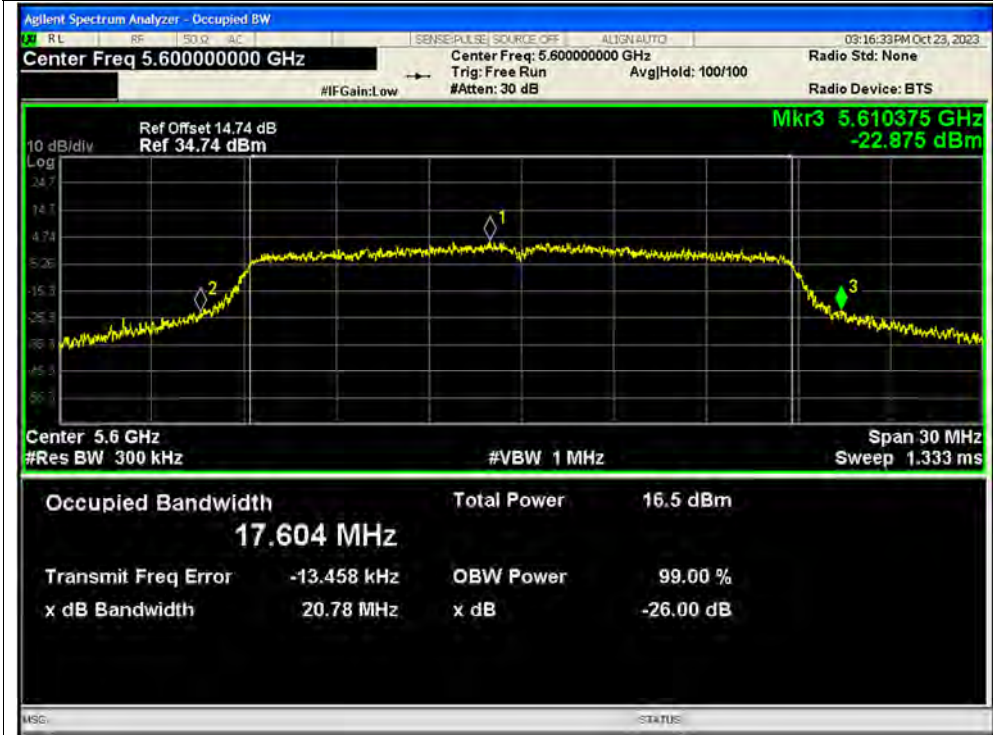

-26dB Bandwidth NVNT n20 5720MHz Ant1 SISO

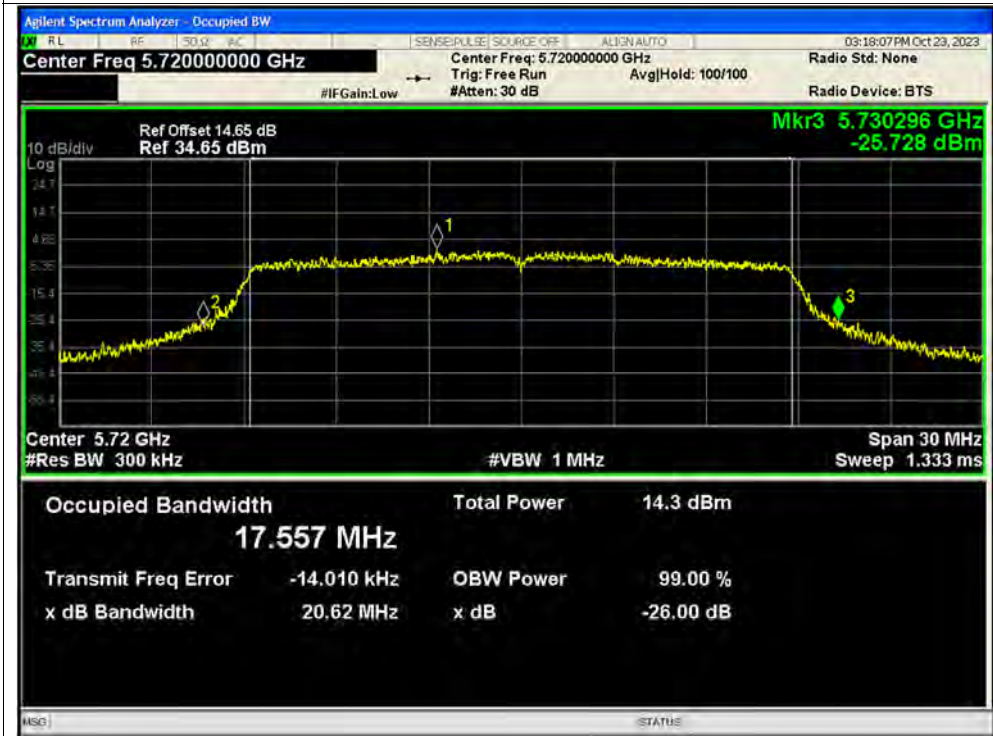



-26dB Bandwidth NVNT n20 5180MHz Ant2 SISO

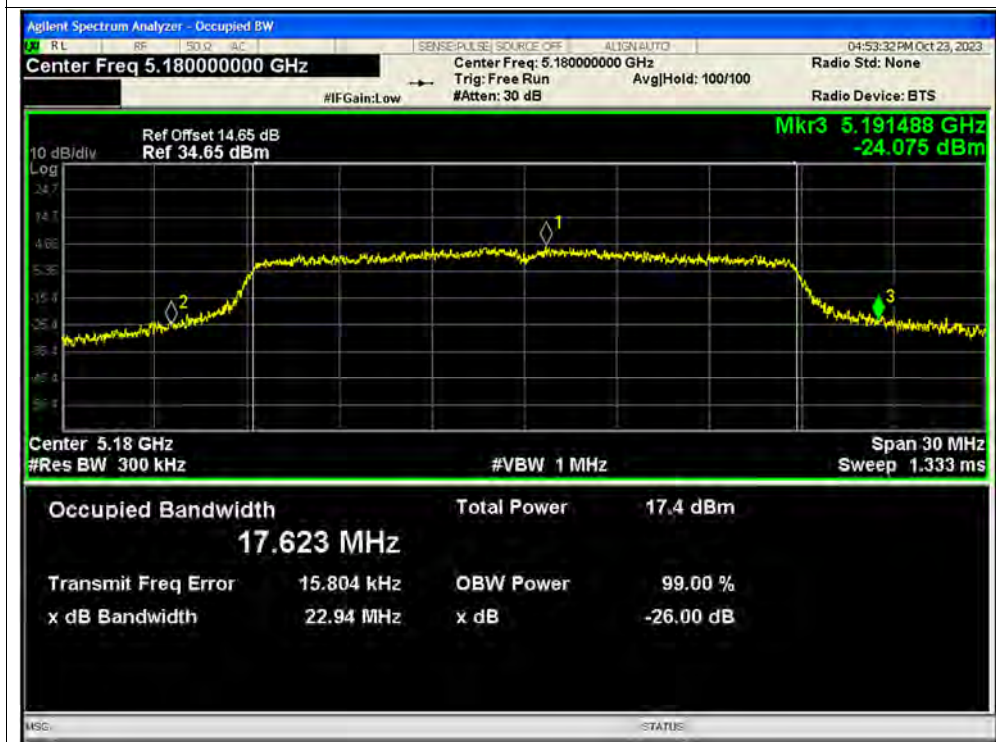

-26dB Bandwidth NVNT n20 5220MHz Ant2 SISO





-26dB Bandwidth NVNT n20 5240MHz Ant2 SISO



-26dB Bandwidth NVNT n20 5260MHz Ant2 SISO





-26dB Bandwidth NVNT n20 5300MHz Ant2 SISO



-26dB Bandwidth NVNT n20 5320MHz Ant2 SISO





-26dB Bandwidth NVNT n20 5500MHz Ant2 SISO



-26dB Bandwidth NVNT n20 5580MHz Ant2 SISO





-26dB Bandwidth NVNT n20 5600MHz Ant2 SISO



-26dB Bandwidth NVNT n20 5720MHz Ant2 SISO

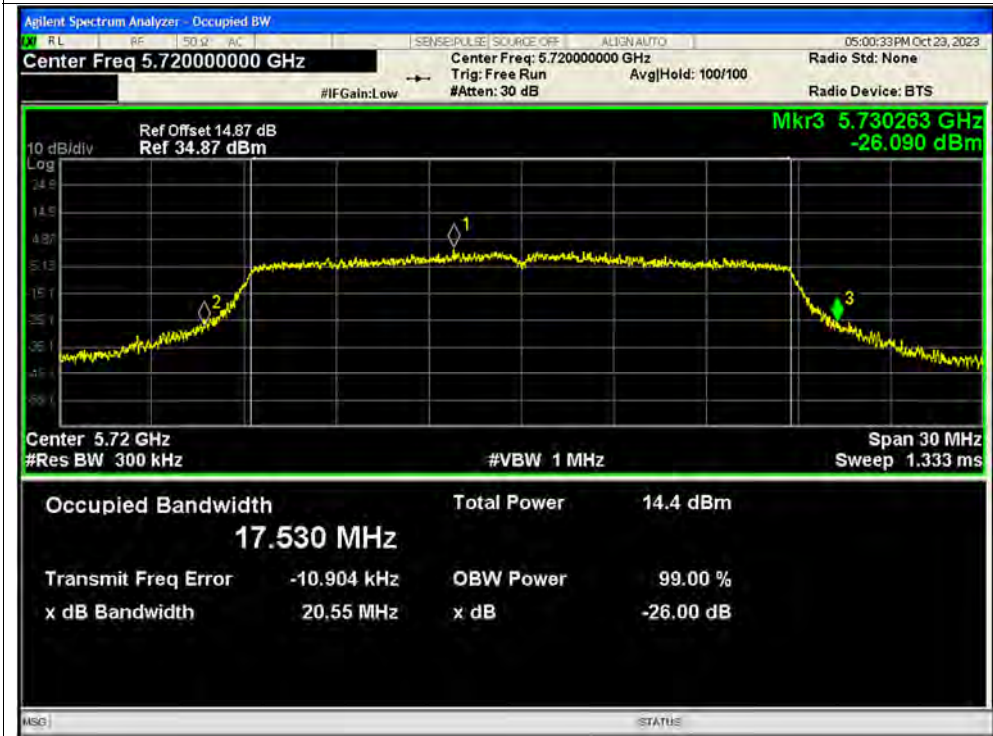



-26dB Bandwidth NVNT n20 5180MHz Ant1 MIMO



-26dB Bandwidth NVNT n20 5180MHz Ant2 MIMO

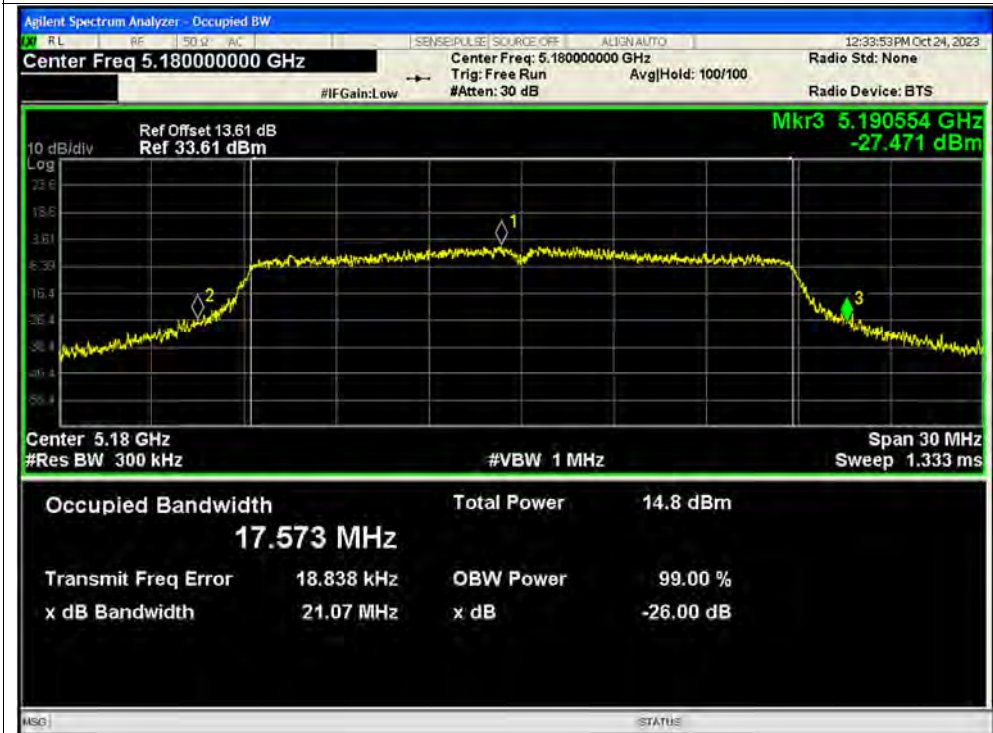



-26dB Bandwidth NVNT n20 5220MHz Ant1 MIMO

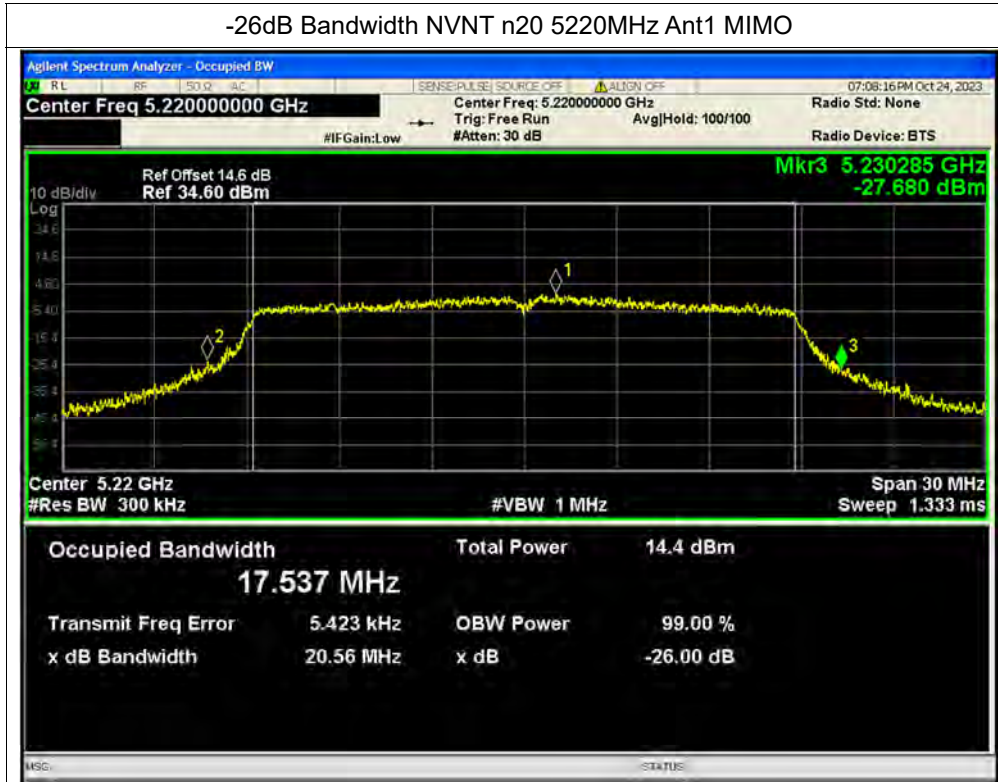

-26dB Bandwidth NVNT n20 5220MHz Ant2 MIMO





-26dB Bandwidth NVNT n20 5240MHz Ant1 MIMO

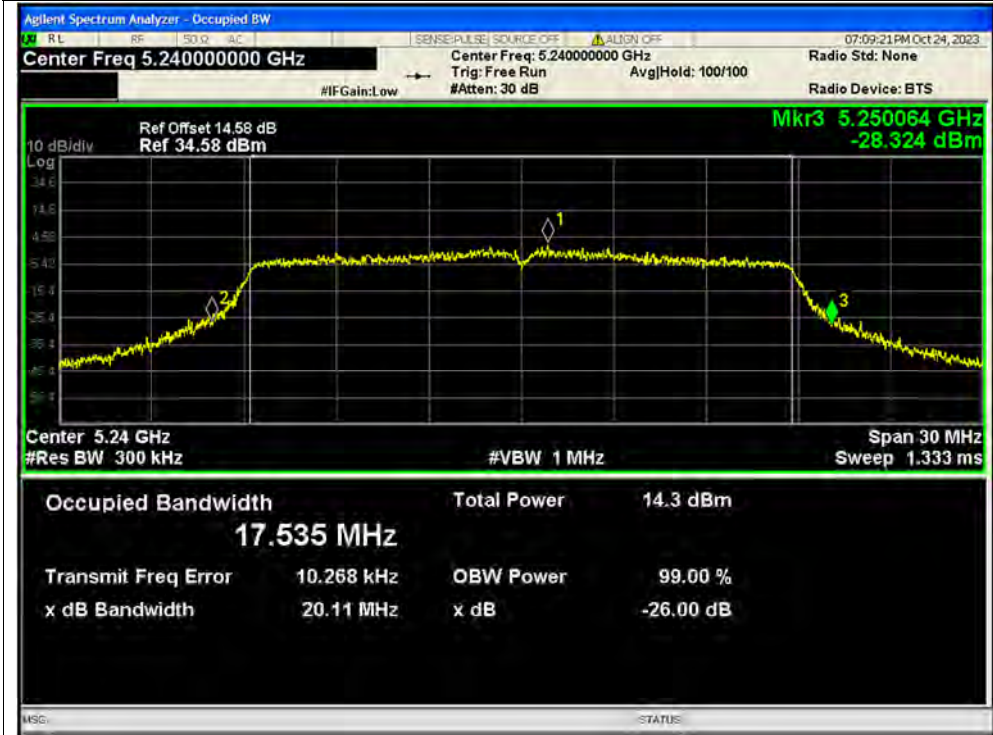

-26dB Bandwidth NVNT n20 5240MHz Ant2 MIMO

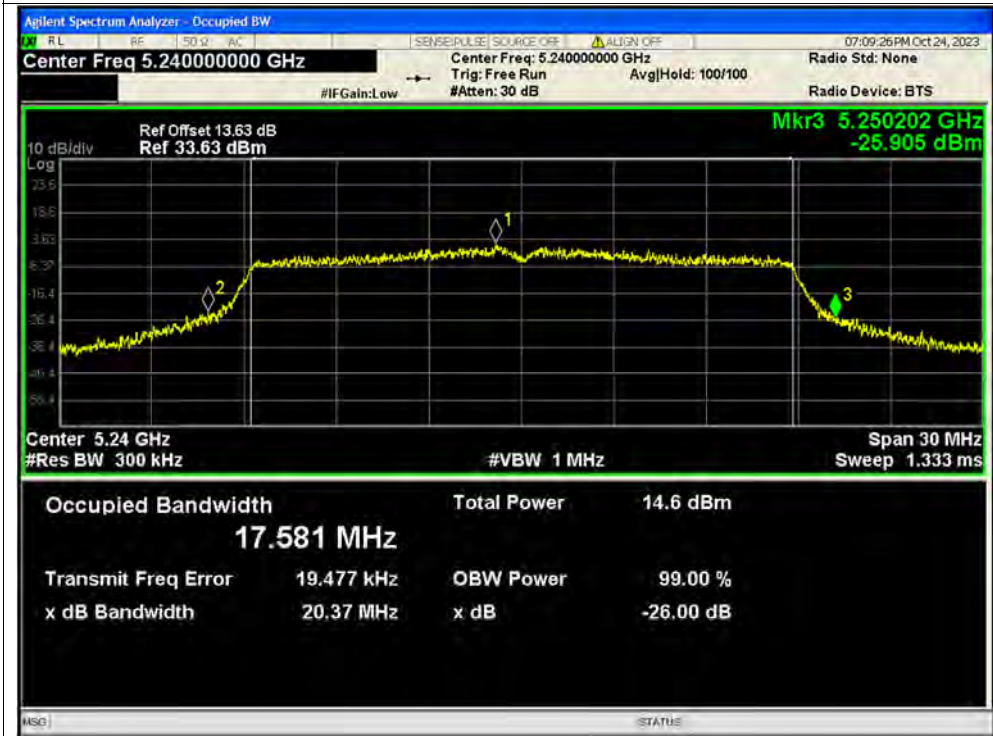



-26dB Bandwidth NVNT n20 5260MHz Ant1 MIMO



-26dB Bandwidth NVNT n20 5260MHz Ant2 MIMO

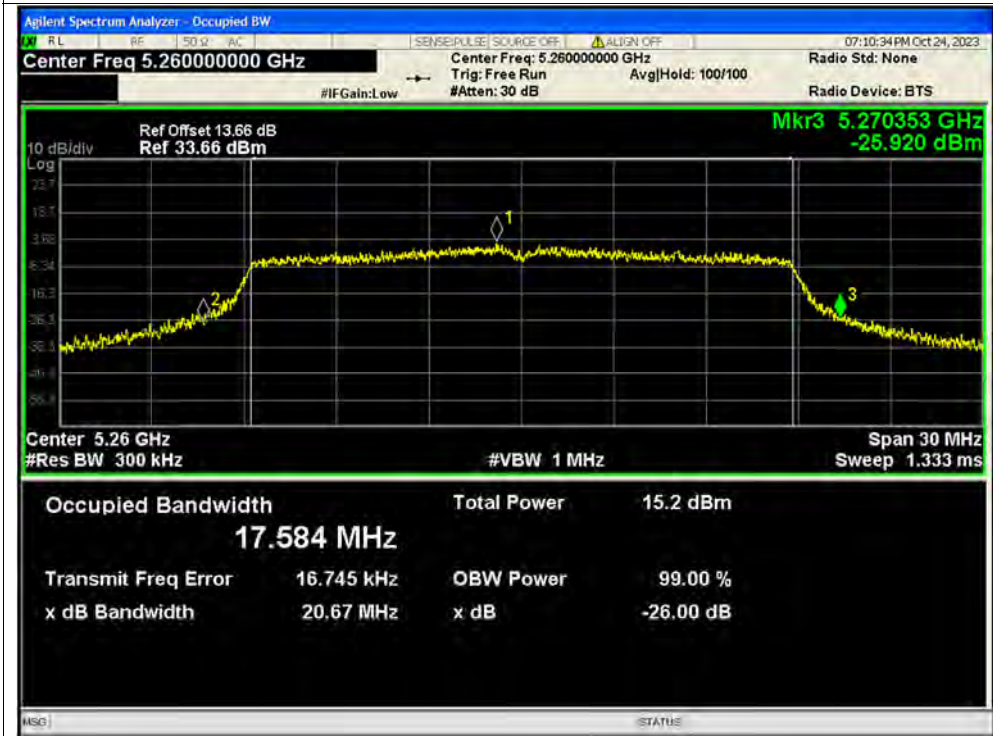



-26dB Bandwidth NVNT n20 5300MHz Ant1 MIMO

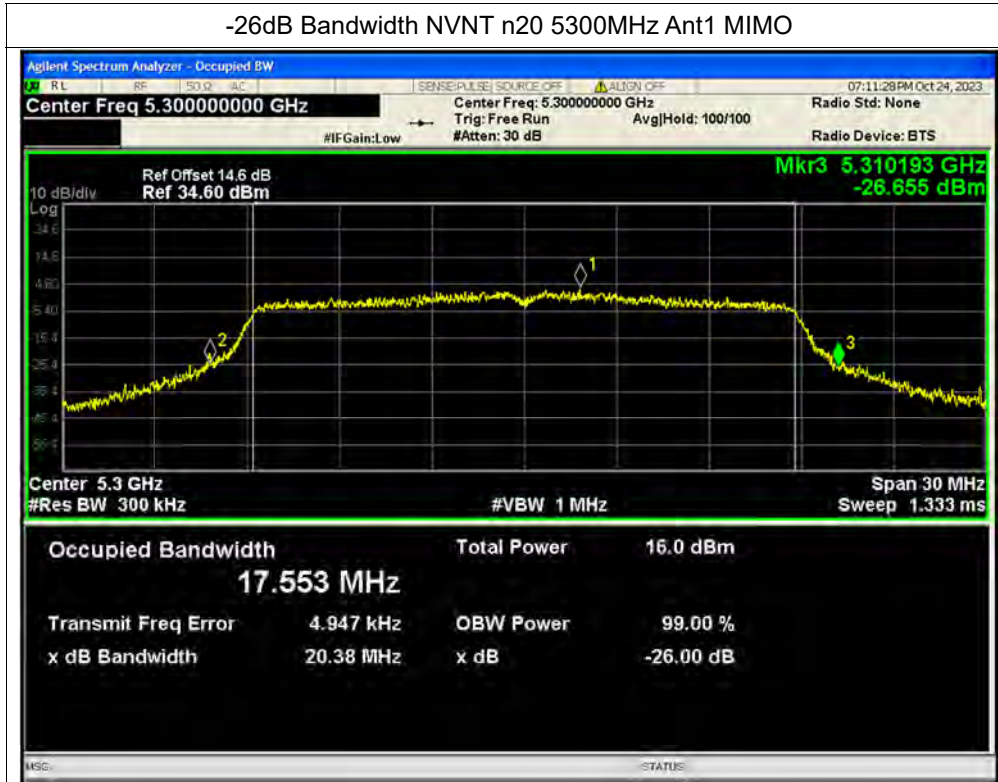

-26dB Bandwidth NVNT n20 5300MHz Ant2 MIMO



-26dB Bandwidth NVNT n20 5320MHz Ant1 MIMO

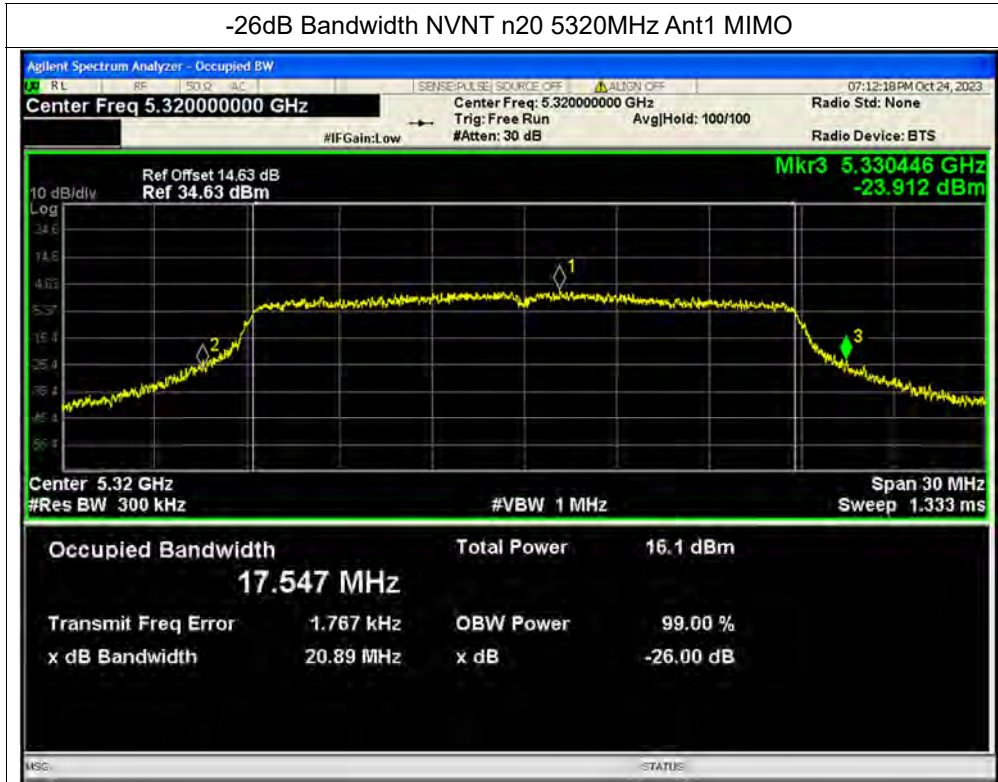

-26dB Bandwidth NVNT n20 5320MHz Ant2 MIMO





-26dB Bandwidth NVNT n20 5500MHz Ant1 MIMO



-26dB Bandwidth NVNT n20 5500MHz Ant2 MIMO

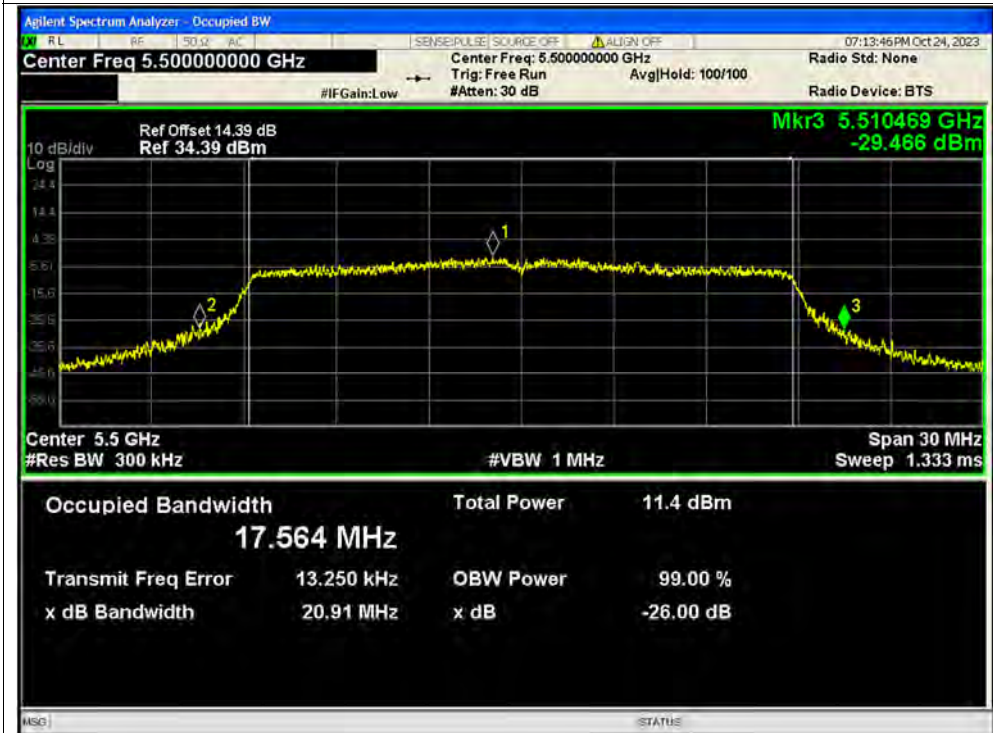



-26dB Bandwidth NVNT n20 5580MHz Ant1 MIMO



-26dB Bandwidth NVNT n20 5580MHz Ant2 MIMO





-26dB Bandwidth NVNT n20 5600MHz Ant1 MIMO



-26dB Bandwidth NVNT n20 5600MHz Ant2 MIMO





-26dB Bandwidth NVNT n20 5720MHz Ant1 MIMO

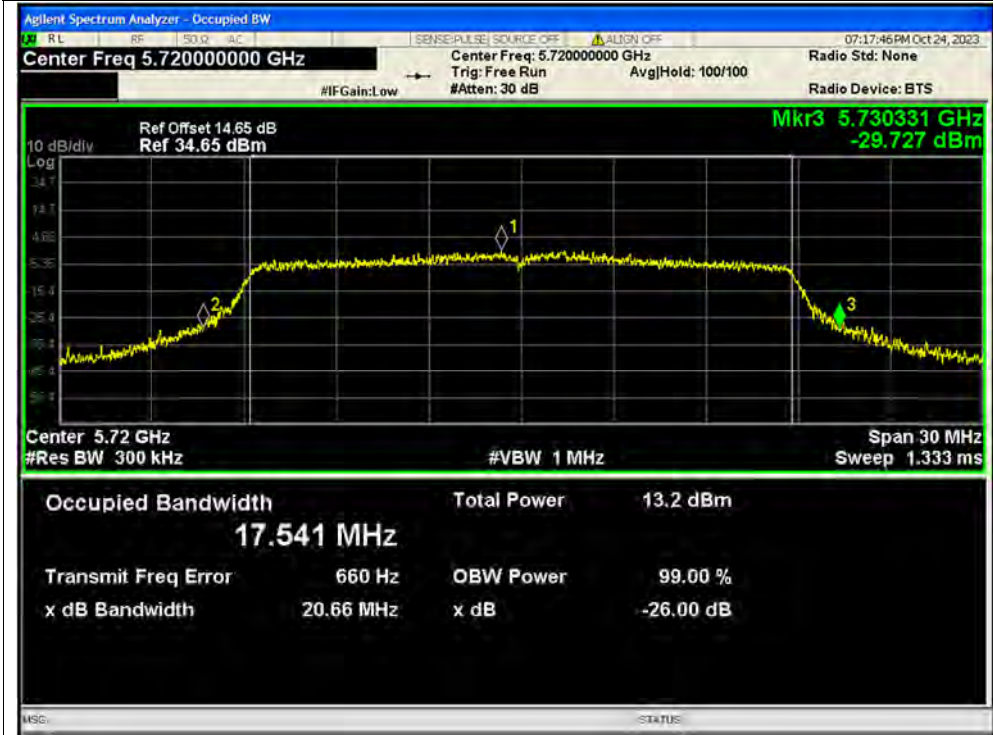

-26dB Bandwidth NVNT n20 5720MHz Ant2 MIMO

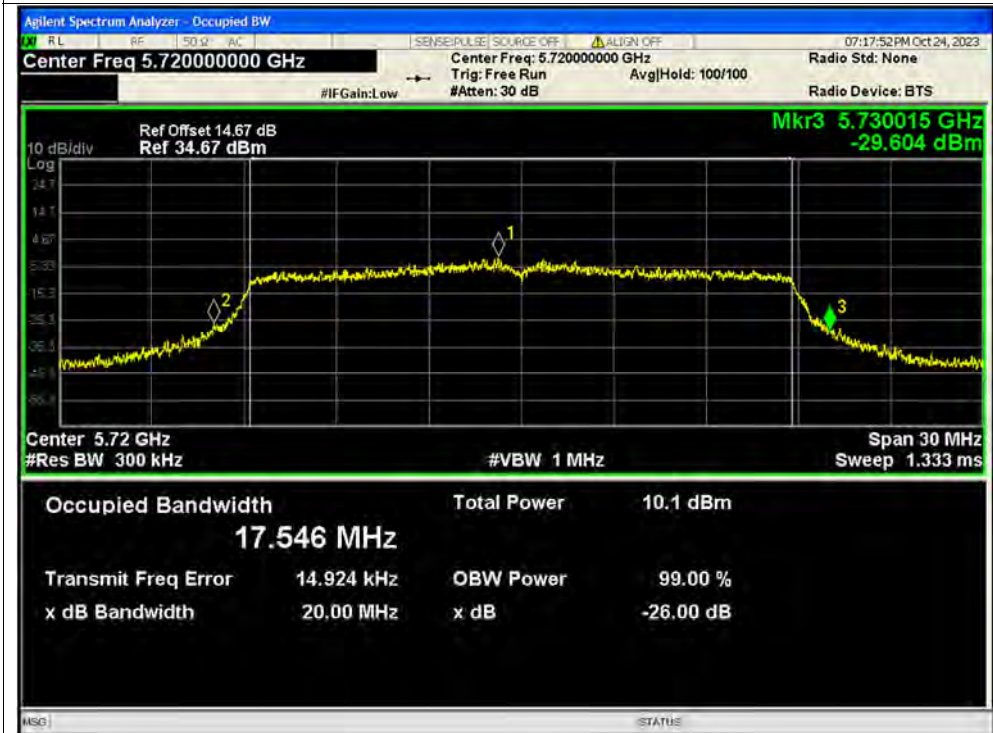



-26dB Bandwidth NVNT n40 5190MHz Ant1 SISO

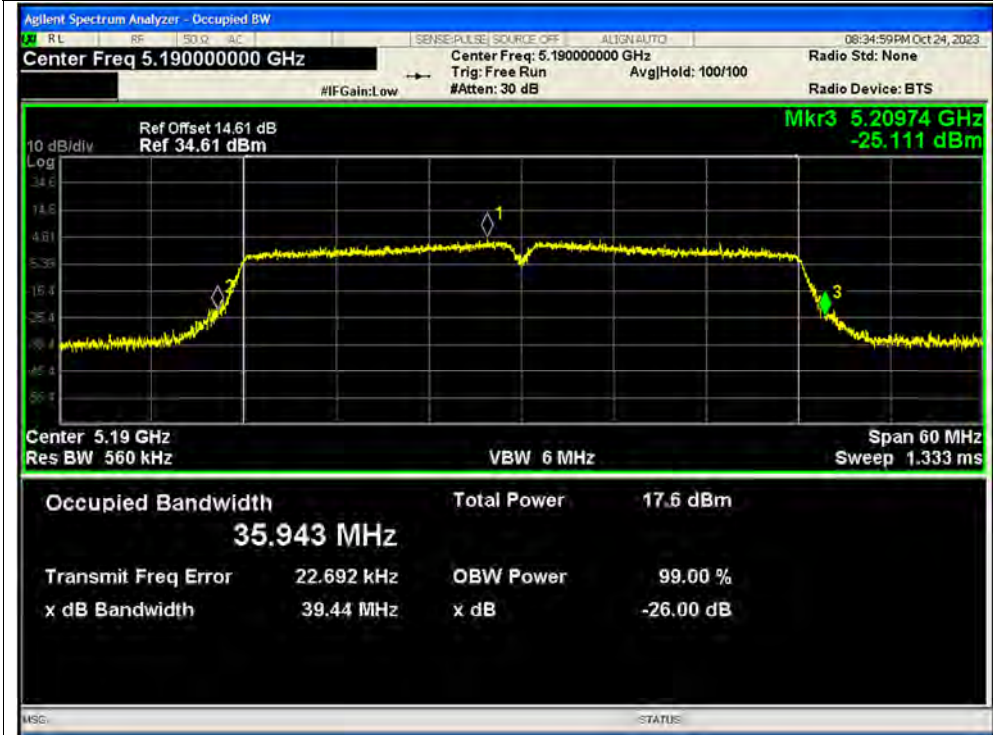

-26dB Bandwidth NVNT n40 5230MHz Ant1 SISO

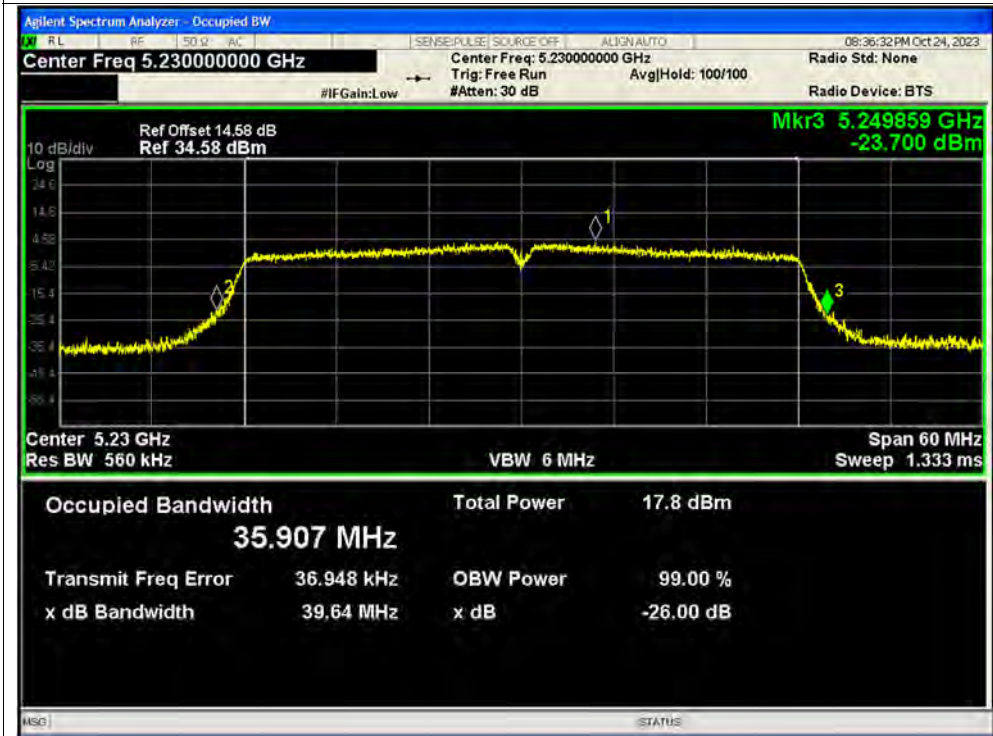



-26dB Bandwidth NVNT n40 5270MHz Ant1 SISO



-26dB Bandwidth NVNT n40 5310MHz Ant1 SISO





-26dB Bandwidth NVNT n40 5510MHz Ant1 SISO

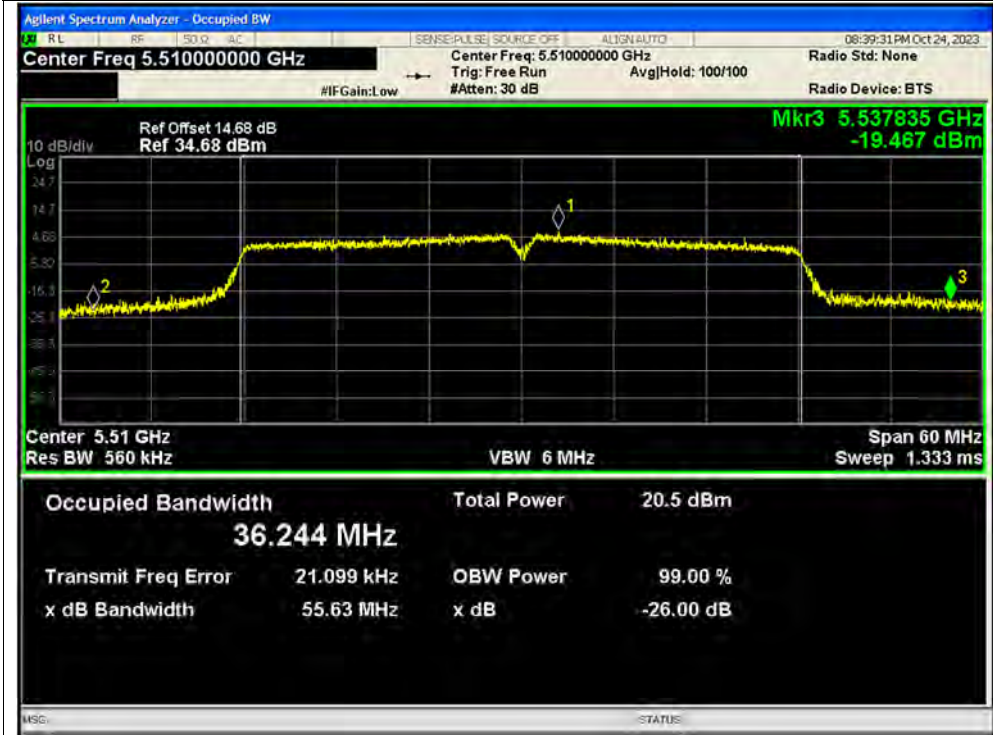

-26dB Bandwidth NVNT n40 5550MHz Ant1 SISO

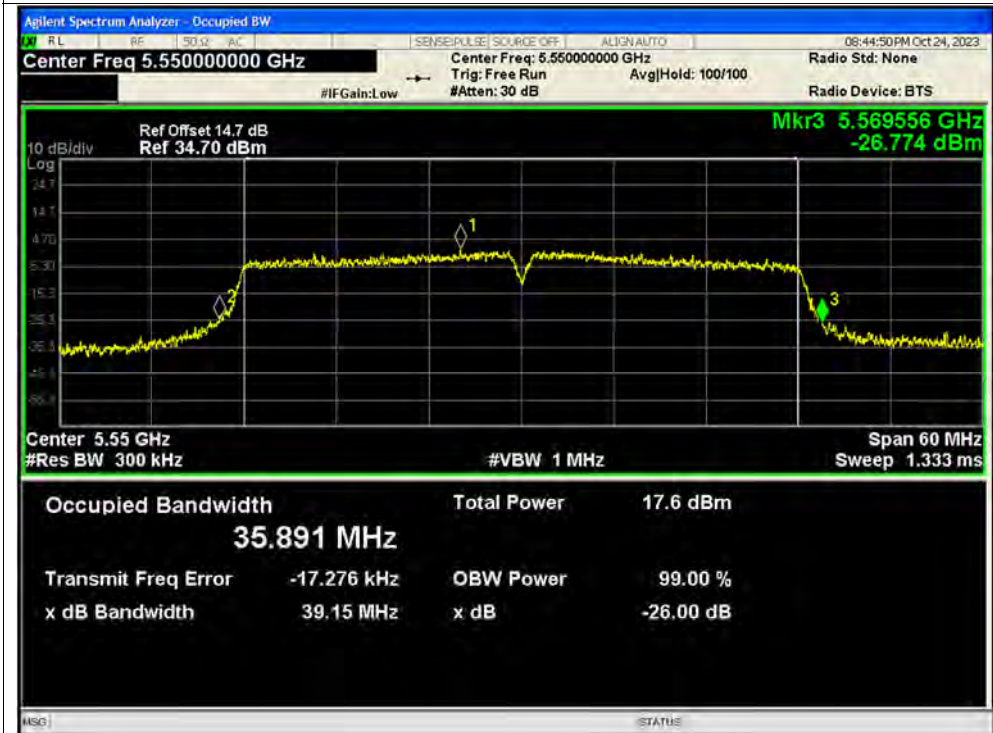



-26dB Bandwidth NVNT n40 5630MHz Ant1 SISO

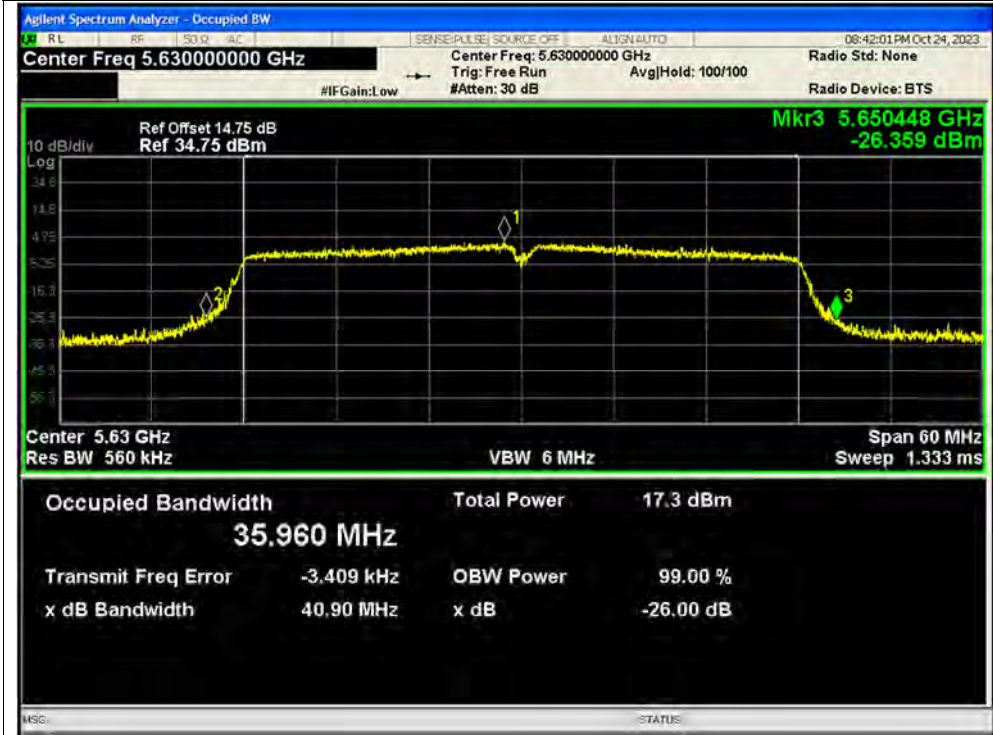

-26dB Bandwidth NVNT n40 5710MHz Ant1 SISO

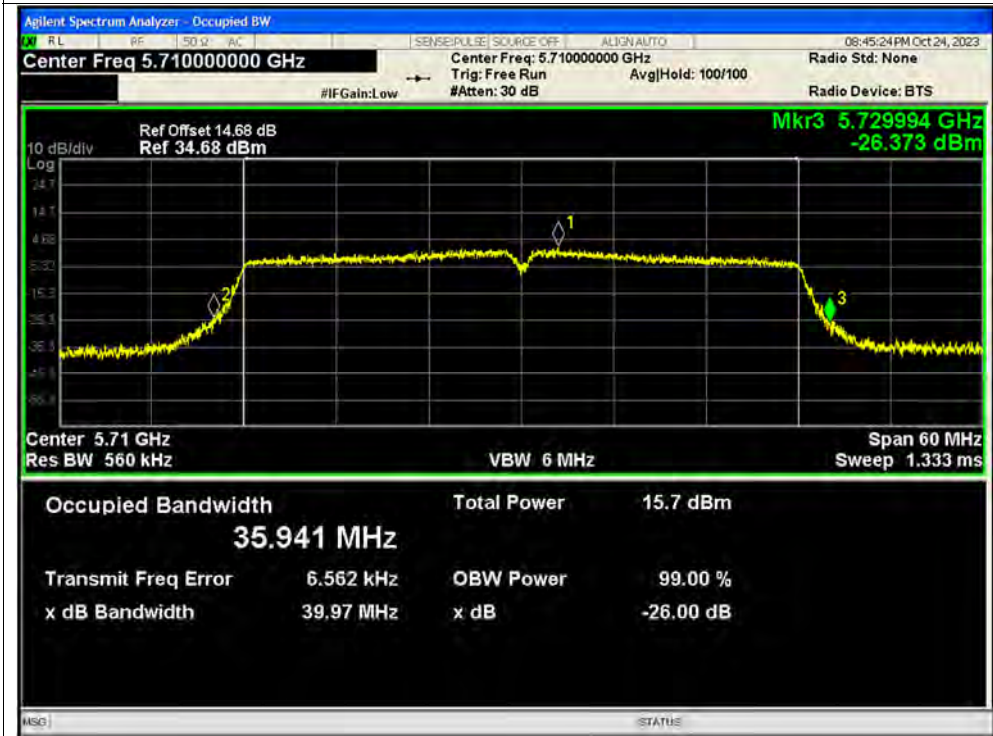



-26dB Bandwidth NVNT n40 5190MHz Ant2 SISO

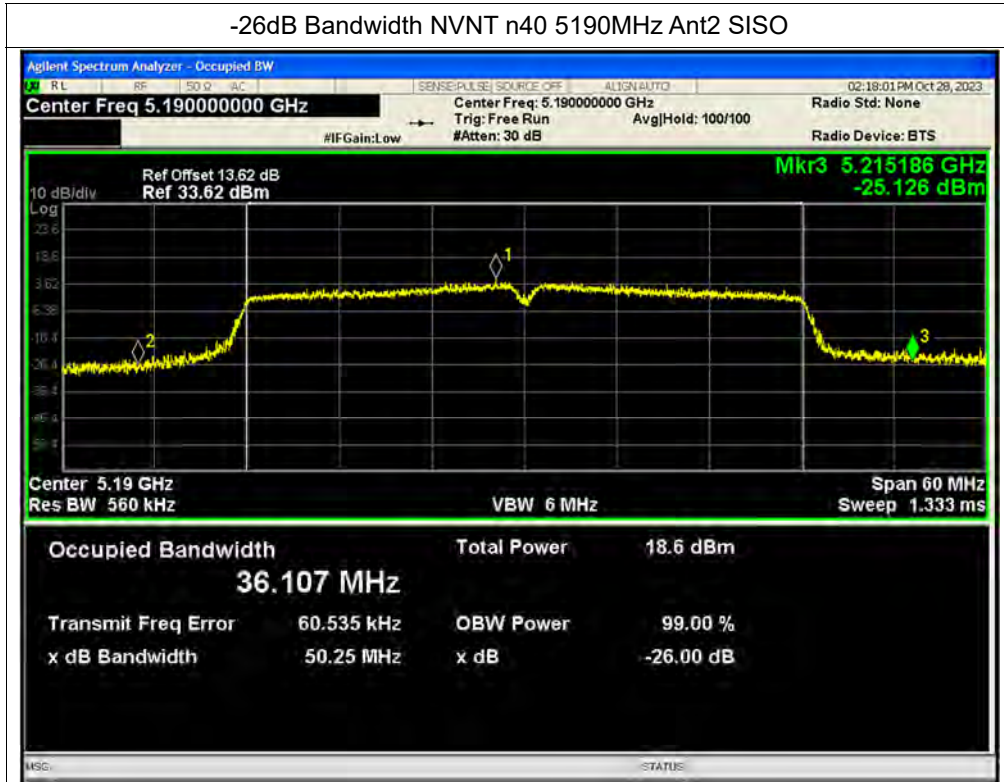

-26dB Bandwidth NVNT n40 5230MHz Ant2 SISO





-26dB Bandwidth NVNT n40 5270MHz Ant2 SISO



-26dB Bandwidth NVNT n40 5310MHz Ant2 SISO





-26dB Bandwidth NVNT n40 5510MHz Ant2 SISO



-26dB Bandwidth NVNT n40 5550MHz Ant2 SISO

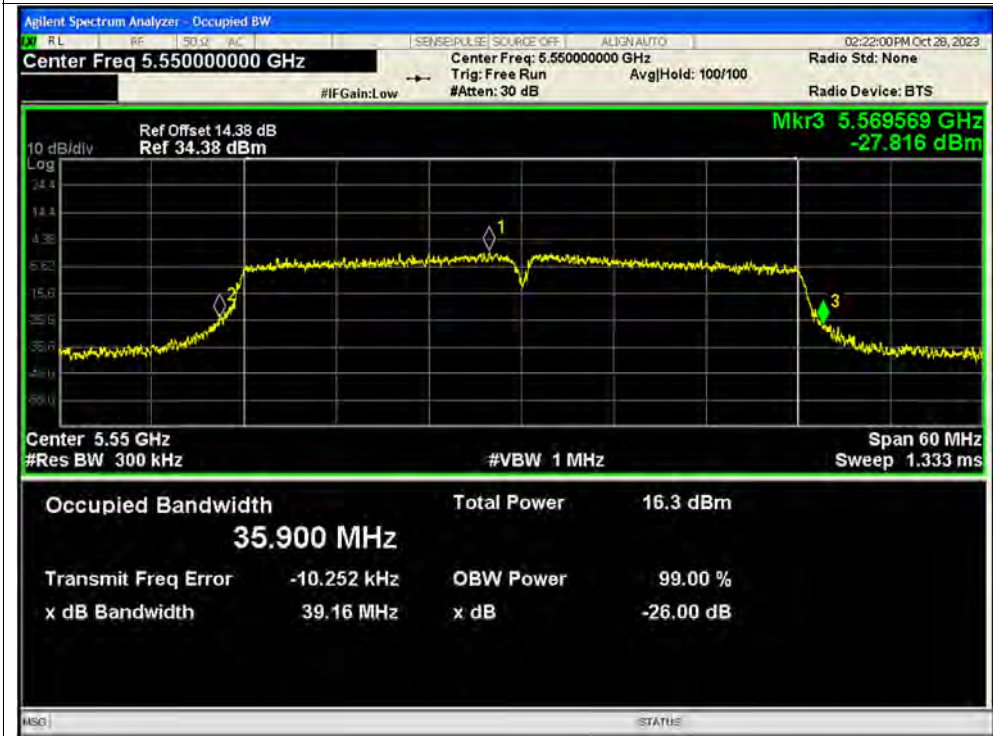



-26dB Bandwidth NVNT n40 5630MHz Ant2 SISO

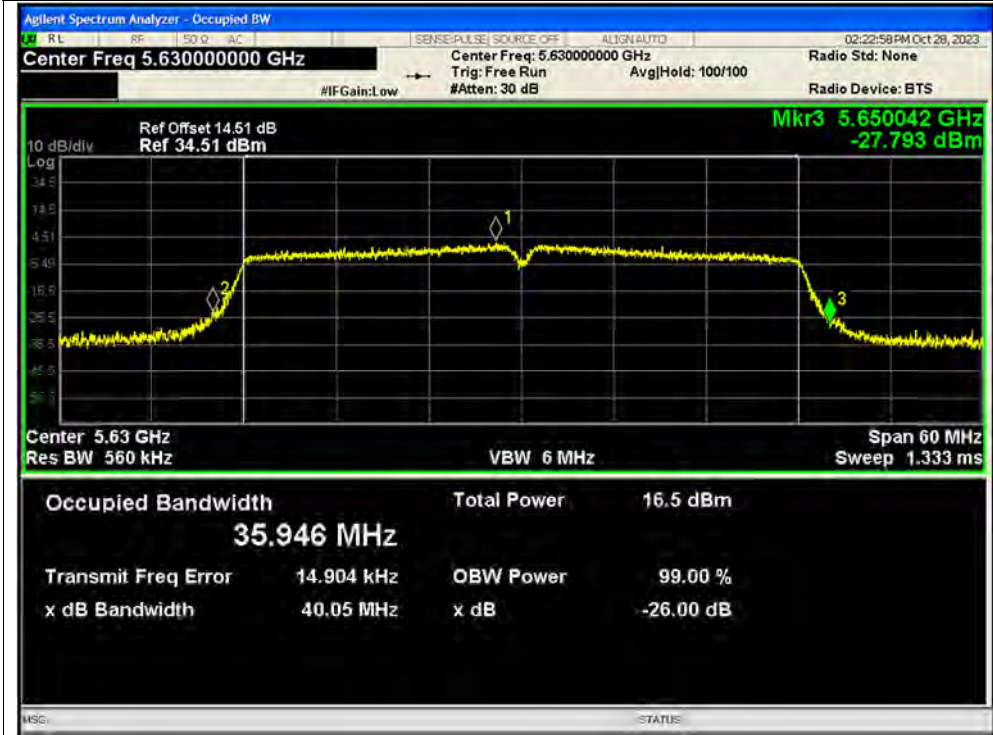

-26dB Bandwidth NVNT n40 5710MHz Ant2 SISO

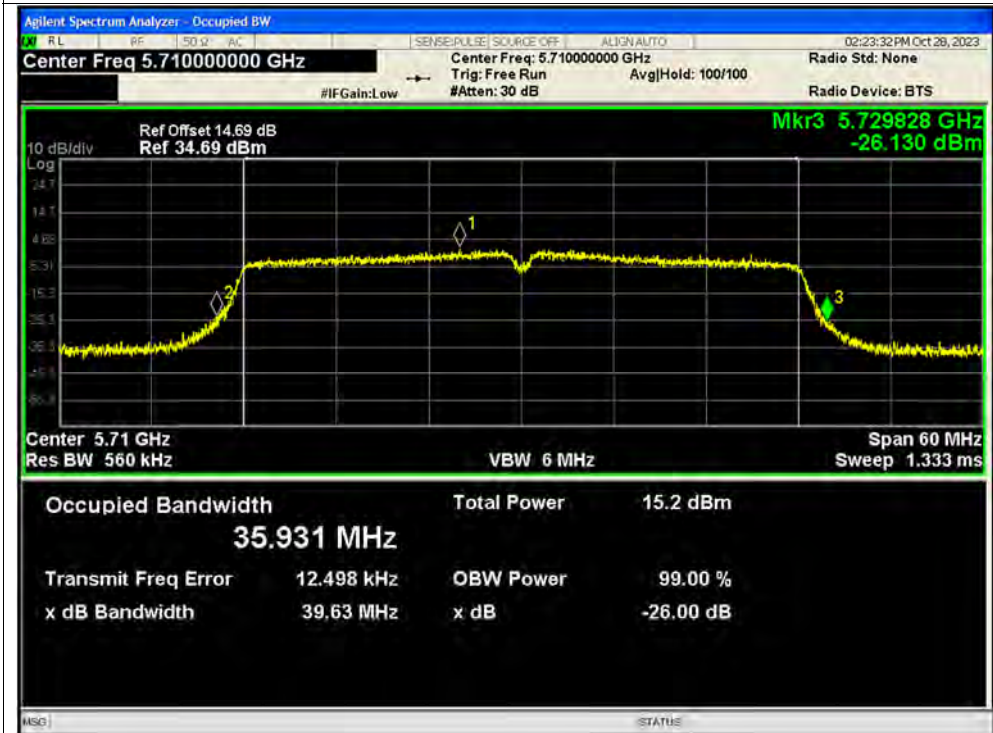



-26dB Bandwidth NVNT n40 5190MHz Ant1 MIMO

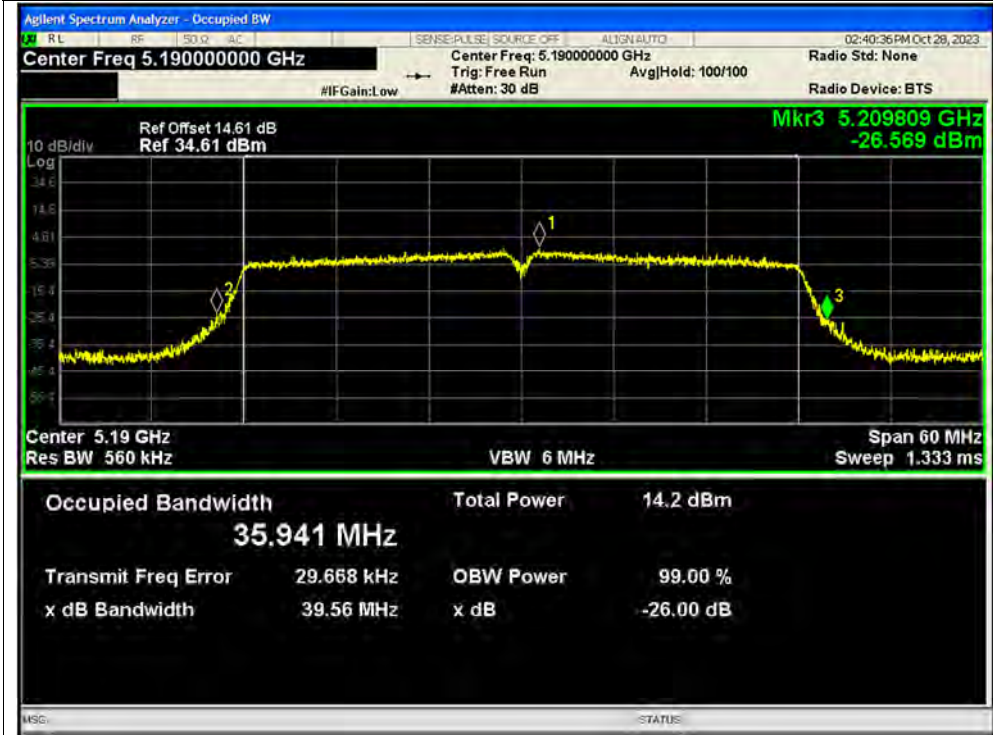

-26dB Bandwidth NVNT n40 5190MHz Ant2 MIMO





-26dB Bandwidth NVNT n40 5230MHz Ant1 MIMO

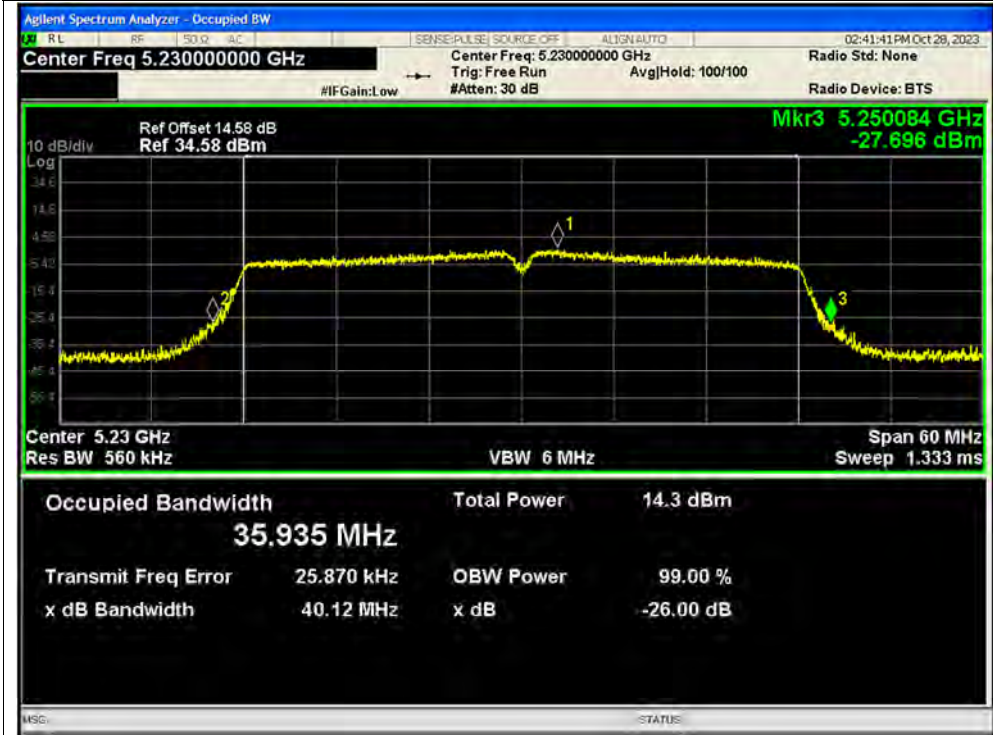

-26dB Bandwidth NVNT n40 5230MHz Ant2 MIMO

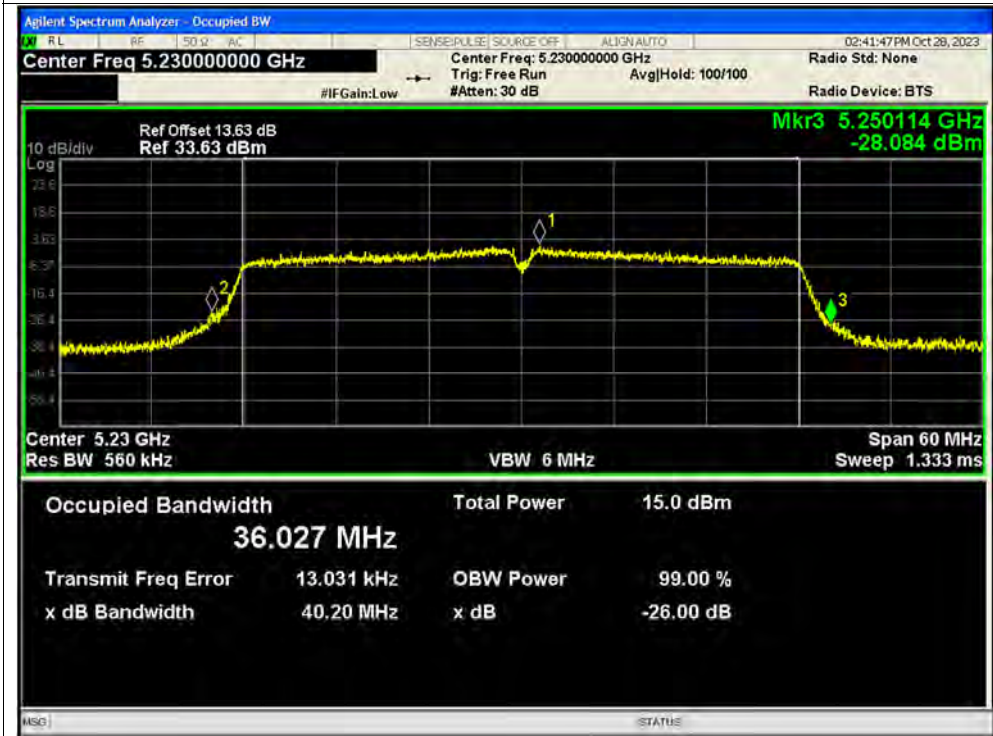



-26dB Bandwidth NVNT n40 5270MHz Ant1 MIMO



-26dB Bandwidth NVNT n40 5270MHz Ant2 MIMO





-26dB Bandwidth NVNT n40 5310MHz Ant1 MIMO

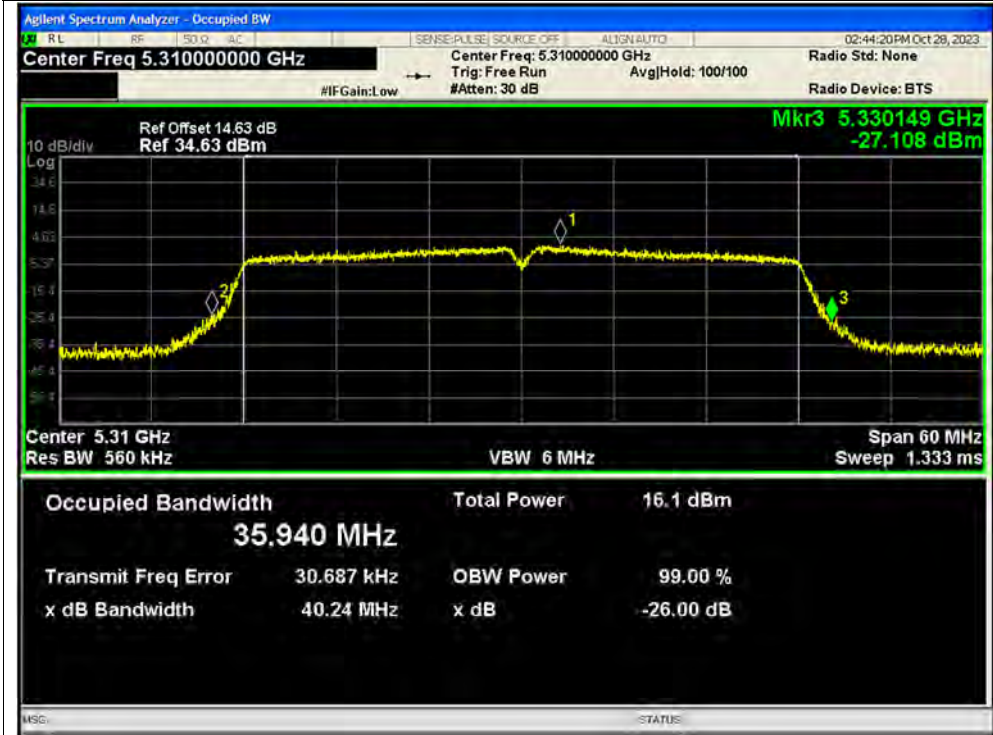

-26dB Bandwidth NVNT n40 5310MHz Ant2 MIMO

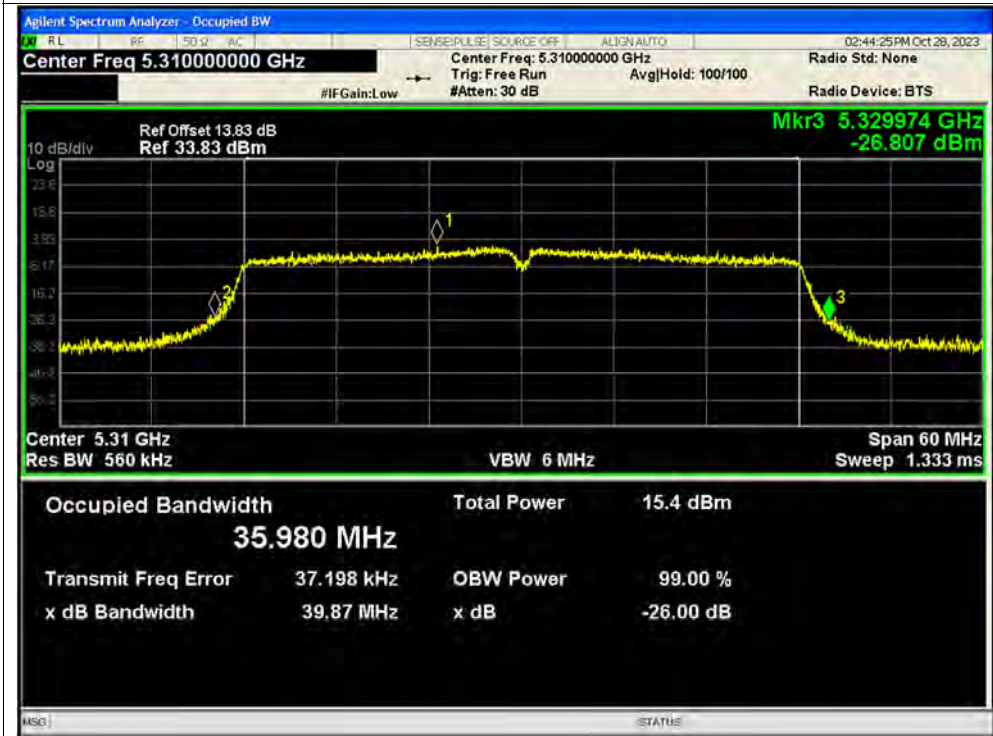



-26dB Bandwidth NVNT n40 5510MHz Ant1 MIMO

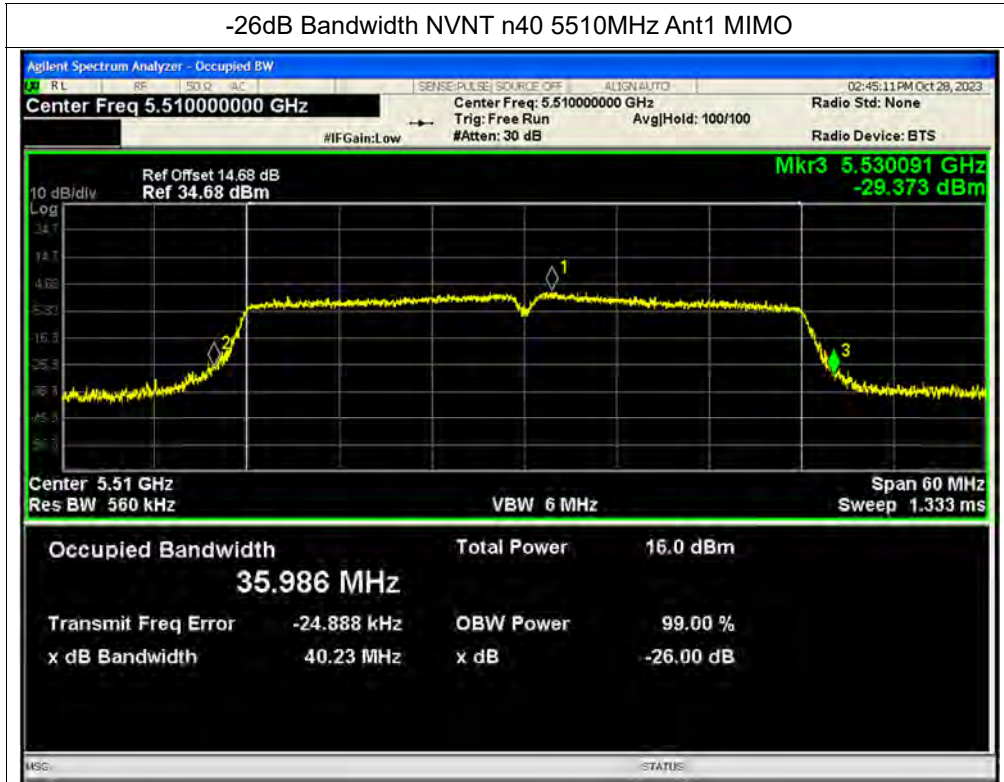

-26dB Bandwidth NVNT n40 5510MHz Ant2 MIMO

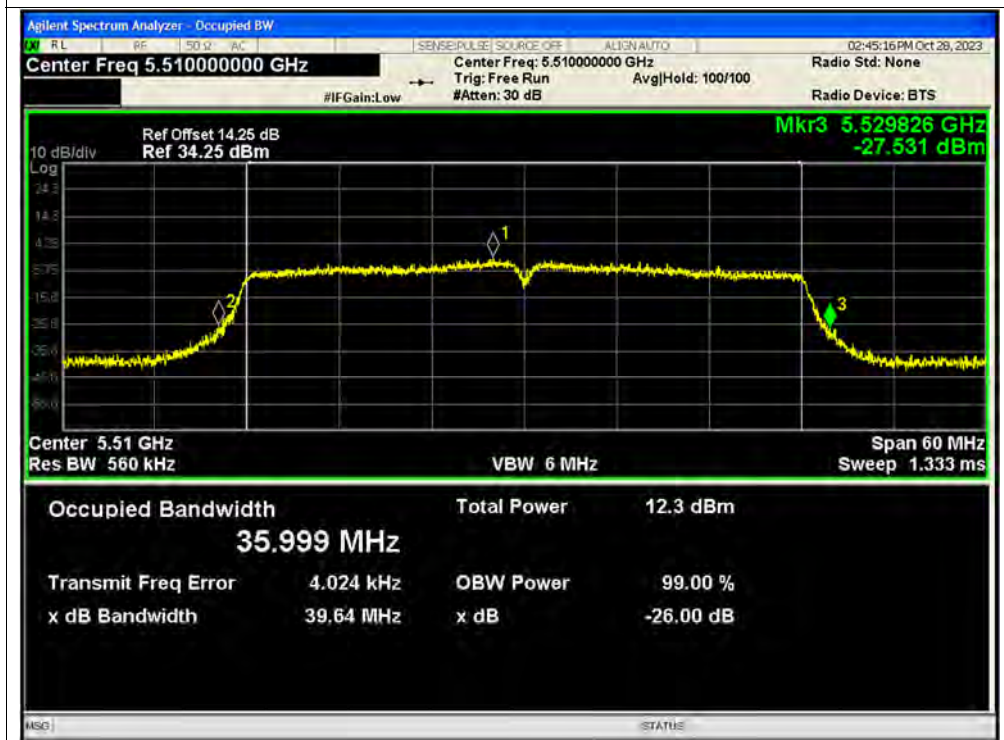



-26dB Bandwidth NVNT n40 5550MHz Ant1 MIMO

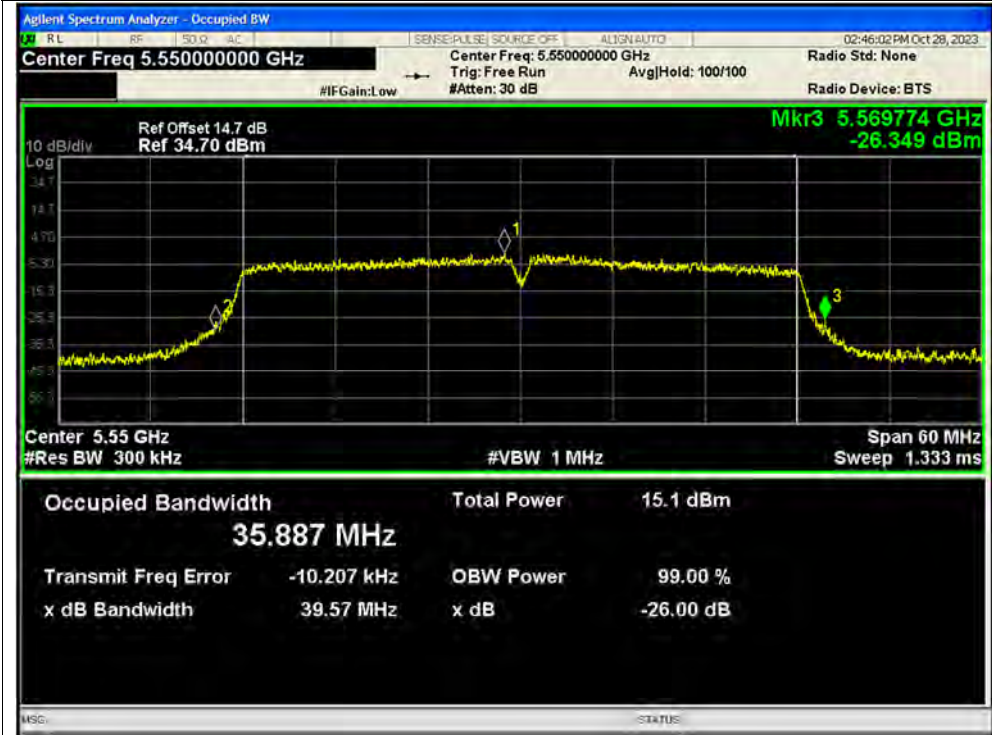

-26dB Bandwidth NVNT n40 5550MHz Ant2 MIMO





-26dB Bandwidth NVNT n40 5630MHz Ant1 MIMO



-26dB Bandwidth NVNT n40 5630MHz Ant2 MIMO

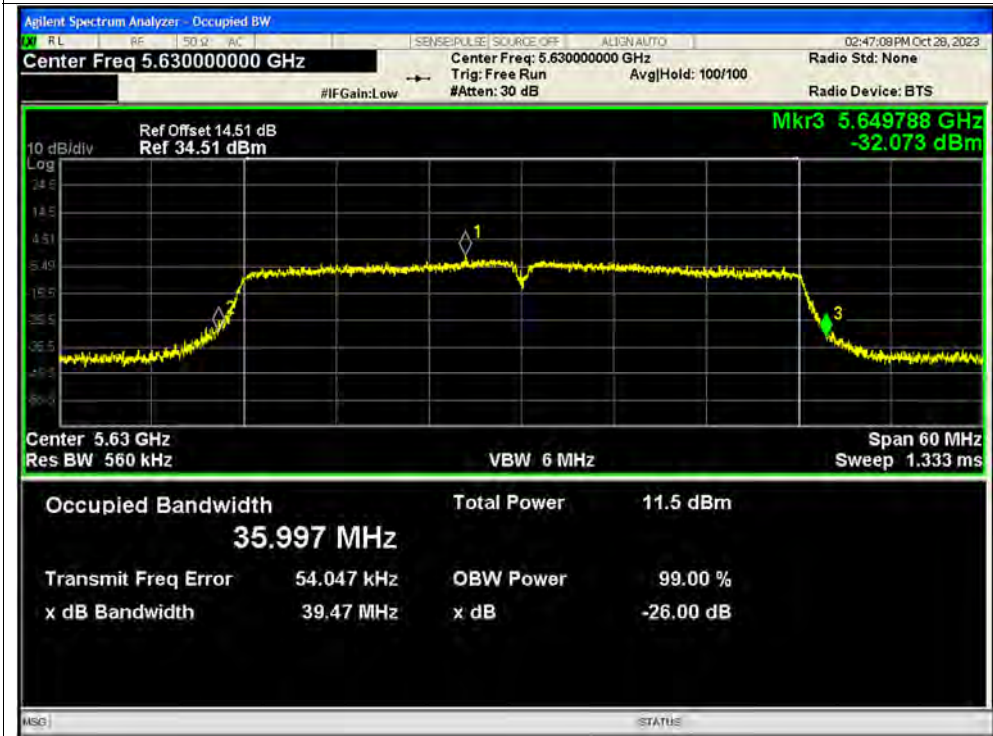



-26dB Bandwidth NVNT n40 5710MHz Ant1 MIMO

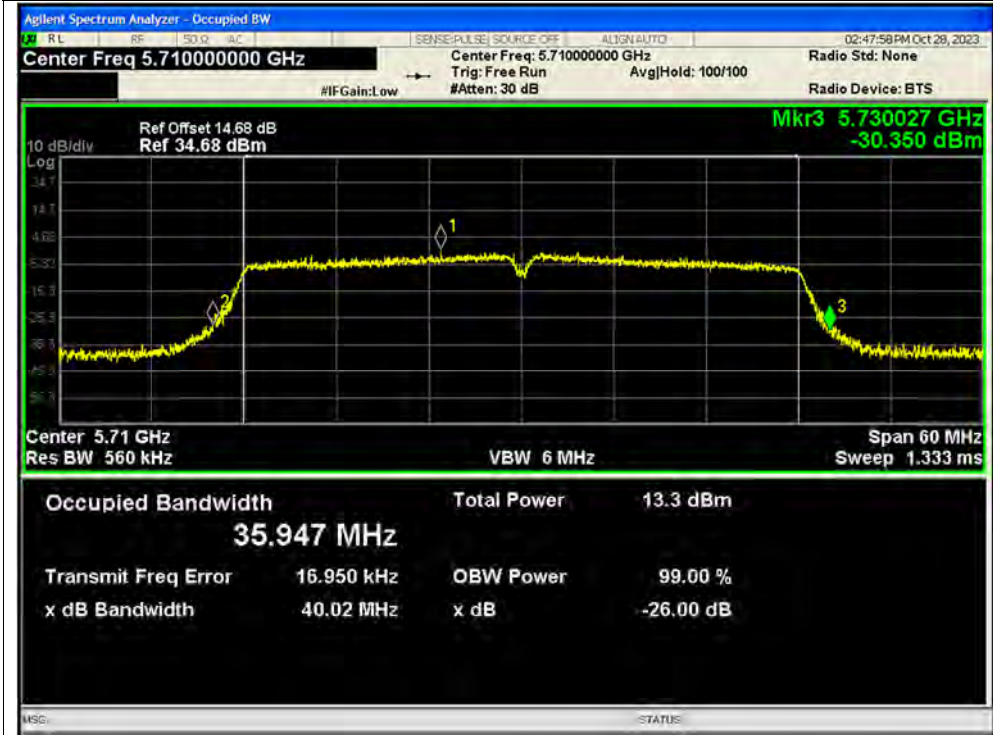

-26dB Bandwidth NVNT n40 5710MHz Ant2 MIMO

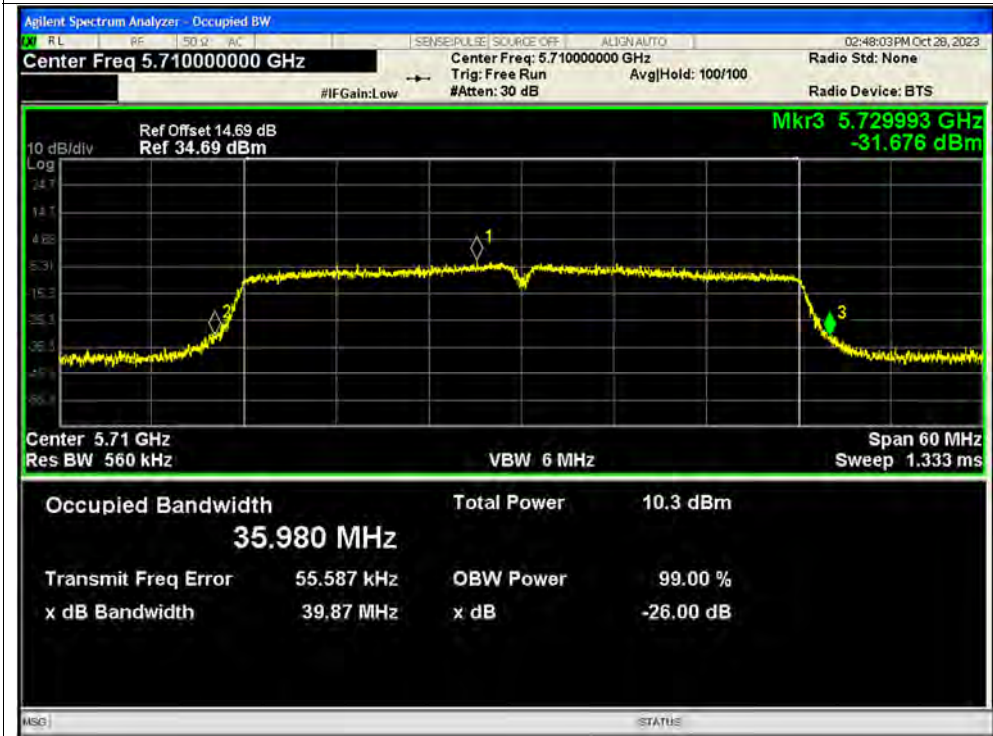



-26dB Bandwidth NVNT ac20 5180MHz Ant1 SISO



-26dB Bandwidth NVNT ac20 5220MHz Ant1 SISO





-26dB Bandwidth NVNT ac20 5240MHz Ant1 SISO

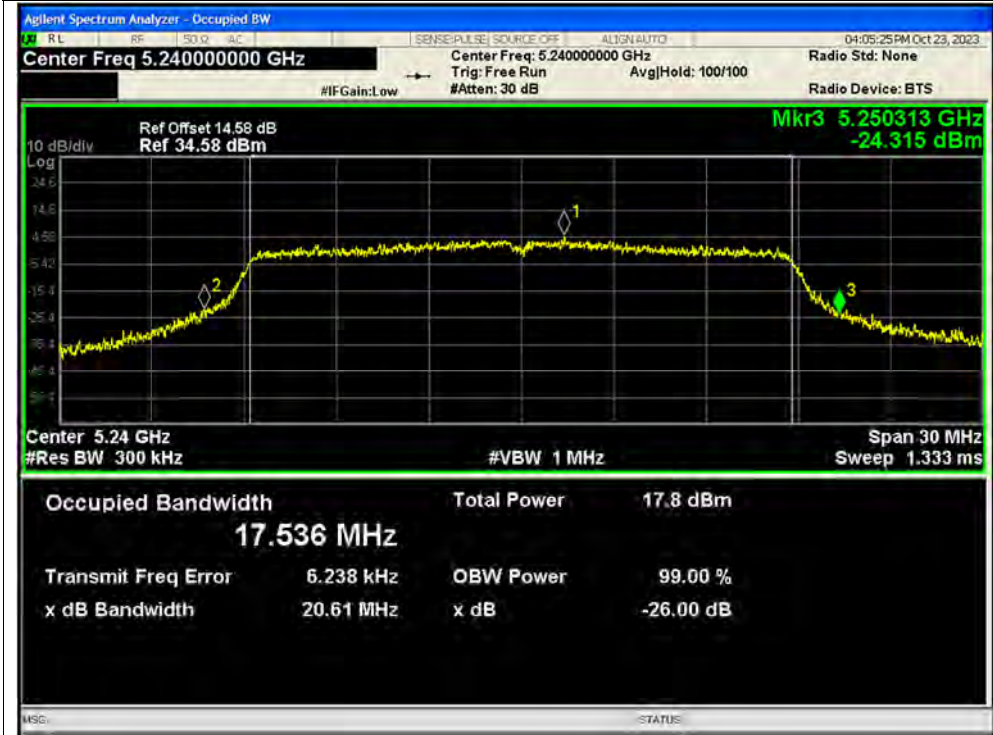

-26dB Bandwidth NVNT ac20 5260MHz Ant1 SISO





-26dB Bandwidth NVNT ac20 5300MHz Ant1 SISO



-26dB Bandwidth NVNT ac20 5320MHz Ant1 SISO





-26dB Bandwidth NVNT ac20 5500MHz Ant1 SISO

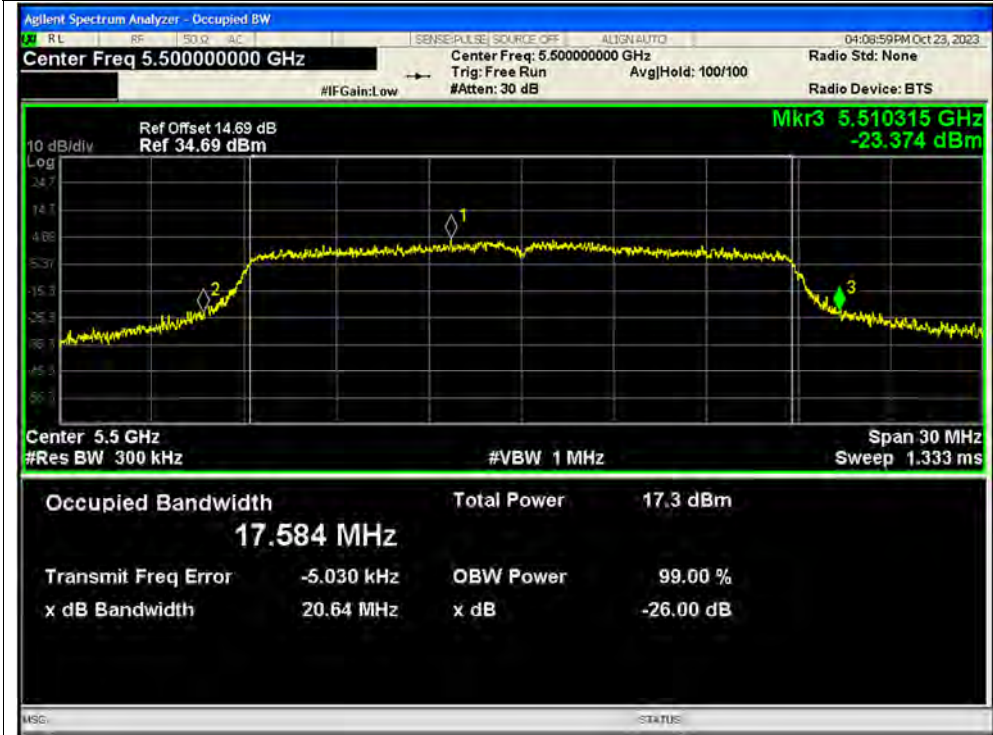

-26dB Bandwidth NVNT ac20 5580MHz Ant1 SISO





-26dB Bandwidth NVNT ac20 5600MHz Ant1 SISO



-26dB Bandwidth NVNT ac20 5720MHz Ant1 SISO

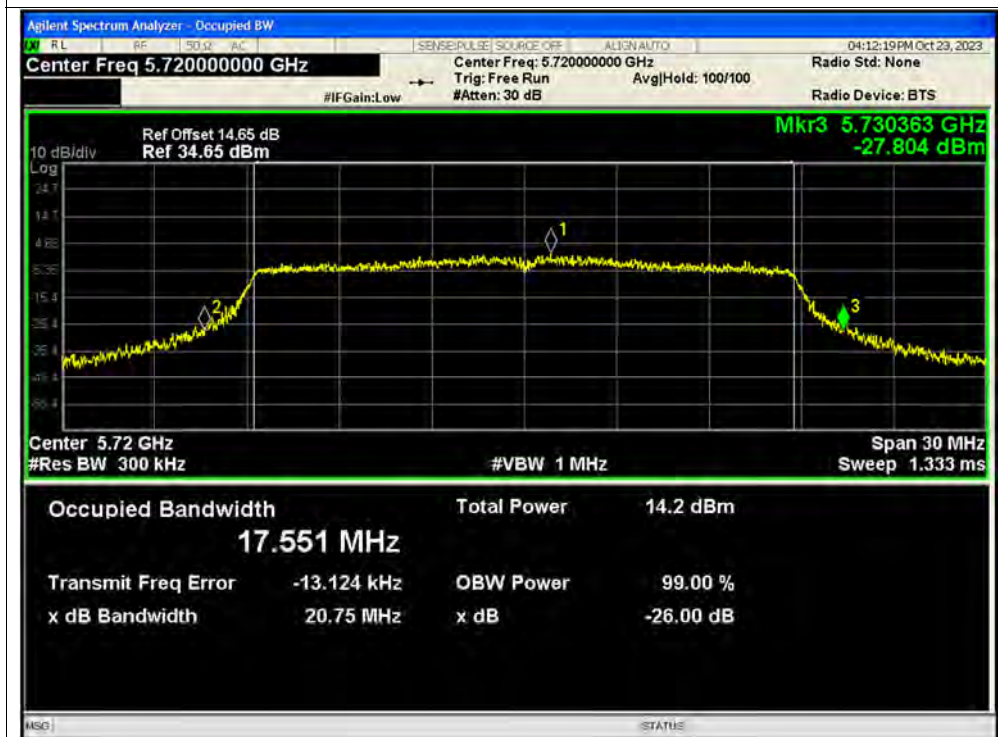



-26dB Bandwidth NVNT ac20 5180MHz Ant2 SISO

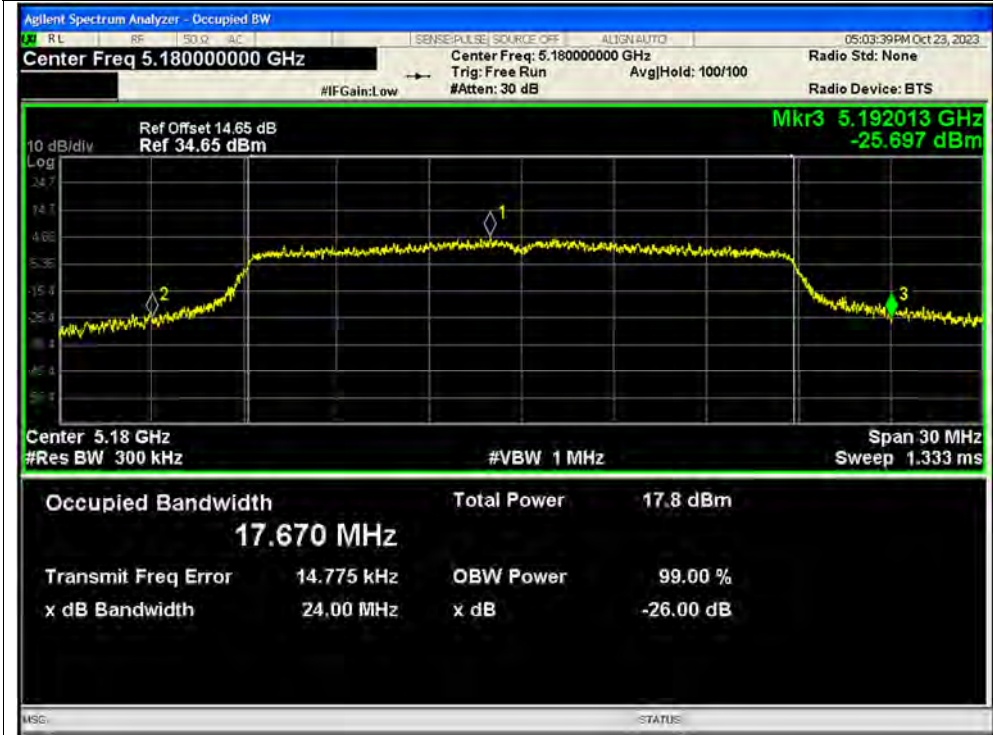

-26dB Bandwidth NVNT ac20 5220MHz Ant2 SISO

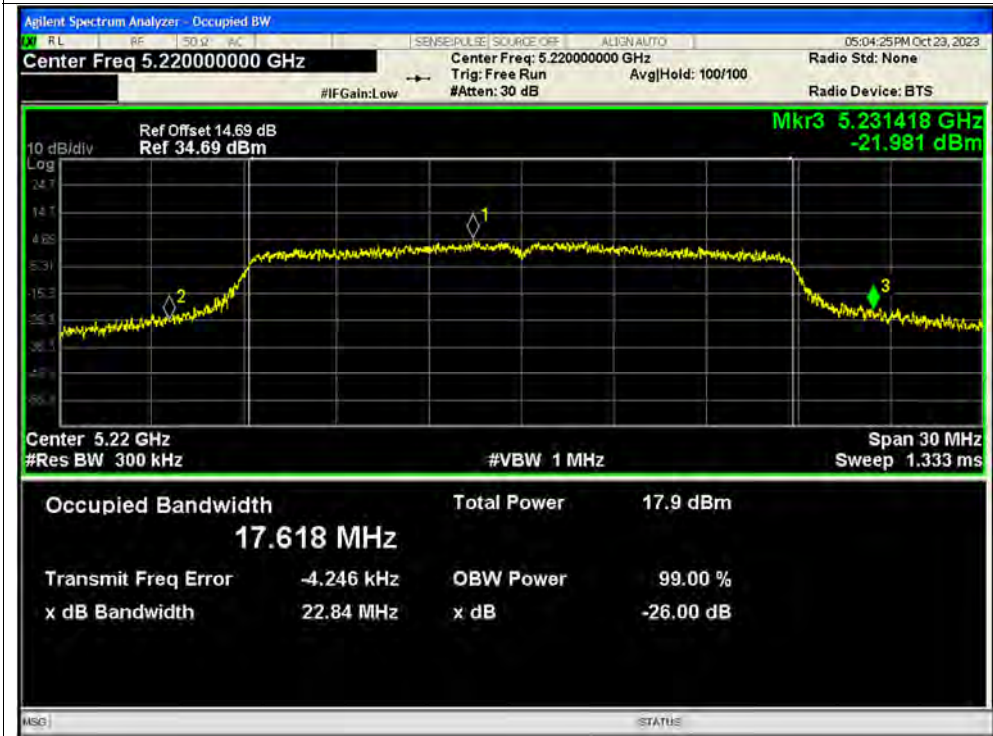



-26dB Bandwidth NVNT ac20 5240MHz Ant2 SISO

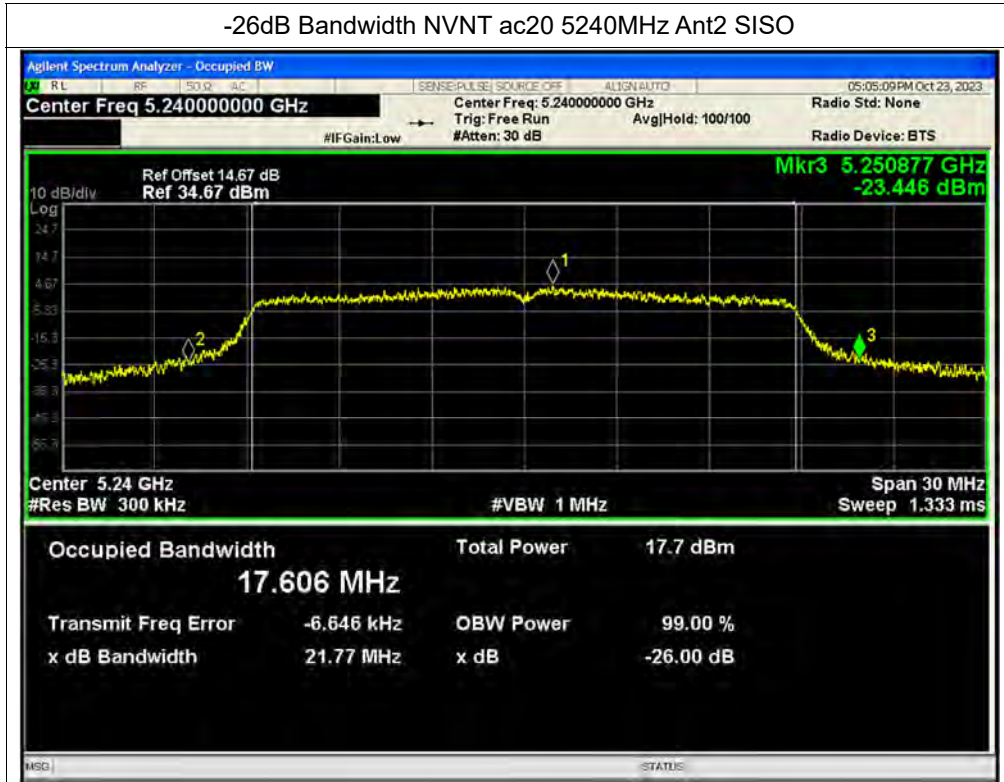

-26dB Bandwidth NVNT ac20 5260MHz Ant2 SISO





-26dB Bandwidth NVNT ac20 5300MHz Ant2 SISO



-26dB Bandwidth NVNT ac20 5320MHz Ant2 SISO

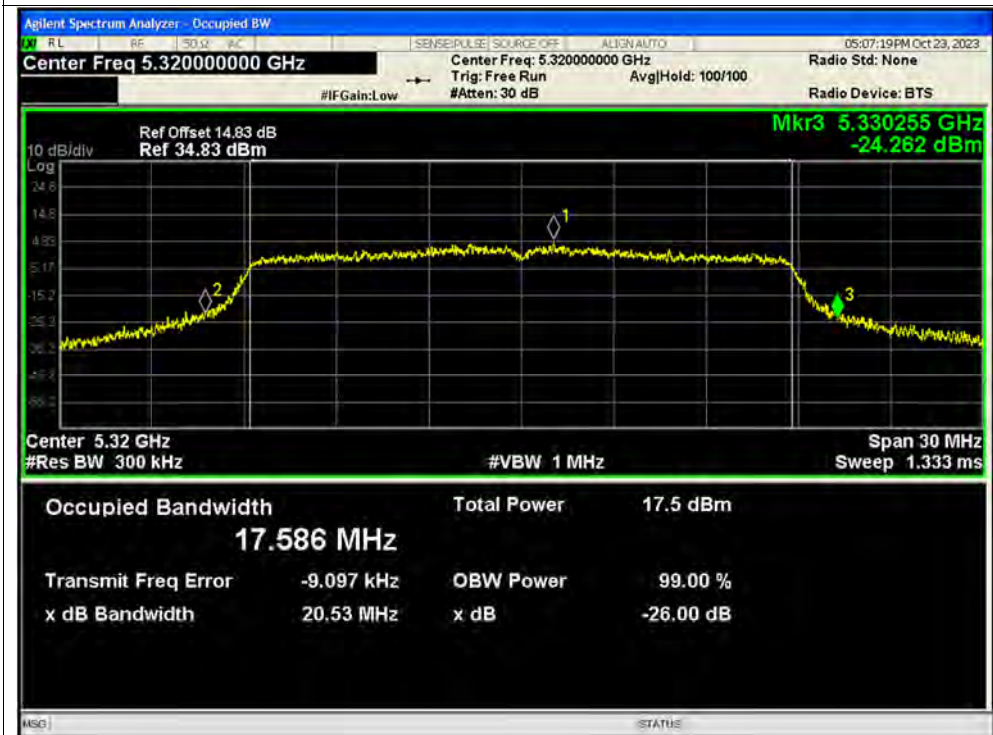



-26dB Bandwidth NVNT ac20 5500MHz Ant2 SISO

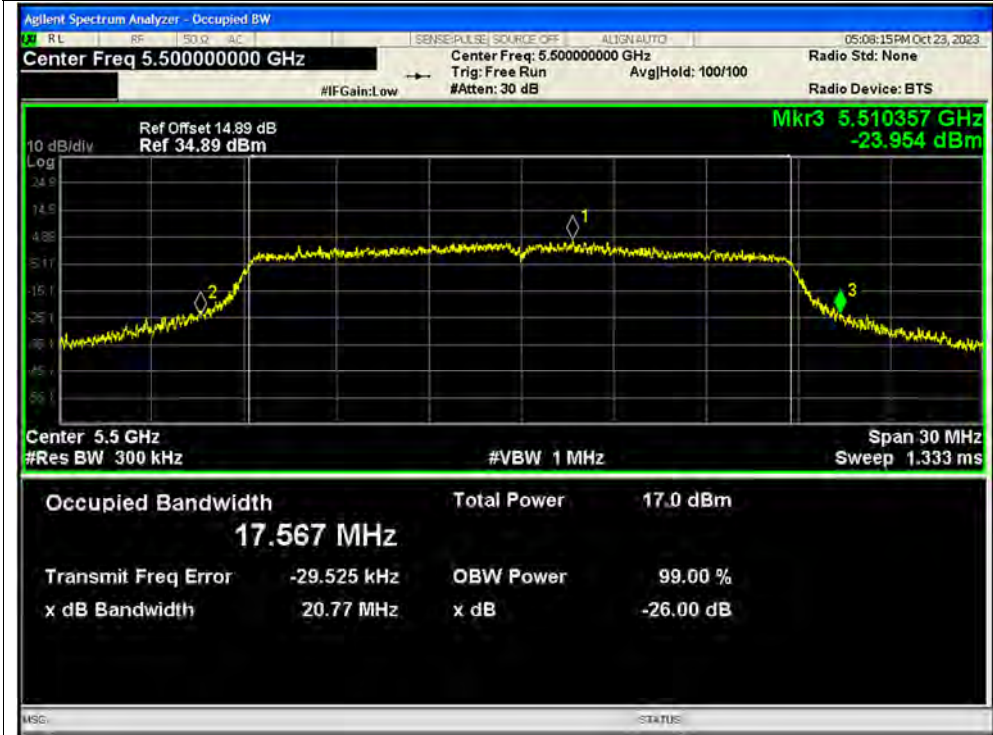

-26dB Bandwidth NVNT ac20 5580MHz Ant2 SISO

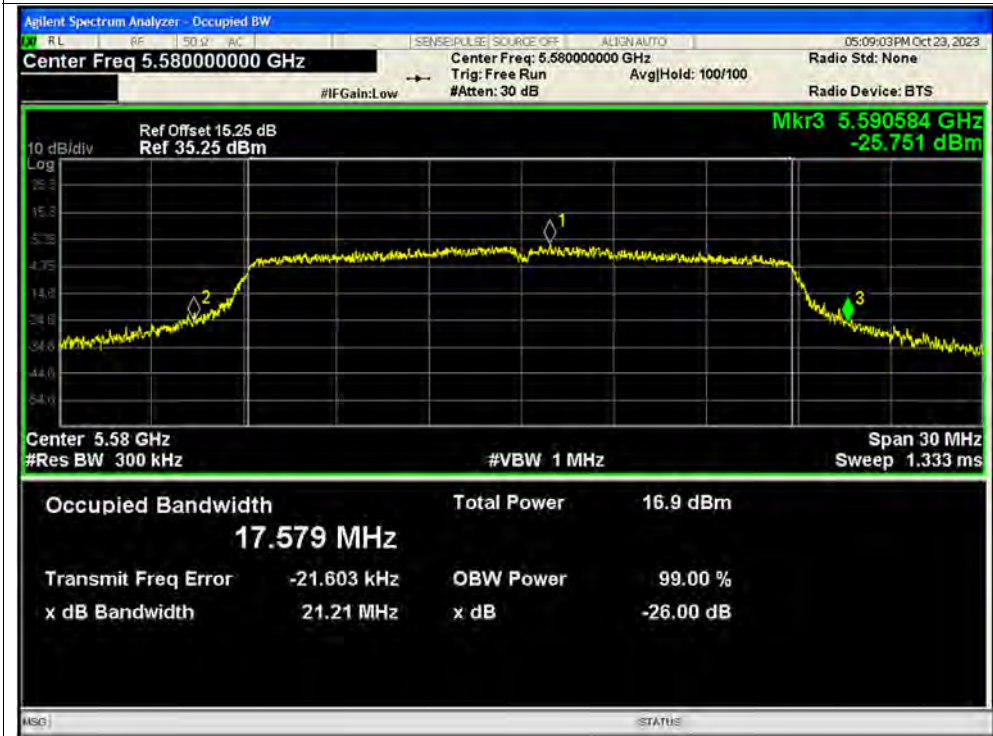



-26dB Bandwidth NVNT ac20 5600MHz Ant2 SISO



-26dB Bandwidth NVNT ac20 5720MHz Ant2 SISO

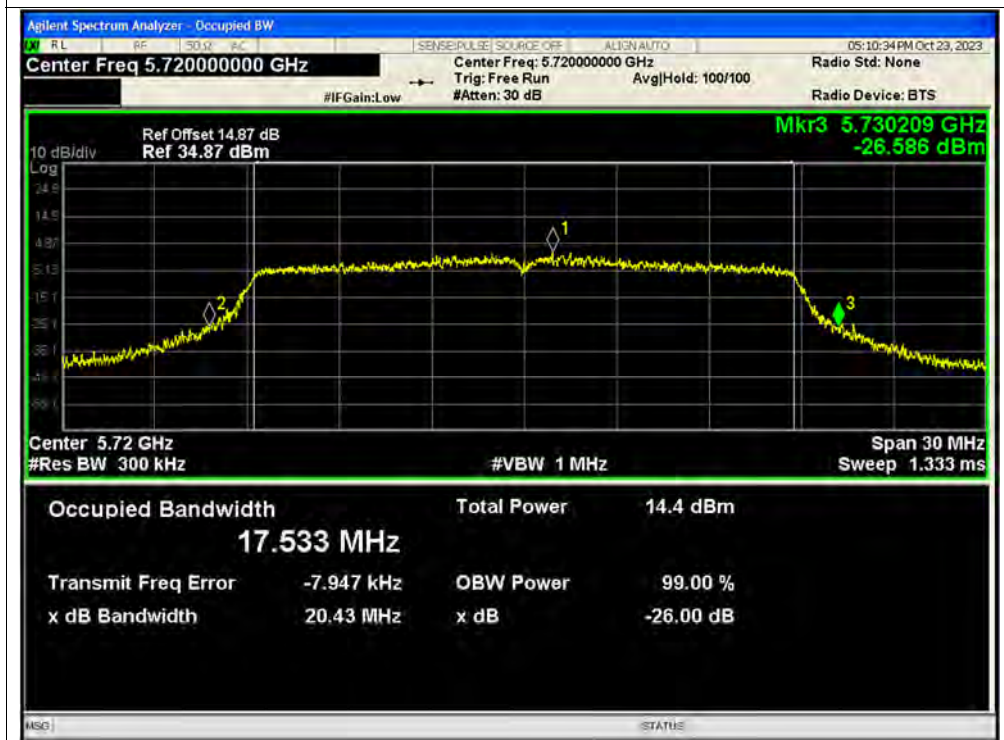



-26dB Bandwidth NVNT ac20 5180MHz Ant1 MIMO

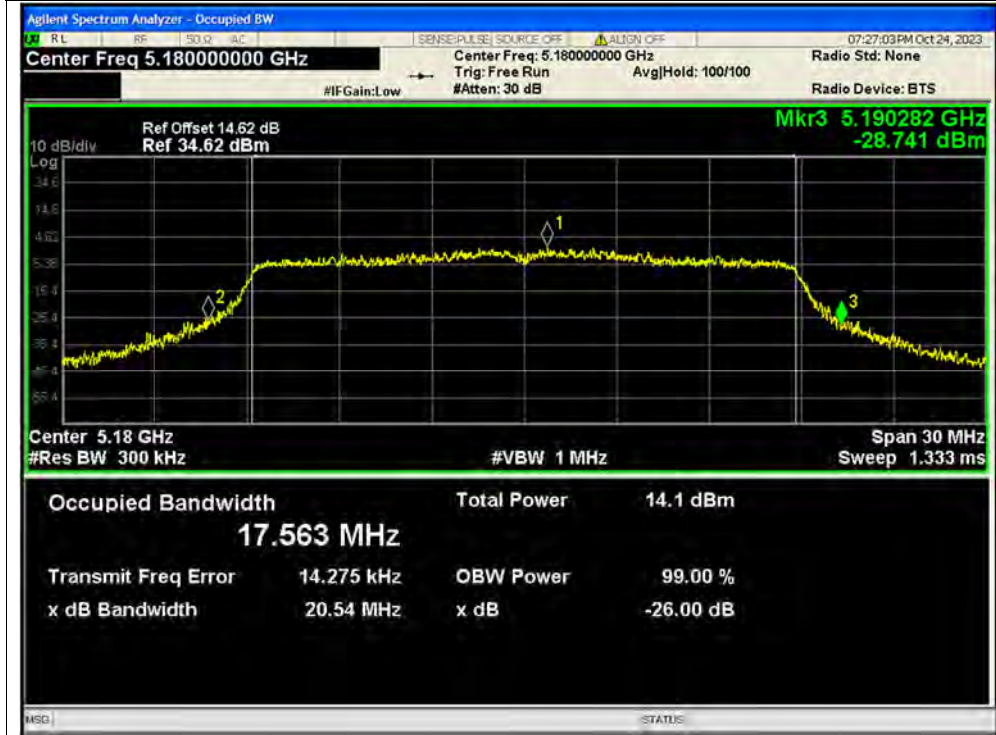

-26dB Bandwidth NVNT ac20 5180MHz Ant2 MIMO





-26dB Bandwidth NVNT ac20 5220MHz Ant1 MIMO



-26dB Bandwidth NVNT ac20 5220MHz Ant2 MIMO





-26dB Bandwidth NVNT ac20 5240MHz Ant1 MIMO



-26dB Bandwidth NVNT ac20 5240MHz Ant2 MIMO





-26dB Bandwidth NVNT ac20 5260MHz Ant1 MIMO



-26dB Bandwidth NVNT ac20 5260MHz Ant2 MIMO





-26dB Bandwidth NVNT ac20 5300MHz Ant1 MIMO



-26dB Bandwidth NVNT ac20 5300MHz Ant2 MIMO





-26dB Bandwidth NVNT ac20 5320MHz Ant1 MIMO



-26dB Bandwidth NVNT ac20 5320MHz Ant2 MIMO

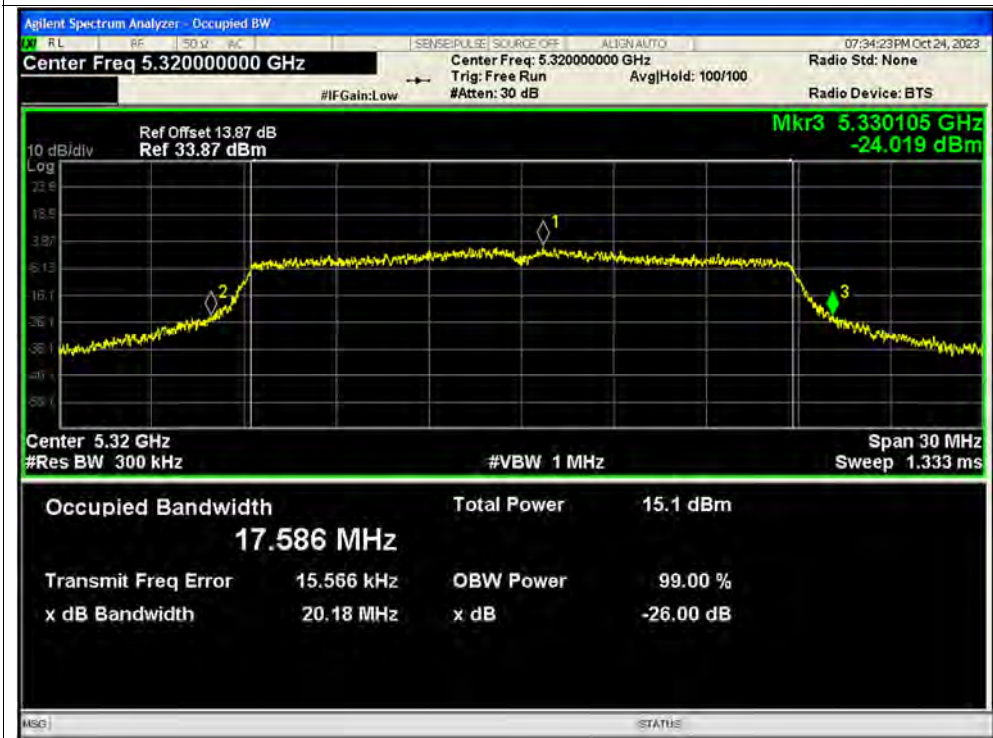



-26dB Bandwidth NVNT ac20 5500MHz Ant1 MIMO



-26dB Bandwidth NVNT ac20 5500MHz Ant2 MIMO





-26dB Bandwidth NVNT ac20 5580MHz Ant1 MIMO



-26dB Bandwidth NVNT ac20 5580MHz Ant2 MIMO

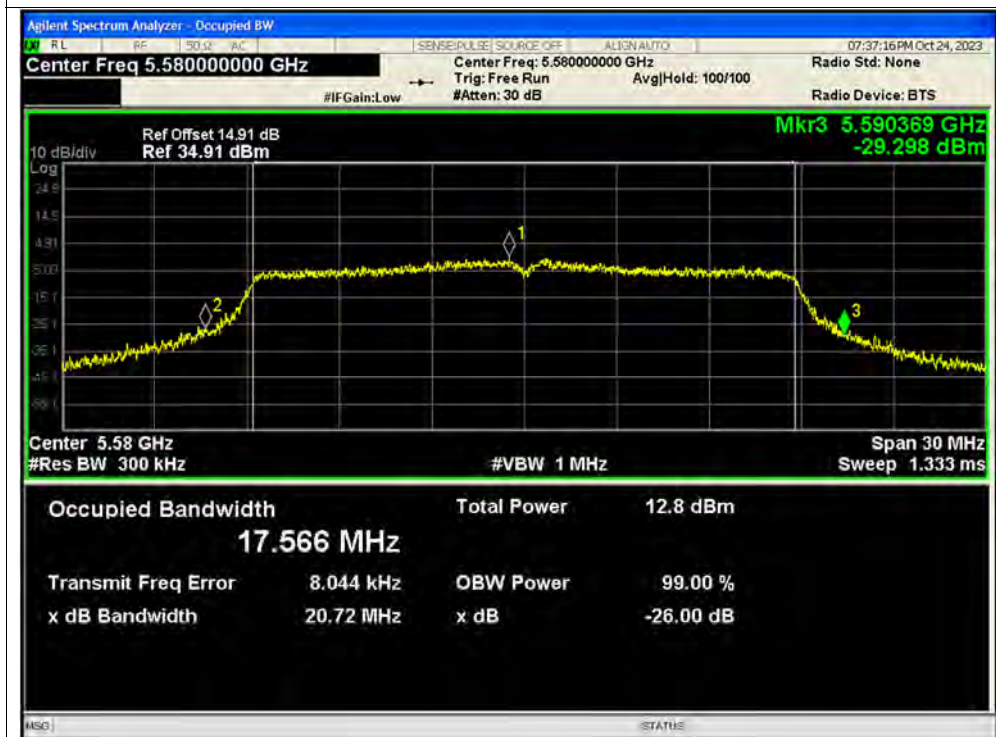



-26dB Bandwidth NVNT ac20 5600MHz Ant1 MIMO



-26dB Bandwidth NVNT ac20 5600MHz Ant2 MIMO

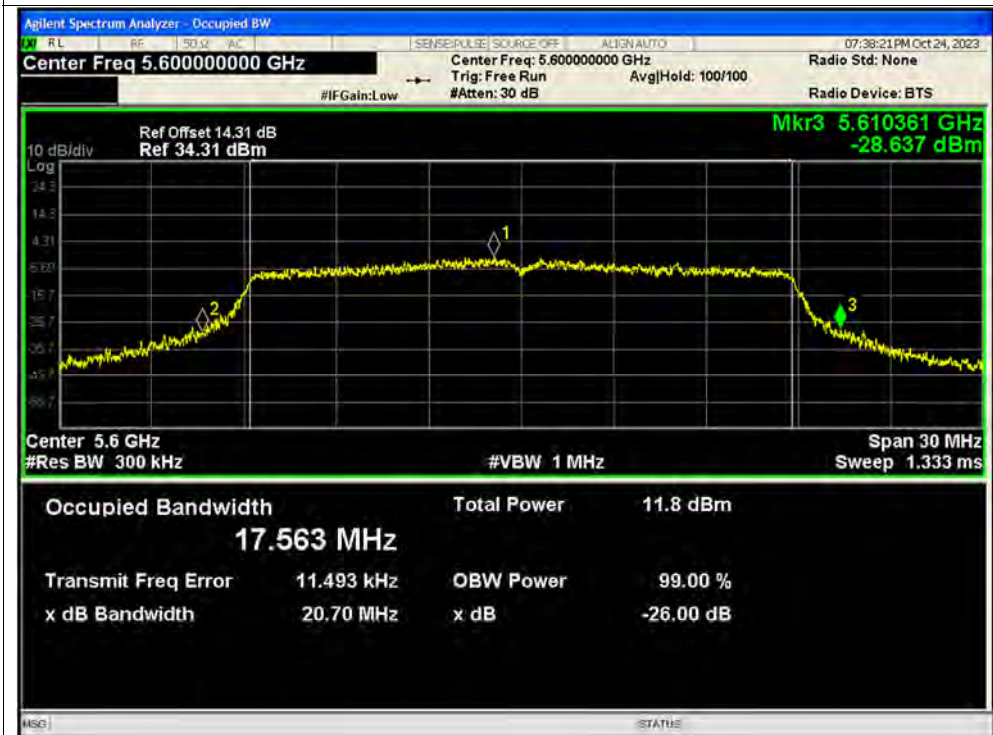



-26dB Bandwidth NVNT ac20 5720MHz Ant1 MIMO



-26dB Bandwidth NVNT ac20 5720MHz Ant2 MIMO

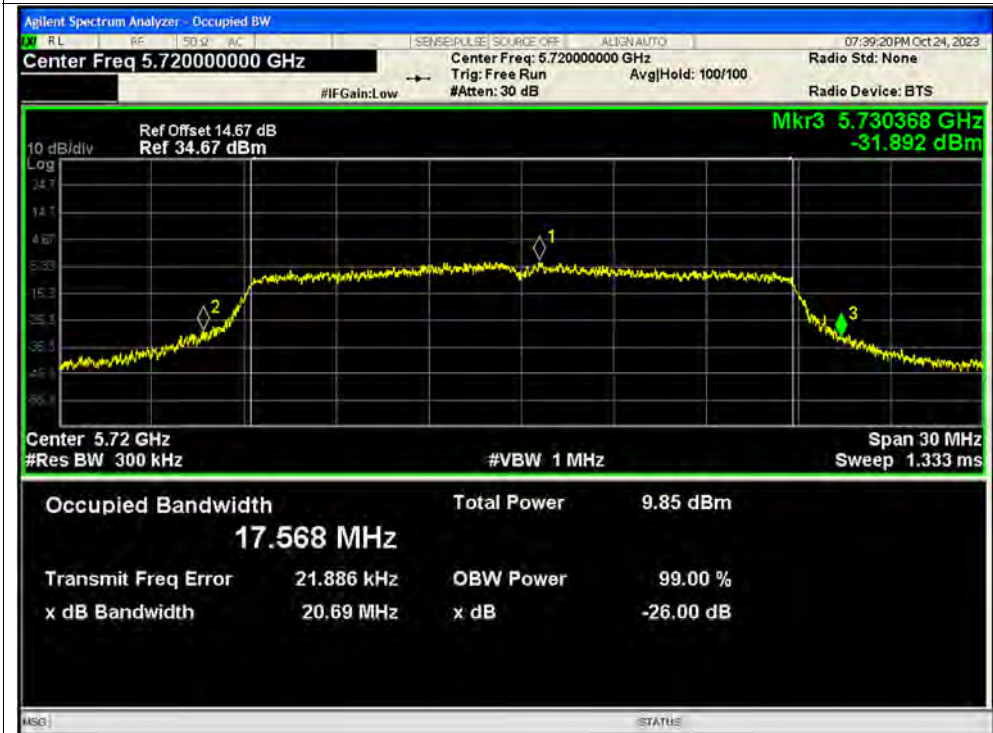



-26dB Bandwidth NVNT ac40 5190MHz Ant1 SISO

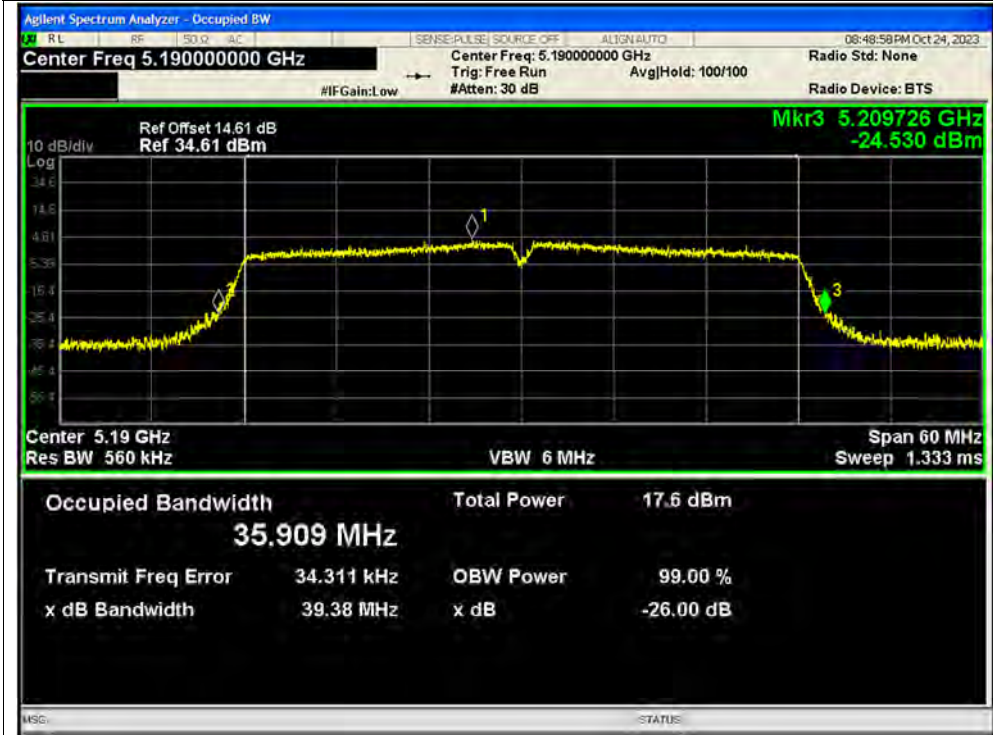

-26dB Bandwidth NVNT ac40 5230MHz Ant1 SISO

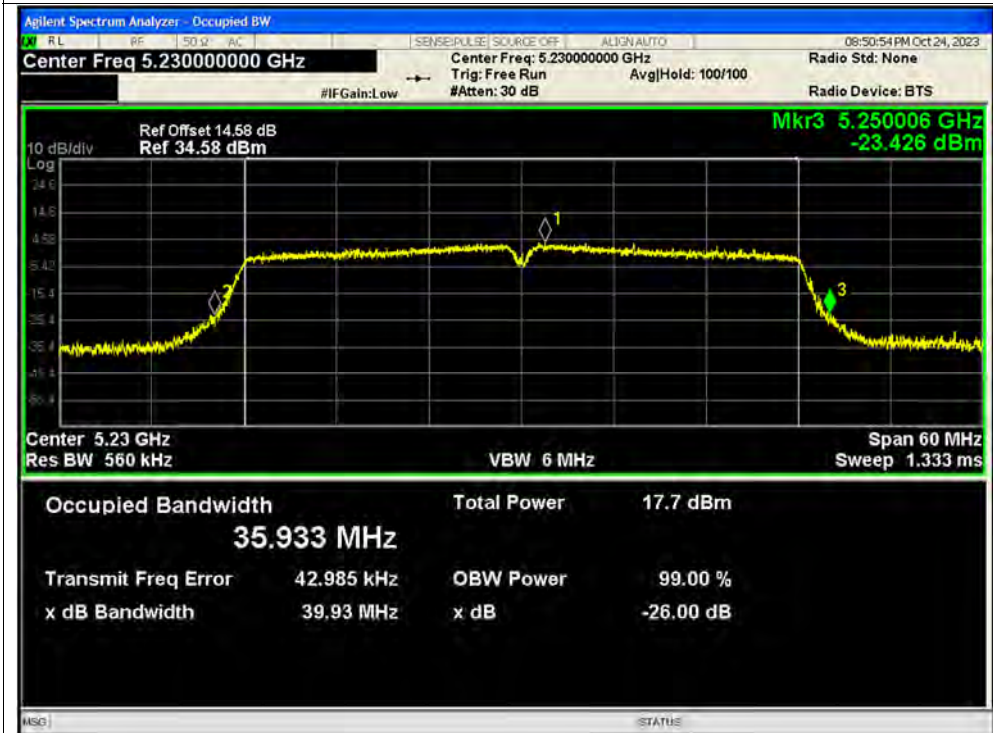



-26dB Bandwidth NVNT ac40 5270MHz Ant1 SISO



-26dB Bandwidth NVNT ac40 5310MHz Ant1 SISO





-26dB Bandwidth NVNT ac40 5510MHz Ant1 SISO



-26dB Bandwidth NVNT ac40 5550MHz Ant1 SISO

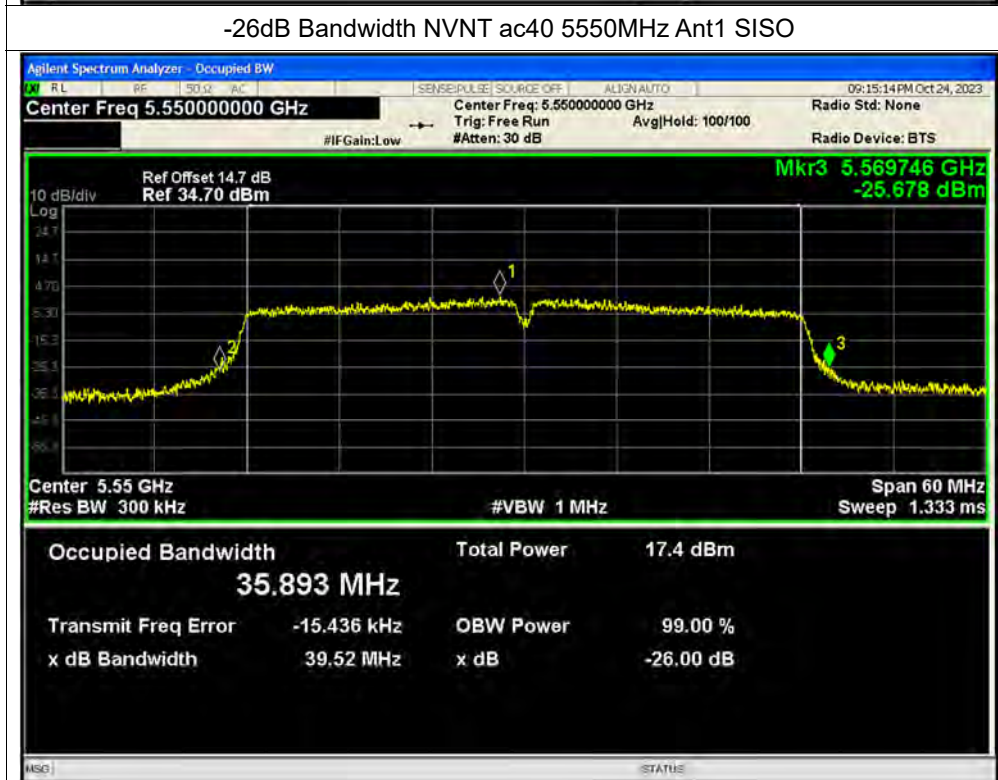



-26dB Bandwidth NVNT ac40 5630MHz Ant1 SISO

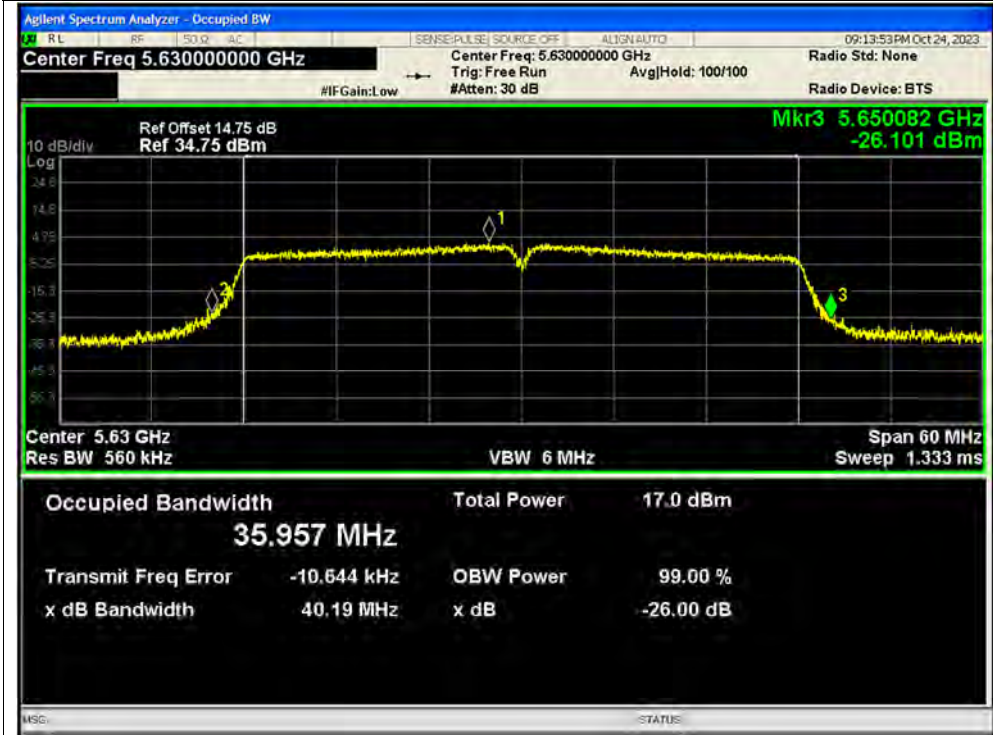

-26dB Bandwidth NVNT ac40 5710MHz Ant1 SISO





-26dB Bandwidth NVNT ac40 5190MHz Ant2 SISO

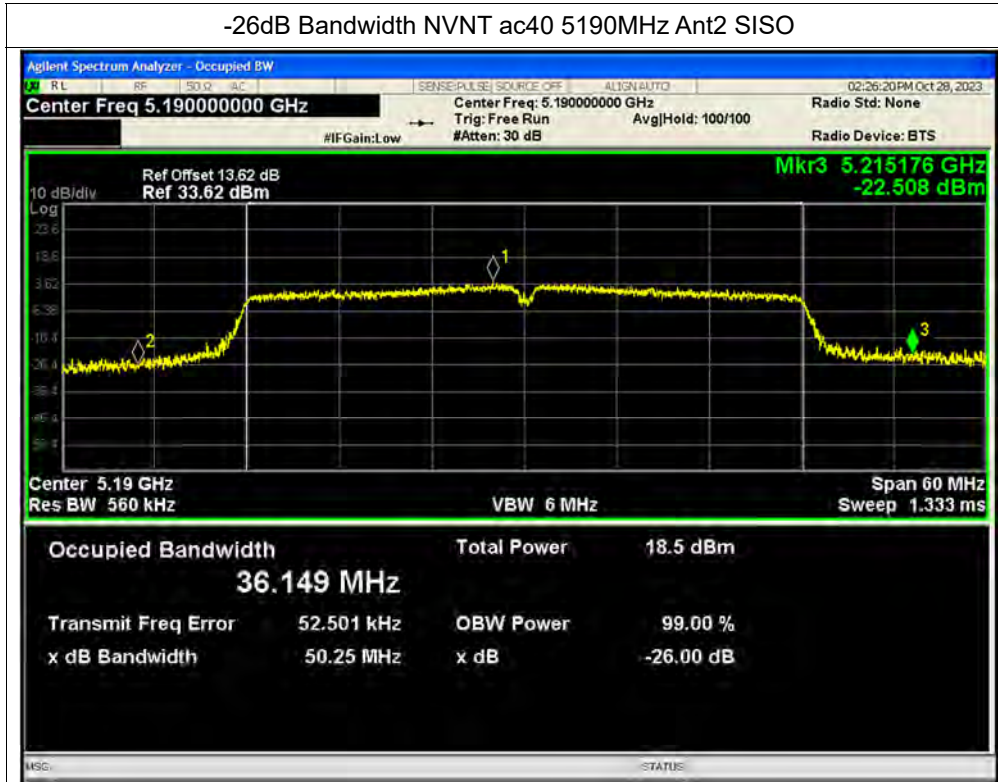

-26dB Bandwidth NVNT ac40 5230MHz Ant2 SISO





-26dB Bandwidth NVNT ac40 5270MHz Ant2 SISO

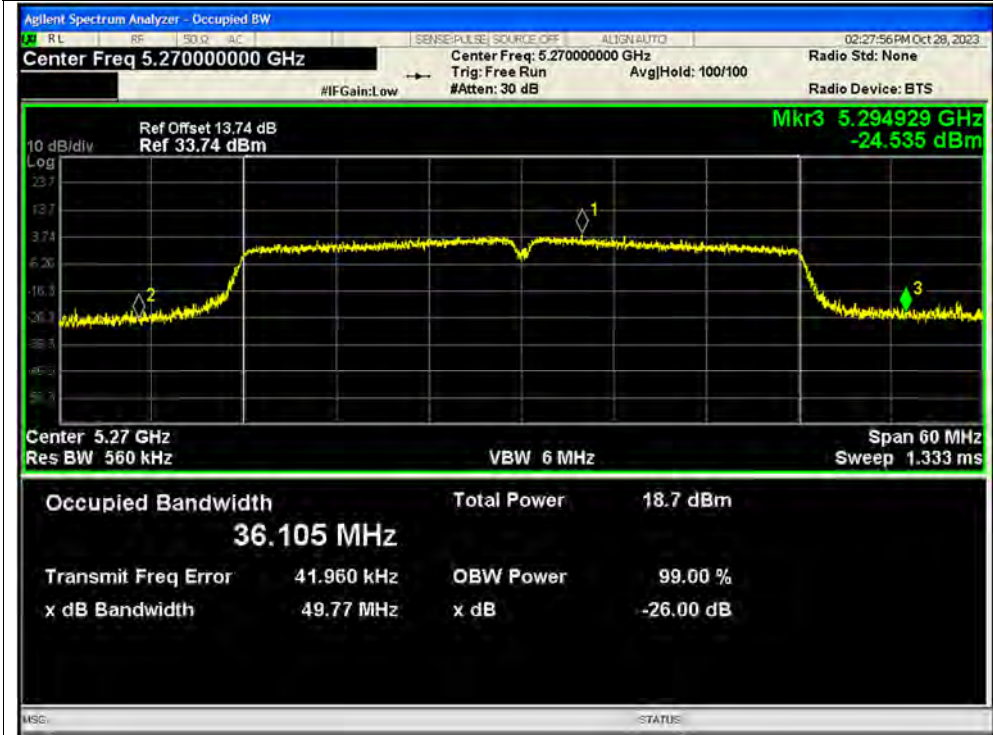

-26dB Bandwidth NVNT ac40 5310MHz Ant2 SISO

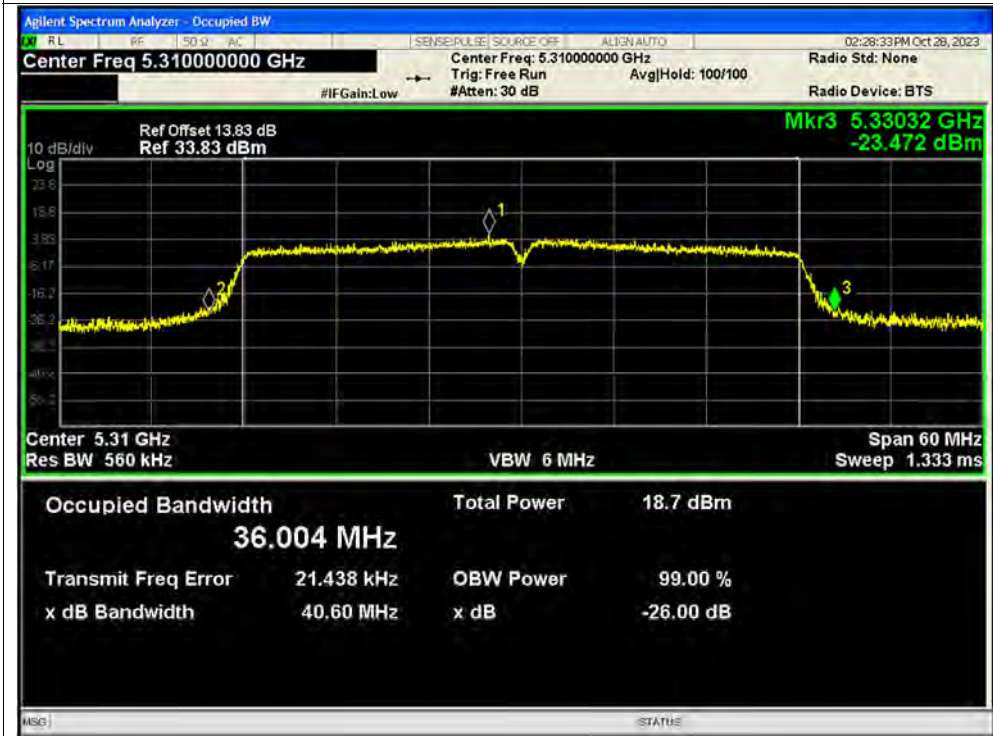



-26dB Bandwidth NVNT ac40 5510MHz Ant2 SISO



-26dB Bandwidth NVNT ac40 5550MHz Ant2 SISO

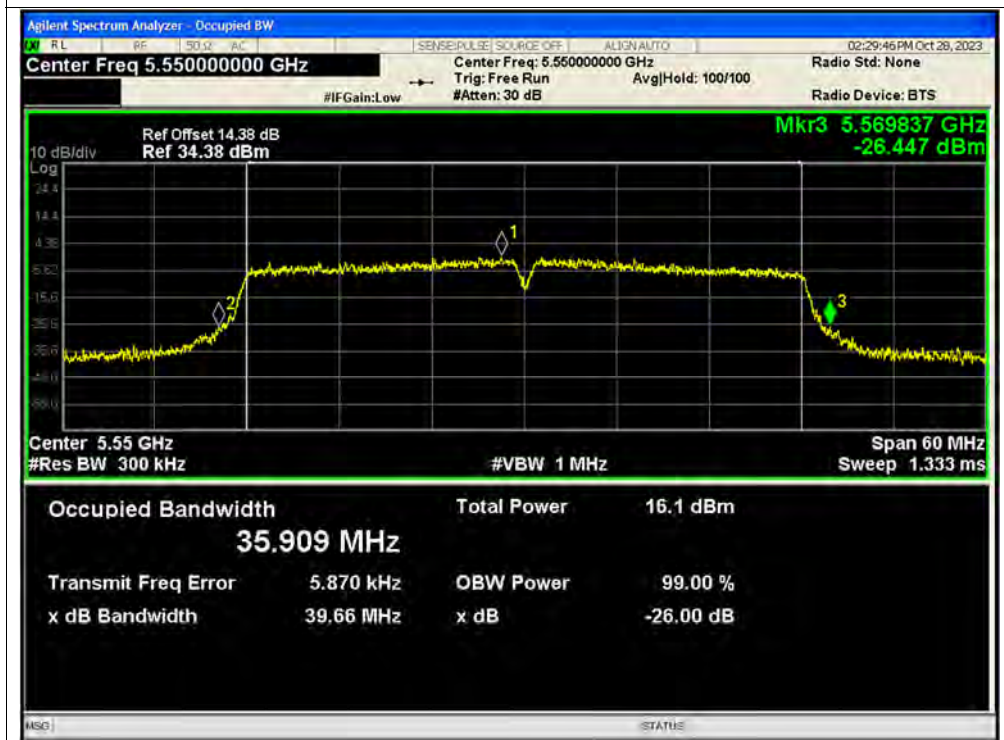



-26dB Bandwidth NVNT ac40 5630MHz Ant2 SISO



-26dB Bandwidth NVNT ac40 5710MHz Ant2 SISO

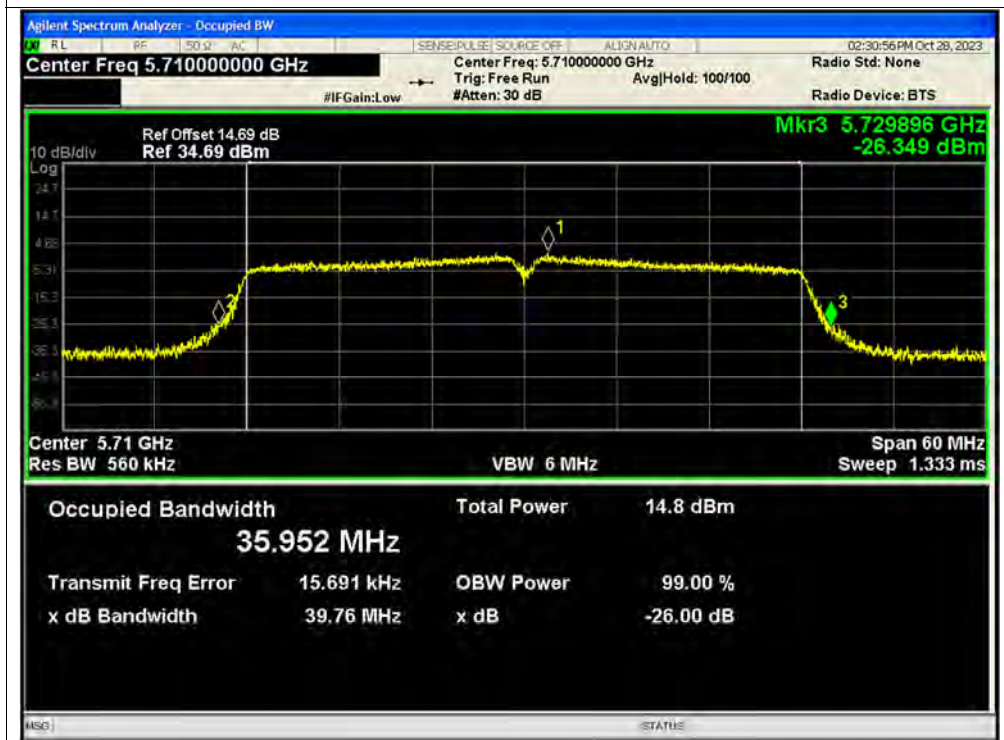



-26dB Bandwidth NVNT ac40 5190MHz Ant1 MIMO

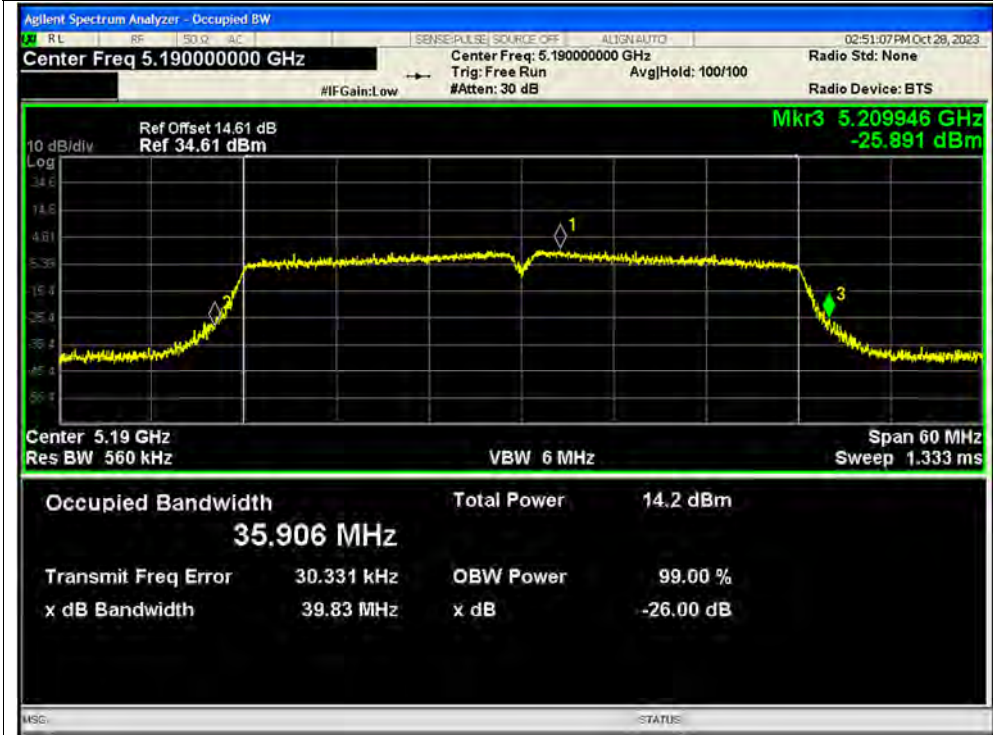

-26dB Bandwidth NVNT ac40 5190MHz Ant2 MIMO

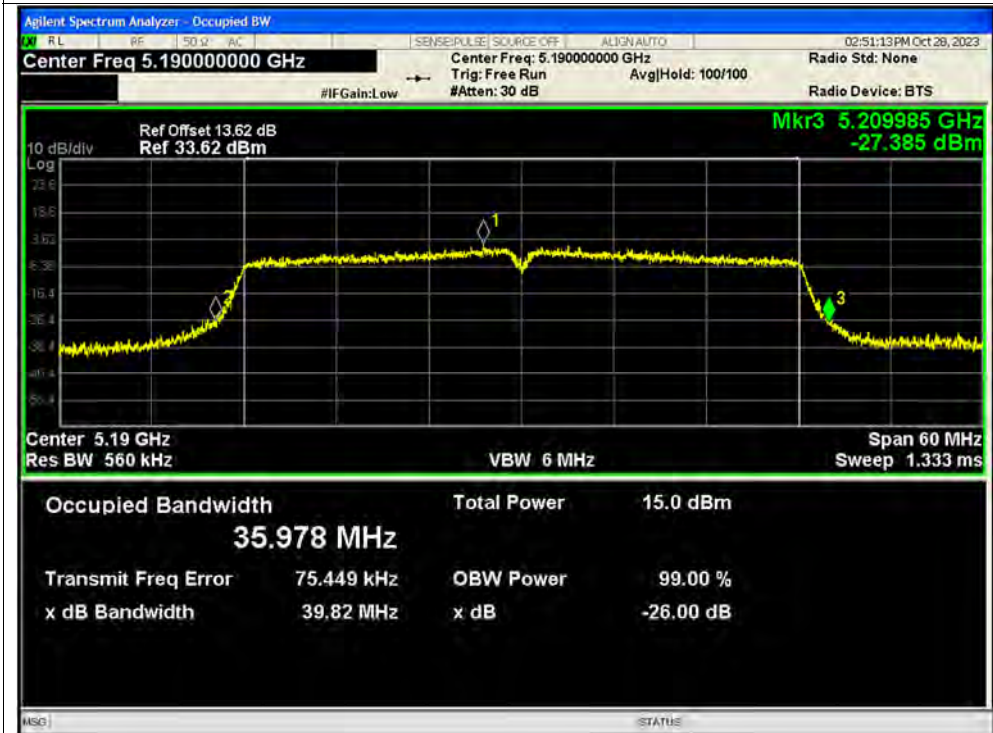



-26dB Bandwidth NVNT ac40 5230MHz Ant1 MIMO

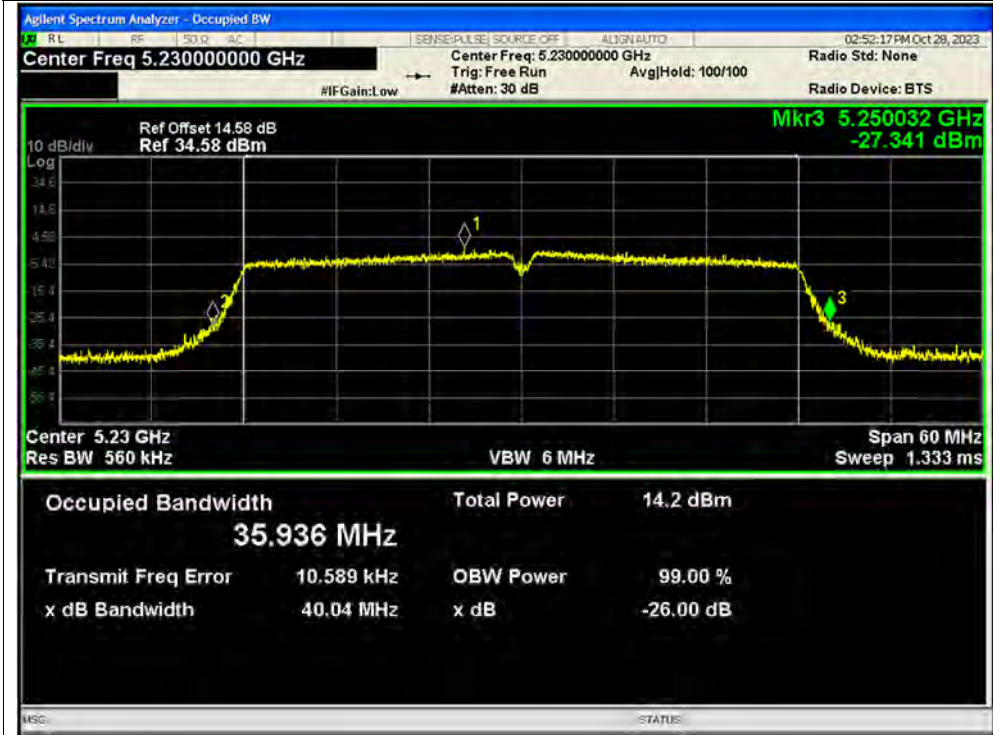

-26dB Bandwidth NVNT ac40 5230MHz Ant2 MIMO

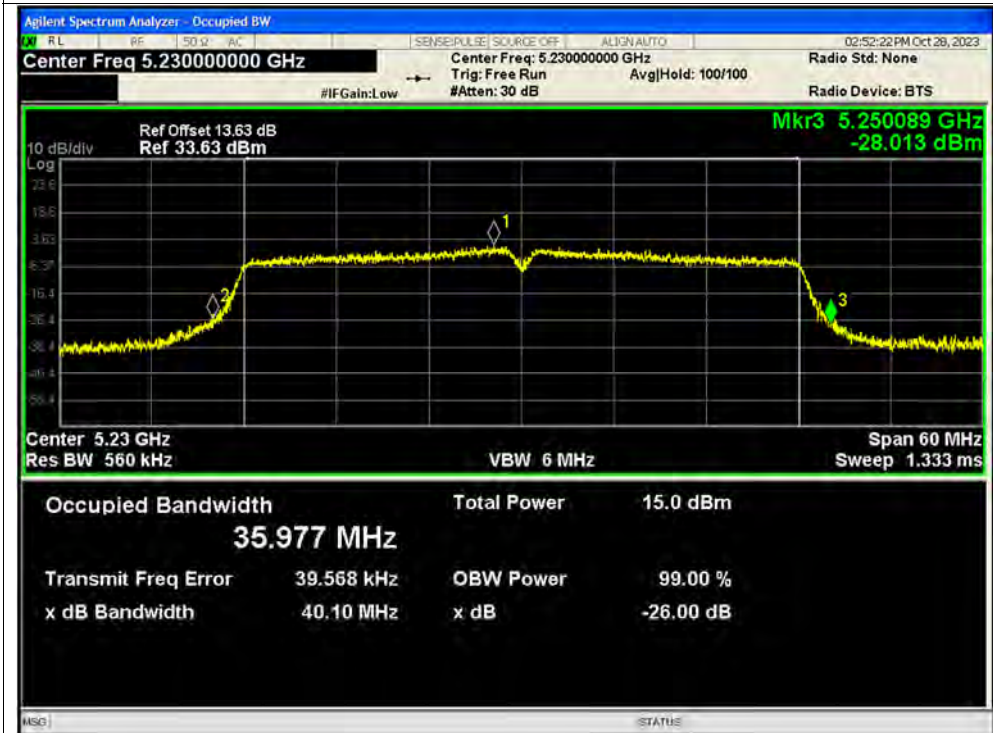



-26dB Bandwidth NVNT ac40 5270MHz Ant1 MIMO

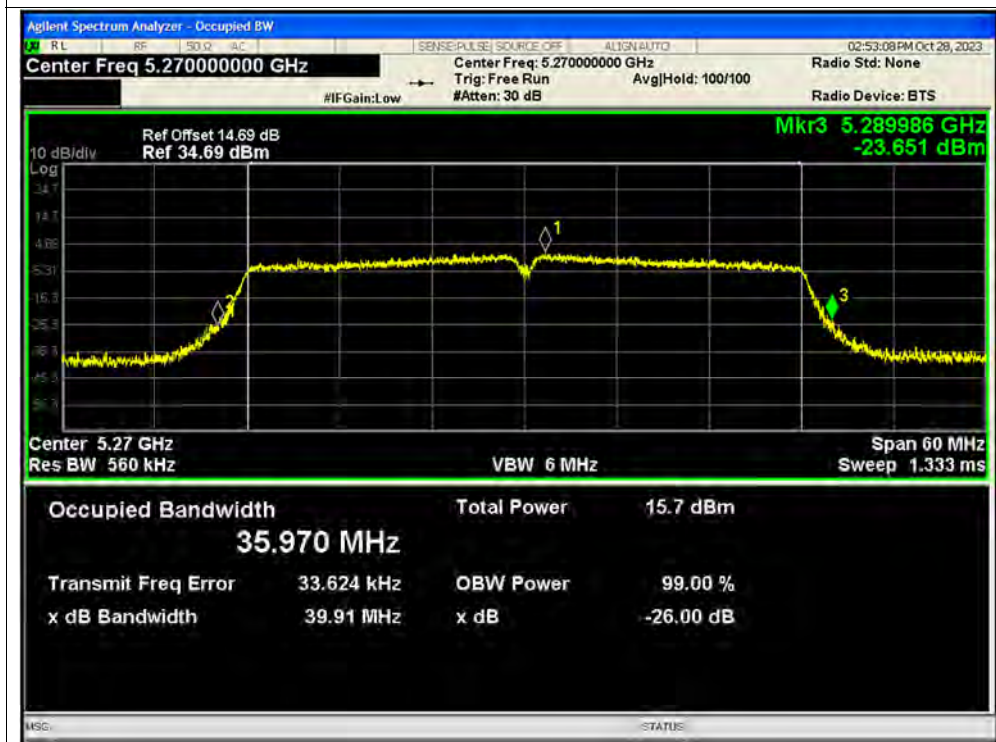

-26dB Bandwidth NVNT ac40 5270MHz Ant2 MIMO

