



LTE ULCA_5A-66A PCC(5A)

Channel Bandwidth:5MHz

Low 1RB



High 1RB

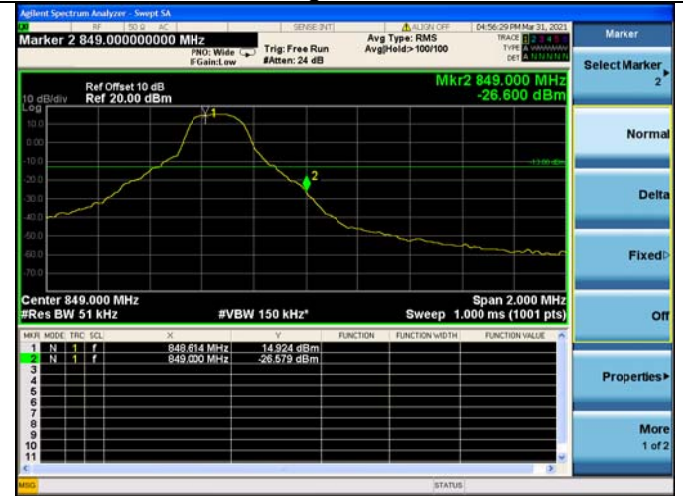

Low FULL RB



High FULL RB





LTE ULCA_5A-66A PCC(5A)
Channel Bandwidth:10MHz

Low 1RB



High 1RB



Low FULL RB

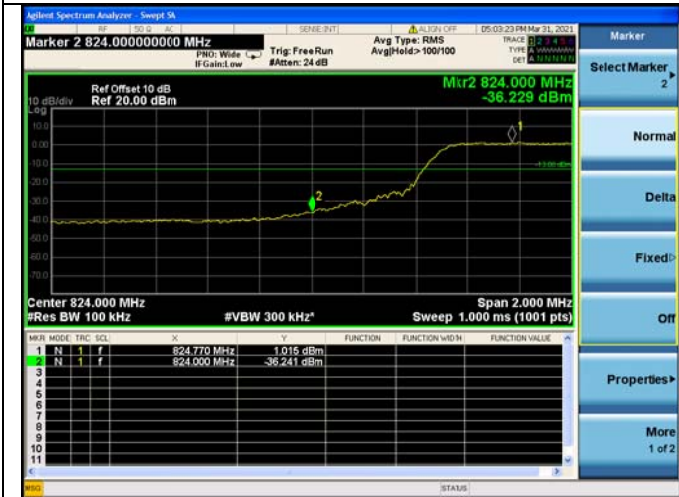

High FULL RB





LTE ULCA 5A-66A SCC(66A)

Channel Bandwidth:5MHz

Low 1RB



High 1RB



Low FULL RB

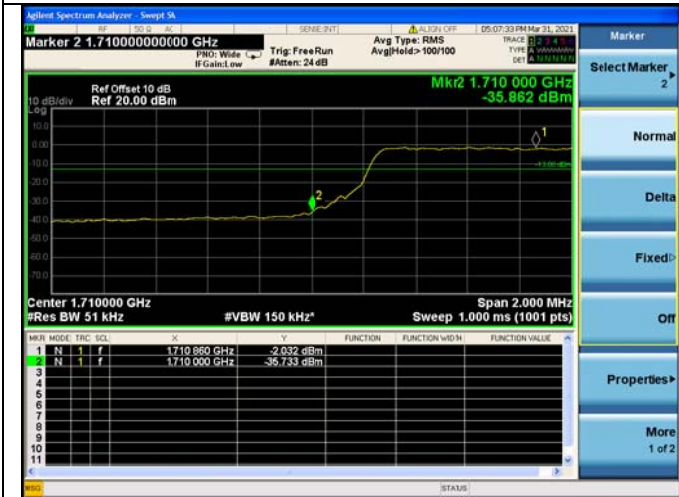

High FULL RB

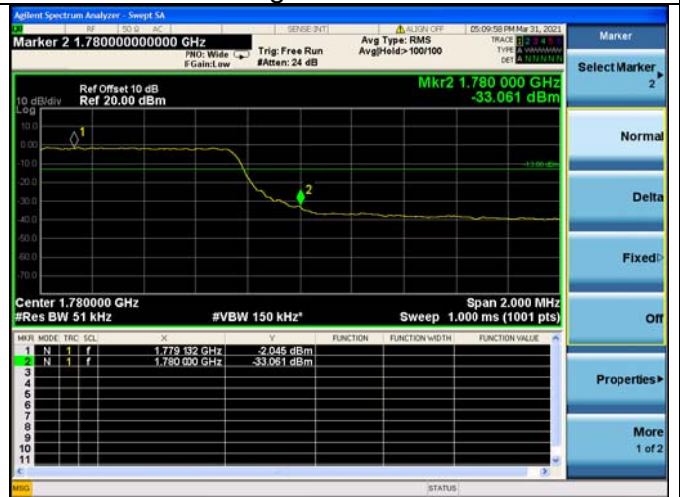



LTE ULCA 5A-66A SCC(66A)

Channel Bandwidth:10MHz

Low 1RB



High 1RB



Low FULL RB



High FULL RB





LTE ULCA 5A-66A SCC(66A)

Channel Bandwidth:15MHz

Low 1RB

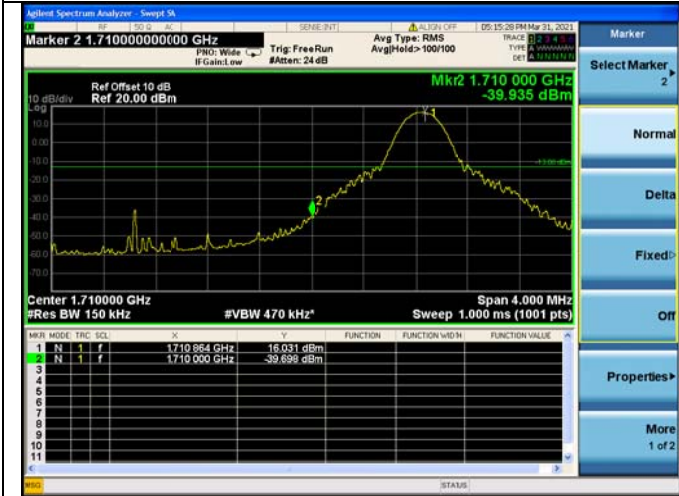

High 1RB



Low FULL RB

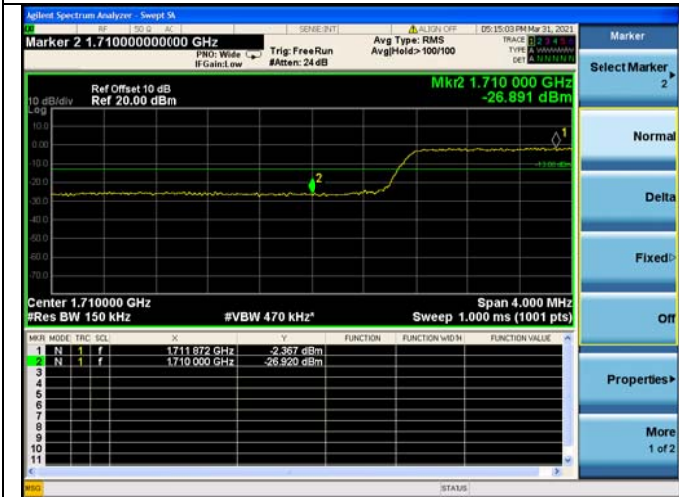

High FULL RB





LTE ULCA 5A-66A SCC(66A)

Channel Bandwidth:20MHz

Low 1RB



High 1RB

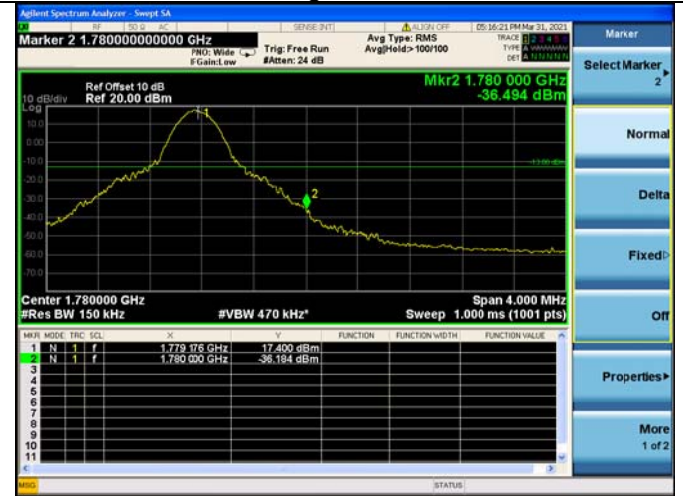

Low FULL RB



High FULL RB





LTE ULCA_12A-66A PCC(12A)
Channel Bandwidth:5MHz

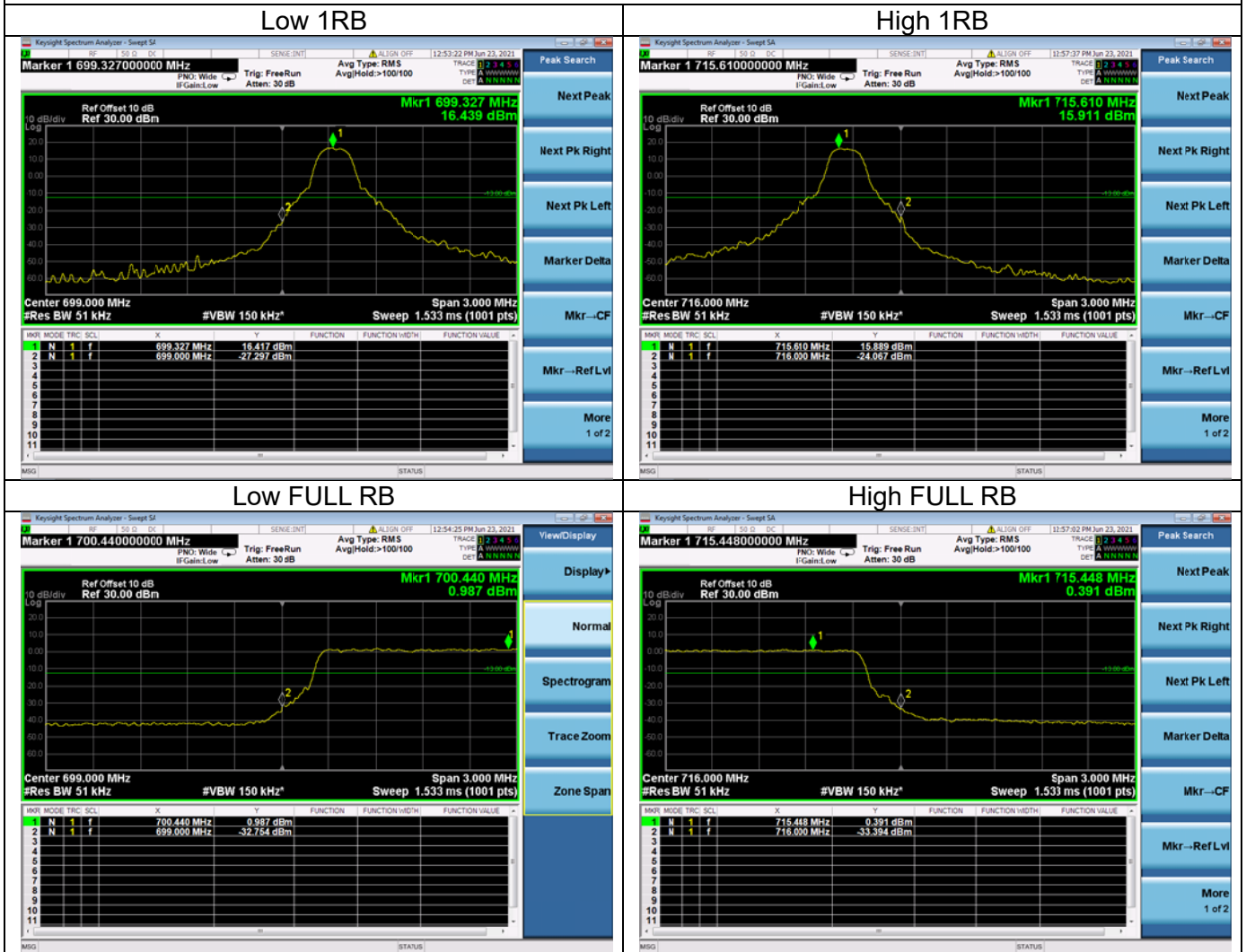



LTE ULCA_12A-66A PCC(12A)
Channel Bandwidth:10MHz

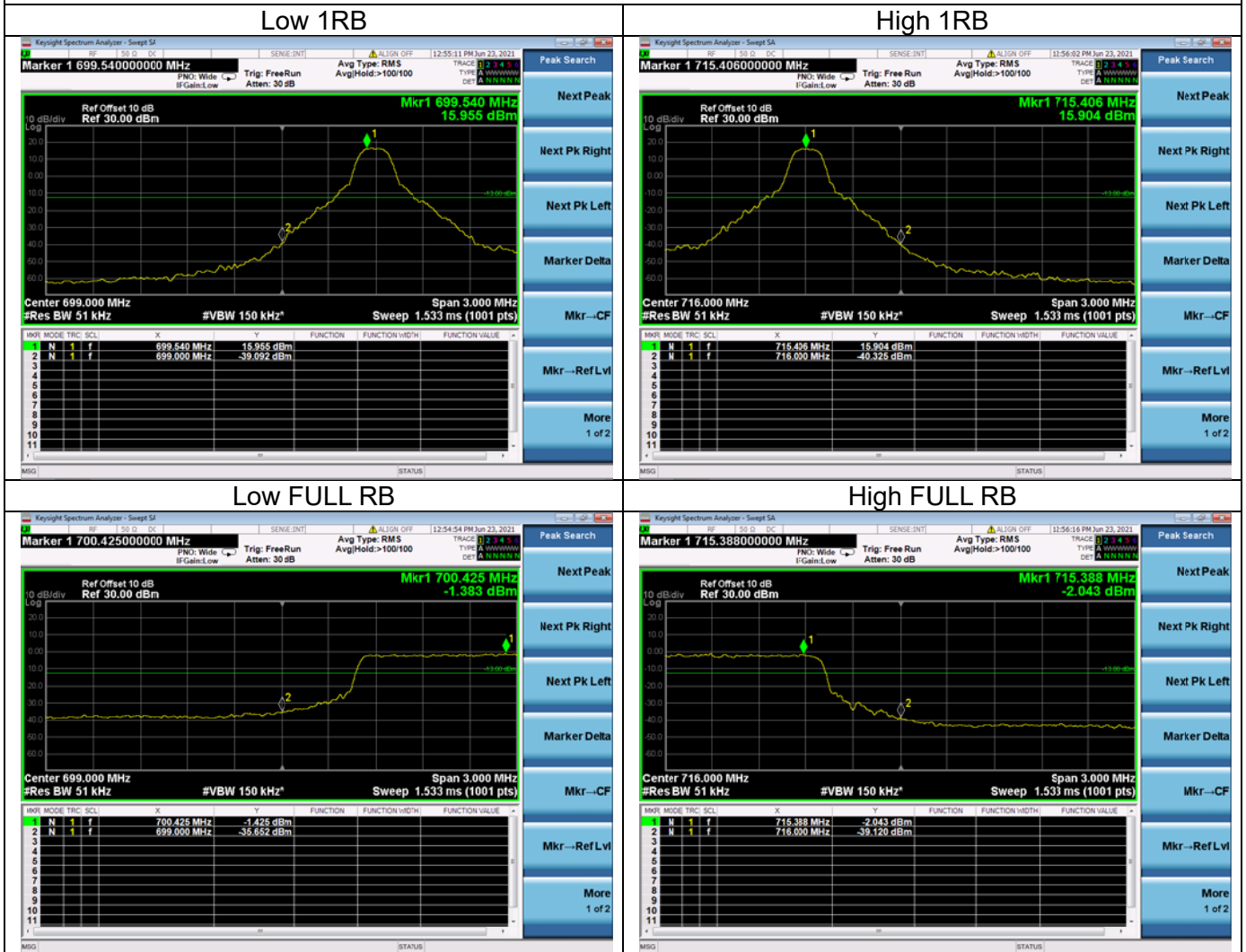



LTE ULCA_12A-66A SCC(66A)
Channel Bandwidth:5MHz

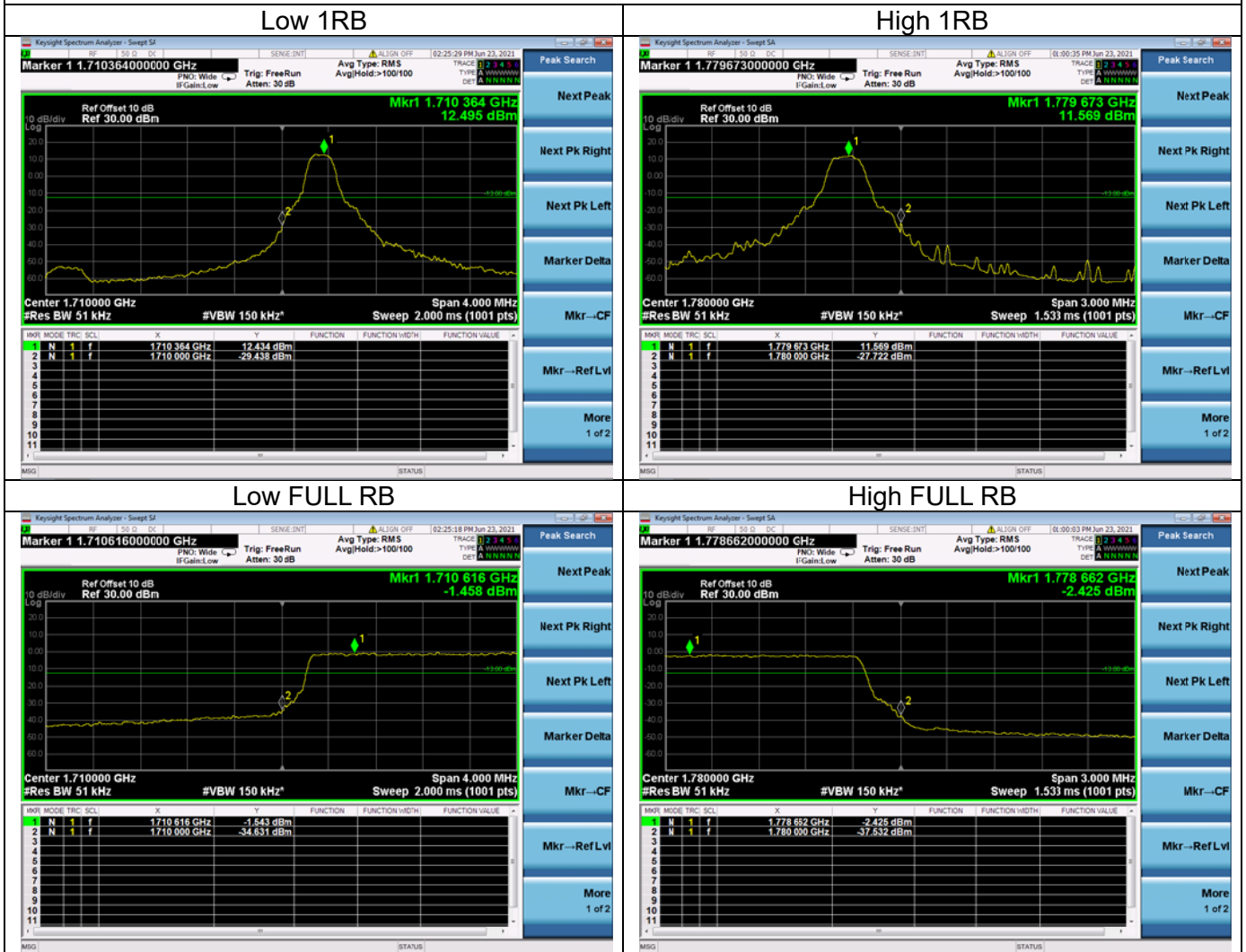



LTE ULCA_12A-66A SCC(66A)

Channel Bandwidth:10MHz

Low 1RB

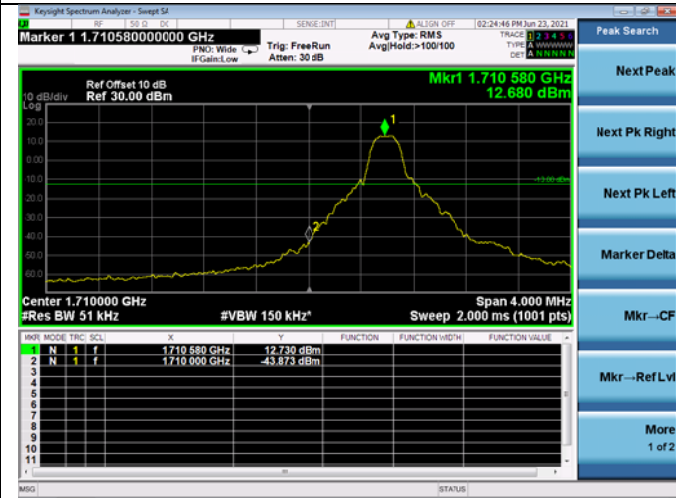

High 1RB

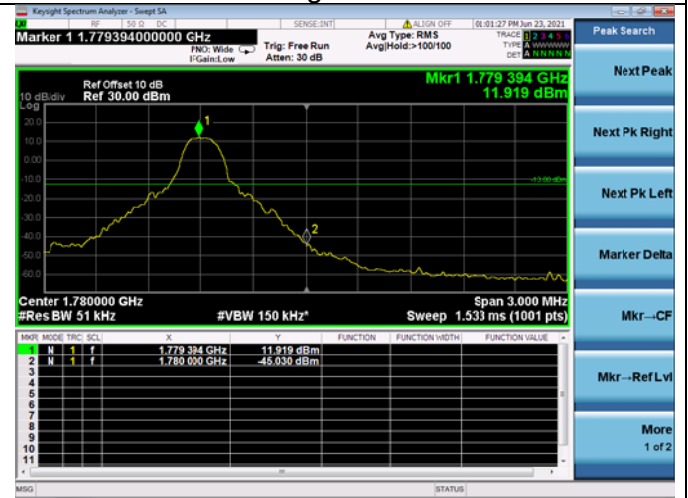

Low FULL RB

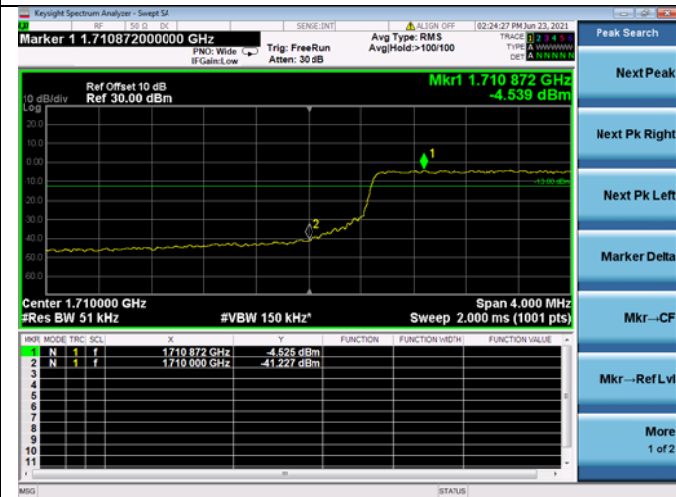

High FULL RB

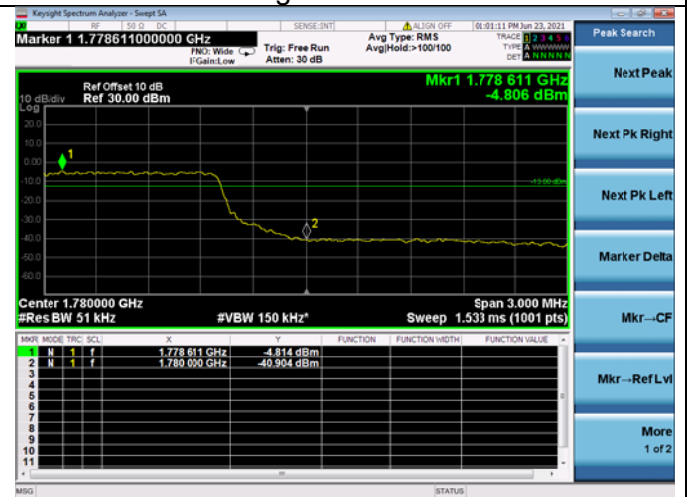



LTE ULCA_12A-66A SCC(66A)
Channel Bandwidth:15MHz

Low 1RB

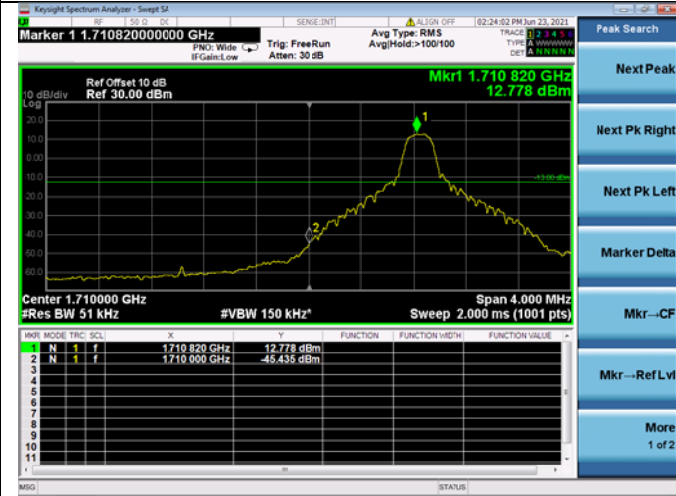

High 1RB

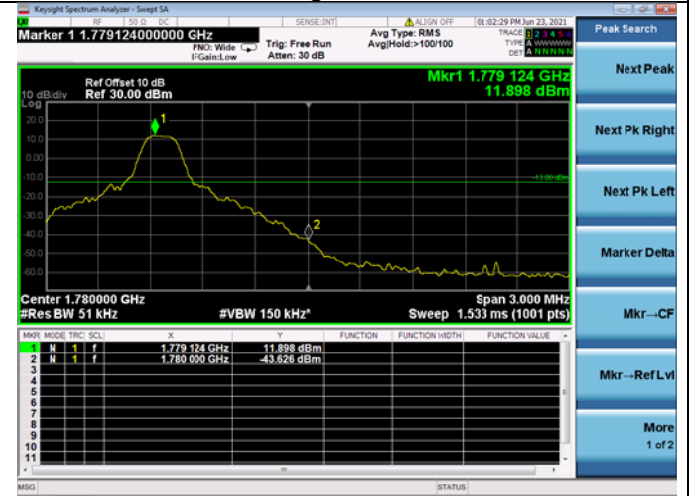

Low FULL RB

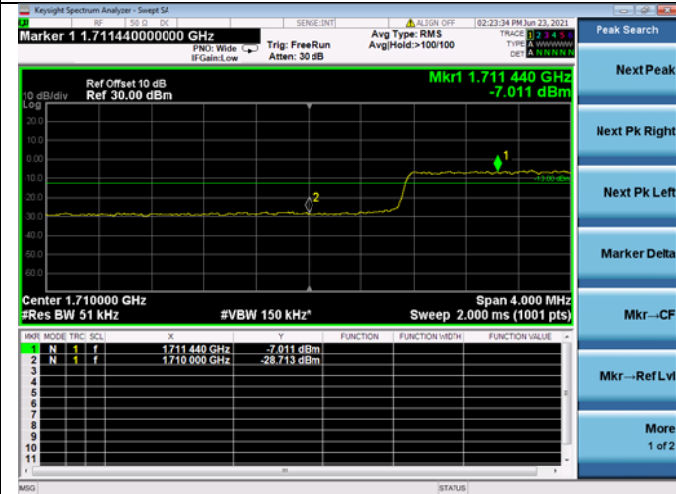

High FULL RB

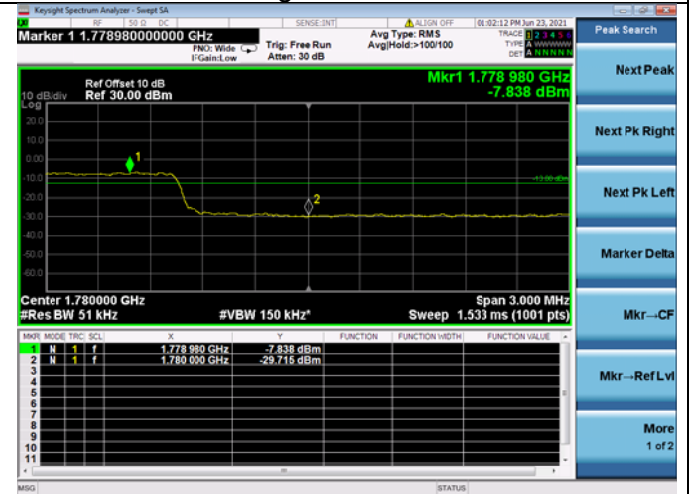



LTE ULCA_12A-66A SCC(66A)
Channel Bandwidth:20MHz

Low 1RB

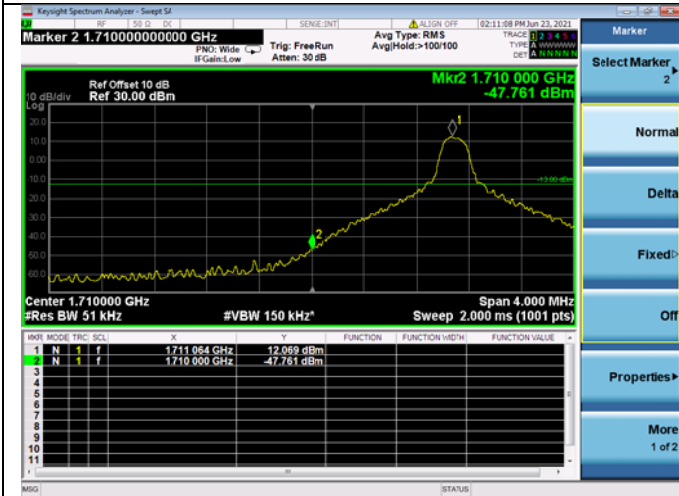

High 1RB

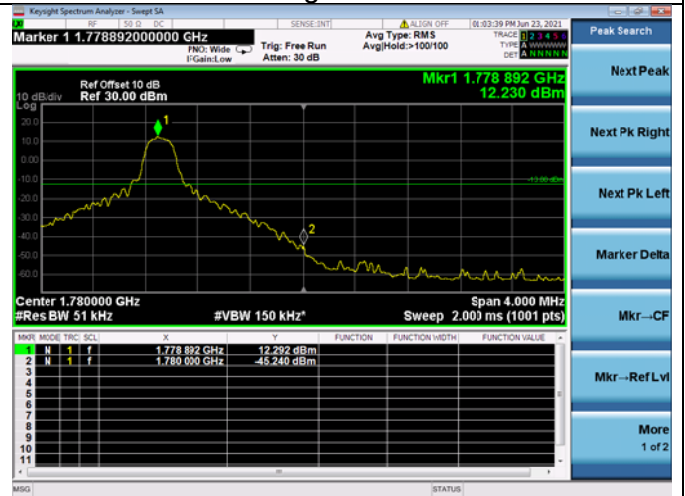

Low FULL RB

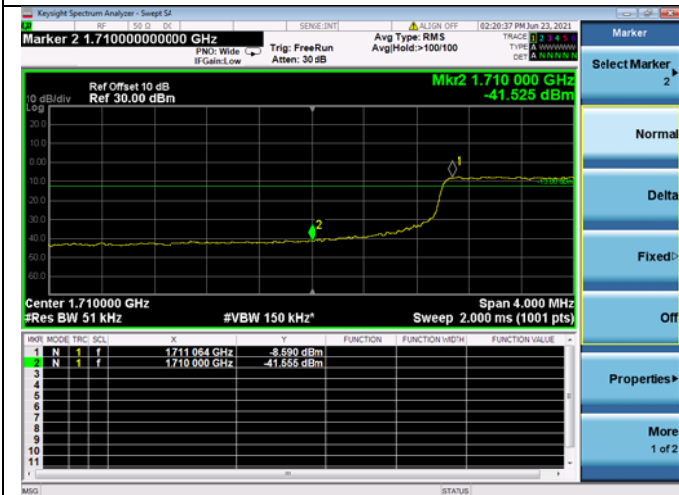

High FULL RB

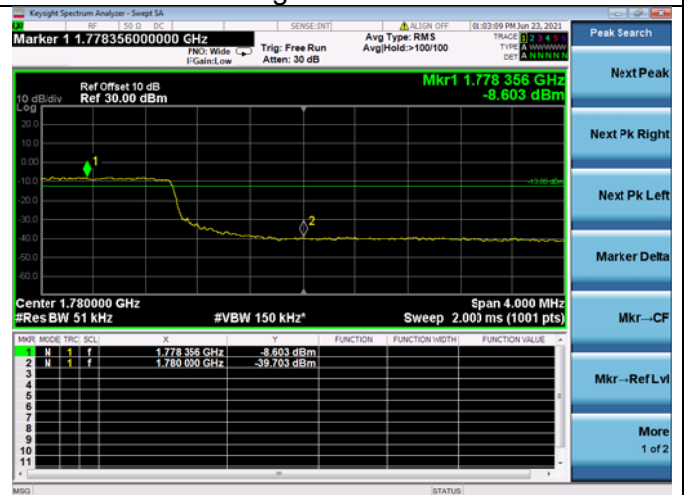



LTE ULCA 5A-66A SCC(66A)

Channel Bandwidth:5MHz

Low 1RB



High 1RB



Low FULL RB

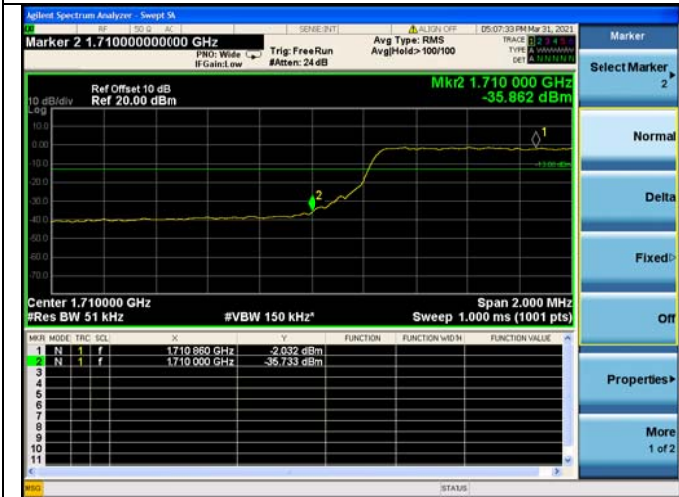

High FULL RB





LTE ULCA 5A-66A SCC(66A)

Channel Bandwidth:10MHz

Low 1RB



High 1RB



Low FULL RB

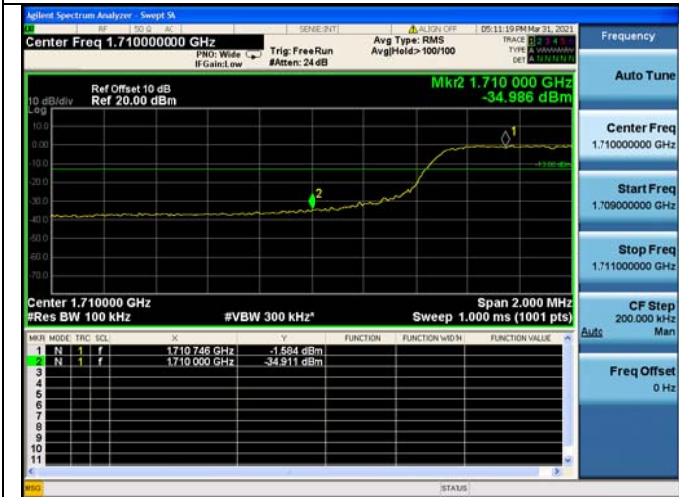

High FULL RB





LTE ULCA 5A-66A SCC(66A)

Channel Bandwidth:15MHz

Low 1RB

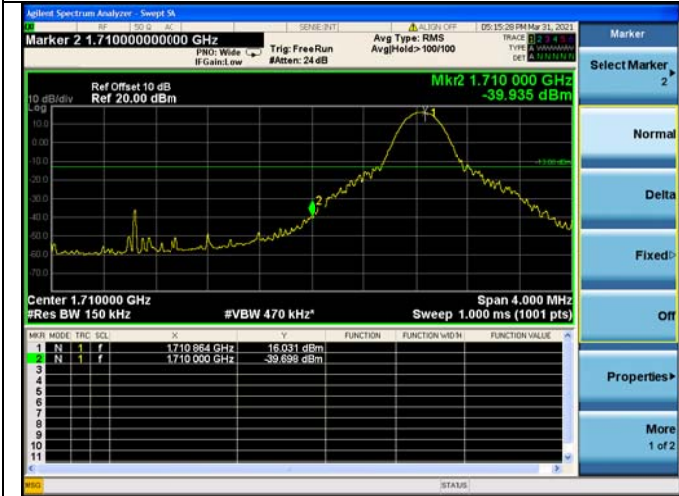

High 1RB



Low FULL RB

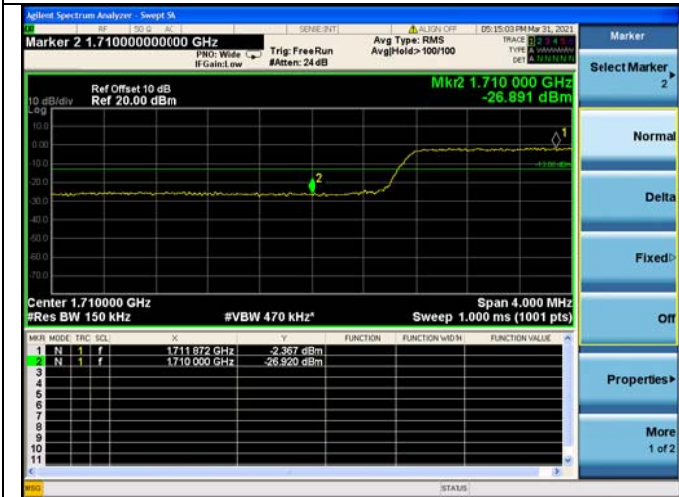

High FULL RB





LTE ULCA 5A-66A SCC(66A)

Channel Bandwidth:20MHz

Low 1RB



High 1RB

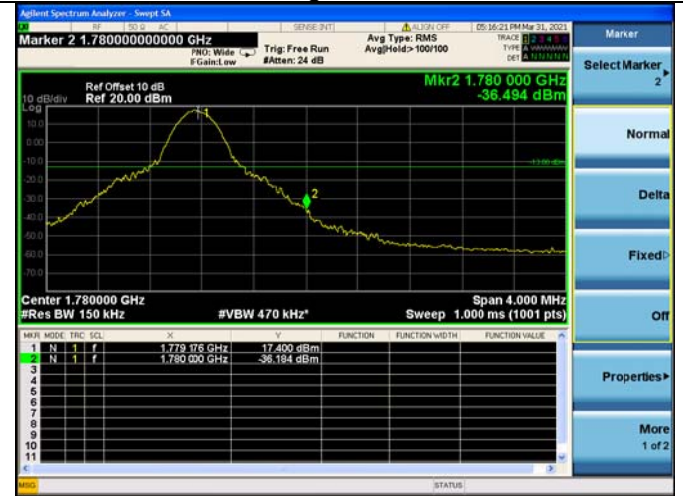

Low FULL RB



High FULL RB





LTE ULCA_13A-66A PCC(13A)

Channel Bandwidth:5MHz

Low 1RB

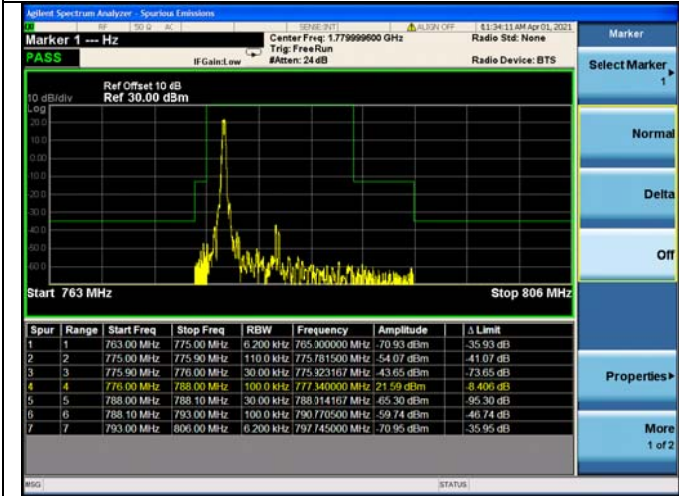

High 1RB

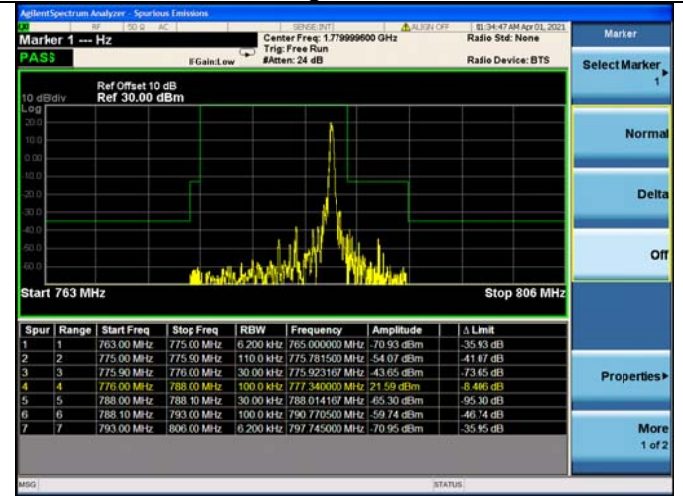

Low FULL RB



High FULL RB

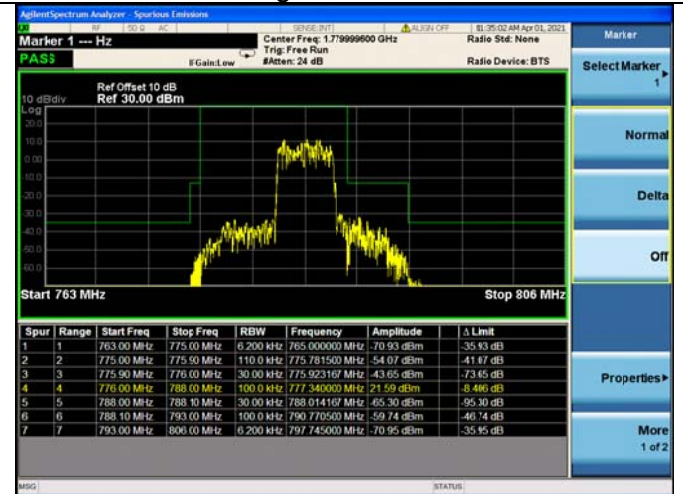



LTE ULCA_13A-66A PCC(13A)
Channel Bandwidth:10MHz

Low 1RB

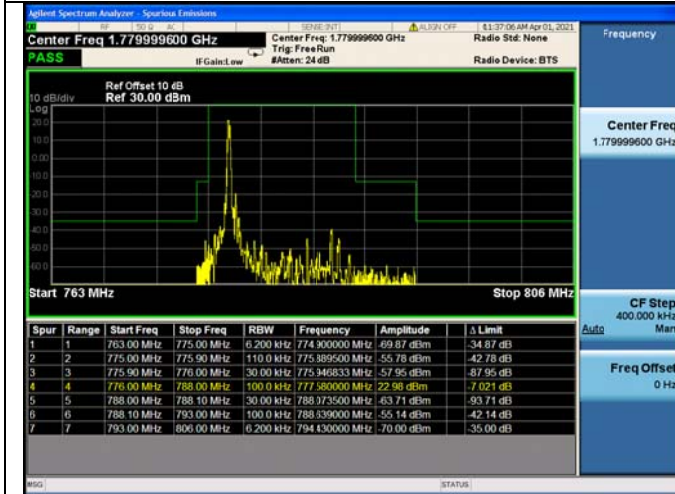

High 1RB

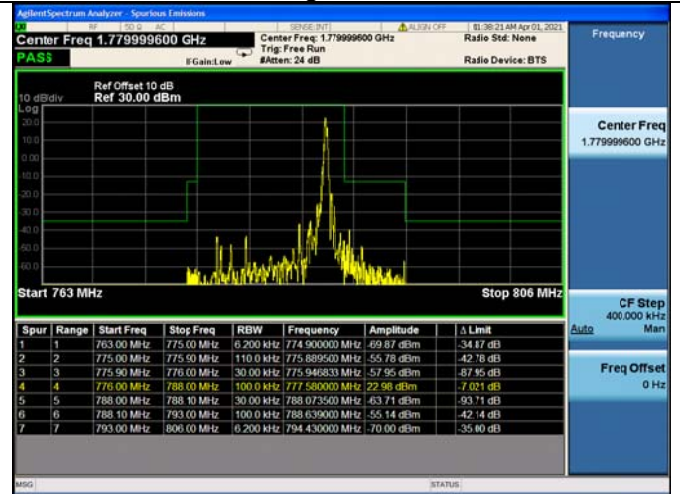

FULL RB

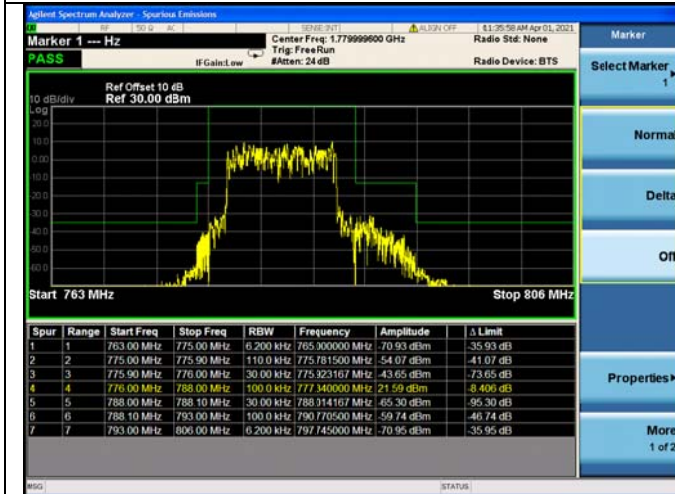



LTE ULCA_13A-66A SCC(66A)

Channel Bandwidth:5MHz

Low 1RB



High 1RB



Low FULL RB



High FULL RB





LTE ULCA_13A-66A SCC(66A)

Channel Bandwidth:10MHz

Low 1RB



High 1RB



Low FULL RB



High FULL RB





LTE ULCA_13A-66A SCC(66A)

Channel Bandwidth:15MHz

Low 1RB

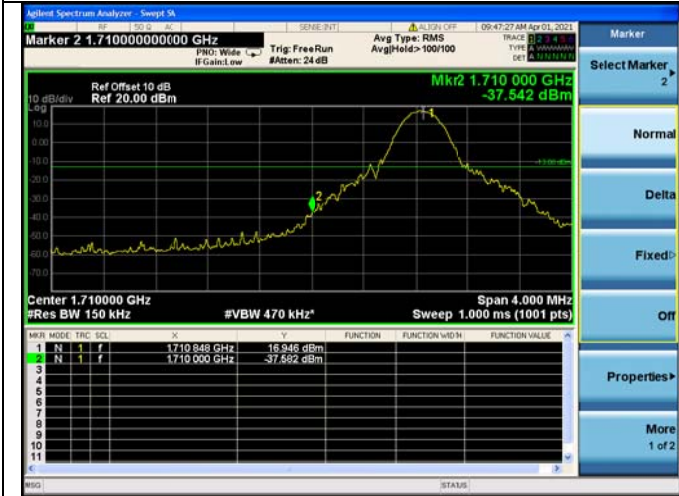

High 1RB



Low FULL RB

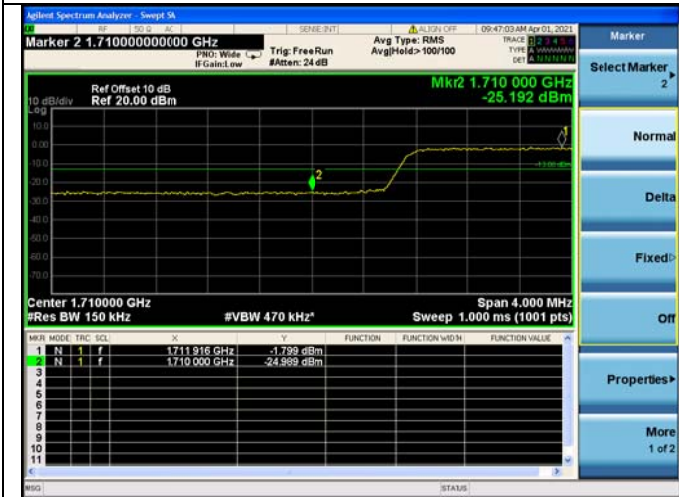

High FULL RB

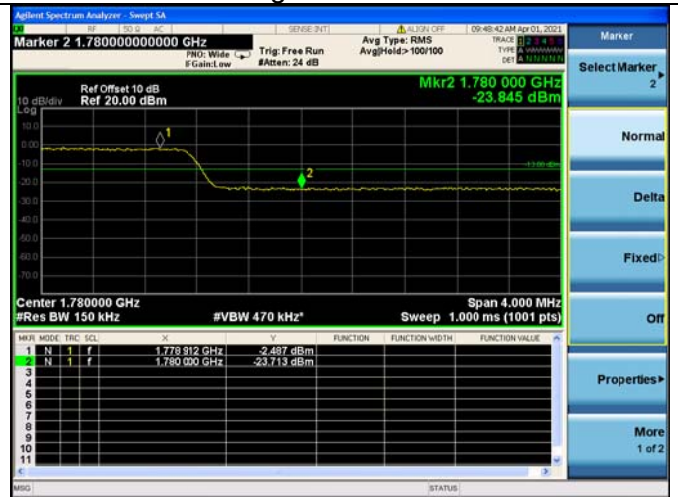



LTE ULCA_13A-66A SCC(66A)

Channel Bandwidth:20MHz

Low 1RB



High 1RB



Low FULL RB

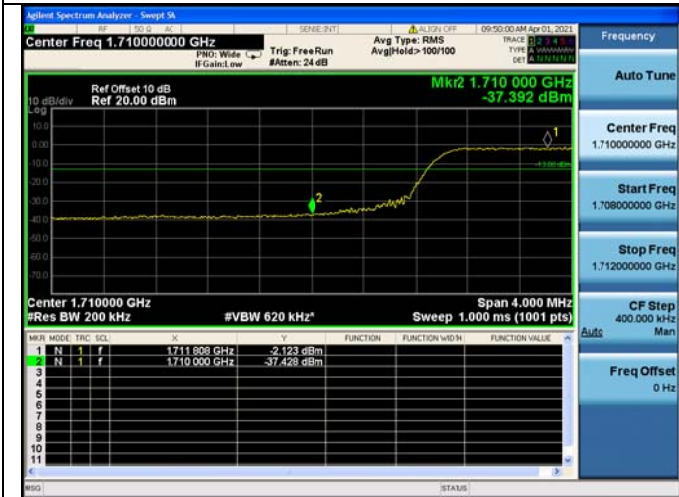

High FULL RB



2.5. Radiated Spurious Emissions

2.5.1. Requirement

According to FCC section 2.1051, the power of any emission outside of the authorized operating frequency ranges must be attenuated below the transmitting power (P) by a factor of at least $43+10*\log(P)$ dB. This calculated to be -13dBm.

Additional requirement for LTE Band 41 48: The power of any emission outside of the authorized operating frequency ranges must be attenuated below the transmitting power (P) by a factor of at least $55 + 10 \log(P)$ dB. This calculated to be -25dBm.

2.5.2. Test Description

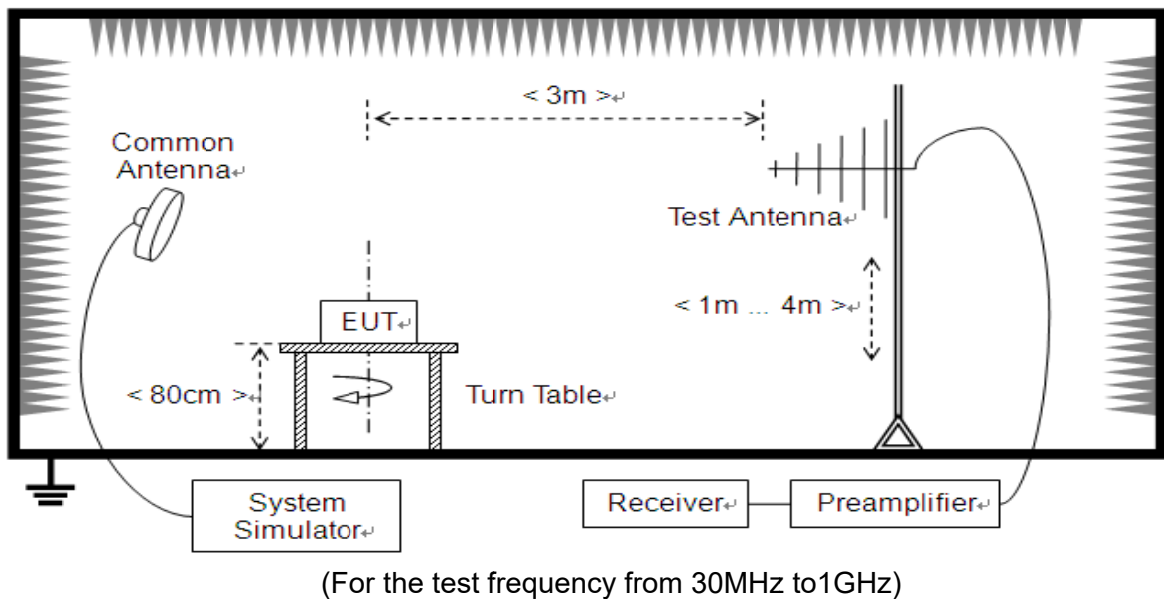

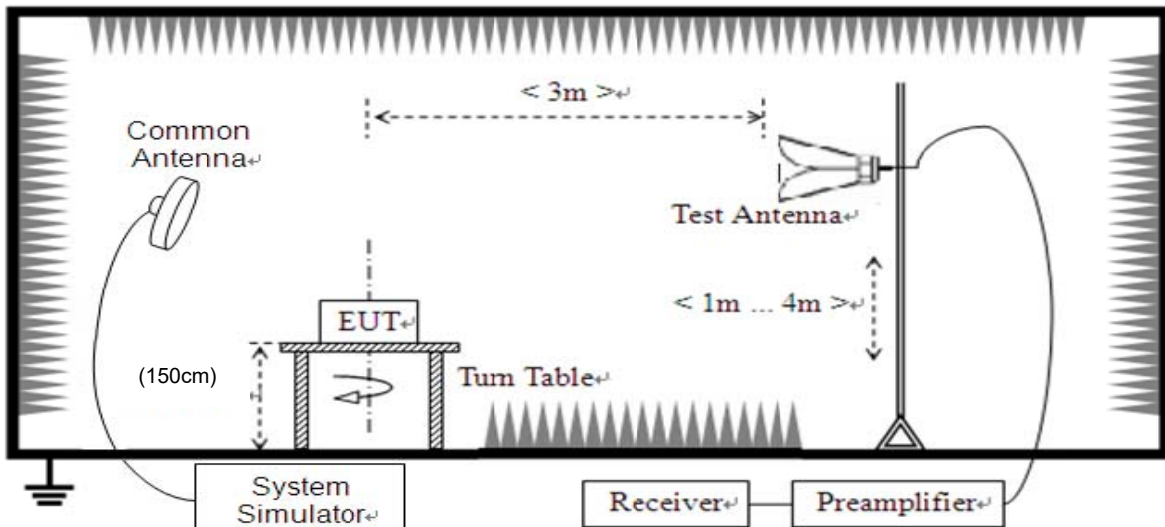

(For the test frequency above 1GHz)

The EUT is located in a 3m Full-Anechoic Chamber, the cable loss, air loss and so on of the site as factors are pre-calibrated using the "Substitution" method, and calculated to correct the reading.

A call is established between the EUT and the SS via a Common Antenna. The EUT is commanded by the SS to operate at the maximum and minimum output power, and only the test result of the maximum output power was recorded.

In the frequency range above 30MHz, Bi-Log Test Antenna (30MHz to 1GHz) and Horn Test Antenna (above 1GHz) are used. Test Antenna is 3m away from the EUT. Test Antenna height is varied from 1m to 4m above the ground and the Turn Table is actuated to turn from 0° to 360° to determine the maximum value of the radiated power. The emission levels at both horizontal and vertical polarizations should be tested. The Filters consists of Notch Filters and High Pass Filter.

Note: when doing measurements above 1GHz, the EUT has been within the 3dB cone width of the horn antenna during horizontal antenna.

2.5.3. Test procedure

KDB 971168 D01v03 Section 5.8 and ANSI/TIA-603-E-2016.



2.5.4. Test Result

The measurement frequency range is from 30MHz to the 10th harmonic of the fundamental frequency. Test Antenna height is varied from 1m to 4m above the ground, and the Turn Table is actuated to turn from 0° to 360°, both horizontal and vertical polarizations of the Test Antenna are used to find the maximum radiated power. Mid channels on all channel bandwidth verified. Only the worst RB size/offset presented.

The substitution corrections are obtained as described below:

$$A_{\text{SUBST}} = P_{\text{SUBST_TX}} - P_{\text{SUBST_RX}} - L_{\text{SUBST_CABLES}} + G_{\text{SUBST_TX_ANT}}$$

$$A_{\text{TOT}} = L_{\text{CABLES}} + A_{\text{SUBST}}$$

Where A_{SUBST} is the final substitution correction including receive antenna gain.

$P_{\text{SUBST_TX}}$ is signal generator level,

$P_{\text{SUBST_RX}}$ is receiver level,

$L_{\text{SUBST_CABLES}}$ is cable losses including TX cable,

$G_{\text{SUBST_TX_ANT}}$ is substitution antenna gain.

A_{TOT} is total correction factor including cable loss and substitution correction

During the test, the data of A_{TOT} was added in the Test Spectrum Analyze, so Spectrum Analyze reading is the final values which contain the data of A_{TOT} .

Note1: The power of the EUT transmitting frequency should be ignored.

Note2: All Spurious Emission tests were performed in X, Y, Z axis direction. And only the worst axis test condition was recorded in this test report.

Note3: All bandwidth and test channel were considered and evaluated respectively by performing full test for each band, only the worst cases were recorded in this test report.

Test Graph

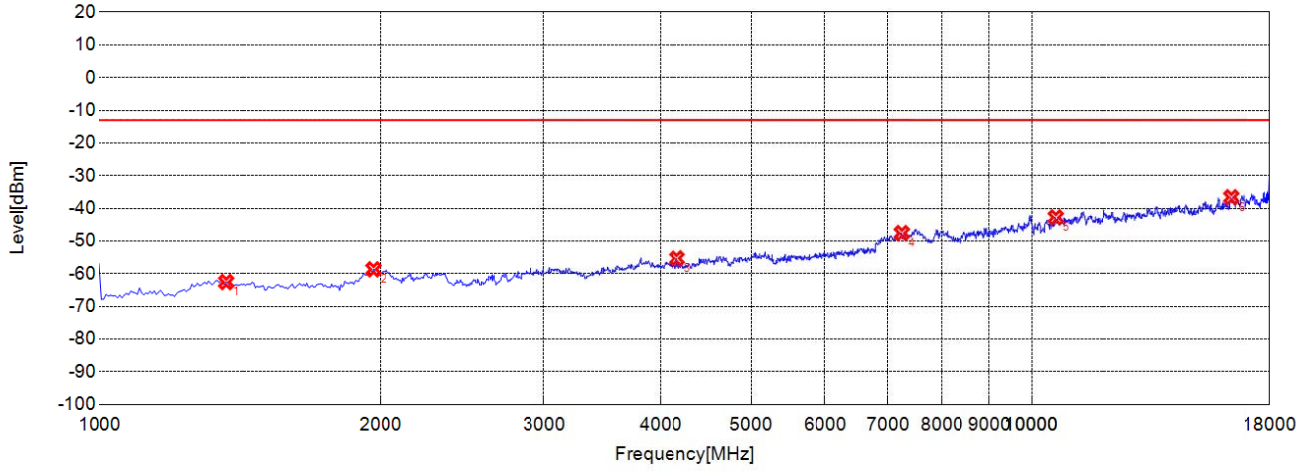

○ Final Test

Suspected List								
NO.	Freq. [MHz]	Level [dBm]	Limit [dBm]	Margin [dB]	Factor [dB]	Path [dB]	Air [dB]	Ant. Pol.
1	1365.7660	-62.56	-13.00	49.56	-8.14	-45.30	37.16	Horizontal
2	1963.7640	-58.67	-13.00	45.67	-4.86	-46.39	41.53	Horizontal
3	4164.1640	-55.31	-13.00	42.31	-7.13	-46.90	39.77	Horizontal
4	7248.4480	-47.59	-13.00	34.59	8.41	-36.95	45.36	Horizontal
5	10611.8120	-42.78	-13.00	29.78	13.19	-35.51	48.70	Horizontal
6	16363.1630	-36.62	-13.00	23.62	24.06	-27.30	51.36	Horizontal

CA_2A_4A Low 20M QPSK RB 1 0 1-18G H

Test Graph

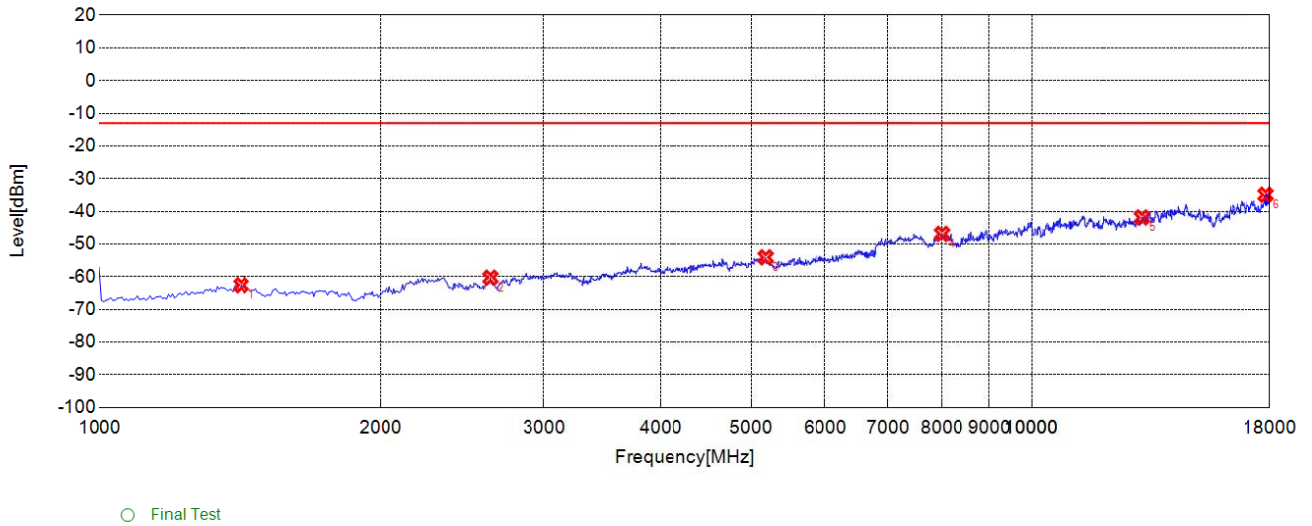

Suspected List								
NO.	Freq. [MHz]	Level [dBm]	Limit [dBm]	Margin [dB]	Factor [dB]	Path [dB]	Air [dB]	Ant. Pol.
1	1418.0180	-62.61	-13.00	49.61	-8.42	-45.38	36.96	Vertical
2	2625.6260	-60.3	-13.00	47.30	-10.31	-47.17	36.86	Vertical
3	5180.1800	-54.08	-13.00	41.08	-2.40	-43.42	41.02	Vertical
4	7999.6000	-46.9	-13.00	33.90	10.66	-35.26	45.92	Vertical
5	13145.5460	-41.88	-13.00	28.88	19.47	-29.67	49.14	Vertical
6	17831.8320	-34.94	-13.00	21.94	26.94	-26.24	53.18	Vertical

CA_2A_4A Low 20M QPSK RB 1 0 1-18G V



Test Graph

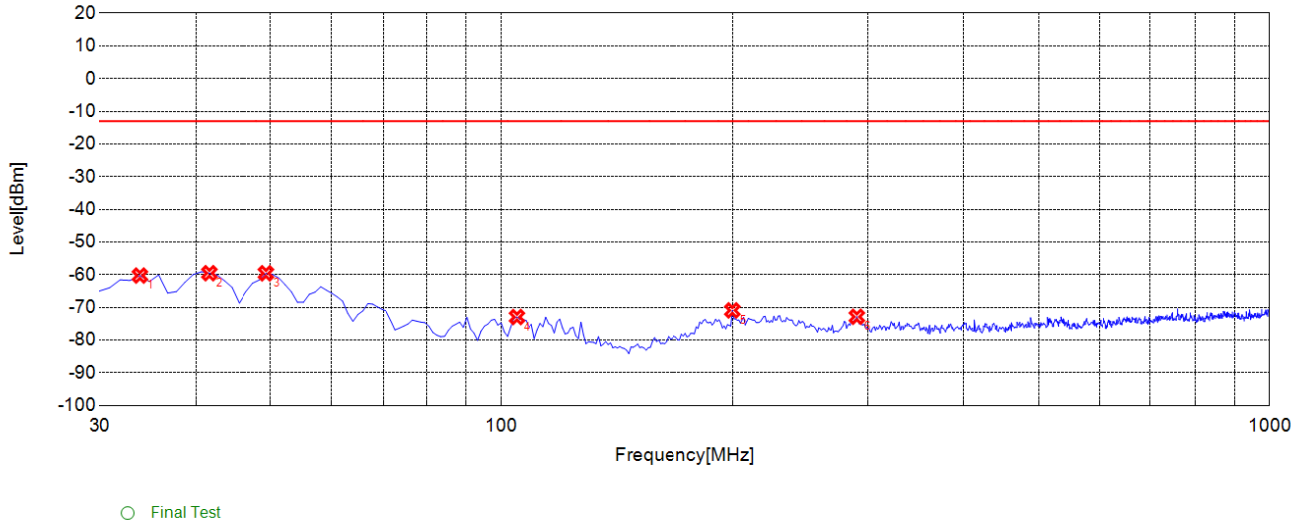

Suspected List								
NO.	Freq. [MHz]	Level [dBm]	Limit [dBm]	Margin [dB]	Factor [dB]	Path [dB]	Air [dB]	Ant. Pol.
1	33.8840	-60.26	-13.00	47.26	-9.81	-39.59	29.78	Horizontal
2	41.6520	-59.54	-13.00	46.54	-7.05	-39.53	32.48	Horizontal
3	49.4190	-59.58	-13.00	46.58	-7.01	-39.46	32.45	Horizontal
4	104.7650	-72.95	-13.00	59.95	-17.53	-38.70	21.17	Horizontal
5	199.9200	-70.92	-13.00	57.92	-14.94	-37.84	22.90	Horizontal
6	290.2200	-72.87	-13.00	59.87	-11.77	-36.97	25.20	Horizontal

CA_2A_4A Low 20M QPSK RB 1 0 30M-1G H

Test Graph

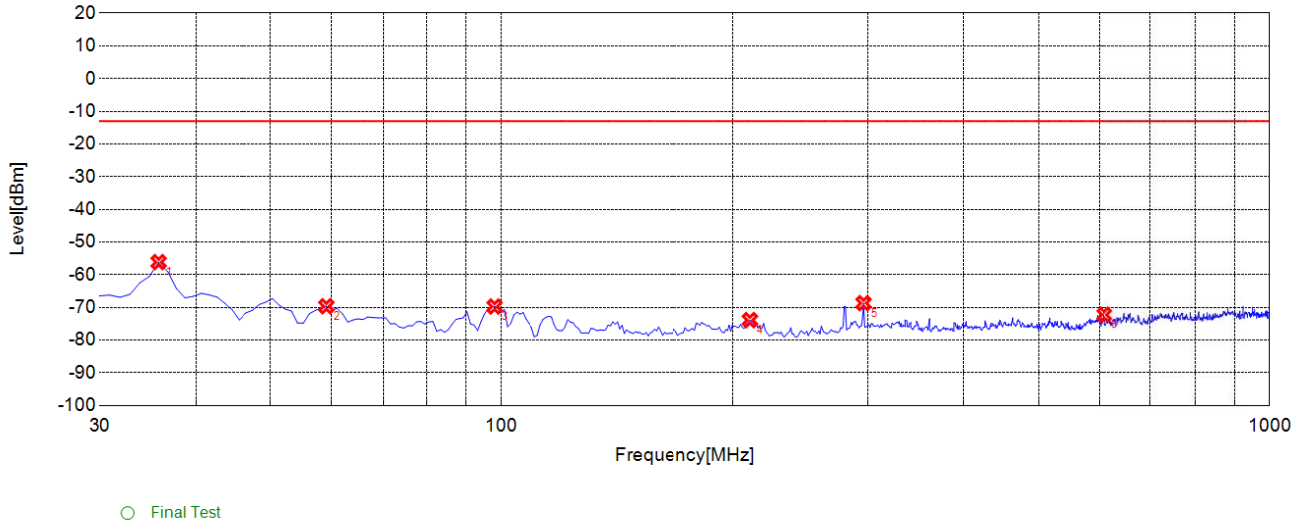

Suspected List								
NO.	Freq. [MHz]	Level [dBm]	Limit [dBm]	Margin [dB]	Factor [dB]	Path [dB]	Air [dB]	Ant. Pol.
1	35.8260	-56.14	-13.00	43.14	-16.61	-39.57	22.96	Vertical
2	59.1290	-69.66	-13.00	56.66	-18.04	-39.48	21.44	Vertical
3	97.9680	-69.74	-13.00	56.74	-13.26	-38.70	25.44	Vertical
4	210.6010	-73.89	-13.00	60.89	-16.64	-37.57	20.93	Vertical
5	296.0460	-68.7	-13.00	55.70	-12.04	-36.97	24.93	Vertical
6	609.6700	-72.25	-13.00	59.25	-5.44	-34.84	29.40	Vertical

CA_2A_4A Low 20M QPSK RB 1 0 30M-1G V

Test Graph

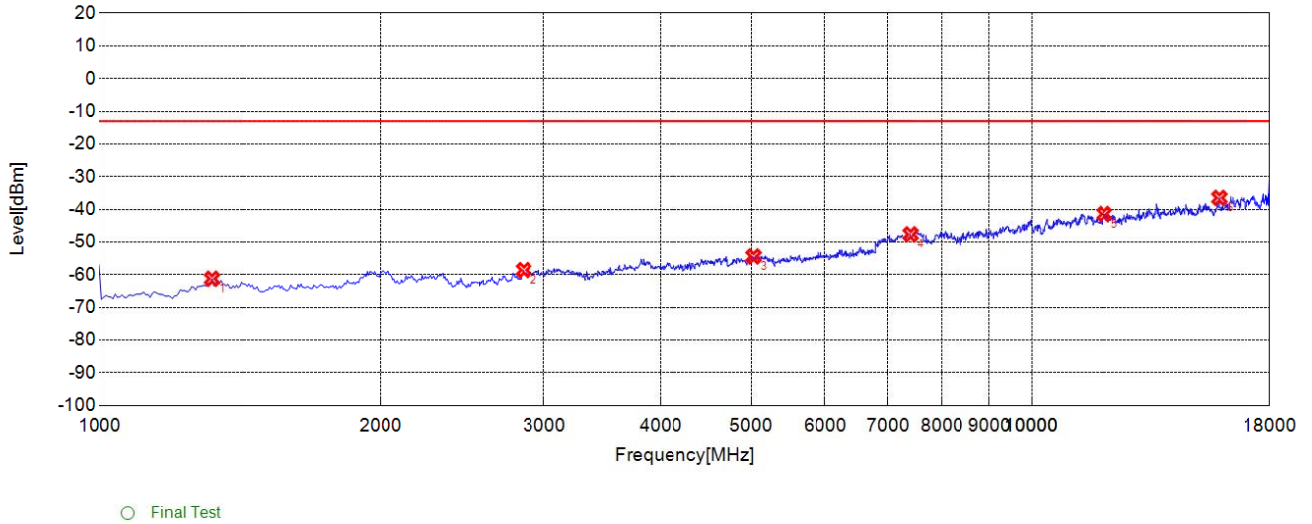

Suspected List								
NO.	Freq. [MHz]	Level [dBm]	Limit [dBm]	Margin [dB]	Factor [dB]	Path [dB]	Air [dB]	Ant. Pol.
1	1319.3190	-61.24	-13.00	48.24	-7.75	-45.28	37.53	Horizontal
2	2852.0520	-58.58	-13.00	45.58	-8.91	-47.51	38.60	Horizontal
3	5029.2290	-54.42	-13.00	41.42	-2.42	-43.84	41.42	Horizontal
4	7405.4050	-47.66	-13.00	34.66	8.83	-36.67	45.50	Horizontal
5	11968.3680	-41.43	-13.00	28.43	17.37	-31.86	49.23	Horizontal
6	15892.2920	-36.5	-13.00	23.50	23.50	-27.14	50.64	Horizontal

CA_2A_4A Middle 20M QPSK RB 1 0 1-18G H



Test Graph

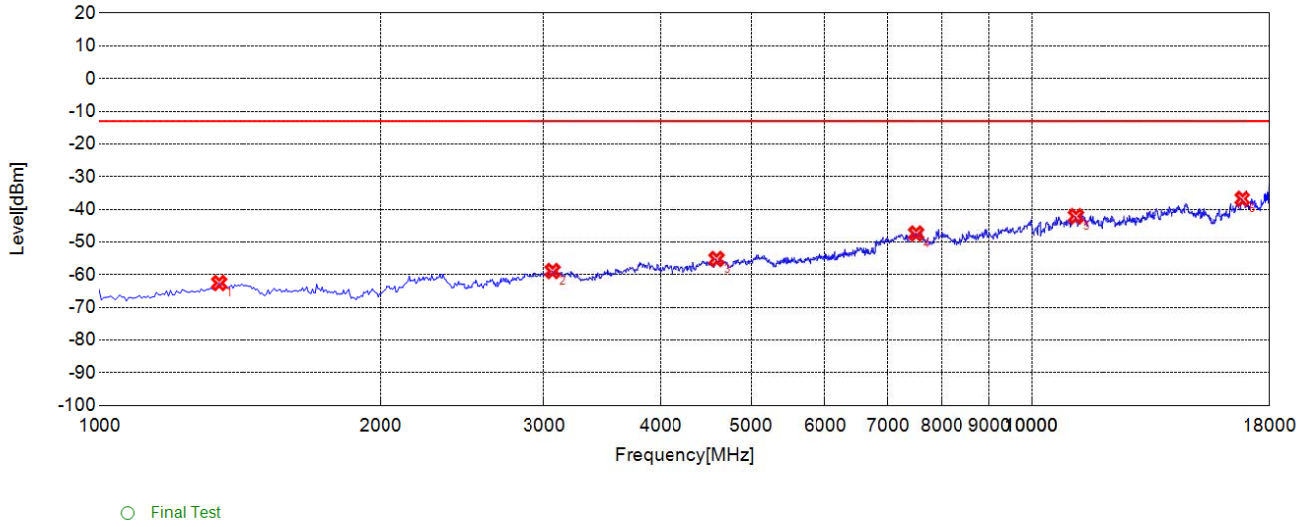

Suspected List								
NO.	Freq. [MHz]	Level [dBm]	Limit [dBm]	Margin [dB]	Factor [dB]	Path [dB]	Air [dB]	Ant. Pol.
1	1342.5430	-62.55	-13.00	49.55	-8.72	-45.27	36.55	Vertical
2	3066.8670	-58.87	-13.00	45.87	-8.76	-47.32	38.56	Vertical
3	4593.7940	-55.2	-13.00	42.20	-5.25	-45.40	40.15	Vertical
4	7506.3060	-47.41	-13.00	34.41	10.21	-35.54	45.75	Vertical
5	11149.9500	-42.13	-13.00	29.13	14.14	-34.76	48.90	Vertical
6	16822.8230	-36.77	-13.00	23.77	24.57	-26.51	51.08	Vertical

CA_2A_4A Middle 20M QPSK RB 1 0 1-18G V

Test Graph

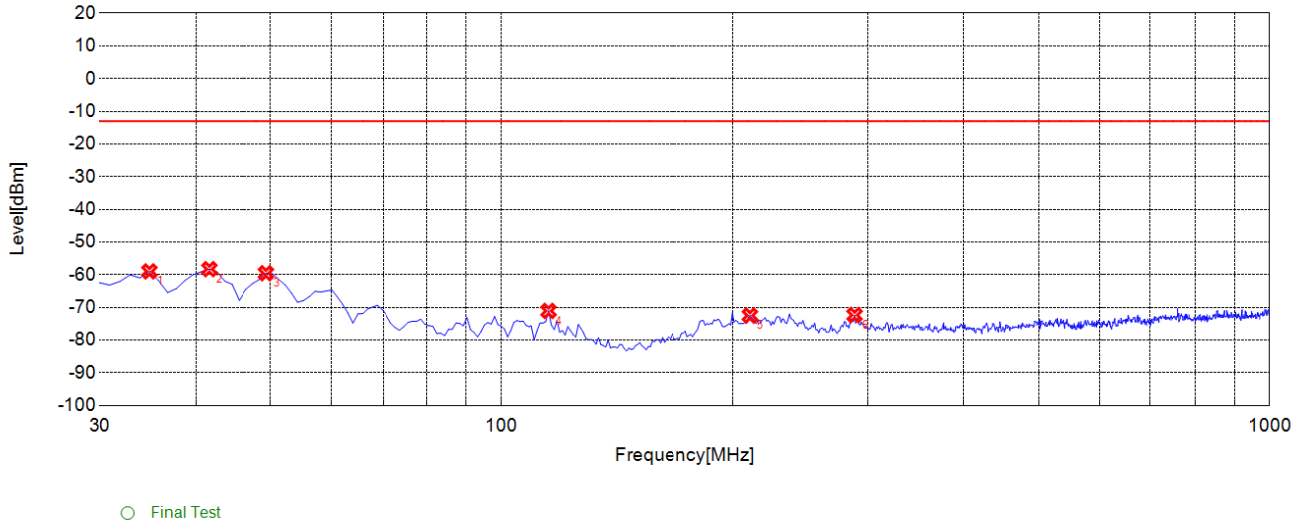

Suspected List								
NO.	Freq. [MHz]	Level [dBm]	Limit [dBm]	Margin [dB]	Factor [dB]	Path [dB]	Air [dB]	Ant. Pol.
1	34.8550	-58.99	-13.00	45.99	-9.37	-39.58	30.21	Horizontal
2	41.6520	-58.3	-13.00	45.30	-7.05	-39.53	32.48	Horizontal
3	49.4190	-59.55	-13.00	46.55	-7.01	-39.46	32.45	Horizontal
4	115.4450	-71.08	-13.00	58.08	-17.90	-38.64	20.74	Horizontal
5	210.6010	-72.49	-13.00	59.49	-13.93	-37.57	23.64	Horizontal
6	288.2780	-72.36	-13.00	59.36	-11.81	-36.98	25.17	Horizontal

CA_2A_4A Middle 20M QPSK RB 1 0 30M-1G H

Test Graph

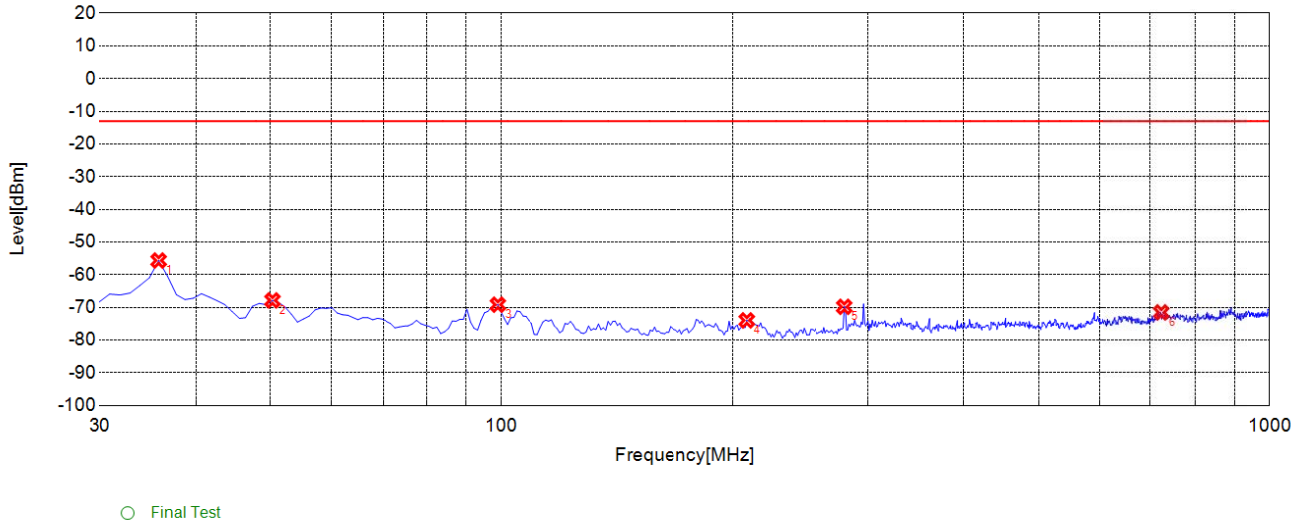

Suspected List								
NO.	Freq. [MHz]	Level [dBm]	Limit [dBm]	Margin [dB]	Factor [dB]	Path [dB]	Air [dB]	Ant. Pol.
1	35.8260	-55.66	-13.00	42.66	-16.61	-39.57	22.96	Vertical
2	50.3900	-67.86	-13.00	54.86	-15.33	-39.46	24.13	Vertical
3	98.9390	-69.17	-13.00	56.17	-12.86	-38.70	25.84	Vertical
4	208.6590	-73.98	-13.00	60.98	-16.60	-37.61	21.01	Vertical
5	279.5400	-69.83	-13.00	56.83	-12.54	-37.04	24.50	Vertical
6	723.2730	-71.53	-13.00	58.53	-3.68	-34.30	30.62	Vertical

CA_2A_4A Middle 20M QPSK RB 1 0 30M-1G V

Test Graph

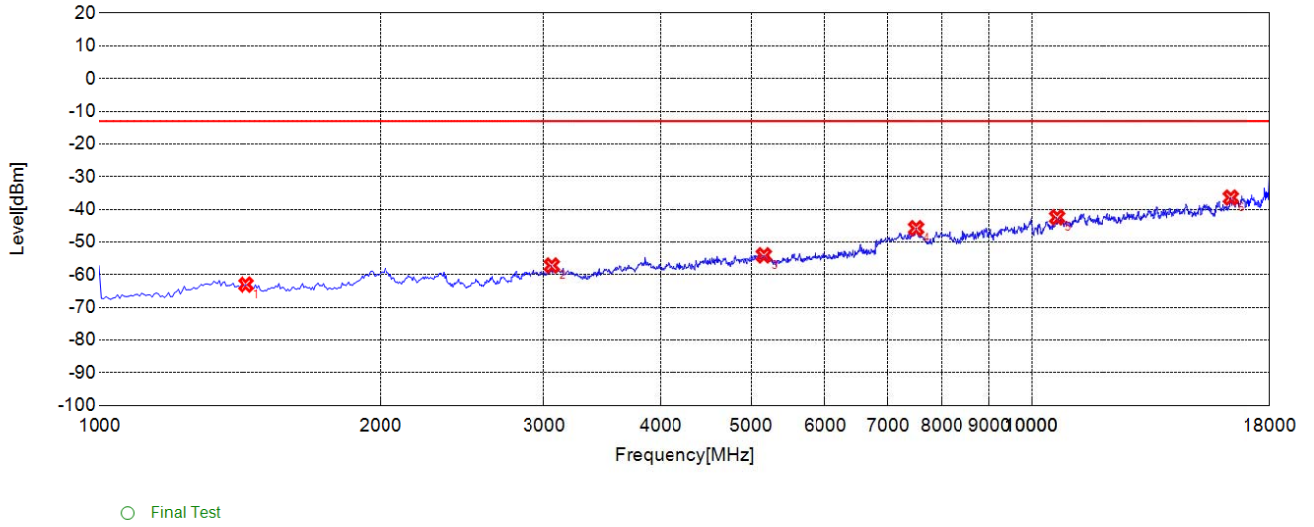

Suspected List								
NO.	Freq. [MHz]	Level [dBm]	Limit [dBm]	Margin [dB]	Factor [dB]	Path [dB]	Air [dB]	Ant. Pol.
1	1435.4350	-63.03	-13.00	50.03	-8.80	-45.40	36.60	Horizontal
2	3061.0610	-57.19	-13.00	44.19	-8.46	-47.36	38.90	Horizontal
3	5156.9570	-54.08	-13.00	41.08	-2.41	-43.73	41.32	Horizontal
4	7506.3060	-45.79	-13.00	32.79	10.60	-35.54	46.14	Horizontal
5	10645.4450	-42.46	-13.00	29.46	13.62	-35.02	48.64	Horizontal
6	16340.7410	-36.42	-13.00	23.42	23.82	-27.46	51.28	Horizontal

CA_2A_4A High 20M QPSK RB 1 0 1-18G H



Test Graph

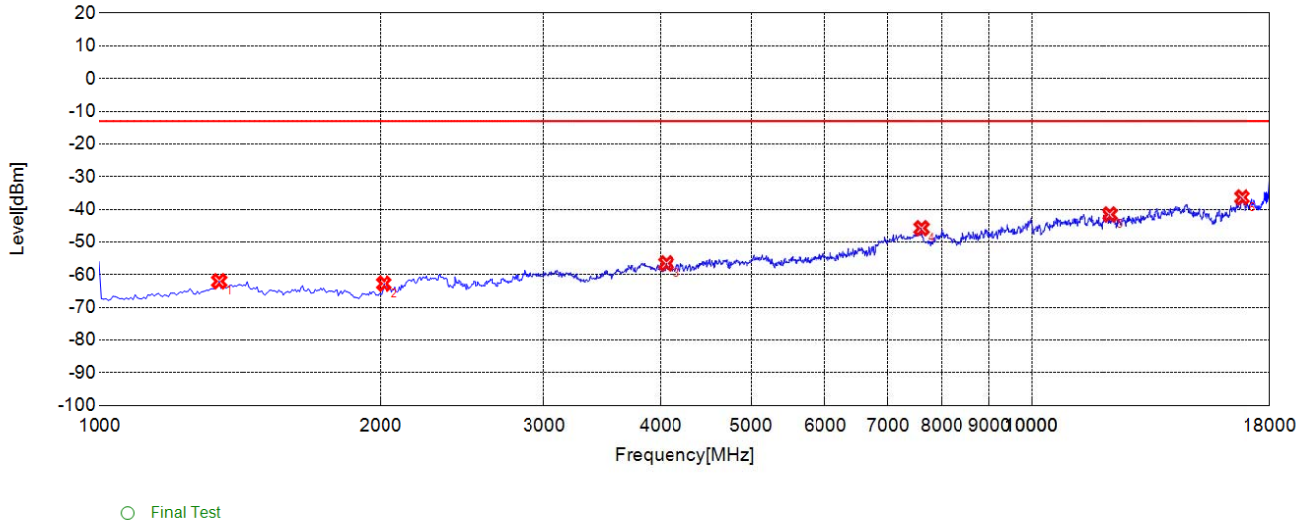

Suspected List								
NO.	Freq. [MHz]	Level [dBm]	Limit [dBm]	Margin [dB]	Factor [dB]	Path [dB]	Air [dB]	Ant. Pol.
1	1342.5430	-62.02	-13.00	49.02	-8.72	-45.27	36.55	Vertical
2	2016.0160	-62.73	-13.00	49.73	-10.03	-46.41	36.38	Vertical
3	4053.8540	-56.55	-13.00	43.55	-7.32	-46.68	39.36	Vertical
4	7607.2070	-45.78	-13.00	32.78	9.82	-35.34	45.16	Vertical
5	12147.7480	-41.58	-13.00	28.58	17.78	-31.03	48.81	Vertical
6	16811.6120	-36.36	-13.00	23.36	24.59	-26.39	50.98	Vertical

CA_2A_4A High 20M QPSK RB 1 0 1-18G V

Test Graph

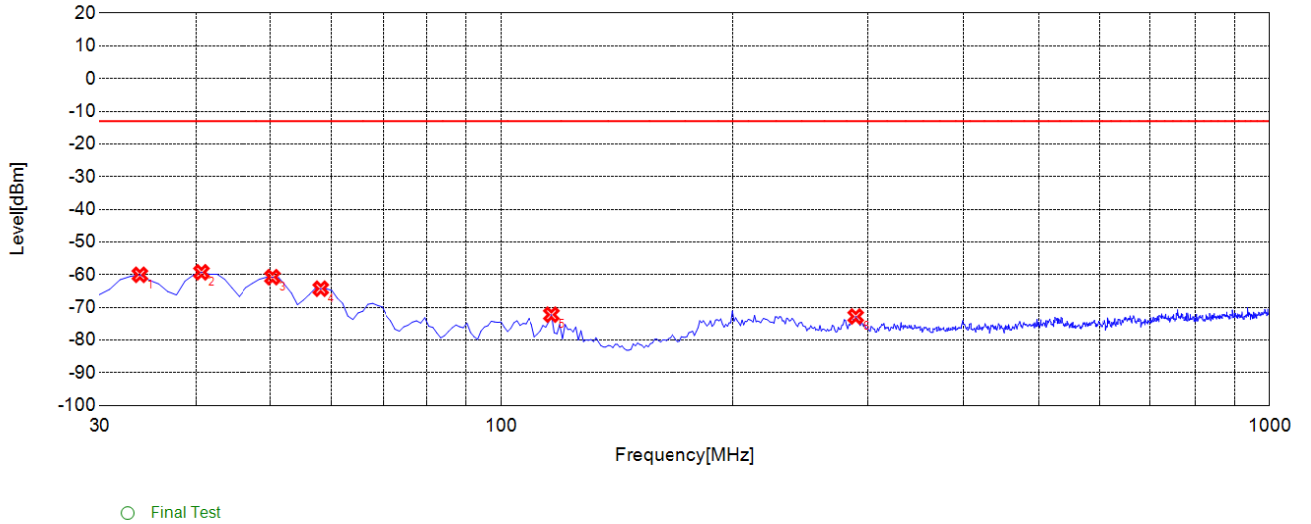

Suspected List								
NO.	Freq. [MHz]	Level [dBm]	Limit [dBm]	Margin [dB]	Factor [dB]	Path [dB]	Air [dB]	Ant. Pol.
1	33.8840	-60.03	-13.00	47.03	-9.81	-39.59	29.78	Horizontal
2	40.6810	-59.26	-13.00	46.26	-7.05	-39.53	32.48	Horizontal
3	50.3900	-60.75	-13.00	47.75	-7.16	-39.46	32.30	Horizontal
4	58.1580	-64.29	-13.00	51.29	-10.21	-39.48	29.27	Horizontal
5	116.4160	-72.23	-13.00	59.23	-17.95	-38.63	20.68	Horizontal
6	289.2490	-72.78	-13.00	59.78	-11.78	-36.97	25.19	Horizontal

CA_2A_4A High 20M QPSK RB 1 0 30M-1G H



Test Graph

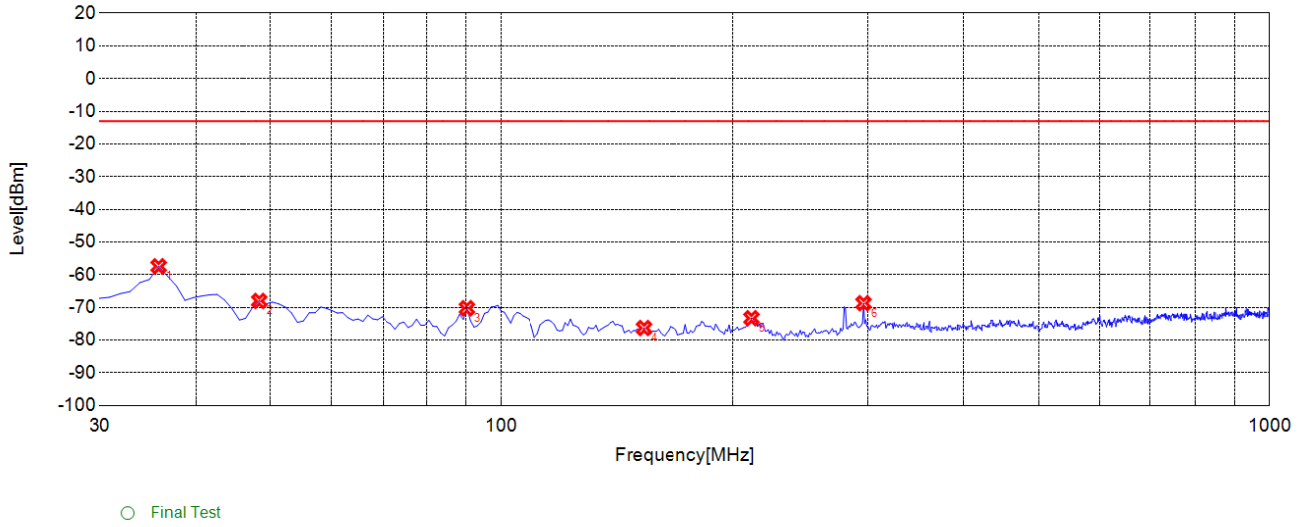

Suspected List								
NO.	Freq. [MHz]	Level [dBm]	Limit [dBm]	Margin [dB]	Factor [dB]	Path [dB]	Air [dB]	Ant. Pol.
1	35.8260	-57.44	-13.00	44.44	-16.61	-39.57	22.96	Vertical
2	48.4480	-68.03	-13.00	55.03	-15.38	-39.47	24.09	Vertical
3	90.2000	-70.25	-13.00	57.25	-16.50	-38.71	22.21	Vertical
4	153.3130	-76.32	-13.00	63.32	-16.80	-38.57	21.77	Vertical
5	211.5720	-73.32	-13.00	60.32	-16.60	-37.57	20.97	Vertical
6	296.0460	-68.73	-13.00	55.73	-12.04	-36.97	24.93	Vertical

CA_2A_4A High 20M QPSK RB 1 0 30M-1G V

Test Graph

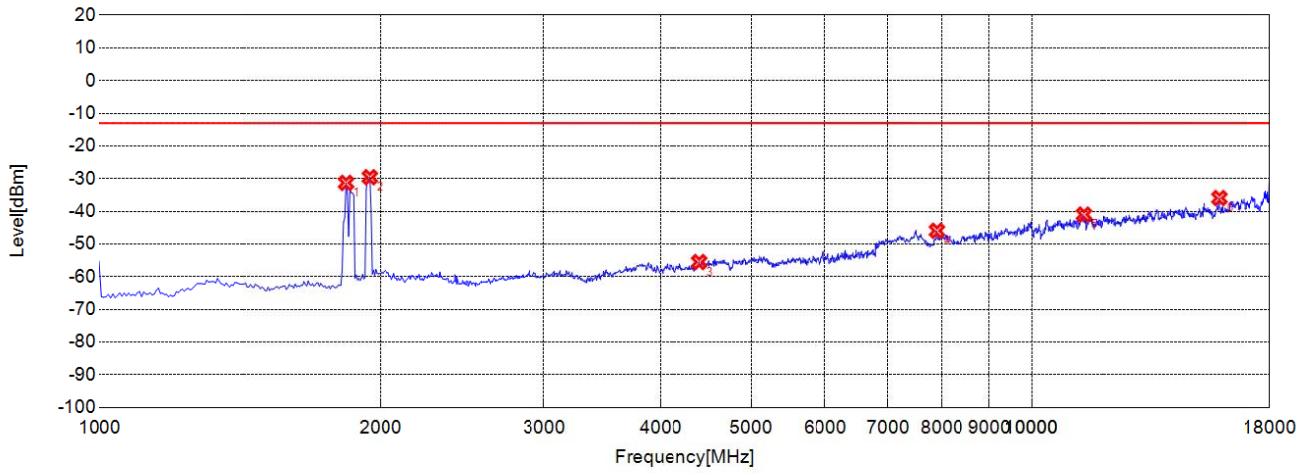

○ Final Test

Suspected List								
NO.	Freq. [MHz]	Level [dBm]	Limit [dBm]	Margin [dB]	Factor [dB]	Path [dB]	Air [dB]	Ant. Pol.
1	1836.0360	-31.3	-13.00	18.30	-7.58	-46.57	38.99	NA
2	1946.3460	-29.57	-13.00	16.57	-5.17	-46.45	41.28	NA
3	4402.2020	-55.51	-13.00	42.51	-5.69	-45.82	40.13	Horizontal
4	7898.6990	-45.96	-13.00	32.96	10.63	-34.87	45.50	Horizontal
5	11374.1740	-41	-13.00	28.00	15.96	-33.36	49.32	Horizontal
6	15892.2920	-35.94	-13.00	22.94	23.50	-27.14	50.64	Horizontal

CA_2A_5A Low 20M QPSK RB 1 0 1-18G H

Test Graph

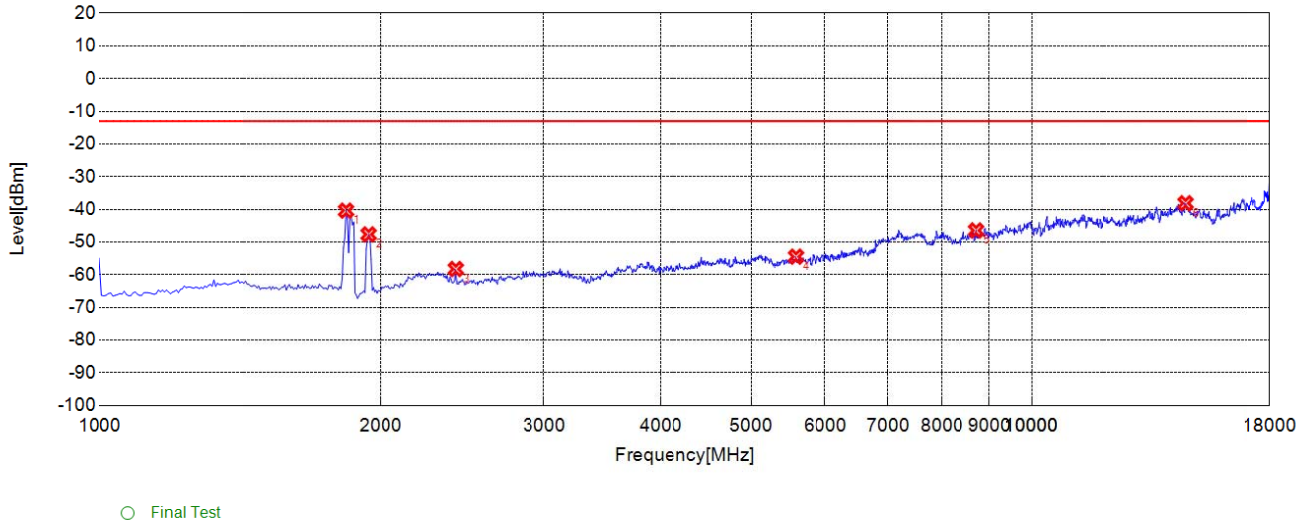

Suspected List								
NO.	Freq. [MHz]	Level [dBm]	Limit [dBm]	Margin [dB]	Factor [dB]	Path [dB]	Air [dB]	Ant. Pol.
1	1836.0360	-40.4	-13.00	27.40	-10.08	-46.57	36.49	NA
2	1940.5410	-47.67	-13.00	34.67	-10.70	-46.49	35.79	NA
3	2410.8110	-58.27	-13.00	45.27	-10.35	-47.43	37.08	Vertical
4	5580.7810	-54.49	-13.00	41.49	-2.62	-43.00	40.38	Vertical
5	8717.1170	-46.47	-13.00	33.47	9.80	-36.74	46.54	Vertical
6	14625.4250	-38.14	-13.00	25.14	22.44	-27.87	50.31	Vertical

CA_2A_5A Low 20M QPSK RB 1 0 1-18G V

Test Graph

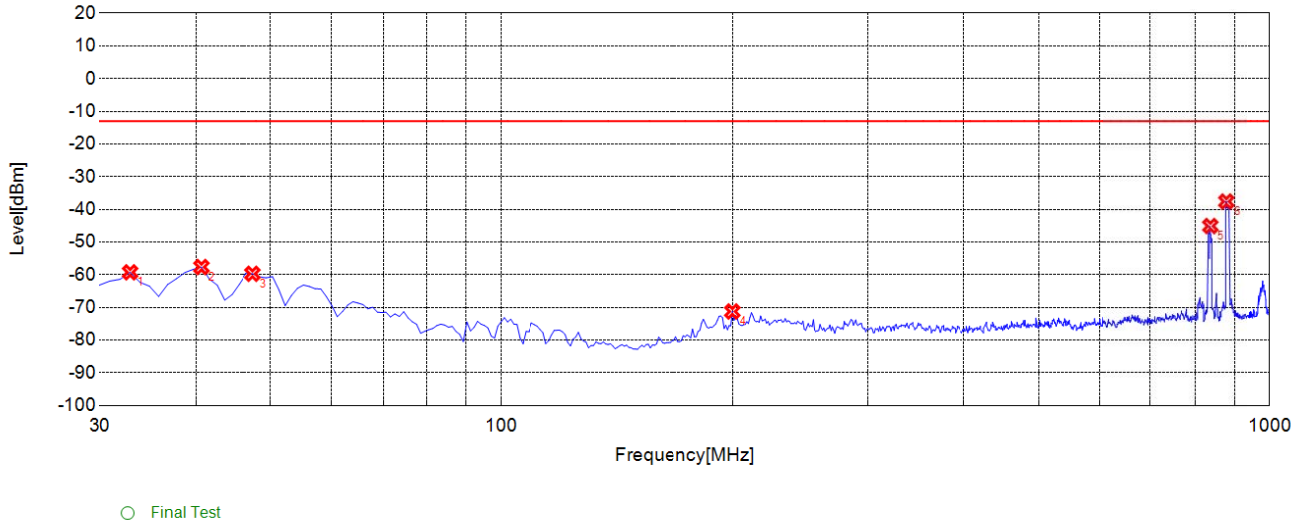

Suspected List								
NO.	Freq. [MHz]	Level [dBm]	Limit [dBm]	Margin [dB]	Factor [dB]	Path [dB]	Air [dB]	Ant. Pol.
1	32.9130	-59.27	-13.00	46.27	-10.25	-39.60	29.35	Horizontal
2	40.6810	-57.65	-13.00	44.65	-7.05	-39.53	32.48	Horizontal
3	47.4770	-59.72	-13.00	46.72	-7.02	-39.48	32.46	Horizontal
4	199.9200	-71.26	-13.00	58.26	-14.94	-37.84	22.90	Horizontal
5	836.8770	-45.11	-13.00	32.11	-2.58	-34.13	31.55	NA
6	877.6580	-37.61	-13.00	24.61	-2.16	-34.02	31.86	NA

CA_2A_5A Low 20M QPSK RB 1 0 30M-1G H

Test Graph

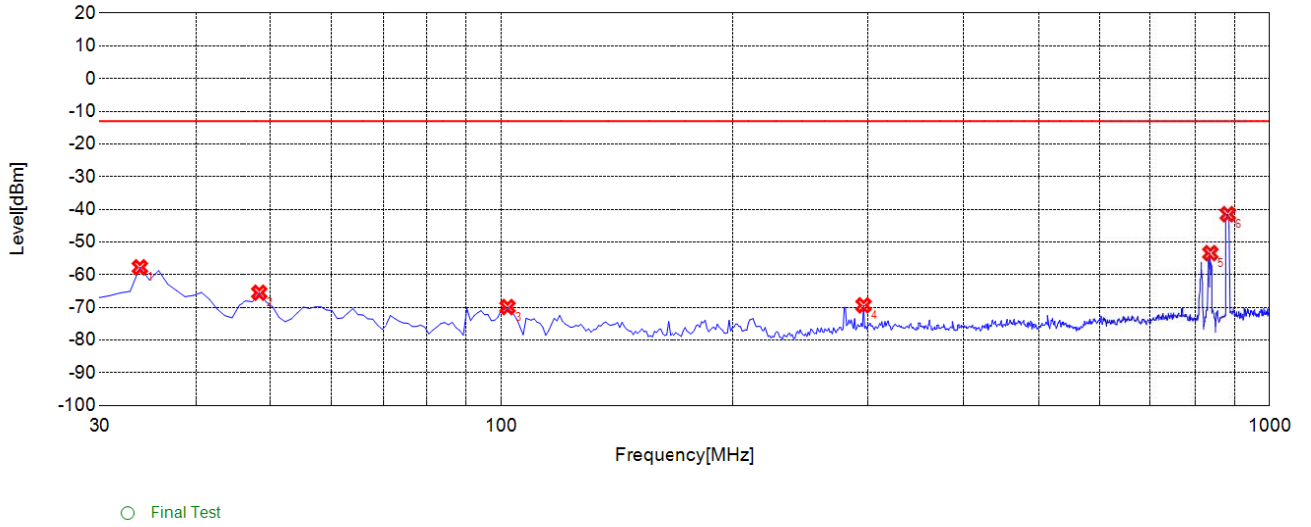

Suspected List								
NO.	Freq. [MHz]	Level [dBm]	Limit [dBm]	Margin [dB]	Factor [dB]	Path [dB]	Air [dB]	Ant. Pol.
1	33.8840	-57.74	-13.00	44.74	-16.76	-39.59	22.83	Vertical
2	48.4480	-65.51	-13.00	52.51	-15.38	-39.47	24.09	Vertical
3	101.8520	-69.89	-13.00	56.89	-13.11	-38.70	25.59	Vertical
4	296.0460	-69.37	-13.00	56.37	-12.04	-36.97	24.93	Vertical
5	836.8770	-53.41	-13.00	40.41	-2.70	-34.13	31.43	NA
6	881.5420	-41.5	-13.00	28.50	-1.51	-34.01	32.50	NA

CA_2A_5A Low 20M QPSK RB 1 0 30M-1G V