



FCC PART 15 SUBPART C TEST REPORT

FCC PART 15.247

Report Reference No.....: TRE1311004701 R/C: 47516

FCC ID..... : 2ABG7-DB85

Compiled by
(position+printed name+signature)..: File administrators Jerome Luo

Jerome Luo

Supervised by
(position+printed name+signature)..: Test Engineer Yuchao Wang

yuchao.wang

Approved by
(position+printed name+signature)..: Manager Wenliang Li

Wenliang Li

Date of issue.....: Dec,13 2013

Testing Laboratory Name: Shenzhen Huatongwei International Inspection Co., Ltd

Address: Keji Nan No.12 Road, Hi-tech Park, Shenzhen, China

Applicant's name: Truly Instrument Ltd

Address: Truly Industrial Area,Shanwei City,Guangdong Province,China

Test specification

Standard: FCC Part 15.247: Operation within the bands 902-928 MHz, 2400-2483.5 MHz and 5725-5850 MHz

TRF Originator.....: Shenzhen Huatongwei International Inspection CO., Ltd

Master TRF.....: Dated 2006-06

Shenzhen Huatongwei International Inspection Co., Ltd. All rights reserved.

This publication may be reproduced in whole or in part for non-commercial purposes as long as the Shenzhen Huatongwei International Inspection Co., Ltd is acknowledged as copyright owner and source of the material. Shenzhen Huatongwei International Inspection Co., Ltd takes no responsibility for and will not assume liability for damages resulting from the reader's interpretation of the reproduced material due to its placement and context.

Test item description: BLOOD PRESSURE MONITOR

Trade Mark: TRULY

Model/Type reference.....: DB85

Listed Models: /

Manufacturer: Truly Instrument Ltd

Modulation Type.....: GFSK

Operation Frequency.....: From 2402MHz to 2480MHz

Rating: 4"AA" Battery 6V

Result.....: PASS

T E S T R E P O R T

Test Report No. :	TRE1311004701	Dec,13 2013
		Date of issue

Equipment under Test : BLOOD PRESSURE MONITOR

Model /Type : DB85

Listed Models : /

Applicant : **Truly Instrument Ltd**

Address : Truly Industrial Area,Shanwei City,Guangdong Province,China

Manufacturer : **Truly Instrument Ltd**

Address : Truly Industrial Area,Shanwei City,Guangdong Province,China

Test Result:	PASS
---------------------	-------------

The test report merely corresponds to the test sample.

It is not permitted to copy extracts of these test result without the written permission of the test laboratory.

Contents

1.	<u>TEST STANDARDS</u>	4
2.	<u>SUMMARY</u>	5
2.1.	General Remarks	5
2.2.	Equipment Under Test	5
2.3.	Short description of the Equipment under Test (EUT)	5
2.4.	EUT operation mode	5
2.5.	Block Diagram of Test Setup	5
2.6.	Related Submittal(s) / Grant (s)	6
2.7.	Modifications	6
2.8.	NOTE	6
3.	<u>TEST ENVIRONMENT</u>	7
3.1.	Address of the test laboratory	7
3.2.	Test Facility	7
3.3.	Environmental conditions	8
3.4.	Test Description	8
3.5.	Statement of the measurement uncertainty	8
3.6.	Equipments Used during the Test	8
4.	<u>TEST CONDITIONS AND RESULTS</u>	10
4.1.	AC Power Conducted Emission(Not Applicable)	10
4.2.	Radiated Emission	11
4.3.	Maximum Peak Output Power	16
4.4.	Power Spectral Density	18
4.5.	6dB Bandwidth	21
4.6.	Band Edge Compliance of RF Emission	23
4.7.	Spurious RF Conducted Emission	27
4.8.	Antenna Requirement	34
5.	<u>TEST SETUP PHOTOS OF THE EUT</u>	35
6.	<u>EXTERNAL AND INTERNAL PHOTOS OF THE EUT</u>	36

1. TEST STANDARDS

The tests were performed according to following standards:

[FCC Rules Part 15.247](#): Frequency Hopping, Direct Spread Spectrum and Hybrid Systems that are in operation within the bands of 902-928 MHz, 2400-2483.5 MHz, and 5725-5850 MHz.

[ANSI C63.10-2009](#): American National Standard for Testing Unlicensed Wireless Devices

[KDB558074 D01 V03](#): Guidance for Performing Compliance Measurements on Digital Transmission Systems (DTS) Operating Under §15.247

2. SUMMARY

2.1. General Remarks

Date of receipt of test sample	:	Nov 25, 2013
Testing commenced on	:	Dec 05, 2013
Testing concluded on	:	Dec 13, 2013

2.2. Equipment Under Test

Power supply system utilised

Power supply voltage	:	<input type="radio"/> 120V / 60 Hz	<input type="radio"/> 115V / 60Hz
		<input type="radio"/> 12 V DC	<input type="radio"/> 24 V DC
		<input checked="" type="radio"/> Other (specified in blank below)	

4"AA" Battery 6V

2.3. Short description of the Equipment under Test (EUT)

2.4GHz (BLOOD PRESSURE MONITOR (M/N:DB85))

For more details, refer to the user's manual of the EUT.

2.4. EUT operation mode

The EUT has been tested under 100% duty cycle operation condition. The Applicant provides communication tools software to control the EUT for staying in continuous transmitting and receiving mode for testing. There are 40 channels of EUT, and the test carried out at the lowest channel, middle channel and highest channel .

Channel	Frequency(MHz)	Channel	Frequency(MHz)
00	2402	20	2442
01	2404	21	2444
02	2406	22	2446
03	2408	23	2448
04	2410	24	2450
05	2412	25	2452
06	2414	26	2454
07	2416	27	2456
08	2418	28	2458
09	2420	29	2460
10	2422	30	2462
11	2424	31	2464
12	2426	32	2466
13	2428	33	2468
14	2430	34	2470
15	2432	35	2472
16	2434	36	2474
17	2436	37	2476
18	2438	38	2478
19	2440	39	2480

2.5. Block Diagram of Test Setup



2.6. Related Submittal(s) / Grant (s)

This submittal(s) (test report) is intended for **FCC ID: 2ABG7-DB85** filing to comply with Section 15.247 of the FCC Part 15, Subpart C Rules.

2.7. Modifications

No modifications were implemented to meet testing criteria.

2.8. NOTE

1. The EUT is a Blood Pressure Monitor with Bluetooth function, The functions of the EUT listed as below:

	Test Standards	Reference Report
Bluetooth	FCC Part 15 Subpart C	TRE1311004701
RF Exposure	FCC Per 47 CFR 2.1093(d)	TRE1311004702

2. The frequency bands used in this EUT are listed as follows:

Frequency Band(MHz)	2400-2483.5	5150-5350	5470-5725	5725-5850
EUT	√	—	—	—

3 . TEST ENVIRONMENT

3.1. Address of the test laboratory

Shenzhen Huatongwei International Inspection Co., Ltd
Keji Nan No.12 Road, Hi-tech Park, Shenzhen, China
Phone: 86-755-26715686 Fax: 86-755-26748089

The sites are constructed in conformance with the requirements of ANSI C63.7, ANSI C63.4 (2009) and CISPR Publication 22.

3.2. Test Facility

The test facility is recognized, certified, or accredited by the following organizations:

CNAS-Lab Code: L1225

Shenzhen Huatongwei International Inspection Co., Ltd. has been assessed and proved to be in compliance with CNAS-CL01 Accreditation Criteria for Testing and Calibration Laboratories (identical to ISO/IEC 17025: 2005 General Requirements) for the Competence of Testing and Calibration Laboratories, Date of Registration: Mar. 01, 2012. Valid time is until Feb 28, 2015.

A2LA-Lab Cert. No. 2243.01

Shenzhen Huatongwei International Inspection Co., Ltd. EMC Laboratory has been accredited by A2LA for technical competence in the field of electrical testing, and proved to be in compliance with ISO/IEC 17025: 2005 General Requirements for the Competence of Testing and Calibration Laboratories and any additional program requirements in the identified field of testing. Valid time is until Sept. 30, 2015.

FCC-Registration No.: 662850

Shenzhen Huatongwei International Inspection Co., Ltd. EMC Laboratory has been registered and fully described in a report filed with the FCC (Federal Communications Commission). The acceptance letter from the FCC is maintained in our files. Registration 662850, Renewal date Jun. 01, 2012, valid time is until Jun. 01, 2015.

IC-Registration No.: 5377A

The 3m Alternate Test Site of Shenzhen Huatongwei International Inspection Co., Ltd. has been registered by Certification and Engineering Bureau of Industry Canada for the performance of radiated measurements with Registration No. 5377A on Jan. 25, 2011, valid time is until Jan. 24, 2014.

ACA

Shenzhen Huatongwei International Inspection Co., Ltd. EMC Laboratory can also perform testing for the Australian C-Tick mark as a result of our A2LA accreditation.

VCCI

The 3m Semi-anechoic chamber (12.2m×7.95m×6.7m) and Shielded Room (8m×4m×3m) of Shenzhen Huatongwei International Inspection Co., Ltd. has been registered in accordance with the Regulations for Voluntary Control Measures with Registration No.: G-292. Date of Registration: Dec. 24, 2010. Valid time is until Dec. 23, 2013.

Main Ports Conducted Interference Measurement of Shenzhen Huatongwei International Inspection Co., Ltd. has been registered in accordance with the Regulations for Voluntary Control Measures with Registration No.: C-2726. Date of Registration: Dec. 20, 2012. Valid time is until Dec. 19, 2015.

Telecommunication Ports Conducted Interference Measurement of Shenzhen Huatongwei International Inspection Co., Ltd. has been registered in accordance with the Regulations for Voluntary Control Measures with Registration No.: T-1837. Date of Registration: May 07, 2013. Valid time is until May 06, 2016.

DNV

Shenzhen Huatongwei International Inspection Co., Ltd. has been found to comply with the requirements of DNV towards subcontractor of EMC and safety testing services in conjunction with the EMC and Low voltage Directives and in the voluntary field. The acceptance is based on a formal quality Audit and follow-ups according to relevant parts of ISO/IEC Guide 17025 (2005), in accordance with the requirements of the DNV Laboratory Quality Manual towards subcontractors. Valid time is until Aug. 24, 2015.

3.3. Environmental conditions

During the measurement the environmental conditions were within the listed ranges:

Temperature:	<u>15-35 ° C</u>
Humidity:	<u>30-60 %</u>
Atmospheric pressure:	<u>950-1050mbar</u>

3.4. Test Description

FCC PART 15 15.247		
FCC Part 15.207	AC Power Conducted Emission	PASS
FCC Part 15.247(a)(2)	6dB Bandwidth	PASS
FCC Part 15.247(d)	Spurious RF Conducted Emission	PASS
FCC Part 15.247(b)	Maximum Peak Output Power	PASS
FCC Part 15.247(e)	Power Spectral Density	PASS
FCC Part 15.109/ 15.205/ 15.209	Radiated Emissions	PASS
FCC Part 15.247(d)	Band Edge	PASS
FCC Part 15.203/15.247 (b)	Antenna Requirement	PASS
FCC Part 1.1307 (b)	RF Exposure Evaluation	PASS

Remark: The measurement uncertainty is not included in the test result.

3.5. Statement of the measurement uncertainty

The data and results referenced in this document are true and accurate. The reader is cautioned that there may be errors within the calibration limits of the equipment and facilities. The measurement uncertainty was calculated for all measurements listed in this test report acc. to CISPR 16 - 4 „Specification for radio disturbance and immunity measuring apparatus and methods – Part 4: Uncertainty in EMC Measurements“ and is documented in the Shenzhen Huatongwei International Inspection Co., Ltd quality system acc. to DIN EN ISO/IEC 17025. Furthermore, component and process variability of devices similar to that tested may result in additional deviation. The manufacturer has the sole responsibility of continued compliance of the device.

Hereafter the best measurement capability for Shenzhen Huatongwei laboratory is reported:

Test Items	Measurement Uncertainty	Notes
Transmitter power conducted	0.57 dB	(1)
Transmitter power Radiated	2.20 dB	(1)
Conducted spurious emission 9KHz-40 GHz	1.60 dB	(1)
Radiated spurious emission 9KHz-40 GHz	2.20 dB	(1)
Conducted Emission 9KHz-30MHz	3.39 dB	(1)
Radiated Emission 30~1000MHz	4.24 dB	(1)
Radiated Emissio 1~18GHz	5.16 dB	(1)
Radiated Emissio 18-40GHz	5.54 dB	(1)
Occupied Bandwidth	-----	(1)

(1) This uncertainty represents an expanded uncertainty expressed at approximately the 95% confidence level using a coverage factor of k=1.96.

3.6. Equipments Used during the Test

AC Power Conducted Emission					
Item	Test Equipment	Manufacturer	Model No.	Serial No.	Last Cal.
1	Artificial Mains	Rohde&Schwarz	ESH2-Z5	100028	2013/10/26
2	EMI Test Receiver	Rohde&Schwarz	ESCI3	100038	2013/10/26
3	Pulse Limiter	Rohde&Schwarz	ESHSZ2	100044	2013/10/26
4	EMI Test Software	Rohde&Schwarz	ES-K1 V1.71	N/A	N/A

Radiated Emission					
Item	Test Equipment	Manufacturer	Model No.	Serial No.	Last Cal.
1	Ultra-Broadband Antenna	ShwarzBeck	VULB9163	538	2013/10/26
2	EMI TEST RECEIVER	Rohde&Schwarz	ESI 26	100009	2013/10/26
3	EMI TEST SOFTWARE	Audix	E3	N/A	N/A
4	TURNTABLE	ETS	2088	2149	N/A
5	ANTENNA MAST	ETS	2075	2346	N/A
6	EMI TEST SOFTWARE	Rohde&Schwarz	ESK1	N/A	N/A
7	HORN ANTENNA	ShwarzBeck	9120D	1011	2013/10/26
8	Amplifer	Sonoma	310N	E009-13	2013/10/26
9	JS amplifier	Rohde&Schwarz	JS4-00101800-28-5A	F201504	2013/10/26
10	High pass filter	Compliance Direction systems	BSU-6	34202	2013/10/26
11	HORN ANTENNA	ShwarzBeck	9120D	1012	2013/10/26
12	Amplifer	Compliance Direction systems	PAP1-4060	120	2013/10/26
13	Loop Antenna	Rohde&Schwarz	HFH2-Z2	100020	2013/10/26
14	TURNTABLE	MATURO	TT2.0	----	N/A
15	ANTENNA MAST	MATURO	TAM-4.0-P	----	N/A
16	Horn Antenna	SCHWARZBECK	BBHA9170	25841	2013/10/26

Maximum Peak Output Power / Power Spectral Density / 6dB Bandwidth / Band Edge Compliance of RF Emission / Spurious RF Conducted Emission					
Item	Test Equipment	Manufacturer	Model No.	Serial No.	Last Cal.

1	Spectrum Analyzer	Rohde&Schwarz	FSP	1164.4391.40	2013/10/26
---	-------------------	---------------	-----	--------------	------------

The Cal.Interval was one year

4. TEST CONDITIONS AND RESULTS

4.1. AC Power Conducted Emission(Not Applicable)

TEST CONFIGURATION

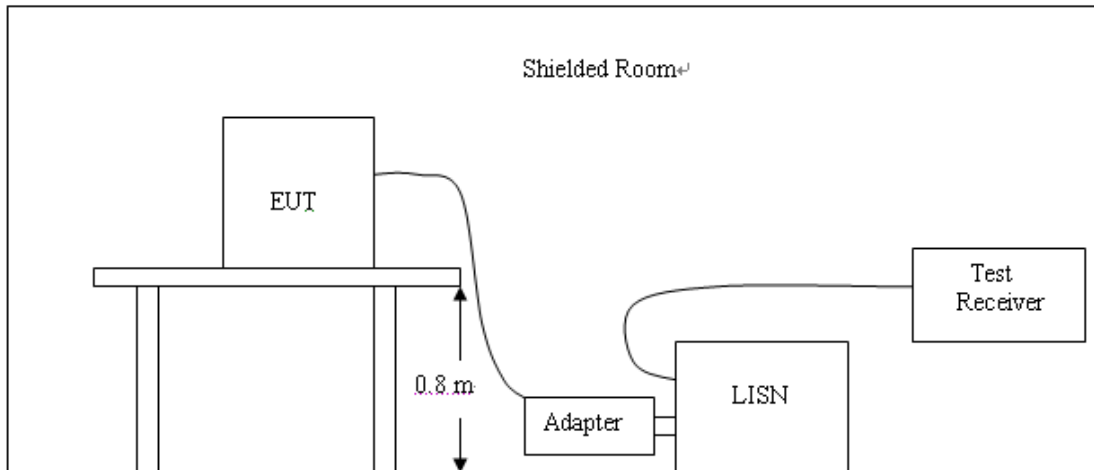

TEST PROCEDURE

- 1 The equipment was set up as per the test configuration to simulate typical actual usage per the user's manual. The EUT is a tabletop system, a wooden table with a height of 0.8 meters is used and is placed on the ground plane as per ANSI C63.10-2009.
- 2 Support equipment, if needed, was placed as per ANSI C63.10-2009
- 3 All I/O cables were positioned to simulate typical actual usage as per ANSI C63.10-2009
- 4 The EUT received DC5V power from PC, the adapter of PC received AC120V/60Hz power through a Line Impedance Stabilization Network (LISN) which supplied power source and was grounded to the ground plane.
- 5 All support equipments received AC power from a second LISN, if any.
- 6 The EUT test program was started. Emissions were measured on each current carrying line of the EUT using a spectrum Analyzer / Receiver connected to the LISN powering the EUT. The LISN has two monitoring points: Line 1 (Hot Side) and Line 2 (Neutral Side). Two scans were taken: one with Line 1 connected to Analyzer / Receiver and Line 2 connected to a 50 ohm load; the second scan had Line 1 connected to a 50 ohm load and Line 2 connected to the Analyzer / Receiver.
- 7 Analyzer / Receiver scanned from 150 KHz to 30MHz for emissions in each of the test modes.
- 8 During the above scans, the emissions were maximized by cable manipulation.

AC Power Conducted Emission Limit

For intentional device, according to § 15.207(a) AC Power Conducted Emission Limits is as following :

Frequency (MHz)	Maximum RF Line Voltage (dBµV)			
	CLASS A		CLASS B	
	Q.P.	Ave.	Q.P.	Ave.
0.15 - 0.50	79	66	66-56*	56-46*
0.50 - 5.00	73	60	56	46
5.00 - 30.0	73	60	60	50

* Decreasing linearly with the logarithm of the frequency

TEST RESULTS

Not applicable to this device(The product was powered by battery).

4.2. Radiated Emission

TEST CONFIGURATION

Frequency range 9KHz – 30MHz

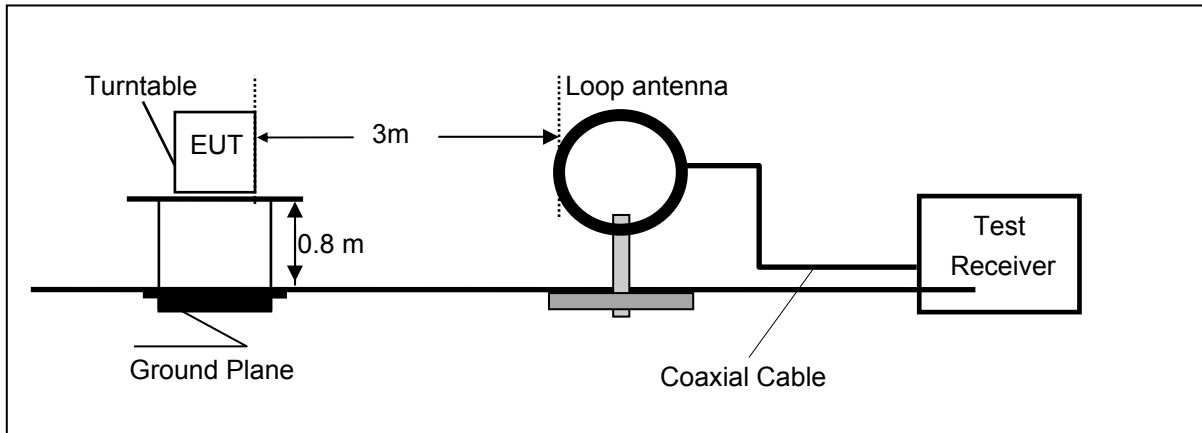

Frequency range 30MHz – 1000MHz

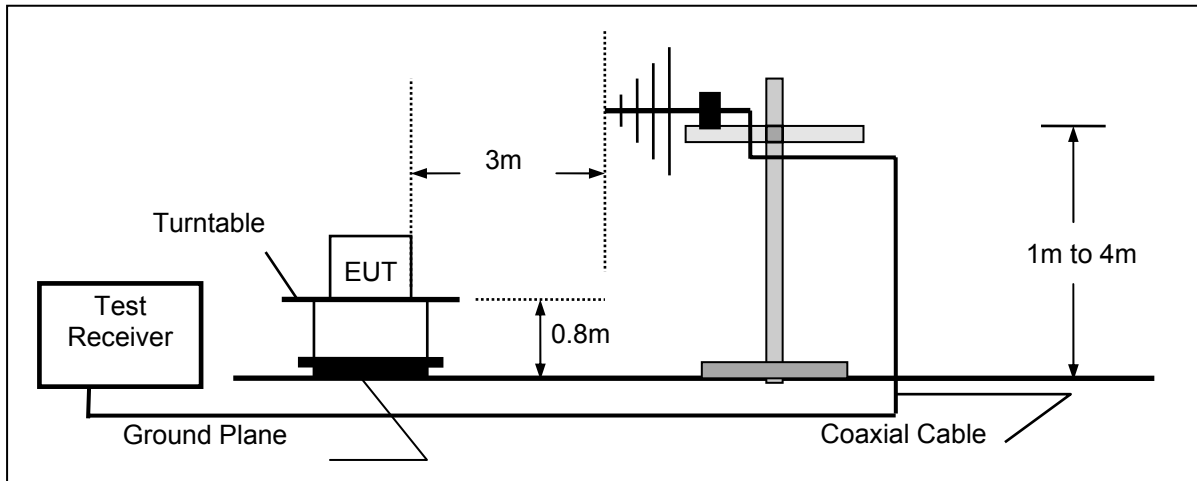

Frequency range above 1GHz-25GHz

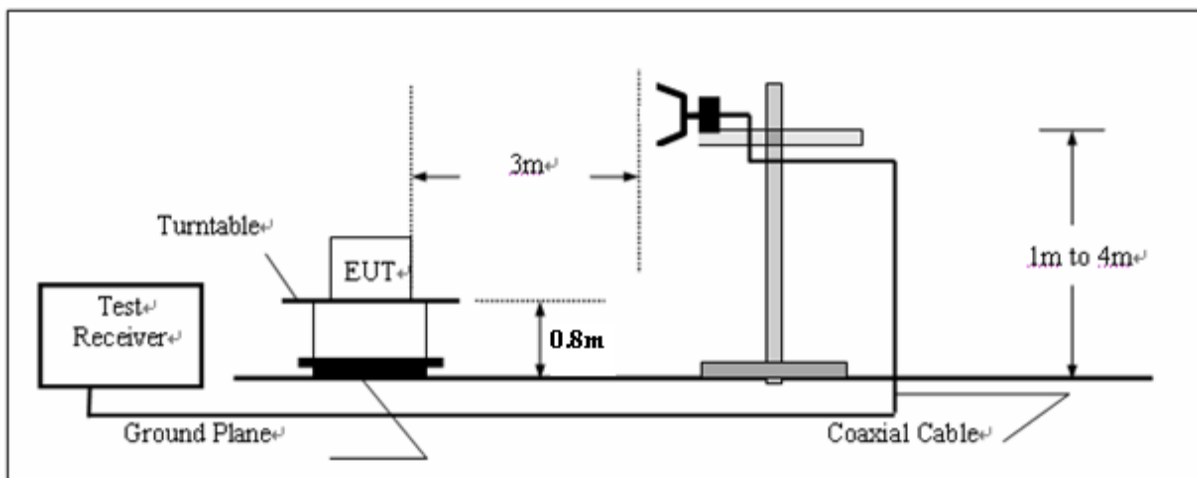

TEST PROCEDURE

1. The EUT was placed on a turn table which is 0.8m above ground plane.
2. Maximum procedure was performed by raising the receiving antenna from 1m to 4m and rotating the turn table from 0° to 360° to acquire the highest emissions from EUT
3. And also, each emission was to be maximized by changing the polarization of receiving antenna both horizontal and vertical.
4. Repeat above procedures until all frequency measurements have been completed.
5. The EUT minimum operation frequency was 32.768KHz and maximum operation frequency was 2480MHz.so radiated emission test frequency band from 9KHz to 25GHz.

Field Strength Calculation

The field strength is calculated by adding the Antenna Factor and Cable Factor and subtracting the Amplifier Gain and Duty Cycle Correction Factor(if any) from the measured reading. The basic equation with a sample calculation is as follows:

$$FS = RA + AF + CL - AG$$

Where FS = Field Strength	CL = Cable Attenuation Factor (Cable Loss)
RA = Reading Amplitude	AG = Amplifier Gain
AF = Antenna Factor	

For example

Frequency (MHz)	FS (dB μ V/m)	RA (dB μ V/m)	AF (dB)	CL (dB)	AG (dB)	Transd (dB)
300.00	40	58.1	12.2	1.6	31.90	-18.1

$$\text{Transd} = \text{AF} + \text{CL} - \text{AG}$$

RADIATION LIMIT

For intentional device, according to § 15.209(a), the general requirement of field strength of radiated emission from intentional radiators at a distance of 3 meters shall not exceed the following table. According to § 15.247(d), in any 100kHz bandwidth outside the frequency band in which the EUT is operating, the radio frequency power that is produced by the intentional radiator shall be at least 20dB below that in the 100kHz bandwidth within the band that contains the highest level of desired power.

The frequency spectrum above 1 GHz for Transmitter was investigated. All emission not reported are much lower than the prescribed limits. Set the RBW=1MHz,VBW=3MHz for Peak Detector while the RBW=1MHz,VBW=10Hz for Average Detector,Readings are both peak and average values. The pre-test have done for the EUT in three axes and found the worst emission at position shown in test setup photos.

Frequency (MHz)	Distance (Meters)	Radiated (dB μ V/m)	Radiated (μ V/m)
0.009-0.49	3	$20\log(2400/F(\text{KHz}))+40\log(300/3)$	$2400/F(\text{KHz})$
0.49-1.705	3	$20\log(24000/F(\text{KHz}))+40\log(30/3)$	$24000/F(\text{KHz})$
1.705-30	3	$20\log(30)+40\log(30/3)$	30
30-88	3	40.0	100
88-216	3	43.5	150
216-960	3	46.0	200
Above 960	3	54.0	500

TEST RESULTS

Remark: 1. We tested three positions and recorded worst case.

For 9KHz to 30MHz

Frequency (MHz)	Corrected Reading (dBµV/m)@3m	FCC Limit (dBµV/m) @3m	Margin (dB)	Detector	Result
0.44	57.35	94.74	37.39	QP	PASS
1.75	49.35	69.54	20.19	QP	PASS
20.24	57.02	69.54	12.52	QP	PASS
25.59	55.39	69.54	14.15	QP	PASS

For 30MHz to 1000MHz

SWEEP TABLE: "test (30M-1G)"

```

Short Description:      Field Strength
Start      Stop      Detector  Meas.   IF      Transducer
Frequency  Frequency
30.0 MHz   1.0 GHz   MaxPeak  Coupled 100 kHz  VULB9163
    
```

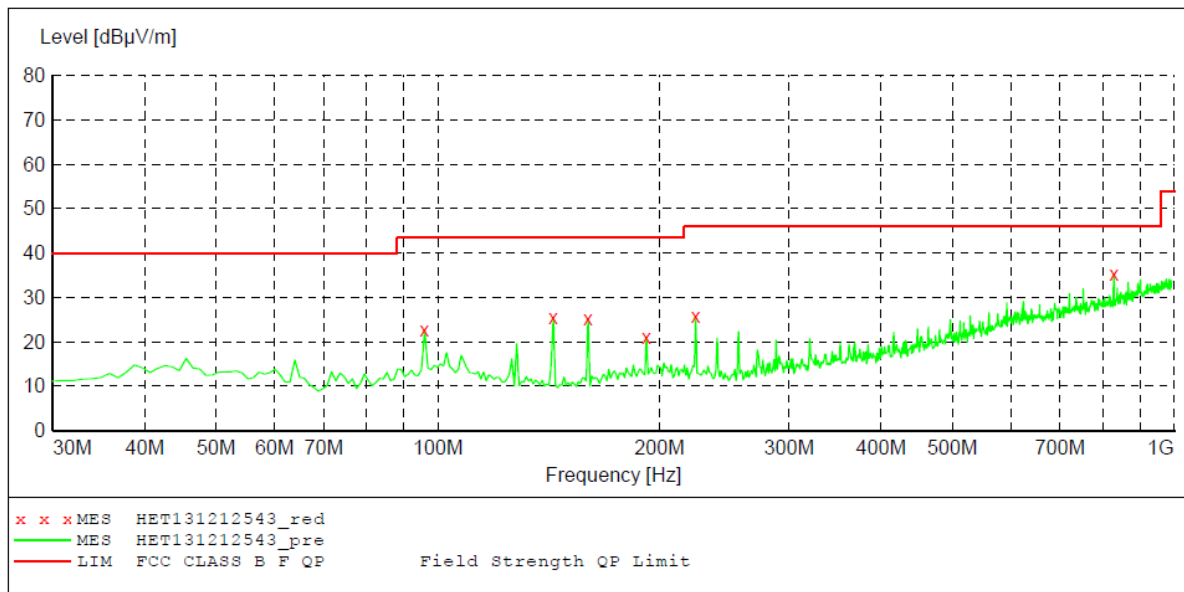

MEASUREMENT RESULT: "HET131212543_red"

12/12/2013 6:20PM

Frequency MHz	Level dBµV/m	Transd dB	Limit dBµV/m	Margin dB	Det.	Height cm	Azimuth deg	Polarization
95.960000	22.60	-14.2	43.5	20.9	PK	100.0	325.00	HORIZONTAL
143.490000	25.50	-18.4	43.5	18.0	PK	100.0	58.00	HORIZONTAL
159.980000	25.30	-17.5	43.5	14.7	PK	100.0	58.00	HORIZONTAL
191.990000	21.10	-14.7	43.5	18.9	PK	100.0	204.00	HORIZONTAL
224.000000	25.70	-15.1	46.0	20.3	PK	100.0	83.00	HORIZONTAL
828.310000	35.30	0.8	46.0	10.7	PK	100.0	252.00	HORIZONTAL

SWEEP TABLE: "test (30M-1G)"

Short Description: Field Strength
 Start Stop Detector Meas. IF Transducer
 Frequency Frequency Time Bandw.
 30.0 MHz 1.0 GHz MaxPeak Coupled 100 kHz VULB9163

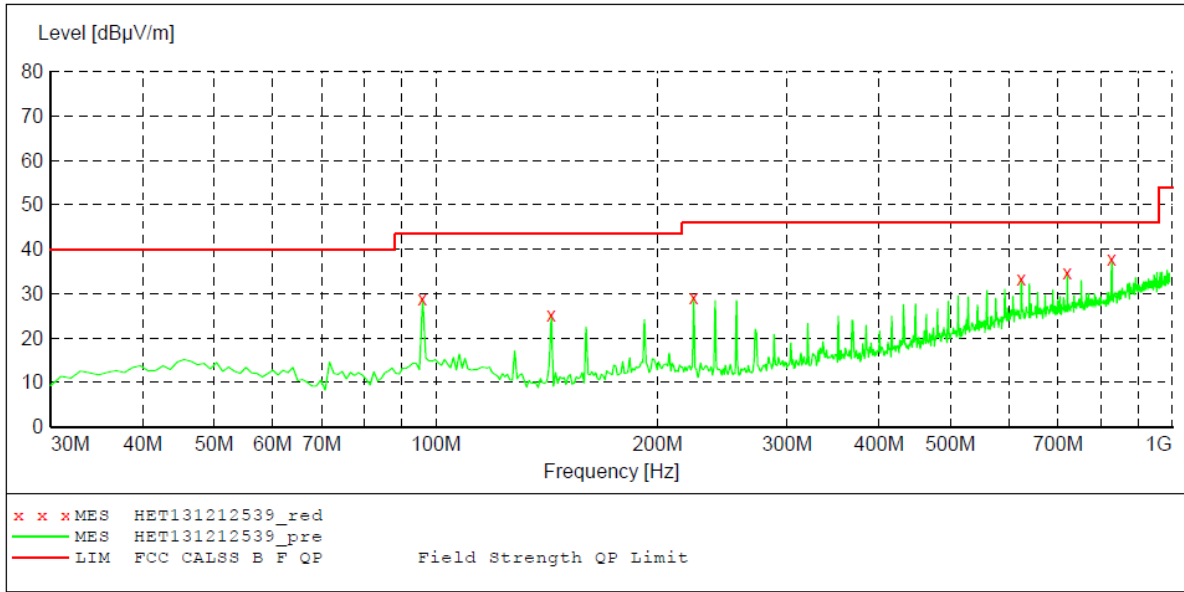

MEASUREMENT RESULT: "HET131212539_red"

12/12/2013 5:45PM

Frequency MHz	Level dBuV/m	Transd dB	Limit dBuV/m	Margin dB	Det.	Height cm	Azimuth deg	Polarization
95.960000	28.80	-14.2	43.5	14.7	PK	100.0	294.00	VERTICAL
143.490000	25.20	-18.4	43.5	18.3	PK	100.0	59.00	VERTICAL
224.000000	29.30	-15.1	46.0	16.7	PK	100.0	84.00	VERTICAL
624.610000	33.30	-2.6	46.0	12.7	PK	100.0	341.00	VERTICAL
720.640000	34.70	-1.2	46.0	11.3	PK	100.0	272.00	VERTICAL
827.340000	37.70	0.8	46.0	8.3	PK	100.0	13.00	VERTICAL

For 1GHz to 25GHz

Low Channel @ Channel 00 @ 2402 MHz

ANTENNA POLARITY & TEST DISTANCE: HORIZONTAL AT 3 M												
No.	Frequency (MHz)	Emission Level (dBuV/m)		Limit (dBuV/m)	Margin (dB)	Antenna Height (m)	Table Angle (Degree)	Raw Value (dBuV)	Antenna Factor (dB/m)	Cable Factor (dB)	Pre-amplifier	Correction Factor (dB/m)
1	4804.00	54.35	PK	74.00	19.65	1.00 H	155	52.27	31.58	7.00	36.5	2.08
2	4804.00	37.34	AV	54.00	16.66	1.00 H	155	35.26	31.58	7.00	36.5	2.08
3	7206.00	36.72	PK	74.00	37.28	1.00 H	126	26.06	37.06	8.90	35.3	10.66

ANTENNA POLARITY & TEST DISTANCE: VERTICAL AT 3 M												
No.	Frequency (MHz)	Emission Level (dBuV/m)		Limit (dBuV/m)	Margin (dB)	Antenna Height (m)	Table Angle (Degree)	Raw Value (dBuV)	Antenna Factor (dB/m)	Cable Factor (dB)	Pre-amplifier	Correction Factor (dB/m)
1	4804.00	55.38	PK	74.00	18.62	1.00 V	135	53.30	31.58	7.00	36.5	2.08
2	4804.00	38.49	AV	54.00	15.51	1.00 V	135	36.41	31.58	7.00	36.5	2.08
3	7206.00	35.67	PK	74.00	38.33	1.00 V	125	25.01	37.06	8.90	35.3	10.66

Middle Channel @ Channel 39 @ 2440 MHz

ANTENNA POLARITY & TEST DISTANCE: HORIZONTAL AT 3 M												
No.	Frequency (MHz)	Emission Level (dBuV/m)		Limit (dBuV/m)	Margin (dB)	Antenna Height (m)	Table Angle (Degree)	Raw Value (dBuV)	Antenna Factor (dB/m)	Cable Factor (dB)	Pre-amplifier	Correction Factor (dB/m)
1	4880.00	54.68	PK	74.00	19.32	1.00 H	78	52.54	31.04	7.60	36.5	2.14
2	4880.00	37.34	AV	54.00	16.66	1.00 H	78	35.20	31.04	7.60	36.5	2.14
3	7320.00	41.86	PK	74.00	32.14	1.00 H	158	30.72	37.84	8.60	35.3	11.14

ANTENNA POLARITY & TEST DISTANCE: VERTICAL AT 3 M												
No.	Frequency (MHz)	Emission Level (dBuV/m)		Limit (dBuV/m)	Margin (dB)	Antenna Height (m)	Table Angle (Degree)	Raw Value (dBuV)	Antenna Factor (dB/m)	Cable Factor (dB)	Pre-amplifier	Correction Factor (dB/m)
1	4880.00	54.23	PK	74.00	19.77	1.00 V	94	52.09	31.04	7.60	36.5	2.14
2	4880.00	37.67	AV	54.00	16.33	1.00 V	94	35.53	31.04	7.60	36.5	2.14
3	7320.00	38.36	PK	74.00	35.64	1.00 V	155	27.22	37.84	8.60	35.3	11.14

High Channel @ Channel 78 @ 2480 MHz

ANTENNA POLARITY & TEST DISTANCE: HORIZONTAL AT 3 M												
No.	Frequency (MHz)	Emission Level (dBuV/m)		Limit (dBuV/m)	Margin (dB)	Antenna Height (m)	Table Angle (Degree)	Raw Value (dBuV)	Antenna Factor (dB/m)	Cable Factor (dB)	Pre-amplifier	Correction Factor (dB/m)
1	4960.00	55.67	PK	74.00	18.33	1.00 H	235	53.24	31.63	7.00	36.2	2.43
2	4960.00	37.68	AV	54.00	16.32	1.00 H	235	35.25	31.63	7.00	36.2	2.43
3	7340.00	38.49	PK	74.00	35.51	1.00 H	187	26.89	38.40	8.50	35.3	11.60

ANTENNA POLARITY & TEST DISTANCE: VERTICAL AT 3 M												
No.	Frequency (MHz)	Emission Level (dBuV/m)		Limit (dBuV/m)	Margin (dB)	Antenna Height (m)	Table Angle (Degree)	Raw Value (dBuV)	Antenna Factor (dB/m)	Cable Factor (dB)	Pre-amplifier	Correction Factor (dB/m)
1	4960.00	54.79	PK	74.00	19.21	1.00 V	155	52.36	31.63	7.00	-36.2	2.43
2	4960.00	38.16	AV	54.00	15.84	1.00 V	155	35.73	31.63	7.00	-36.2	2.43
3	7340.00	39.72	PK	74.00	34.28	1.00 V	30	28.12	38.40	8.50	-35.3	11.60

- REMARKS:**
1. Emission level (dBuV/m) = Raw Value (dBuV) + Correction Factor (dB/m)
 2. Correction Factor (dB/m) = Antenna Factor (dB/m) + Cable Factor (dB) - Pre-amplifier Factor
 3. The other emission levels were very low against the limit.
 4. Margin value = Limit value - Emission level.
 5. The average measurement was not performed when the peak measured data under the limit of average detection.

4.3. Maximum Peak Output Power

TEST CONFIGURATION

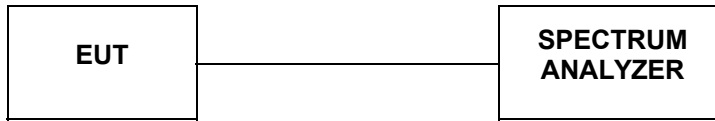

TEST PROCEDURE

Remove the antenna from the EUT and then connect a low loss RF cable from the antenna port to the spectrum.

LIMIT

The Maximum Peak Output Power Measurement is 30dBm.

TEST RESULTS

A. Test Verdict

Channel	Frequency (MHz)	Measured Output Peak Power (dBm)	Refer to Plot	Limits (dBm)	Verdict
00	2402	-5.88	Plot 4.3.1	30	PASS
39	2441	-6.28	Plot 4.3.1	30	PASS
78	2480	-7.72	Plot 4.3.1	30	PASS

Note: 1.The test results including the cable lose.

B. Test Plots

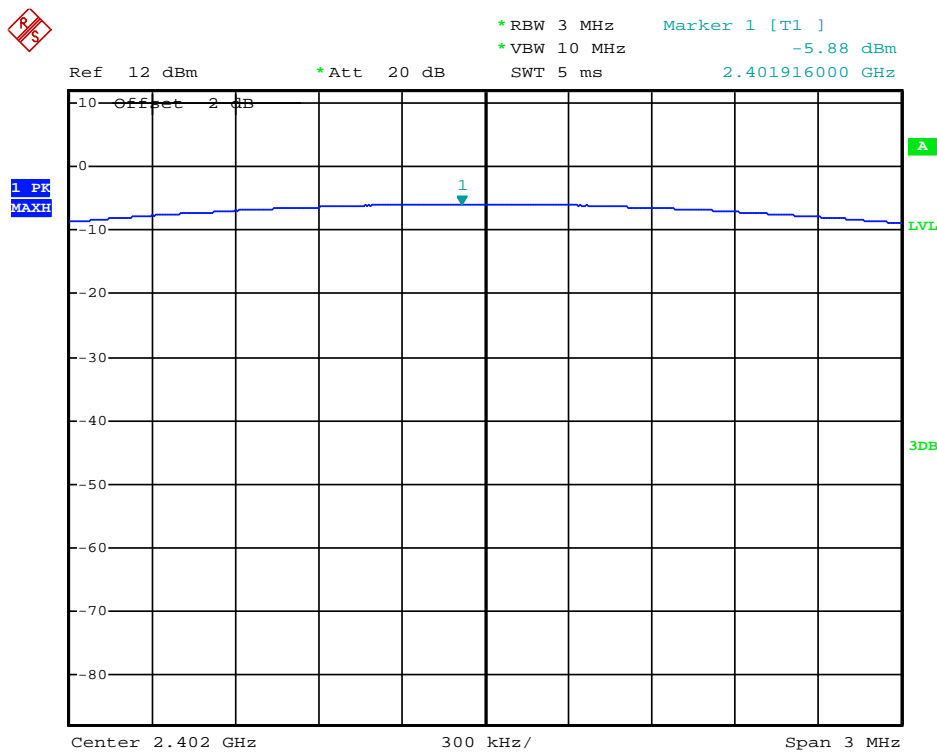

Date: 10.DEC.2013 14:58:51

(Plot 4.3.1: Channel 00: 2402MHz)



*RBW 3 MHz Marker 1 [T1]
*VBW 10 MHz -6.28 dBm
SWT 5 ms 2.440282000 GHz

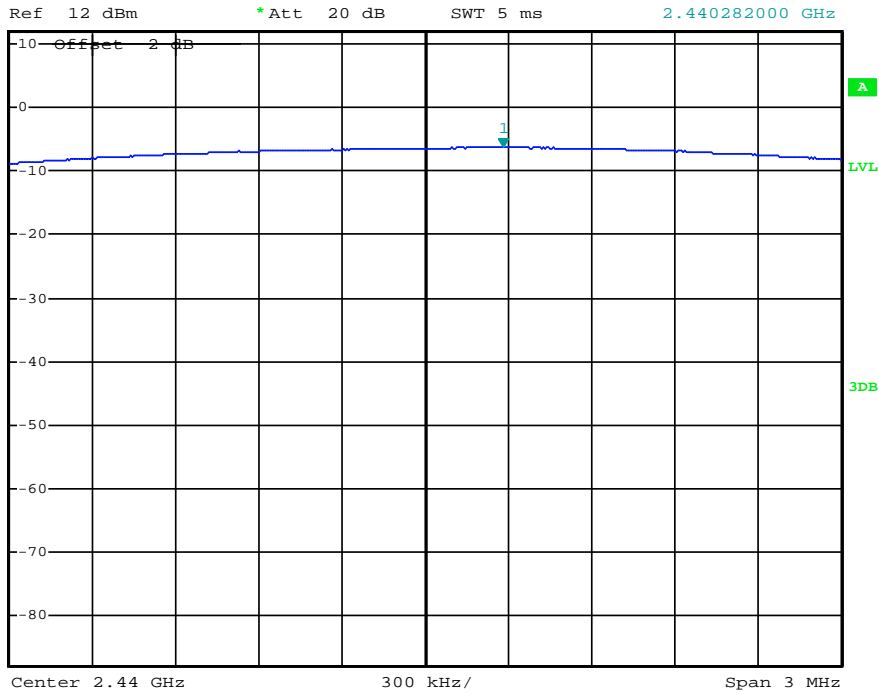

Date: 10.DEC.2013 15:00:29

(Plot 4.3.2: Channel 19: 2440MHz)



*RBW 3 MHz Marker 1 [T1]
*VBW 10 MHz -7.72 dBm
SWT 5 ms 2.479706000 GHz

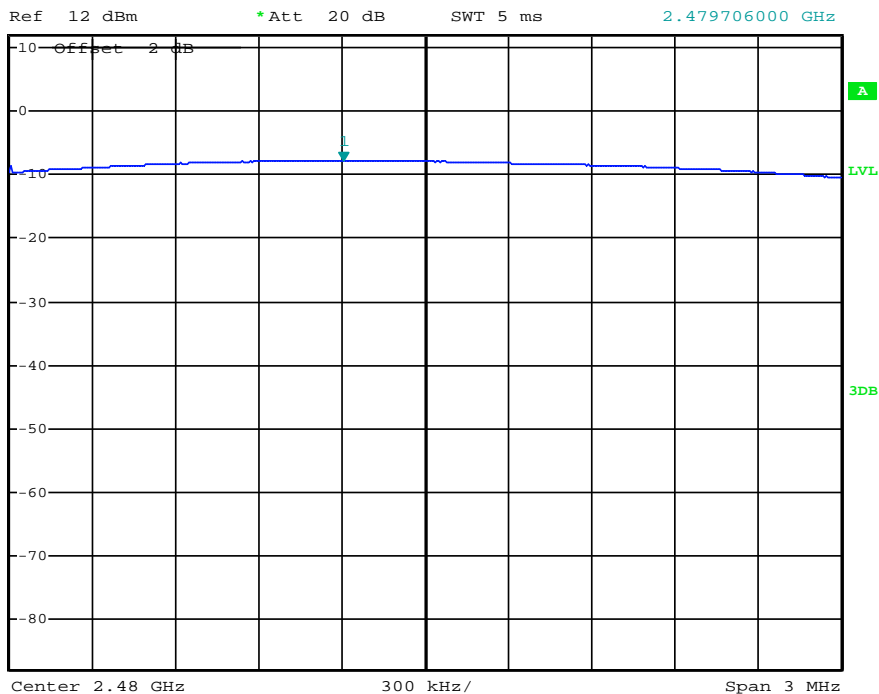

Date: 10.DEC.2013 15:02:03

(Plot 4.3.3: Channel 39: 2480MHz)

4.4. Power Spectral Density

TEST CONFIGURATION

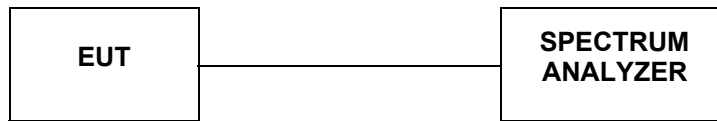

TEST PROCEDURE

1. Use this procedure when the maximum peak conducted output power in the fundamental emission is used to demonstrate compliance.
2. Set the RBW ≥ 3 kHz.
3. Set the VBW $\geq 3 \times$ RBW.
4. Set the span to 1.5 times the DTS channel bandwidth.
5. Detector = peak.
6. Sweep time = auto couple.
7. Trace mode = max hold.
8. Allow trace to fully stabilize.
9. Use the peak marker function to determine the maximum power level.
10. If measured value exceeds limit, reduce RBW (no less than 3 kHz) and repeat.
11. The resulting peak PSD level must be ≤ 8 dBm.

LIMIT

For digitally modulated systems, the power spectral density conducted from the intentional radiator to the antenna shall not be greater than 8 dBm in any 3 kHz band during any time interval of continuous transmission.

TEST RESULTS

A. Test Verdict

Channel	Frequency (MHz)	Report PSD (dBm/3kHz)	Refer to Plot	Limits (dBm/3KHz)	Verdict
00	2402	-18.93	Plot 4.4.1	8	PASS
19	2440	-19.47	Plot 4.4.2	8	PASS
39	2480	-21.30	Plot 4.4.3	8	PASS

B. Test Plots



*RBW 3 kHz Marker 1 [T1]
*VBW 10 kHz -18.93 dBm
SWT 105 ms 2.402007272 GHz

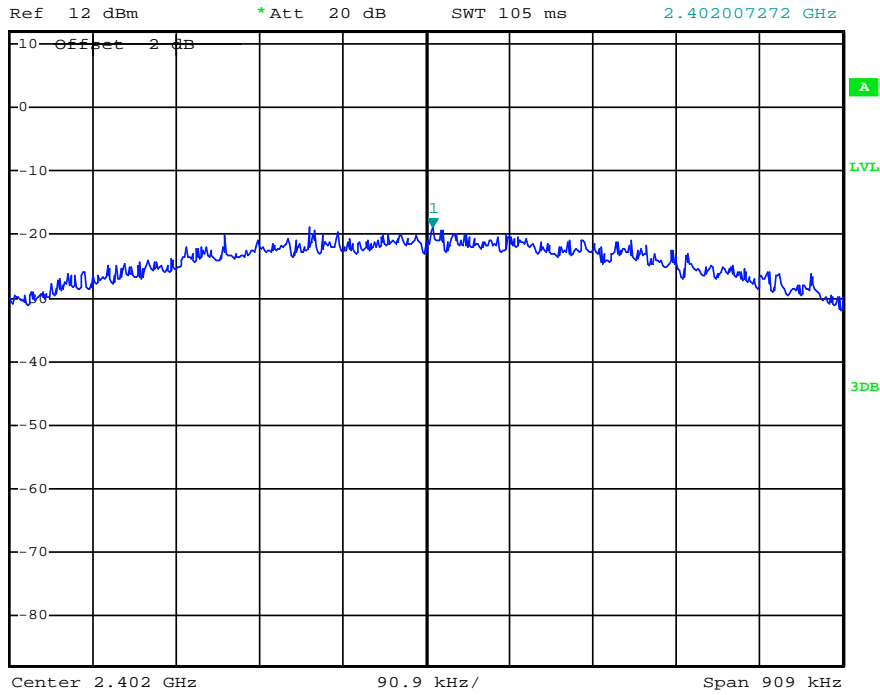

Date: 13.DEC.2013 09:39:32

(Plot 4.4.1 : Channel 00: 2402MHz)



*RBW 3 kHz Marker 1 [T1]
*VBW 10 kHz -19.47 dBm
SWT 105 ms 2.440065448 GHz

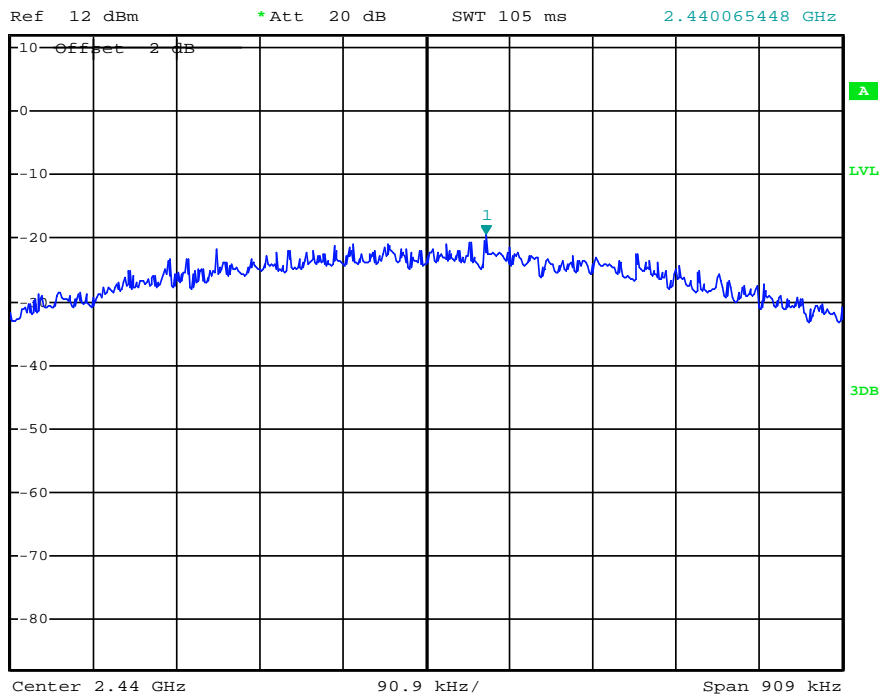

Date: 13.DEC.2013 09:40:40

(Plot 4.4.2 : Channel 19: 2440MHz)



*RBW 3 kHz Marker 1 [T1]
*VBW 10 kHz -21.30 dBm
SWT 105 ms 2.480074538 GHz

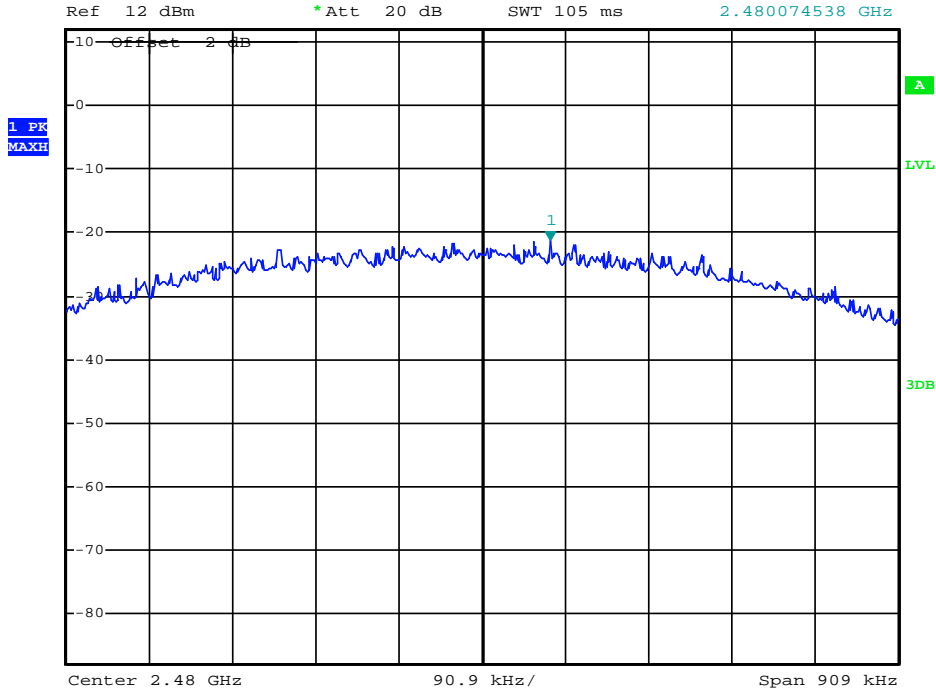

Date: 13.DEC.2013 09:40:10

(Plot 4.4.3 : Channel 39: 2480MHz)

4.5. 6dB Bandwidth

TEST CONFIGURATION

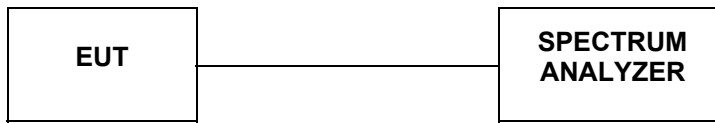

TEST PROCEDURE

The transmitter output was connected to the spectrum analyzer through an attenuator. The bandwidth of the fundamental frequency was measured by spectrum analyzer with RBW=100KHz and VBW=300KHz. The 6dB bandwidth is defined as the total spectrum the power of which is higher than peak power minus 6dB.

LIMIT

For digital modulation systems, the minimum 6 dB bandwidth shall be at least 500 kHz

TEST RESULTS

A. Test Verdict

Channel	Frequency (MHz)	6 dB Bandwidth (MHz)	Refer to Plot	Limits (kHz)	Verdict
00	2402	0.6060	Plot 4.5.1	≥500	PASS
19	2440	0.6060	Plot 4.5.2	≥500	PASS
39	2480	0.6060	Plot 4.5.3	≥500	PASS

Note: 1.The test results including the cable lose.

B. Test Plots

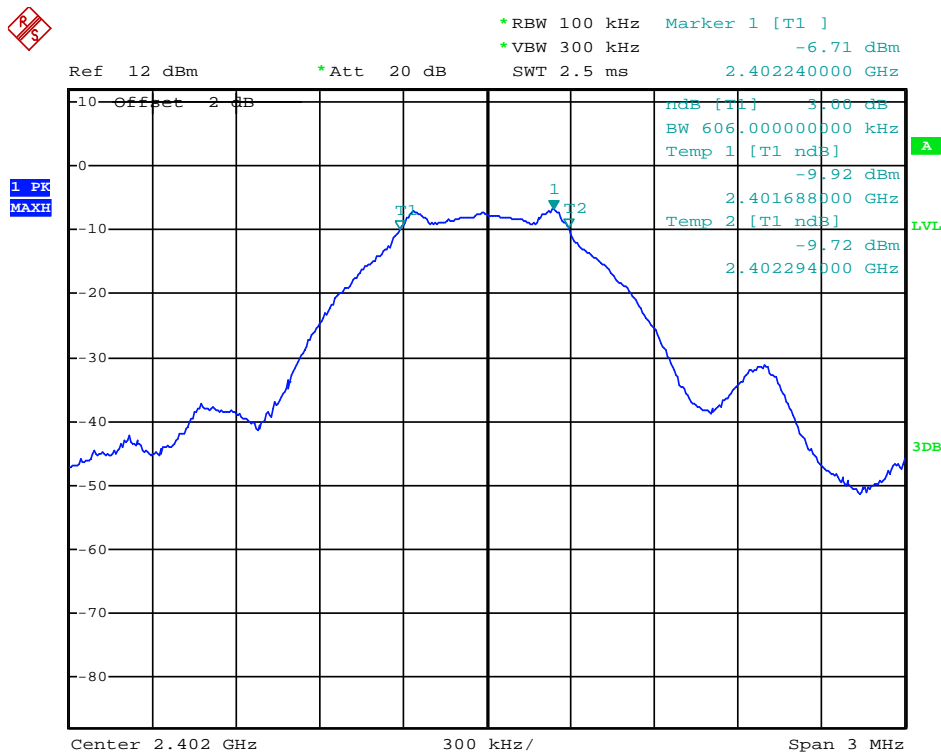

Date: 13.DEC.2013 09:36:38

(Plot 4.5.1: Channel 00: 2402MHz)



*RBW 100 kHz Marker 1 [T1]
*VBW 300 kHz -7.99 dBm
Ref 12 dBm *Att 20 dB SWT 2.5 ms 2.440246000 GHz

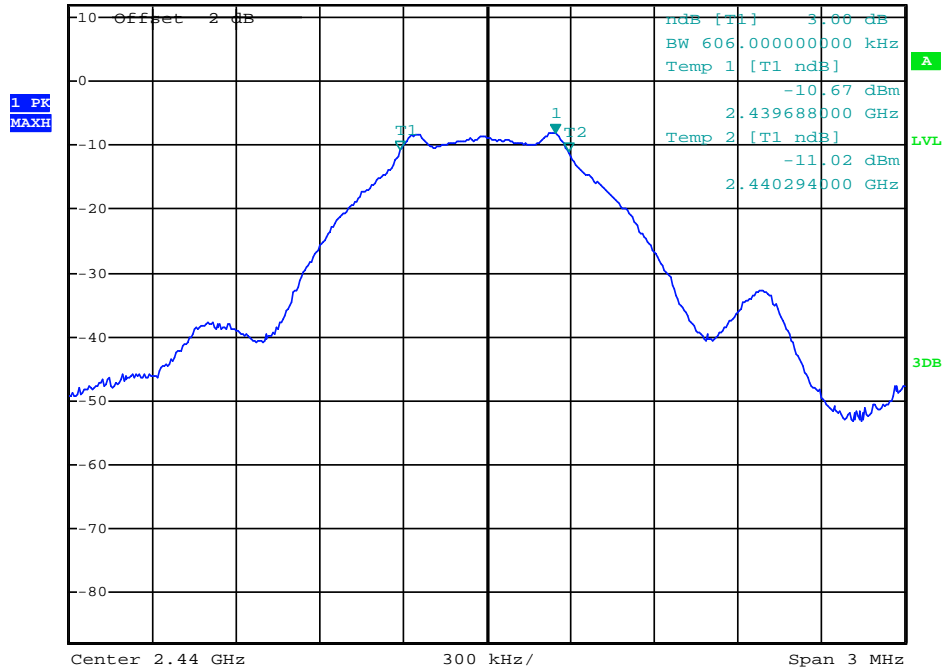

Date: 13.DEC.2013 09:35:17

(Plot 4.5.2: Channel 19: 2440MHz)



MARKER 1
2.479736 GHz
*RBW 100 kHz Marker 1 [T1]
*VBW 300 kHz -9.32 dBm
Ref 12 dBm *Att 20 dB SWT 2.5 ms 2.479736000 GHz

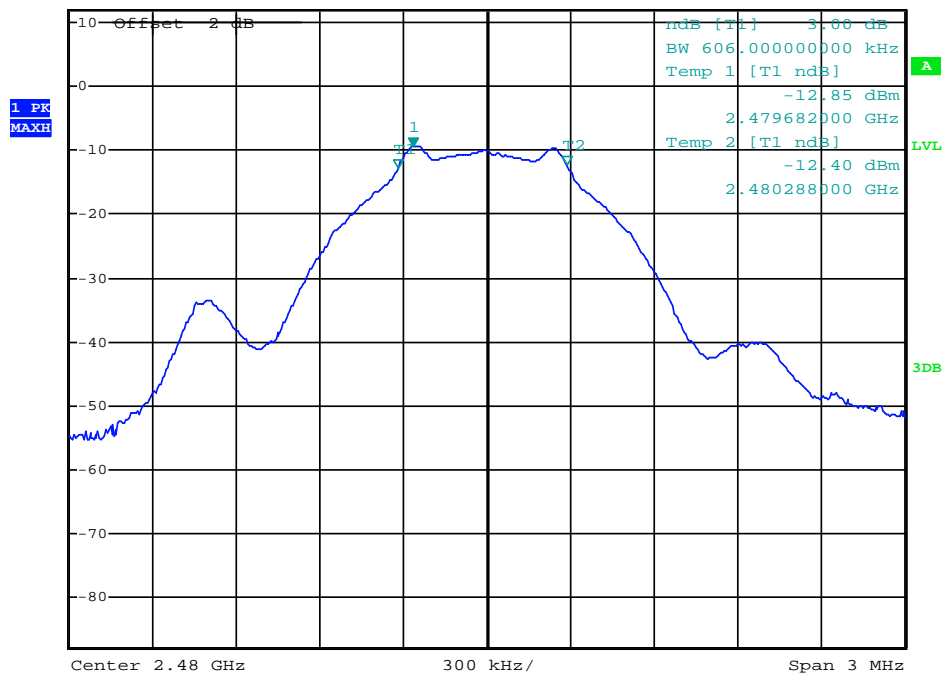

Date: 13.DEC.2013 09:34:27

(Plot 4.5.3: Channel 39: 2480MHz)

4.6. Band Edge Compliance of RF Emission

TEST REQUIREMENT

In any 100 kHz bandwidth outside the frequency band in which the spread spectrum or digitally modulated intentional radiator is operating, the radio frequency power that is produced by the intentional radiator shall be at least 20 dB below that in the 100 kHz bandwidth within the band that contains the highest level of the desired power, based on either an RF conducted or a radiated measurement, provided the transmitter demonstrates compliance with the peak conducted power limits. If the transmitter complies with the conducted power limits based on the use of RMS averaging over a time interval, as permitted under paragraph (b)(3) of this section, the attenuation required under this paragraph shall be 30 dB instead of 20 dB. Attenuation below the general limits specified in §15.209(a) is not required. In addition, radiated emissions which fall in the restricted bands, as defined in §15.205(a), must also comply with the radiated emission limits specified in §15.209(a) (see §15.205(c)).

TEST PROCEDURE

According to KDB 558074 D01 V03 for Antenna-port conducted measurement. Antenna-port conducted measurements may also be used as an alternative to radiated measurements for demonstrating compliance in the restricted frequency bands. If conducted measurements are performed, then proper impedance matching must be ensured and an additional radiated test for cabinet/case spurious emissions is required.

1. Check the calibration of the measuring instrument using either an internal calibrator or a known signal from an external generator.
2. Remove the antenna from the EUT and then connect to a low loss RF cable from the antenna port to a EMI test receiver, then turn on the EUT and make it operate in transmitting mode. Then set it to Low Channel and High Channel within its operating range, and make sure the instrument is operated in its linear range.
3. Set both RBW and VBW of spectrum analyzer to 100 kHz with a convenient frequency span including 100kHz bandwidth from band edge, for Radiated emissions restricted band RBW=1MHz, VBW=3MHz for peak detector and RBW=1MHz, VBW=10Hz for average detector.
4. Measure the highest amplitude appearing on spectral display and set it as a reference level. Plot the graph with marking the highest point and edge frequency.
5. Repeat above procedures until all measured frequencies were complete.
6. Measure the conducted output power (in dBm) using the detector specified by the appropriate regulatory agency (see 12.2.2, 12.2.3, and 12.2.4 for guidance regarding measurement procedures for determining quasi-peak, peak, and average conducted output power, respectively).
7. Add the maximum transmit antenna gain (in dBi) to the measured output power level to determine the EIRP level (see 12.2.5 for guidance on determining the applicable antenna gain)
8. Add the appropriate maximum ground reflection factor to the EIRP level (6 dB for frequencies ≤ 30 MHz, 4.7 dB for frequencies between 30 MHz and 1000 MHz, inclusive and 0 dB for frequencies > 1000 MHz).
9. For devices with multiple antenna-ports, measure the power of each individual chain and sum the EIRP of all chains in linear terms (e.g., Watts, mW).
10. Convert the resultant EIRP level to an equivalent electric field strength using the following relationship:
$$E = \text{EIRP} - 20\log D + 104.8$$

where:

E = electric field strength in dB μ V/m,

EIRP = equivalent isotropic radiated power in dBm

D = specified measurement distance in meters.

11. Compare the resultant electric field strength level to the applicable regulatory limit.
12. Perform radiated spurious emission test

LIMIT

Below -20dB of the highest emission level in operating band.

Radiated emissions which fall in the restricted bands, as defined in § 15.205(a), must also comply with the radiated emission limits specified in § 15.209(a)

TEST RESULTS

A. Test Verdict

Frequency (MHz)	Conducted Power (dBm)	Antenna Gain (dBi)	Ground reflection factor(dBi)	Covert Radiated E Level At 3m (dBuV/m)	Refer to Plot	Detector	Limit (dBuV/m)
2390.00	-59.02	2.00	0	38.24	Plot 4.6.1	PK	74.00
2390.00	-70.04	2.00	0	27.22	Plot 4.6.2	AV	54.00
2483.50	-45.18	2.00	0	52.08	Plot 4.6.3	PK	74.00
2483.50	-49.60	2.00	0	47.66	Plot 4.6.4	AV	54.00

B. Test Plots

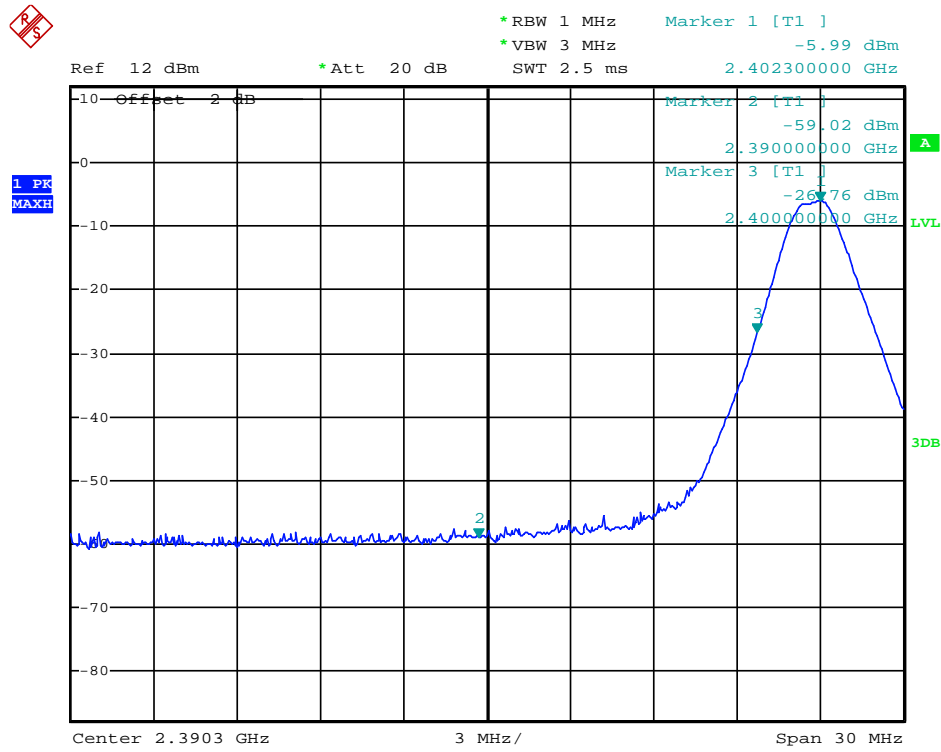

Date: 13.DEC.2013 09:50:53

(Plot 4.6.1 : Channel 00: 2402MHz)

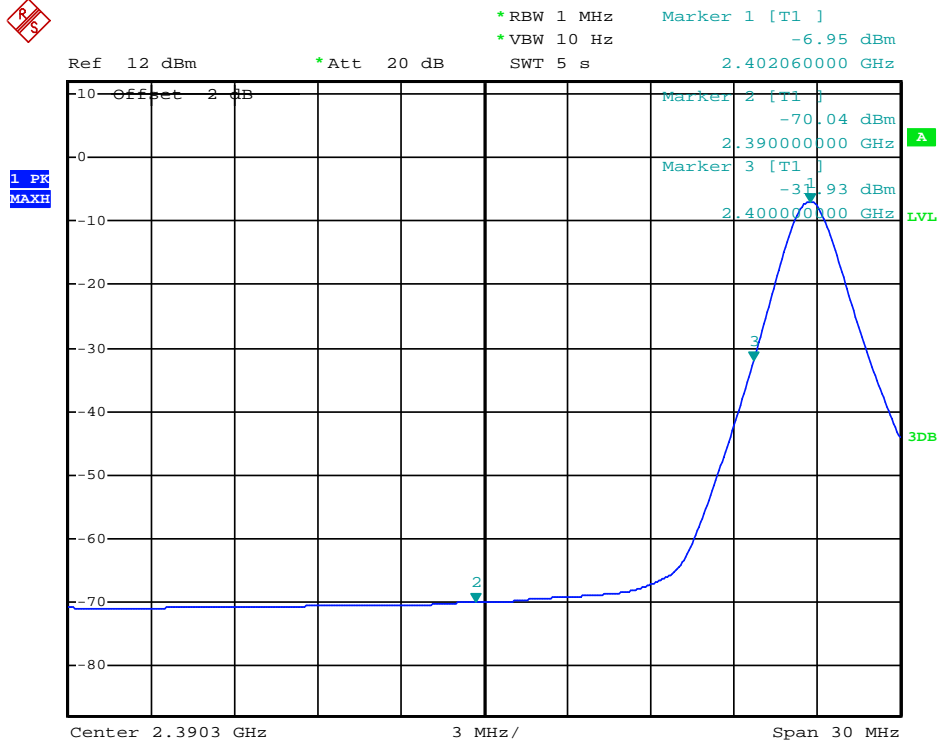

Date: 13.DEC.2013 09:51:13

(Plot 4.6.2 : Channel 00: 2402MHz)

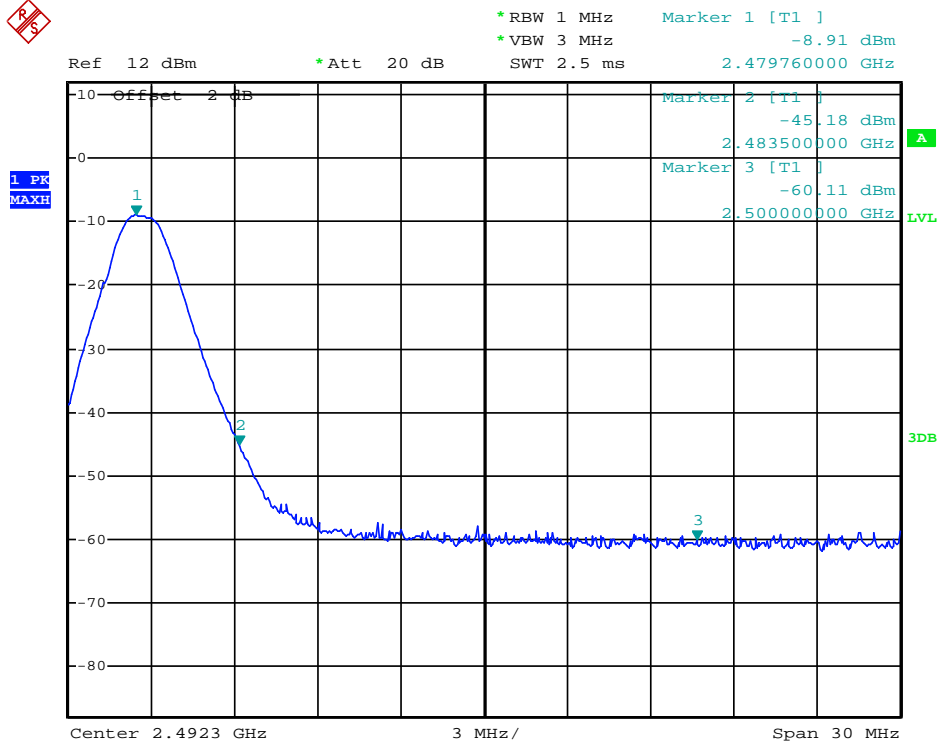

Date: 13.DEC.2013 09:52:25

(Plot 4.6.3 : Channel 39: 2480MHz)



*RBW 1 MHz Marker 1 [T1]
*VBW 10 Hz -9.93 dBm
SWT 5 s 2.480000000 GHz

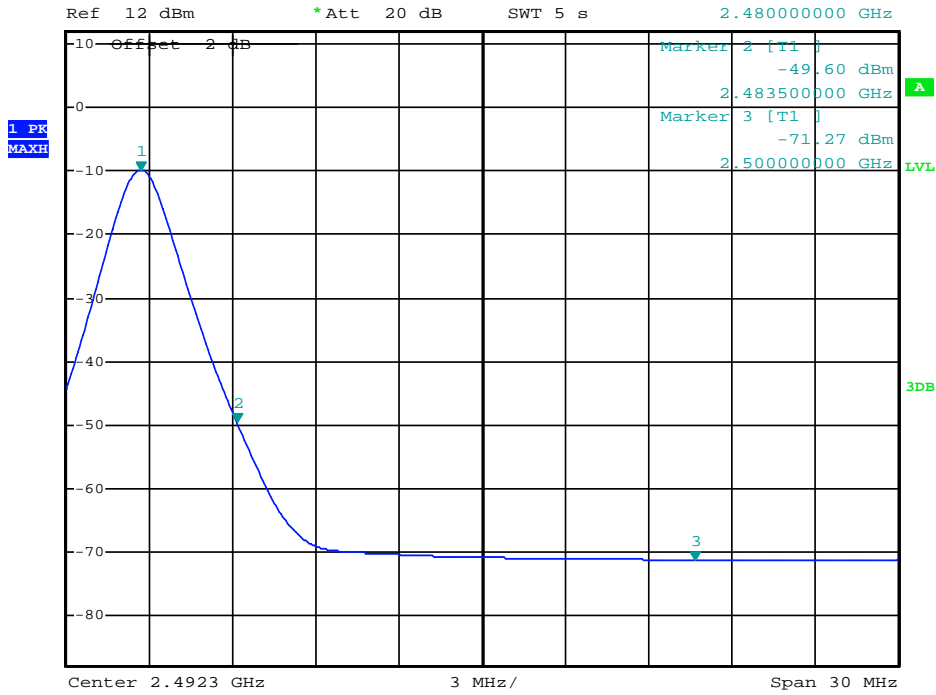

Date: 13.DEC.2013 09:52:49

(Plot 4.6.4 : Channel 39: 2480MHz)

4.7. Spurious RF Conducted Emission

TEST CONFIGURATION

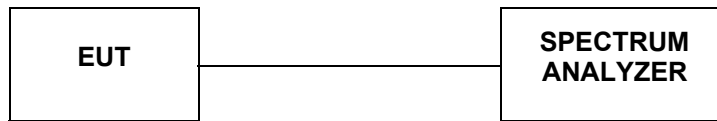

TEST PROCEDURE

The Spurious RF conducted emissions compliance of RF radiated emission should be measured by following the guidance in ANSI C63.10-2009 with respect to maximizing the emission by rotating the EUT, measuring the emission while the EUT is situated in three orthogonal planes (if appropriate), adjusting the measurement antenna height and polarization etc. Set RBW=100kHz and VBM= 300kHz to measure the peak field strength, and measure frequency range from 30MHz to 26.5GHz.

LIMIT

1. Below -20dB of the highest emission level in operating band.
2. Fall in the restricted bands listed in section 15.205. The maximum permitted average field strength is listed in section 15.209.

TEST RESULTS

Remark: The measurement frequency range is from 30MHz to the 10th harmonic of the fundamental frequency. The lowest, middle and highest channels are tested to verify the spurious emissions and band edge measurement data.

A. Test Verdict

Channel	Frequency (MHz)	Frequency Range	Refer to Plot	Limit (dBc)	Verdict
00	2402	30MHz-3GHz	Plot 4.7 A1	20	PASS
		3GHz-15GHz	Plot 4.7 A2	20	PASS
		15GHz-25GHz	Plot 4.7 A3	20	PASS
19	2440	30MHz-3GHz	Plot 4.7 B1	20	PASS
		3GHz-15GHz	Plot 4.7 B2	20	PASS
		15GHz-25GHz	Plot 4.7 B3	20	PASS
39	2480	30MHz-3GHz	Plot 4.7 C1	20	PASS
		3GHz-15GHz	Plot 4.7 C2	20	PASS
		15GHz-25GHz	Plot 4.7 C3	20	PASS

Frequency (MHz)	Delta Peak to Band emission (dBc)	Detector	Limit (dBc)	Refer to Plot	Verdict
2399.30	40.18	Peak	20	Plot 4.7 D	PASS
2483.50	47.61	Peak	20	Plot 4.7 E	PASS

B. Test Plots



*RBW 100 kHz Marker 1 [T1]
*VBW 300 kHz -7.15 dBm
Ref 12 dBm *Att 20 dB SWT 300 ms 2.406000000 GHz

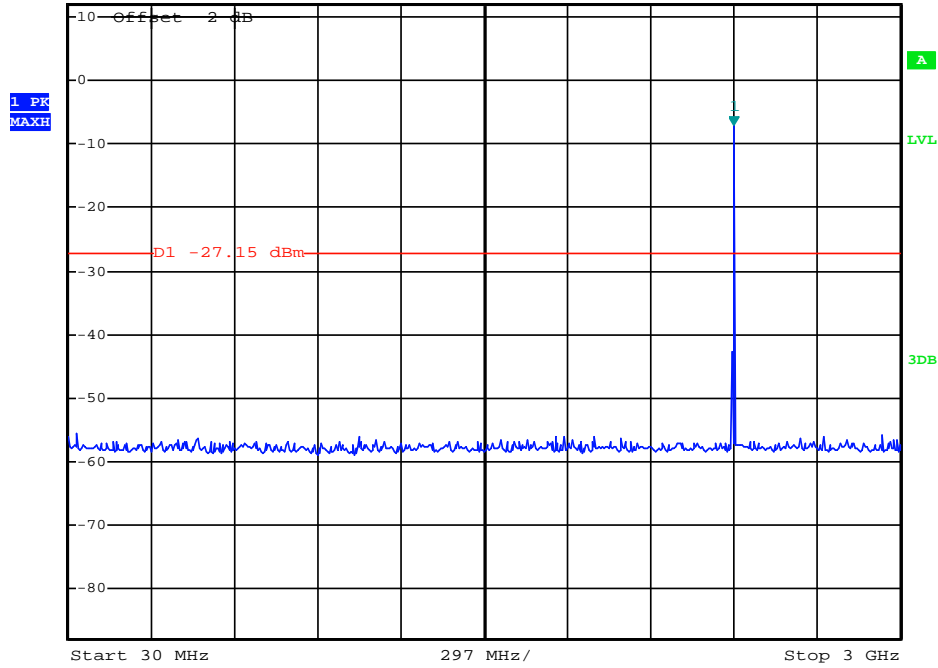

Date: 13.DEC.2013 09:44:26

(Plot 4.7 A1: Channel 00: 2402MHz)



*RBW 100 kHz Marker 1 [T1]
*VBW 300 kHz -53.72 dBm
Ref 12 dBm *Att 20 dB SWT 1.2 s 13.968000000 GHz

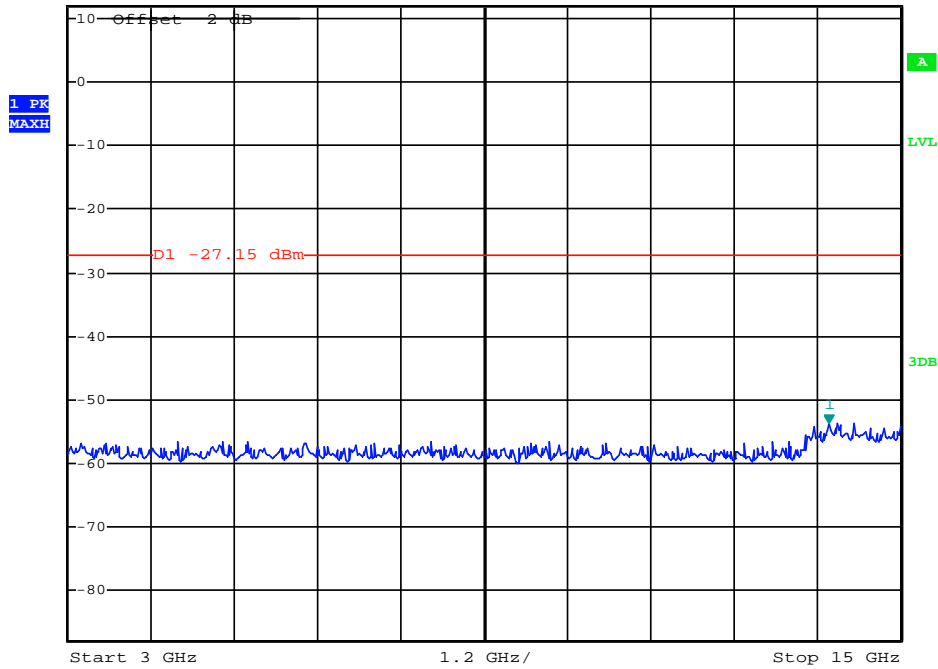

Date: 13.DEC.2013 09:44:52

(Plot 4.7 A2: Channel 00: 2402MHz)



*RBW 100 kHz Marker 1 [T1]
*VBW 300 kHz -52.23 dBm
Ref 12 dBm *Att 20 dB SWT 1 s 19.82000000 GHz

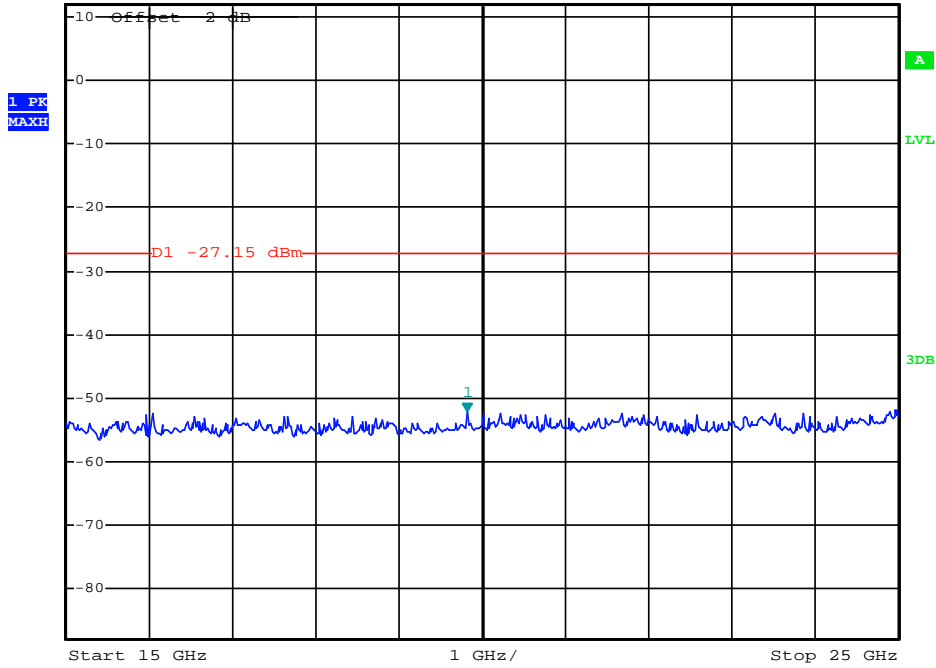

Date: 13.DEC.2013 09:45:09

(Plot 4.7 A3: Channel 00: 2402MHz)



*RBW 100 kHz Marker 1 [T1]
*VBW 300 kHz -8.14 dBm
Ref 12 dBm *Att 20 dB SWT 300 ms 2.441640000 GHz

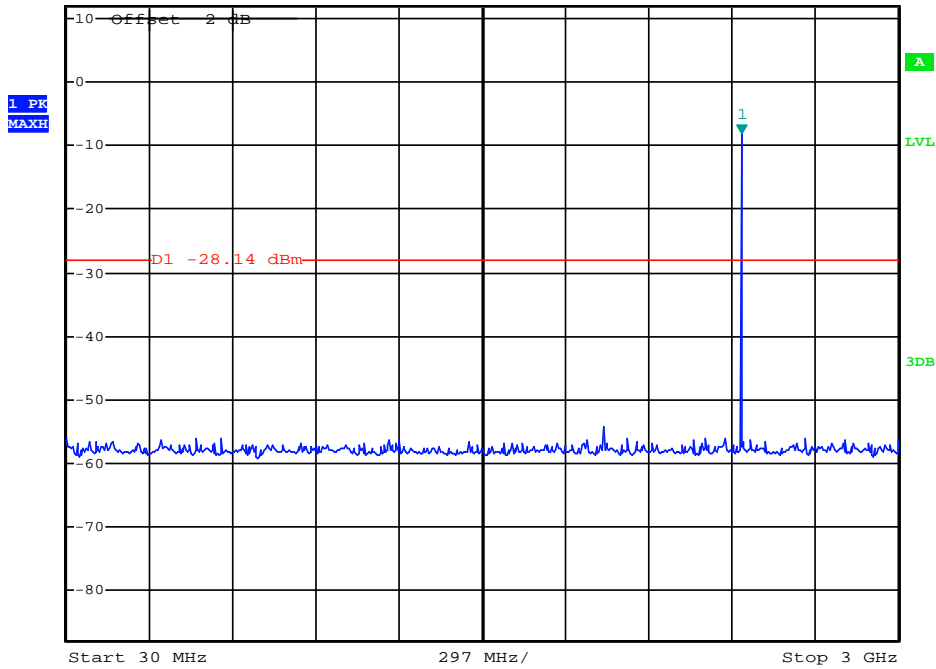

Date: 13.DEC.2013 09:42:23

(Plot 4.7 B1: Channel 19: 2440MHz)



*RBW 100 kHz Marker 1 [T1]
*VBW 300 kHz -53.42 dBm
SWT 1.2 s 14.232000000 GHz

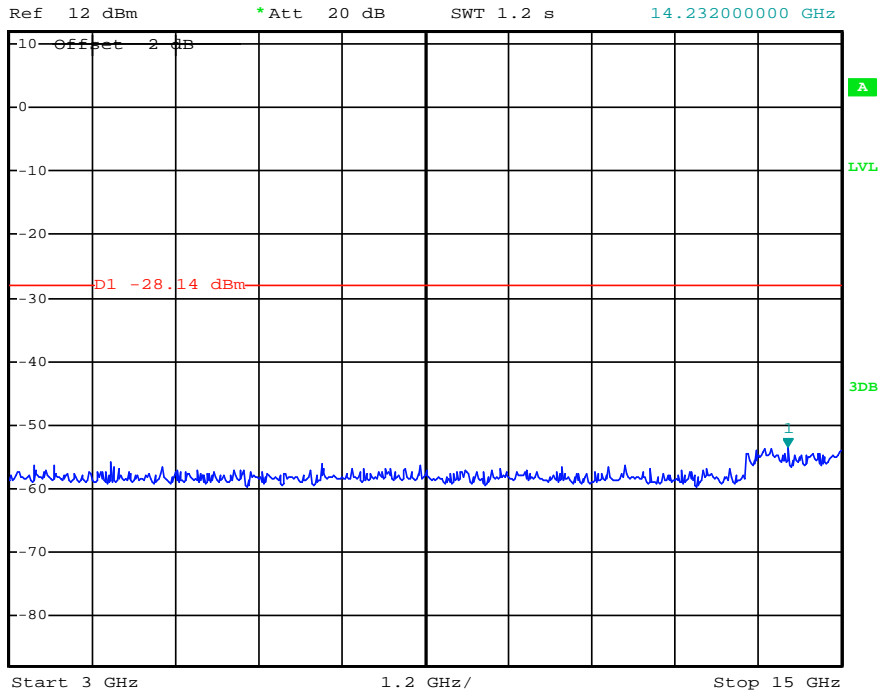

Date: 13.DEC.2013 09:42:47

(Plot 4.7 B2: Channel 19: 2440MHz)



*RBW 100 kHz Marker 1 [T1]
*VBW 300 kHz -51.99 dBm
SWT 1 s 23.380000000 GHz

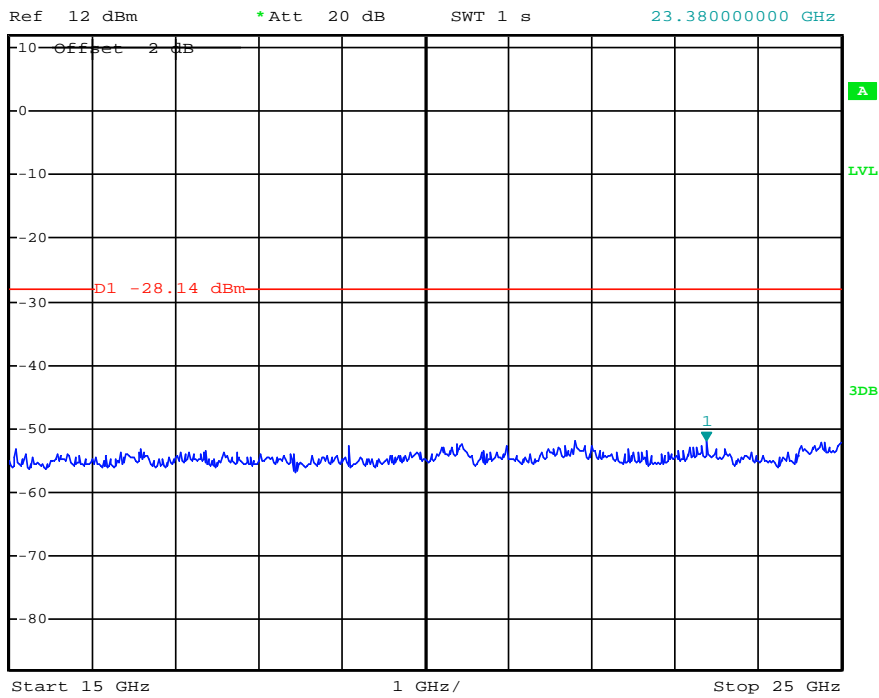

Date: 13.DEC.2013 09:43:00

(Plot 4.7 B3: Channel 19: 2440MHz)



*RBW 100 kHz Marker 1 [T1]
*VBW 300 kHz -10.42 dBm
Ref 12 dBm *Att 20 dB SWT 300 ms 2.484515998 GHz

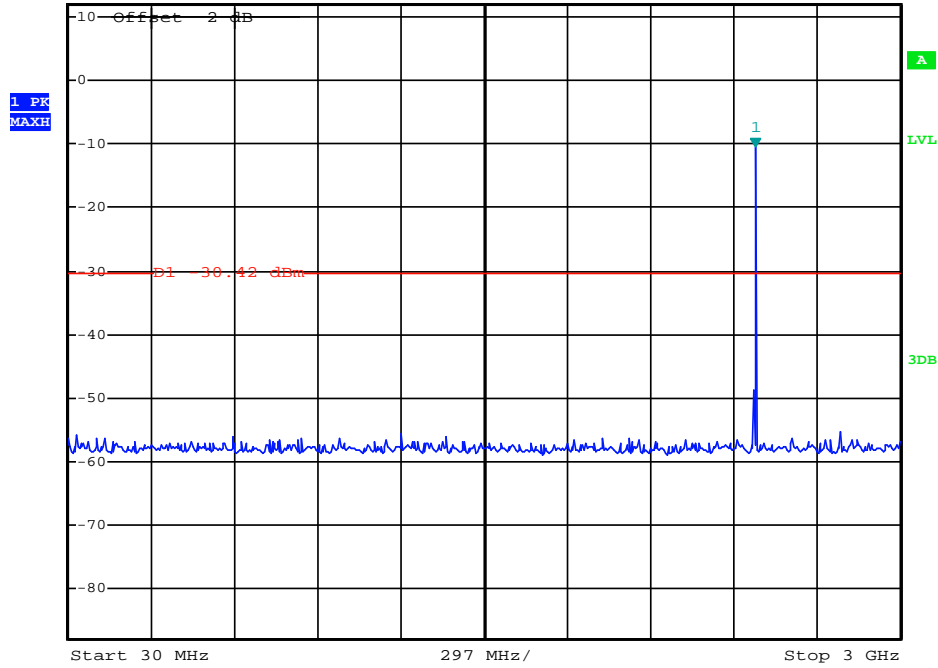

Date: 13.DEC.2013 09:48:11

(Plot 4.7 C1: Channel 39: 2480MHz)



*RBW 100 kHz Marker 1 [T1]
*VBW 300 kHz -53.38 dBm
Ref 12 dBm *Att 20 dB SWT 1.2 s 14.112000000 GHz

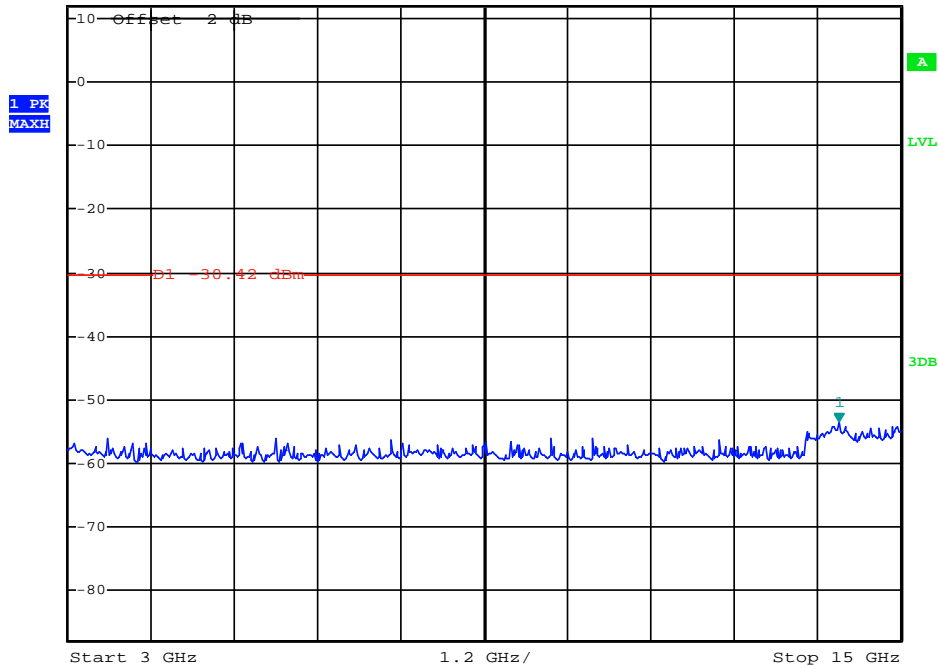

Date: 13.DEC.2013 09:48:25

(Plot 4.7 C2: Channel 39: 2480MHz)



*RBW 100 kHz Marker 1 [T1]
*VBW 300 kHz -52.06 dBm
SWT 1 s 21.660000000 GHz

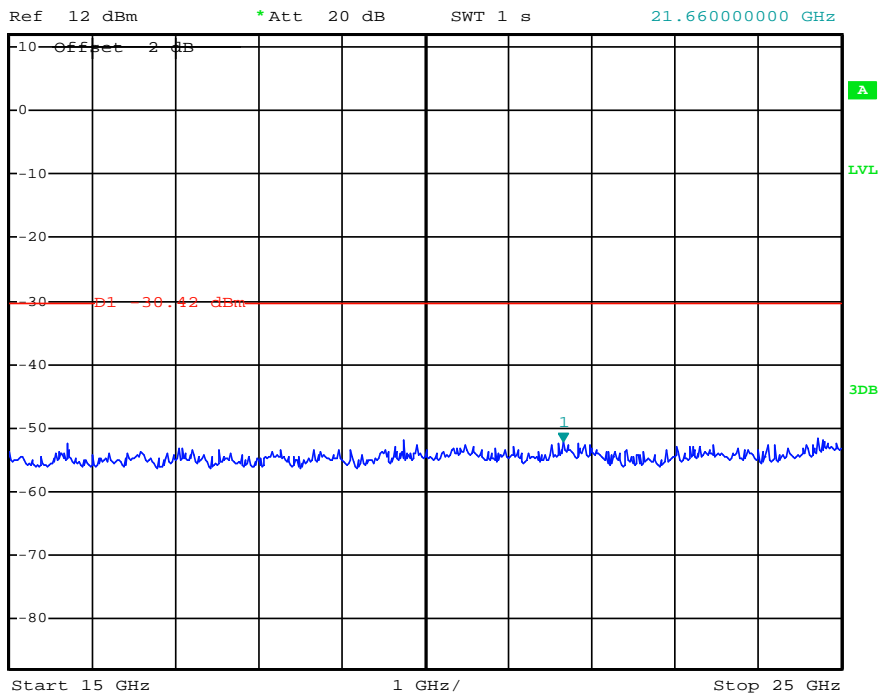

Date: 13.DEC.2013 09:48:40

(Plot 4.7 C3: Channel 39: 2480MHz)



*RBW 100 kHz Marker 1 [T1]
*VBW 300 kHz -6.76 dBm
SWT 5 ms 2.402240000 GHz

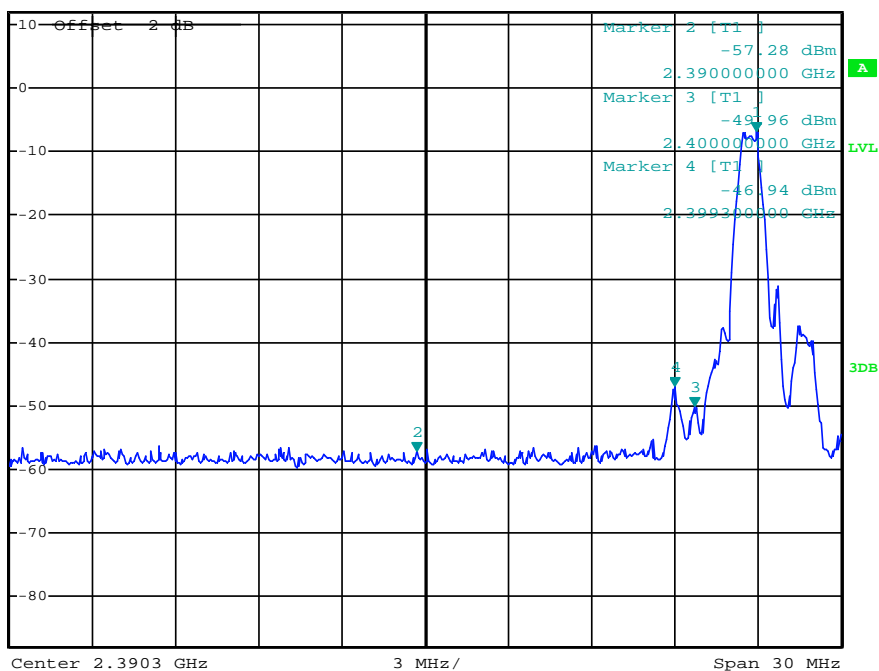

Date: 13.DEC.2013 09:50:31

(Plot 4.7 D: Channel 1: 2402MHz)



*RBW 100 kHz Marker 1 [T1]
*VBW 300 kHz -9.60 dBm
SWT 5 ms 2.479700000 GHz

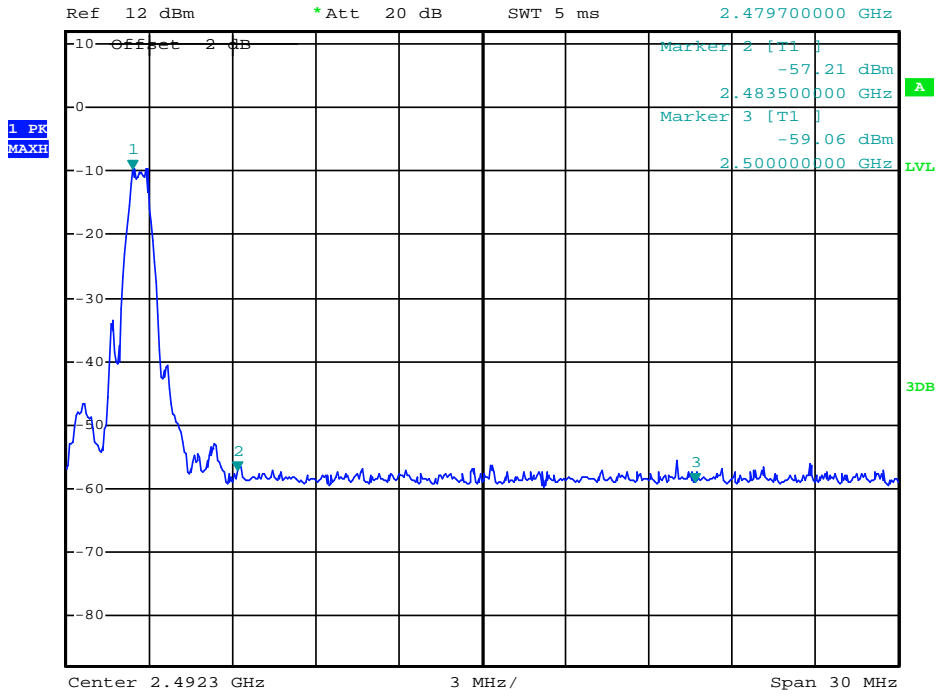

Date: 13.DEC.2013 09:52:13

(Plot 4.7 E: Channel 39: 2480MHz)

4.8. Antenna Requirement

Standard Applicable

For intentional device, according to FCC 47 CFR Section 15.203, an intentional radiator shall be designed to ensure that no antenna other than that furnished by the responsible party shall be used with the device.

And according to FCC 47 CFR Section 15.247 (c), if transmitting antennas of directional gain greater than 6dBi are used, the power shall be reduced by the amount in dB that the directional gain of the antenna exceeds 6dBi.

Refer to statement below for compliance.

The manufacturer may design the unit so that the user can replace a broken antenna, but the use of a standard antenna jack or electrical connector is prohibited. Further, this requirement does not apply to intentional radiators that must be professionally installed.

Antenna Connected Construction

The maximum gain of bluetooth antenna was 0 dBi.

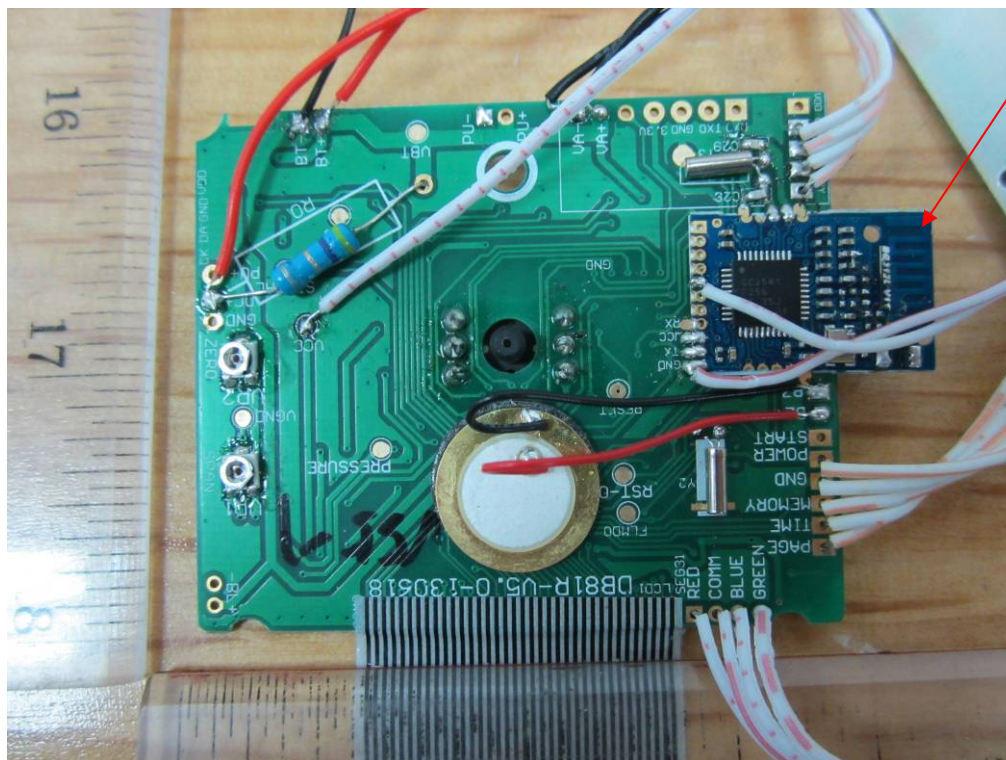

5. Test Setup Photos of the EUT

Radiated Emission (30MHz-1GHz)



Radiated Emission (1GHz-25GHz)



Radiated Emission (Below 30MHz)



6. External and Internal Photos of the EUT

External Photos





Internal Photos

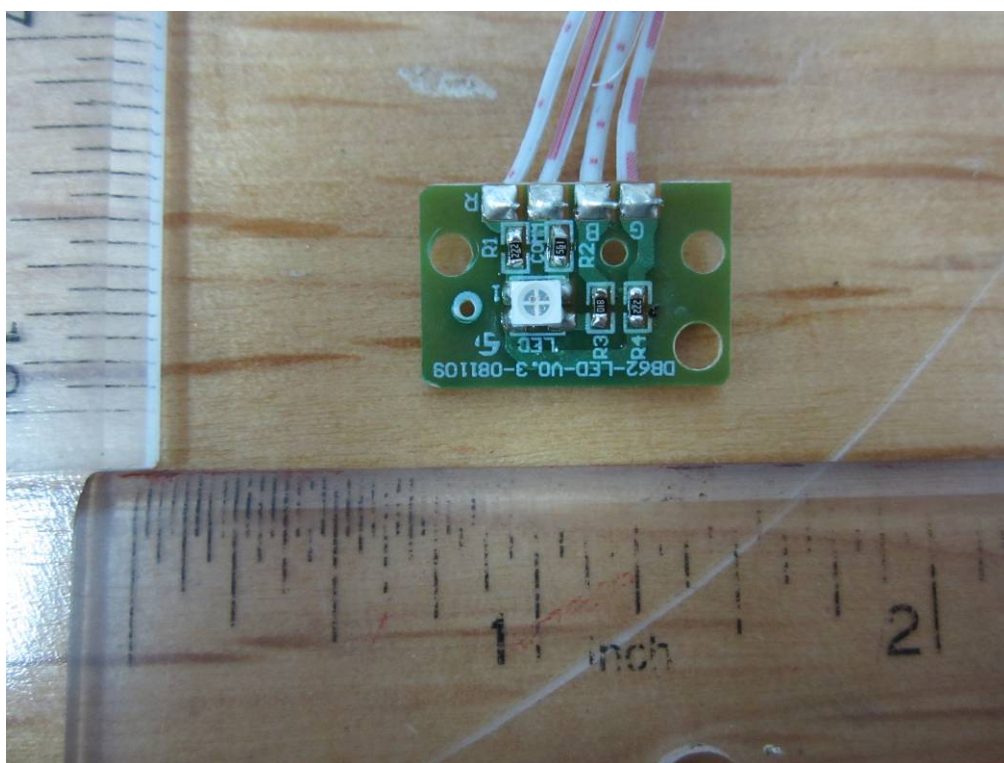
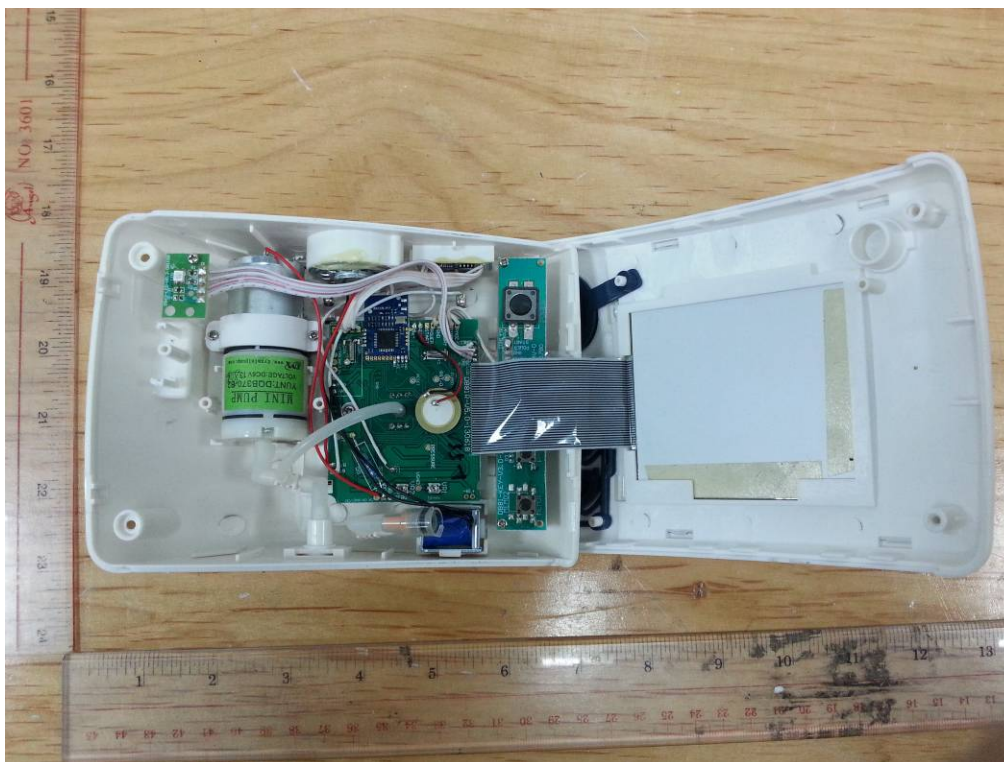

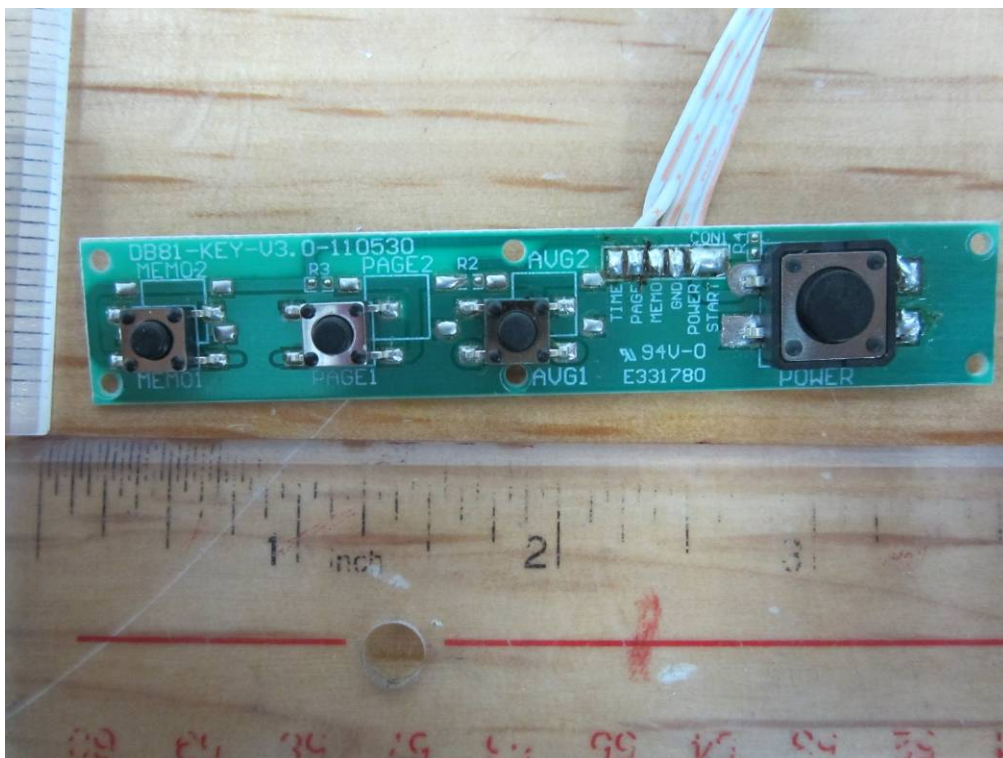
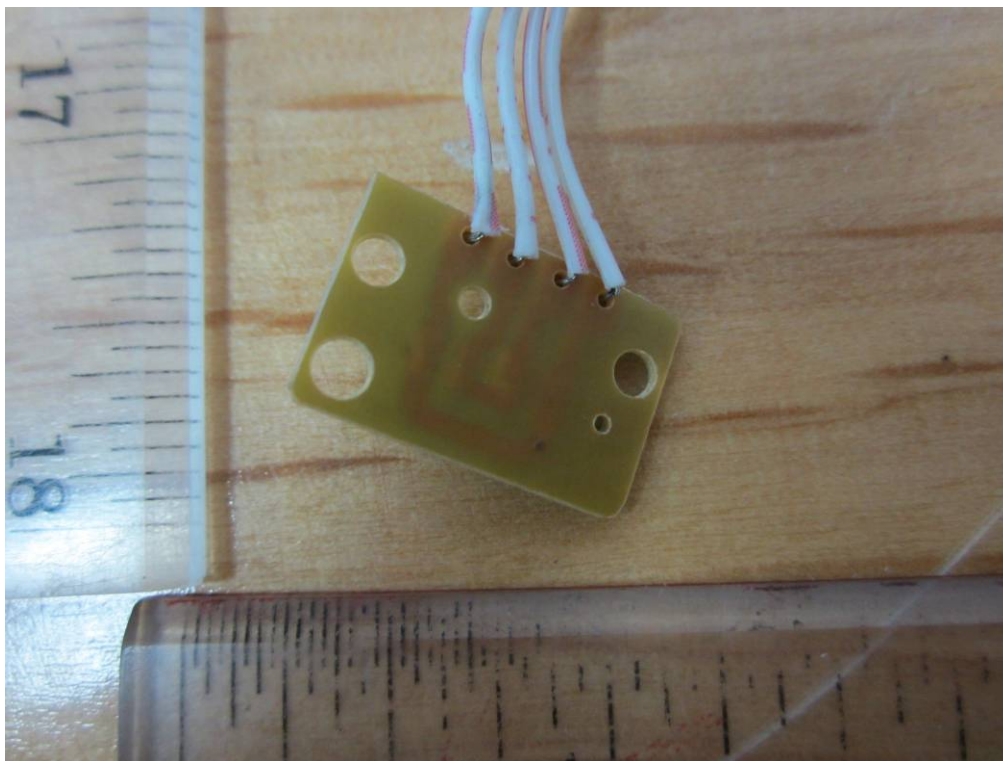

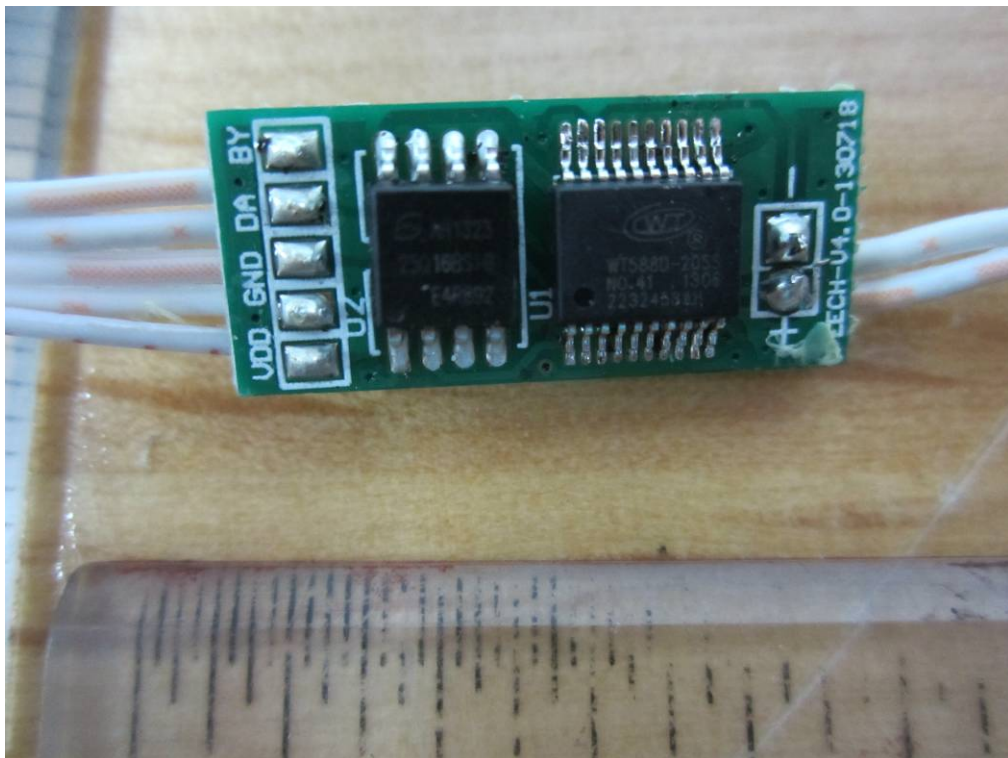
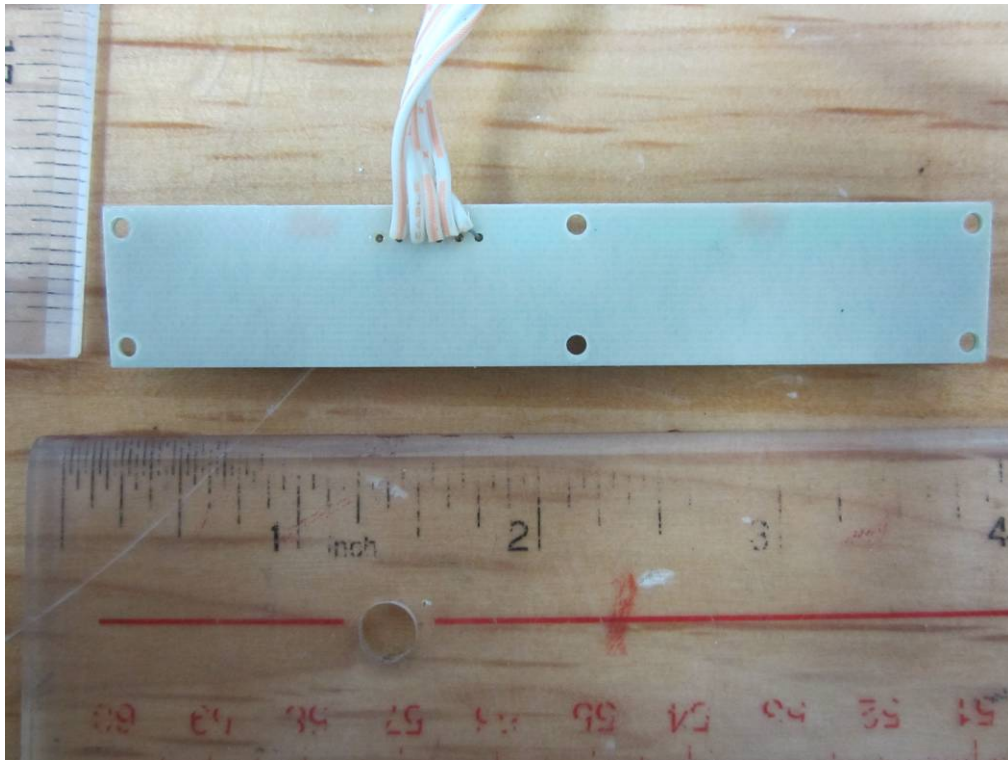

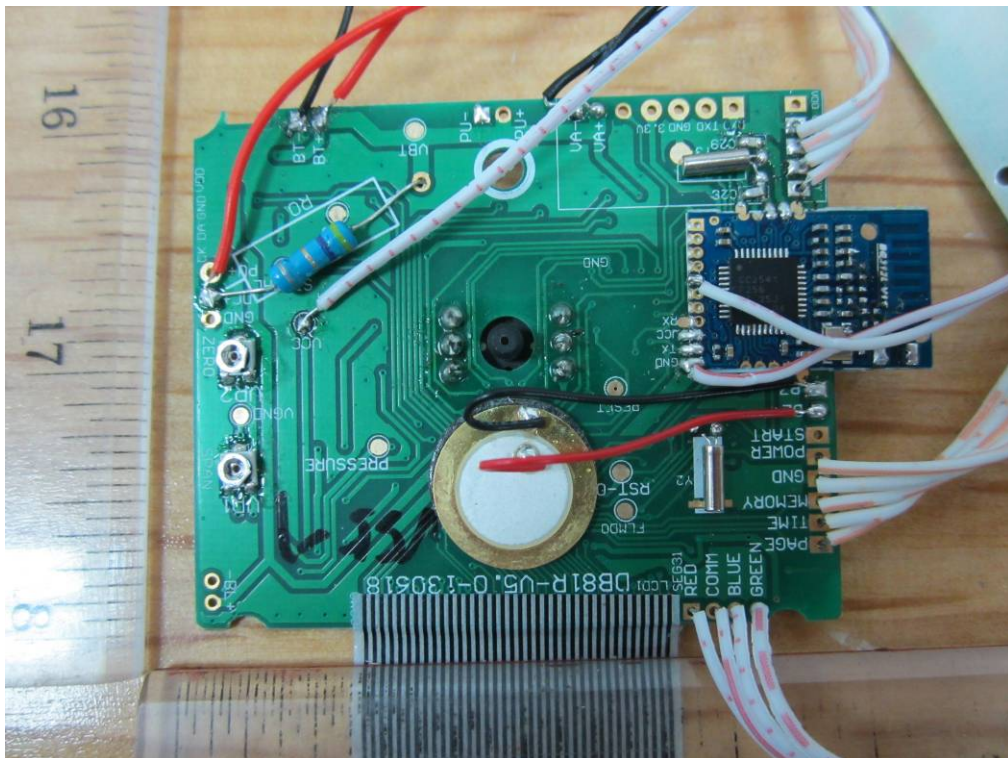
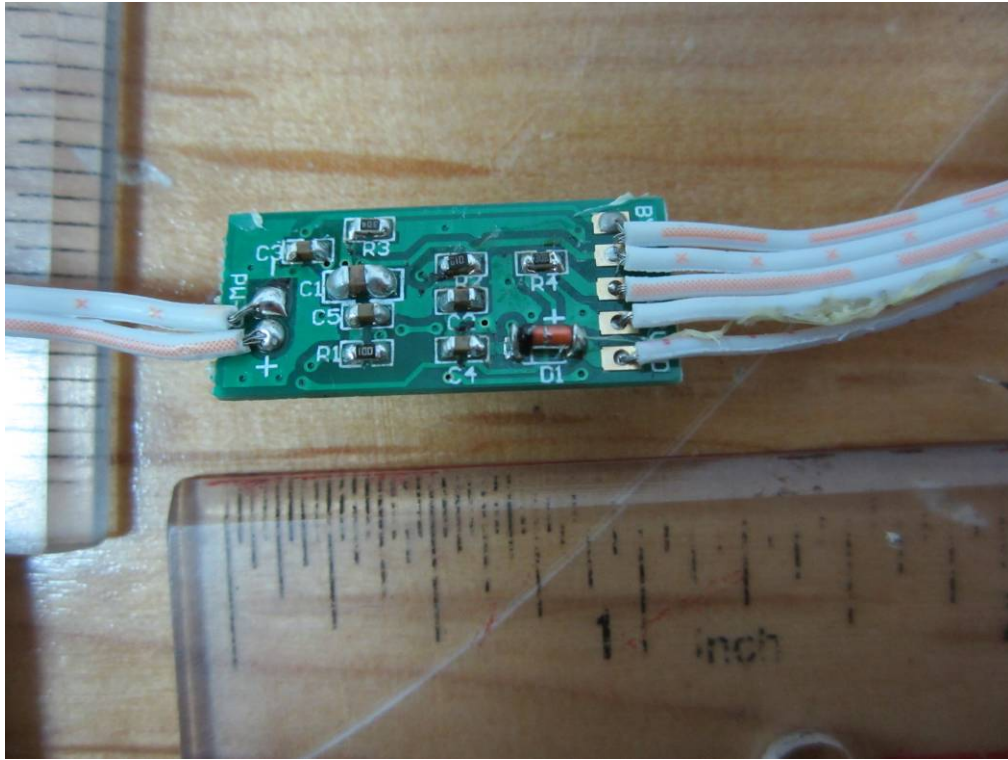

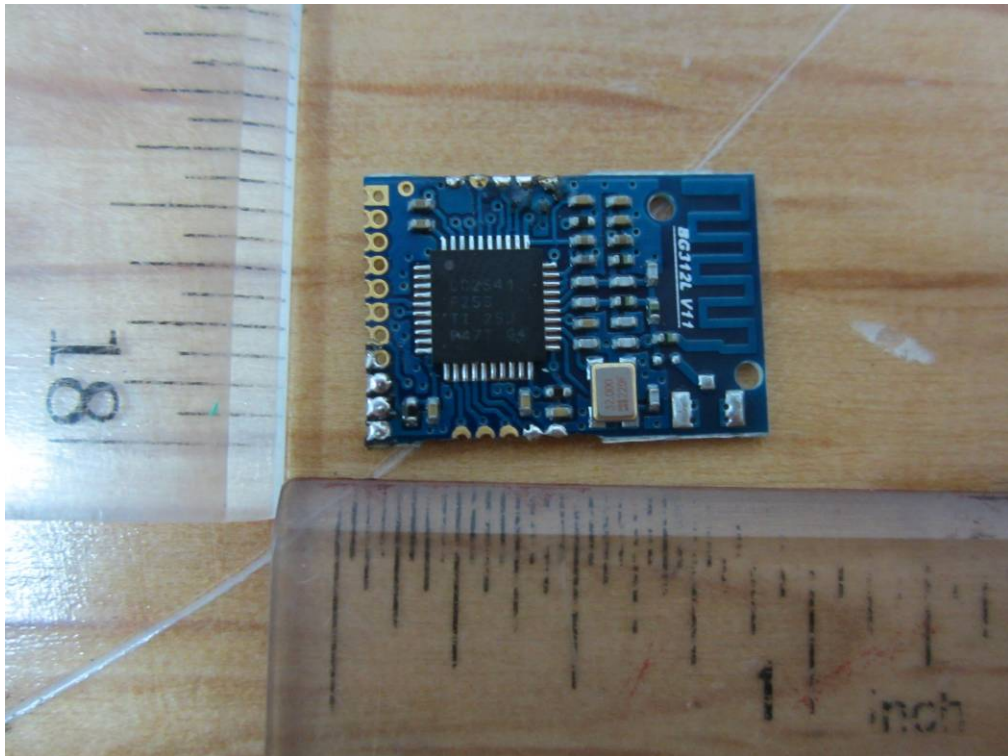
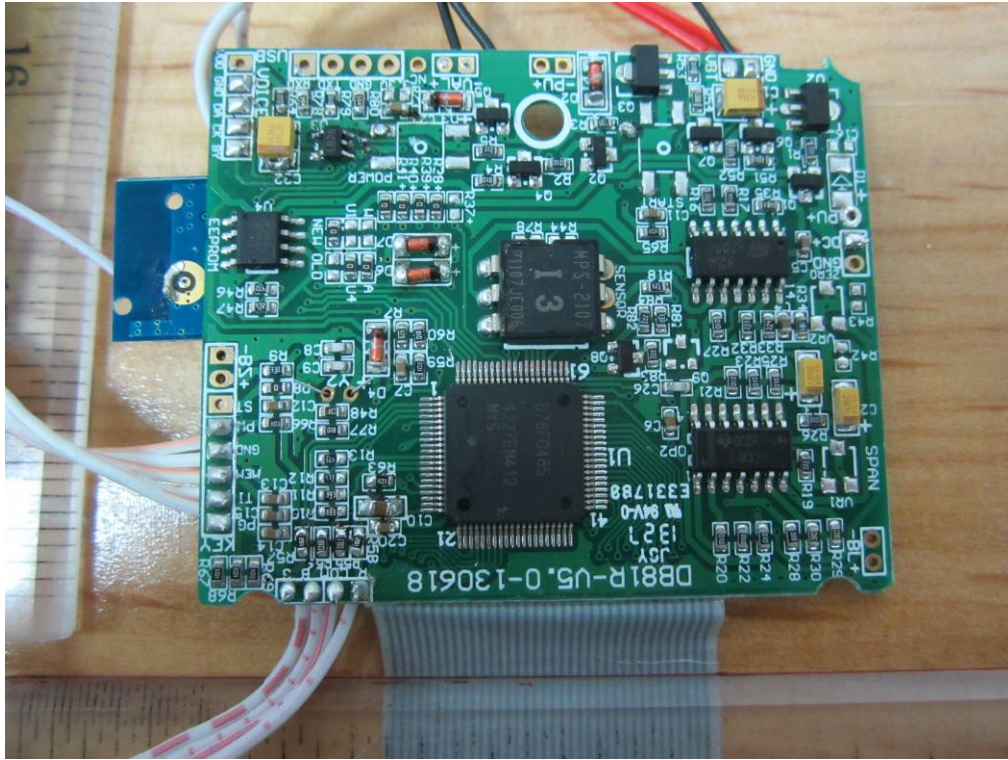

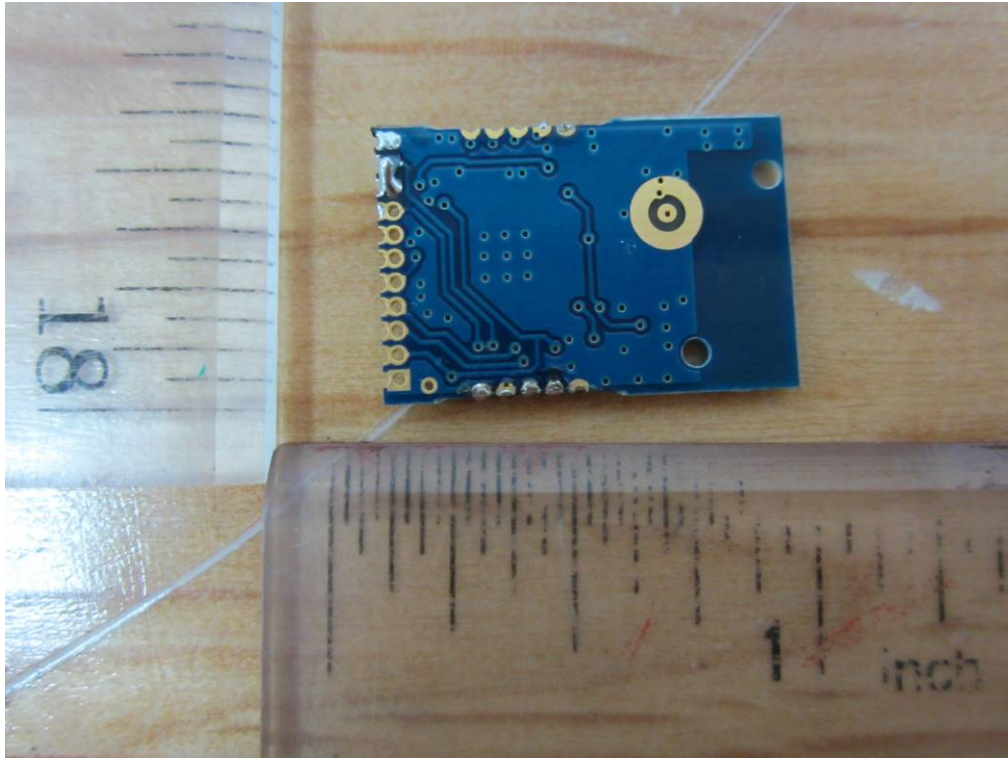

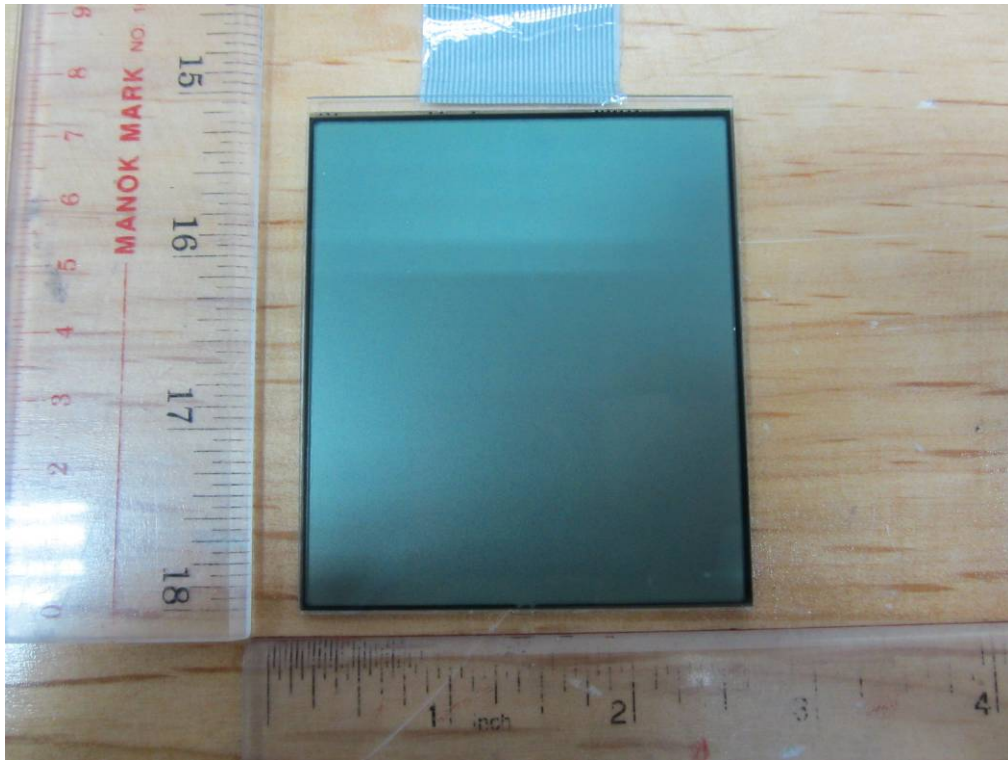

.....End of Report.....