



FCC TEST REPORT

**Test report
On Behalf of
International Communications Corporation
For
11ac Wave2 Tri-band AP
Model No.: ARC50-6WAP
FCC ID: 2ABFZ-ARC50-6WAP**

Prepared for : International Communications Corporation
11801 Pierce St., 2nd FL Riverside, CA 92505, United States

Prepared By : Shenzhen HUAKE Testing Technology Co., Ltd.
1F, B2 Building, Junfeng Zhongcheng Zhizao Innovation Park, Fuhai Street,
Bao'an District, Shenzhen City, China

Date of Test: Oct. 09, 2020 ~Oct. 16, 2020

Date of Report: Oct. 16, 2020

Report Number: HK2010102815-2E



TEST RESULT CERTIFICATION

Applicant's name: International Communications Corporation
Address: 11801 Pierce St., 2nd FL Riverside, CA 92505, United States
Manufacture's Name.....: Shenzhen Yunlink Technology Co., Ltd.
Address: B3 Building, Anle Industrial Zone, Hangcheng Road, Gushu, Xixiang, Bao'an, Shenzhen, China

Product description

Trade Mark: activeARC® Wireless
Product name.....: 11ac Wave2 Tri-band AP
Model and/or type reference .: ARC50-6WAP
Standards: FCC Rules and Regulations Part 15 Subpart C Section 15.407
ANSI C63.10: 2013

This publication may be reproduced in whole or in part for non-commercial purposes as long as the Shenzhen HUAK Testing Technology Co., Ltd. is acknowledged as copyright owner and source of the material. Shenzhen HUAK Testing Technology Co., Ltd. takes no responsibility for and will not assume liability for damages resulting from the reader's interpretation of the reproduced material due to its placement and context.

Date of Test:
Date (s) of performance of tests: Oct. 09, 2020 ~Oct. 16, 2020
Date of Issue.....: Oct. 16, 2020
Test Result.....: Pass

Prepared by:

Project Engineer

Reviewed by:

Project Supervisor

Approved by:

Technical Director



TABLE OF CONTENTS

1. Test Result Summary	5
1.1. TEST PROCEDURES AND RESULTS.....	5
1.2. TEST FACILITY	5
1.3. MEASUREMENT UNCERTAINTY	6
2. EUT Description	7
2.1. GENERAL DESCRIPTION OF EUT	7
2.2. OPERATION FREQUENCY EACH OF CHANNEL.....	8
2.3. OPERATION OF EUT DURING TESTING	8
2.4. DESCRIPTION OF TEST SETUP	9
3. Genera Information	10
3.1. TEST ENVIRONMENT AND MODE	10
3.2. DESCRIPTION OF SUPPORT UNITS	11
4. Test Results and Measurement Data	12
4.1. CONDUCTED EMISSION	12
4.2. MAXIMUM CONDUCTED OUTPUT POWER	16
4.3. 6dB EMISSION BANDWIDTH	19
4.4. 26dB BANDWIDTH AND 99% OCCUPIED BANDWIDTH.....	20
4.5. POWER SPECTRAL DENSITY	37
4.6. BAND EDGE.....	55
4.7. SPURIOUS EMISSION	91
4.8. FREQUENCY STABILITY MEASUREMENT.....	109
4.9. ANTENNA REQUIREMENT	111
4.10. PHOTOGRAPHS OF TEST SETUP	112
4.11. PHOTOS OF THE EUT	114



**** Modified History ****

Revision	Description	Issued Data	Remark
Revision 1.0	Initial Test Report Release	Oct. 16, 2020	Jason Zhou



1. Test Result Summary

1.1. TEST PROCEDURES AND RESULTS

Requirement	CFR 47 Section	Result
Antenna requirement	§15.203	PASS
AC Power Line Conducted Emission	§15.207	PASS
Maximum Conducted Output Power	§15.407(a)	PASS
6dB Emission Bandwidth	§15.407(e)	N/A
26dB Emission Bandwidth & 99% Occupied Bandwidth	§15.407(a)	PASS
Power Spectral Density	§15.407(a)	PASS
Band edge	§15.407(b)/15.209/15.205	PASS
Radiated Emission	§15.407(b)/15.209/15.205	PASS
Frequency Stability	§15.407(g)	PASS

Note:

1. PASS: Test item meets the requirement.
2. Fail: Test item does not meet the requirement.
3. N/A: Test case does not apply to the test object.
4. The test result judgment is decided by the limit of test standard.

1.2. TEST FACILITY

Test Firm : Shenzhen HUAKE Testing Technology Co., Ltd.

Address : 1F, B2 Building, Junfeng Zhongcheng Zhizao Innovation Park, Fuhai Street, Bao'an District, Shenzhen City, China



1.3. Measurement Uncertainty

The reported uncertainty of measurement $y \pm U$, where expanded uncertainty U is based on a standard uncertainty multiplied by a coverage factor of $k=2$, providing a level of confidence of approximately 95 %.

No.	Item	MU
1	Conducted Emission	$\pm 2.71\text{dB}$
2	RF power, conducted	$\pm 0.37\text{dB}$
3	Spurious emissions, conducted	$\pm 0.11\text{dB}$
4	All emissions, radiated(<1G)	$\pm 3.90\text{dB}$
5	All emissions, radiated(>1G)	$\pm 4.28\text{dB}$
6	Temperature	$\pm 0.1^\circ\text{C}$
7	Humidity	$\pm 1.0\%$



2. EUT Description

2.1. GENERAL DESCRIPTION OF EUT

Equipment	11ac Wave2 Tri-band AP
Model Name	ARC50-6WAP
Serial No.	N/A
Trade Mark	activeARC® Wireless
Model Difference	N/A
FCC ID	2ABFZ-ARC50-6WAP
Operation Frequency:	IEEE 802.11a/n/ac(HT20) 5.180GHz-5.240GHz IEEE 802.11n/ac(HT40) 5.190GHz-5.230GHz IEEE 802.11ac(HT80) 5.210GHz
Modulation Technology:	IEEE 802.11a/n/ac
Modulation Type	OFDM
Antenna Type	Internal Antenna
Antenna Gain	Antenna 1:3dBi Antenna 2:3dBi MIMO: 6.01dBi
Power Source	POE IN 48V DC IN 12V 2A
Power Supply:	POE IN 48V DC IN 12V 2A
Note: The EUT incorporates a MIMO function. Physically, it provides two completed transmitters and receivers(2T2R), two transmit signals are completely correlated, then, Direction gain= $GA_{NT} + 10 \cdot \log(2)$ dBi.	



2.2. Operation Frequency each of channel

802.11a/802.11n(HT20) 802.11ac(HT20)		802.11n(HT40)/ 802.11ac(HT40)		802.11ac(HT80)	
Channel	Frequency	Channel	Frequency	Channel	Frequency
36	5180	38	5190	42	5210
40	5200	46	5230		
44	5220				
48	5240				

Note:

In section 15.31(m), regards to the operating frequency range over 10 MHz, the Lowest frequency, the middle frequency, and the highest frequency of channel were selected to perform the test, and the selected channel see below:

2.3. Operation of EUT during testing

For 802.11a/n (HT20)/ac(HT20)

Band I (5150 - 5250 MHz)		
Channel Number	Channel	Frequency (MHz)
36	Low	5180
40	Mid	5200
48	High	5240

For 802.11n (HT40)/ ac(HT40)

Band I (5150 - 5250 MHz)		
Channel Number	Channel	Frequency (MHz)
38	Low	5190
46	High	5230

For 802.11ac(HT80)

Band I (5150 - 5250 MHz)	
Channel Number	Frequency (MHz)
42	5210



2.4. DESCRIPTION OF TEST SETUP

Operation of EUT during conducted testing and radiation below 1GHz testing:

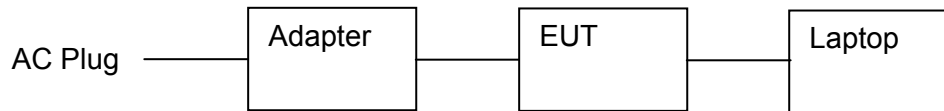

Operation of EUT during radiation above 1GHz testing:

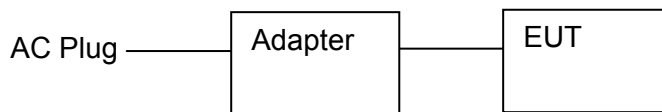

- Adapter information
Model: GRT-POE15-480050
Input: AC100-240V, 50-60Hz, 0.8A
Output: 48V, 500mA
- Laptop information
Model: SE2417HG
Input: 100-240V, 50/60Hz, 1.6A

The sample was placed (0.8m below 1GHz, 1.5m above 1GHz) above the ground plane of 3m chamber. Measurements in both horizontal and vertical polarities were performed. During the test, each emission was maximized by: having the EUT continuously working, investigated all operating modes, rotated about all 3 axis (X, Y & Z) and considered typical configuration to obtain worst position, manipulating interconnecting cables, rotating the turntable, varying antenna height from 1m to 4m in both horizontal and vertical polarizations. The emissions worst-case are shown in Test Results of the following pages. The worst case is X position.



3. Genera Information

3.1. Test environment and mode

Operating Environment:	
Temperature:	25.0 °C
Humidity:	56 % RH
Atmospheric Pressure:	1010 mbar
Test Mode:	
Engineering mode:	Keep the EUT in continuous transmitting by select channel and modulations(The value of duty cycle is 100%)
<p>The sample was placed 0.8m/1.5m for blow/above 1GHz above the ground plane of 3m chamber. Measurements in both horizontal and vertical polarities were performed. During the test, each emission was maximized by: having the EUT continuously working, investigated all operating modes, rotated about all 3 axis (X, Y & Z) and considered typical configuration to obtain worst position, manipulating interconnecting cables, rotating the turntable, varying antenna height from 1m to 4m in both horizontal and vertical polarizations. The emissions worst-case are shown in Test Results of the following pages.</p>	

<p>We have verified the construction and function in typical operation. All the test modes were carried out with the EUT in transmitting operation, which was shown in this test report and defined as follows:</p>	
Per-scan all kind of data rate in lowest channel, and found the follow list which it was worst case.	
Mode	Data rate
802.11a	6 Mbps
802.11n(HT20)	MCS0
802.11n(HT40)	MCS0
802.11ac(HT20)/ac(HT40)/ac(HT80)	MCS0
Final Test Mode:	
Operation mode:	Keep the EUT in continuous transmitting with modulation



3.2. Description of Support Units

The EUT has been tested as an independent unit together with other necessary accessories or support units. The following support units or accessories were used to form a representative test configuration during the tests.

Equipment	Model No.	Serial No.	FCC ID	Trade Name
/	/	/	/	/

Note:

- 1. All the equipment/cables were placed in the worst-case configuration to maximize the emission during the test.*
- 2. Grounding was established in accordance with the manufacturer's requirements and conditions for the intended use.*
- 3. For conducted measurements (Output Power, Emission Bandwidth, Power Spectral Density, Spurious Emissions), the antenna of EUT is connected to the test equipment via temporary antenna connector, the antenna connector is soldered on the antenna port of EUT, and the temporary antenna connector is listed in the Test Instruments.*



4. Test Results and Measurement Data

4.1. Conducted Emission

4.1.1. Test Specification

Test Requirement:	FCC Part15 C Section 15.207														
Test Method:	ANSI C63.10:2013														
Frequency Range:	150 kHz to 30 MHz														
Receiver setup:	RBW=9 kHz, VBW=30 kHz, Sweep time=auto														
Limits:	<table border="1"> <thead> <tr> <th rowspan="2">Frequency range (MHz)</th> <th colspan="2">Limit (dBuV)</th> </tr> <tr> <th>Quasi-peak</th> <th>Average</th> </tr> </thead> <tbody> <tr> <td>0.15-0.5</td> <td>66 to 56*</td> <td>56 to 46*</td> </tr> <tr> <td>0.5-5</td> <td>56</td> <td>46</td> </tr> <tr> <td>5-30</td> <td>60</td> <td>50</td> </tr> </tbody> </table>	Frequency range (MHz)	Limit (dBuV)		Quasi-peak	Average	0.15-0.5	66 to 56*	56 to 46*	0.5-5	56	46	5-30	60	50
Frequency range (MHz)	Limit (dBuV)														
	Quasi-peak	Average													
0.15-0.5	66 to 56*	56 to 46*													
0.5-5	56	46													
5-30	60	50													
Test Setup:	<p style="text-align: center;">Reference Plane</p> <p style="text-align: center;">40cm 80cm</p> <p style="text-align: center;">E.U.T AC power LISN Filter AC power</p> <p style="text-align: center;">EMI Receiver</p> <p style="text-align: center;">Test table/Insulation plane</p> <p><i>Remark:</i> <i>E.U.T: Equipment Under Test</i> <i>LISN: Line Impedance Stabilization Network</i> <i>Test table height=0.8m</i></p>														
Test Mode:	Tx Mode														
Test Procedure:	<ol style="list-style-type: none"> 1. The E.U.T and simulators are connected to the main power through a line impedance stabilization network (L.I.S.N.). This provides a 50ohm/50uH coupling impedance for the measuring equipment. 2. The peripheral devices are also connected to the main power through a LISN that provides a 50ohm/50uH coupling impedance with 50ohm termination. (Please refer to the block diagram of the test setup and photographs). 3. Both sides of A.C. line are checked for maximum conducted interference. In order to find the maximum emission, the relative positions of equipment and all of the interface cables must be changed according to ANSI C63.10: 2013 on conducted measurement. 														
Test Result:	PASS														



4.1.2. Test Instruments

Conducted Emission Shielding Room Test Site (843)

Equipment	Manufacturer	Model	Serial Number	Calibration Date	Calibration Due
Receiver	R&S	ESCI 7	HKE-010	Dec. 26, 2019	Dec. 25, 2020
LISN	R&S	ENV216	HKE-002	Dec. 26, 2019	Dec. 25, 2020
Coax cable (9KHz-30MHz)	Times	381806-002	N/A	Dec. 26, 2019	Dec. 25, 2020
Conducted test software	Tonscend	TS+ Rev 2.5.0.0	HKE-081	N/A	N/A

Note: The calibration interval of the above test instruments is 12 months and the calibrations are traceable to international system unit (SI).



4.1.3. Test data

All the test modes completed for test. only the worst result was reported as below:
Conducted Emission on Line Terminal of the power line (150 kHz to 30MHz)

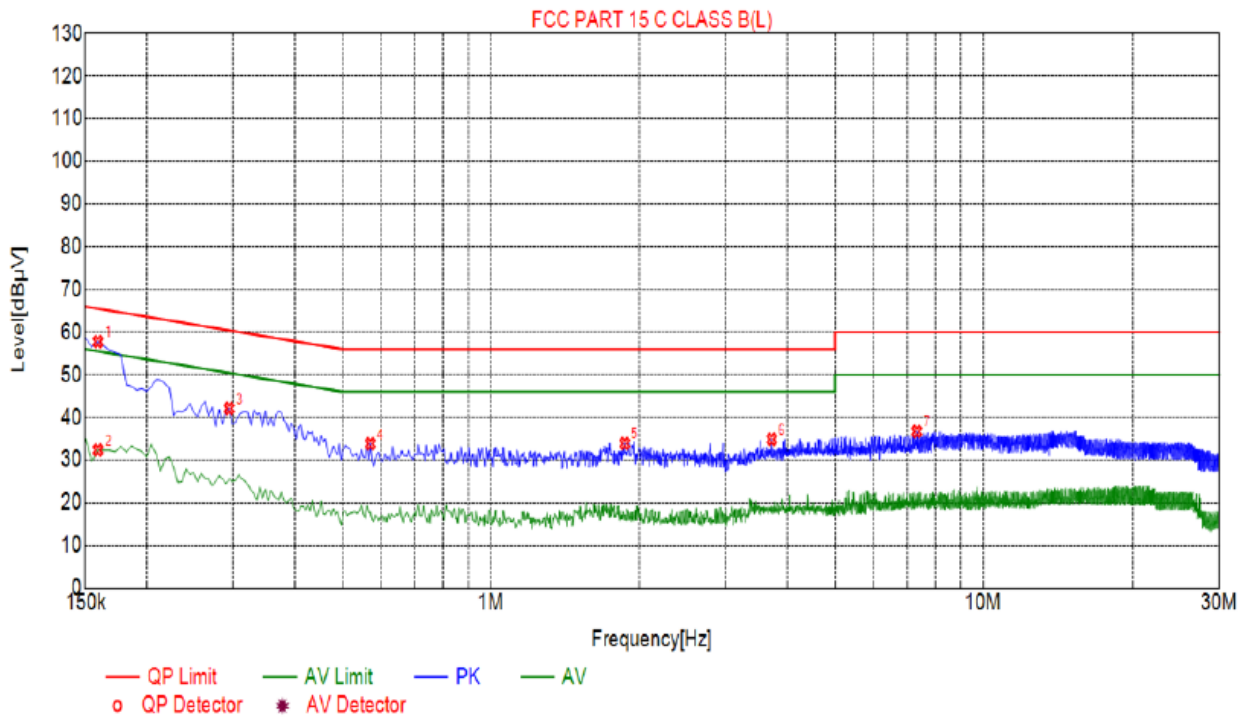

Suspected List								
NO.	Freq. [MHz]	Level [dBµV]	Factor [dB]	Limit [dBµV]	Margin [dB]	Reading [dBµV]	Detector	Type
1	0.1590	57.77	20.01	65.52	7.75	37.76	PK	L
2	0.1590	32.32	20.01	55.52	23.20	12.31	AV	L
3	0.2940	42.09	20.03	60.41	18.32	22.06	PK	L
4	0.5685	33.81	20.05	56.00	22.19	13.76	PK	L
5	1.8690	33.88	20.14	56.00	22.12	13.74	PK	L
6	3.7185	34.85	20.25	56.00	21.15	14.60	PK	L
7	7.3365	36.69	20.18	60.00	23.31	16.51	PK	L

Remark: Margin = Limit – Level
 Correction factor = Cable lose + LISN insertion loss
 Level=Test receiver reading + correction factor



Conducted Emission on Neutral Terminal of the power line (150 kHz to 30MHz)

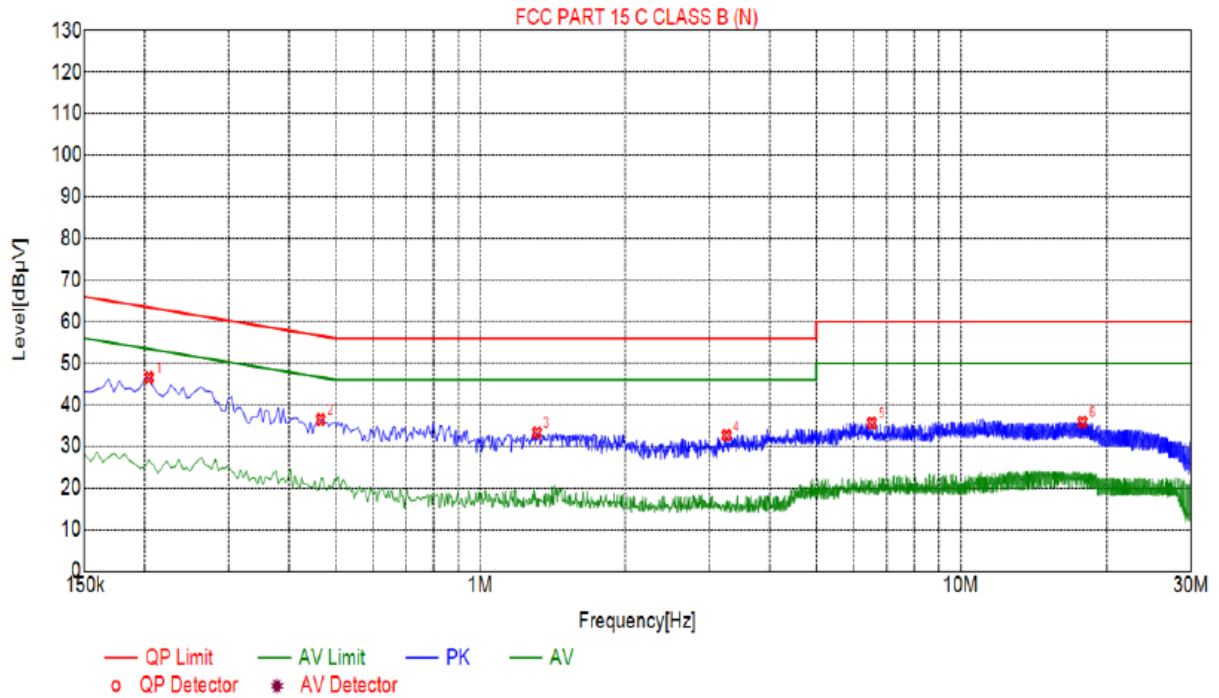

Suspected List								
NO.	Freq. [MHz]	Level [dBµV]	Factor [dB]	Limit [dBµV]	Margin [dB]	Reading [dBµV]	Detector	Type
1	0.2040	46.54	20.04	63.45	16.91	26.50	PK	N
2	0.4650	36.45	20.04	56.60	20.15	16.41	PK	N
3	1.3110	33.30	20.10	56.00	22.70	13.20	PK	N
4	3.2550	32.64	20.23	56.00	23.36	12.41	PK	N
5	6.5355	35.61	20.21	60.00	24.39	15.40	PK	N
6	17.8035	35.84	20.03	60.00	24.16	15.81	PK	N

Remark: Margin = Limit – Level
 Correction factor = Cable lose + LISN insertion loss
 Level=Test receiver reading + correction factor



4.2. Maximum Conducted Output Power

4.2.1. Test Specification

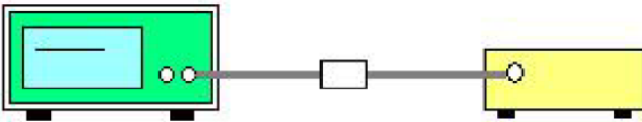
Test Requirement:	FCC Part15 E Section 15.407(a)	
Test Method:	KDB789033 D02 General UNII Test Procedures New Rules v02.r01 Section E	
Limit:	Frequency Band (MHz)	Limit
	5150-5250	1W for indoor access points device
Test Setup:	 <p style="text-align: center;"> Power meter EUT </p>	
Test Mode:	Transmitting mode with modulation	
Test Procedure:	<ol style="list-style-type: none"> 1. The testing follows the Measurement Procedure of KDB789033 D02 General UNII Test Procedures New Rules v02r01 Section E, 3, a 2. The RF output of EUT was connected to the power meter by RF cable and attenuator. The path loss was compensated to the results for each measurement. 3. Set to the maximum power setting and enable the EUT transmit continuously. 5. Measure the conducted output power and record the results in the test report. 	
Test Result:	PASS	
Remark:	Conducted output power= measurement power +10log(1/x) X is duty cycle=1, so 10log(1/1)=0 Conducted output power= measurement power	



4.2.2. Test Instruments

RF Test Room					
Equipment	Manufacturer	Model	Serial Number	Calibration Date	Calibration Due
Spectrum analyzer	Agilent	N9020A	HKE-048	Dec. 26, 2019	Dec. 25, 2020
Power meter	Agilent	E4419B	HKE-085	Dec. 26, 2019	Dec. 25, 2020
Power Sensor	Agilent	E9300A	HKE-086	Dec. 26, 2019	Dec. 25, 2020
RF cable	Times	1-40G	HKE-034	Dec. 26, 2019	Dec. 25, 2020
RF automatic control unit	Tonscend	JS0806-2	HKE-060	Dec. 26, 2019	Dec. 25, 2020

Note: The calibration interval of the above test instruments is 12 months and the calibrations are traceable to international system unit (SI).



4.2.3. Test Data

Configuration Band I (5150 - 5250 MHz)						
Mode	Test channel	Maximum Conducted Output Power (dBm)			FCC Limit (dBm)	Result
		Antenna 1	Antenna 2	MIMO		
11a	CH36	14.64	14.44	/	30	PASS
11a	CH40	14.34	14.71	/	30	PASS
11a	CH48	15	14.98	/	30	PASS
11n(HT20)	CH36	14.43	14.52	17.49	30	PASS
11n(HT20)	CH40	14.33	14.17	17.26	30	PASS
11n(HT20)	CH48	14.94	14.26	17.62	30	PASS
11n(HT40)	CH38	13.52	13.41	16.48	30	PASS
11n(HT40)	CH46	13.23	13.19	16.22	30	PASS
11ac(HT20)	CH36	14.29	13.02	16.71	30	PASS
11ac(HT20)	CH40	13.91	14.18	17.06	30	PASS
11ac(HT20)	CH48	12.77	13.66	16.25	30	PASS
11ac(HT40)	CH38	12.30	13.36	15.87	30	PASS
11ac(HT40)	CH46	12.83	12.67	15.76	30	PASS
11ac(HT80)	CH42	12.75	12.84	15.81	30	PASS



4.3. 6dB Emission Bandwidth

4.3.1. Test Specification

Test Requirement:	FCC CFR47 Part 15 Section 15.407(e)
Test Method:	KDB789033 D02 General UNII Test Procedures New Rules v02r01 Section C
Limit:	>500kHz
Test Setup:	 Spectrum Analyzer EUT
Test Mode:	Transmitting mode with modulation
Test Procedure:	<ol style="list-style-type: none">1. KDB789033 D02 General UNII Test Procedures New Rules v01r04 Section C2. Set to the maximum power setting and enable the EUT transmit continuously.3. Make the measurement with the spectrum analyzer's resolution bandwidth (RBW) = 100 kHz. Set the Video bandwidth (VBW) = 300 kHz. In order to make an accurate measurement. The 6dB bandwidth must be greater than 500 kHz.4. Measure and record the results in the test report.
Test Result:	PASS

4.3.2. Test Instruments

	RF Test Room				
Equipment	Manufacturer	Model	Serial Number	Calibration Date	Calibration Due
Spectrum analyzer	Agilent	N9020A	HKE-048	Dec. 26, 2019	Dec. 25, 2020
RF cable	Times	1-40G	HKE-034	Dec. 26, 2019	Dec. 25, 2020
RF automatic control unit	Tonscend	JS0806-2	HKE-060	Dec. 26, 2019	Dec. 25, 2020

Note: The calibration interval of the above test instruments is 12 months and the calibrations are traceable to international system unit (SI).

4.3.3. Test data

N/A



4.4. 26dB Bandwidth and 99% Occupied Bandwidth

4.4.1. Test Specification

Test Requirement:	47 CFR Part 15C Section 15.407 (a)
Test Method:	KDB789033 D02 General UNII Test Procedures New Rules v02r01 Section C
Limit:	No restriction limits
Test Setup:	 <p style="text-align: center;">Spectrum Analyzer EUT</p>
Test Mode:	Transmitting mode with modulation
Test Procedure:	<ol style="list-style-type: none"> 1. KDB789033 D02 General UNII Test Procedures New Rules v02r01 Section C 2. Set to the maximum power setting and enable the EUT transmit continuously. 3. Make the measurement with the spectrum analyzer's resolution bandwidth $RBW = 1\% EBW$, $VBW \geq 3RBW$, In order to make an accurate measurement. 4. Measure and record the results in the test report.
Test Result:	PASS

4.4.2. Test Instruments

RF Test Room					
Equipment	Manufacturer	Model	Serial Number	Calibration Date	Calibration Due
Spectrum analyzer	Agilent	N9020A	HKE-048	Dec. 26, 2019	Dec. 25, 2020
RF cable	Times	1-40G	HKE-034	Dec. 26, 2019	Dec. 25, 2020
RF automatic control unit	Tonscend	JS0806-2	HKE-060	Dec. 26, 2019	Dec. 25, 2020

Note: The calibration interval of the above test instruments is 12 months and the calibrations are traceable to international system unit (SI).



4.4.3. Test data

Band I

ANT 1

Mode	Test channel	Frequency (MHz)	26 dB Bandwidth (MHz)	Verdict
11a	CH36	5180	21.15	PASS
11a	CH40	5200	21.21	PASS
11a	CH48	5240	21.15	PASS
11n(HT20)	CH36	5180	22.31	PASS
11n(HT20)	CH40	5200	22.57	PASS
11n(HT20)	CH48	5240	22.37	PASS
11n(HT40)	CH38	5190	43.09	PASS
11n(HT40)	CH46	5230	43.58	PASS
11ac(HT20)	CH36	5180	22.14	PASS
11ac(HT20)	CH40	5200	22.52	PASS
11ac(HT20)	CH48	5240	22.21	PASS
11ac(HT40)	CH38	5190	43.42	PASS
11ac(HT40)	CH46	5230	43.35	PASS
11ac(HT80)	CH42	5210	89.70	PASS

Test plots as follows:



Band I (5150 – 5250 MHz)

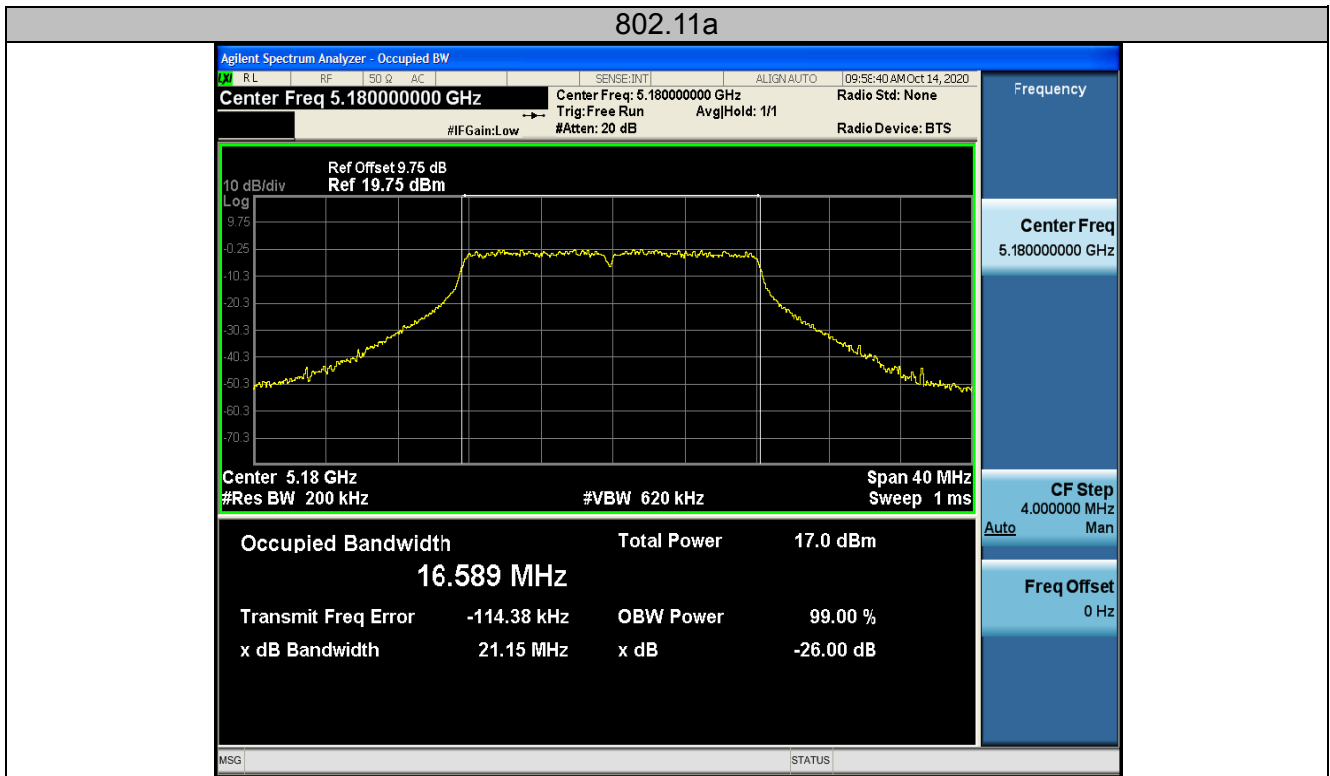

Low

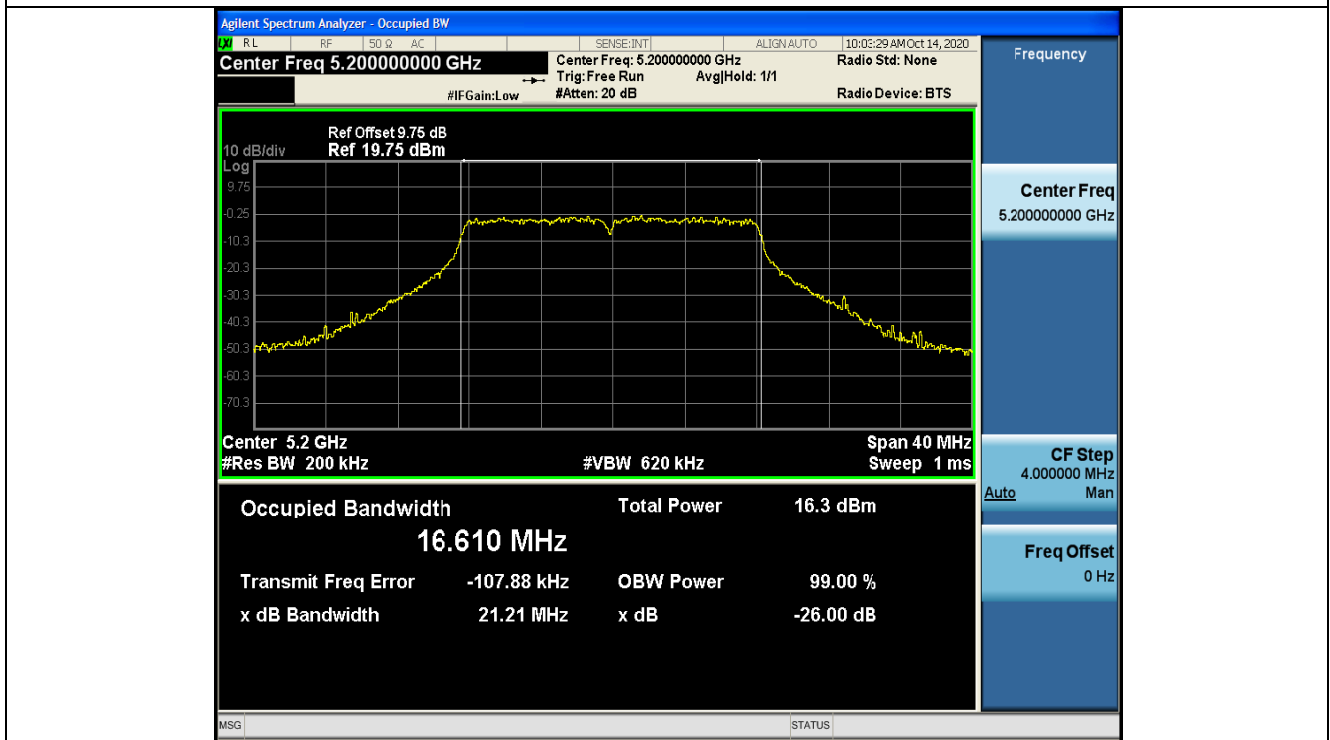

Mid

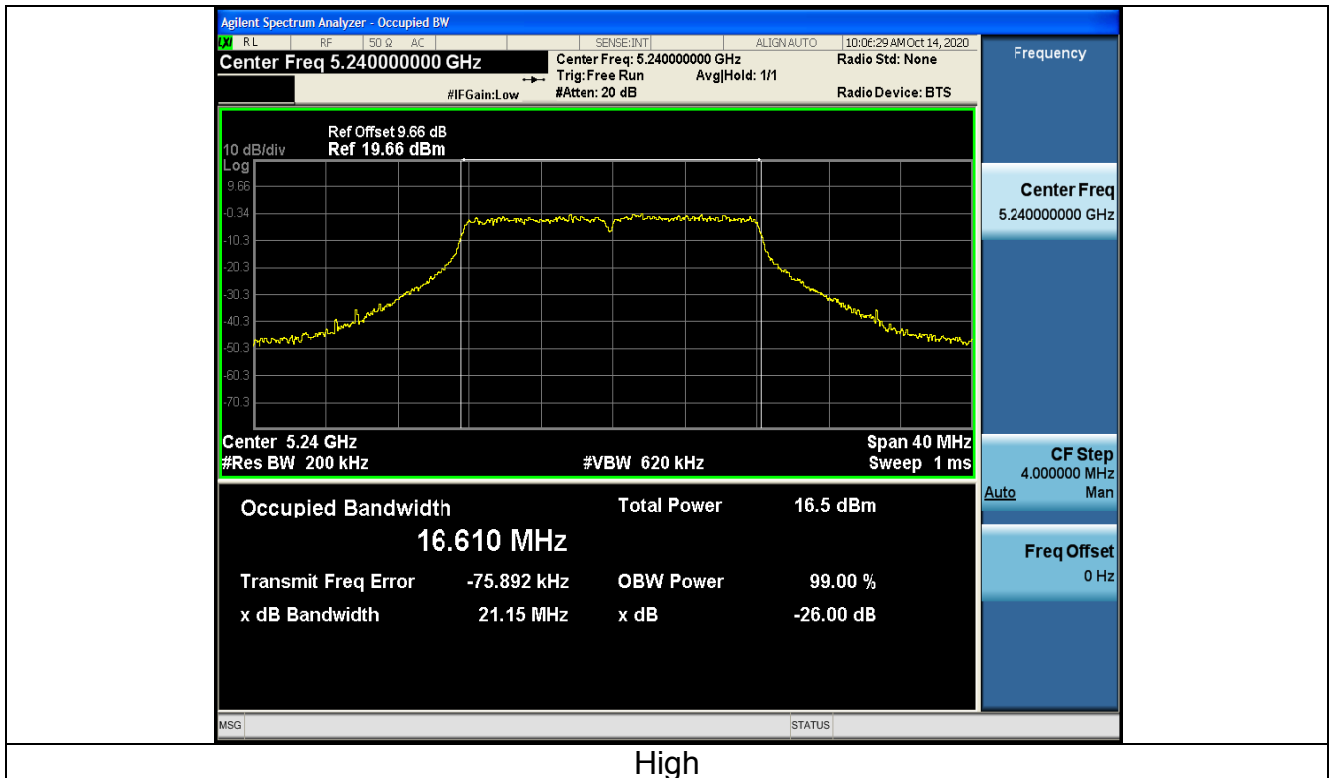

High

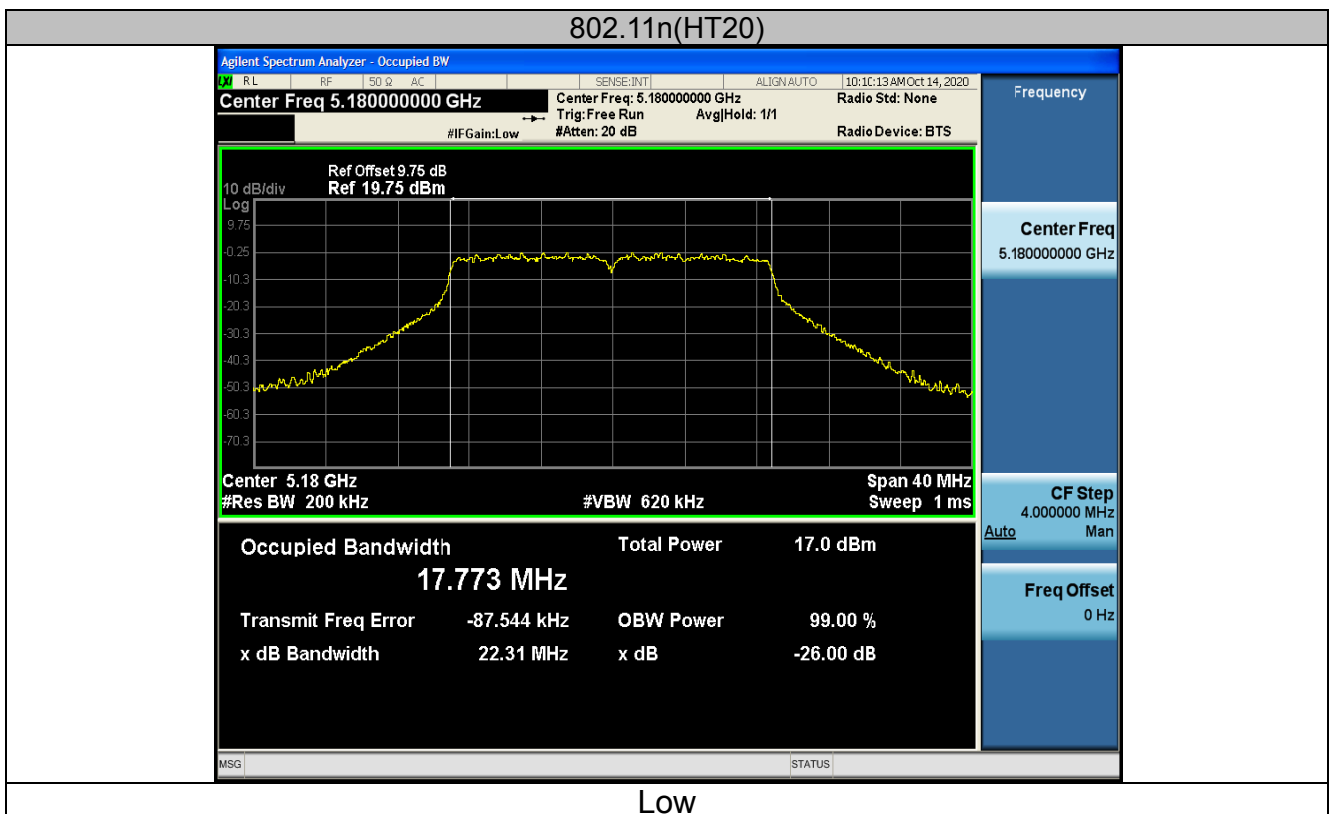

Low

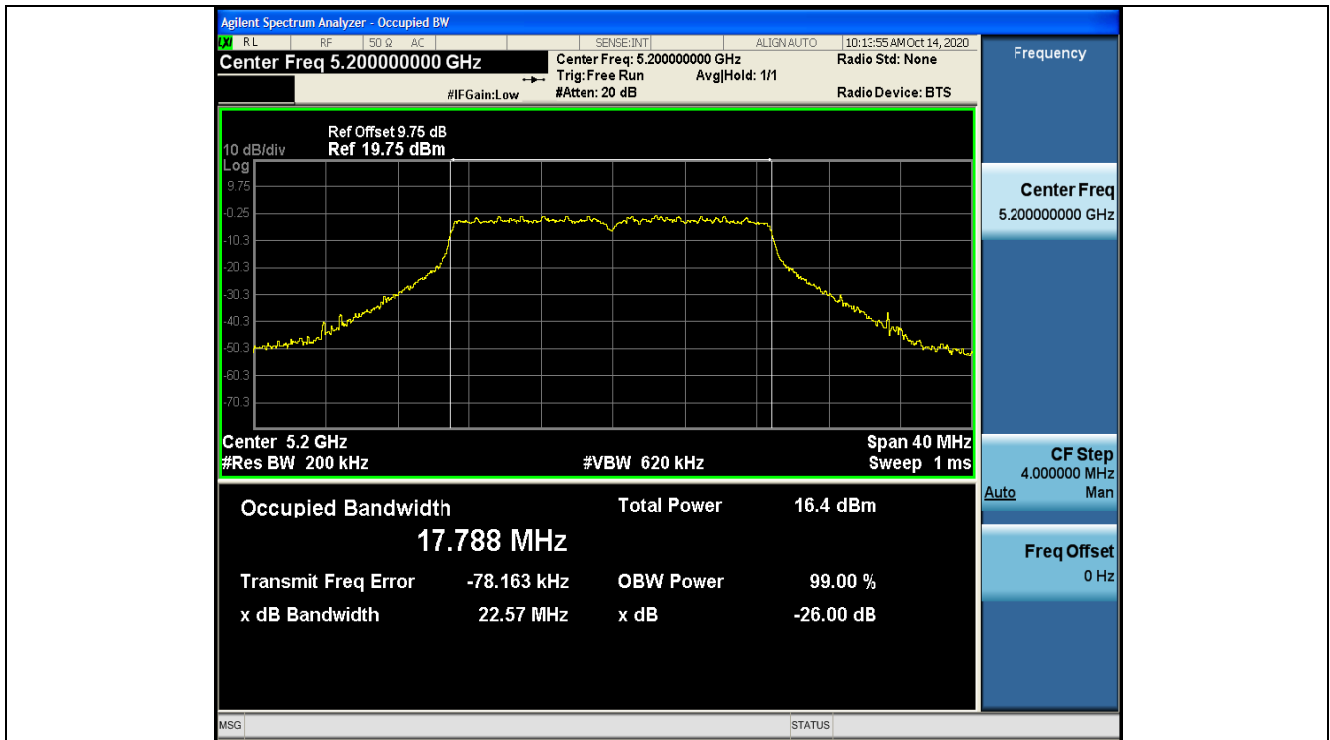

Mid

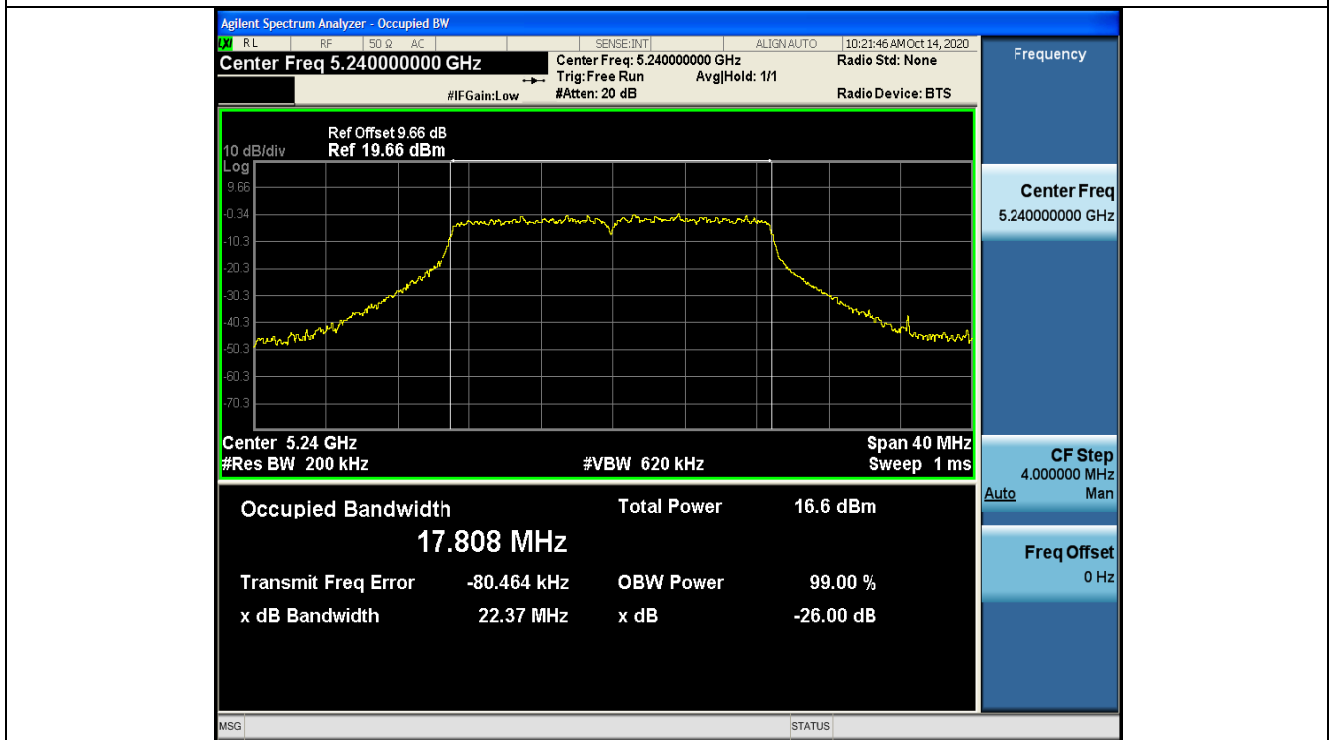

High



802.11n(HT40)

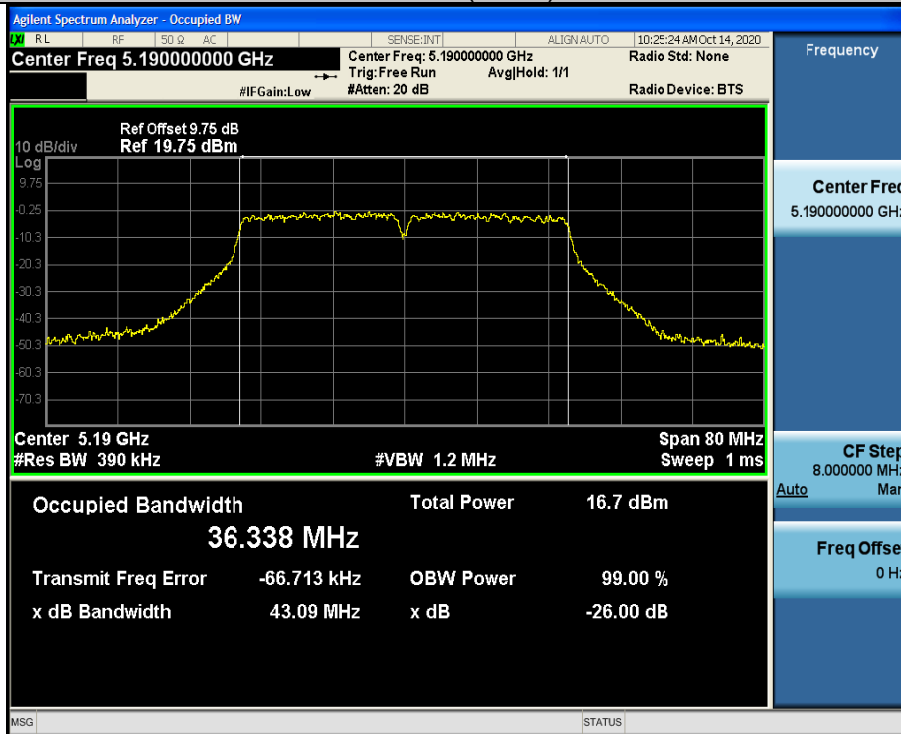

Low

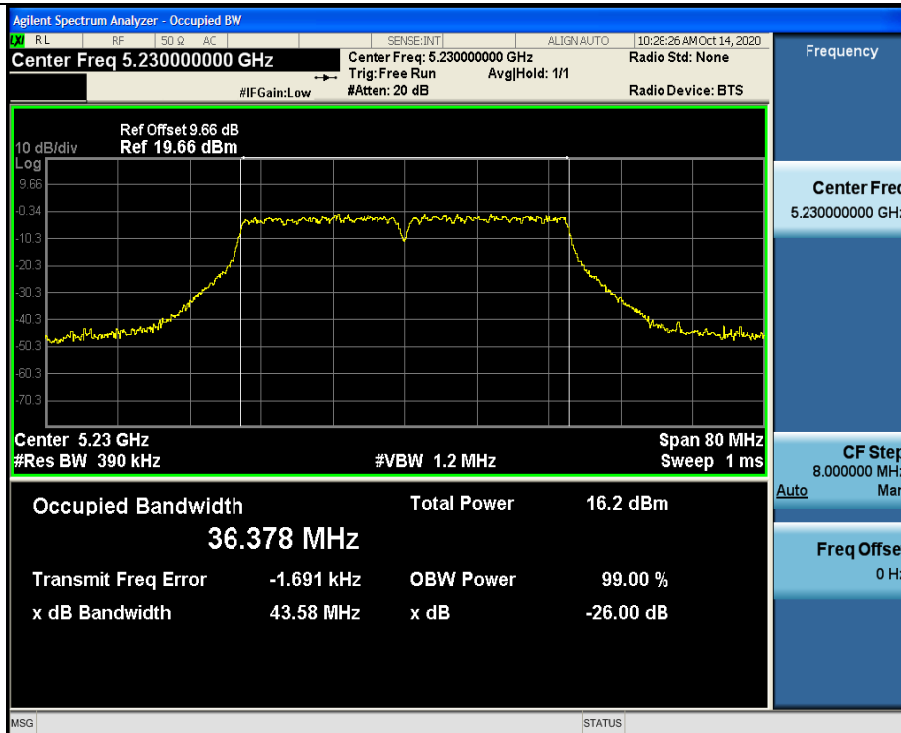

High



802.11ac(HT20)

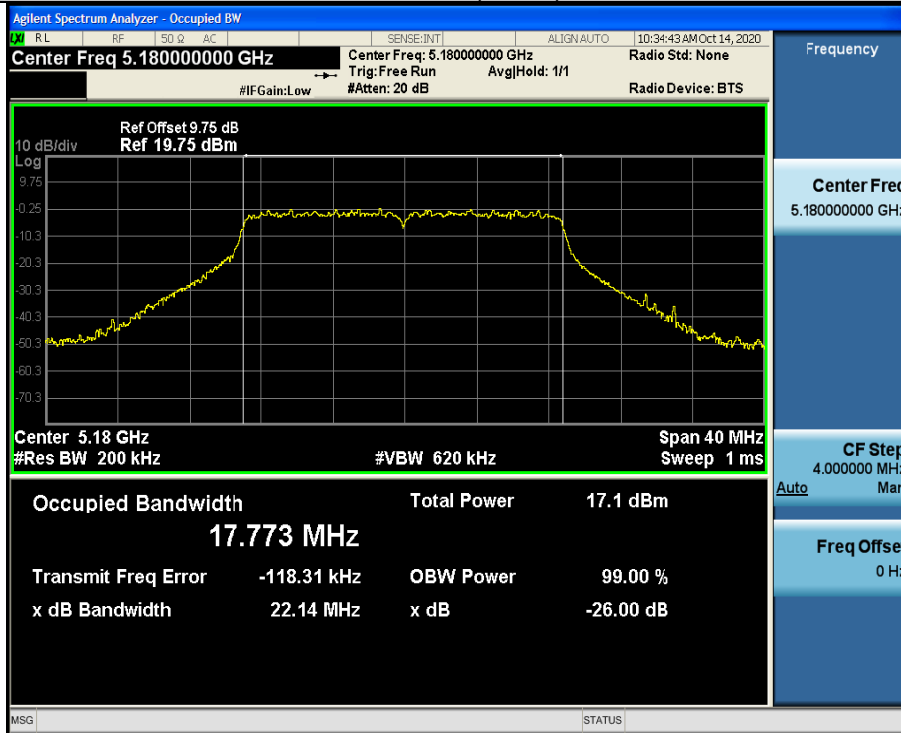

Low



Mid

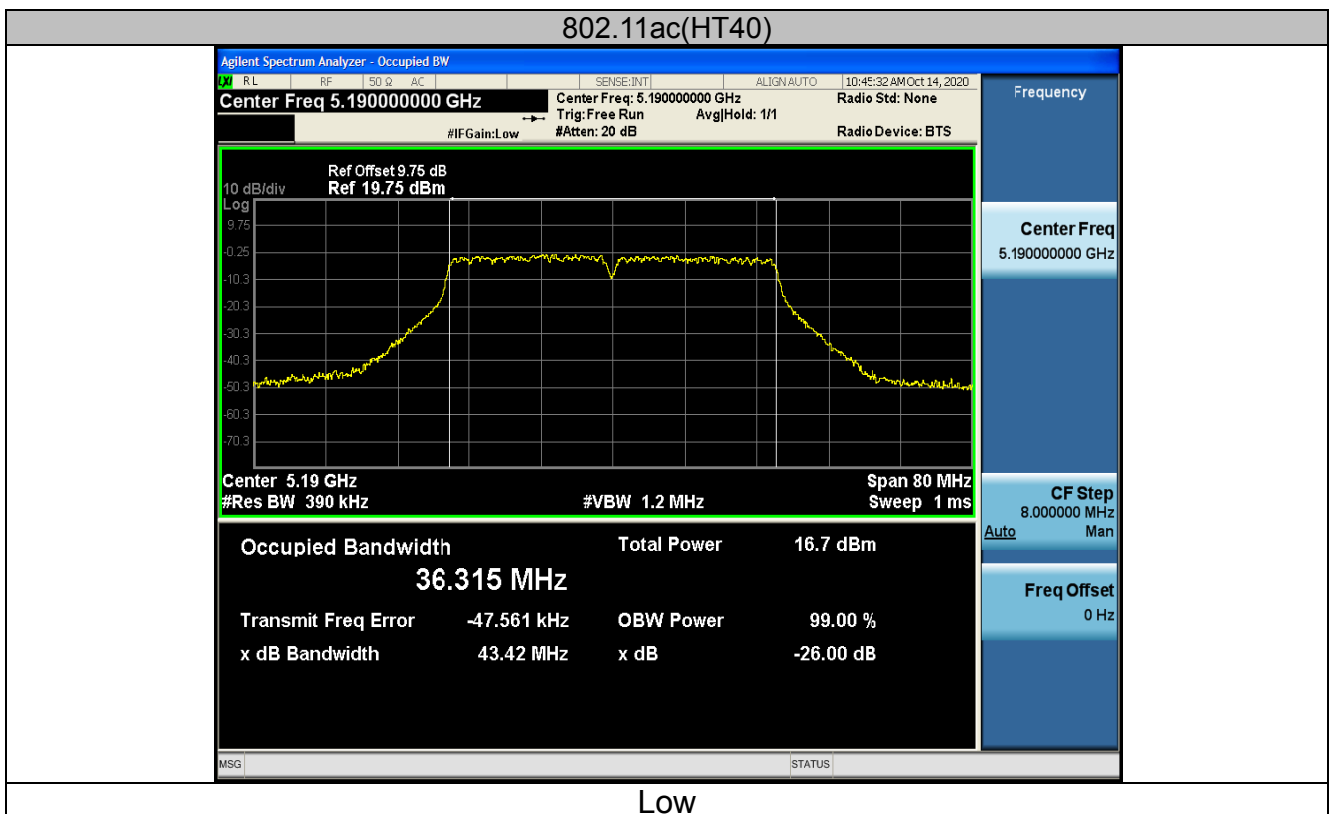
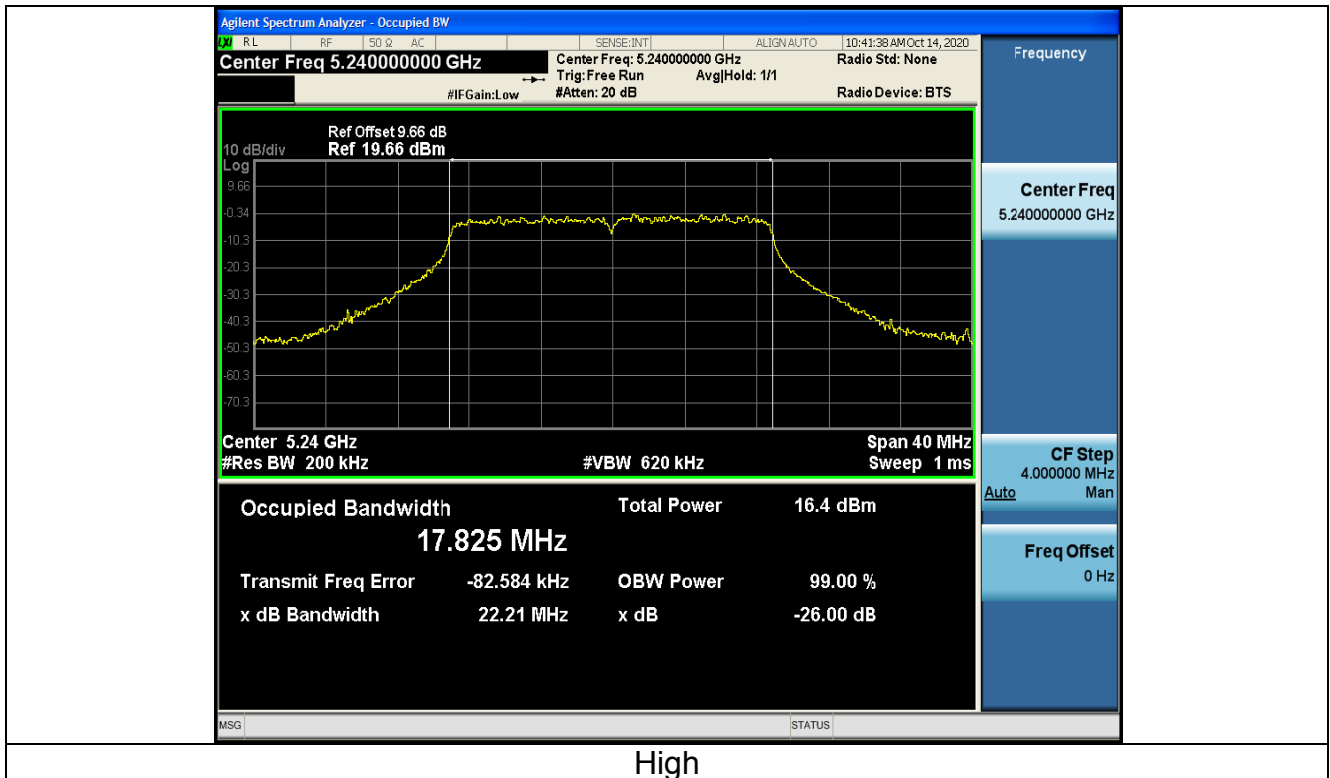

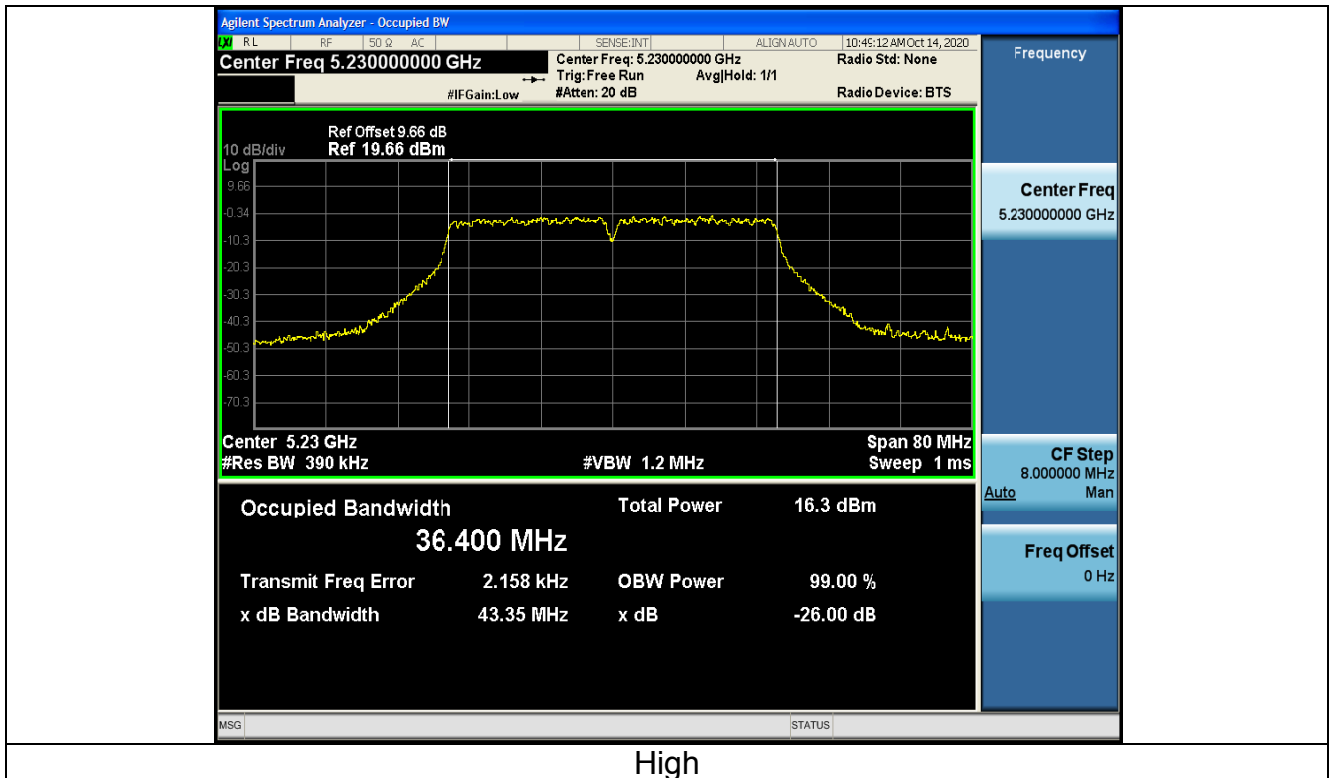

High

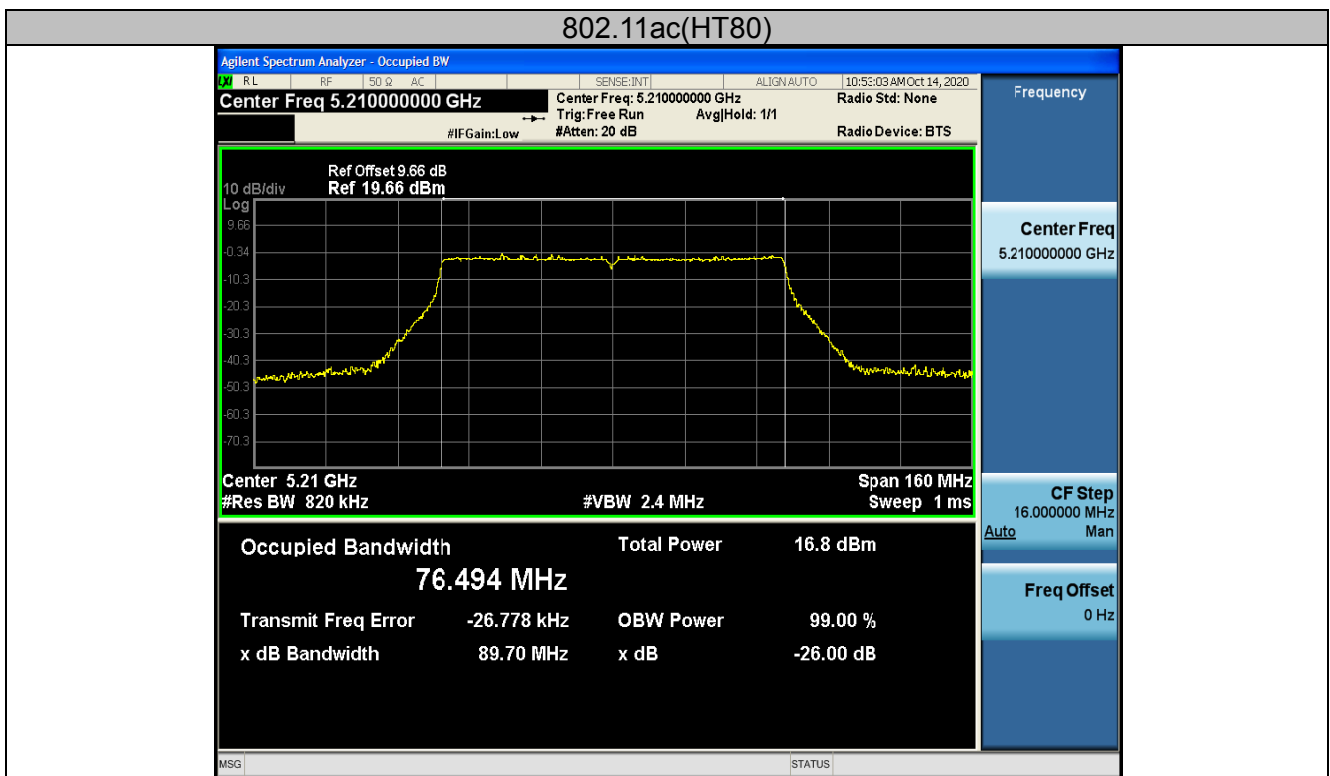

**ANT 2**

Mode	Test channel	Frequency (MHz)	26 dB Bandwidth (MHz)	Verdict
11a	CH36	5180	21.03	PASS
11a	CH40	5200	20.96	PASS
11a	CH48	5240	21.37	PASS
11n(HT20)	CH36	5180	22.97	PASS
11n(HT20)	CH40	5200	22.42	PASS
11n(HT20)	CH48	5240	22.86	PASS
11n(HT40)	CH38	5190	43.26	PASS
11n(HT40)	CH46	5230	44.06	PASS
11ac(HT20)	CH36	5180	22.27	PASS
11ac(HT20)	CH40	5200	22.54	PASS
11ac(HT20)	CH48	5240	22.49	PASS
11ac(HT40)	CH38	5190	43.45	PASS
11ac(HT40)	CH46	5230	43.35	PASS
11ac(HT80)	CH42	5210	88.45	PASS

Test plots as follows:



Band I (5150 – 5250 MHz)

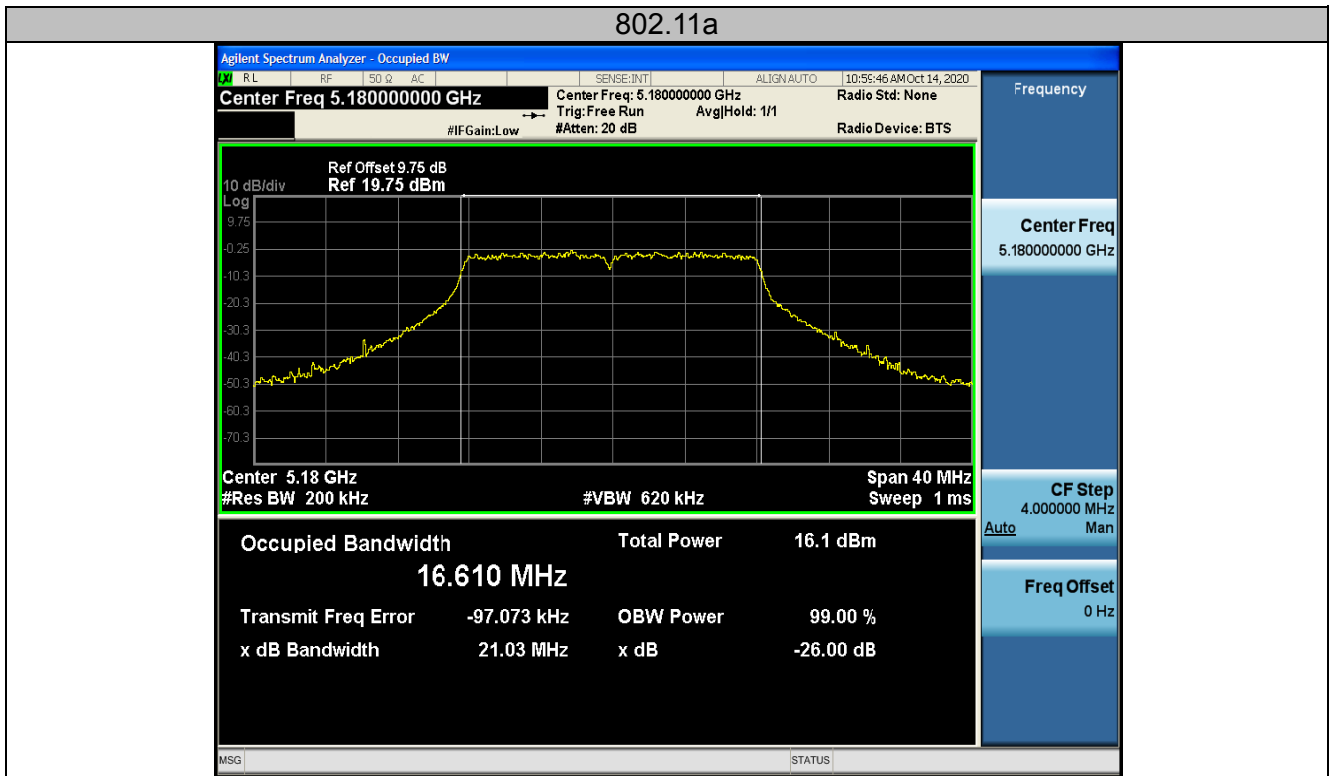

Low

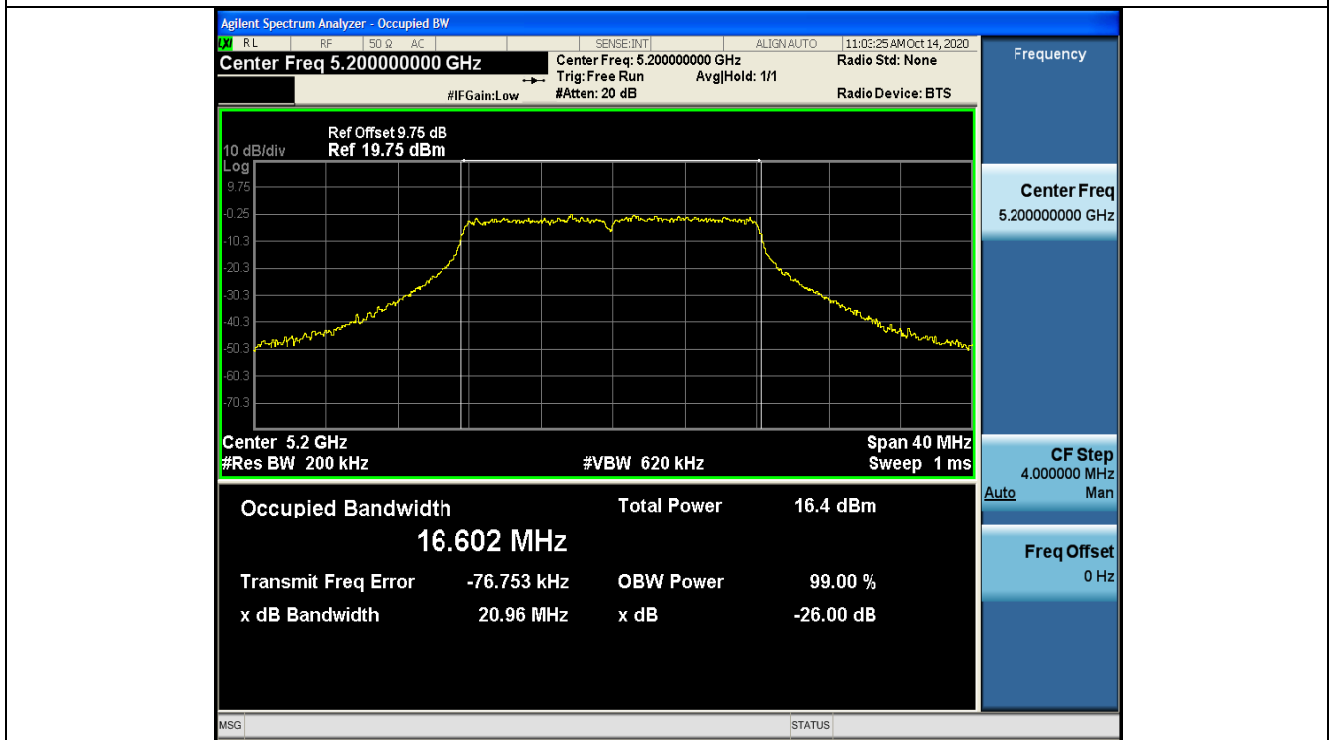

Mid

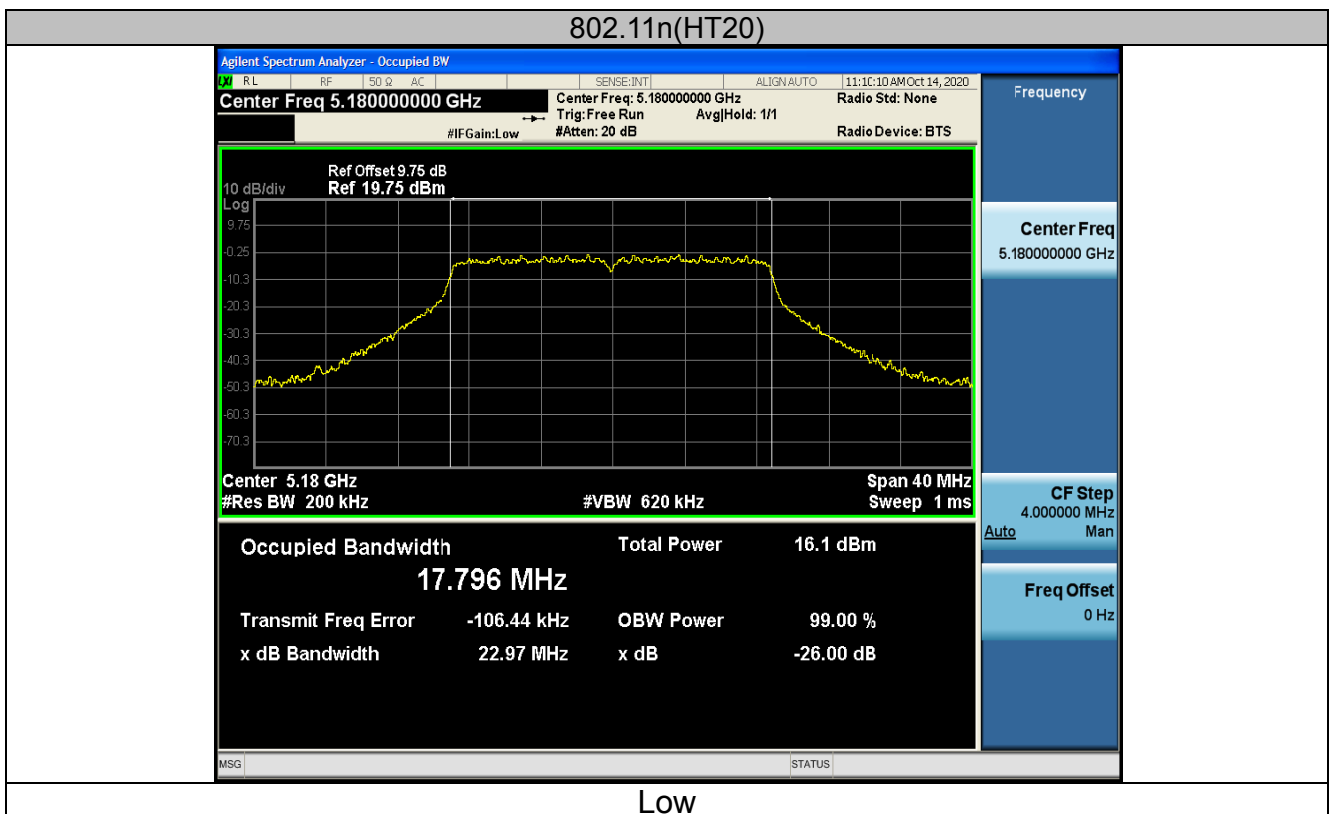
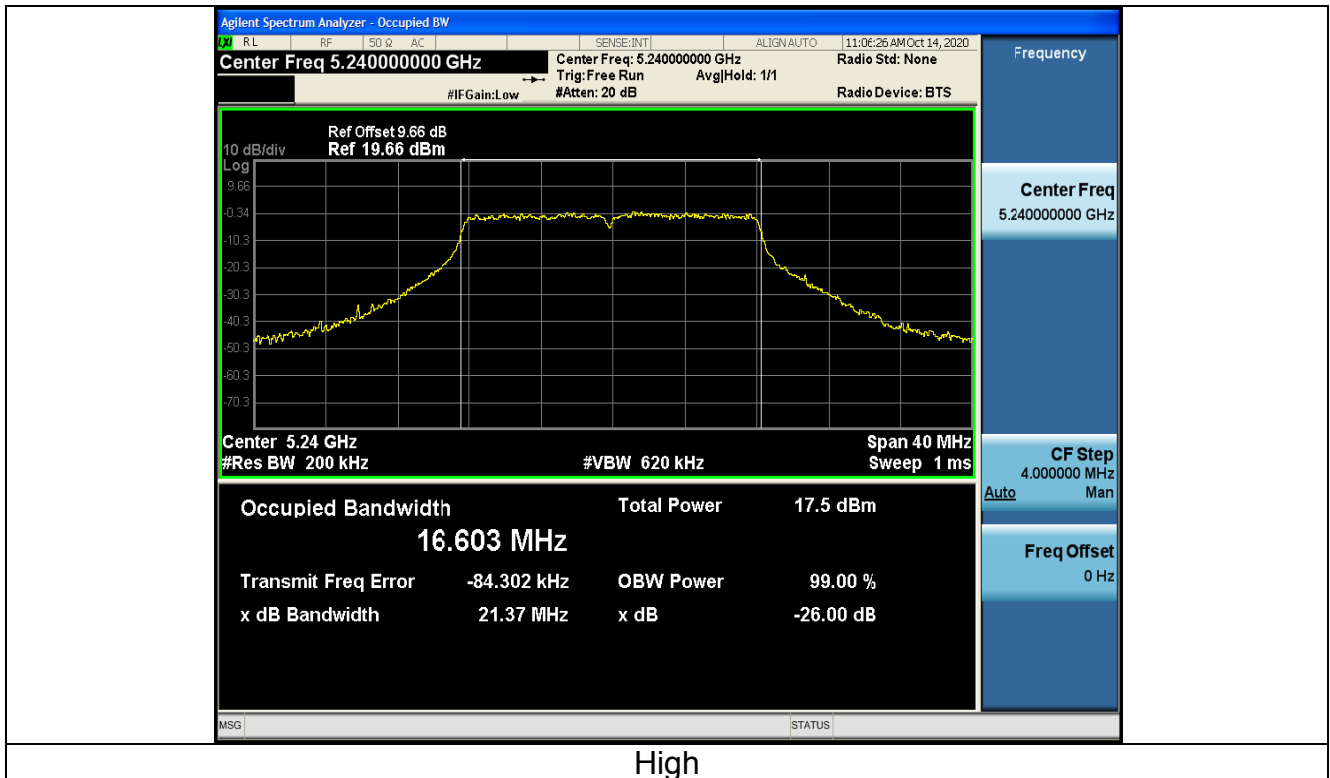

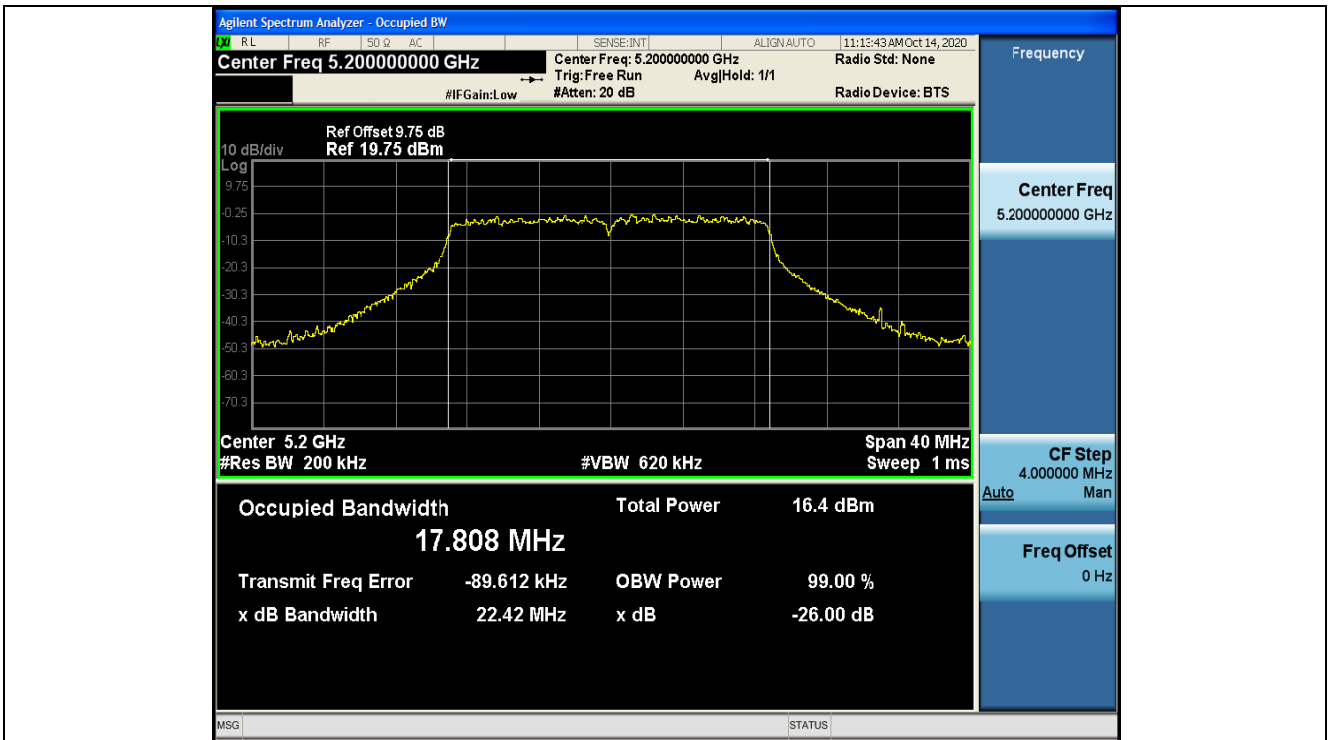

Mid

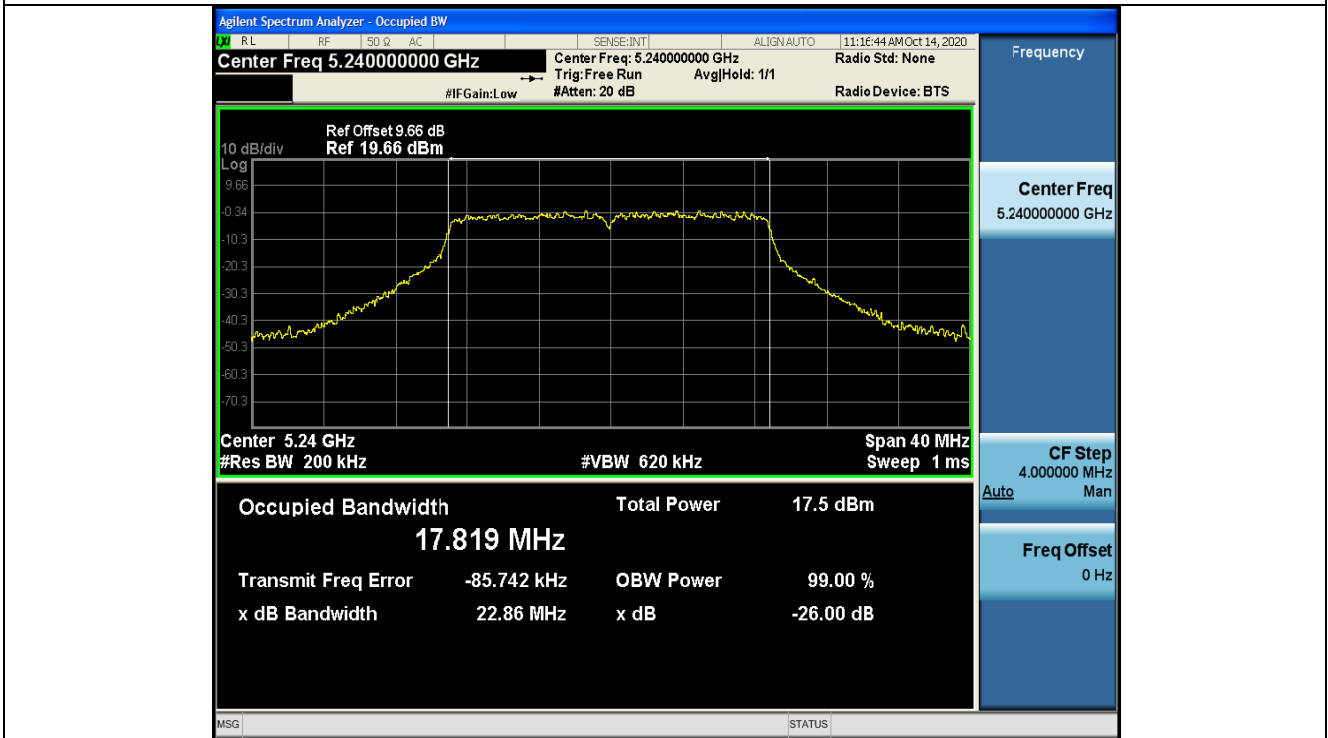

High



802.11n(HT40)

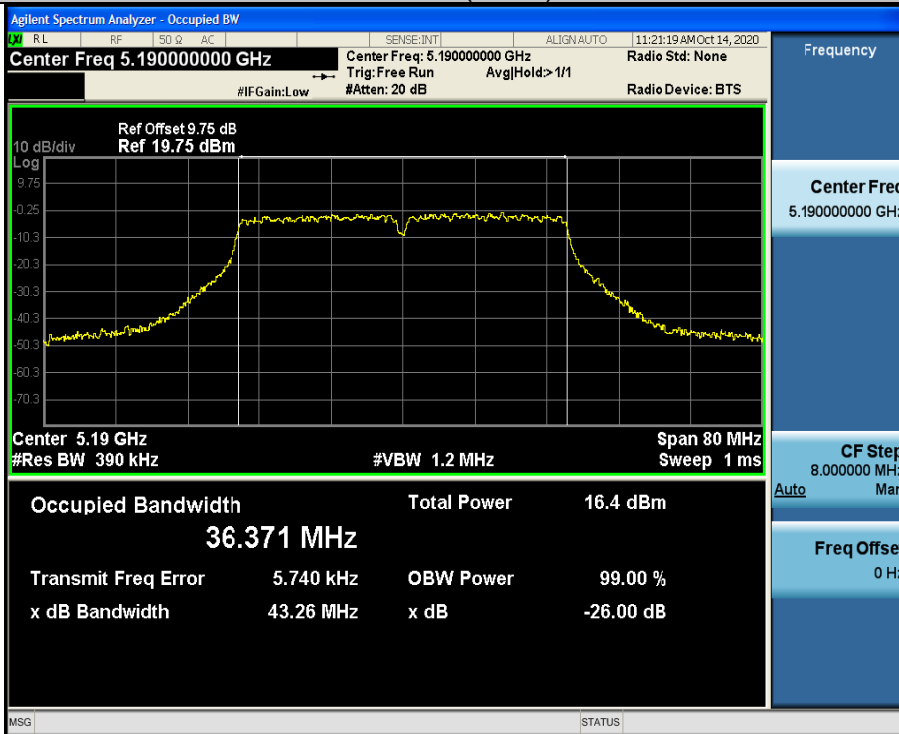

Low

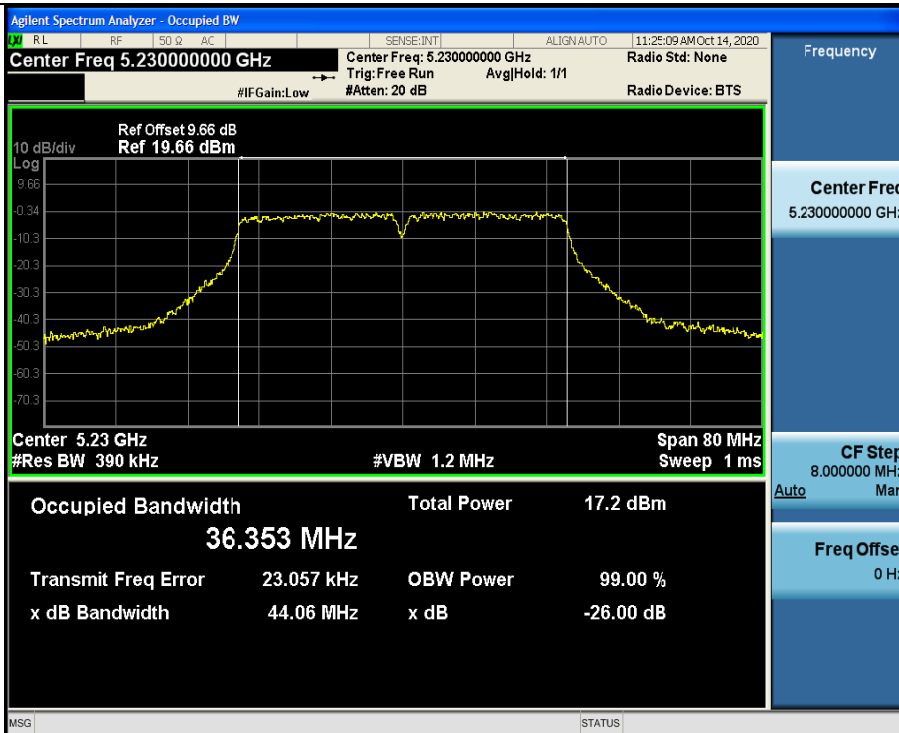

High



802.11ac(HT20)

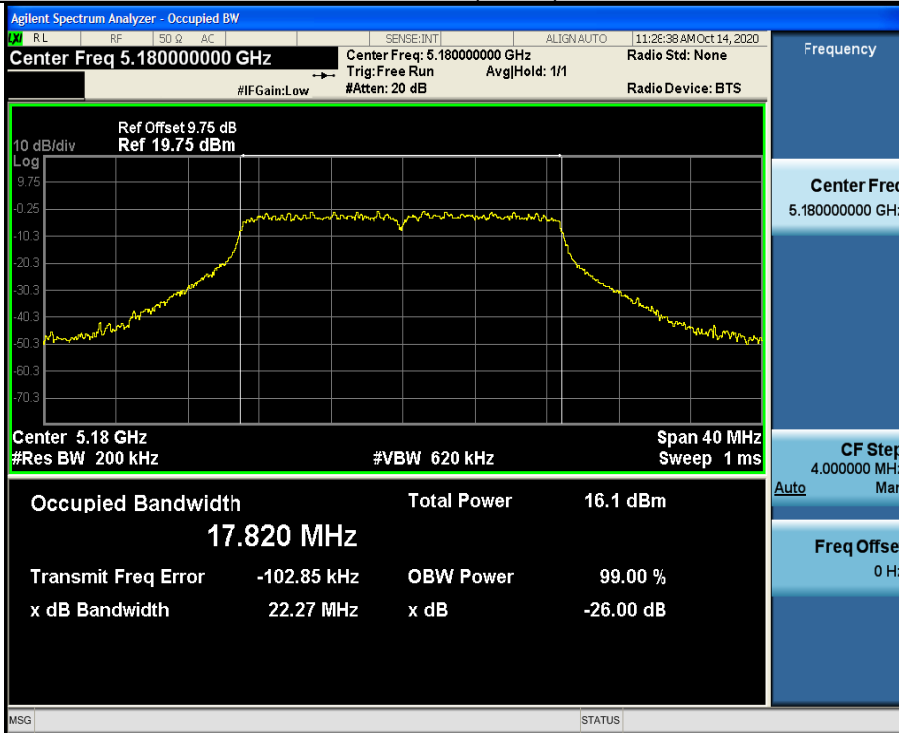

Low

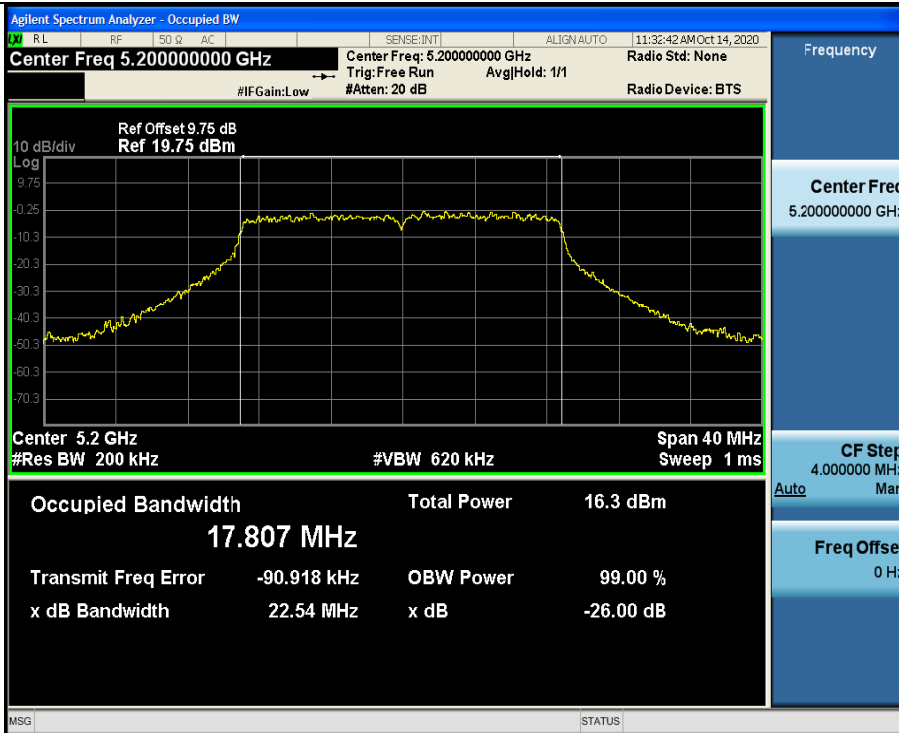

Mid



High

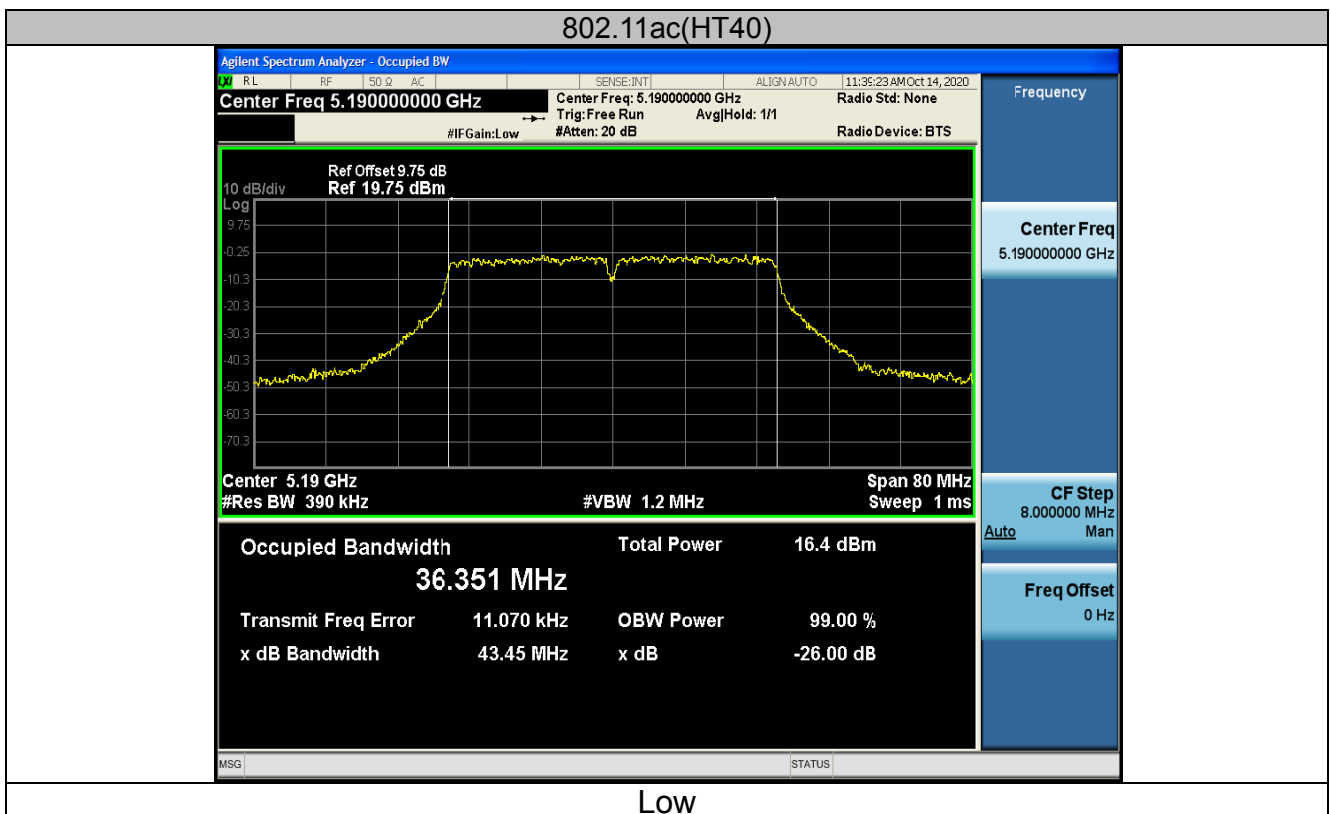

Low

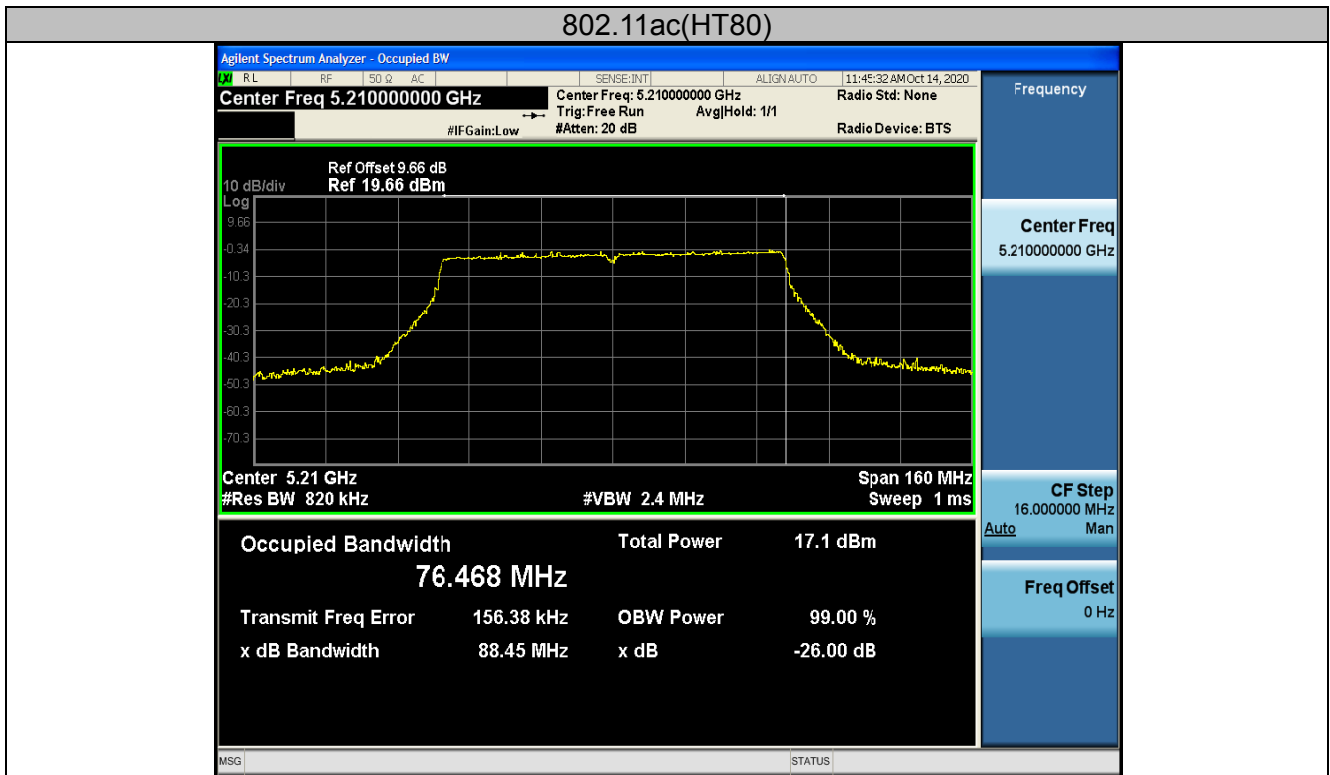



4.5. Power Spectral Density

4.5.1. Test Specification

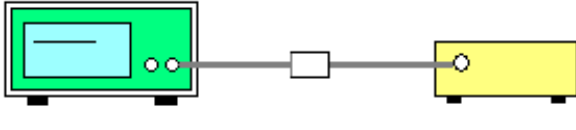
Test Requirement:	FCC Part15 E Section 15.407 (a)
Test Method:	KDB789033 D02 General UNII Test Procedures New Rules v02r01 Section F
Limit:	≤11.00dBm/MHz for Band I 5150MHz-5250MHz ≤17dBm/MHz for indoor access device
Test Setup:	 <p style="text-align: center;">Spectrum Analyzer EUT</p>
Test Mode:	Transmitting mode with modulation
Test Procedure:	<ol style="list-style-type: none"> 1. Set the spectrum analyzer or EMI receiver span to view the entire emission bandwidth. 1. Set RBW = 1MHz, VBW ≥ 3*RBW, Sweep time = Auto, Detector = RMS. 2. Allow the sweeps to continue until the trace stabilizes. 3. Use the peak marker function to determine the maximum amplitude level. 4. The E.I.R.P spectral density used radiated test method. At a test site that has been validated using the procedures of ANSI C63.4 or the latest CISPR 16-1-4 for measurements above 1 GHz, so as to simulate a near free-space environment.
Test Result:	PASS

4.5.2. Test Instruments

RF Test Room					
Equipment	Manufacturer	Model	Serial Number	Calibration Date	Calibration Due
Spectrum analyzer	Agilent	N9020A	HKE-048	Dec. 26, 2019	Dec. 25, 2020
RF cable	Times	1-40G	HKE-034	Dec. 26, 2019	Dec. 25, 2020
RF automatic control unit	Tonscend	JS0806-2	HKE-060	Dec. 26, 2019	Dec. 25, 2020

Note: The calibration interval of the above test instruments is 12 months and the calibrations are traceable to international system unit (SI).



4.5.3. Test data

ANT 1

Configuration Band I (5150 - 5250 MHz)

Mode	Test channel	Level [dBm/MHz]	Limit (dBm/MHz)	Result
11a	CH36	5.35	17	PASS
11a	CH40	4.10	17	PASS
11a	CH48	4.17	17	PASS
11n(HT20)	CH36	5.52	17	PASS
11n(HT20)	CH40	4.59	17	PASS
11n(HT20)	CH48	5.33	17	PASS
11n(HT40)	CH38	1.19	17	PASS
11n(HT40)	CH46	0.51	17	PASS
11ac(HT20)	CH36	5.17	17	PASS
11ac(HT20)	CH40	4.78	17	PASS
11ac(HT20)	CH48	5.50	17	PASS
11ac(HT40)	CH38	0.93	17	PASS
11ac(HT40)	CH46	1.26	17	PASS
11ac(HT80)	CH42	-2.32	17	PASS



Test plots as follows:

Band I (5150 – 5250 MHz)

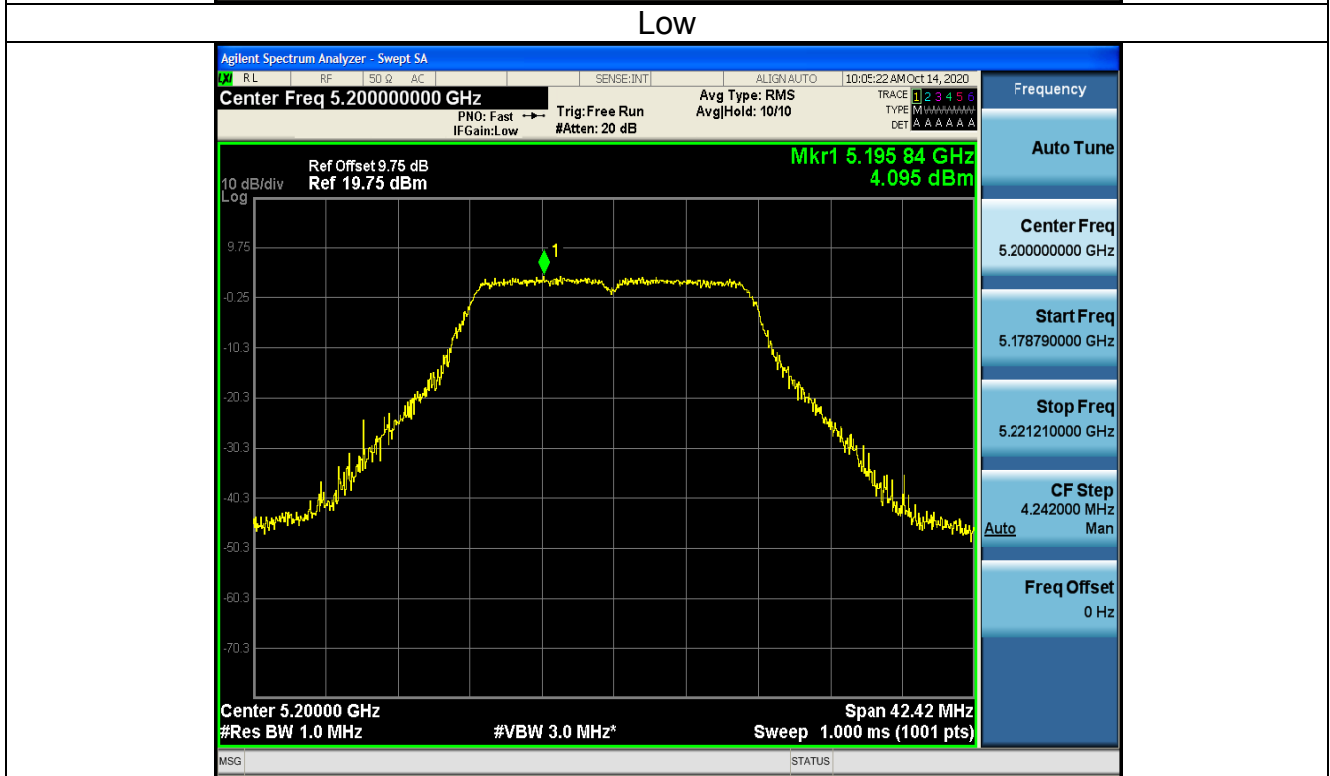
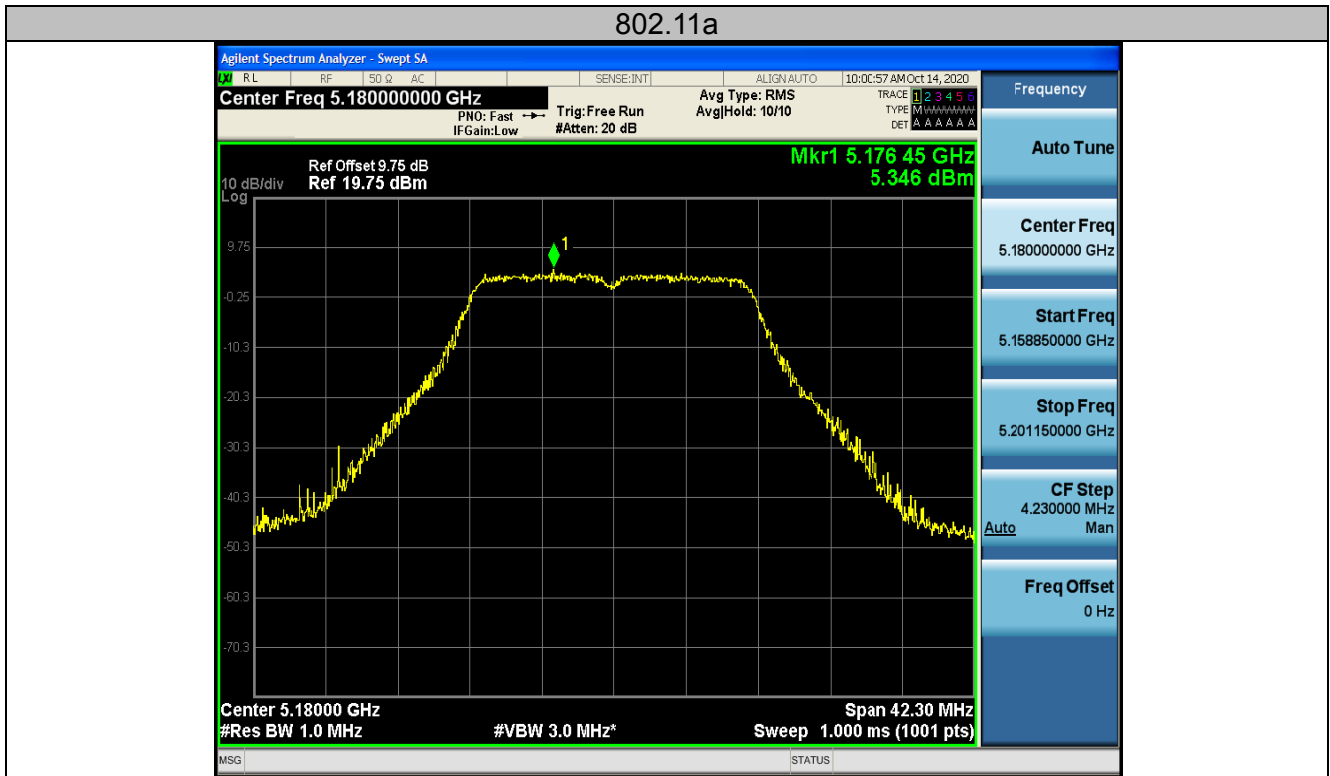

Mid

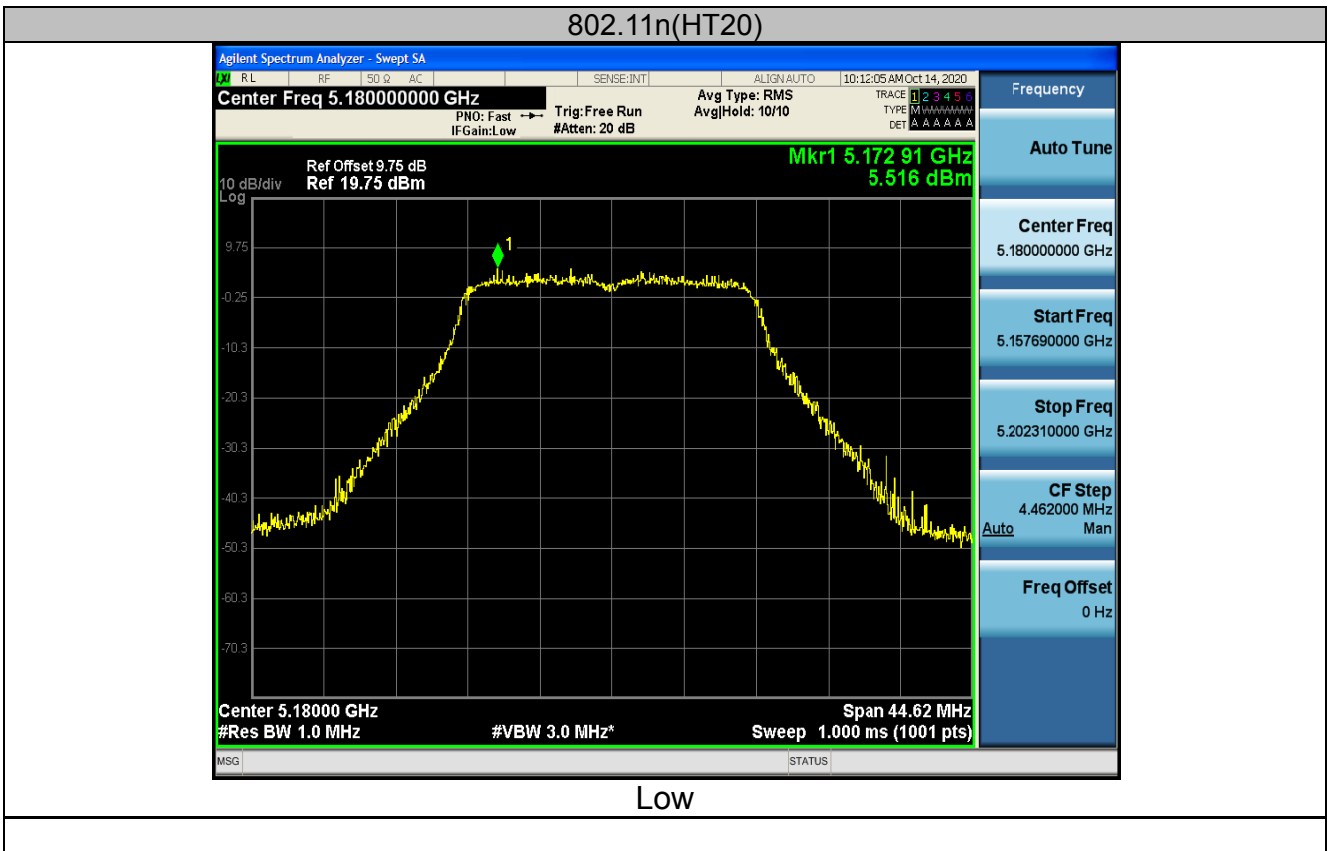
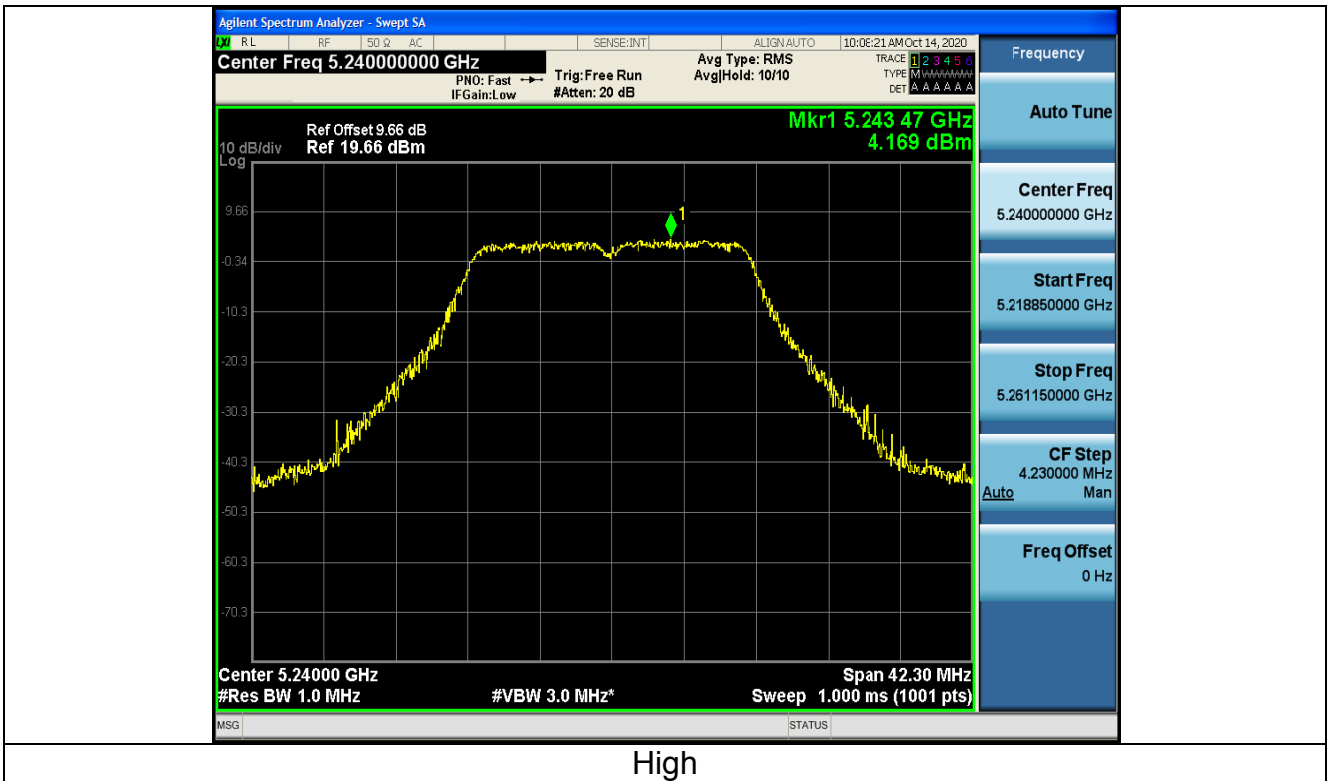

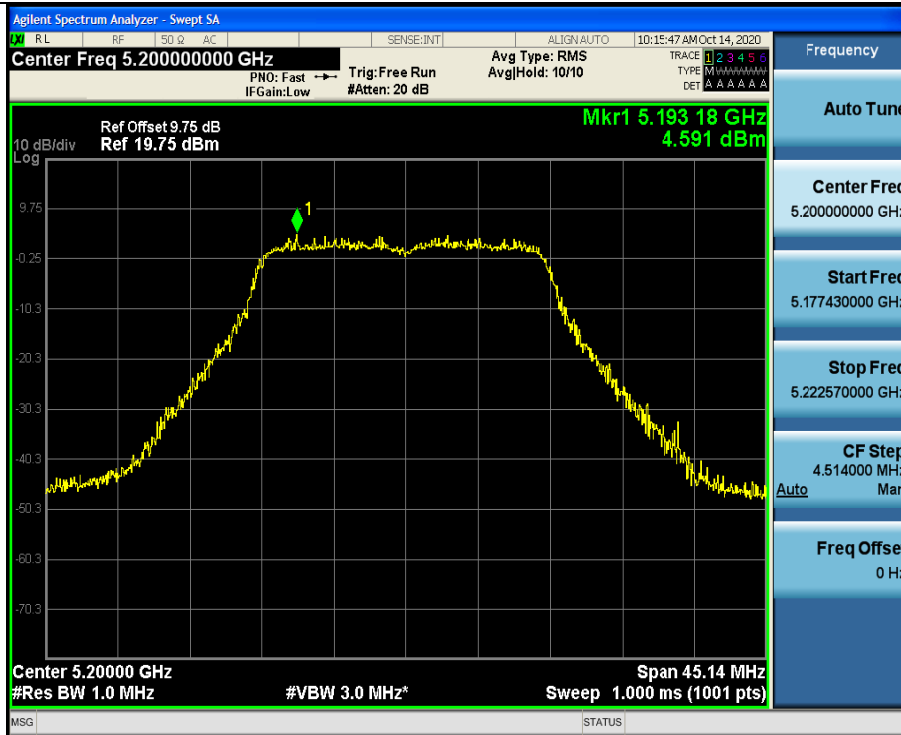

Mid

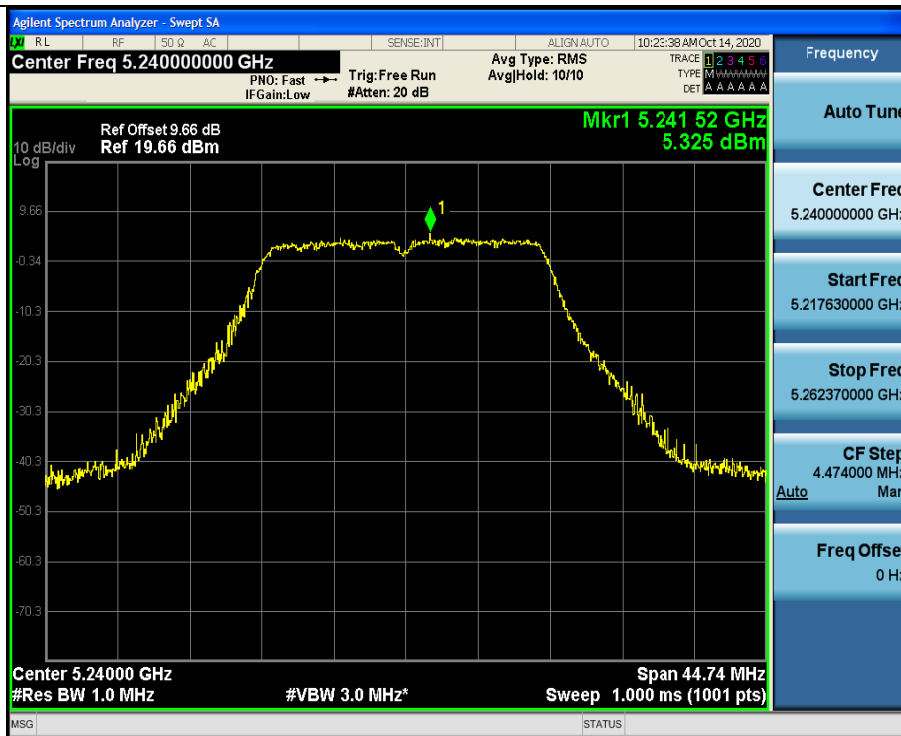

High



802.11n(HT40)

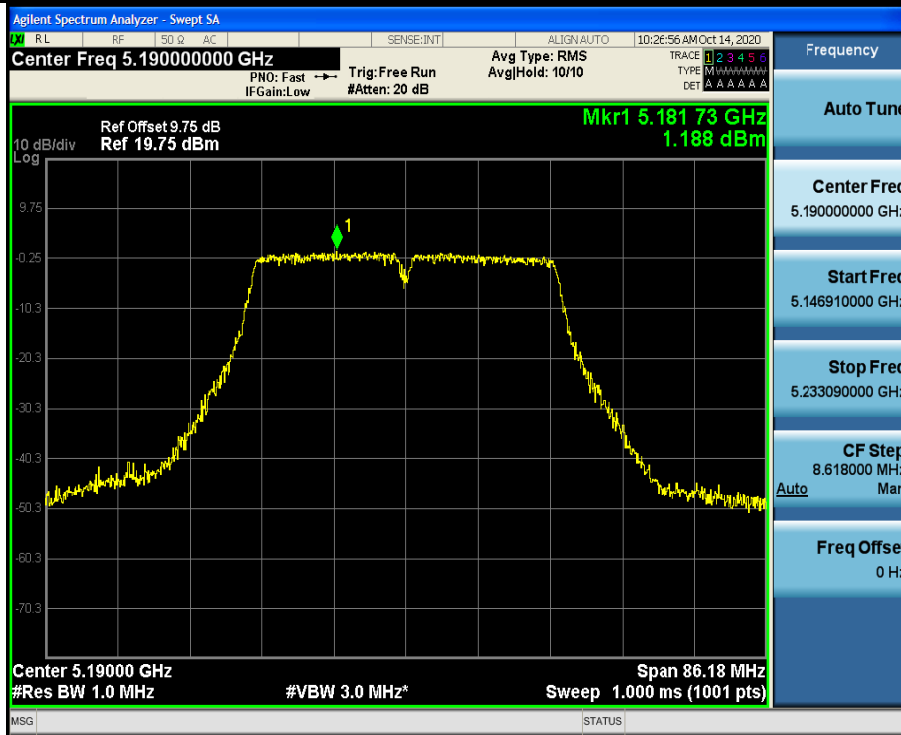

Low

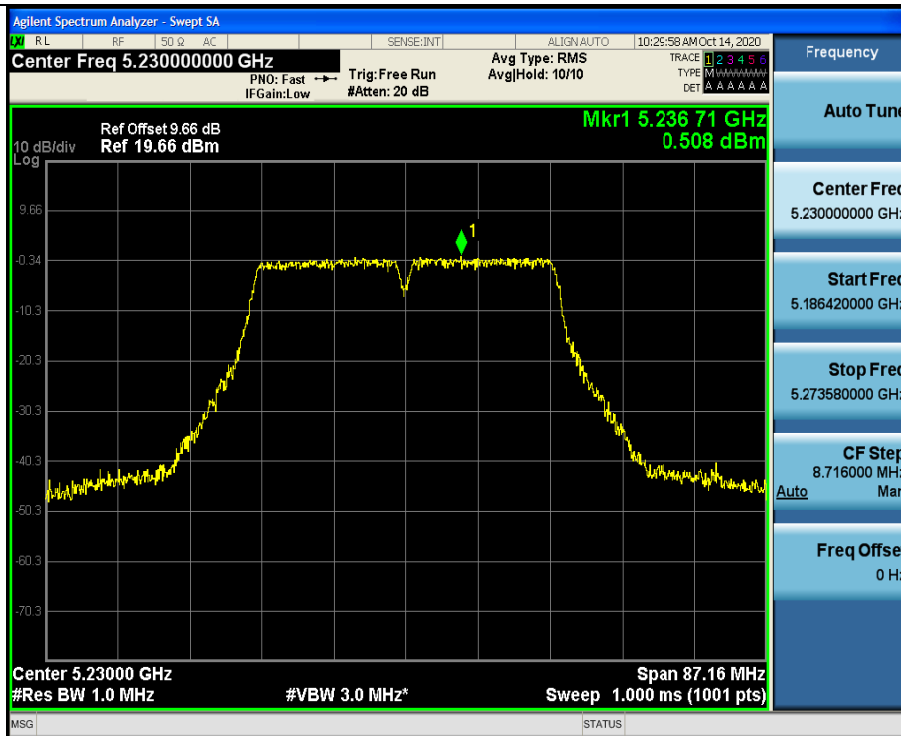

High



802.11ac(HT20)

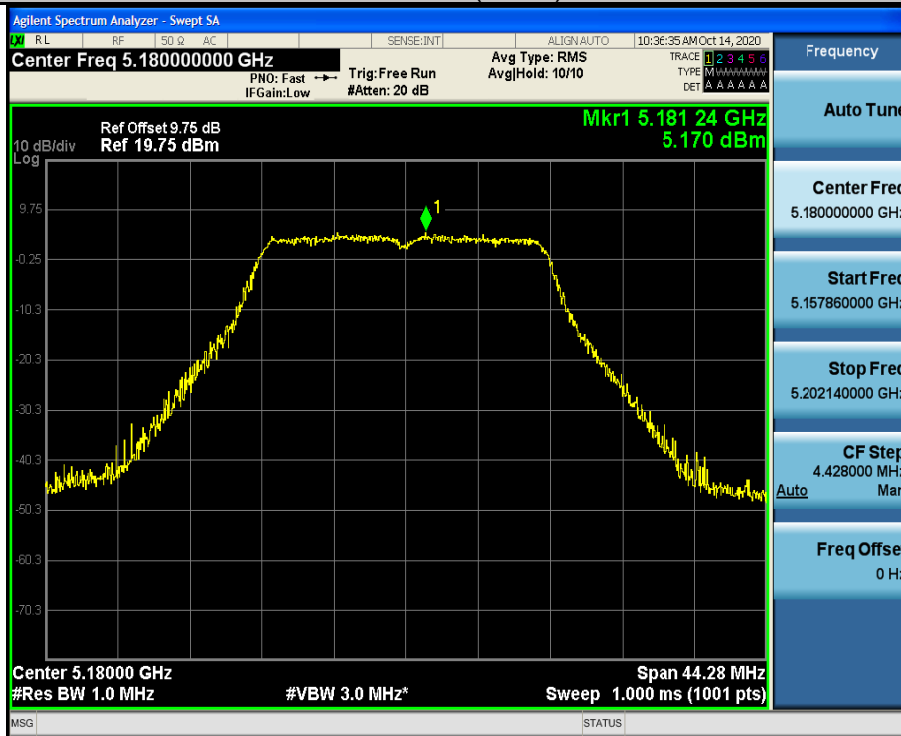

Low

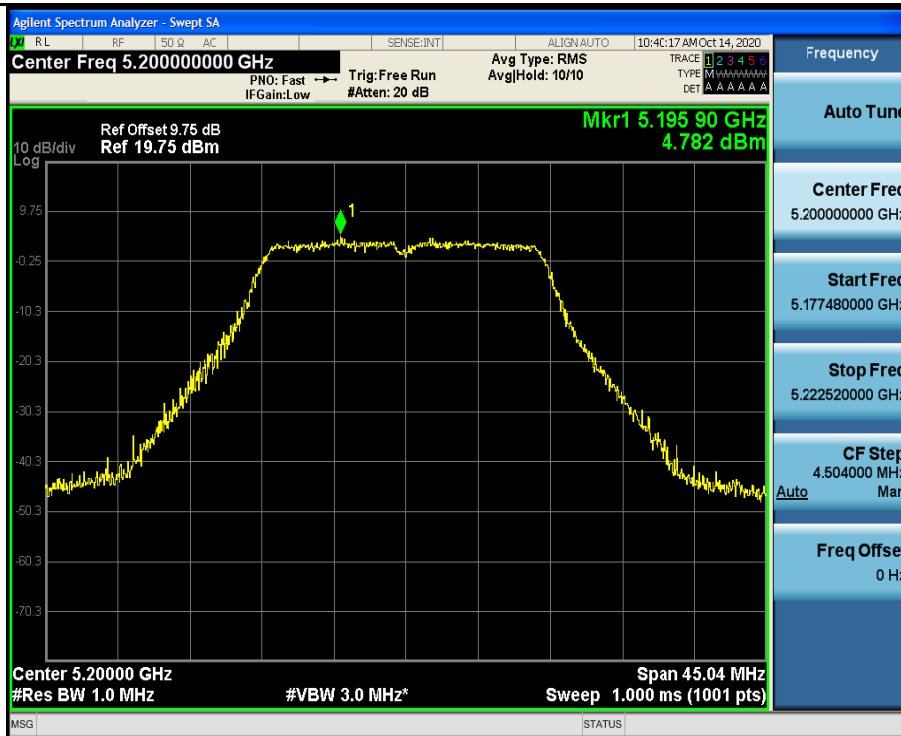

Mid

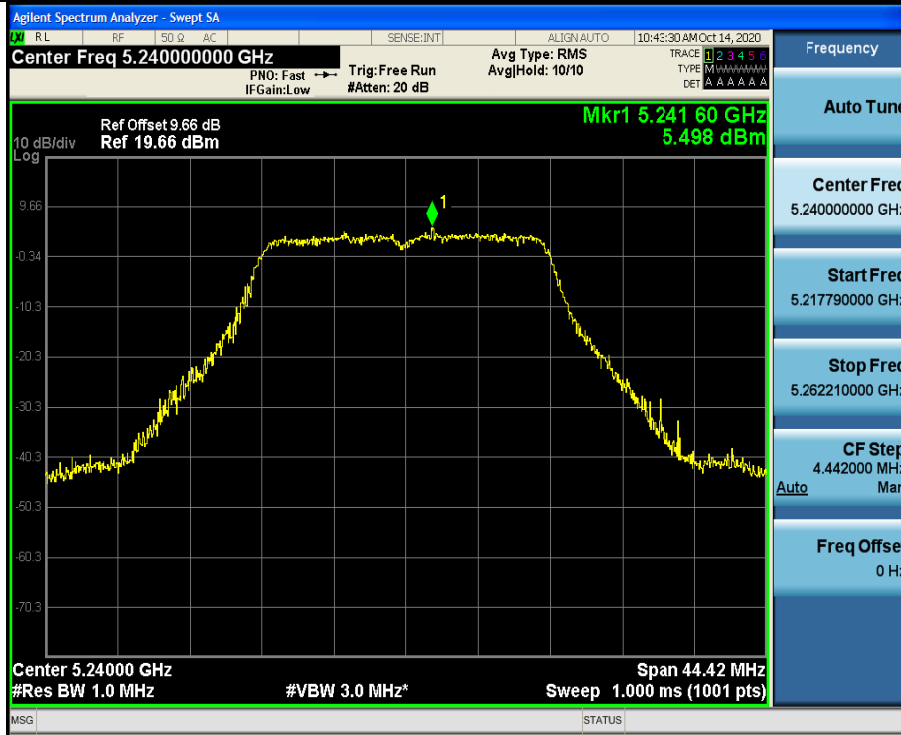

High

802.11ac(HT40)

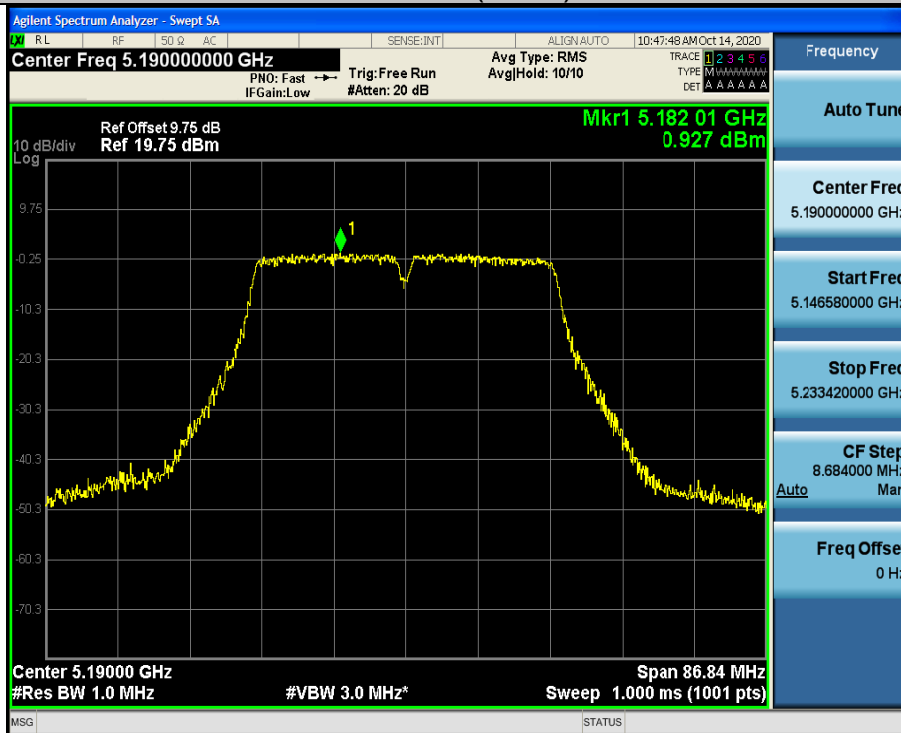

Low

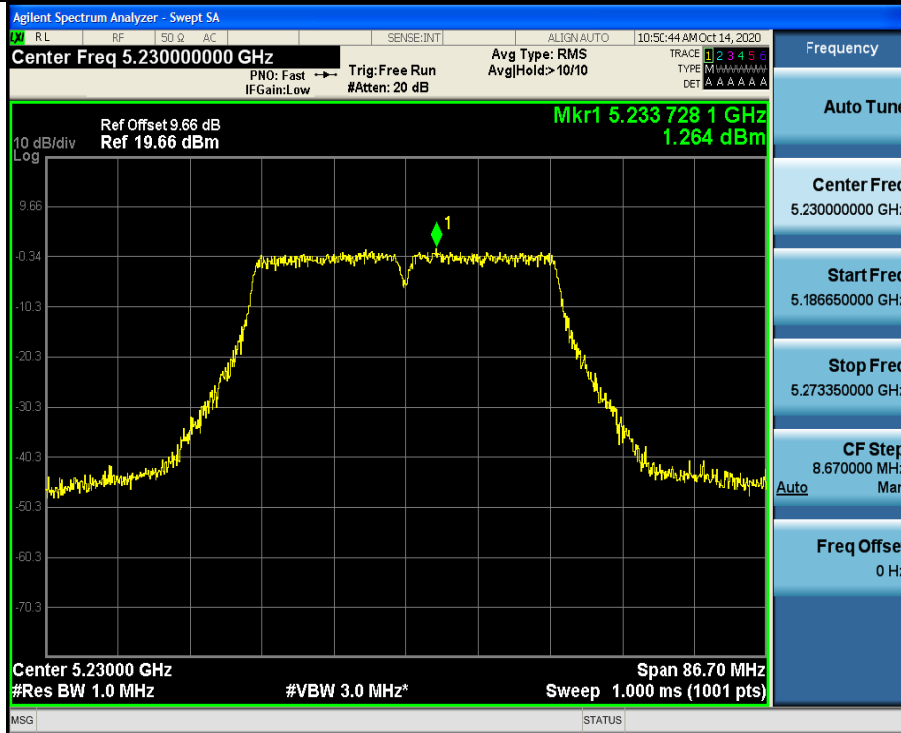

High

802.11ac(HT80)

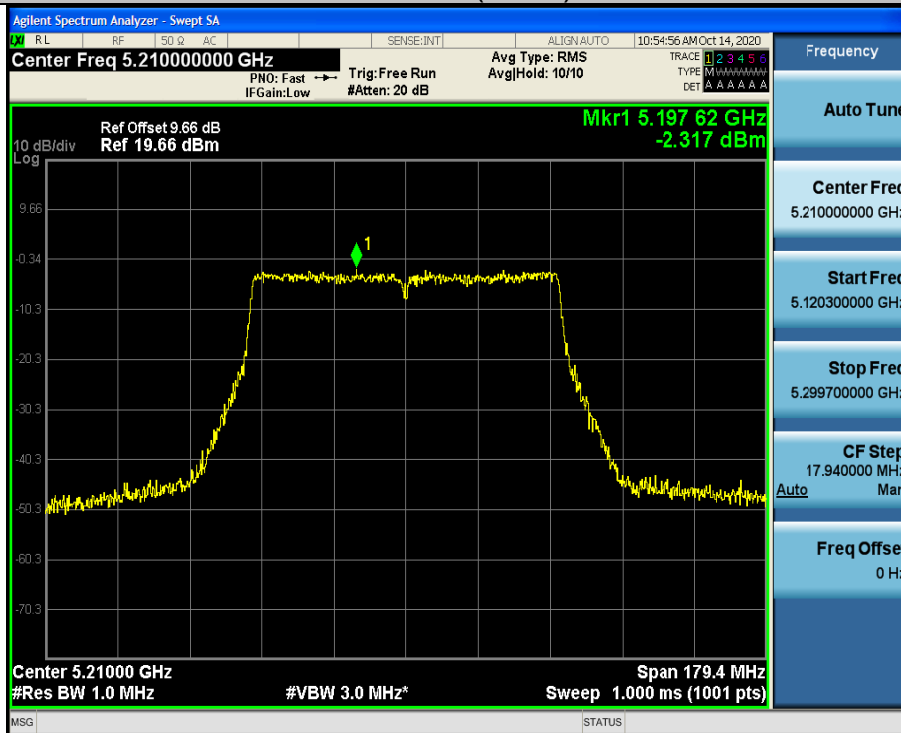

Low



ANT 2

Configuration Band I (5150 - 5250 MHz)

Mode	Test channel	Level [dBm/MHz]	Limit (dBm/MHz)	Result
11a	CH36	5.30	17	PASS
11a	CH40	4.36	17	PASS
11a	CH48	5.43	17	PASS
11n(HT20)	CH36	4.65	17	PASS
11n(HT20)	CH40	4.64	17	PASS
11n(HT20)	CH48	5.58	17	PASS
11n(HT40)	CH38	0.56	17	PASS
11n(HT40)	CH46	1.47	17	PASS
11ac(HT20)	CH36	4.34	17	PASS
11ac(HT20)	CH40	4.45	17	PASS
11ac(HT20)	CH48	5.91	17	PASS
11ac(HT40)	CH38	0.67	17	PASS
11ac(HT40)	CH46	1.42	17	PASS
11ac(HT80)	CH42	-1.67	17	PASS



Test plots as follows:

Band I (5150 – 5250 MHz)

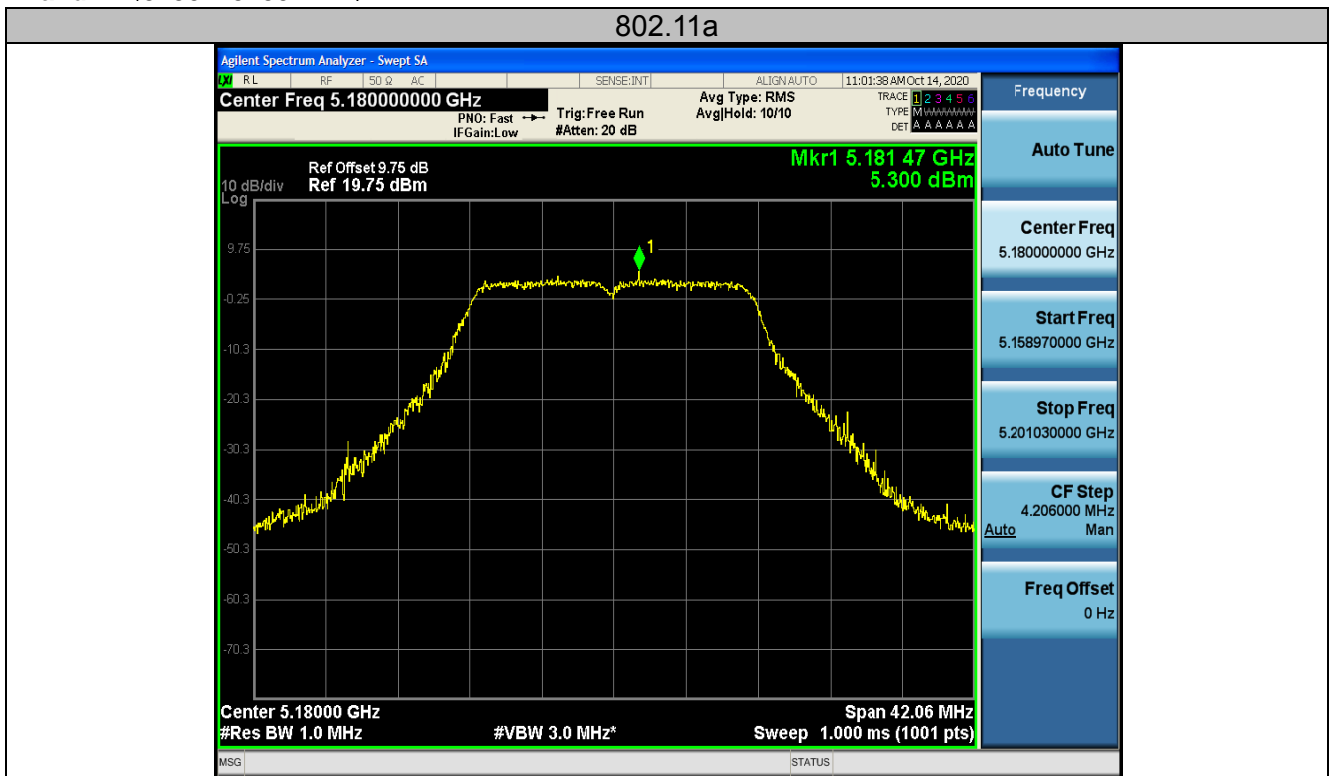

Low

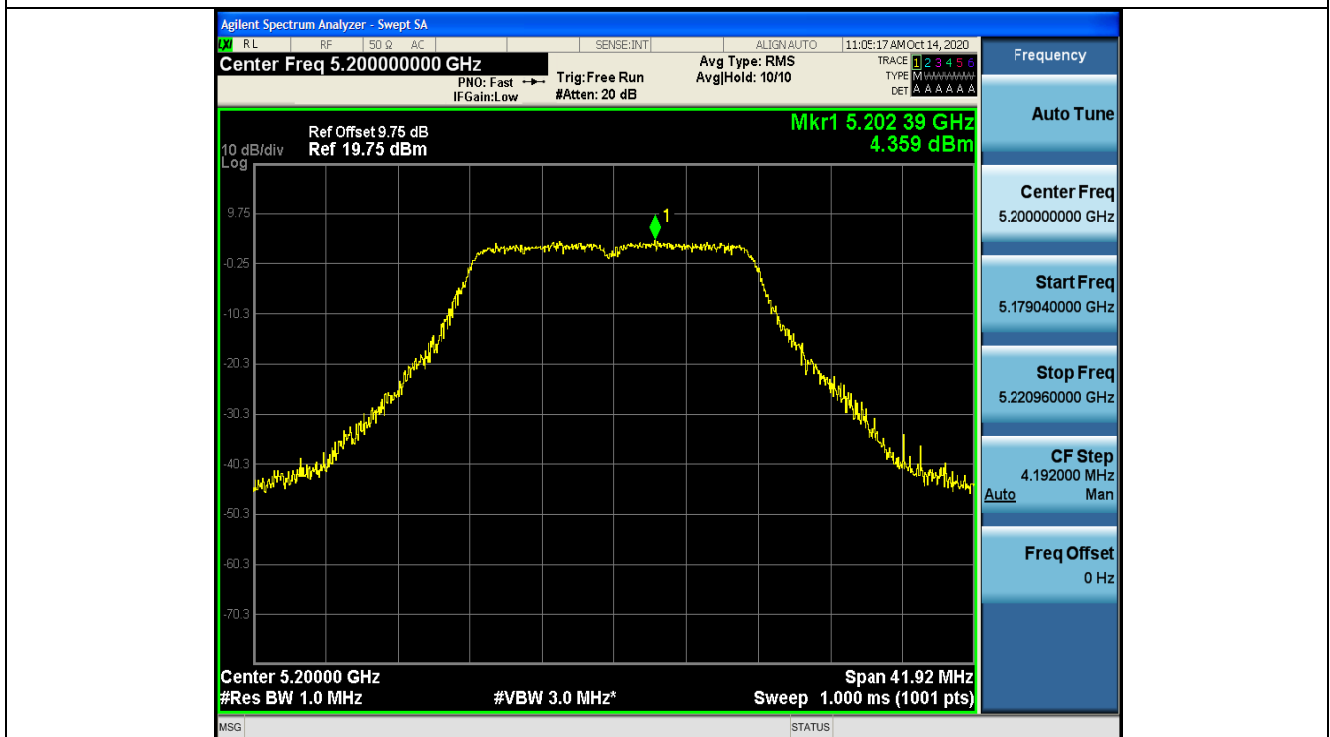

Mid

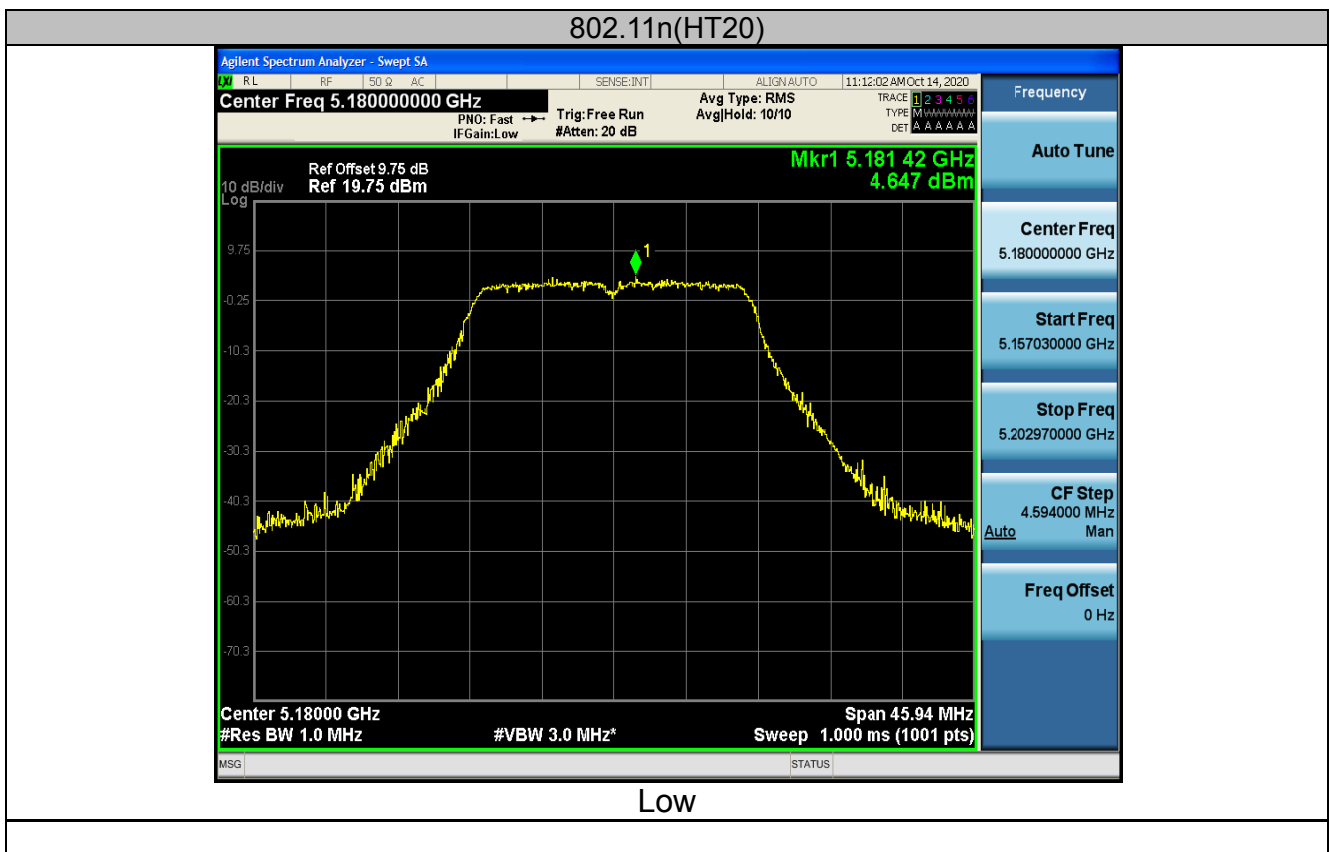
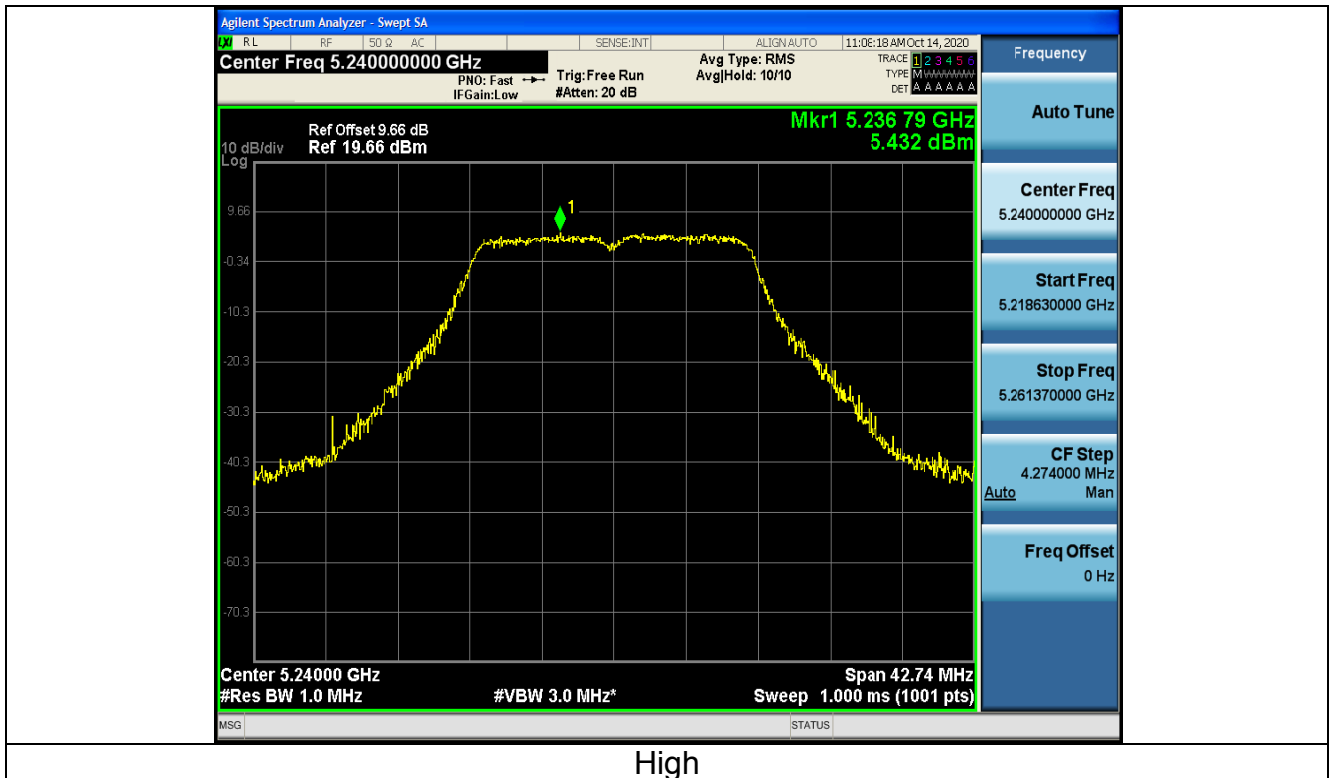

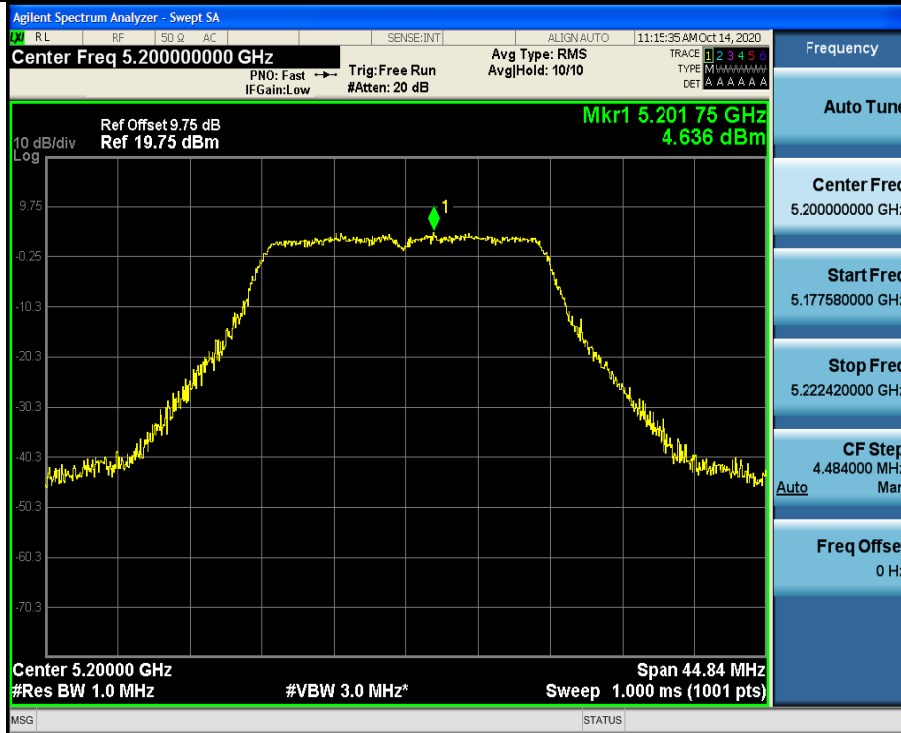

Mid

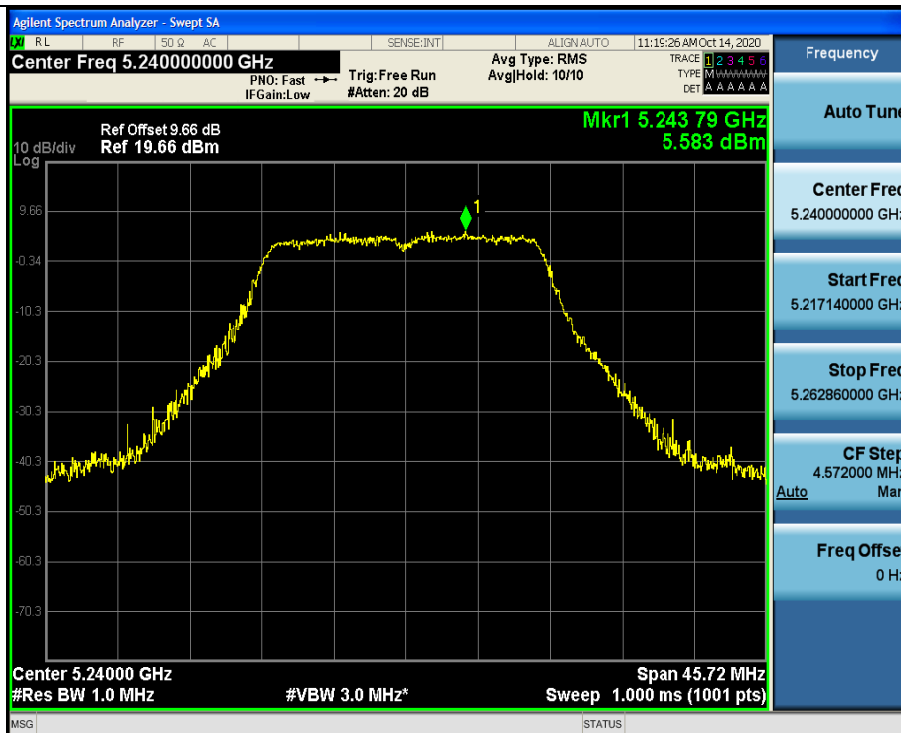

High



802.11n(HT40)

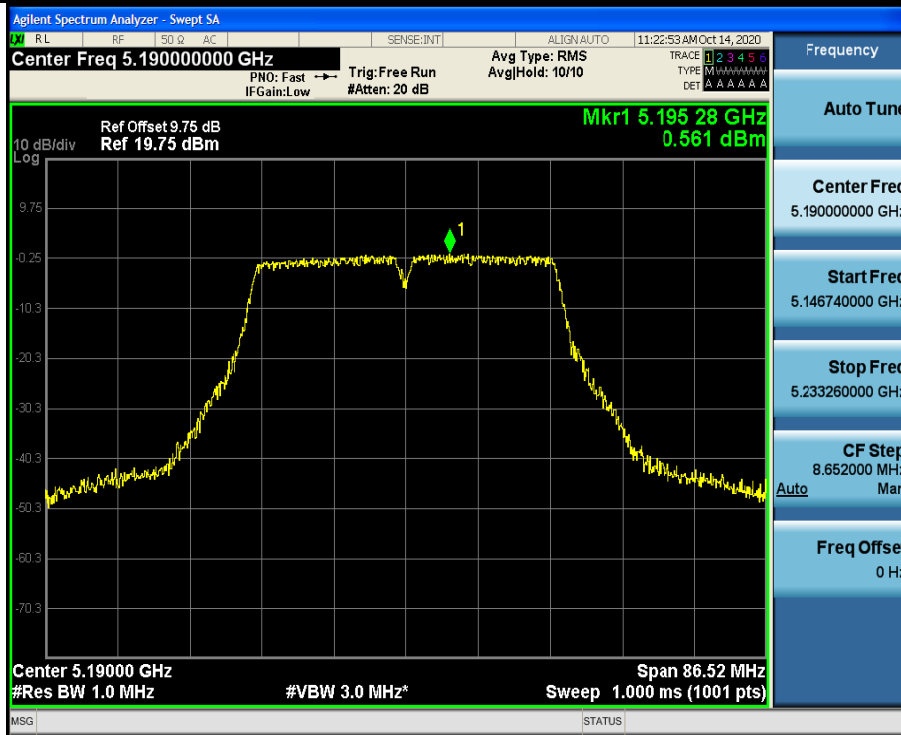

Low

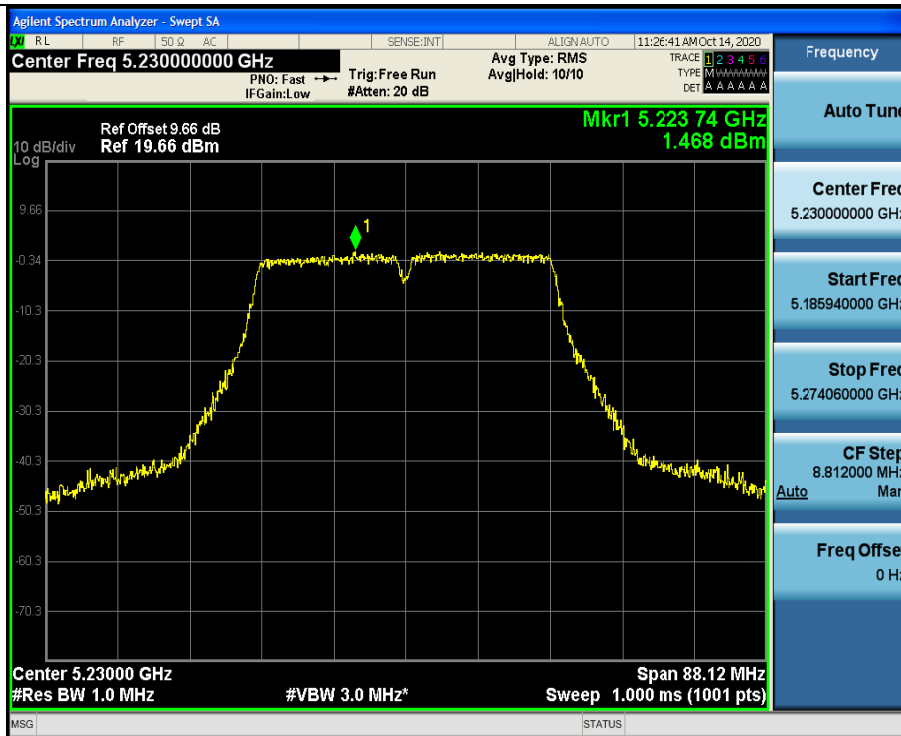

High



802.11ac(HT20)

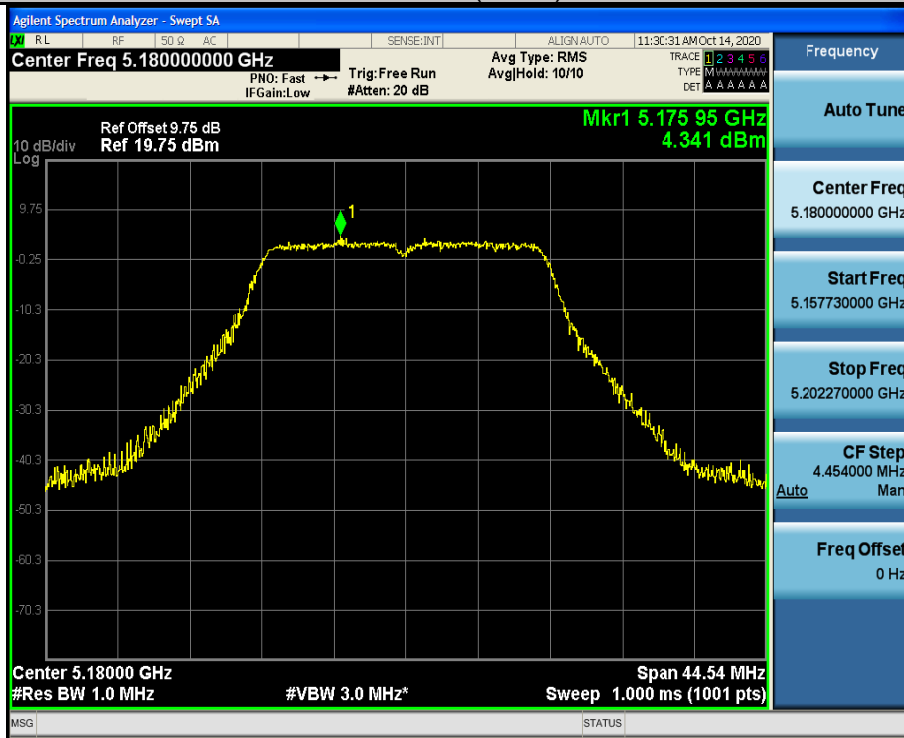

Low



Mid

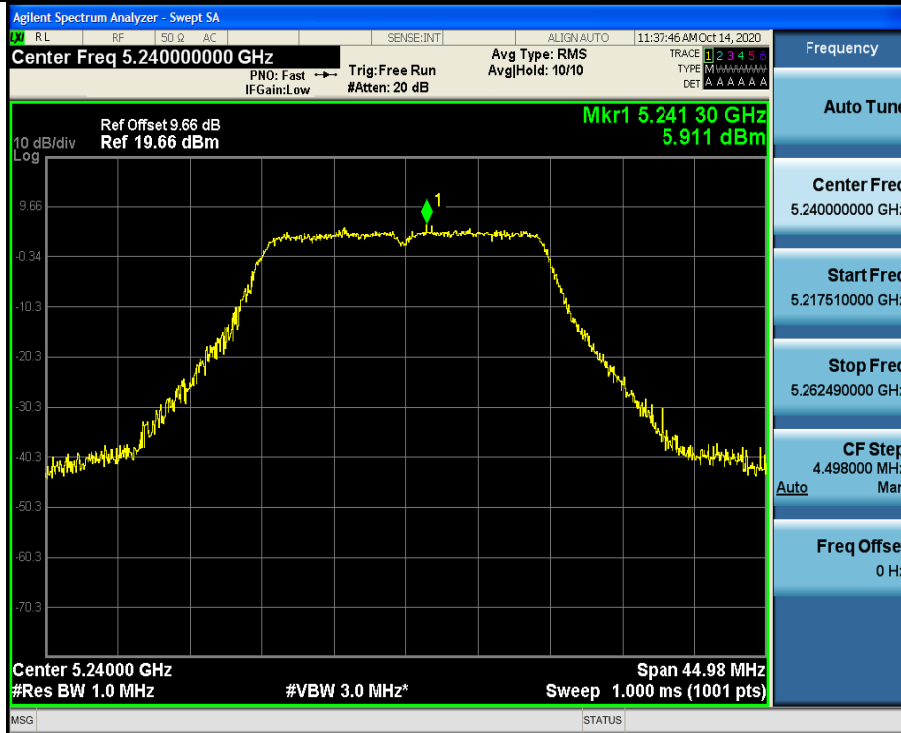

High

802.11ac(HT40)

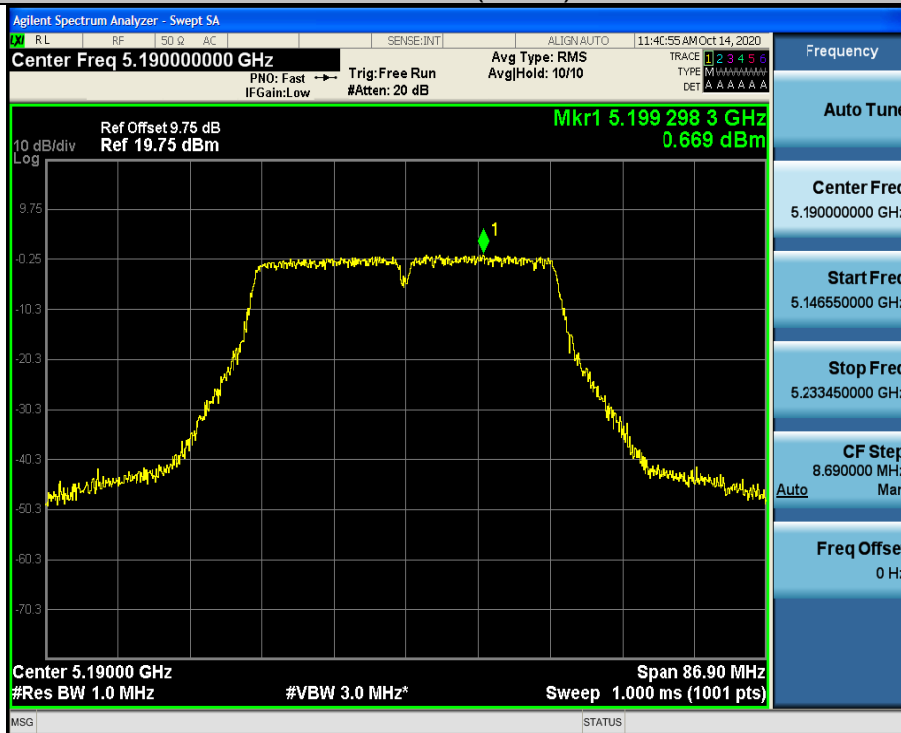

Low

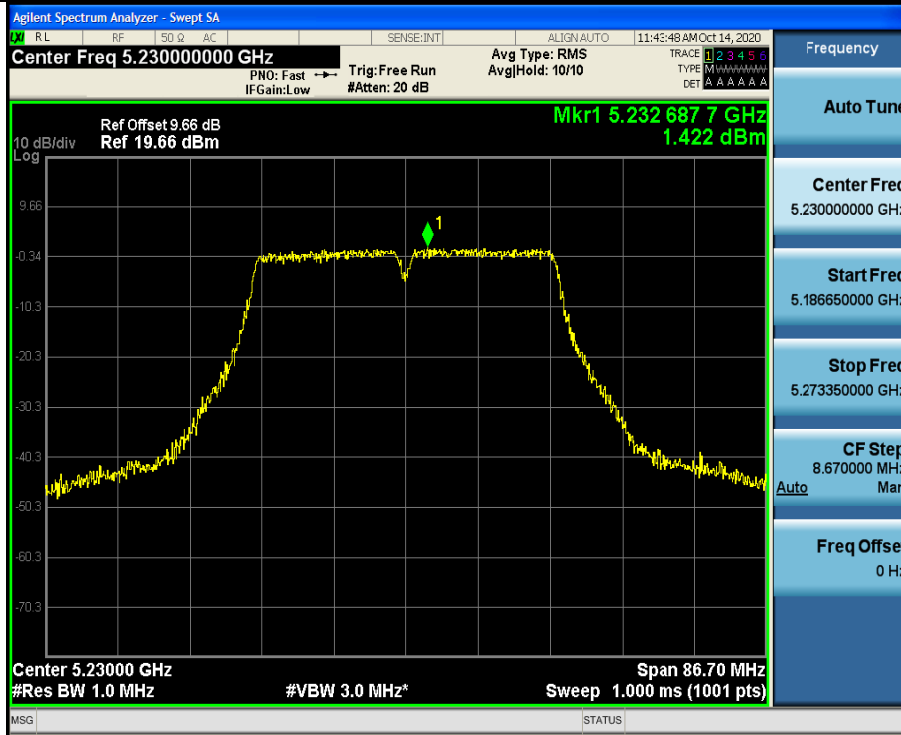

High

802.11ac(HT80)



Low



For MIMO antenna 1+antenna 2
Configuration Band IV (5150 - 5250MHz)

Mode	Test channel	Power Density (dBm)	Limit (dBm)	Result
11n(HT20)	CH36	8.12	16.99	PASS
11n(HT20)	CH40	7.63	16.99	PASS
11n(HT20)	CH48	8.47	16.99	PASS
11n(HT40)	CH38	3.90	16.99	PASS
11n(HT40)	CH46	4.03	16.99	PASS
11ac(HT20)	CH36	7.79	16.99	PASS
11ac(HT20)	CH40	7.63	16.99	PASS
11ac(HT20)	CH48	8.72	16.99	PASS
11ac(HT40)	CH38	3.81	16.99	PASS
11ac(HT40)	CH46	4.35	16.99	PASS
11ac(HT80)	CH42	1.03	16.99	PASS
Note: 1 According to KDB 662911, Result power = $10\log(10^{(\text{ant1}/10)}+10^{(\text{ant2}/10)})$. 2 Result unit: W, The end result is converted to units of dBm.				

Note: This product supports antenna 3 and antenna 4 launch, but only support 802.11 n/ac for MIMO mode,
not support 802.11 a for MIMO mode.

4.6. Band edge

4.6.1. Test Specification

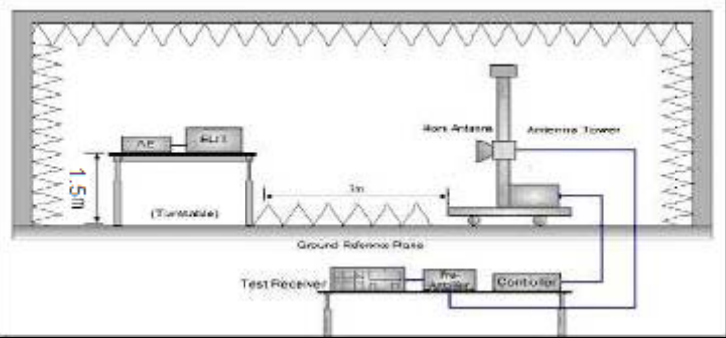
Test Requirement:	FCC CFR47 Part 15E Section 15.407 & 15.209 & 15.205
Test Method:	ANSI C63.10 2013
Limit:	(1) For transmitters operating in the 5.15-5.25 GHz band: All emissions outside of the 5.15-5.35 GHz band shall not exceed an e.i.r.p. of -27 dBm/MHz. The limit of frequency below 1GHz and which fall in restricted bands should complies 15.209.
Test Setup:	
Test Mode:	Transmitting mode with modulation
Test Procedure:	<ol style="list-style-type: none"> 1. The EUT was placed on the top of a rotating table 1.5 meters above the ground at a 3 meter camber. The table was rotated 360 degrees to determine the position of the highest radiation. 2. The EUT was set 3 meters away from the interference-receiving antenna, which was mounted on the top of a variable-height antenna tower. 3. The antenna height is varied from one meter to four meters above the ground to determine the maximum value of the field strength. Both horizontal and vertical polarizations of the antenna are set to make the measurement. 4. For each suspected emission, the EUT was arranged to its worst case and then the antenna was tuned to heights from 1 meter to 4 meters and the rota table was turned from 0 degrees to 360 degrees to find the maximum reading. 5. The test-receiver system was set to Peak Detect Function and Specified Bandwidth with Maximum Hold Mode. 6. If the emission level of the EUT in peak mode was 10dB lower than the limit specified, then testing could be stopped and the peak values of the EUT would be reported. Otherwise the emissions that did not have 10dB margin would be re-tested one by one using peak, quasipeak or average method as specified and then reported in a data sheet.
Test Result:	PASS



4.6.2. Test Instruments

Radiated Emission Test Site (966)					
Name of Equipment	Manufacturer	Model	Serial Number	Calibration Date	Calibration Due
Receiver	R&S	ESRP3	HKE-005	Dec. 26, 2019	Dec. 25, 2020
Spectrum analyzer	Agilent	N9020A	HKE-048	Dec. 26, 2019	Dec. 25, 2020
Preamplifier	EMCI	EMC051845S E	HKE-015	Dec. 26, 2019	Dec. 25, 2020
Preamplifier	Agilent	83051A	HKE-016	Dec. 26, 2019	Dec. 25, 2020
Loop antenna	Schwarzbeck	FMZB 1519 B	HKE-014	Dec. 26, 2019	Dec. 25, 2020
Broadband antenna	Schwarzbeck	VULB 9163	HKE-012	Dec. 26, 2019	Dec. 25, 2020
Horn antenna	Schwarzbeck	9120D	HKE-013	Dec. 26, 2019	Dec. 25, 2020
Antenna Mast	Keleto	CC-A-4M	N/A	N/A	N/A
Position controller	Taiwan MF	MF7802	HKE-011	Dec. 26, 2019	Dec. 25, 2020
Radiated test software	Tonscend	TS+ Rev 2.5.0.0	HKE-082	N/A	N/A
RF cable (9KHz-1GHz)	Times	381806-001	N/A	N/A	N/A
Hf antenna	Schwarzbeck	LB-180400-KF	HKE-031	Dec. 26, 2019	Dec. 25, 2020
RF cable	Tonscend	1-18G	HKE-099	Dec. 26, 2019	Dec. 25, 2020
RF cable	Times	1-40G	HKE-034	Dec. 26, 2019	Dec. 25, 2020
Horn Antenna	Schwarzbeck	BBHA 9170	HKE-017	Dec. 26, 2019	Dec. 25, 2020
Spectrum analyzer	R&S	FSP40	HKE-025	Dec. 26, 2019	Dec. 25, 2020

Note: The calibration interval of the above test instruments is 12 months and the calibrations are traceable to international system unit (SI).



4.6.3. Test Data

ANT 1

Operation Mode: 802.11a Mode with 5.2G TX CH Low

Horizontal

Frequency	Meter Reading	Factor	Emission Level	Limits	Margin	Detector Type
(MHz)	(dB μ V)	(dB)	(dB μ V/m)	(dB μ V/m)	(dB)	
5150	52.59	-2.49	50.1	74	-23.9	peak
5150	/	-2.49	/	54	/	AVG

Remark: Factor = Antenna Factor + Cable Loss – Pre-amplifier.

Vertical:

Frequency	Meter Reading	Factor	Emission Level	Limits	Margin	Detector Type
(MHz)	(dB μ V)	(dB)	(dB μ V/m)	(dB μ V/m)	(dB)	
5150	53.64	-2.49	51.15	74	-22.85	peak
5150	/	-2.49	/	54	/	AVG

Remark: Factor = Antenna Factor + Cable Loss – Pre-amplifier.



Operation Mode: TX CH High with 5.2G

Horizontal

Frequency	Meter Reading	Factor	Emission Level	Limits	Margin	Detector Type
(MHz)	(dB μ V)	(dB)	(dB μ V/m)	(dB μ V/m)	(dB)	
5350	52.14	-2.11	50.03	74	-23.97	peak
5350	/	-2.11	/	54	/	AVG

Remark: Factor = Antenna Factor + Cable Loss – Pre-amplifier.

Vertical:

Frequency	Meter Reading	Factor	Emission Level	Limits	Margin	Detector Type
(MHz)	(dB μ V)	(dB)	(dB μ V/m)	(dB μ V/m)	(dB)	
5350	51.65	-2.11	49.54	74	-24.46	peak
5350	/	-2.11	/	54	/	AVG

Remark: Factor = Antenna Factor + Cable Loss – Pre-amplifier.



Operation Mode: 802.11n20 Mode with 5.2G TX CH Low

Horizontal

Frequency	Meter Reading	Factor	Emission Level	Limits	Margin	Detector Type
(MHz)	(dB μ V)	(dB)	(dB μ V/m)	(dB μ V/m)	(dB)	
5150	53.33	-2.49	50.84	74	-23.16	peak
5150	/	-2.49	/	54	/	AVG

Remark: Factor = Antenna Factor + Cable Loss – Pre-amplifier.

Vertical:

Frequency	Meter Reading	Factor	Emission Level	Limits	Margin	Detector Type
(MHz)	(dB μ V)	(dB)	(dB μ V/m)	(dB μ V/m)	(dB)	
5150	51.42	-2.49	48.93	74	-25.07	peak
5150	/	-2.49	/	54	/	AVG

Remark: Factor = Antenna Factor + Cable Loss – Pre-amplifier.



Operation Mode: TX CH High with 5.2G

Horizontal

Frequency	Meter Reading	Factor	Emission Level	Limits	Margin	Detector Type
(MHz)	(dB μ V)	(dB)	(dB μ V/m)	(dB μ V/m)	(dB)	
5350	50.66	-2.11	48.55	74	-25.45	peak
5350	/	-2.11	/	54	/	AVG

Remark: Factor = Antenna Factor + Cable Loss – Pre-amplifier.

Vertical:

Frequency	Meter Reading	Factor	Emission Level	Limits	Margin	Detector Type
(MHz)	(dB μ V)	(dB)	(dB μ V/m)	(dB μ V/m)	(dB)	
5350	51.61	-2.11	49.5	74	-24.5	peak
5350	/	-2.11	/	54	/	AVG

Remark: Factor = Antenna Factor + Cable Loss – Pre-amplifier.



Operation Mode: 802.11 n40 Mode with 5.2G TX CH Low

Horizontal

Frequency	Meter Reading	Factor	Emission Level	Limits	Margin	Detector Type
(MHz)	(dB μ V)	(dB)	(dB μ V/m)	(dB μ V/m)	(dB)	
5150	52.27	-2.49	49.78	74	-24.22	peak
5150	/	-2.49	/	54	/	AVG
Remark: Factor = Antenna Factor + Cable Loss – Pre-amplifier.						

Vertical:

Frequency	Meter Reading	Factor	Emission Level	Limits	Margin	Detector Type
(MHz)	(dB μ V)	(dB)	(dB μ V/m)	(dB μ V/m)	(dB)	
5150	51.14	-2.49	48.65	74	-25.35	peak
5150	/	-2.49	/	54	/	AVG
Remark: Factor = Antenna Factor + Cable Loss – Pre-amplifier.						



Operation Mode: TX CH High with 5.2G

Horizontal

Frequency	Meter Reading	Factor	Emission Level	Limits	Margin	Detector Type
(MHz)	(dB μ V)	(dB)	(dB μ V/m)	(dB μ V/m)	(dB)	
5350	51.75	-2.11	49.64	74	-24.36	peak
5350	/	-2.11	/	54	/	AVG

Remark: Factor = Antenna Factor + Cable Loss – Pre-amplifier.

Vertical:

Frequency	Meter Reading	Factor	Emission Level	Limits	Margin	Detector Type
(MHz)	(dB μ V)	(dB)	(dB μ V/m)	(dB μ V/m)	(dB)	
5350	51.22	-2.11	49.11	74	-24.89	peak
5350	/	-2.11	/	54	/	AVG

Remark: Factor = Antenna Factor + Cable Loss – Pre-amplifier.



Operation Mode: 802.11 ac20 Mode with 5.2G TX CH Low

Horizontal

Frequency	Meter Reading	Factor	Emission Level	Limits	Margin	Detector Type
(MHz)	(dB μ V)	(dB)	(dB μ V/m)	(dB μ V/m)	(dB)	
5150	52.39	-2.49	49.9	74	-24.1	peak
5150	/	-2.49	/	54	/	AVG

Remark: Factor = Antenna Factor + Cable Loss – Pre-amplifier.

Vertical:

Frequency	Meter Reading	Factor	Emission Level	Limits	Margin	Detector Type
(MHz)	(dB μ V)	(dB)	(dB μ V/m)	(dB μ V/m)	(dB)	
5150	52.41	-2.49	49.92	74	-24.08	peak
5150	/	-2.49	/	54	/	AVG

Remark: Factor = Antenna Factor + Cable Loss – Pre-amplifier.



Operation Mode: TX CH High with 5.2G

Horizontal

Frequency	Meter Reading	Factor	Emission Level	Limits	Margin	Detector Type
(MHz)	(dB μ V)	(dB)	(dB μ V/m)	(dB μ V/m)	(dB)	
5350	52.28	-2.11	50.17	74	-23.83	peak
5350	/	-2.11	/	54	/	AVG

Remark: Factor = Antenna Factor + Cable Loss – Pre-amplifier.

Vertical:

Frequency	Meter Reading	Factor	Emission Level	Limits	Margin	Detector Type
(MHz)	(dB μ V)	(dB)	(dB μ V/m)	(dB μ V/m)	(dB)	
5350	50.36	-2.11	48.25	74	-25.75	peak
5350	/	-2.11	/	54	/	AVG

Remark: Factor = Antenna Factor + Cable Loss – Pre-amplifier.



Operation Mode: 802.11 ac40 Mode with 5.2G TX CH Low

Horizontal

Frequency	Meter Reading	Factor	Emission Level	Limits	Margin	Detector Type
(MHz)	(dB μ V)	(dB)	(dB μ V/m)	(dB μ V/m)	(dB)	
5150	53.46	-2.49	50.97	74	-23.03	peak
5150	/	-2.49	/	54	/	AVG
Remark: Factor = Antenna Factor + Cable Loss – Pre-amplifier.						

Vertical:

Frequency	Meter Reading	Factor	Emission Level	Limits	Margin	Detector Type
(MHz)	(dB μ V)	(dB)	(dB μ V/m)	(dB μ V/m)	(dB)	
5150	52.66	-2.49	50.17	74	-23.83	peak
5150	/	-2.49	/	54	/	AVG
Remark: Factor = Antenna Factor + Cable Loss – Pre-amplifier.						



Operation Mode: TX CH High with 5.2G

Horizontal

Frequency	Meter Reading	Factor	Emission Level	Limits	Margin	Detector Type
(MHz)	(dB μ V)	(dB)	(dB μ V/m)	(dB μ V/m)	(dB)	
5350	55.32	-2.11	53.21	74	-20.79	peak
5350	/	-2.11	/	54	/	AVG

Remark: Factor = Antenna Factor + Cable Loss – Pre-amplifier.

Vertical:

Frequency	Meter Reading	Factor	Emission Level	Limits	Margin	Detector Type
(MHz)	(dB μ V)	(dB)	(dB μ V/m)	(dB μ V/m)	(dB)	
5350	51.12	-2.11	49.01	74	-24.99	peak
5350	/	-2.11	/	54	/	AVG

Remark: Factor = Antenna Factor + Cable Loss – Pre-amplifier.



Operation Mode: 802.11 ac80 Mode with 5.2G TX CH Low

Horizontal

Frequency	Meter Reading	Factor	Emission Level	Limits	Margin	Detector Type
(MHz)	(dB μ V)	(dB)	(dB μ V/m)	(dB μ V/m)	(dB)	
5150	53.12	-2.49	50.63	74	-23.37	peak
5150	/	-2.49	/	54	/	AVG
Remark: Factor = Antenna Factor + Cable Loss – Pre-amplifier.						

Vertical:

Frequency	Meter Reading	Factor	Emission Level	Limits	Margin	Detector Type
(MHz)	(dB μ V)	(dB)	(dB μ V/m)	(dB μ V/m)	(dB)	
5150	51.39	-2.49	48.9	74	-25.1	peak
5150	/	-2.49	/	54	/	AVG
Remark: Factor = Antenna Factor + Cable Loss – Pre-amplifier.						



Operation Mode: TX CH High with 5.2G

Horizontal

Frequency	Meter Reading	Factor	Emission Level	Limits	Margin	Detector Type
(MHz)	(dB μ V)	(dB)	(dB μ V/m)	(dB μ V/m)	(dB)	
5350	53.42	-2.11	51.31	74	-22.69	peak
5350	/	-2.11	/	54	/	AVG

Remark: Factor = Antenna Factor + Cable Loss – Pre-amplifier.

Vertical:

Frequency	Meter Reading	Factor	Emission Level	Limits	Margin	Detector Type
(MHz)	(dB μ V)	(dB)	(dB μ V/m)	(dB μ V/m)	(dB)	
5350	51.27	-2.11	49.16	74	-24.84	peak
5350	/	-2.11	/	54	/	AVG

Remark: Factor = Antenna Factor + Cable Loss – Pre-amplifier.

**ANT 2**

Operation Mode: 802.11a Mode with 5.2G TX CH Low

Horizontal

Frequency	Meter Reading	Factor	Emission Level	Limits	Margin	Detector Type
(MHz)	(dB μ V)	(dB)	(dB μ V/m)	(dB μ V/m)	(dB)	
5150	51.33	-2.49	48.84	74	-25.16	peak
5150	/	-2.49	/	54	/	AVG

Remark: Factor = Antenna Factor + Cable Loss – Pre-amplifier.

Vertical:

Frequency	Meter Reading	Factor	Emission Level	Limits	Margin	Detector Type
(MHz)	(dB μ V)	(dB)	(dB μ V/m)	(dB μ V/m)	(dB)	
5150	52.64	-2.49	50.15	74	-23.85	peak
5150	/	-2.49	/	54	/	AVG

Remark: Factor = Antenna Factor + Cable Loss – Pre-amplifier.



Operation Mode: TX CH High with 5.2G

Horizontal

Frequency	Meter Reading	Factor	Emission Level	Limits	Margin	Detector Type
(MHz)	(dB μ V)	(dB)	(dB μ V/m)	(dB μ V/m)	(dB)	
5350	52.76	-2.11	50.65	74	-23.35	peak
5350	/	-2.11	/	54	/	AVG

Remark: Factor = Antenna Factor + Cable Loss – Pre-amplifier.

Vertical:

Frequency	Meter Reading	Factor	Emission Level	Limits	Margin	Detector Type
(MHz)	(dB μ V)	(dB)	(dB μ V/m)	(dB μ V/m)	(dB)	
5350	51.24	-2.11	49.13	74	-24.87	peak
5350	/	-2.11	/	54	/	AVG

Remark: Factor = Antenna Factor + Cable Loss – Pre-amplifier.



Operation Mode: 802.11n20 Mode with 5.2G TX CH Low

Horizontal

Frequency	Meter Reading	Factor	Emission Level	Limits	Margin	Detector Type
(MHz)	(dB μ V)	(dB)	(dB μ V/m)	(dB μ V/m)	(dB)	
5150	55.47	-2.49	52.98	74	-21.02	peak
5150	/	-2.49	/	54	/	AVG

Remark: Factor = Antenna Factor + Cable Loss – Pre-amplifier.

Vertical:

Frequency	Meter Reading	Factor	Emission Level	Limits	Margin	Detector Type
(MHz)	(dB μ V)	(dB)	(dB μ V/m)	(dB μ V/m)	(dB)	
5150	51.26	-2.49	48.77	74	-25.23	peak
5150	/	-2.49	/	54	/	AVG

Remark: Factor = Antenna Factor + Cable Loss – Pre-amplifier.



Operation Mode: TX CH High with 5.2G

Horizontal

Frequency	Meter Reading	Factor	Emission Level	Limits	Margin	Detector Type
(MHz)	(dB μ V)	(dB)	(dB μ V/m)	(dB μ V/m)	(dB)	
5350	52.12	-2.11	50.01	74	-23.99	peak
5350	/	-2.11	/	54	/	AVG

Remark: Factor = Antenna Factor + Cable Loss – Pre-amplifier.

Vertical:

Frequency	Meter Reading	Factor	Emission Level	Limits	Margin	Detector Type
(MHz)	(dB μ V)	(dB)	(dB μ V/m)	(dB μ V/m)	(dB)	
5350	55.22	-2.11	53.11	74	-20.89	peak
5350	/	-2.11	/	54	/	AVG

Remark: Factor = Antenna Factor + Cable Loss – Pre-amplifier.



Operation Mode: 802.11 n40 Mode with 5.2G TX CH Low

Horizontal

Frequency	Meter Reading	Factor	Emission Level	Limits	Margin	Detector Type
(MHz)	(dB μ V)	(dB)	(dB μ V/m)	(dB μ V/m)	(dB)	
5150	52.77	-2.49	50.28	74	-23.72	peak
5150	/	-2.49	/	54	/	AVG
Remark: Factor = Antenna Factor + Cable Loss – Pre-amplifier.						

Vertical:

Frequency	Meter Reading	Factor	Emission Level	Limits	Margin	Detector Type
(MHz)	(dB μ V)	(dB)	(dB μ V/m)	(dB μ V/m)	(dB)	
5150	54.21	-2.49	51.72	74	-22.28	peak
5150	/	-2.49	/	54	/	AVG
Remark: Factor = Antenna Factor + Cable Loss – Pre-amplifier.						



Operation Mode: TX CH High with 5.2G

Horizontal

Frequency	Meter Reading	Factor	Emission Level	Limits	Margin	Detector Type
(MHz)	(dB μ V)	(dB)	(dB μ V/m)	(dB μ V/m)	(dB)	
5350	53.34	-2.11	51.23	74	-22.77	peak
5350	/	-2.11	/	54	/	AVG

Remark: Factor = Antenna Factor + Cable Loss – Pre-amplifier.

Vertical:

Frequency	Meter Reading	Factor	Emission Level	Limits	Margin	Detector Type
(MHz)	(dB μ V)	(dB)	(dB μ V/m)	(dB μ V/m)	(dB)	
5350	52.77	-2.11	50.66	74	-23.34	peak
5350	/	-2.11	/	54	/	AVG

Remark: Factor = Antenna Factor + Cable Loss – Pre-amplifier.



Operation Mode: 802.11 ac20 Mode with 5.2G TX CH Low

Horizontal

Frequency	Meter Reading	Factor	Emission Level	Limits	Margin	Detector Type
(MHz)	(dB μ V)	(dB)	(dB μ V/m)	(dB μ V/m)	(dB)	
5150	52.21	-2.49	49.72	74	-24.28	peak
5150	/	-2.49	/	54	/	AVG
Remark: Factor = Antenna Factor + Cable Loss – Pre-amplifier.						

Vertical:

Frequency	Meter Reading	Factor	Emission Level	Limits	Margin	Detector Type
(MHz)	(dB μ V)	(dB)	(dB μ V/m)	(dB μ V/m)	(dB)	
5150	52.36	-2.49	49.87	74	-24.13	peak
5150	/	-2.49	/	54	/	AVG
Remark: Factor = Antenna Factor + Cable Loss – Pre-amplifier.						



Operation Mode: TX CH High with 5.2G

Horizontal

Frequency	Meter Reading	Factor	Emission Level	Limits	Margin	Detector Type
(MHz)	(dB μ V)	(dB)	(dB μ V/m)	(dB μ V/m)	(dB)	
5350	52.44	-2.11	50.33	74	-23.67	peak
5350	/	-2.11	/	54	/	AVG

Remark: Factor = Antenna Factor + Cable Loss – Pre-amplifier.

Vertical:

Frequency	Meter Reading	Factor	Emission Level	Limits	Margin	Detector Type
(MHz)	(dB μ V)	(dB)	(dB μ V/m)	(dB μ V/m)	(dB)	
5350	53.11	-2.11	51	74	-23	peak
5350	/	-2.11	/	54	/	AVG

Remark: Factor = Antenna Factor + Cable Loss – Pre-amplifier.



Operation Mode: 802.11 ac40 Mode with 5.2G TX CH Low

Horizontal

Frequency	Meter Reading	Factor	Emission Level	Limits	Margin	Detector Type
(MHz)	(dB μ V)	(dB)	(dB μ V/m)	(dB μ V/m)	(dB)	
5150	53.42	-2.49	50.93	74	-23.07	peak
5150	/	-2.49	/	54	/	AVG
Remark: Factor = Antenna Factor + Cable Loss – Pre-amplifier.						

Vertical:

Frequency	Meter Reading	Factor	Emission Level	Limits	Margin	Detector Type
(MHz)	(dB μ V)	(dB)	(dB μ V/m)	(dB μ V/m)	(dB)	
5150	51.29	-2.49	48.8	74	-25.2	peak
5150	/	-2.49	/	54	/	AVG
Remark: Factor = Antenna Factor + Cable Loss – Pre-amplifier.						



Operation Mode: TX CH High with 5.2G

Horizontal

Frequency	Meter Reading	Factor	Emission Level	Limits	Margin	Detector Type
(MHz)	(dB μ V)	(dB)	(dB μ V/m)	(dB μ V/m)	(dB)	
5350	52.66	-2.11	50.55	74	-23.45	peak
5350	/	-2.11	/	54	/	AVG

Remark: Factor = Antenna Factor + Cable Loss – Pre-amplifier.

Vertical:

Frequency	Meter Reading	Factor	Emission Level	Limits	Margin	Detector Type
(MHz)	(dB μ V)	(dB)	(dB μ V/m)	(dB μ V/m)	(dB)	
5350	50.27	-2.11	48.16	74	-25.84	peak
5350	/	-2.11	/	54	/	AVG

Remark: Factor = Antenna Factor + Cable Loss – Pre-amplifier.



Operation Mode: 802.11 ac80 Mode with 5.2G TX CH Low

Horizontal

Frequency	Meter Reading	Factor	Emission Level	Limits	Margin	Detector Type
(MHz)	(dB μ V)	(dB)	(dB μ V/m)	(dB μ V/m)	(dB)	
5150	51.24	-2.49	48.75	74	-25.25	peak
5150	/	-2.49	/	54	/	AVG
Remark: Factor = Antenna Factor + Cable Loss – Pre-amplifier.						

Vertical:

Frequency	Meter Reading	Factor	Emission Level	Limits	Margin	Detector Type
(MHz)	(dB μ V)	(dB)	(dB μ V/m)	(dB μ V/m)	(dB)	
5150	52.11	-2.49	49.62	74	-24.38	peak
5150	/	-2.49	/	54	/	AVG
Remark: Factor = Antenna Factor + Cable Loss – Pre-amplifier.						



Operation Mode: TX CH High with 5.2G

Horizontal

Frequency	Meter Reading	Factor	Emission Level	Limits	Margin	Detector Type
(MHz)	(dB μ V)	(dB)	(dB μ V/m)	(dB μ V/m)	(dB)	
5350	50.57	-2.11	48.46	74	-25.54	peak
5350	/	-2.11	/	54	/	AVG

Remark: Factor = Antenna Factor + Cable Loss – Pre-amplifier.

Vertical:

Frequency	Meter Reading	Factor	Emission Level	Limits	Margin	Detector Type
(MHz)	(dB μ V)	(dB)	(dB μ V/m)	(dB μ V/m)	(dB)	
5350	51.24	-2.11	49.13	74	-24.87	peak
5350	/	-2.11	/	54	/	AVG

Remark: Factor = Antenna Factor + Cable Loss – Pre-amplifier.



MIMO:

Operation Mode: 802.11n20 Mode with 5.2G TX CH Low

Horizontal

Frequency	Meter Reading	Factor	Emission Level	Limits	Margin	Detector Type
(MHz)	(dB μ V)	(dB)	(dB μ V/m)	(dB μ V/m)	(dB)	
5150	55.38	-2.49	52.89	74	-21.11	peak
5150	/	-2.49	/	54	/	AVG

Remark: Factor = Antenna Factor + Cable Loss – Pre-amplifier.

Vertical:

Frequency	Meter Reading	Factor	Emission Level	Limits	Margin	Detector Type
(MHz)	(dB μ V)	(dB)	(dB μ V/m)	(dB μ V/m)	(dB)	
5150	54.44	-2.49	51.95	74	-22.05	peak
5150	/	-2.49	/	54	/	AVG

Remark: Factor = Antenna Factor + Cable Loss – Pre-amplifier.



Operation Mode: TX CH High with 5.2G

Horizontal

Frequency	Meter Reading	Factor	Emission Level	Limits	Margin	Detector Type
(MHz)	(dB μ V)	(dB)	(dB μ V/m)	(dB μ V/m)	(dB)	
5350	56.16	-2.11	54.05	74	-19.95	peak
5350	/	-2.11	/	54	/	AVG

Remark: Factor = Antenna Factor + Cable Loss – Pre-amplifier.

Vertical:

Frequency	Meter Reading	Factor	Emission Level	Limits	Margin	Detector Type
(MHz)	(dB μ V)	(dB)	(dB μ V/m)	(dB μ V/m)	(dB)	
5350	55.29	-2.11	53.18	74	-20.82	peak
5350	/	-2.11	/	54	/	AVG

Remark: Factor = Antenna Factor + Cable Loss – Pre-amplifier.



Operation Mode: 802.11 n40 Mode with 5.2G TX CH Low

Horizontal

Frequency	Meter Reading	Factor	Emission Level	Limits	Margin	Detector Type
(MHz)	(dB μ V)	(dB)	(dB μ V/m)	(dB μ V/m)	(dB)	
5150	55.73	-2.49	53.24	74	-20.76	peak
5150	/	-2.49	/	54	/	AVG
Remark: Factor = Antenna Factor + Cable Loss – Pre-amplifier.						

Vertical:

Frequency	Meter Reading	Factor	Emission Level	Limits	Margin	Detector Type
(MHz)	(dB μ V)	(dB)	(dB μ V/m)	(dB μ V/m)	(dB)	
5150	56.57	-2.49	54.08	74	-19.92	peak
5150	/	-2.49	/	54	/	AVG
Remark: Factor = Antenna Factor + Cable Loss – Pre-amplifier.						



Operation Mode: TX CH High with 5.2G

Horizontal

Frequency	Meter Reading	Factor	Emission Level	Limits	Margin	Detector Type
(MHz)	(dB μ V)	(dB)	(dB μ V/m)	(dB μ V/m)	(dB)	
5350	55.69	-2.11	53.58	74	-20.42	peak
5350	/	-2.11	/	54	/	AVG

Remark: Factor = Antenna Factor + Cable Loss – Pre-amplifier.

Vertical:

Frequency	Meter Reading	Factor	Emission Level	Limits	Margin	Detector Type
(MHz)	(dB μ V)	(dB)	(dB μ V/m)	(dB μ V/m)	(dB)	
5350	54.78	-2.11	52.67	74	-21.33	peak
5350	/	-2.11	/	54	/	AVG

Remark: Factor = Antenna Factor + Cable Loss – Pre-amplifier.



Operation Mode: 802.11 ac20 Mode with 5.2G TX CH Low

Horizontal

Frequency	Meter Reading	Factor	Emission Level	Limits	Margin	Detector Type
(MHz)	(dB μ V)	(dB)	(dB μ V/m)	(dB μ V/m)	(dB)	
5150	55.36	-2.49	52.87	74	-21.13	peak
5150	/	-2.49	/	54	/	AVG
Remark: Factor = Antenna Factor + Cable Loss – Pre-amplifier.						

Vertical:

Frequency	Meter Reading	Factor	Emission Level	Limits	Margin	Detector Type
(MHz)	(dB μ V)	(dB)	(dB μ V/m)	(dB μ V/m)	(dB)	
5150	56.71	-2.49	54.22	74	-19.78	peak
5150	/	-2.49	/	54	/	AVG
Remark: Factor = Antenna Factor + Cable Loss – Pre-amplifier.						



Operation Mode: TX CH High with 5.2G

Horizontal

Frequency	Meter Reading	Factor	Emission Level	Limits	Margin	Detector Type
(MHz)	(dB μ V)	(dB)	(dB μ V/m)	(dB μ V/m)	(dB)	
5350	55.26	-2.11	53.15	74	-20.85	peak
5350	/	-2.11	/	54	/	AVG

Remark: Factor = Antenna Factor + Cable Loss – Pre-amplifier.

Vertical:

Frequency	Meter Reading	Factor	Emission Level	Limits	Margin	Detector Type
(MHz)	(dB μ V)	(dB)	(dB μ V/m)	(dB μ V/m)	(dB)	
5350	56.47	-2.11	54.36	74	-19.64	peak
5350	/	-2.11	/	54	/	AVG

Remark: Factor = Antenna Factor + Cable Loss – Pre-amplifier.



Operation Mode: 802.11 ac40 Mode with 5.2G TX CH Low

Horizontal

Frequency	Meter Reading	Factor	Emission Level	Limits	Margin	Detector Type
(MHz)	(dB μ V)	(dB)	(dB μ V/m)	(dB μ V/m)	(dB)	
5150	55.62	-2.49	53.13	74	-20.87	peak
5150	/	-2.49	/	54	/	AVG
Remark: Factor = Antenna Factor + Cable Loss – Pre-amplifier.						

Vertical:

Frequency	Meter Reading	Factor	Emission Level	Limits	Margin	Detector Type
(MHz)	(dB μ V)	(dB)	(dB μ V/m)	(dB μ V/m)	(dB)	
5150	55.24	-2.49	52.75	74	-21.25	peak
5150	/	-2.49	/	54	/	AVG
Remark: Factor = Antenna Factor + Cable Loss – Pre-amplifier.						



Operation Mode: TX CH High with 5.2G

Horizontal

Frequency	Meter Reading	Factor	Emission Level	Limits	Margin	Detector Type
(MHz)	(dB μ V)	(dB)	(dB μ V/m)	(dB μ V/m)	(dB)	
5350	55.39	-2.11	53.28	74	-20.72	peak
5350	/	-2.11	/	54	/	AVG

Remark: Factor = Antenna Factor + Cable Loss – Pre-amplifier.

Vertical:

Frequency	Meter Reading	Factor	Emission Level	Limits	Margin	Detector Type
(MHz)	(dB μ V)	(dB)	(dB μ V/m)	(dB μ V/m)	(dB)	
5350	55.19	-2.11	53.08	74	-20.92	peak
5350	/	-2.11	/	54	/	AVG

Remark: Factor = Antenna Factor + Cable Loss – Pre-amplifier.



Operation Mode: 802.11 ac80 Mode with 5.2G TX CH Low

Horizontal

Frequency	Meter Reading	Factor	Emission Level	Limits	Margin	Detector Type
(MHz)	(dB μ V)	(dB)	(dB μ V/m)	(dB μ V/m)	(dB)	
5150	54.36	-2.49	51.87	74	-22.13	peak
5150	/	-2.49	/	54	/	AVG
Remark: Factor = Antenna Factor + Cable Loss – Pre-amplifier.						

Vertical:

Frequency	Meter Reading	Factor	Emission Level	Limits	Margin	Detector Type
(MHz)	(dB μ V)	(dB)	(dB μ V/m)	(dB μ V/m)	(dB)	
5150	55.66	-2.49	53.17	74	-20.83	peak
5150	/	-2.49	/	54	/	AVG
Remark: Factor = Antenna Factor + Cable Loss – Pre-amplifier.						



Operation Mode: TX CH High with 5.2G

Horizontal

Frequency	Meter Reading	Factor	Emission Level	Limits	Margin	Detector Type
(MHz)	(dB μ V)	(dB)	(dB μ V/m)	(dB μ V/m)	(dB)	
5350	56.64	-2.11	54.53	74	-19.47	peak
5350	/	-2.11	/	54	/	AVG

Remark: Factor = Antenna Factor + Cable Loss – Pre-amplifier.

Vertical:

Frequency	Meter Reading	Factor	Emission Level	Limits	Margin	Detector Type
(MHz)	(dB μ V)	(dB)	(dB μ V/m)	(dB μ V/m)	(dB)	
5350	55.71	-2.11	53.6	74	-20.4	peak
5350	/	-2.11	/	54	/	AVG

Remark: Factor = Antenna Factor + Cable Loss – Pre-amplifier.

4.7. Spurious Emission

4.7.1.1. Test Specification

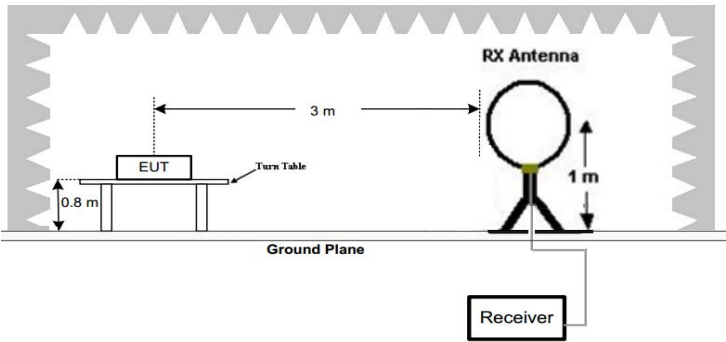
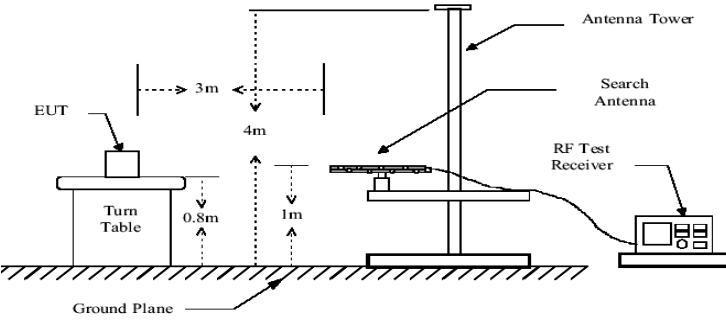
Test Requirement:	FCC CFR47 Part 15 Section 15.407 & 15.209 & 15.205																													
Test Method:	KDB 789033 D02 v02r01																													
Frequency Range:	9kHz to 40GHz																													
Measurement Distance:	3 m																													
Antenna Polarization:	Horizontal & Vertical																													
Operation mode:	Transmitting mode with modulation																													
Receiver Setup:	<table border="1"> <thead> <tr> <th>Frequency</th> <th>Detector</th> <th>RBW</th> <th>VBW</th> <th>Remark</th> </tr> </thead> <tbody> <tr> <td>9kHz- 150kHz</td> <td>Quasi-peak</td> <td>200Hz</td> <td>1kHz</td> <td>Quasi-peak Value</td> </tr> <tr> <td>150kHz- 30MHz</td> <td>Quasi-peak</td> <td>9kHz</td> <td>30kHz</td> <td>Quasi-peak Value</td> </tr> <tr> <td>30MHz-1GHz</td> <td>Quasi-peak</td> <td>120kHz</td> <td>300kHz</td> <td>Quasi-peak Value</td> </tr> <tr> <td rowspan="2">Above 1GHz</td> <td>Peak</td> <td>1MHz</td> <td>3MHz</td> <td>Peak Value</td> </tr> <tr> <td>Peak</td> <td>1MHz</td> <td>10Hz</td> <td>Average Value</td> </tr> </tbody> </table>	Frequency	Detector	RBW	VBW	Remark	9kHz- 150kHz	Quasi-peak	200Hz	1kHz	Quasi-peak Value	150kHz- 30MHz	Quasi-peak	9kHz	30kHz	Quasi-peak Value	30MHz-1GHz	Quasi-peak	120kHz	300kHz	Quasi-peak Value	Above 1GHz	Peak	1MHz	3MHz	Peak Value	Peak	1MHz	10Hz	Average Value
Frequency	Detector	RBW	VBW	Remark																										
9kHz- 150kHz	Quasi-peak	200Hz	1kHz	Quasi-peak Value																										
150kHz- 30MHz	Quasi-peak	9kHz	30kHz	Quasi-peak Value																										
30MHz-1GHz	Quasi-peak	120kHz	300kHz	Quasi-peak Value																										
Above 1GHz	Peak	1MHz	3MHz	Peak Value																										
	Peak	1MHz	10Hz	Average Value																										
Limit:	<p>(1) For transmitters operating in the 5.15-5.25 GHz band: All emissions outside of the 5.15-5.35 GHz band shall not exceed an e.i.r.p. of -27 dBm/MHz.</p> <p>The limit of frequency below 1GHz and which fall in restricted bands should comply 15.209.</p>																													
Test setup:	<p>For radiated emissions below 30MHz</p>  <p>30MHz to 1GHz</p>  <p>Above 1GHz</p>																													

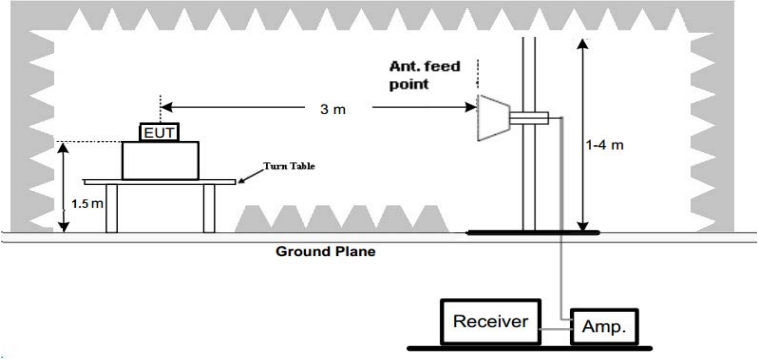
	
Test Procedure:	<ol style="list-style-type: none"> 1. The EUT was placed on the top of a rotating table 0.8 meters above the ground at a 3 meter camber. The table was rotated 360 degrees to determine the position of the highest radiation. 2. The EUT was set 3 meters away from the interference-receiving antenna, which was mounted on the top of a variable-height antenna tower. 3. The antenna height is varied from one meter to four meters above the ground to determine the maximum value of the field strength. Both horizontal and vertical polarizations of the antenna are set to make the measurement. 4. For each suspected emission, the EUT was arranged to its worst case and then the antenna was tuned to heights from 1 meter to 4 meters and the rotating table was turned from 0 degrees to 360 degrees to find the maximum reading. 5. The test-receiver system was set to Peak Detect Function and Specified Bandwidth with Maximum Hold Mode. 6. If the emission level of the EUT in peak mode was 10dB lower than the limit specified, then testing could be stopped and the peak values of the EUT would be reported. Otherwise the emissions that did not have 10dB margin would be re-tested one by one using peak, quasi-peak or average method as specified and then reported in a data sheet.
Test results:	PASS



4.7.2. Test Data

test mode: TX 802.11a 5180MHz

All the test modes completed for test. The worst case of Radiated Emission; the test data of this mode was reported.

Below 1GHz

Horizontal

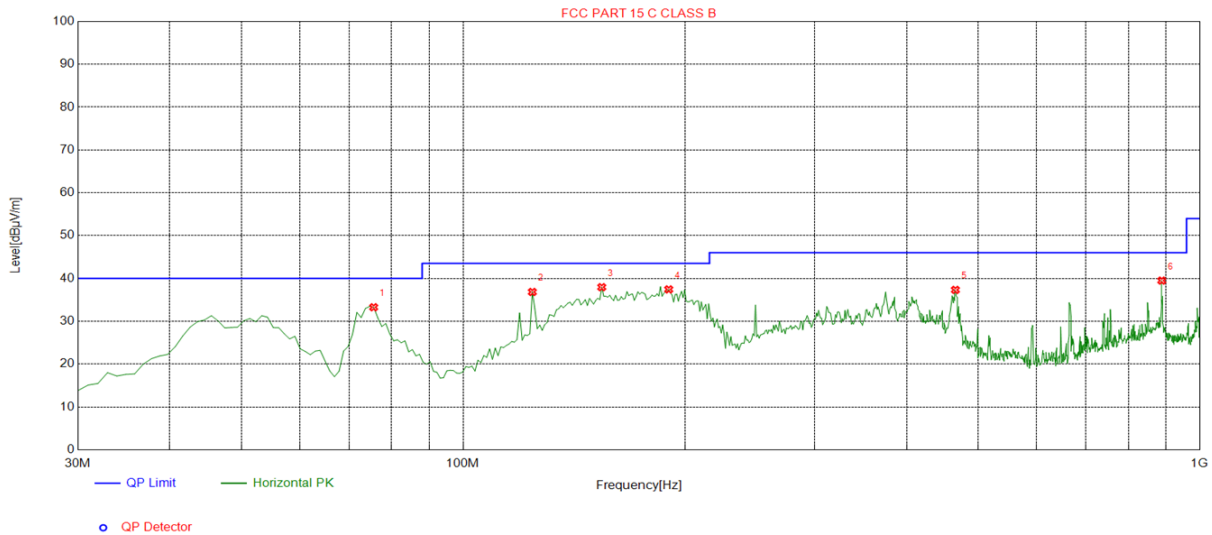

Suspected List									
NO.	Freq. [MHz]	Factor [dB]	Reading [dBµV/m]	Level [dBµV/m]	Limit [dBµV/m]	Margin [dB]	Height [cm]	Angle [°]	Polarity
1	75.6356	-18.68	51.95	33.27	40.00	6.73	100	234	Horizontal
2	124.1842	-17.72	54.56	36.84	43.50	6.66	100	328	Horizontal
3	154.2843	-18.63	56.59	37.96	43.50	5.54	100	303	Horizontal
4	190.2102	-15.99	53.43	37.44	43.50	6.06	100	316	Horizontal
5	465.9660	-8.47	45.79	37.32	46.00	8.68	100	112	Horizontal
6	888.3383	-1.91	41.41	39.50	46.00	6.50	100	64	Horizontal

Remark: Factor = Cable loss + Antenna factor – Preamplifier; Level = Reading + Factor; Margin = Limit – Level



Vertical

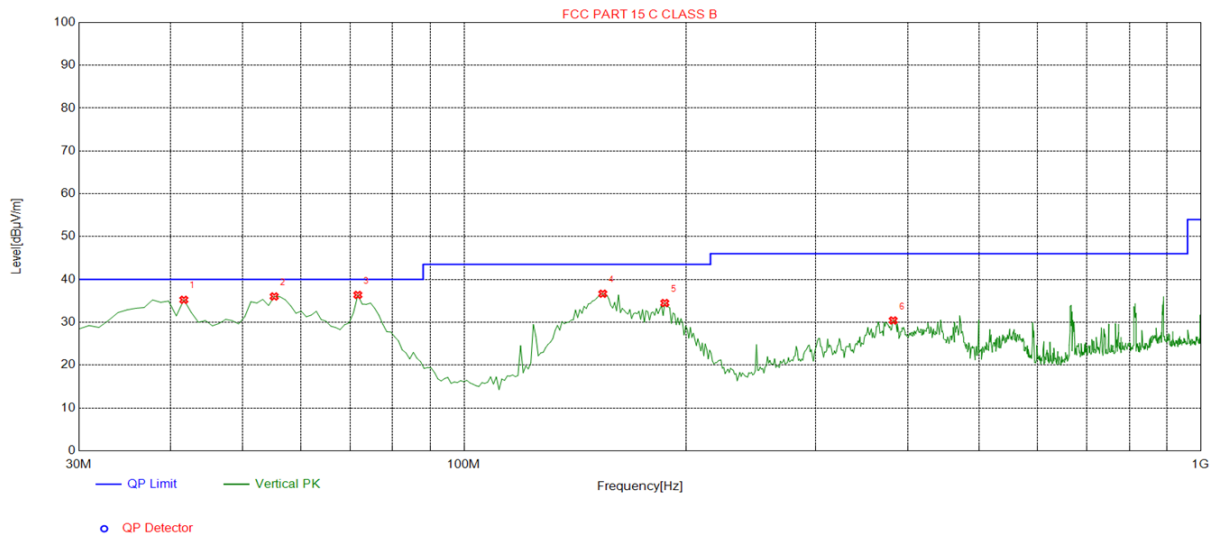

Suspected List									
NO.	Freq. [MHz]	Factor [dB]	Reading [dBµV/m]	Level [dBµV/m]	Limit [dBµV/m]	Margin [dB]	Height [cm]	Angle [°]	Polarity
1	41.6517	-14.25	49.49	35.24	40.00	4.76	100	309	Vertical
2	55.2452	-14.44	50.46	36.02	40.00	3.98	100	34	Vertical
3	71.7518	-17.99	54.37	36.38	40.00	3.62	100	322	Vertical
4	154.2843	-18.63	55.29	36.66	43.50	6.84	100	251	Vertical
5	187.2973	-16.24	50.73	34.49	43.50	9.01	100	196	Vertical
6	382.4625	-10.78	41.20	30.42	46.00	15.58	100	137	Vertical

Remark: Factor = Cable loss + Antenna factor – Pre-amplifier; Level = Reading + Factor; Margin = Limit – Level

Harmonics and Spurious Emissions

Frequency Range (9 kHz-30MHz)

Frequency (MHz)	Level@3m (dBµV/m)	Limit@3m (dBµV/m)
--	--	--
--	--	--
--	--	--
--	--	--

Note: 1. Emission Level=Reading+ Cable loss+ Antenna factor-Amp factor

2. The emission levels are 20 dB below the limit value, which are not reported. It is deemed to comply with the requirement

**Above 1GHz**

5.2G 802.11 a Mode

All modes of operation were investigated and the worst-case of MIMO are reported.

LOW CH 36

Horizontal:

Frequency	Meter Reading	Factor	Emission Level	Limits	Margin	Detector Type
(MHz)	(dB μ V)	(dB)	(dB μ V/m)	(dB μ V/m)	(dB)	
3647	62.84	-4.59	58.25	74	-15.75	peak
3647	49.65	-4.59	45.06	54	-8.94	AVG
10360	55.39	3.74	59.13	68.2	-9.07	peak

Remark: Factor = Antenna Factor + Cable Loss – Pre-amplifier.

Vertical:

Frequency	Meter Reading	Factor	Emission Level	Limits	Margin	Detector Type
(MHz)	(dB μ V)	(dB)	(dB μ V/m)	(dB μ V/m)	(dB)	
3647	64.54	-4.59	59.95	74	-14.05	peak
3647	48.35	-4.59	43.76	54	-10.24	AVG
10360	53.47	3.74	57.21	68.2	-10.99	peak

Remark: Factor = Antenna Factor + Cable Loss – Pre-amplifier.



MID CH40
Horizontal:

Frequency	Meter Reading	Factor	Emission Level	Limits	Margin	Detector Type
(MHz)	(dB μ V)	(dB)	(dB μ V/m)	(dB μ V/m)	(dB)	
3647	66.54	-4.59	61.95	74	-12.05	peak
3647	48.11	-4.59	43.52	54	-10.48	AVG
10400	54.72	3.74	58.46	68.2	-9.74	peak

Remark: Factor = Antenna Factor + Cable Loss – Pre-amplifier.

Vertical:

Frequency	Meter Reading	Factor	Emission Level	Limits	Margin	Detector Type
(MHz)	(dB μ V)	(dB)	(dB μ V/m)	(dB μ V/m)	(dB)	
3647	64.14	-4.59	59.55	74	-14.45	peak
3647	45.62	-4.59	41.03	54	-12.97	AVG
10400	55.38	3.74	59.12	68.2	-9.08	peak

Remark: Factor = Antenna Factor + Cable Loss – Pre-amplifier.

HIGH CH 48
Horizontal:

Frequency (MHz)	Meter Reading (dB μ V)	Factor (dB)	Emission Level (dB μ V/m)	Limits (dB μ V/m)	Margin (dB)	Detector Type
3647	61.57	-4.59	56.98	74	-17.02	peak
3647	45.66	-4.59	41.07	54	-12.93	AVG
10480	54.42	3.75	58.17	68.2	-10.03	peak

Remark: Factor = Antenna Factor + Cable Loss – Pre-amplifier.

Vertical:

Frequency (MHz)	Meter Reading (dB μ V)	Factor (dB)	Emission Level (dB μ V/m)	Limits (dB μ V/m)	Margin (dB)	Detector Type
3647	63.39	-4.59	58.8	74	-15.2	peak
3647	46.44	-4.59	41.85	54	-12.15	AVG
10480	51.88	3.75	55.63	68.2	-12.57	peak

Remark: Factor = Antenna Factor + Cable Loss – Pre-amplifier.

Remark:

- (1) Measuring frequencies from 1 GHz to the 40 GHz.
- (2) "F" denotes fundamental frequency; "H" denotes spurious frequency. "E" denotes band edge frequency.
- (3) * denotes emission frequency which appearing within the Restricted Bands specified in provision of 15.205, then the general radiated emission limits in 15.209 apply.
- (4) The emissions are attenuated more than 20dB below the permissible limits are not record in the report.
- (5) The IF bandwidth of EMI Test Receiver between 30MHz to 1GHz was 120KHz, 1 MHz for measuring above 1 GHz, below 30MHz was 10KHz.
- (6) When the test results of Peak Detected below the limits of Average Detected, the Average Detected is not need completed. For example: Top Channel at Fundamental 73.16dBuV/m(PK Value) <93.98(AV Limit), at harmonic 53.20 dBuV/m(PK Value) <54 dBuV/m(AV Limit), the Average Detected not need to completed.



5.2G 802.11n20 Mode

All modes of operation were investigated and the worst-case of MIMO are reported.

LOW CH 36

Horizontal:

Frequency	Meter Reading	Factor	Emission Level	Limits	Margin	Detector Type
(MHz)	(dB μ V)	(dB)	(dB μ V/m)	(dB μ V/m)	(dB)	
3647	64.62	-4.59	60.03	74	-13.97	peak
3647	48.44	-4.59	43.85	54	-10.15	AVG
10360	56.35	3.74	60.09	68.2	-8.11	peak

Remark: Factor = Antenna Factor + Cable Loss – Pre-amplifier.

Vertical:

Frequency	Meter Reading	Factor	Emission Level	Limits	Margin	Detector Type
(MHz)	(dB μ V)	(dB)	(dB μ V/m)	(dB μ V/m)	(dB)	
3647	62.54	-4.59	57.95	74	-16.05	peak
3647	47.24	-4.59	42.65	54	-11.35	AVG
10360	52.87	3.74	56.61	68.2	-11.59	peak

Remark: Factor = Antenna Factor + Cable Loss – Pre-amplifier.



MID CH40
Horizontal:

Frequency	Meter Reading	Factor	Emission Level	Limits	Margin	Detector Type
(MHz)	(dB μ V)	(dB)	(dB μ V/m)	(dB μ V/m)	(dB)	
3647	64.47	-4.59	59.88	74	-14.12	peak
3647	47.53	-4.59	42.94	54	-11.06	AVG
10400	55.21	3.74	58.95	68.2	-9.25	peak

Remark: Factor = Antenna Factor + Cable Loss – Pre-amplifier.

Vertical:

Frequency	Meter Reading	Factor	Emission Level	Limits	Margin	Detector Type
(MHz)	(dB μ V)	(dB)	(dB μ V/m)	(dB μ V/m)	(dB)	
3647	63.77	-4.59	59.18	74	-14.82	peak
3647	46.21	-4.59	41.62	54	-12.38	AVG
10400	54.22	3.74	57.96	68.2	-10.24	peak

Remark: Factor = Antenna Factor + Cable Loss – Pre-amplifier.



HIGH CH 48
Horizontal:

Frequency (MHz)	Meter Reading (dB μ V)	Factor (dB)	Emission Level (dB μ V/m)	Limits (dB μ V/m)	Margin (dB)	Detector Type
3647	61.47	-4.59	56.88	74	-17.12	peak
3647	46.63	-4.59	42.04	54	-11.96	AVG
10480	55.19	3.75	58.94	68.2	-9.26	peak

Remark: Factor = Antenna Factor + Cable Loss – Pre-amplifier.

Vertical:

Frequency (MHz)	Meter Reading (dB μ V)	Factor (dB)	Emission Level (dB μ V/m)	Limits (dB μ V/m)	Margin (dB)	Detector Type
3647	62.77	-4.59	58.18	74	-15.82	peak
3647	47.68	-4.59	43.09	54	-10.91	AVG
10480	53.74	3.75	57.49	68.2	-10.71	peak

Remark: Factor = Antenna Factor + Cable Loss – Pre-amplifier.

Remark:

- (1) Measuring frequencies from 1 GHz to the 40 GHz.
- (2) "F" denotes fundamental frequency; "H" denotes spurious frequency. "E" denotes band edge frequency.
- (3) * denotes emission frequency which appearing within the Restricted Bands specified in provision of 15.205, then the general radiated emission limits in 15.209 apply.
- (4) The emissions are attenuated more than 20dB below the permissible limits are not record in the report.
- (5) The IF bandwidth of EMI Test Receiver between 30MHz to 1GHz was 120KHz, 1 MHz for measuring above 1 GHz, below 30MHz was 10KHz.
- (6) When the test results of Peak Detected below the limits of Average Detected, the Average Detected is not need completed. For example: Top Channel at Fundamental 73.16dBuV/m(PK Value) <93.98(AV Limit), at harmonic 53.20 dBuV/m(PK Value) <54 dBuV/m(AV Limit), the Average Detected not need to completed.



5.2G 802.11n40 Mode

All modes of operation were investigated and the worst-case of MIMO are reported.

LOW CH 38

Horizontal:

Frequency	Meter Reading	Factor	Emission Level	Limits	Margin	Detector Type
(MHz)	(dB μ V)	(dB)	(dB μ V/m)	(dB μ V/m)	(dB)	
3647	63.59	-4.59	59	74	-15	peak
3647	48.35	-4.59	43.76	54	-10.24	AVG
10360	54.66	3.74	58.4	68.2	-9.8	peak

Remark: Factor = Antenna Factor + Cable Loss – Pre-amplifier.

Vertical:

Frequency	Meter Reading	Factor	Emission Level	Limits	Margin	Detector Type
(MHz)	(dB μ V)	(dB)	(dB μ V/m)	(dB μ V/m)	(dB)	
3647	63.37	-4.59	58.78	74	-15.22	peak
3647	47.28	-4.59	42.69	54	-11.31	AVG
10360	54.71	3.74	58.45	68.2	-9.75	peak

Remark: Factor = Antenna Factor + Cable Loss – Pre-amplifier.

HIGH CH 46
Horizontal:

Frequency	Meter Reading	Factor	Emission Level	Limits	Margin	Detector Type
(MHz)	(dB μ V)	(dB)	(dB μ V/m)	(dB μ V/m)	(dB)	
3647	61.34	-4.59	56.75	74	-17.25	peak
3647	46.66	-4.59	42.07	54	-11.93	AVG
10480	55.38	3.75	59.13	68.2	-9.07	peak

Remark: Factor = Antenna Factor + Cable Loss – Pre-amplifier.

Vertical:

Frequency	Meter Reading	Factor	Emission Level	Limits	Margin	Detector Type
(MHz)	(dB μ V)	(dB)	(dB μ V/m)	(dB μ V/m)	(dB)	
3647	63.46	-4.59	58.87	74	-15.13	peak
3647	47.22	-4.59	42.63	54	-11.37	AVG
10480	53.39	3.75	57.14	68.2	-11.06	peak

Remark: Factor = Antenna Factor + Cable Loss – Pre-amplifier.

Remark:

- (1) Measuring frequencies from 1 GHz to the 40 GHz.
- (2) "F" denotes fundamental frequency; "H" denotes spurious frequency. "E" denotes band edge frequency.
- (3) * denotes emission frequency which appearing within the Restricted Bands specified in provision of 15.205, then the general radiated emission limits in 15.209 apply.
- (4) The emissions are attenuated more than 20dB below the permissible limits are not record in the report.
- (5) The IF bandwidth of EMI Test Receiver between 30MHz to 1GHz was 120KHz, 1 MHz for measuring above 1 GHz, below 30MHz was 10KHz.
- (6) When the test results of Peak Detected below the limits of Average Detected, the Average Detected is not need completed. For example: Top Channel at Fundamental 73.16dBuV/m(PK Value) <93.98(AV Limit), at harmonic 53.20 dBuV/m(PK Value) <54 dBuV/m(AV Limit), the Average Detected not need to completed.



5.2G 802.11ac20 Mode

All modes of operation were investigated and the worst-case of MIMO are reported.

LOW CH 36

Horizontal:

Frequency	Meter Reading	Factor	Emission Level	Limits	Margin	Detector Type
(MHz)	(dB μ V)	(dB)	(dB μ V/m)	(dB μ V/m)	(dB)	
3647	64.38	-4.59	59.79	74	-14.21	peak
3647	49.47	-4.59	44.88	54	-9.12	AVG
10360	55.66	3.74	59.4	68.2	-8.8	peak

Remark: Factor = Antenna Factor + Cable Loss – Pre-amplifier.

Vertical:

Frequency	Meter Reading	Factor	Emission Level	Limits	Margin	Detector Type
(MHz)	(dB μ V)	(dB)	(dB μ V/m)	(dB μ V/m)	(dB)	
3647	63.75	-4.59	59.16	74	-14.84	peak
3647	46.86	-4.59	42.27	54	-11.73	AVG
10360	51.63	3.74	55.37	68.2	-12.83	peak

Remark: Factor = Antenna Factor + Cable Loss – Pre-amplifier.



MID CH40
Horizontal:

Frequency	Meter Reading	Factor	Emission Level	Limits	Margin	Detector Type
(MHz)	(dB μ V)	(dB)	(dB μ V/m)	(dB μ V/m)	(dB)	
3647	64.33	-4.59	59.74	74	-14.26	peak
3647	47.72	-4.59	43.13	54	-10.87	AVG
10400	55.47	3.74	59.21	68.2	-8.99	peak

Remark: Factor = Antenna Factor + Cable Loss – Pre-amplifier.

Vertical:

Frequency	Meter Reading	Factor	Emission Level	Limits	Margin	Detector Type
(MHz)	(dB μ V)	(dB)	(dB μ V/m)	(dB μ V/m)	(dB)	
3647	62.59	-4.59	58	74	-16	peak
3647	46.27	-4.59	41.68	54	-12.32	AVG
10400	54.81	3.74	58.55	68.2	-9.65	peak

Remark: Factor = Antenna Factor + Cable Loss – Pre-amplifier.



HIGH CH 48
Horizontal:

Frequency	Meter Reading	Factor	Emission Level	Limits	Margin	Detector Type
(MHz)	(dB μ V)	(dB)	(dB μ V/m)	(dB μ V/m)	(dB)	
3647	62.46	-4.59	57.87	74	-16.13	peak
3647	46.39	-4.59	41.8	54	-12.2	AVG
10480	55.11	3.75	58.86	68.2	-9.34	peak

Remark: Factor = Antenna Factor + Cable Loss – Pre-amplifier.

Vertical:

Frequency	Meter Reading	Factor	Emission Level	Limits	Margin	Detector Type
(MHz)	(dB μ V)	(dB)	(dB μ V/m)	(dB μ V/m)	(dB)	
3647	63.39	-4.59	58.8	74	-15.2	peak
3647	47.74	-4.59	43.15	54	-10.85	AVG
10480	53.22	3.75	56.97	68.2	-11.23	peak

Remark: Factor = Antenna Factor + Cable Loss – Pre-amplifier.

Remark:

- (1) Measuring frequencies from 1 GHz to the 40 GHz.
- (2) "F" denotes fundamental frequency; "H" denotes spurious frequency. "E" denotes band edge frequency.
- (3) * denotes emission frequency which appearing within the Restricted Bands specified in provision of 15.205, then the general radiated emission limits in 15.209 apply.
- (4) The emissions are attenuated more than 20dB below the permissible limits are not record in the report.
- (5) The IF bandwidth of EMI Test Receiver between 30MHz to 1GHz was 120KHz, 1 MHz for measuring above 1 GHz, below 30MHz was 10KHz.
- (6) When the test results of Peak Detected below the limits of Average Detected, the Average Detected is not need completed. For example: Top Channel at Fundamental 73.16dBuV/m(PK Value) <93.98(AV Limit), at harmonic 53.20 dBuV/m(PK Value) <54 dBuV/m(AV Limit), the Average Detected not need to completed.



5.2G 802.11ac40 Mode

All modes of operation were investigated and the worst-case of MIMO are reported.

LOW CH 38

Horizontal:

Frequency	Meter Reading	Factor	Emission Level	Limits	Margin	Detector Type
(MHz)	(dB μ V)	(dB)	(dB μ V/m)	(dB μ V/m)	(dB)	
3647	64.28	-4.59	59.69	74	-14.31	peak
3647	49.19	-4.59	44.6	54	-9.4	AVG
10360	55.43	3.74	59.17	68.2	-9.03	peak

Remark: Factor = Antenna Factor + Cable Loss – Pre-amplifier.

Vertical:

Frequency	Meter Reading	Factor	Emission Level	Limits	Margin	Detector Type
(MHz)	(dB μ V)	(dB)	(dB μ V/m)	(dB μ V/m)	(dB)	
3647	63.77	-4.59	59.18	74	-14.82	peak
3647	47.63	-4.59	43.04	54	-10.96	AVG
10360	53.44	3.74	57.18	68.2	-11.02	peak

Remark: Factor = Antenna Factor + Cable Loss – Pre-amplifier.

HIGH CH 46
Horizontal:

Frequency	Meter Reading	Factor	Emission Level	Limits	Margin	Detector Type
(MHz)	(dB μ V)	(dB)	(dB μ V/m)	(dB μ V/m)	(dB)	
3647	62.22	-4.59	57.63	74	-16.37	peak
3647	46.61	-4.59	42.02	54	-11.98	AVG
10480	56.82	3.75	60.57	68.2	-7.63	peak

Remark: Factor = Antenna Factor + Cable Loss – Pre-amplifier.

Vertical:

Frequency	Meter Reading	Factor	Emission Level	Limits	Margin	Detector Type
(MHz)	(dB μ V)	(dB)	(dB μ V/m)	(dB μ V/m)	(dB)	
3647	62.43	-4.59	57.84	74	-16.16	peak
3647	48.75	-4.59	44.16	54	-9.84	AVG
10480	53.66	3.75	57.41	68.2	-10.79	peak

Remark: Factor = Antenna Factor + Cable Loss – Pre-amplifier.

Remark:

- (1) Measuring frequencies from 1 GHz to the 40 GHz.
- (2) "F" denotes fundamental frequency; "H" denotes spurious frequency. "E" denotes band edge frequency.
- (3) * denotes emission frequency which appearing within the Restricted Bands specified in provision of 15.205, then the general radiated emission limits in 15.209 apply.
- (4) The emissions are attenuated more than 20dB below the permissible limits are not record in the report.
- (5) The IF bandwidth of EMI Test Receiver between 30MHz to 1GHz was 120KHz, 1 MHz for measuring above 1 GHz, below 30MHz was 10KHz.
- (6) When the test results of Peak Detected below the limits of Average Detected, the Average Detected is not need completed. For example: Top Channel at Fundamental 73.16dBuV/m(PK Value) <93.98(AV Limit), at harmonic 53.20 dBuV/m(PK Value) <54 dBuV/m(AV Limit), the Average Detected not need to completed.



5.2G 802.11ac80 Mode

All modes of operation were investigated and the worst-case of MIMO are reported.

CH 42

Horizontal:

Frequency	Meter Reading	Factor	Emission Level	Limits	Margin	Detector Type
(MHz)	(dB μ V)	(dB)	(dB μ V/m)	(dB μ V/m)	(dB)	
3647	64.47	-4.59	59.88	74	-14.12	peak
3647	49.33	-4.59	44.74	54	-9.26	AVG
10360	56.12	3.74	59.86	68.2	-8.34	peak

Remark: Factor = Antenna Factor + Cable Loss – Pre-amplifier.

Vertical:

Frequency	Meter Reading	Factor	Emission Level	Limits	Margin	Detector Type
(MHz)	(dB μ V)	(dB)	(dB μ V/m)	(dB μ V/m)	(dB)	
3647	63.38	-4.59	58.79	74	-15.21	peak
3647	47.66	-4.59	43.07	54	-10.93	AVG
10360	53.27	3.74	57.01	68.2	-11.19	peak

Remark: Factor = Antenna Factor + Cable Loss – Pre-amplifier.

Remark:

- (1) Measuring frequencies from 1 GHz to the 40 GHz.
- (2) "F" denotes fundamental frequency; "H" denotes spurious frequency. "E" denotes band edge frequency.
- (3) * denotes emission frequency which appearing within the Restricted Bands specified in provision of 15.205, then the general radiated emission limits in 15.209 apply.
- (4) The emissions are attenuated more than 20dB below the permissible limits are not record in the report.
- (5) The IF bandwidth of EMI Test Receiver between 30MHz to 1GHz was 120KHz, 1 MHz for measuring above 1 GHz, below 30MHz was 10KHz.
- (6) When the test results of Peak Detected below the limits of Average Detected, the Average Detected is not need completed. For example: Top Channel at Fundamental 73.16dBuV/m(PK Value) <93.98(AV Limit), at harmonic 53.20 dBuV/m(PK Value) <54 dBuV/m(AV Limit), the Average Detected not need to completed.



4.8. Frequency Stability Measurement

4.8.1. Test Specification

Test Requirement:	FCC Part15 Section 15.407(g)
Test Method:	ANSI C63.10: 2013
Limit:	The frequency tolerance shall be maintained within the band of operation frequency over a temperature variation of 0 degrees to 35 degrees C at normal supply voltage, and for a variation in the primary supply voltage from 85% to 115% of the rated supply voltage at a temperature of 20 degrees C.
Test Setup:	<pre> graph TD SA[Spectrum Analyzer] --- EUT[EUT] subgraph TC [Temperature Chamber] EUT end P[AC/DC Power supply] --- EUT </pre>
Test Procedure:	The EUT was placed inside the environmental test chamber and powered by nominal AC/DC voltage. b. Turn the EUT on and couple its output to a spectrum analyzer. c. Turn the EUT off and set the chamber to the highest temperature specified. d. Allow sufficient time (approximately 30 min) for the temperature of the chamber to stabilize. e. Repeat step 2 and 3 with the temperature chamber set to the lowest temperature. f. The test chamber was allowed to stabilize at +20 degree C for a minimum of 30 minutes. The supply voltage was then adjusted on the EUT from 85% to 115% and the frequency record.
Test Result:	PASS
Remark:	N/A

**Test Result as follows:**

Mode	Voltage (V)	FHL (5180MHz)	Deviation (KHz)	FHH (5240MHz)	Deviation (KHz)
5.2G Band	12V	5179.976	-24	5240.035	35
	13.8 V	5180.025	25	5239.969	-31
	10.2 V	5179.954	-46	5239.982	-18

Mode	Temperature (°C)	FHL (5180MHz)	Deviation (KHz)	FHH (5240MHz)	Deviation (KHz)
5.2G Band	-30	5179.963	-37	5240.034	34
	-20	5180.009	9	5239.992	-8
	-10	5180.035	35	5240.033	33
	0	5179.997	-3	5239.975	-25
	10	5179.943	-57	5239.985	-15
	20	5180.025	25	5239.974	-26
	30	5179.983	-17	5240.021	21
	40	5180.042	42	5239.966	-34
	50	5180.033	33	5239.963	-37

4.9. ANTENNA REQUIREMENT

Standard Applicable

For intentional device, according to FCC 47 CFR Section 15.203, an intentional radiator shall be designed to ensure that no antenna other than that furnished by the responsible party shall be used with the device. And according to FCC 47 CFR Section 15.249, if transmitting antennas of directional gain greater than 6dBi are used, the power shall be reduced by the amount in dB that the directional gain of the antenna exceeds 6dBi.

Refer to statement below for compliance.

The manufacturer may design the unit so that the user can replace a broken antenna, but the use of a standard antenna jack or electrical connector is prohibited. Further, this requirement does not apply to intentional radiators that must be professionally installed.

Antenna Connected Construction

The antenna used in this product is a Internal antenna, need professional installation, not easy to remove. It conforms to the standard requirements. The directional gains of antenna used for transmitting is 3dBi.

WIFI ANTENNA

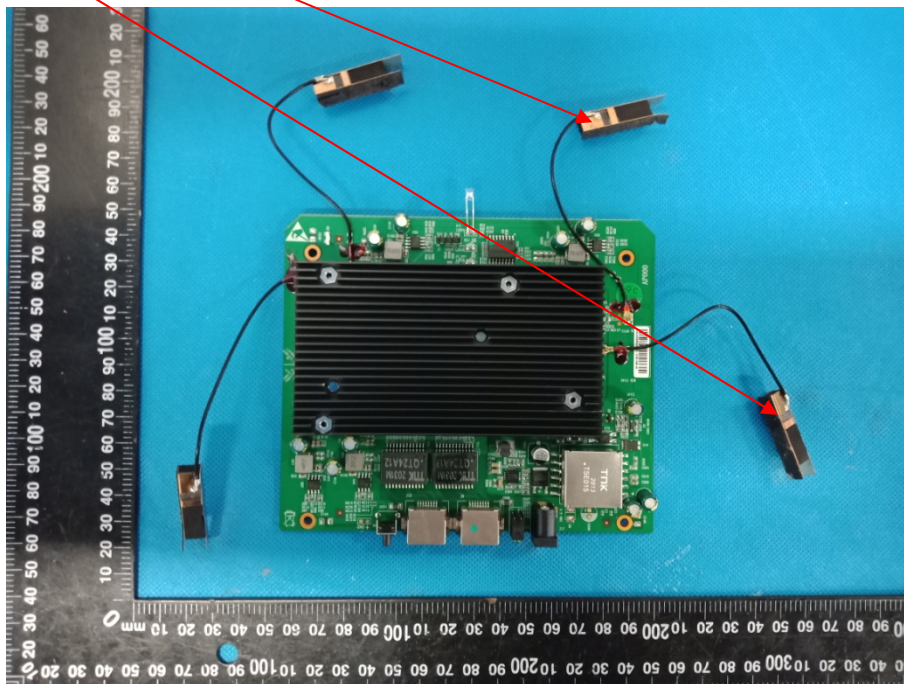

4.10. Photographs of Test Setup

Radiated Emission

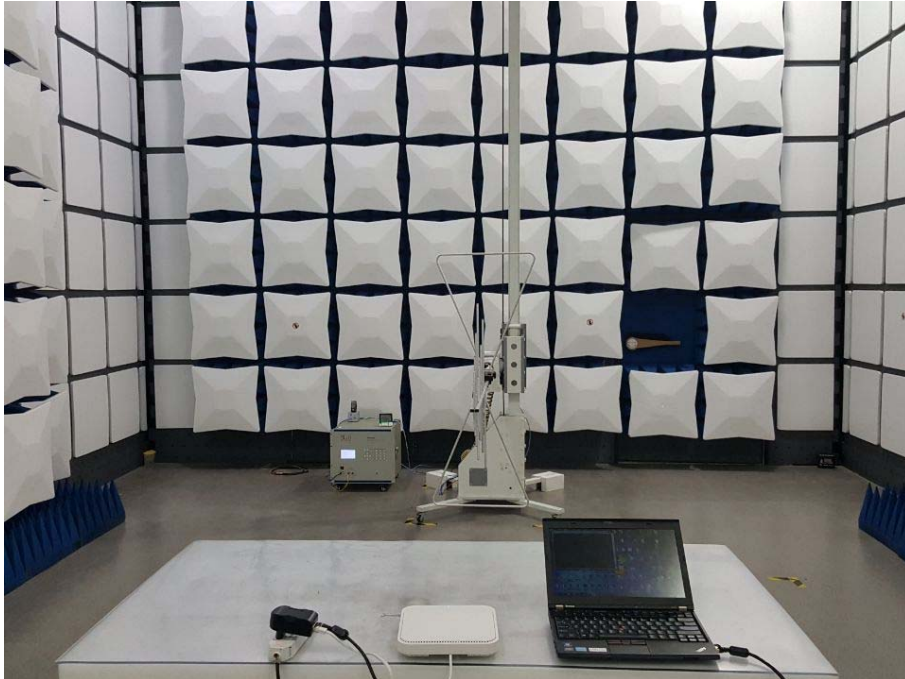



Conducted Emission





4.11. PHOTOS OF THE EUT

Reference to the reporter : ANNEX A of external photos and ANNEX B of internal photos

*****End of Report*****