

# PTSGOB8W

## Quick Start Guide



## Introduction

Thank you for your choosing the new Tablet PC.

This guide serves to enable users to get to know and familiar with our product as soon as possible.

Here we have made a brief introduction to the key layout and definitions in figures and words.

## Contents

<b>I . Precautions before Use</b>	<b>3</b>
<b>II .Key Layout and Definitions</b>	<b>4</b>
<b>VI. Introduction to Desktop</b>	<b>5</b>
1. Windows10 Start Screen	5
2. Image slide applications	5
3.Introduction to app Interface	6
4.Charm menu column	8
5.Multitasking operating interface	9
<b>V . Basic Operations</b>	<b>10</b>
2.Sleep, restart and power off	10

## I . Precautions before Use

1. This production is suitable for use in non-tropic areas below 2,000 meters, and the mark  in the nameplate indicates the product is suitable for use in non-tropic areas.
2. Prevent the Tablet PC from falling to the ground or being strongly impacted otherwise.
3. Do not use it in the long term in any environment where the air is too cold, too hot (<35°C), too humid or with too much dust. Do not expose the Tablet PC to sunlight.
4. Avoid using it in the strong magnetic and strong static environment as much as possible.
5. Once any water or other liquid splashes onto the Tablet PC, close it immediately and do not use it until it dries out.
6. Do not clean the Tablet PC with any detergent containing chemical element or other liquid to avoid causing damage due to corrosion and becoming damp. If cleaning is really necessary, clean it with dry soft cloth tissue paper.
7. Our company shall not bear any and all responsibilities for loss or deletion of material inside the machine caused due to abnormal software and hardware operation, maintenance or any other accident.
8. Please back up your important material at any time to avoid loss.
9. Please do not disassemble the Tablet PC by yourself; otherwise you will lose the right to warranty.
10. This product supports the overwhelming majority of mainstream brands of 3G DONGLE network cards. The cases for 3G Dongle may be different. It is suggested that you test it to make sure it is OK before buying it.
11. Quick Use Guide and the relevant software shall be updated at any time. For updated software version, visit [www.xxx.com](http://www.xxx.com) for downloading by yourself, and no notice shall be given otherwise. If any anything is found to be inconsistent with the Quick Use Guide, the material object shall prevail.
12. Replacement with incorrect type batteries may cause explosion. Make sure to use original batteries.

## II .Key Layout and Definitions

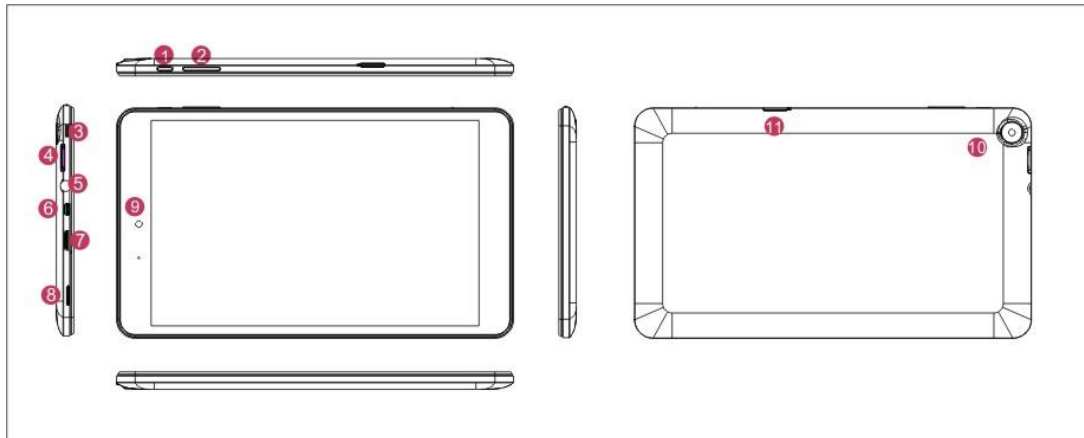

- ① Power button: Press it down to start or close the touch screen panel. You can also let the computer to enter dormancy through this button or wake from the dormancy mode.
- ② Sound-/sound+: Lower/raise volume
- ③ Windows key: Press this button to return to the Start screen.
- ④ MicroSD& MicroSDHC Micro SD card slot: The built-in storage card reader slot supports MicroSD and MicroSDHC format.
- ⑤ Socket for earphone and microphone: This socket can transmit the audio signals of Tablet PC to loudspeaker or earphone.
- ⑥ Micro HDMI Interface: High-Definition Multimedia Interface
- ⑦ Micro USB Interface: You can read the data through USB.
- ⑧ Loudspeaker: The built-in loudspeaker enables you to hear the sound without having to linking additional device.
- ⑨ Front camera: take photos, and record pictures
- ⑩ Back camera: take photos, and record pictures.
- ⑪ 3G Interface: Built-in 3G module, 3G Internet support.( no this option if without 3g function)

## VI. Introduction to Desktop

### 1. Windows10 Start Screen

Windows 10 start image: On the start screen, you can see many programs fixed in the image. These application programs are displayed in the form of “magnet”. As long as you click them, you can easily visit them.

You need to log on your Microsoft account before the application program completely runs.

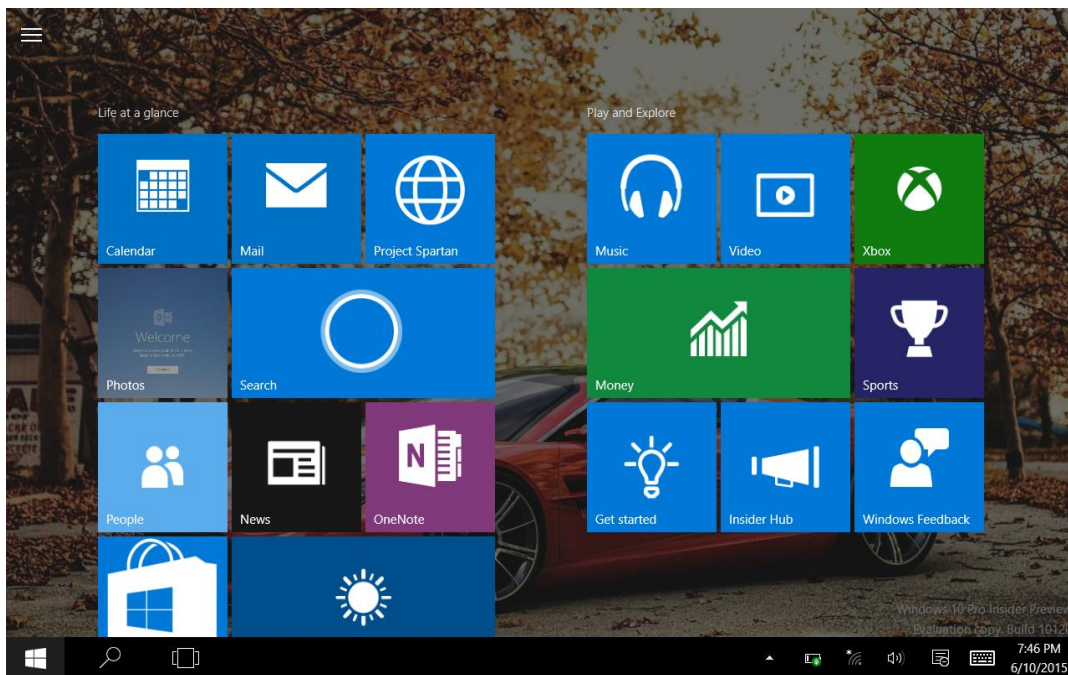

### 2. Image slide applications

Slide to right



Slide to the right from the left side of the screen to scan the application program in running.

Slide to left

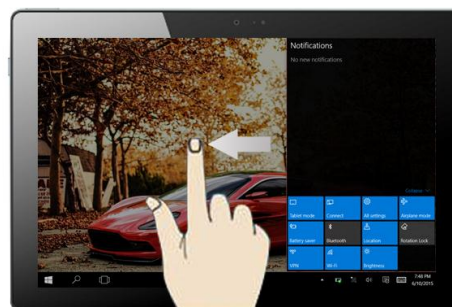

Slide to the left from the right side of the screen to setting Charm menu column.

Slide downward



Slide with finger



In start screen, slide from the top of the screen to view application programs

In start screen, slide finger up and down to move the image.

### 3.Introduction to app Interface

Besides the application programs already fixed on the start screen, you can also start other application programs in all application programs, such as other software application programs attached to the Tablet PC.

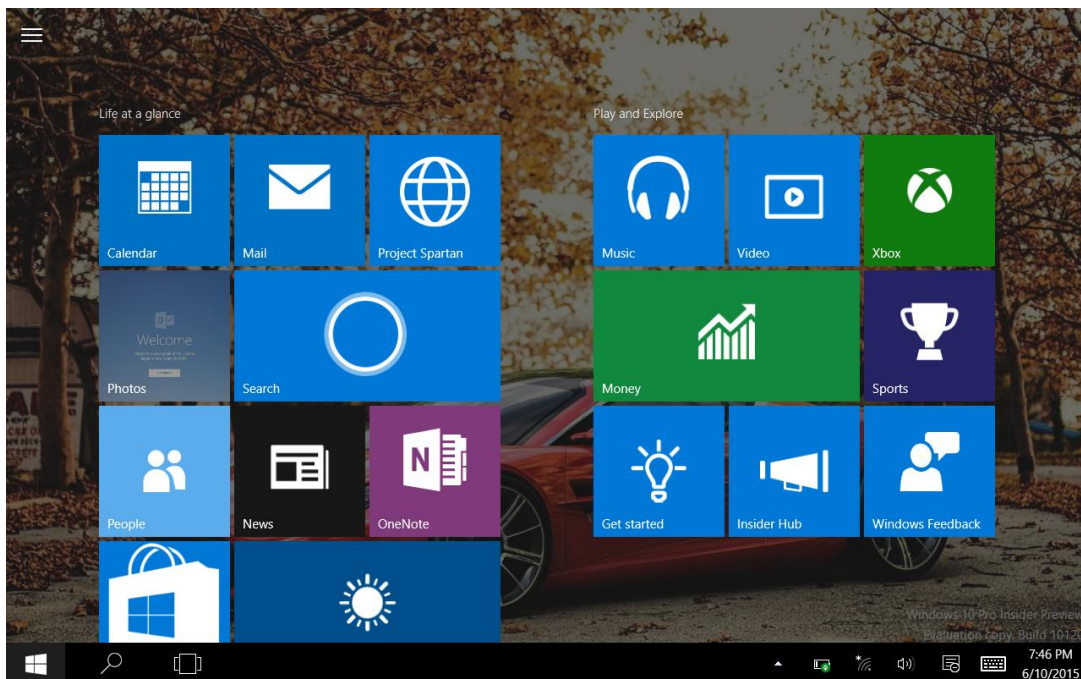



If you want to fix more application programs on the start interface, see the operation in the figure below, (1) Click the properties icon(2) press and hold the application program magnet for about one second and then let go (3) Click the Pin to start

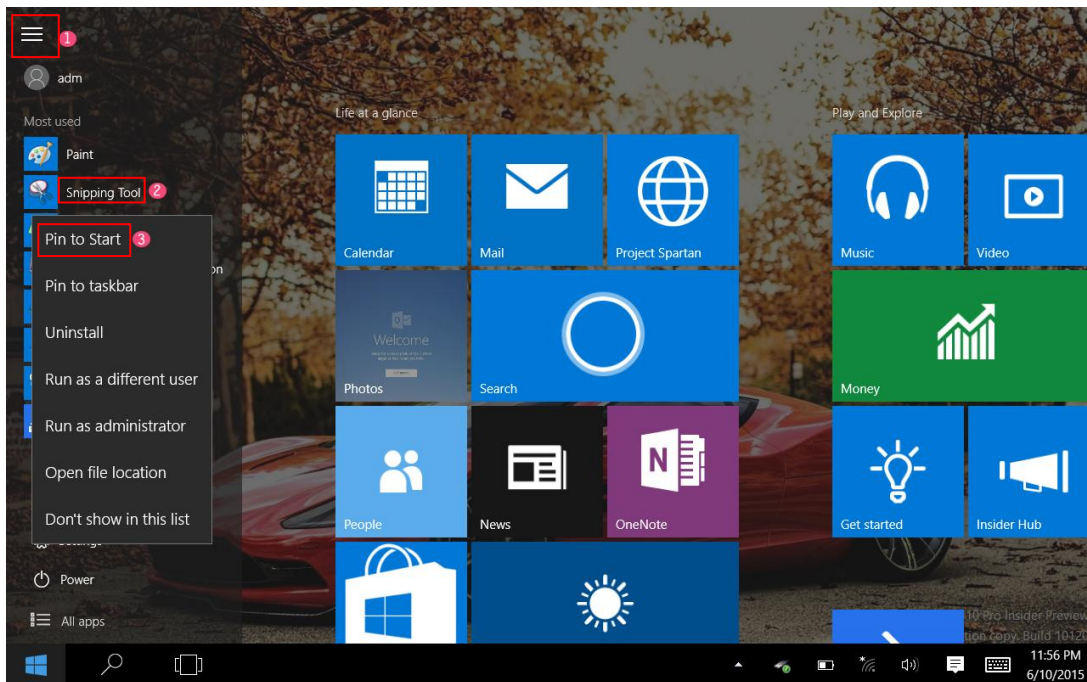

Conversely, if you want to cancel or delete a certain application in the start screen, (1) lightly touch, press and hold the application program magnet for about one second and then let it go and run, and select

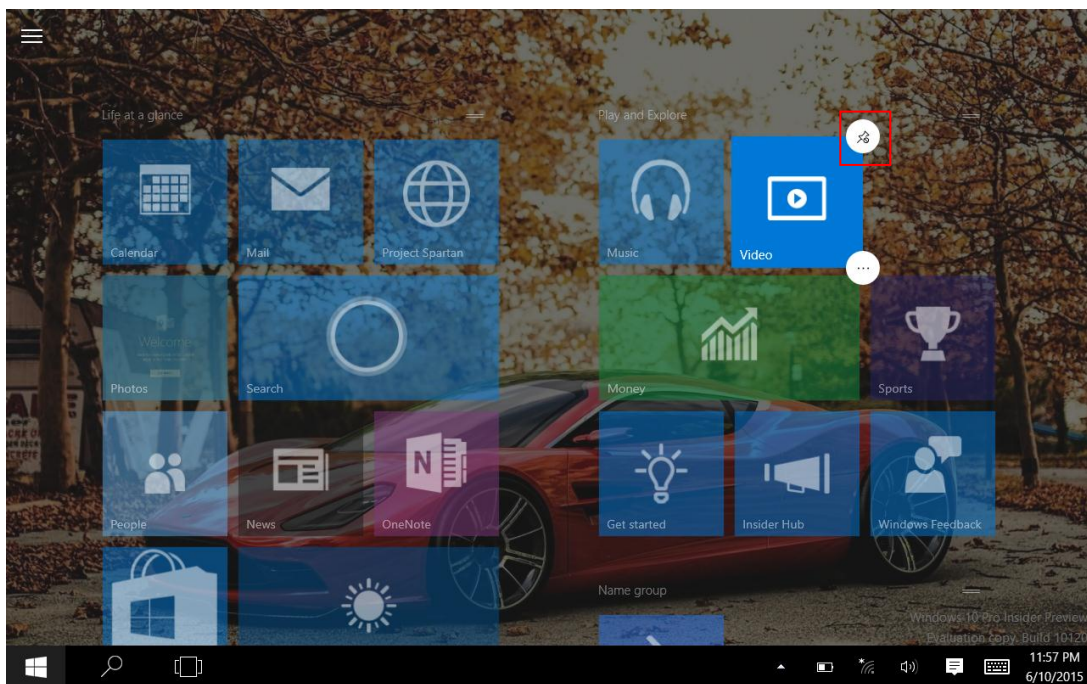

#### 4. Charm menu column

Slide it to the left from the right side of the screen to start Charm menu column, including: Start, Device, Setup, Share, and Search Program.

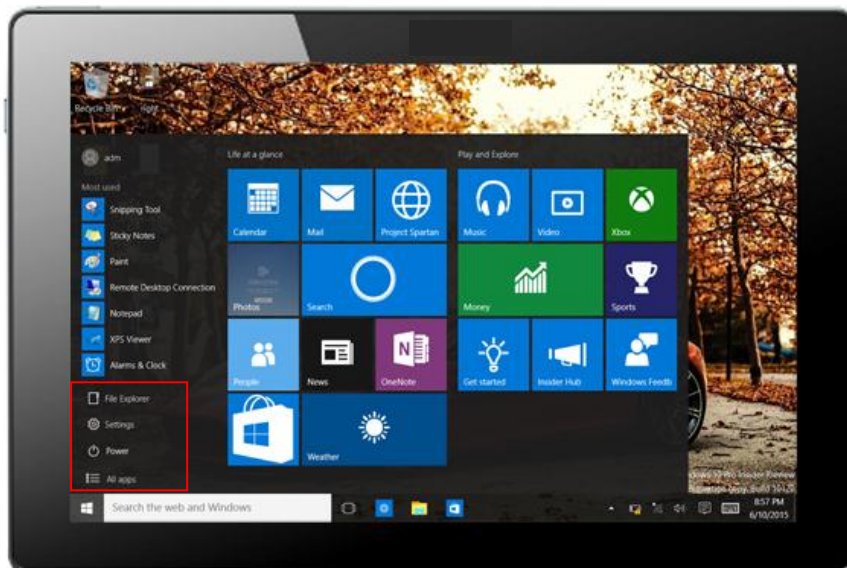

Slide it to the left from the right side of the screen to start Charm menu column, Usually: File Explorer, Settings, Power, and All apps

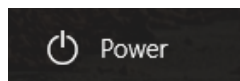

Can Sleep/Shut down/Restart the Tablet PC

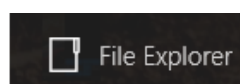

Can let you search the files and application programs in the Tablet PC.

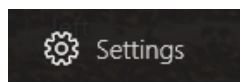

Can let you set up the Table PC.

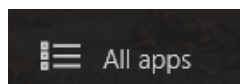

Can scan more apps



Search menu



Device Menu

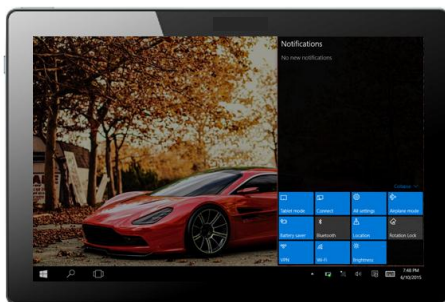

Set up Menu

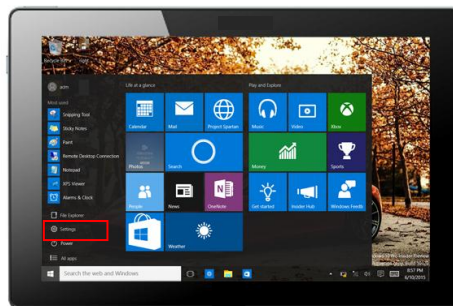

## 5. Multitasking operating interface

slide it right from the left side of the screen, Let go when Can see the running applications. We can enter the application, also can be deleted.

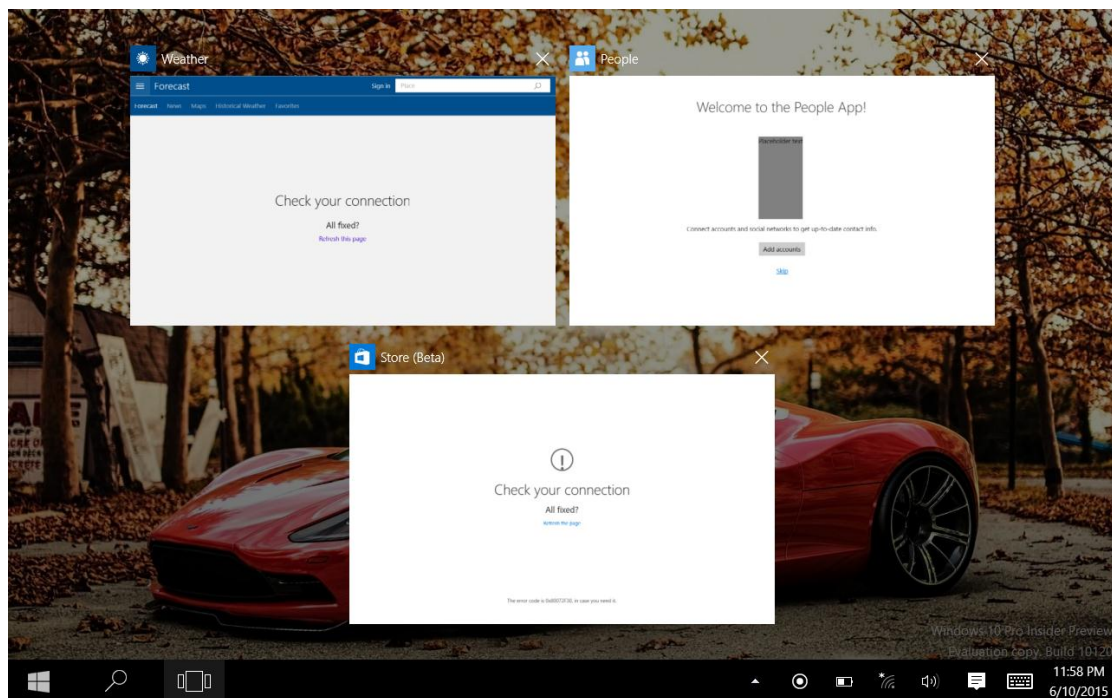

## V. Basic Operations

### 2.Sleep, restart and power off

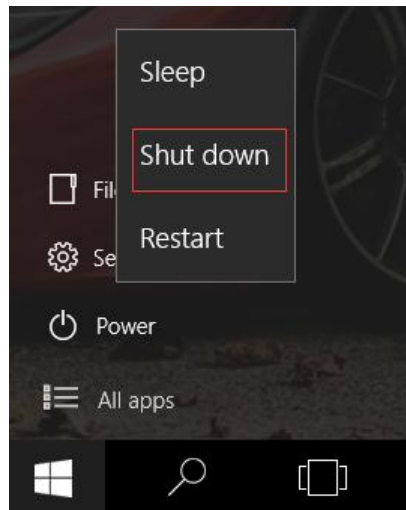
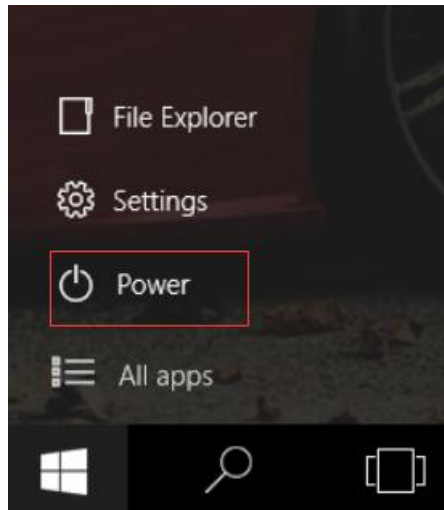

## Warning Statement

This equipment has been tested and found to comply with the limits for a Class B digital device, pursuant to part 15 of the FCC Rules. These limits are designed to provide reasonable protection against harmful interference in a residential installation. This equipment generates, uses and can radiate radio frequency energy and, if not installed and used in accordance with the instructions, may cause harmful interference to radio communications. However, there is no guarantee that interference will not occur in a particular installation. If this equipment does cause harmful interference to radio or television reception, which can be determined by turning the equipment off and on, the user is encouraged to try to correct the interference by one or more of the following measures:

- Reorient or relocate the receiving antenna.
- Increase the separation between the equipment and receiver.
- Connect the equipment into an outlet on a circuit different from that to which the receiver is connected.
- Consult the dealer or an experienced radio/TV technician for help.

Caution: Any changes or modifications to this device not explicitly approved by manufacturer could void your authority to operate this equipment.

This device complies with part 15 of the FCC Rules. Operation is subject to the following two conditions: (1) This device may not cause harmful interference, and (2) this device must accept any interference received, including interference that may cause undesired operation.

The device has been evaluated to meet general RF exposure requirement. The device can be used in portable exposure condition without restriction.