

SGS

Internal photos of EUT

- Basic Model

Internal view of EUT



Top view of Main PCB

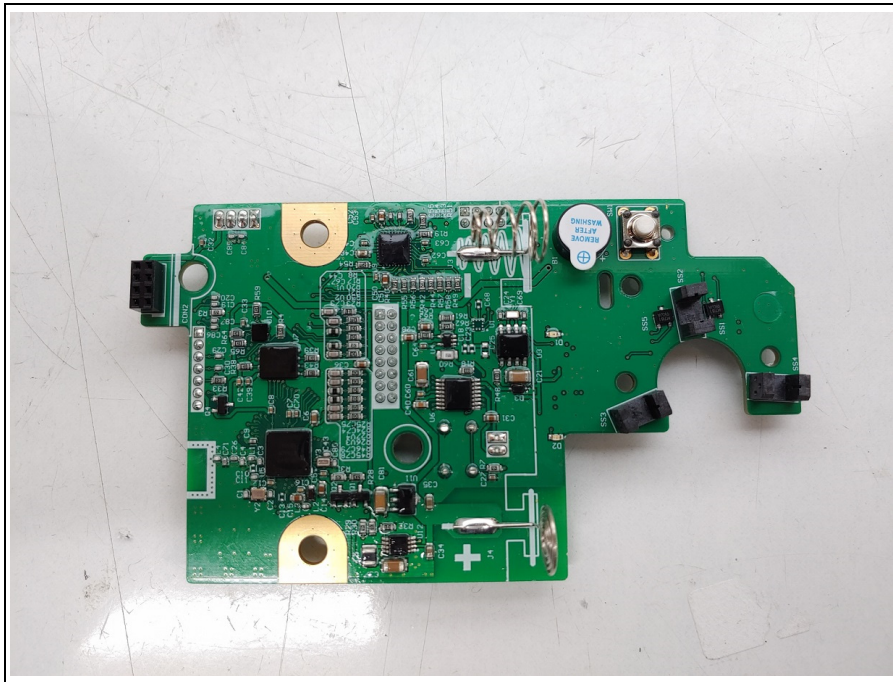

Bottom view of Main PCB

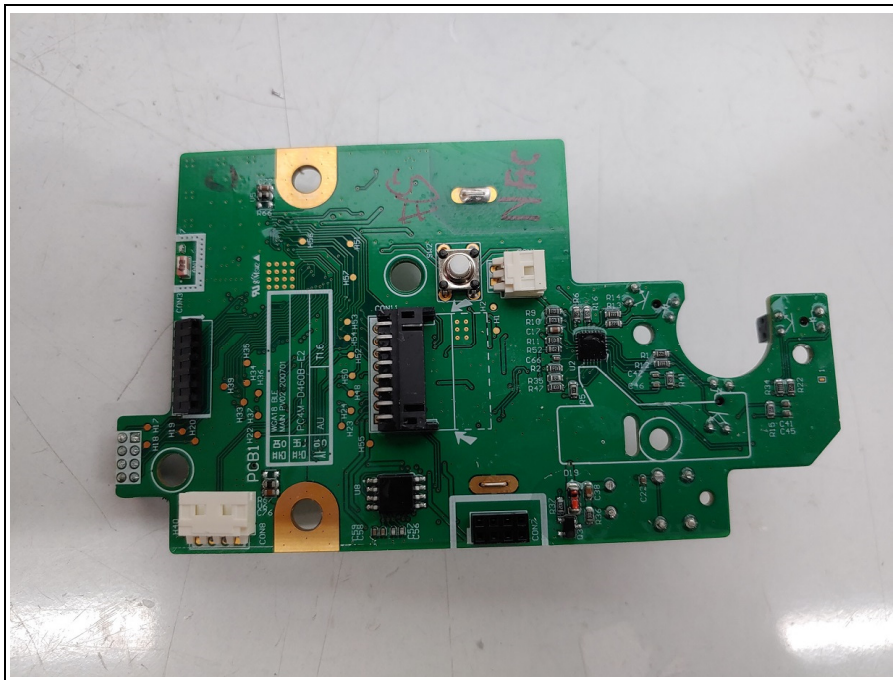

Top view of Sub PCB

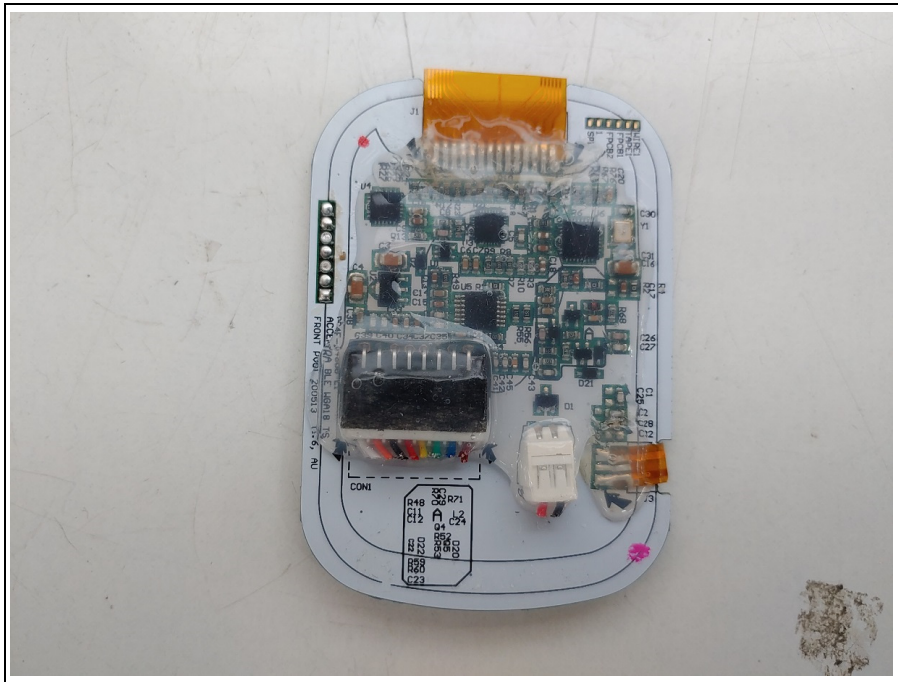

Bottom view of Sub PCB

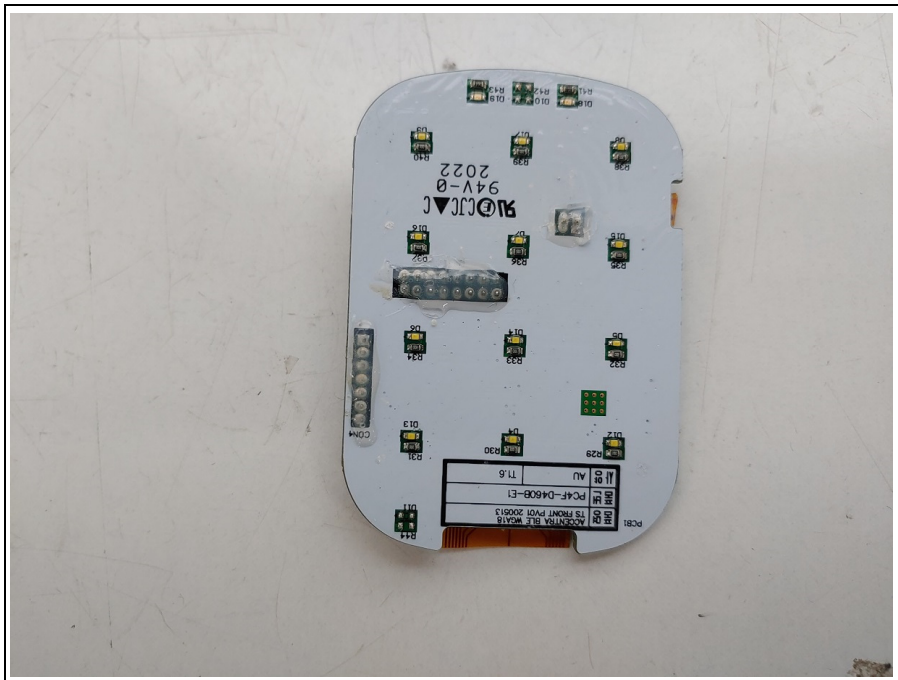

View of Antenna

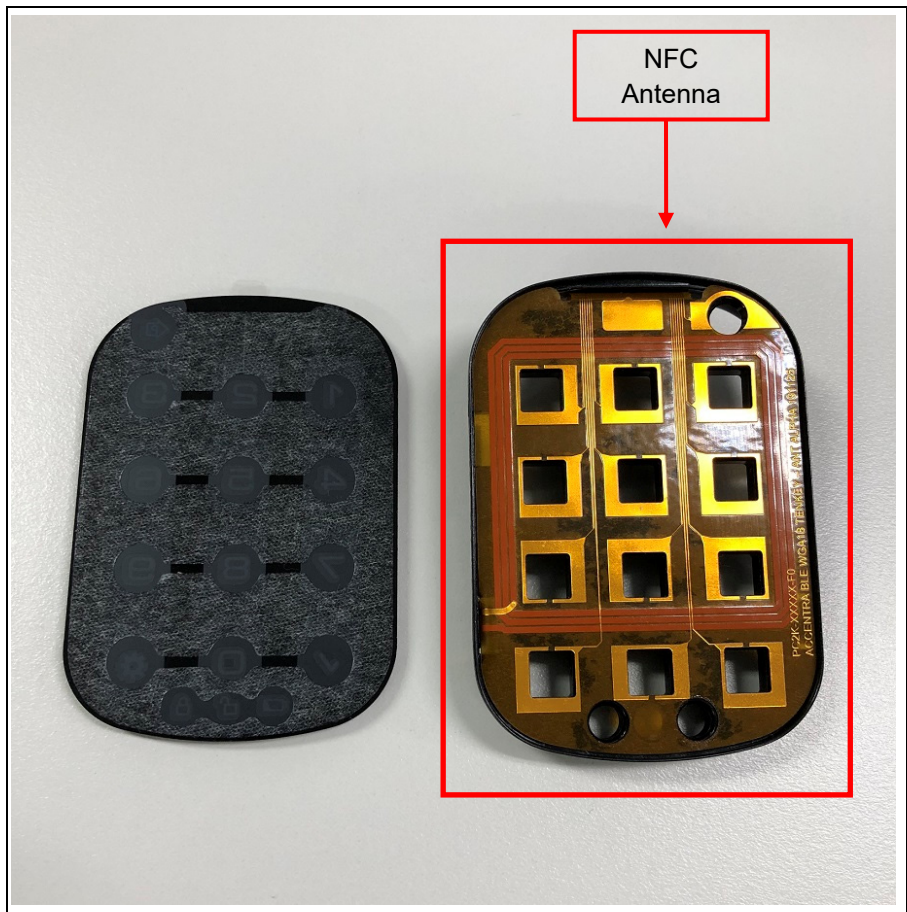
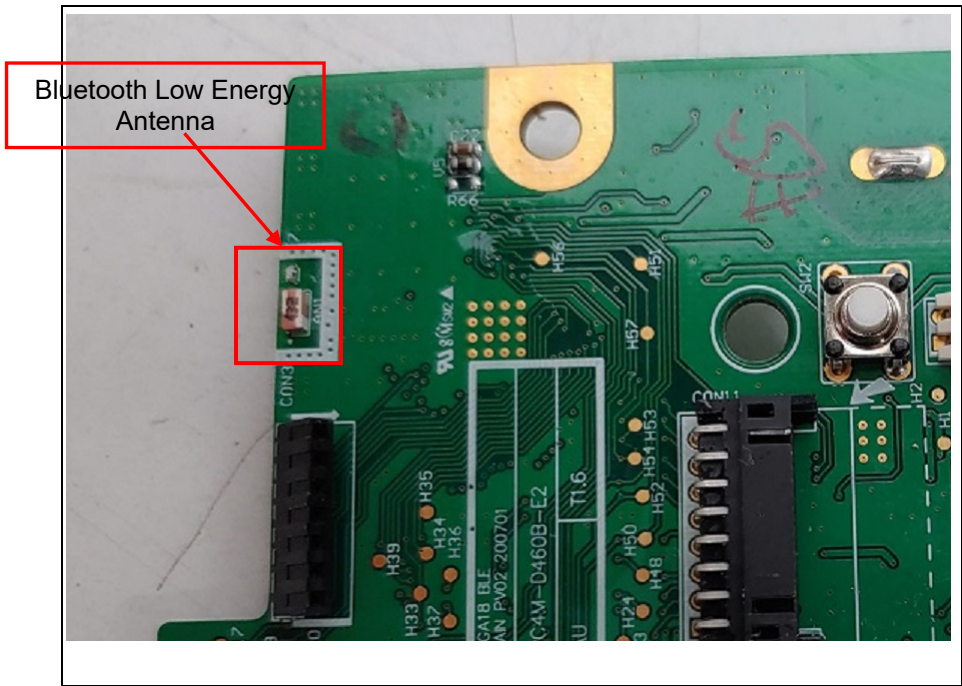

View of Module

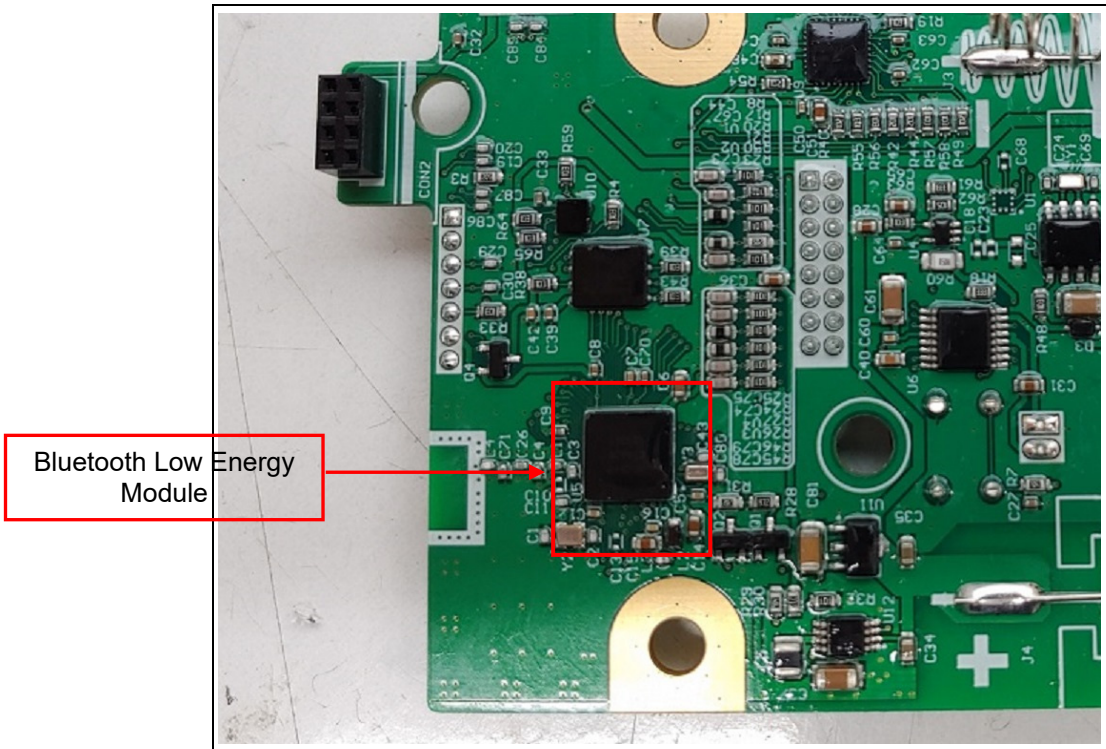

- Variant Model

Internal view of EUT

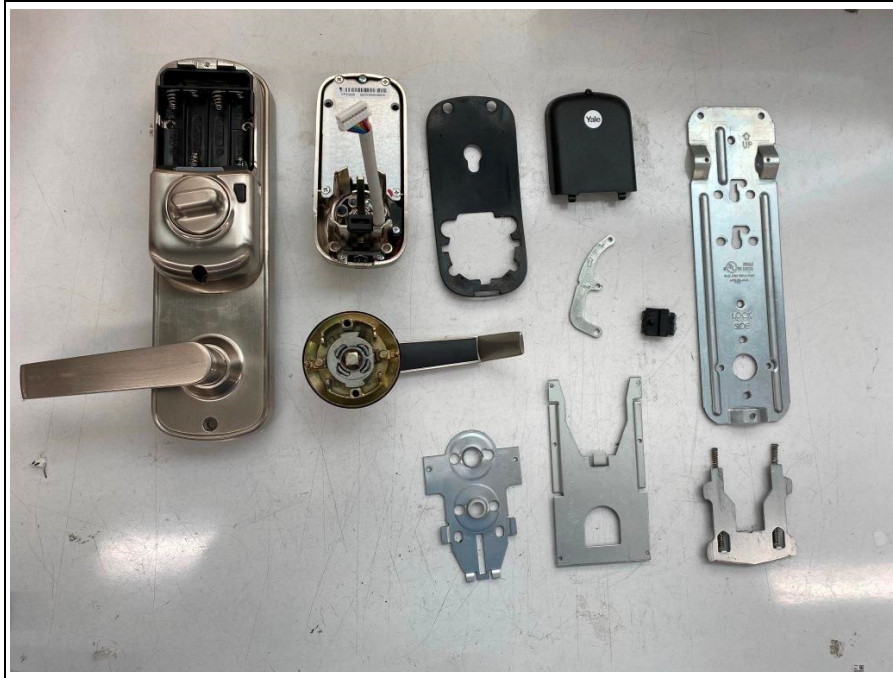

Top view of Main PCB

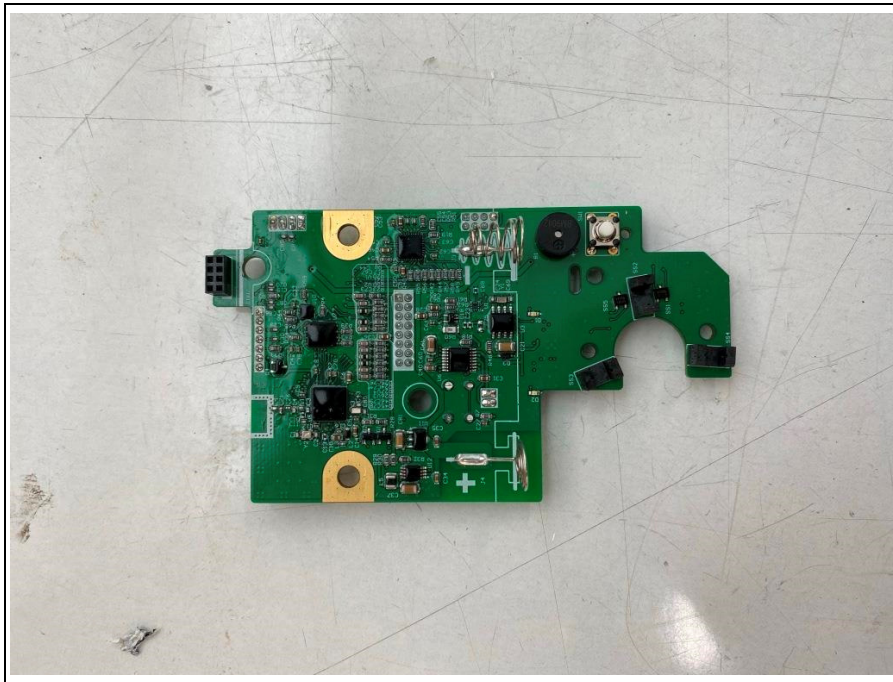

Bottom view of Main PCB

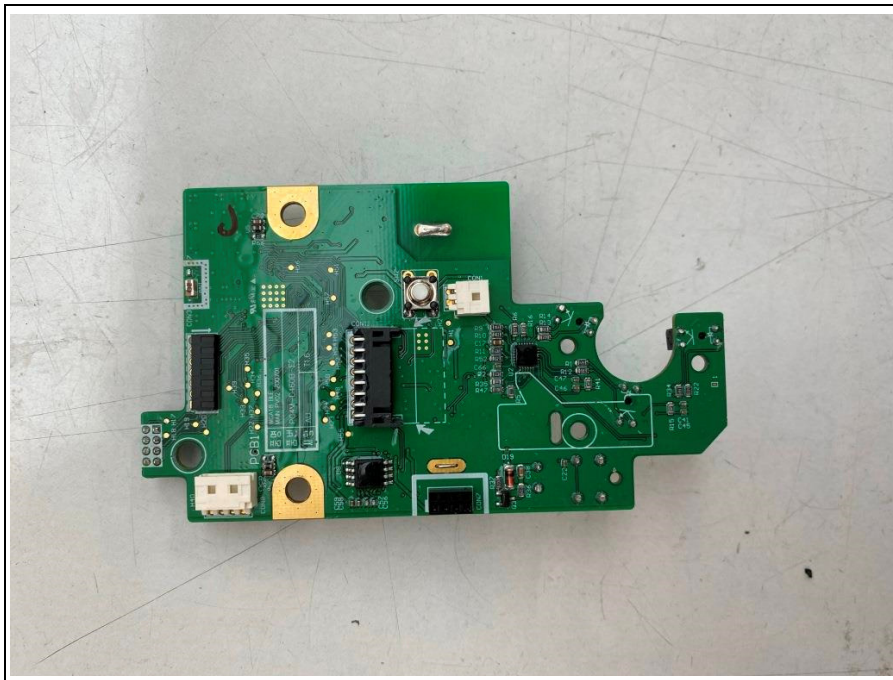

Top view of Sub PCB

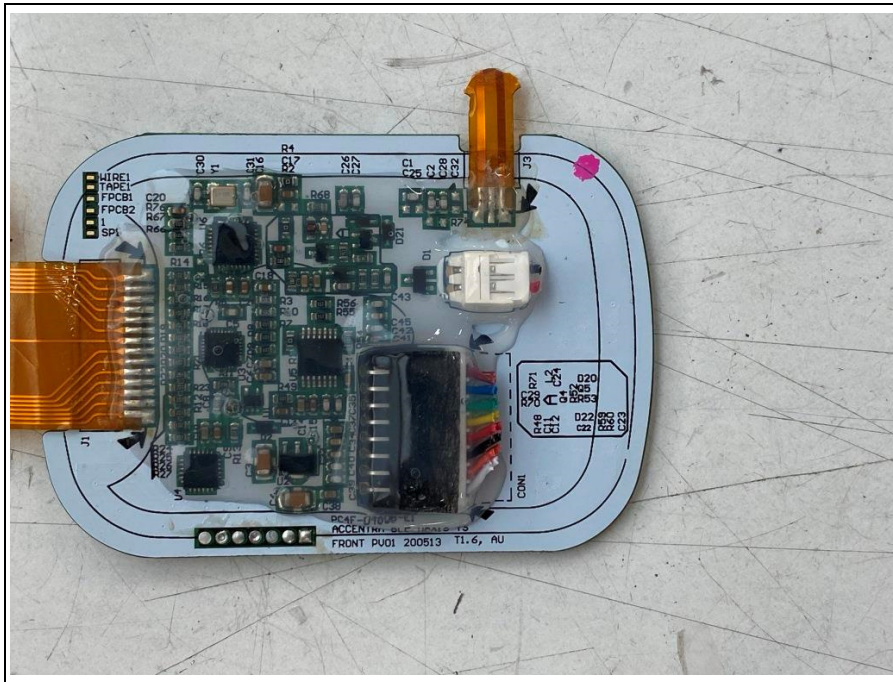

Bottom view of Sub PCB

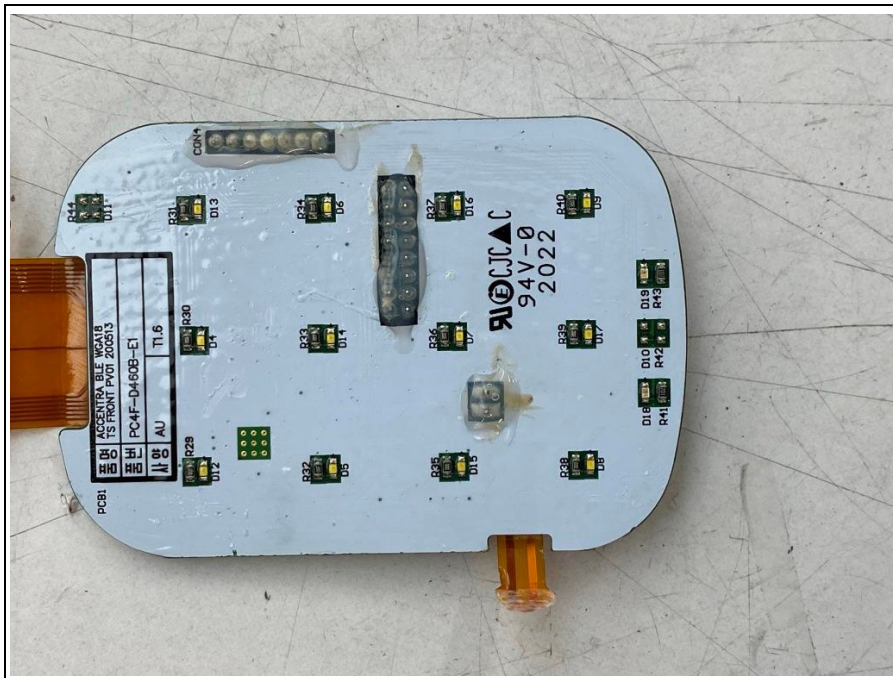

View of Antenna

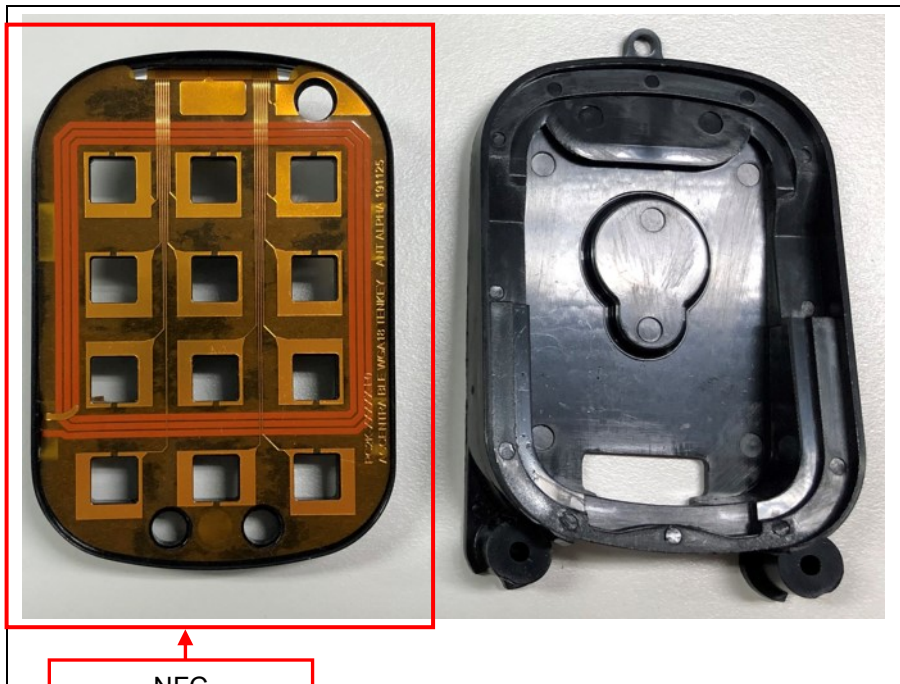

NFC Antenna

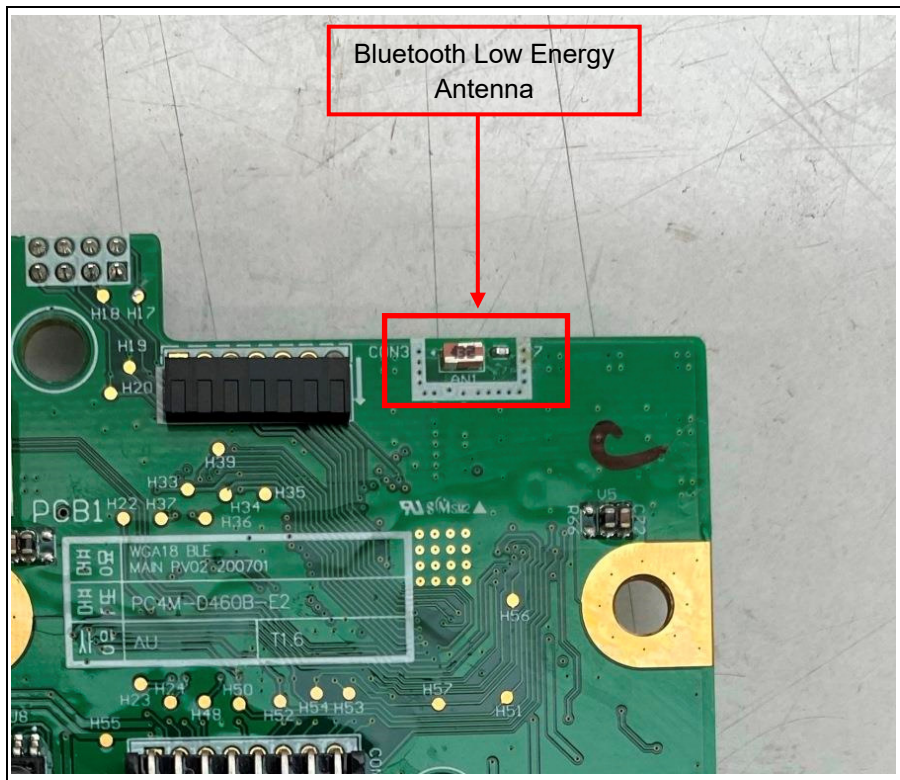

Bluetooth Low Energy Antenna

View of Module

