FCC Test Report

Report No.: AGC01369141102FE03

FCC ID : 2ABFFSH26
APPLICATION PURPOSE : Original Equipment
PRODUCT DESIGNATION : Bluetooth Headset
BRAND NAME : N/A
MODEL NAME : SH26, SH26B, SH26C, SH26D
CLIENT : SHENZHEN SURE THING INDUSTRY AND COMMERCE
DEVELOPMENT CO., LTD.
DATE OF ISSUE : Dec.11,2014
STANDARD(S) : FCC Part 15 Rules
REPORT VERSION : V1.0

Attestation of *Global Compliance (Shenzhen) Co., Ltd*

CAUTION:

This report shall not be reproduced except in full without the written permission of the test laboratory and shall not be quoted out of context.



Report Revise Record

| Report Version | Revise Time | Issued Date | Valid Version | Notes |
|-----------------------|--------------------|--------------------|----------------------|-----------------|
| V1.0 | / | Dec.11,2014 | Valid | Original Report |

TABLE OF CONTENTS

| | |
|-------------------------------------------------------------|-----------|
| 1. VERIFICATION OF CONFORMITY | 5 |
| 2. GENERAL INFORMATION | 6 |
| 2.1. PRODUCT DESCRIPTION..... | 6 |
| 2.2. TABLE OF CARRIER FREQUENCIES..... | 6 |
| 2.3. RECEIVER INPUT BANDWIDTH | 7 |
| 2.4. EXAMPLE OF A HOPPING SEQUENCY IN DATA MODE | 7 |
| 2.5. EQUALLY AVERAGE USE OF FREQUENCIES AND BEHAVIOUR | 7 |
| 2.6. RELATED SUBMITTAL(S) / GRANT (S)..... | 8 |
| 2.7. TEST METHODOLOGY..... | 8 |
| 2.8. SPECIAL ACCESSORIES | 8 |
| 2.9. EQUIPMENT MODIFICATIONS | 8 |
| 3. MEASUREMENT UNCERTAINTY..... | 9 |
| 4. DESCRIPTION OF TEST MODES..... | 9 |
| 5. SYSTEM TEST CONFIGURATION | 10 |
| 5.1. CONFIGURATION OF EUT SYSTEM | 10 |
| 5.2. EQUIPMENT USED IN EUT SYSTEM | 10 |
| 5.3. SUMMARY OF TEST RESULTS | 10 |
| 6. TEST FACILITY | 11 |
| 7. PEAK OUTPUT POWER | 12 |
| 7.1. MEASUREMENT PROCEDURE | 12 |
| 7.2. TEST SET-UP (BLOCK DIAGRAM OF CONFIGURATION)..... | 12 |
| 7.3. LIMITS AND MEASUREMENT RESULT | 13 |
| 8. 20DB BANDWIDTH..... | 19 |
| 8.1. MEASUREMENT PROCEDURE | 19 |
| 8.2. TEST SET-UP (BLOCK DIAGRAM OF CONFIGURATION)..... | 19 |
| 8.3. LIMITS AND MEASUREMENT RESULTS..... | 19 |
| 9. CONDUCTED SPURIOUS EMISSION | 26 |
| 9.1. MEASUREMENT PROCEDURE | 26 |
| 9.2. TEST SET-UP (BLOCK DIAGRAM OF CONFIGURATION)..... | 26 |
| 9.3. MEASUREMENT EQUIPMENT USED..... | 26 |
| 9.4. LIMITS AND MEASUREMENT RESULT | 26 |
| 10. RADIATED EMISSION | 30 |
| 10.1. MEASUREMENT PROCEDURE | 30 |
| 10.2. TEST SETUP..... | 32 |
| 10.3. TEST RESULT | 32 |

| | |
|-------------------------------------------------------------------|-----------|
| 11. BAND EDGE EMISSION | 39 |
| 11.1. MEASUREMENT PROCEDURE | 45 |
| 11.2. TEST SET-UP | 45 |
| 11.3. TEST RESULT | 46 |
| 12. NUMBER OF HOPPING FREQUENCY..... | 50 |
| 12.1. MEASUREMENT PROCEDURE | 50 |
| 12.2. TEST SETUP (BLOCK DIAGRAM OF CONFIGURATION)..... | 50 |
| 12.3. MEASUREMENT EQUIPMENT USED..... | 50 |
| 12.4. LIMITS AND MEASUREMENT RESULT | 50 |
| 13. TIME OF OCCUPANCY (DWELL TIME)..... | 51 |
| 13.1. MEASUREMENT PROCEDURE | 51 |
| 13.2. TEST SETUP (BLOCK DIAGRAM OF CONFIGURATION)..... | 51 |
| 13.3. MEASUREMENT EQUIPMENT USED..... | 51 |
| 13.4. LIMITS AND MEASUREMENT RESULT | 51 |
| 14. FREQUENCY SEPARATION | 54 |
| 14.1. MEASUREMENT PROCEDURE | 54 |
| 14.2. TEST SETUP (BLOCK DIAGRAM OF CONFIGURATION)..... | 54 |
| 14.3. MEASUREMENT EQUIPMENT USED..... | 54 |
| 14.4. LIMITS AND MEASUREMENT RESULT | 54 |
| 15. FCC LINE CONDUCTED EMISSION TEST | 56 |
| 15.1. LIMITS OF LINE CONDUCTED EMISSION TEST | 56 |
| 15.2. BLOCK DIAGRAM OF LINE CONDUCTED EMISSION TEST | 56 |
| 15.3. PRELIMINARY PROCEDURE OF LINE CONDUCTED EMISSION TEST | 57 |
| 15.4. FINAL PROCEDURE OF LINE CONDUCTED EMISSION TEST | 57 |
| 15.5. TEST RESULT OF LINE CONDUCTED EMISSION TEST | 58 |
| APPENDIX A: PHOTOGRAPHS OF TEST SETUP | 60 |
| APPENDIX B: PHOTOGRAPHS OF EUT | 62 |

1. VERIFICATION OF CONFORMITY

| | |
|---------------------------------|----------------------------------------------------------------------------------------------------------------|
| Applicant | SHENZHEN SURE THING INDUSTRY AND COMMERCE DEVELOPMENT CO.,LTD. |
| Address | 2-3F, Building A, Fuxinlin Industrial Park, Hangcheng Industrial Area, Xixiang Town, Bao An District, Shenzhen |
| Manufacturer | SHENZHEN SURE THING INDUSTRY AND COMMERCE DEVELOPMENT CO.,LTD |
| Address | 2-3F, Building A, Fuxinlin Industrial Park, Hangcheng Industrial Area, Xixiang Town, Bao An District, Shenzhen |
| Product Designation | Bluetooth Headset |
| Brand Name | N/A |
| Test Model | SH26 |
| Series Model | SH26B, SH26C,SH26D |
| Different Description | All the same except for the model name |
| Date of test | Dec.09,2014 to Dec.10,2014 |
| Deviation | None |
| Condition of Test Sample | Normal |
| Report Template | AGCRT-US-BR/RF (2013-03-01) |

We hereby certify that:

The above equipment was tested by Attestation of Global Compliance (Shenzhen) Co., Ltd. The test data, data evaluation, test procedures, and equipment configurations shown in this report were made in accordance with the procedures given in ANSI C63.4 (2003) and the energy emitted by the sample EUT tested as described in this report is in compliance with radiated emission limits of FCC Rules Part 15.247.

Prepared By

Water Zuo

Water Zuo Dec.11,2014

Checked By

Forrest Lei

Forrest Lei Dec.11,2014

Authorized By

Solger Zhang

Solger Zhang Dec.11,2014

2. GENERAL INFORMATION

2.1. PRODUCT DESCRIPTION

The EUT is “Bluetooth Headset” designed as a “Communication Device”. It is designed by way of utilizing the FHSS technology to achieve the system operation.

A major technical description of EUT is described as following

| | |
|------------------------------------------------------------------------------------------------------------------------------------------------------------------------------------------------------------------------------------------------------------------------------------------------------------------------------------------------------------------------------------------------|-----------------------------|
| Operation Frequency | 2.402 GHz to 2.480GHz |
| RF Output Power | 5.06dBm(Max) |
| Bluetooth Version | V 4.1 |
| Modulation | GFSK, $\pi/4$ -DQPSK, 8DPSK |
| Number of channels | 79 |
| Hardware Version | N/A |
| Software Version | N/A |
| Antenna Designation | PCB Antenna |
| Antenna Gain | 0dBi |
| Power Supply | DC3.7V by Battery |
| <p>Note: The USB port only used for charging and can't be used to transfer data with PC. The EUT is equipped with the Bluetooth Chip AB1510 which complies with Bluetooth V 4.1, including the EDR function. But for this device The EUT supports BDR & EDR function only. End-user is not able to change the settings and enable any additional functionality by himself.</p> | |

2.2. TABLE OF CARRIER FREQUENCIES

| Frequency Band | Channel Number | Frequency |
|----------------|----------------|-----------|
| 2402~2480MHZ | 0 | 2402MHZ |
| | 1 | 2403MHZ |
| | : | : |
| | 38 | 2440 MHZ |
| | 39 | 2441 MHZ |
| | 40 | 2442 MHZ |
| | : | : |
| | 77 | 2479 MHZ |
| | 78 | 2480 MHZ |

2.3. RECEIVER INPUT BANDWIDTH

The input bandwidth of the receiver is 1.3MHz. In every connection one Bluetooth device is the master and the other one is slave. The master determines the hopping sequence. The slave follows this sequence. Both devices shift between RX and TX time slot according to the clock of the master. Additionally the type of connection (e.g. single or multislotted packet) is set up at the beginning of the connection. The master adapts its hopping frequency and its TX/RX timing according to the packet type of the connection. Also the slave of the connection will use these settings.

Repeating of a packet has no influence on the hopping sequence. The hopping sequence generated by the master of the connection will be followed in any case. That means, a repeated packet will not be sent on the same frequency, it is sent on the next frequency of the hopping sequence.

2.4. EXAMPLE OF A HOPPING SEQUENCE IN DATA MODE

Example of a 79 hopping sequence in data mode:

40,21,44,23,42,53,46,55,48,33,52,35,50,65,54,67
 56,37,60,39,58,69,62,71,64,25,68,27,66,57,70,59
 72,29,76,31,74,61,78,63,01,41,05,43,03,73,07,75
 09,45,13,47,11,77,15,00,64,49,66,53,68,02,70,06
 01, 51, 03, 55, 05, 04

2.5. EQUALLY AVERAGE USE OF FREQUENCIES AND BEHAVIOUR

The generation of the hopping sequence in connection mode depends essentially on two input values:

1. LAP/UAP of the master of the connection.
2. Internal master clock

The LAP (lower address part) are the 24 LSB's of the 48 BD_ADDRESS. The BD_ADDRESS is an unambiguous number of every Bluetooth unit. The UAP (upper address part) are the 24 MSB's of the 48 BD_ADDRESS.

The internal clock of a Bluetooth unit is derived from a free running clock which is never adjusted and is never turned off. For synchronization with other units only offsets are used. It has no relation to the time of the day. Its resolution is at least half the RX/TX slot length of 312.5µs. The clock has a cycle of about one day (23h30). In most cases it is implemented as a 28-bit counter. For the deriving of the hopping sequence the entire LAP (24 bits), 4 LSB's (4 bits) (Input 1) and the 27 MSB's of the clock (Input 2) are used. With these input values different mathematical procedures (permutations, additions, XOR-operations) are performed to generate the sequence. This will be done at the beginning of every new transmission.

Regarding short transmissions the Bluetooth system has the following behavior:

The first connection between the two devices is established, a hopping sequence was generated. For transmitting the wanted data the complete hopping sequence was not used. The connection ended.

The second connection will be established. A new hopping sequence is generated. Due to the fact the Bluetooth clock has a different value, because the period between the two transmissions is longer (and it cannot be shorter) than the minimum resolution of the clock (312.5µs). The hopping sequence will always differ from the first one.

2.6. RELATED SUBMITTAL(S) / GRANT (S)

This submittal(s) (test report) is intended for **FCC ID: 2ABFFSH26** filing to comply with Section 15.247 of the FCC Part 15, Subpart C Rules.

2.7. TEST METHODOLOGY

Both conducted and radiated testing was performed according to the procedures in ANSI C63.4 (2003).

Radiated testing was performed at an antenna to EUT distance 3 meters.

Test has been referenced to the DA 00-705

2.8. SPECIAL ACCESSORIES

Refer to section 5.2.

2.9. EQUIPMENT MODIFICATIONS

Not available for this EUT intended for grant.

3. MEASUREMENT UNCERTAINTY

Conducted measurement: +/- 2.75dB
Radiated measurement: +/- 3.2dB

4. DESCRIPTION OF TEST MODES

| NO. | TEST MODE DESCRIPTION |
|-----|-----------------------|
| 1 | Low channel TX |
| 2 | Middle channel TX |
| 3 | High channel TX |
| 4 | Normal Operating (BT) |

Note:

- 1. Only the result of the worst case was recorded in the report, if no other cases.
- 2. For Radiated Emission, 3axis were chosen for testing for each applicable mode.

5. SYSTEM TEST CONFIGURATION

5.1. CONFIGURATION OF EUT SYSTEM

Configure 1: (Normal hopping)

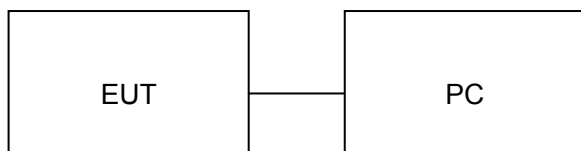

Configure 2: (Control continuous TX)

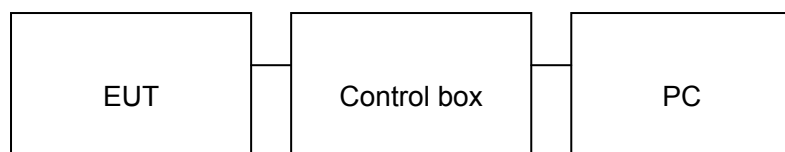

5.2. EQUIPMENT USED IN EUT SYSTEM

| Item | Equipment | Mfr/Brand | Model/Type No. | Remark |
|------|-------------------|-----------|----------------|--------|
| 1 | Bluetooth Headset | N/A | SH26 | EUT |
| 2 | PC | DELL | INSPIRON | A.E |
| 3 | PC | APPLE | A1465 | A.E |
| 4 | Control box | N/A | N/A | A.E |

5.3. SUMMARY OF TEST RESULTS

| FCC RULES | DESCRIPTION OF TEST | RESULT |
|-----------|-----------------------------|-----------|
| §15.247 | Peak Output Power | Compliant |
| §15.247 | 20 dB Bandwidth | Compliant |
| §15.247 | Spurious Emission | Compliant |
| §15.209 | Radiated Emission | Compliant |
| §15.247 | Band Edges | Compliant |
| §15.207 | Conduction Emission | Compliant |
| §15.247 | Number of Hopping Frequency | Compliant |
| §15.247 | Time of Occupancy | Compliant |
| §15.247 | Frequency Separation | Compliant |

6. TEST FACILITY

| | |
|--------------------|----------------------------------------------------------------------------------------------------------------------------------|
| Site | Attestation of Global Compliance (Shenzhen) Co., Ltd |
| Location | 2/F., Building 2, No.1-No.4, Chaxi Sanwei Technical Industrial Park, Gushu, Xixiang, Bao'an District, Shenzhen, Guangdong, China |
| Description | The test site is constructed and calibrated to meet the FCC requirements in documents ANSI C63.4:2003. |

ALL TEST EQUIPMENT LIST

| Description | Manufacturer | Model | S/N | Cal. Date | Cal. Due |
|-----------------------|-------------------|-------------|------------|------------|------------|
| Power Probe | R&S | NRP-Z23 | 100323 | 07/16/2014 | 07/15/2015 |
| RF attenuator | N/A | RFA20db | 68 | N/A | N/A |
| Spectrum Analyzer | Agilent | E4440A | US41421290 | 07/16/2014 | 07/15/2015 |
| EXA Signal Analyzer | Agilent | N9010A | -- | 02/28/2014 | 02/27/2015 |
| Amplifier | EM | EM30180 | 0607030 | 02/28/2014 | 02/27/2015 |
| Horn Antenna | EM | EM-AH-10180 | 67 | 04/19/2014 | 04/18/2015 |
| Horn Antenna | A.H. Systems Inc. | SAS-574 | -- | 07/16/2014 | 07/15/2015 |
| EMI Test Receiver | Rohde & Schwarz | ESCI | 100694 | 07/16/2014 | 07/15/2015 |
| Biological Antenna | A.H. Systems Inc. | SAS-521-4 | 26 | 06/06/2014 | 06/05/2015 |
| LISN | R&S | ESH3-Z5 | 8389791009 | 07/16/2014 | 07/15/2015 |
| Loop Antenna | Daze | ZN30900N | SEL0097 | 07/16/2014 | 07/15/2015 |
| Isolation Transformer | LETEAC | LTBK | -- | 07/16/2014 | 07/15/2015 |
| Radiation Cable 1 | Sat | RE1 | R003 | 06/04/2014 | 06/03/2015 |
| Radiation Cable 2 | Sat | RE2 | R002 | 06/04/2014 | 06/03/2015 |
| Conduction Cable | Sat | CE1 | C001 | 06/04/2014 | 06/03/2015 |

7. PEAK OUTPUT POWER

7.1. MEASUREMENT PROCEDURE

For peak power test:

1. Connect EUT RF output port to the Spectrum Analyzer through an RF attenuator
2. Set the EUT Work on the top, middle and the bottom operation frequency individually.
3. RBW > the 20 dB bandwidth of the emission being measured, VBW \geq RBW.
4. Record the maximum power from the Spectrum Analyzer.

For average power test:

1. Connect EUT RF output port to power probe through an RF attenuator.
2. Connect the power probe to the PC.
3. Set the EUT Work on the top, the middle and the bottom operation frequency individually.
4. Record the maximum power from the software.
5. The maximum peak power shall be less 125mW (21dBm).

Note : The EUT was tested according to DA000705 for compliance to FCC 47CFR 15.247 requirements.

7.2. TEST SET-UP (BLOCK DIAGRAM OF CONFIGURATION)

PEAK POWER TEST SETUP

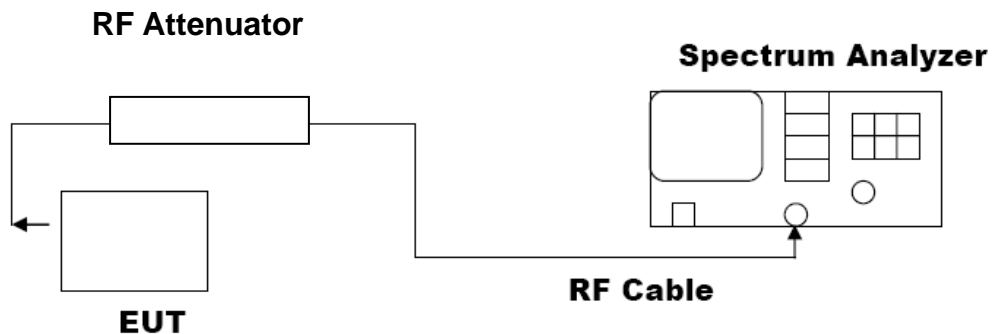

AVERAGE POWER SETUP

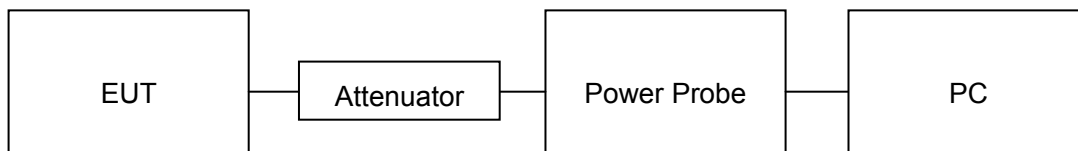

7.3. LIMITS AND MEASUREMENT RESULT

| PEAK OUTPUT POWER MEASUREMENT RESULT FOR GFSK MOUDULATION | | | | |
|--------------------------------------------------------------|---------------------|------------------|-------------------------|--------------|
| Frequency (GHz) | Average Power (dBm) | Peak Power (dBm) | Applicable Limits (dBm) | Pass or Fail |
| 2.402 | 0.82 | 2.74 | 30 | Pass |
| 2.441 | 2.67 | 4.62 | 30 | Pass |
| 2.480 | 3.10 | 5.06 | 30 | Pass |

CH0

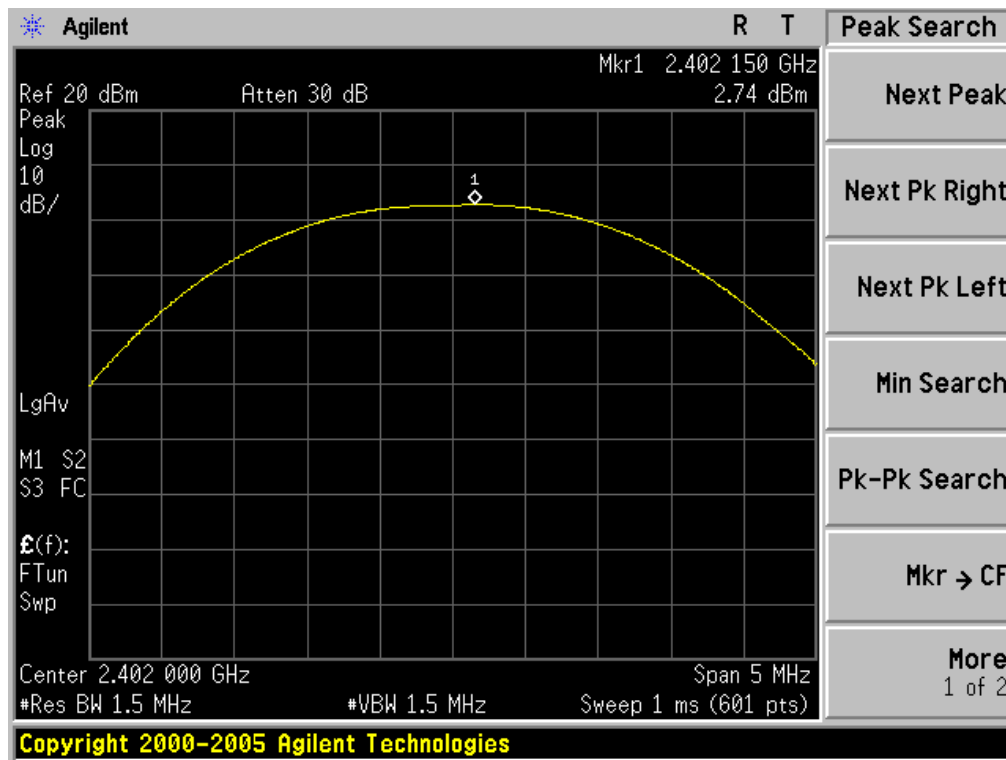

CH39

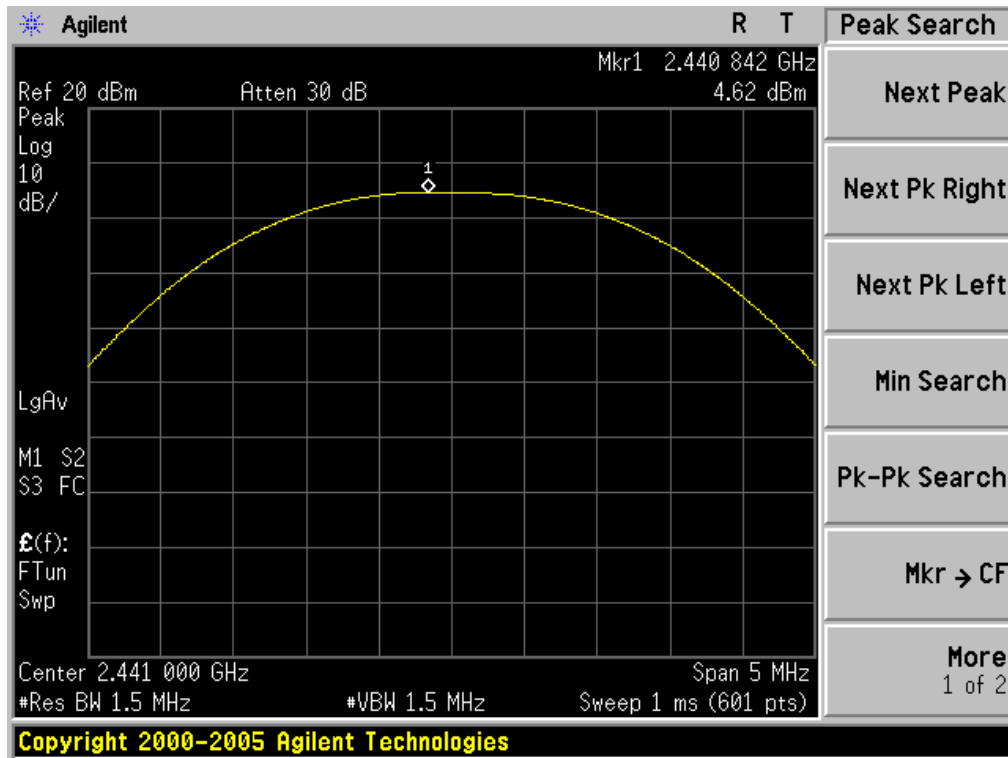

CH78

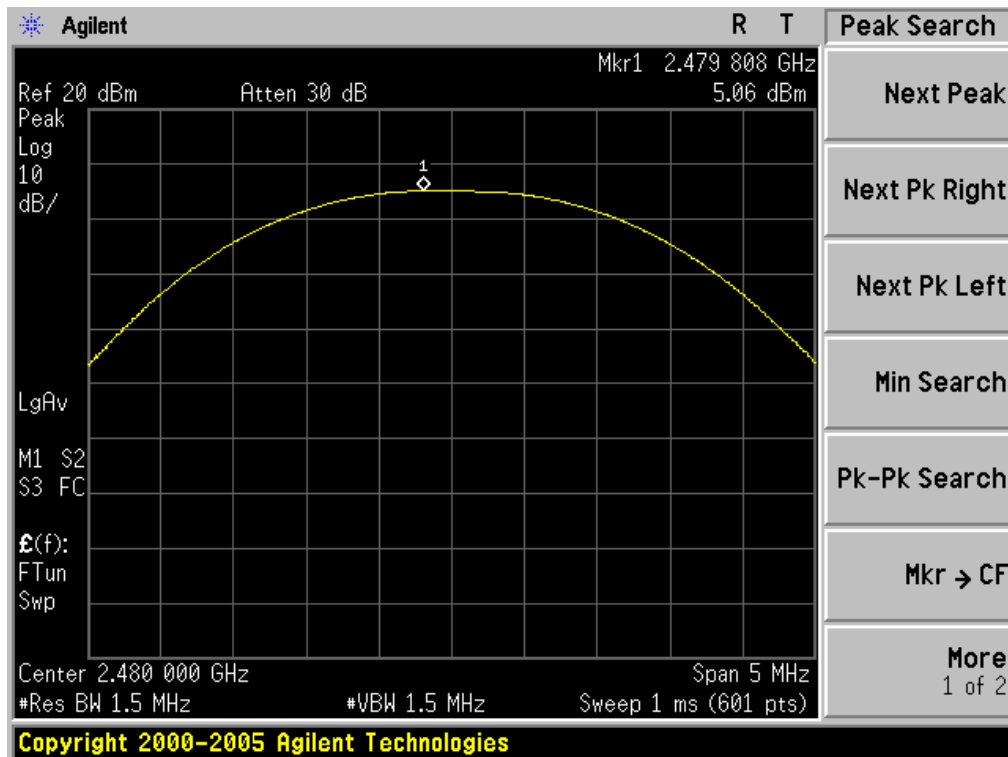

| PEAK OUTPUT POWER MEASUREMENT RESULT FOR Π /4-DQPSK MODULATION | | | | |
|-----------------------------------------------------------------------|---------------------|------------------|-------------------------|--------------|
| Frequency (GHz) | Average Power (dBm) | Peak Power (dBm) | Applicable Limits (dBm) | Pass or Fail |
| 2.402 | -1.38 | 0.47 | 30 | Pass |
| 2.441 | 1.01 | 2.95 | 30 | Pass |
| 2.480 | 1.76 | 3.72 | 30 | Pass |

CH0

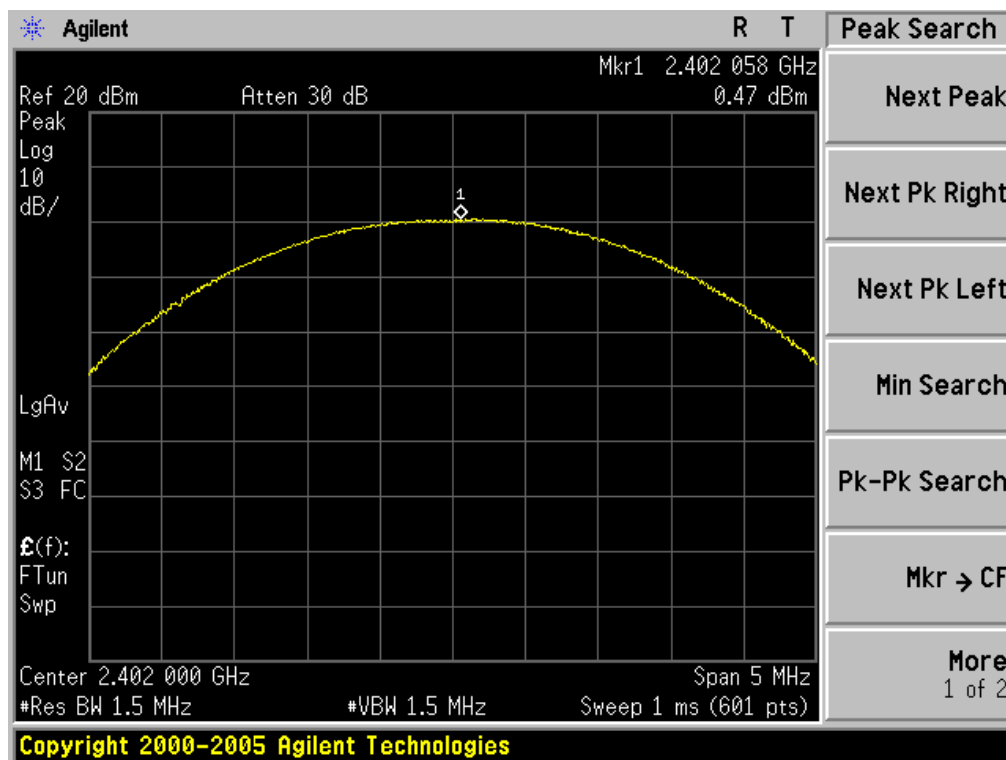

CH39

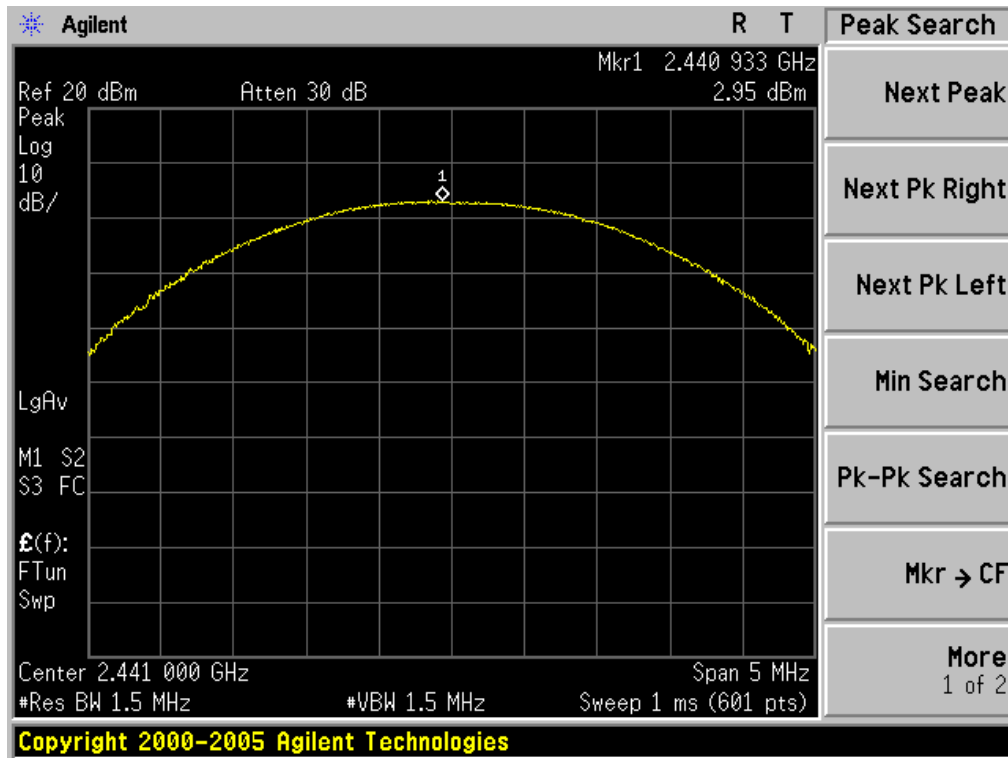

CH78

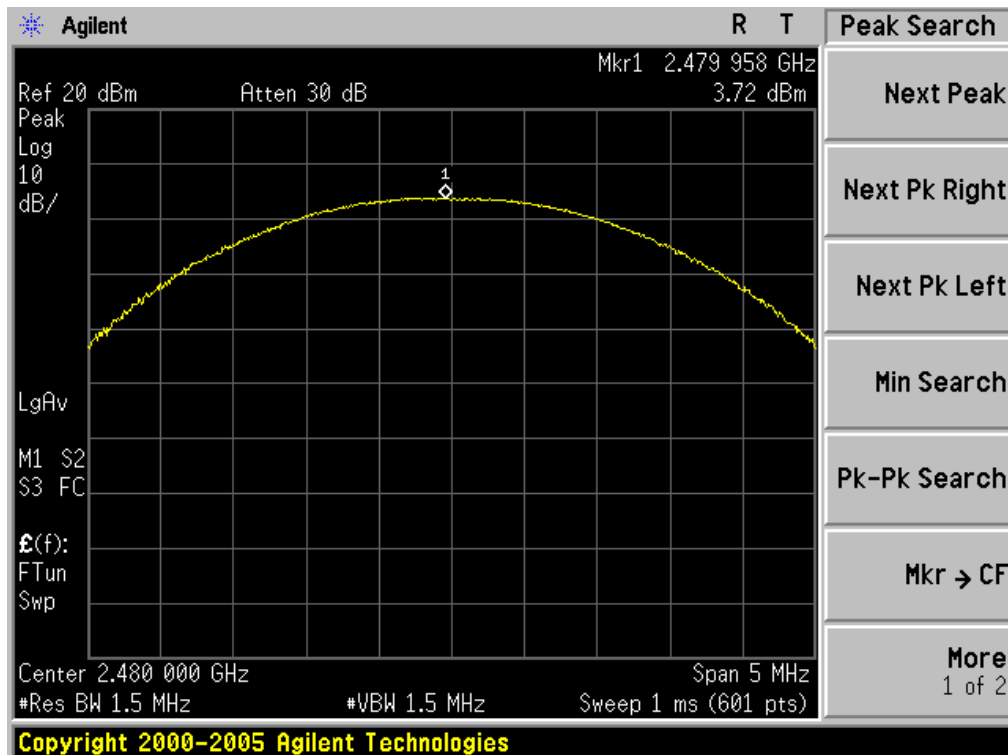

| PEAK OUTPUT POWER MEASUREMENT RESULT FOR 8-DPSK MODULATION | | | | |
|---------------------------------------------------------------|---------------------|------------------|-------------------------|--------------|
| Frequency (GHz) | Average Power (dBm) | Peak Power (dBm) | Applicable Limits (dBm) | Pass or Fail |
| 2.402 | -1.23 | 0.72 | 30 | Pass |
| 2.441 | 1.39 | 3.23 | 30 | Pass |
| 2.480 | 2.10 | 4.01 | 30 | Pass |

CH0

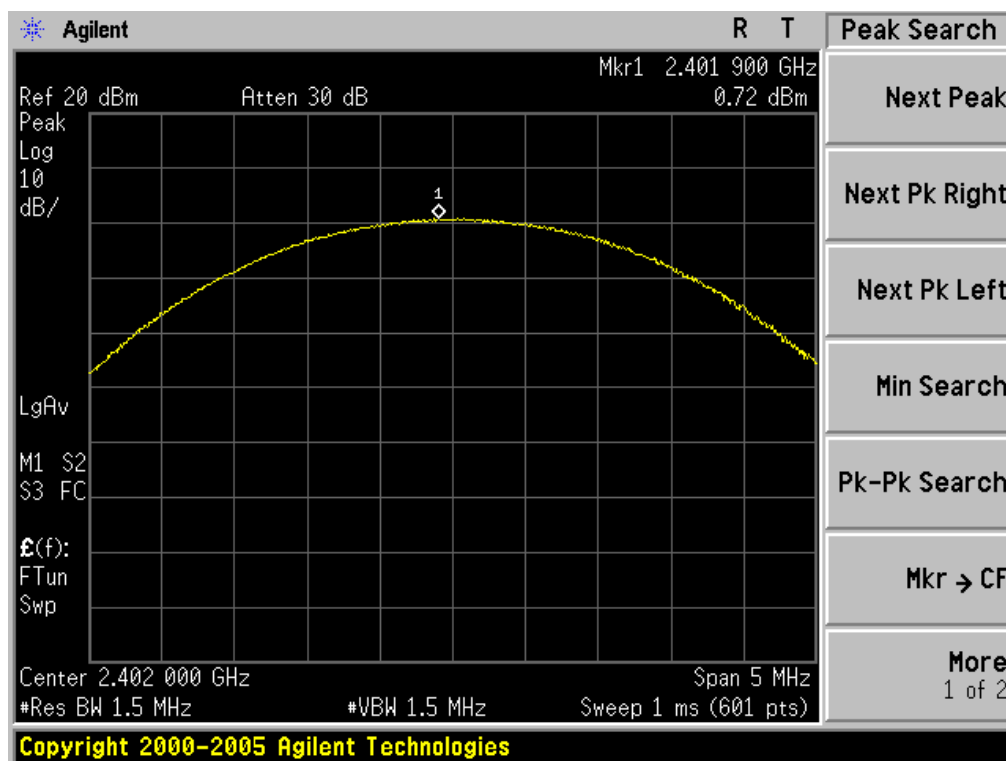

CH39

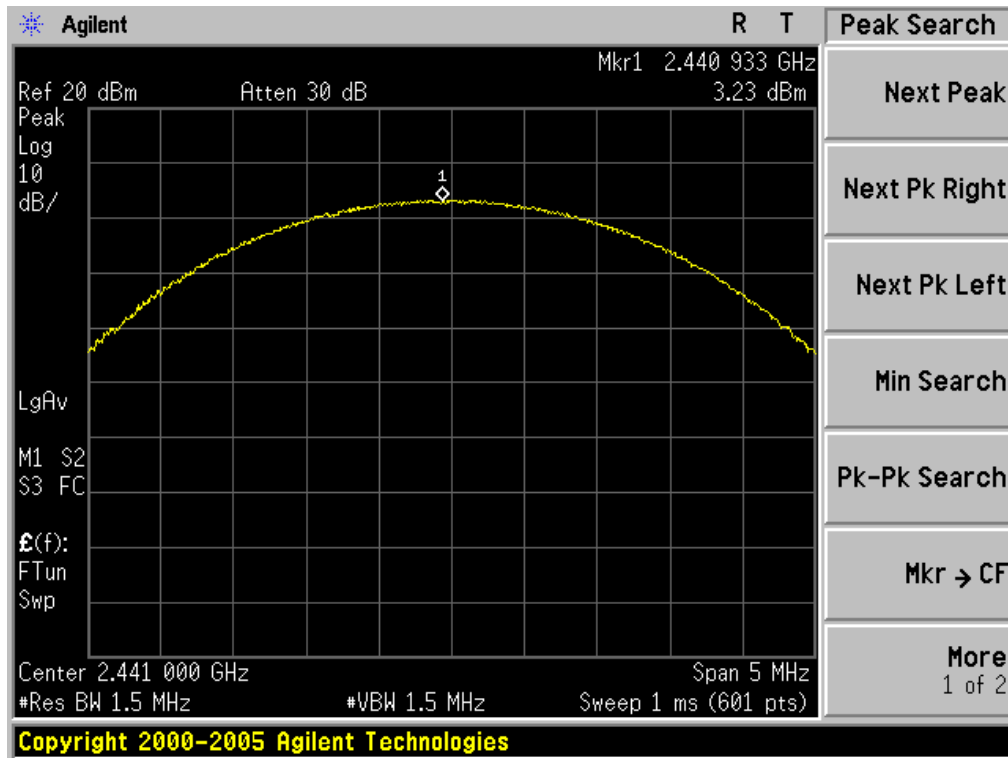

CH78

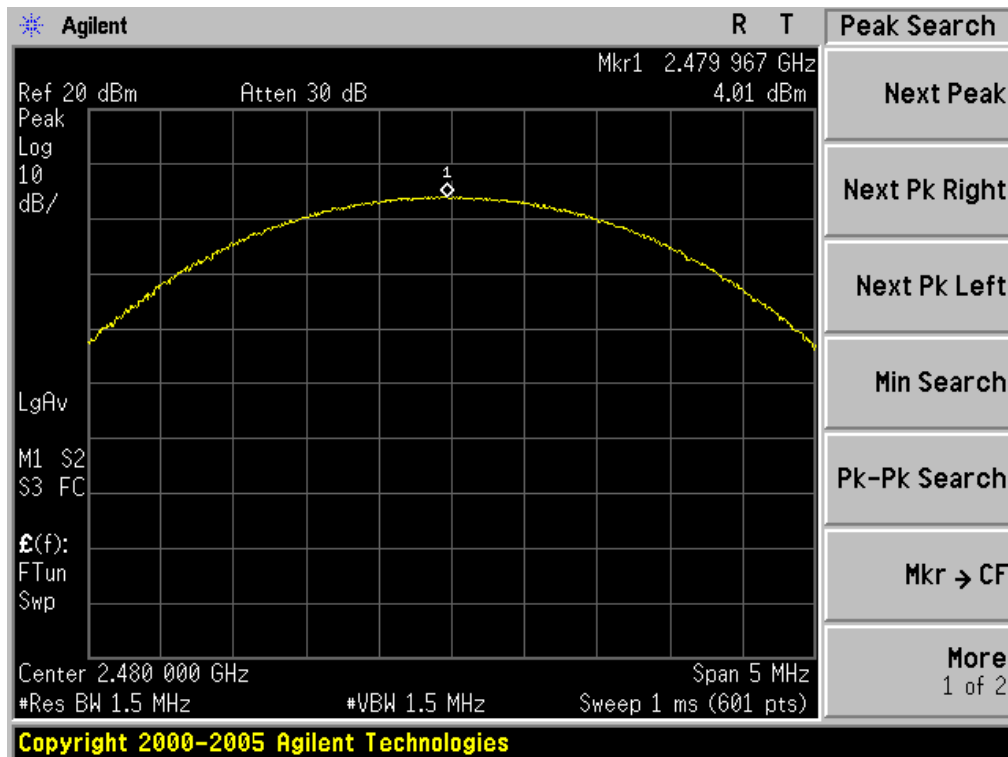

8. 20DB BANDWIDTH

8.1. MEASUREMENT PROCEDURE

1. Connect EUT RF output port to the Spectrum Analyzer through an RF attenuator
2. Set the EUT Work on the top, the middle and the bottom operation frequency individually.
3. Set Span = approximately 2 to 3 times the 20 dB bandwidth, centered on a hopping channel
RBW \geq 1% of the 20 dB bandwidth, VBW \geq RBW; Sweep = auto; Detector function = peak
4. Set SPA Trace 1 Max hold, then View.

8.2. TEST SET-UP (BLOCK DIAGRAM OF CONFIGURATION)

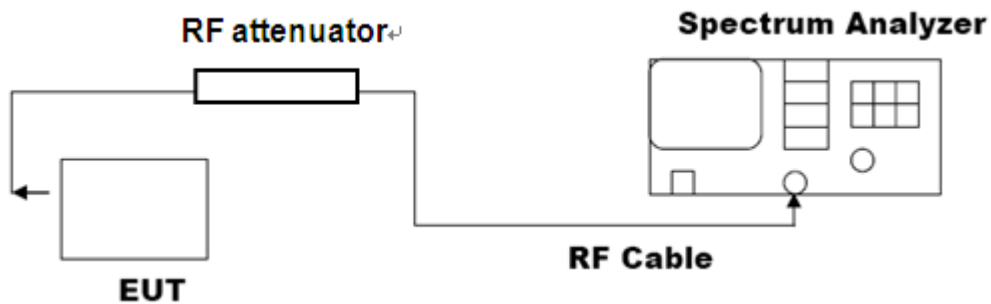

8.3. LIMITS AND MEASUREMENT RESULTS

| BLUETOOTH 1MBPS LIMITS AND MEASUREMENT RESULT | | | |
|-----------------------------------------------|--------------------|-------|----------|
| Applicable Limits | Measurement Result | | |
| | Test Data (MHz) | | Criteria |
| N/A | Low Channel | 0.875 | PASS |
| | Middle Channel | 0.868 | PASS |
| | High Channel | 0.941 | PASS |

TEST PLOT OF BANDWIDTH FOR LOW CHANNEL

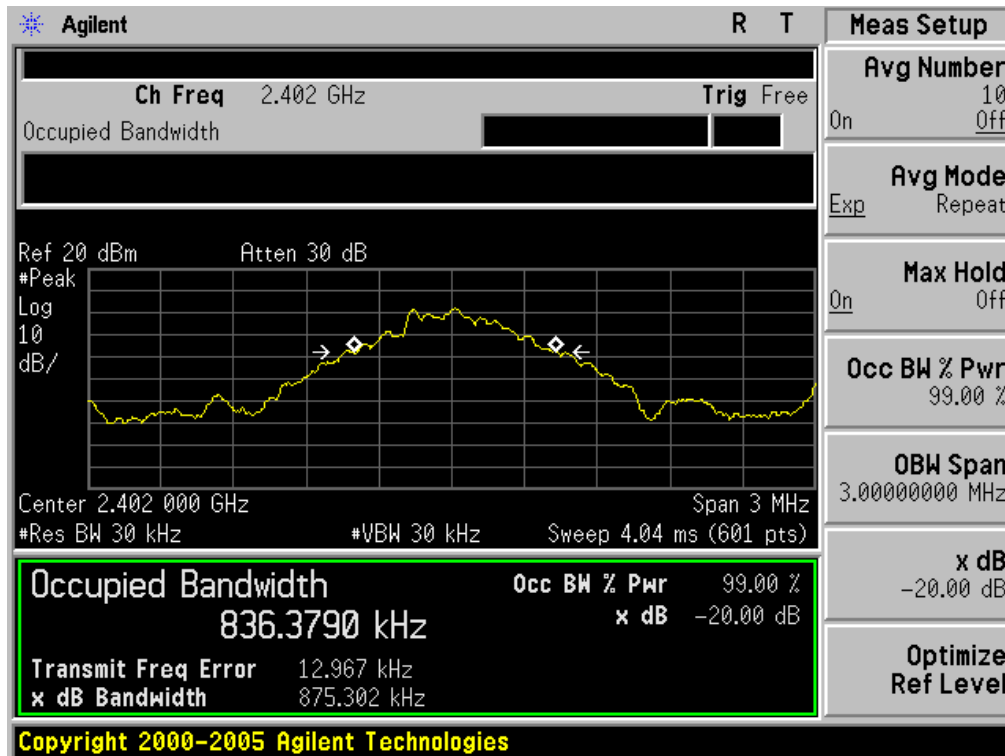

TEST PLOT OF BANDWIDTH FOR MIDDLE CHANNEL

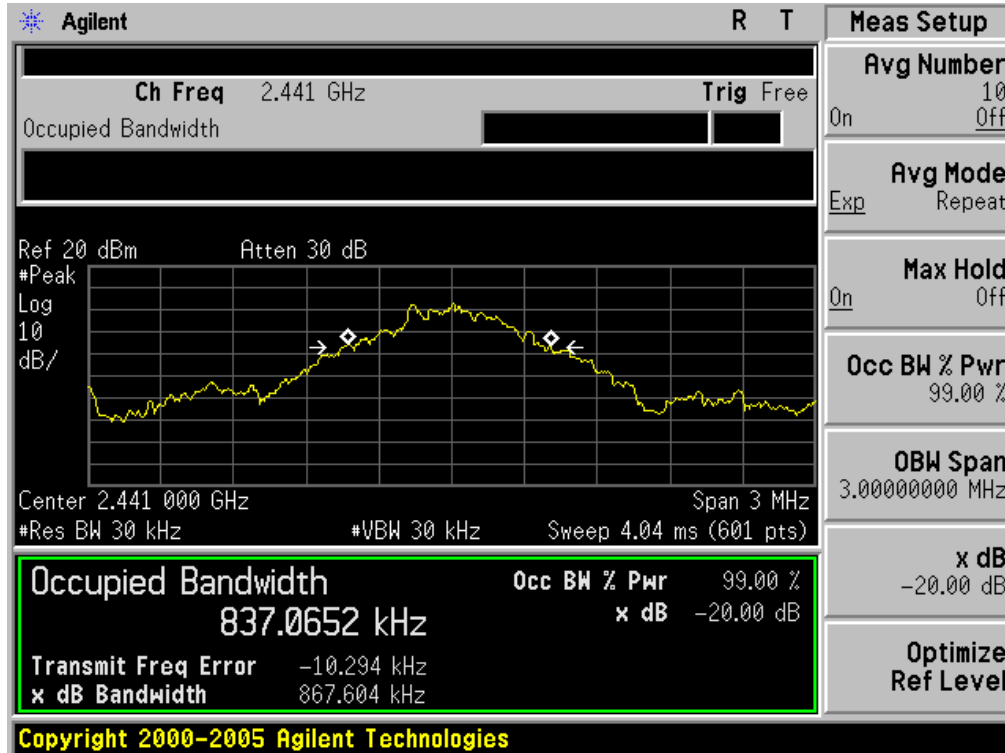

TEST PLOT OF BANDWIDTH FOR HIGH CHANNEL

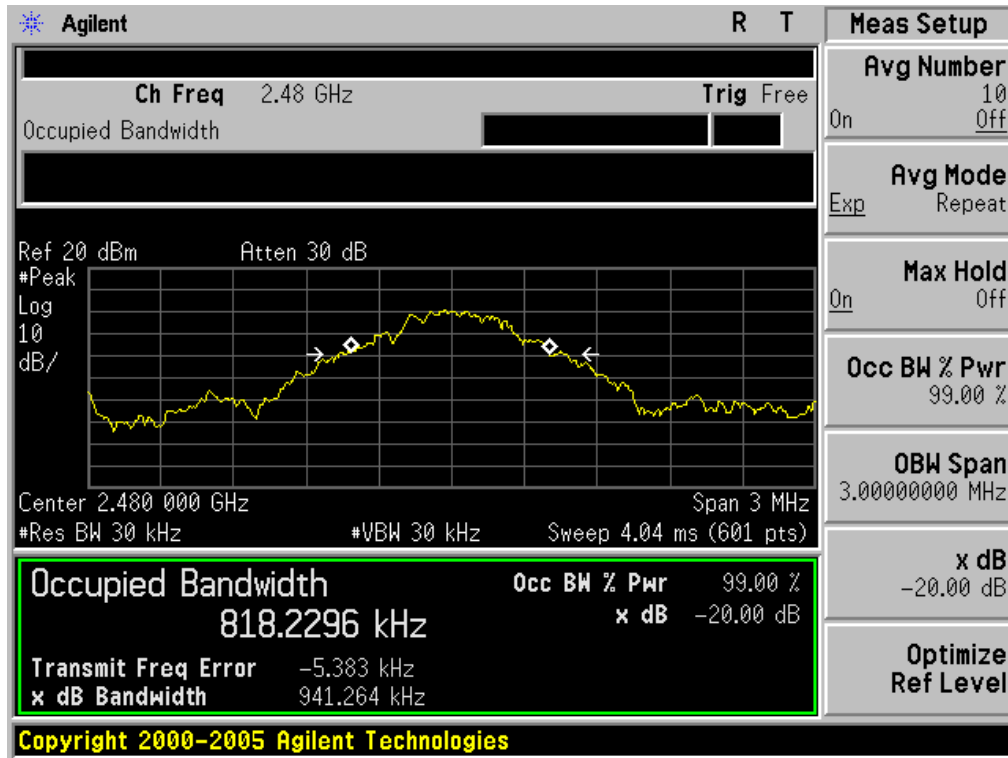

| BLUETOOTH 2MBPS LIMITS AND MEASUREMENT RESULT | | | |
|-----------------------------------------------|--------------------|-------|----------|
| Applicable Limits | Measurement Result | | |
| | Test Data (MHz) | | Criteria |
| N/A | Low Channel | 1.175 | PASS |
| | Middle Channel | 1.274 | PASS |
| | High Channel | 1.216 | PASS |

TEST PLOT OF BANDWIDTH FOR LOW CHANNEL

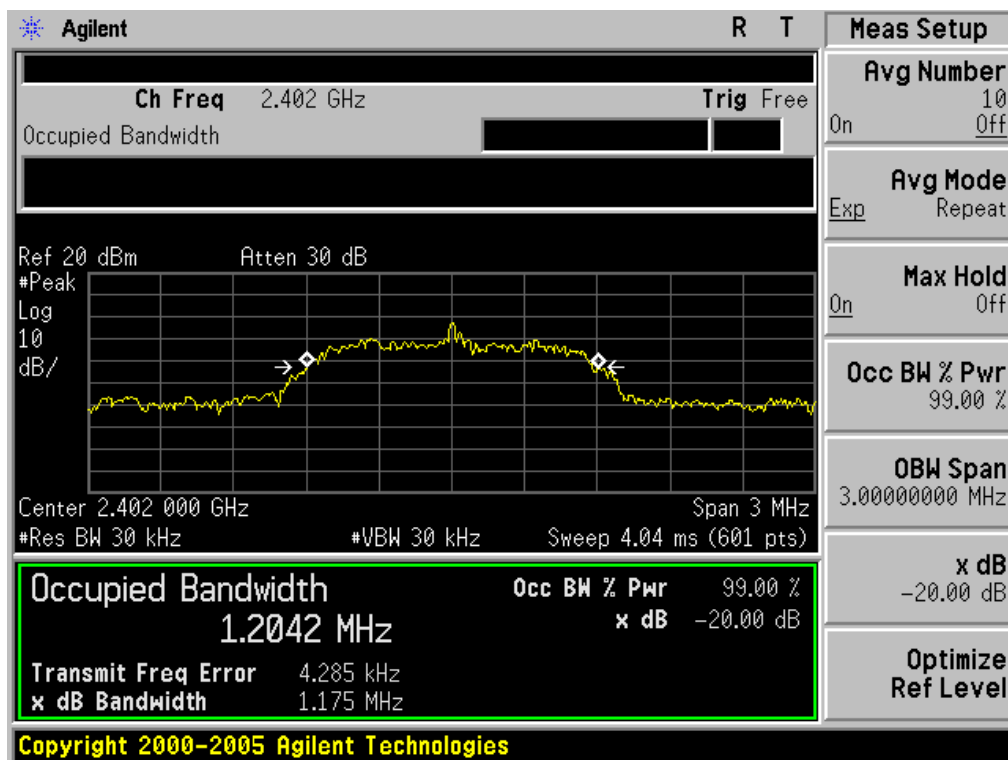

TEST PLOT OF BANDWIDTH FOR MIDDLE CHANNEL

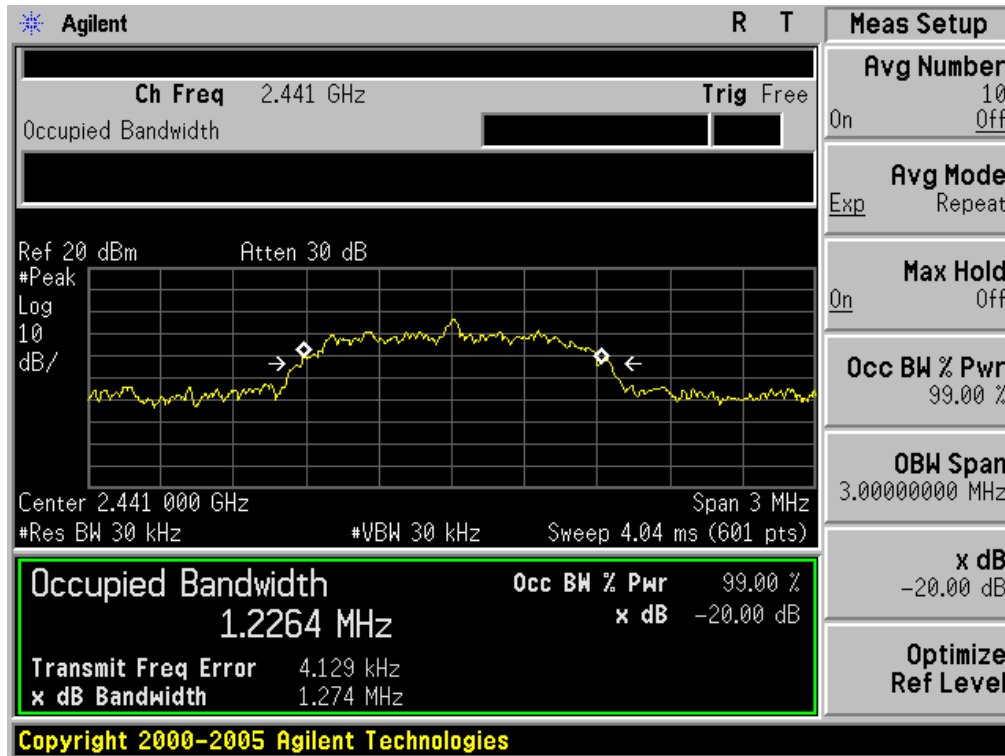

TEST PLOT OF BANDWIDTH FOR HIGH CHANNEL

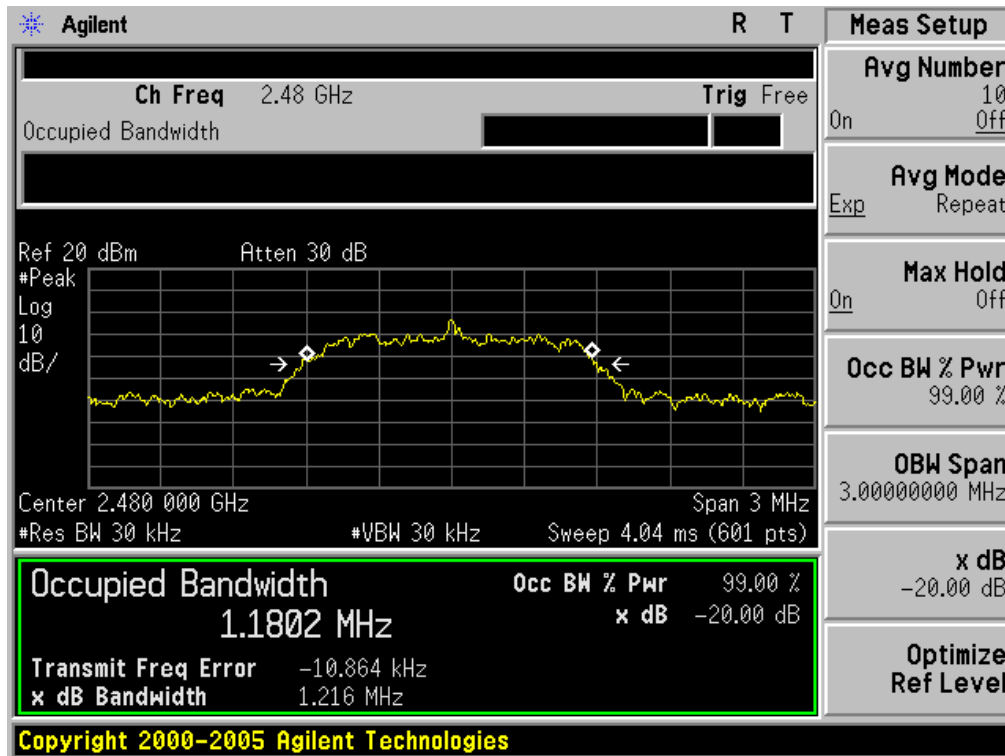

| BLUETOOTH 3MBPS LIMITS AND MEASUREMENT RESULT | | | |
|-----------------------------------------------|--------------------|-------|----------|
| Applicable Limits | Measurement Result | | |
| | Test Data (MHz) | | Criteria |
| N/A | Low Channel | 1.292 | PASS |
| | Middle Channel | 1.309 | PASS |
| | High Channel | 1.215 | PASS |

TEST PLOT OF BANDWIDTH FOR LOW CHANNEL

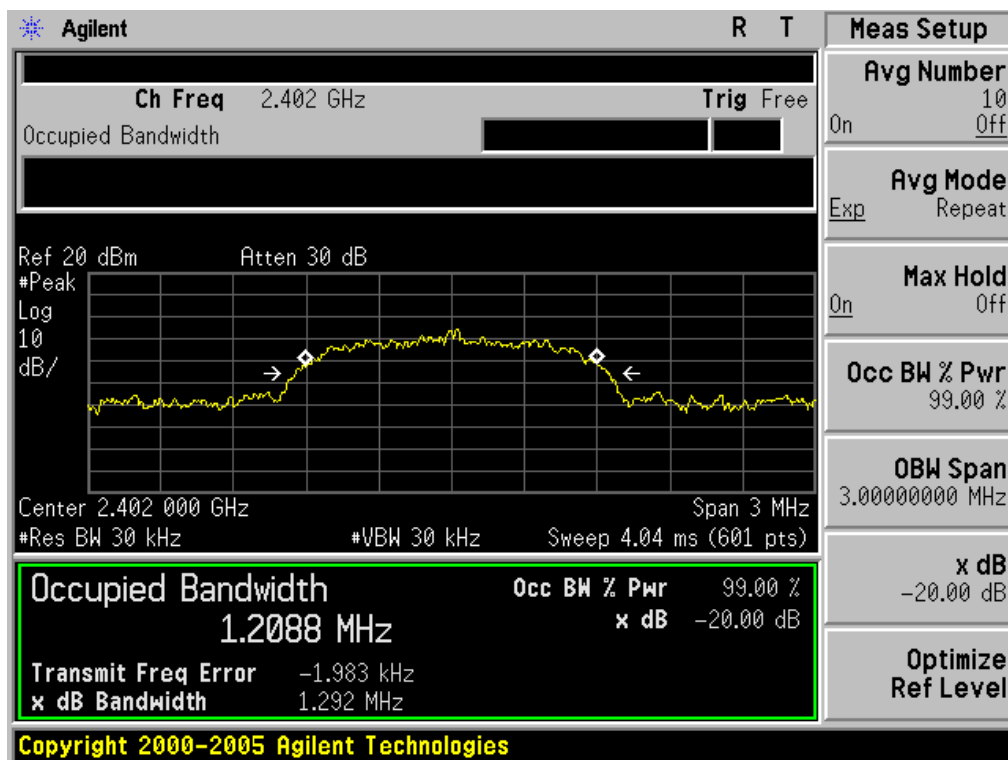

TEST PLOT OF BANDWIDTH FOR MIDDLE CHANNEL

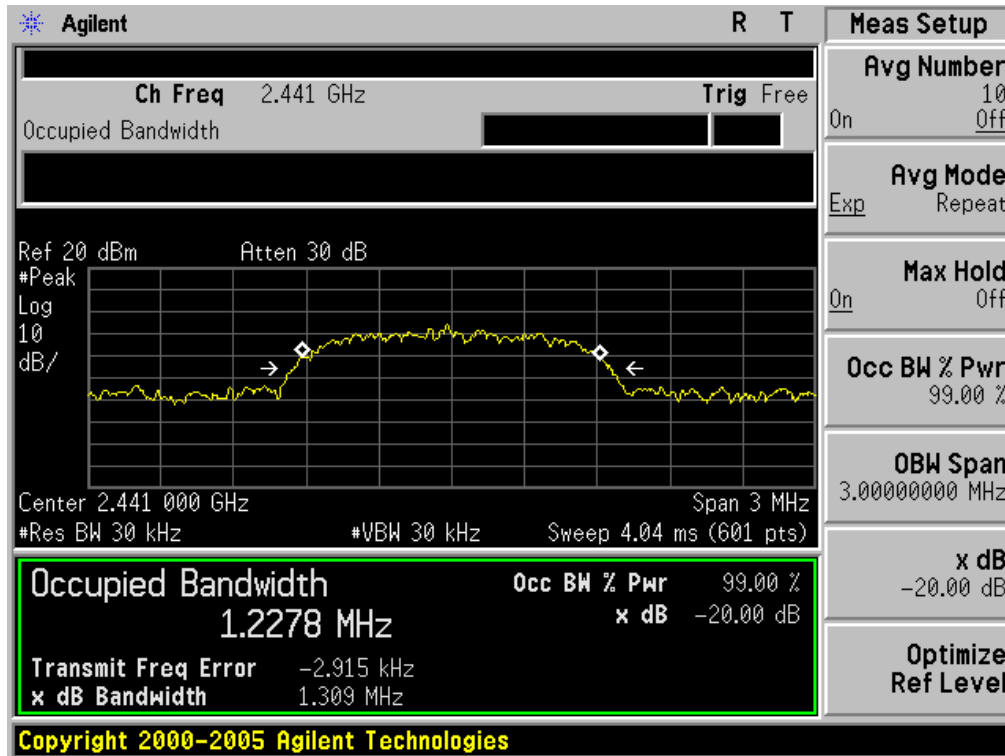

TEST PLOT OF BANDWIDTH FOR HIGH CHANNEL

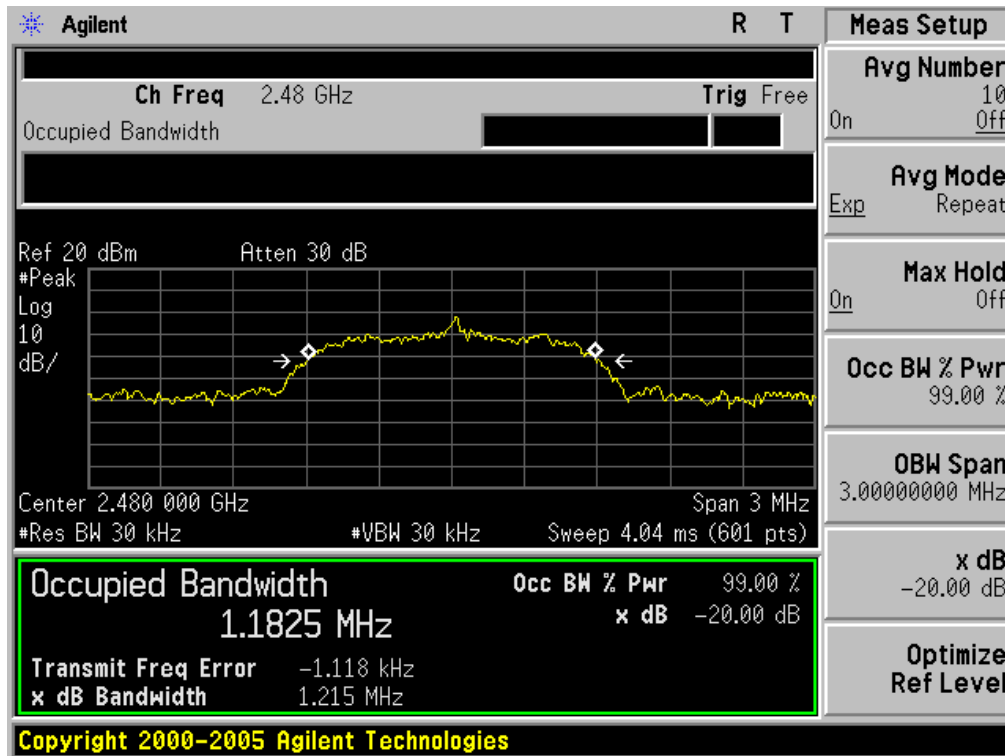

9. CONDUCTED SPURIOUS EMISSION

9.1. MEASUREMENT PROCEDURE

1. Connect EUT RF output port to the Spectrum Analyzer through an RF attenuator
2. Set the EUT Work on the top, the Middle and the bottom operation frequency individually.
3. Set the Span = wide enough to capture the peak level of the in-band emission and all spurious emissions from the lowest frequency generated in the EUT up through the 10th harmonic.
RBW = 100 kHz; VBW \geq RBW; Sweep = auto; Detector function = peak.
4. Set SPA Trace 1 Max hold, then View.

9.2. TEST SET-UP (BLOCK DIAGRAM OF CONFIGURATION)

The same as described in section 8.2

9.3. MEASUREMENT EQUIPMENT USED

The same as described in section 6

9.4. LIMITS AND MEASUREMENT RESULT

| LIMITS AND MEASUREMENT RESULT | | |
|-----------------------------------------------------------------------------------------------------------------------------------------------------------------------------------------------------------------------------------------------------------------------------------------------------------------------------------------------------------------------------------------------------------------------------------------------------------------------------------------------------|----------------------------------------------------------------|----------|
| Applicable Limits | Measurement Result | |
| | Test Data | Criteria |
| In any 100 KHz Bandwidth Outside the frequency band in which the spread spectrum intentional radiator is operating, the radio frequency power that is produce by the intentional radiator shall be at least 20 dB below that in 100KHz bandwidth within the band that contains the highest level of the desired power. In addition, radiation emissions which fall in the restricted bands, as defined in §15.205(a), must also comply with the radiated emission limits specified in§15.209(a)) | At least -20dBc than the limit Specified on the BOTTOM Channel | PASS |
| | At least -20dBc than the limit Specified on the TOP Channel | PASS |

TEST PLOT OF OUT OF BAND EMISSIONS WITH THE WORST CASE
 OF GFSK MODULATION IN LOW CHANNEL

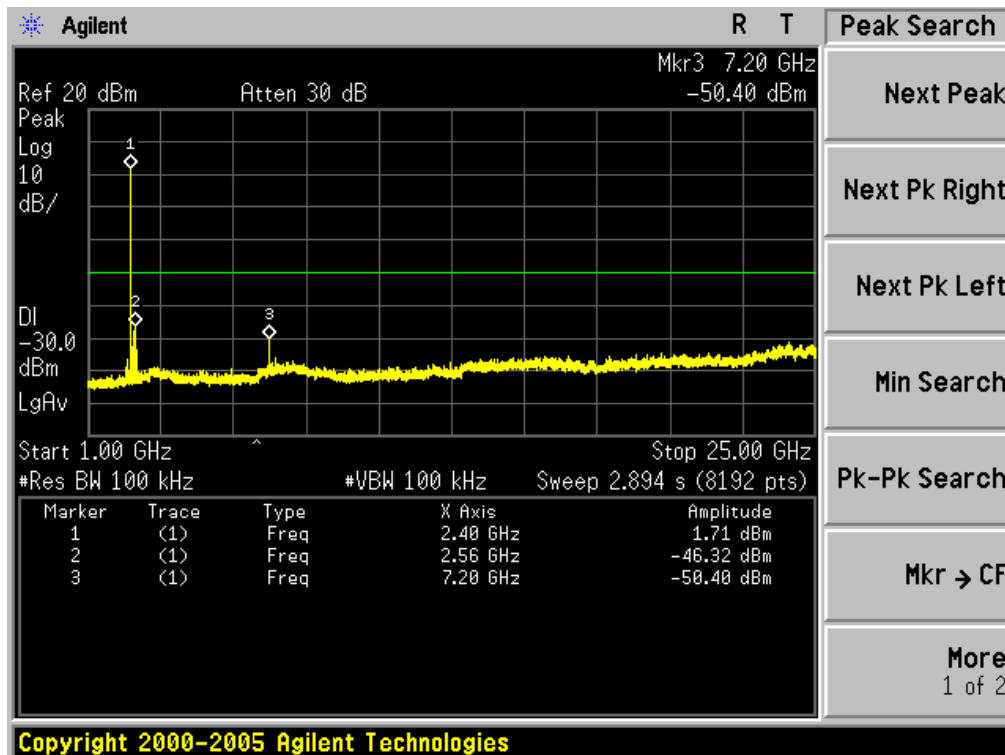
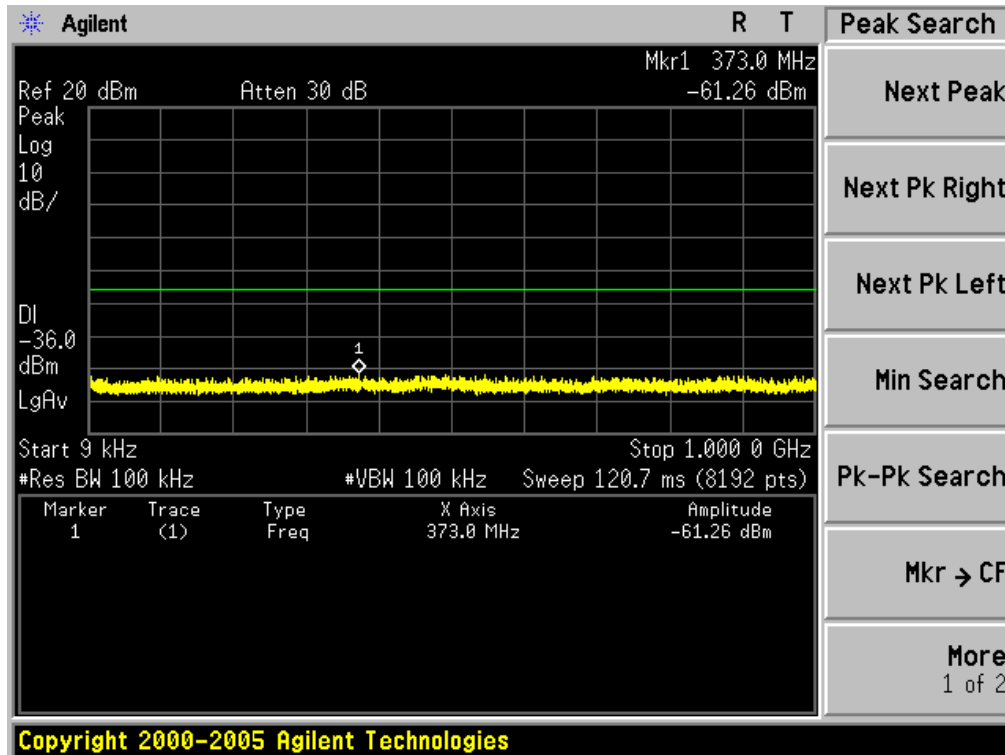

TEST PLOT OF OUT OF BAND EMISSIONS
OF GFSK MODULATION IN MIDDLE CHANNEL

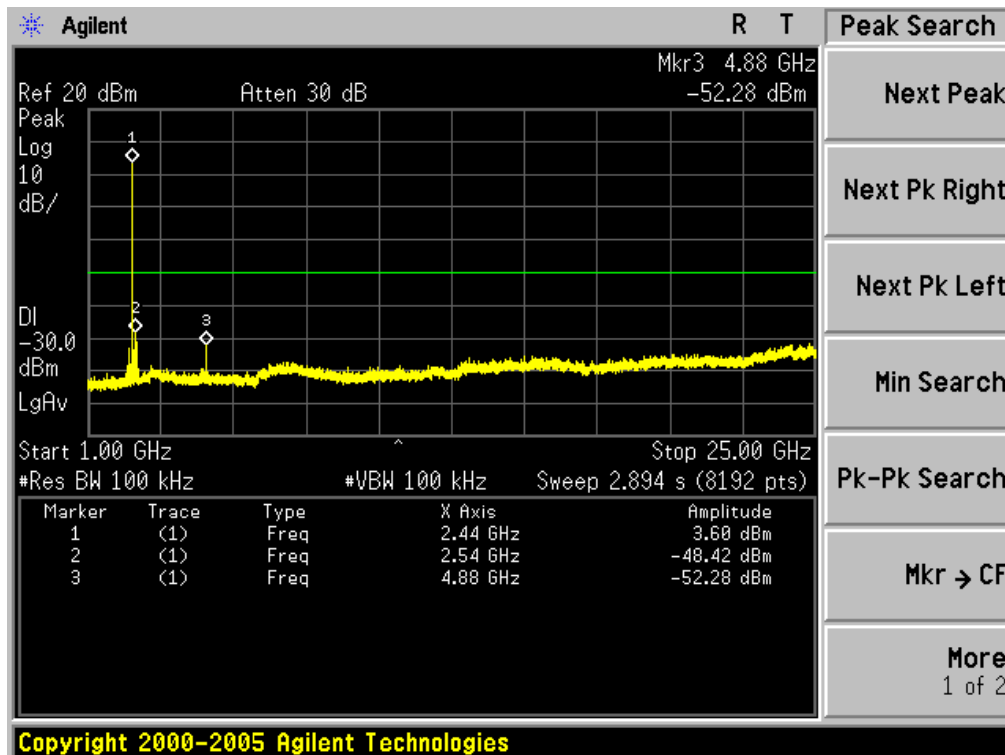
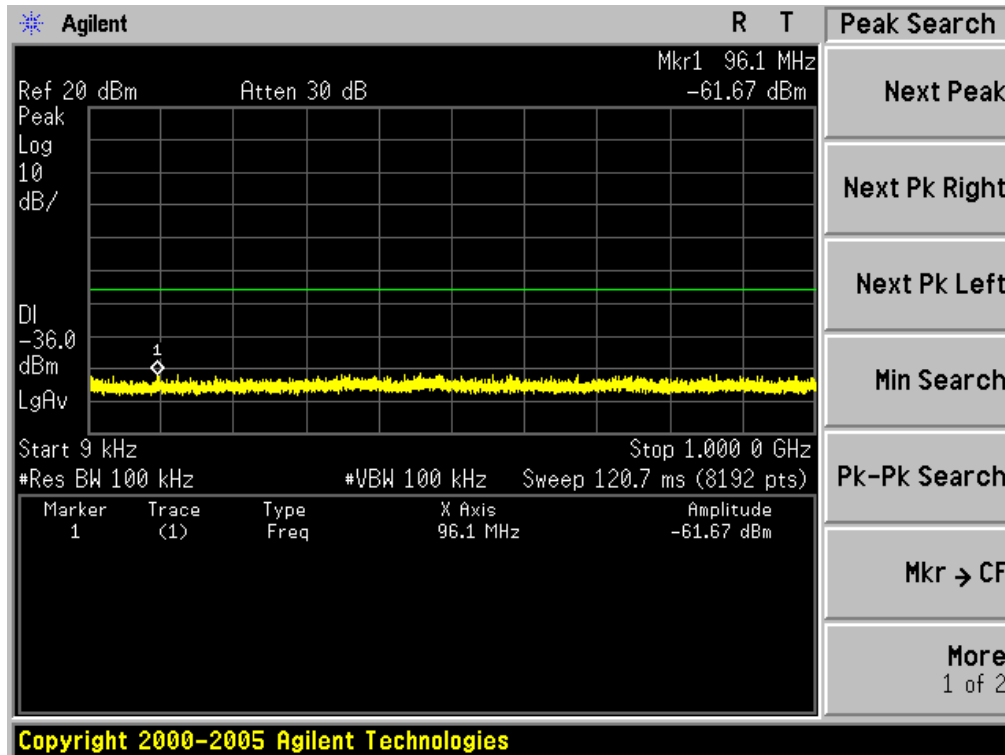

TEST PLOT OF OUT OF BAND EMISSIONS
 OF GFSK MODULATION IN HIGH CHANNEL

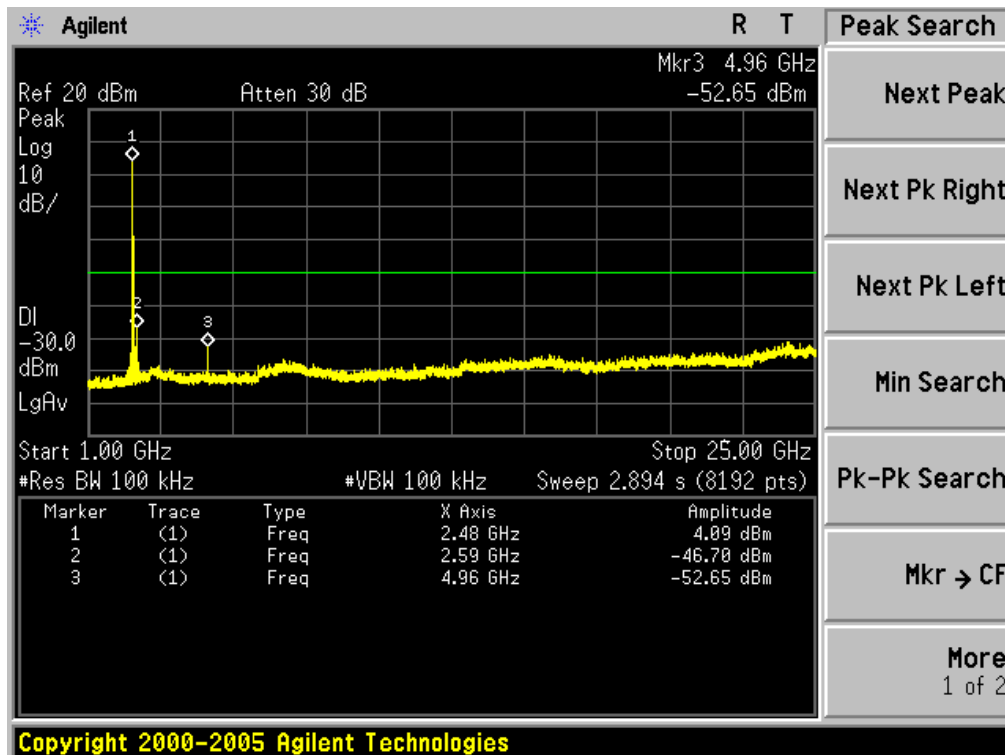
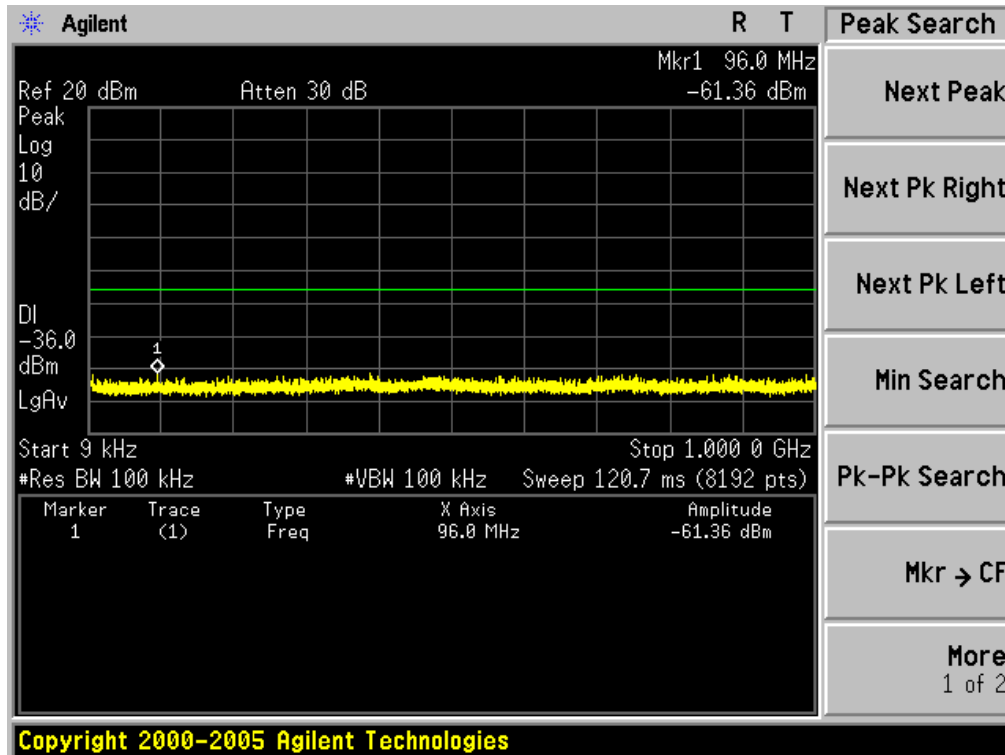

10. RADIATED EMISSION

10.1. MEASUREMENT PROCEDURE

1. Configure the EUT according to ANSI C63.4. The EUT was placed on the top of the turntable 0.8 meter above ground. The phase center of the receiving antenna mounted on the top of a height-variable antenna tower was placed 3 meters far away from the turntable.
2. Power on the EUT and all the supporting units. The turntable was rotated by 360 degrees to determine the position of the highest radiation.
3. The height of the broadband receiving antenna was varied between one meter and four meters above ground to find the maximum emissions field strength of both horizontal and vertical polarization.
4. For each suspected emissions, the antenna tower was scan (from 1 M to 4 M) and then the turntable was rotated (from 0 degree to 360 degrees) to find the maximum reading.
5. Set the test-receiver system to Peak or CISPR quasi-peak Detect Function with specified bandwidth under Maximum Hold Mode.
6. For emissions above 1GHz, use 1MHz VBW and RBW for peak reading. Then 1MHz RBW and 10Hz VBW for average reading in spectrum analyzer.
7. When the radiated emissions limits are expressed in terms of the average value of the emissions, and pulsed operation is employed, the measurement field strength shall be determined by averaging over one complete pulse train, including blanking intervals, as long as the pulse train does not exceed 0.1 seconds. As an alternative (provided the transmitter operates for longer than 0.1 seconds) or in cases where the pulse train exceeds 0.1 seconds, the measured field strength shall be determined from the average absolute voltage during a 0.1 second interval during which the field strength is at its maximum values.
8. If the emissions level of the EUT in peak mode was 3 dB lower than the average limit specified, then testing will be stopped and peak values of EUT will be reported for above 1GHz, and the emissions which do not have 3 dB margin will be repeated one by one using the quasi-peak method for below 1GHz.
9. For testing above 1GHz, the emissions level of the EUT in peak mode was lower than average limit (that means the emissions level in peak mode also complies with the limit in average mode), then testing will be stopped and peak values of EUT will be reported, otherwise, the emissions will be measured in average mode again and reported.
10. In case the emission is lower than 30MHz, loop antenna has to be used for measurement and the recorded data should be QP measured by receiver. High - Low scan is not required in this case.

The following table is the setting of spectrum analyzer and receiver.

| Spectrum Parameter | Setting |
|---------------------------|-----------------------------------------------------------|
| Start ~Stop Frequency | 9KHz~150KHz/RB 200Hz for QP |
| Start ~Stop Frequency | 150KHz~30MHz/RB 9KHz for QP |
| Start ~Stop Frequency | 30MHz~1000MHz/RB 120KHz for QP |
| Start ~Stop Frequency | 1GHz~26.5GHz 1MHz/1MHz for Peak, 1MHz/10Hz for Average |

| Receiver Parameter | Setting |
|---------------------------|--------------------------------|
| Start ~Stop Frequency | 9KHz~150KHz/RB 200Hz for QP |
| Start ~Stop Frequency | 150KHz~30MHz/RB 9KHz for QP |
| Start ~Stop Frequency | 30MHz~1000MHz/RB 120KHz for QP |

10.2. TEST SETUP

RADIATED EMISSION TEST SETUP 30MHz-1000MHz

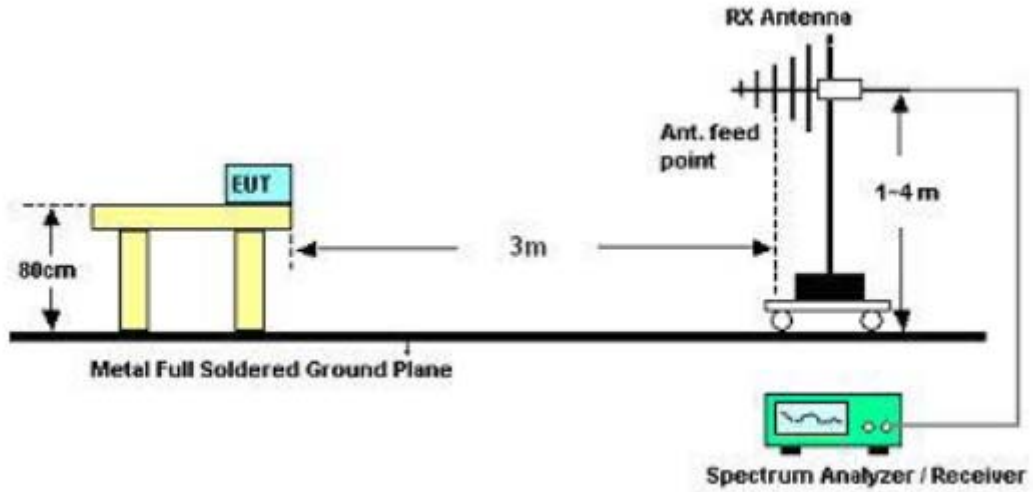

RADIATED EMISSION TEST SETUP ABOVE 1000MHz

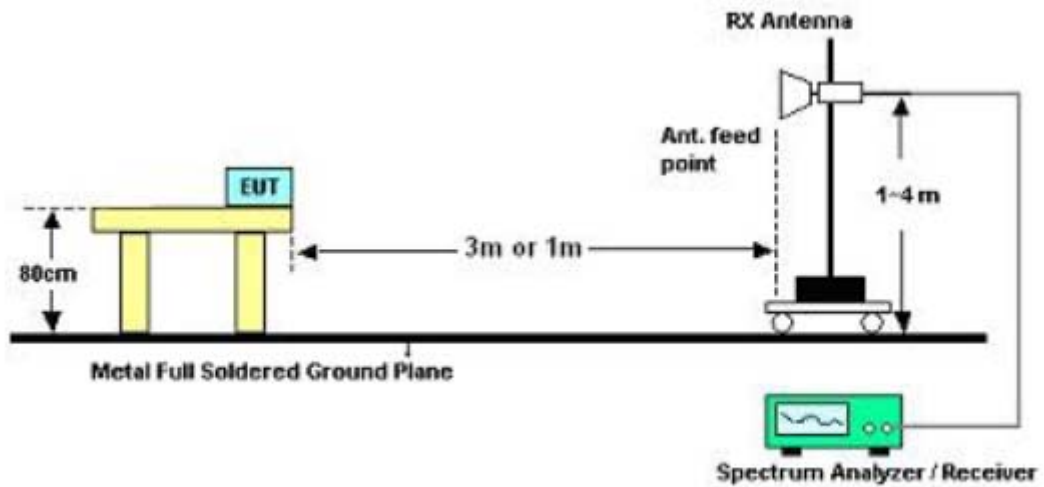

10.3. TEST RESULT (Worst Modulation: GFSK)

RADIATED EMISSION BELOW 30MHZ

No emission found between lowest internal used/generated frequencies to 30MHz.

RADIATED EMISSION BELOW 1GHZ

RADIATED EMISSION TEST- (30MHZ-1GHZ)-LOW CHANNEL-HORIZONTAL

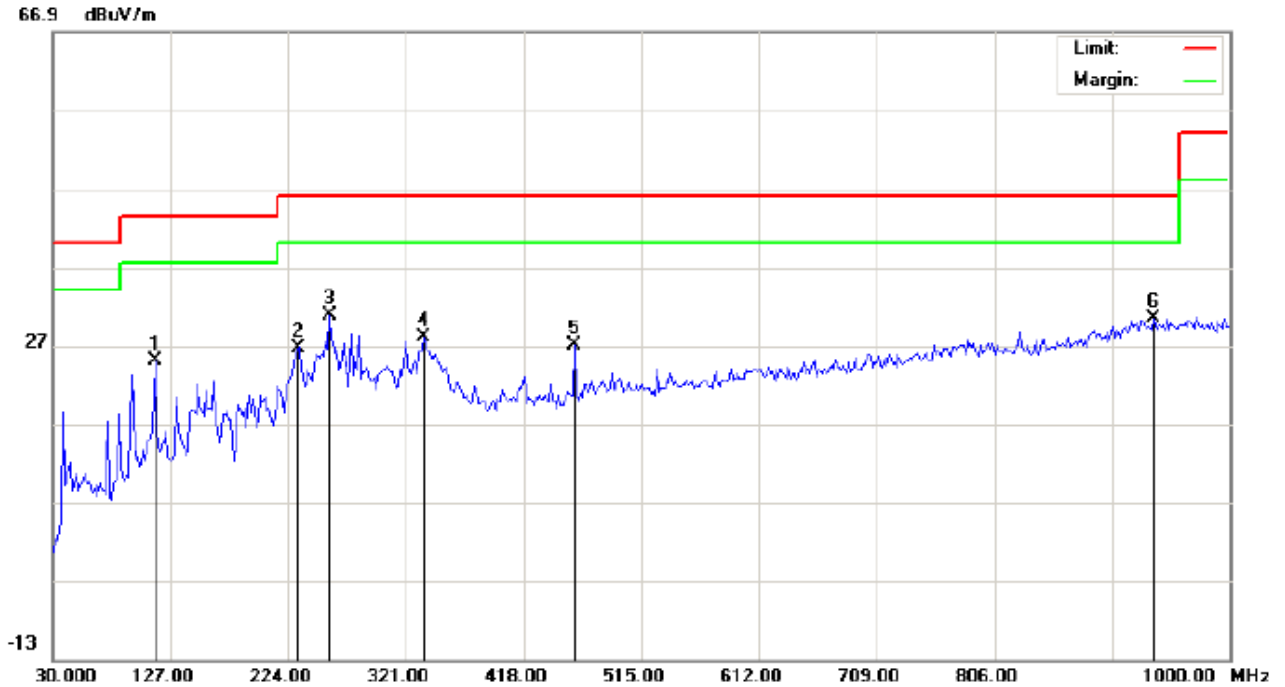

Site: site #1
Limit: FCC Class B 3M Radiation
EUT: Bluetooth Headset
M/N: SH26
Mode: Low Channel TX
Note:

Polarization: *Horizontal*
Power:
Distance: 3m

Temperature: 26
Humidity: 60 %

| No. | Mk | Freq. | Reading | Factor | Measurement | Limit | Over | Detector | Antenna Height | Table Degree | Comment |
|-----|----|----------|---------|--------|-------------|--------|--------|----------|----------------|--------------|---------|
| | | MHz | dBuV | dB/m | dBuV/m | dBuV/m | dB | | cm | degree | |
| 1 | | 114.0667 | 13.53 | 11.45 | 24.98 | 43.50 | -18.52 | peak | | | |
| 2 | | 232.0833 | 13.43 | 13.22 | 26.65 | 46.00 | -19.35 | peak | | | |
| 3 | * | 257.9500 | 16.75 | 14.14 | 30.89 | 46.00 | -15.11 | peak | | | |
| 4 | | 335.5500 | 10.16 | 17.78 | 27.94 | 46.00 | -18.06 | peak | | | |
| 5 | | 460.0333 | 6.30 | 20.70 | 27.00 | 46.00 | -19.00 | peak | | | |
| 6 | | 936.9500 | 0.75 | 29.64 | 30.39 | 46.00 | -15.61 | peak | | | |

RESULT: PASS

RADIATED EMISSION TEST- (30MHZ-1GHZ)-LOW CHANNEL -VERTICAL

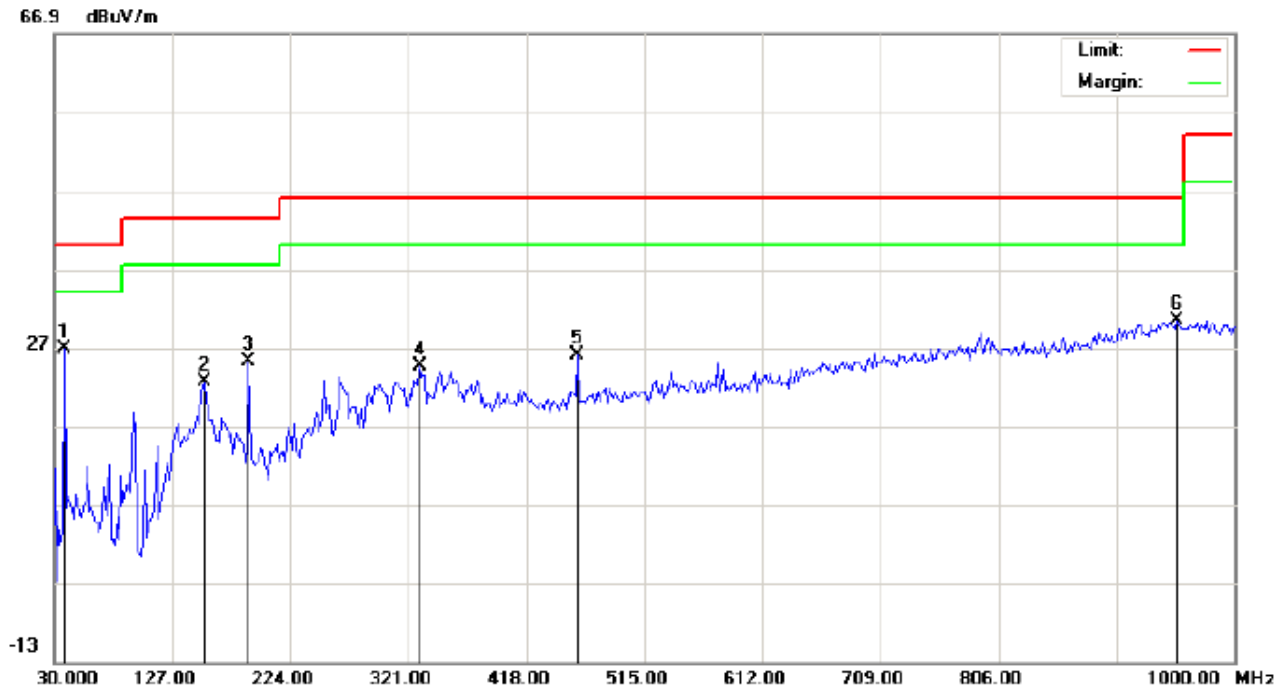

Site: site #1
Limit: FCC Class B 3M Radiation
EUT: Bluetooth Headset
M/N: SH26
Mode: Low Channel TX
Note:

Polarization: *Vertical*
Power:
Distance: 3m

Temperature: 26
Humidity: 60 %

| No. | Mk | Freq. | Reading | Factor | Measurement | Limit | Over | Detector | Antenna Height | Table Degree | Comment |
|-----|----|----------|---------|--------|-------------|--------|--------|----------|----------------|--------------|---------|
| | | MHz | dBuV | dB/m | dBuV/m | dBuV/m | dB | | cm | degree | |
| 1 | * | 38.0833 | 20.34 | 6.39 | 26.73 | 40.00 | -13.27 | peak | | | |
| 2 | | 152.8667 | 7.36 | 15.28 | 22.64 | 43.50 | -20.86 | peak | | | |
| 3 | | 190.0500 | 13.62 | 11.52 | 25.14 | 43.50 | -18.36 | peak | | | |
| 4 | | 330.7000 | 7.10 | 17.45 | 24.55 | 46.00 | -21.45 | peak | | | |
| 5 | | 460.0333 | 5.37 | 20.70 | 26.07 | 46.00 | -19.93 | peak | | | |
| 6 | | 953.1167 | 0.44 | 29.97 | 30.41 | 46.00 | -15.59 | peak | | | |

RESULT: PASS

Note: 1. Factor=Antenna Factor + Cable loss, Margin=Measurement-Limit.

2. The "Factor" value can be calculated automatically by software of measurement system.

RADIATED EMISSION TEST- (30MHZ-1GHZ)-MIDDLE CHANNEL-HORIZONTAL

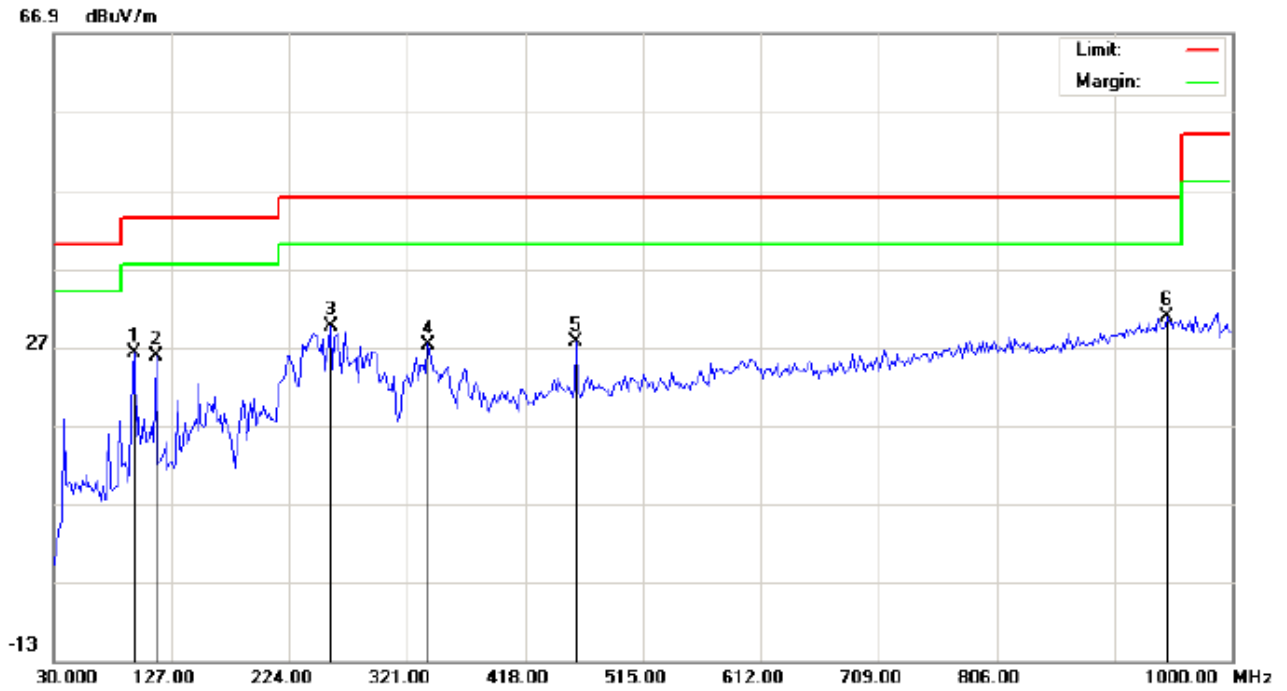

Site: site #1
Limit: FCC Class B 3M Radiation
EUT: Bluetooth Headset
M/N: SH26
Mode: Middle Channel TX
Note:

Polarization: *Horizontal*
Power:
Distance: 3m

Temperature: 26
Humidity: 60 %

| No. | Mk | Freq. | Reading | Factor | Measurement | Limit | Over | Detector | Antenna | Table | Comment |
|-----|----|----------|---------|--------|-------------|--------|--------|----------|---------|--------|---------|
| | | MHz | dBuV | dB/m | dBuV/m | dBuV/m | dB | | Height | Degree | |
| 1 | | 96.2833 | 16.07 | 10.07 | 26.14 | 43.50 | -17.36 | peak | cm | degree | |
| 2 | | 114.0667 | 14.31 | 11.45 | 25.76 | 43.50 | -17.74 | peak | | | |
| 3 | | 257.9500 | 15.56 | 14.14 | 29.70 | 46.00 | -16.30 | peak | | | |
| 4 | | 338.7833 | 9.31 | 17.99 | 27.30 | 46.00 | -18.70 | peak | | | |
| 5 | | 460.0333 | 6.82 | 20.70 | 27.52 | 46.00 | -18.48 | peak | | | |
| 6 | * | 946.6500 | 0.87 | 29.91 | 30.78 | 46.00 | -15.22 | peak | | | |

RESULT: PASS

RADIATED EMISSION TEST- (30MHZ-1GHZ)- MIDDLE CHANNEL -VERTICAL

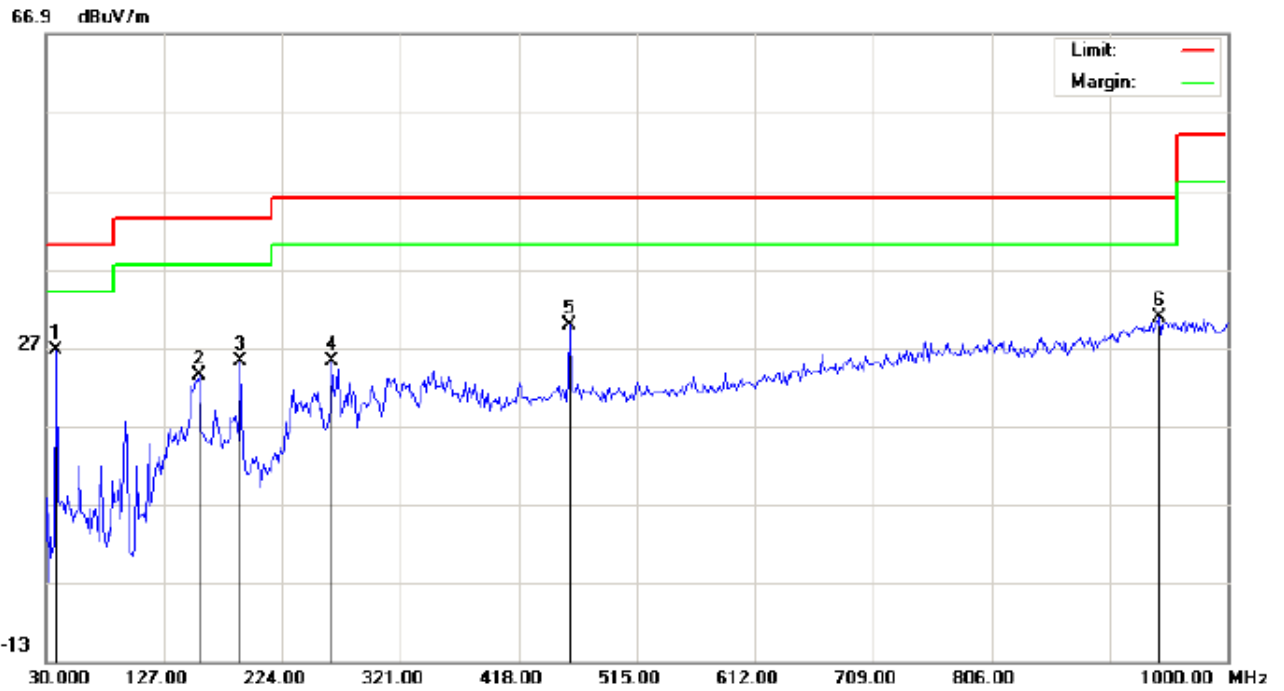

Site: site #1
Limit: FCC Class B 3M Radiation
EUT: Bluetooth Headset
M/N: SH26
Mode: Middle Channel TX
Note:

Polarization: *Vertical*
Power:
Distance: 3m

Temperature: 26
Humidity: 60 %

| No. | Mk | Freq. | Reading | Factor | Measurement | Limit | Over | Detector | Antenna | Table | Comment |
|-----|----|----------|---------|--------|-------------|--------|--------|----------|---------|--------|---------|
| | | MHz | dBuV | dB/m | dBuV/m | dBuV/m | dB | | Height | Degree | |
| 1 | * | 38.0833 | 20.23 | 6.39 | 26.62 | 40.00 | -13.38 | peak | cm | degree | |
| 2 | | 156.1000 | 8.10 | 15.30 | 23.40 | 43.50 | -20.10 | peak | | | |
| 3 | | 190.0500 | 13.70 | 11.52 | 25.22 | 43.50 | -18.28 | peak | | | |
| 4 | | 264.4166 | 10.88 | 14.34 | 25.22 | 46.00 | -20.78 | peak | | | |
| 5 | | 460.0333 | 9.03 | 20.70 | 29.73 | 46.00 | -16.27 | peak | | | |
| 6 | | 943.4167 | 0.94 | 29.82 | 30.76 | 46.00 | -15.24 | peak | | | |

RESULT: PASS

Note: 1. Factor=Antenna Factor + Cable loss, Margin=Measurement-Limit.

2. The "Factor" value can be calculated automatically by software of measurement system.

RADIATED EMISSION TEST- (30MHZ-1GHZ)-HIGH CHANNEL-HORIZONTAL

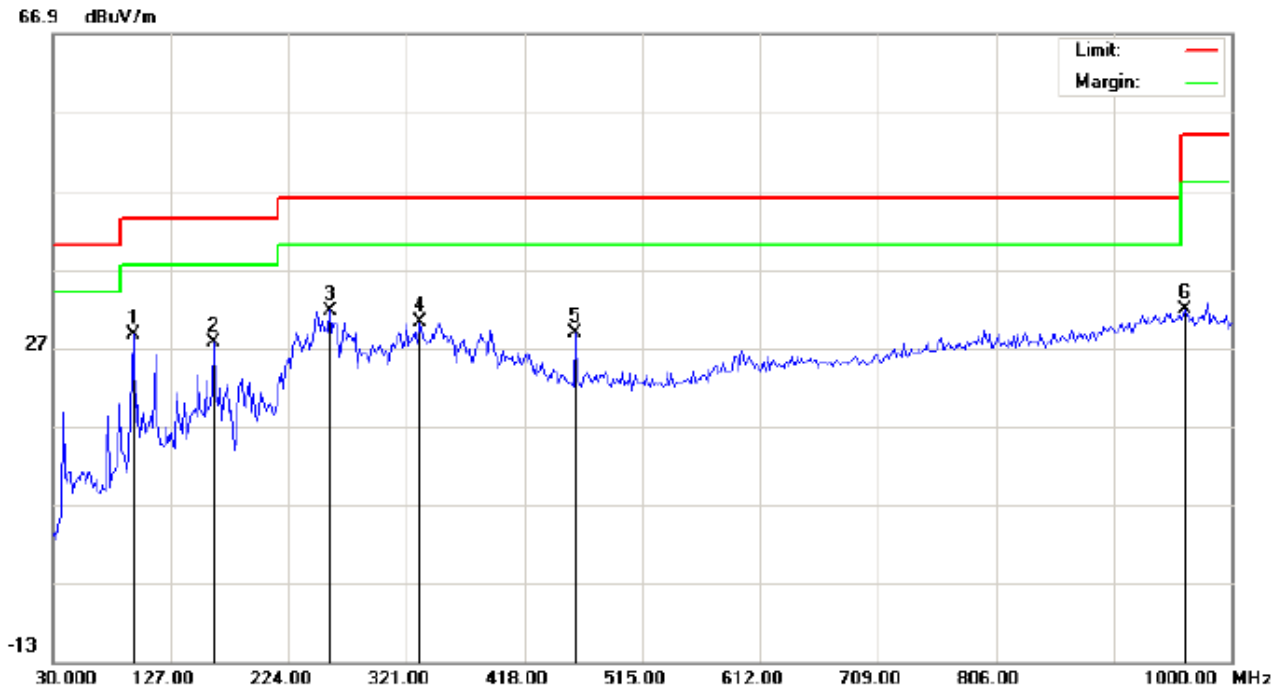

Site: site #1
Limit: FCC Class B 3M Radiation
EUT: Bluetooth Headset
M/N: SH26
Mode: High Channel TX
Note:

Polarization: *Horizontal*
Power:
Distance: 3m

Temperature: 26
Humidity: 60 %

| No. | Mk | Freq. | Reading | Factor | Measurement | Limit | Over | Detector | Antenna Height | Table Degree | Comment |
|-----|----|----------|---------|--------|-------------|--------|--------|----------|----------------|--------------|---------|
| | | MHz | dBuV | dB/m | dBuV/m | dBuV/m | dB | | cm | degree | |
| 1 | | 96.2833 | 18.52 | 10.07 | 28.59 | 43.50 | -14.91 | peak | | | |
| 2 | | 162.5667 | 12.85 | 14.78 | 27.63 | 43.50 | -15.87 | peak | | | |
| 3 | * | 257.9500 | 17.56 | 14.14 | 31.70 | 46.00 | -14.30 | peak | | | |
| 4 | | 332.3167 | 12.61 | 17.56 | 30.17 | 46.00 | -15.83 | peak | | | |
| 5 | | 460.0333 | 8.06 | 20.70 | 28.76 | 46.00 | -17.24 | peak | | | |
| 6 | | 961.2000 | 1.97 | 29.89 | 31.86 | 54.00 | -22.14 | peak | | | |

RESULT: PASS

RADIATED EMISSION TEST- (30MHZ-1GHZ)-HIGH CHANNEL -VERTICAL

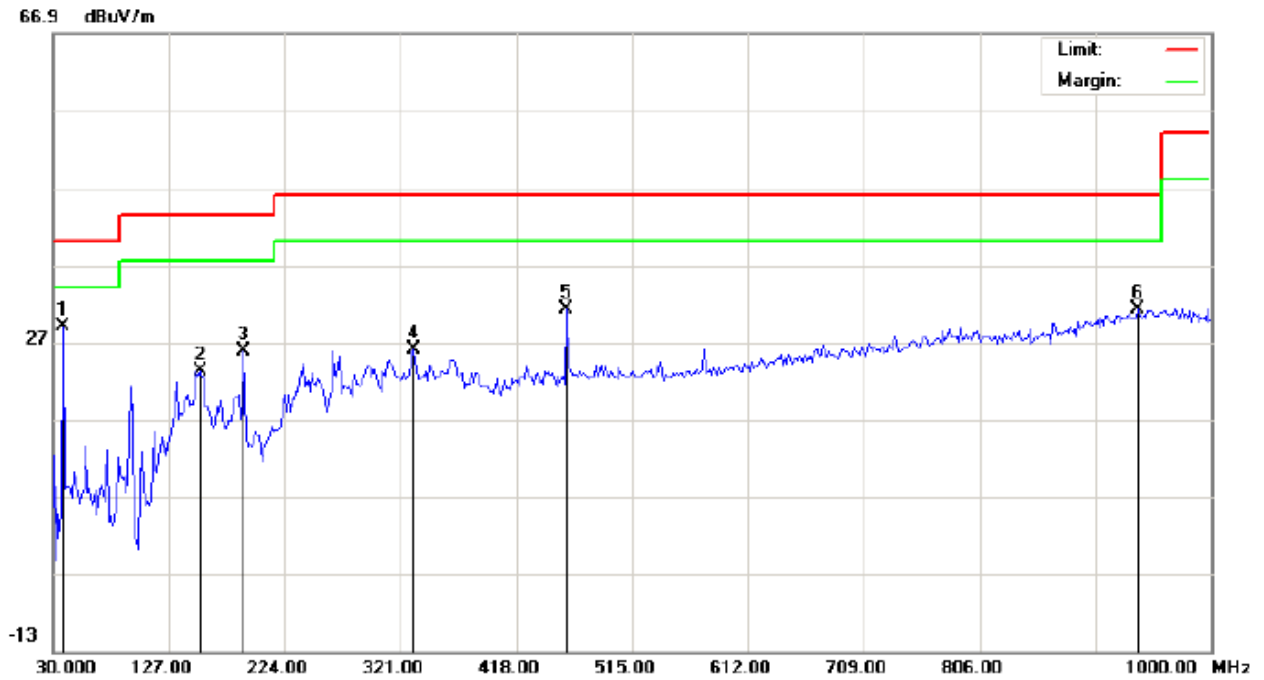

Site: site #1
Limit: FCC Class B 3M Radiation
EUT: Bluetooth Headset
M/N: SH26
Mode: High Channel TX
Note:

Polarization: **Vertical**
Power:
Distance: 3m

Temperature: 26
Humidity: 60 %

| No. | Mk | Freq. | Reading | Factor | Measurement | Limit | Over | Detector | Antenna Height | Table Degree | Comment |
|-----|----|----------|---------|--------|-------------|--------|--------|----------|----------------|--------------|---------|
| | | MHz | dBuV | dB/m | dBuV/m | dBuV/m | dB | | cm | degree | |
| 1 | * | 38.0833 | 22.65 | 6.39 | 29.04 | 40.00 | -10.96 | peak | | | |
| 2 | | 152.8667 | 8.01 | 15.28 | 23.29 | 43.50 | -20.21 | peak | | | |
| 3 | | 190.0500 | 14.28 | 11.52 | 25.80 | 43.50 | -17.70 | peak | | | |
| 4 | | 332.3167 | 8.48 | 17.56 | 26.04 | 46.00 | -19.96 | peak | | | |
| 5 | | 460.0333 | 10.50 | 20.70 | 31.20 | 46.00 | -14.80 | peak | | | |
| 6 | | 938.5667 | 1.61 | 29.68 | 31.29 | 46.00 | -14.71 | peak | | | |

RESULT: PASS

Note: 1. Factor=Antenna Factor + Cable loss, Margin=Measurement-Limit.

2. The "Factor" value can be calculated automatically by software of measurement system.

RADIATED EMISSION ABOVE 1GHZ (1-10th Harmonics)-HIGH CHANNEL-HORIZONTAL

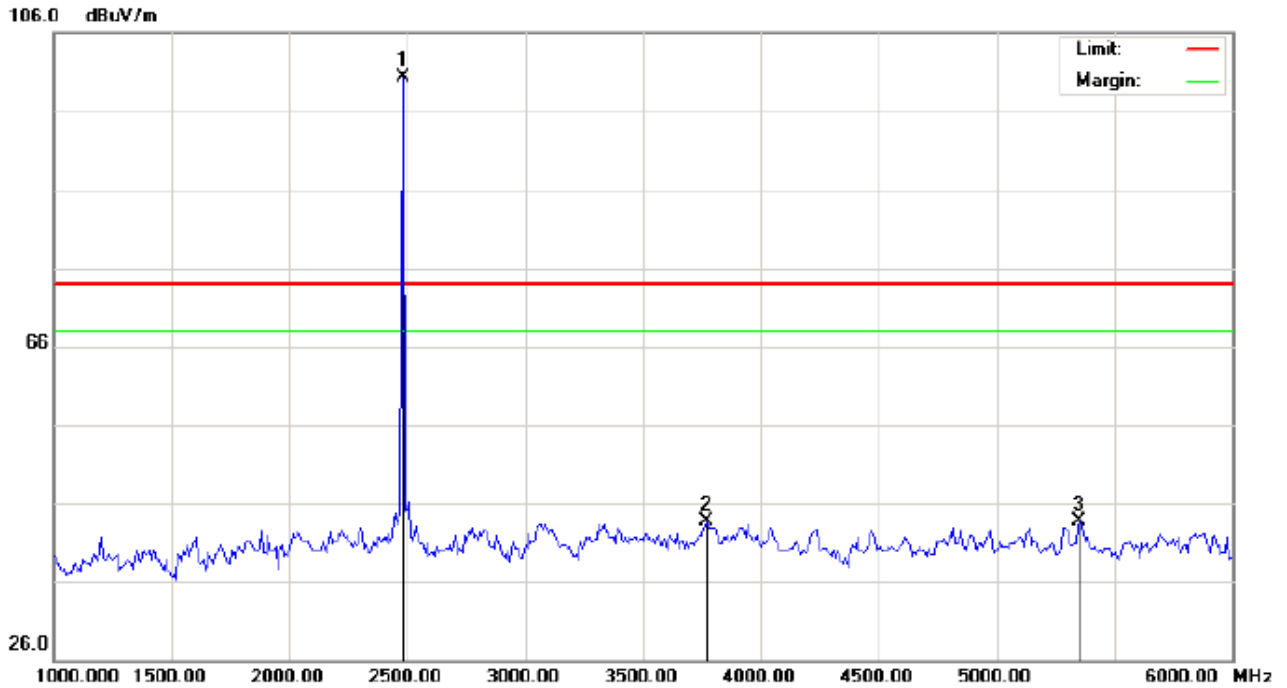

Site: site #1 Polarization: *Horizontal* Temperature: 26
Limit: FCC Class B 3M Radiation above 1GHZ(PK) Power: Humidity: 60 %
EUT: Bluetooth Headset Distance:
M/N: SH26
Mode: High Channel TX
Note:

| No. | Mk | Freq. | Reading | Factor | Measurement | Limit | Over | Detector | Antenna | Table | Comment |
|-----|----|----------|---------|--------|-------------|--------|--------|----------|---------|--------|---------|
| | | MHz | dBuV | dB/m | dBuV/m | dBuV/m | dB | | Height | Degree | |
| 1 | * | 2480.000 | 89.93 | 10.41 | 100.34 | 74.00 | 26.34 | peak | cm | degree | |
| 2 | | 3766.667 | 29.94 | 13.75 | 43.69 | 74.00 | -30.31 | peak | | | |
| 3 | | 5350.000 | 42.51 | 1.19 | 43.70 | 74.00 | -30.30 | peak | | | |

RESULT: PASS

11. BAND EDGE EMISSION

11.1. MEASUREMENT PROCEDURE

1. Set the EUT Work on the top, the bottom operation frequency individually.
2. Set SPA Start or Stop Frequency=Operation Frequency, $RBW \geq 100\text{kHz}$, $VBW \geq 3 * RBW$,
Center frequency =Operation frequency
3. The band edges was measured and recorded.

11.2. TEST SET-UP

Radiated same as 10.2

12. NUMBER OF HOPPING FREQUENCY

12.1. MEASUREMENT PROCEDURE

1. Place the EUT on the table and set it in transmitting mode.
2. Remove the antenna from the EUT and then connect a low RF cable from the antenna port to the spectrum analyzer.
3. Set the spectrum analyzer Start = 2.4GHz Stop = 2.4835GHz
4. Set the Spectrum Analyzer as RBW>=1%span, VBW>=RBW.

12.2. TEST SETUP (BLOCK DIAGRAM OF CONFIGURATION)

Same as described in section 8.2

12.3. MEASUREMENT EQUIPMENT USED

The same as described in section 6

12.4. LIMITS AND MEASUREMENT RESULT

| TOTAL NO. OF HOPPING CHANNEL | LIMIT (NO. OF CH) | MEASUREMENT (NO. OF CH) | RESULT |
|------------------------------|-------------------|-------------------------|--------|
| | >=15 | 79 | PASS |

TEST PLOT FOR NO. OF TOTAL CHANNELS

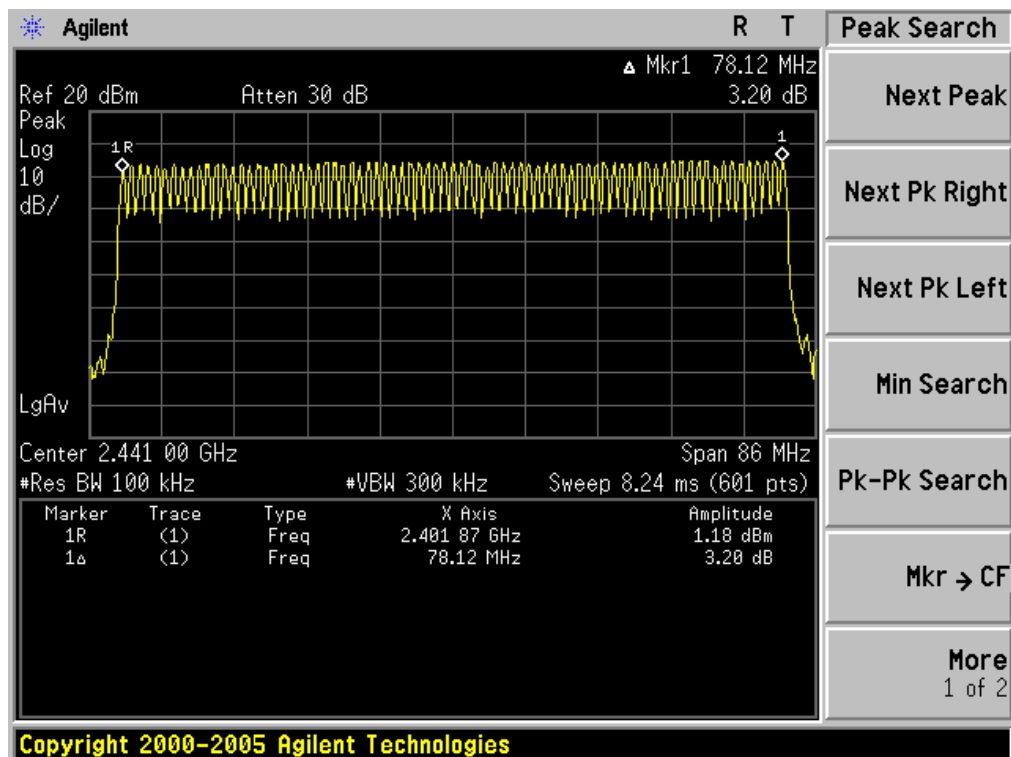

13. TIME OF OCCUPANCY (DWELL TIME)

13.1. MEASUREMENT PROCEDURE

1. Place the EUT on the table and set it in transmitting mode
2. Remove the antenna from the EUT and then connect a low RF cable from the antenna port to the spectrum analyzer.
3. Set Span = zero span, centered on a hopping channel
4. Set the spectrum analyzer as RBW=1MHz, VBW>=RBW, Span = 0 Hz

13.2. TEST SETUP (BLOCK DIAGRAM OF CONFIGURATION)

Same as described in section 8.2

13.3. MEASUREMENT EQUIPMENT USED

The same as described in section 6

13.4. LIMITS AND MEASUREMENT RESULT

The Worst Case (3Mbps)

| Channel | Time of Pulse for DH5 (ms) | Period Time (s) | Sweep Time (ms) | Limit (ms) |
|---------|----------------------------|-----------------|-----------------|------------|
| Low | 2.912 | 31.6 | 310.61 | 400 |
| Middle | 2.912 | 31.6 | 310.61 | 400 |
| High | 2.912 | 31.6 | 310.61 | 400 |

Low Channel Time

$$2.912 \times (1600/6) / 79 \times 31.6 = 310.61 \text{ms}$$

Middle Channel Time

$$2.912 \times (1600/6) / 79 \times 31.6 = 310.61 \text{ms}$$

High Channel Time

$$2.912 \times (1600/6) / 79 \times 31.6 = 310.61 \text{ms}$$

TEST PLOT OF LOW CHANNEL

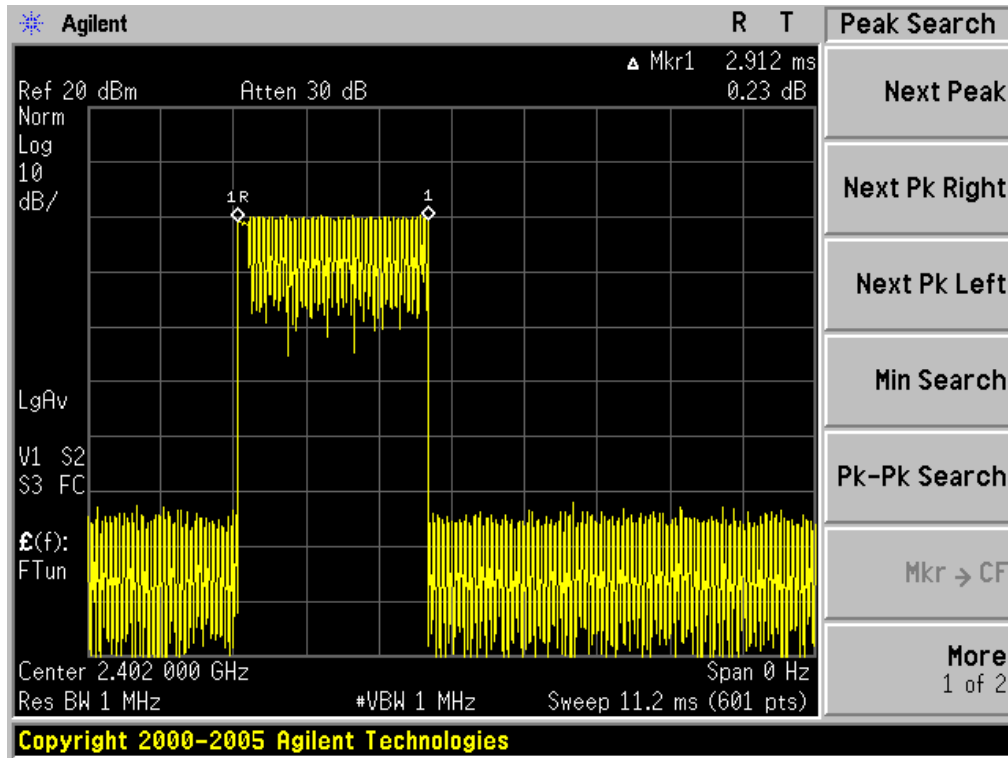

TEST PLOT OF MIDDLE CHANNEL

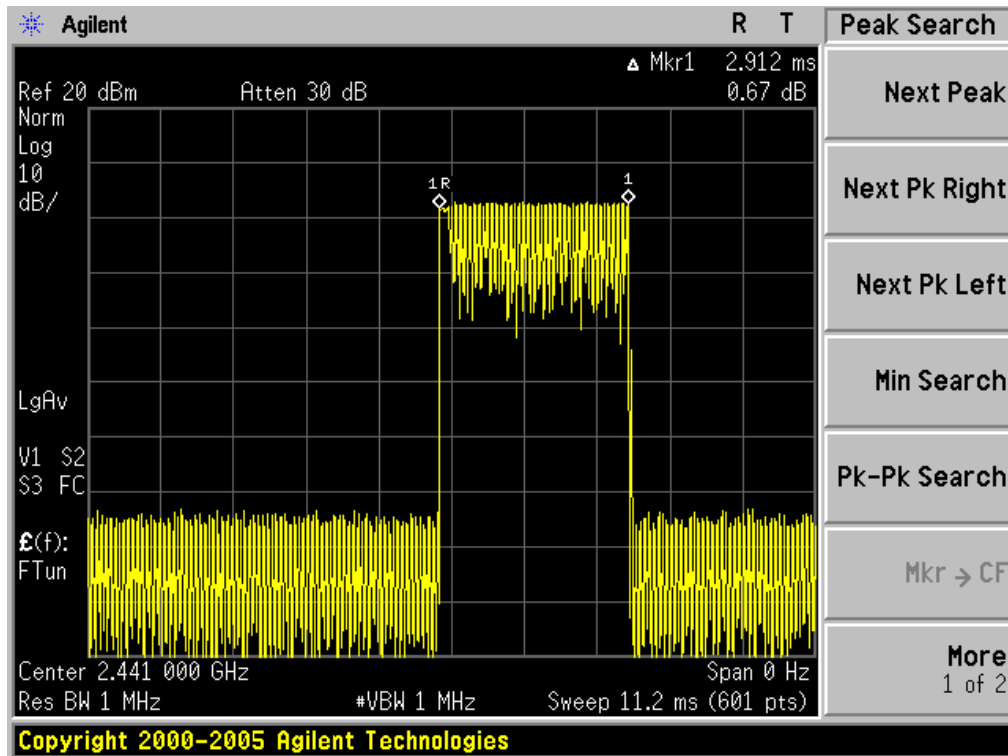

TEST PLOT OF HIGH CHANNEL

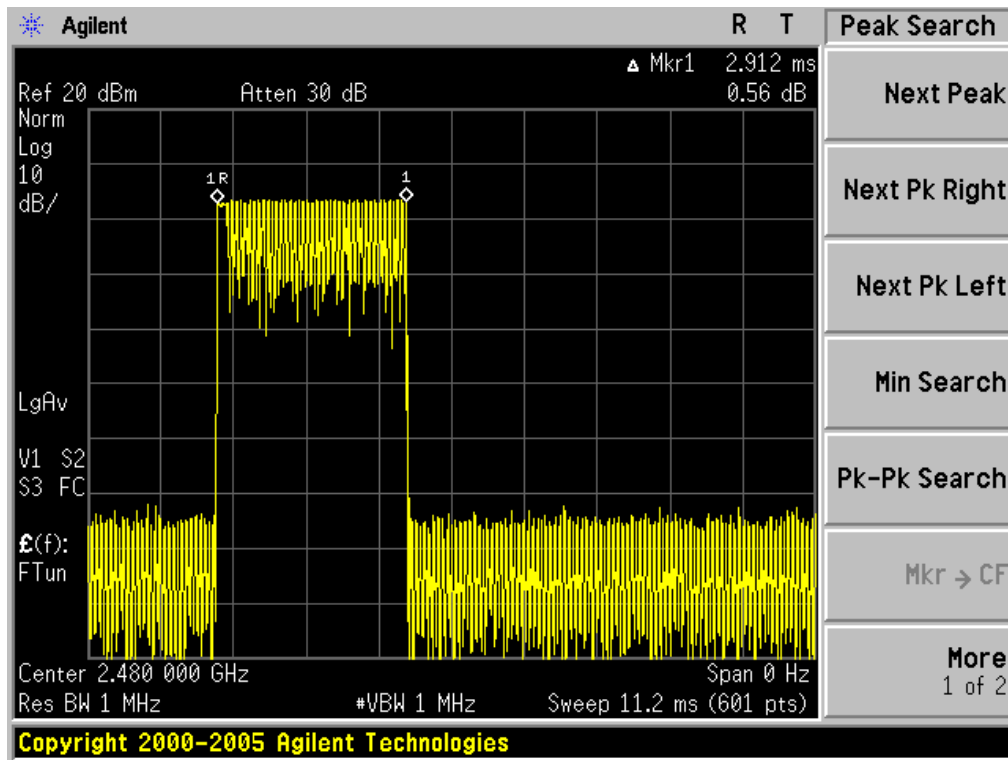

14. FREQUENCY SEPARATION

14.1. MEASUREMENT PROCEDURE

1. Place the EUT on the table and set it in transmitting mode
2. Remove the antenna from the EUT and then connect a low RF cable from the antenna port to the spectrum analyzer
3. Set Span = wide enough to capture the peaks of two adjacent channels Resolution (or IF) Bandwidth (RBW) \geq 1% of the span Video (or Average) Bandwidth (VBW) \geq RBW; Sweep = auto; Detector function = peak; Trace = max hold

14.2. TEST SETUP (BLOCK DIAGRAM OF CONFIGURATION)

Same as described in section 6.2

14.3. MEASUREMENT EQUIPMENT USED

The same as described in section 6.3

14.4. LIMITS AND MEASUREMENT RESULT

| CHANNEL | CHANNEL SEPARATION | LIMIT | RESULT |
|-----------|--------------------|-------------------------------|--------|
| | KHz | KHz | |
| CH00-CH01 | 1000 | \geq 25 KHz or 2/3 20 dB BW | Pass |

TEST PLOT FOR FREQUENCY SEPARATION (3Mbps)

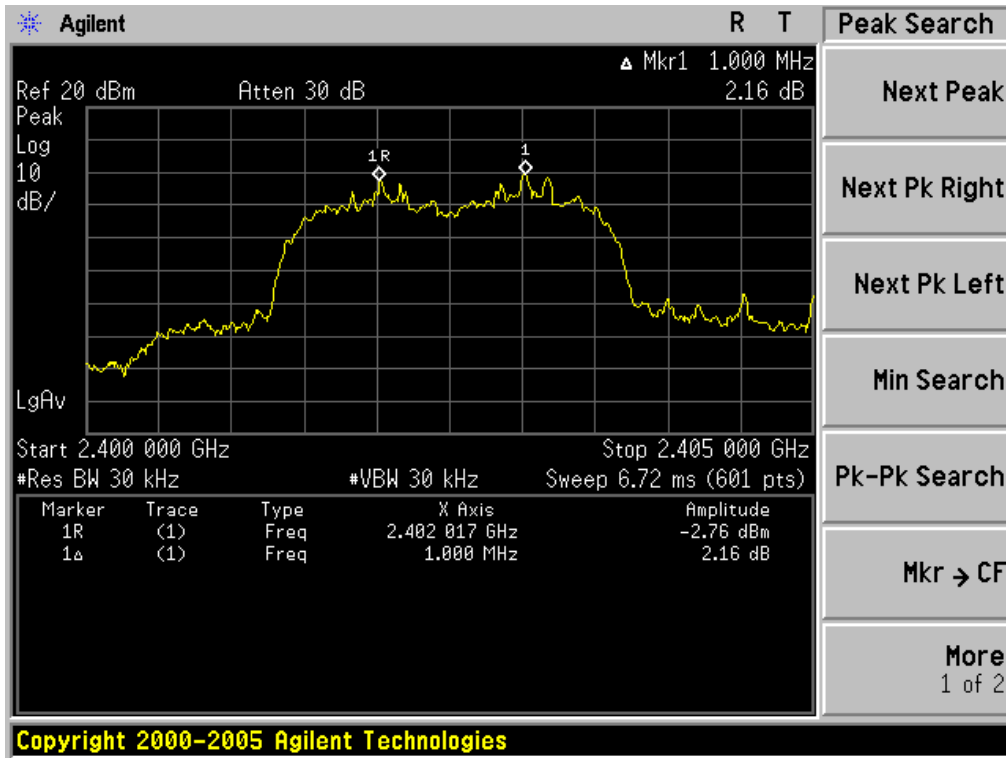

15. FCC LINE CONDUCTED EMISSION TEST

15.1. LIMITS OF LINE CONDUCTED EMISSION TEST

| Frequency | Maximum RF Line Voltage | |
|---------------|-------------------------|----------------|
| | Q.P.(dBuV) | Average(dBuV) |
| 150kHz~500kHz | 66-56 | 56-46 |
| 500kHz~5MHz | 56 | 46 |
| 5MHz~30MHz | 60 | 50 |

Note:

1. The lower limit shall apply at the transition frequency.
2. The limit decreases linearly with the logarithm of the frequency in the range 0.15 MHz to 0.50 MHz.

15.2. BLOCK DIAGRAM OF LINE CONDUCTED EMISSION TEST

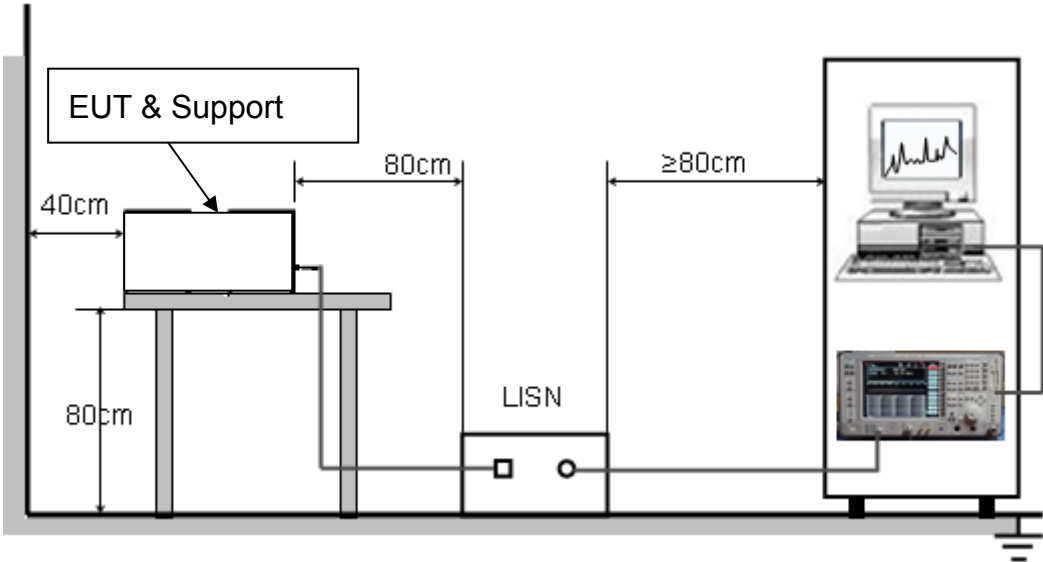

15.3. PRELIMINARY PROCEDURE OF LINE CONDUCTED EMISSION TEST

1. The equipment was set up as per the test configuration to simulate typical actual usage per the user's manual. When the EUT is a tabletop system, a wooden table with a height of 0.8 meters is used and is placed on the ground plane as per ANSI C63.4 (see Test Facility for the dimensions of the ground plane used). When the EUT is a floor-standing equipment, it is placed on the ground plane which has a 3-12 mm non-conductive covering to insulate the EUT from the ground plane.
2. Support equipment, if needed, was placed as per ANSI C63.4.
3. All I/O cables were positioned to simulate typical actual usage as per ANSI C63.4.
4. All support equipments received AC120V/60Hz power from a LISN, if any.
5. The EUT received DC charging voltage by PC which received 120V/60Hz power by a LISN..
6. The test program was started. Emissions were measured on each current carrying line of the EUT using a spectrum Analyzer / Receiver connected to the LISN powering the EUT. The LISN has two monitoring points: Line 1 (Hot Side) and Line 2 (Neutral Side). Two scans were taken: one with Line 1 connected to Analyzer / Receiver and Line 2 connected to a 50 ohm load; the second scan had Line 1 connected to a 50 ohm load and Line 2 connected to the Analyzer / Receiver.
7. Analyzer / Receiver scanned from 150 kHz to 30MHz for emissions in each of the test modes.
8. During the above scans, the emissions were maximized by cable manipulation.
9. The test mode(s) were scanned during the preliminary test.

Then, the EUT configuration and cable configuration of the above highest emission level were recorded for reference of final testing.

15.4. FINAL PROCEDURE OF LINE CONDUCTED EMISSION TEST

1. EUT and support equipment was set up on the test bench as per step 2 of the preliminary test.
2. A scan was taken on both power lines, Line 1 and Line 2, recording at least the six highest emissions. Emission frequency and amplitude were recorded into a computer in which correction factors were used to calculate the emission level and compare reading to the applicable limit. If EUT emission level was less -2dB to the A.V. limit in Peak mode, then the emission signal was re-checked using Q.P and Average detector.
3. The test data of the worst case condition(s) was reported on the Summary Data page.

15.5. TEST RESULT OF LINE CONDUCTED EMISSION TEST

Line Conducted Emission Test Line 1-L

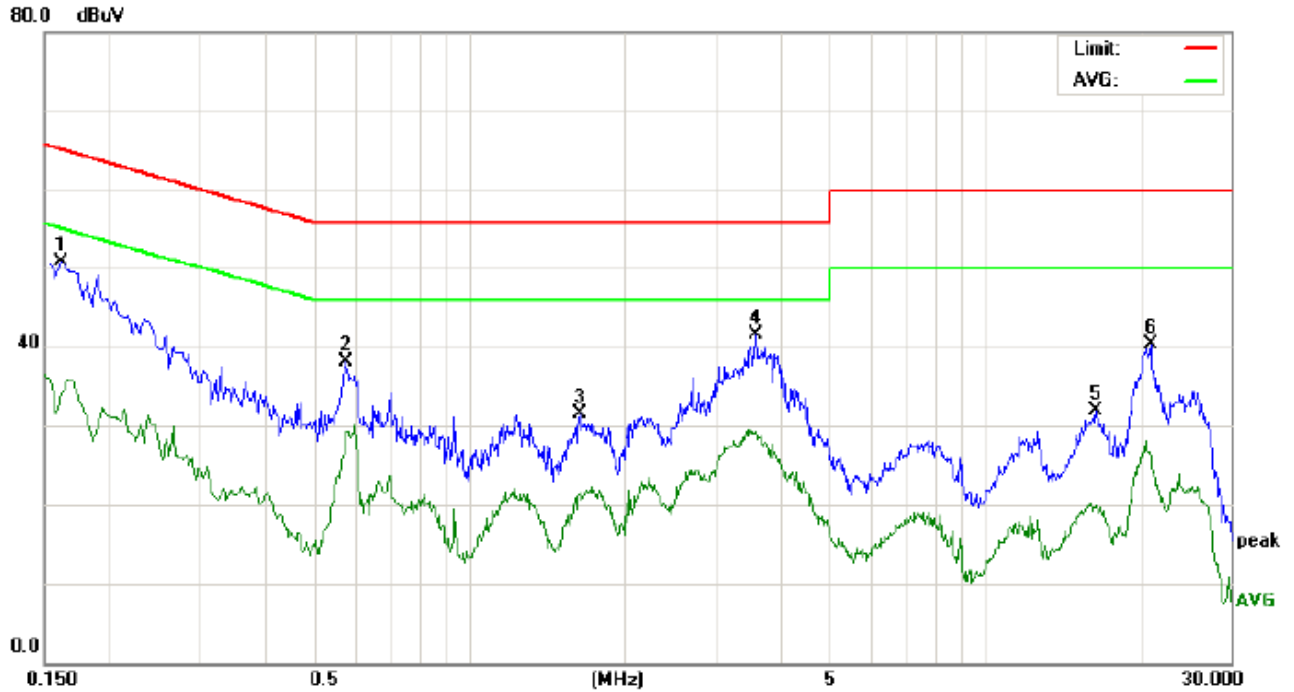

Site: Conduction Phase: **L1** Temperature: 26
Limit: FCC Class B Conduction(QP) Power: Humidity: 60 %
EUT: Bluetooth Headset
M/N: SH26
Mode: Normal Operation
Note:

| No. | Freq. (MHz) | Reading_Level (dBuV) | | | Correct Factor (dB) | Measurement (dBuV) | | | Limit (dBuV) | | Margin (dB) | | P/F | Comment |
|-----|-------------|----------------------|----|-------|---------------------|--------------------|----|-------|--------------|-------|-------------|--------|-----|---------|
| | | Peak | QP | AVG | | Peak | QP | AVG | QP | AVG | QP | AVG | | |
| 1 | 0.1620 | 40.81 | | 23.97 | 10.17 | 50.98 | | 34.14 | 65.36 | 55.36 | -14.38 | -21.22 | P | |
| 2 | 0.5780 | 27.70 | | 19.03 | 10.33 | 38.03 | | 29.36 | 56.00 | 46.00 | -17.97 | -16.64 | P | |
| 3 | 1.6420 | 21.21 | | 11.10 | 10.33 | 31.54 | | 21.43 | 56.00 | 46.00 | -24.46 | -24.57 | P | |
| 4 | 3.5860 | 31.00 | | 18.77 | 10.50 | 41.50 | | 29.27 | 56.00 | 46.00 | -14.50 | -16.73 | P | |
| 5 | 16.4260 | 21.78 | | 9.78 | 10.12 | 31.90 | | 19.90 | 60.00 | 50.00 | -28.10 | -30.10 | P | |
| 6 | 20.9619 | 30.17 | | 16.17 | 10.13 | 40.30 | | 26.30 | 60.00 | 50.00 | -19.70 | -23.70 | P | |

Line Conducted Emission Test Line 2-N

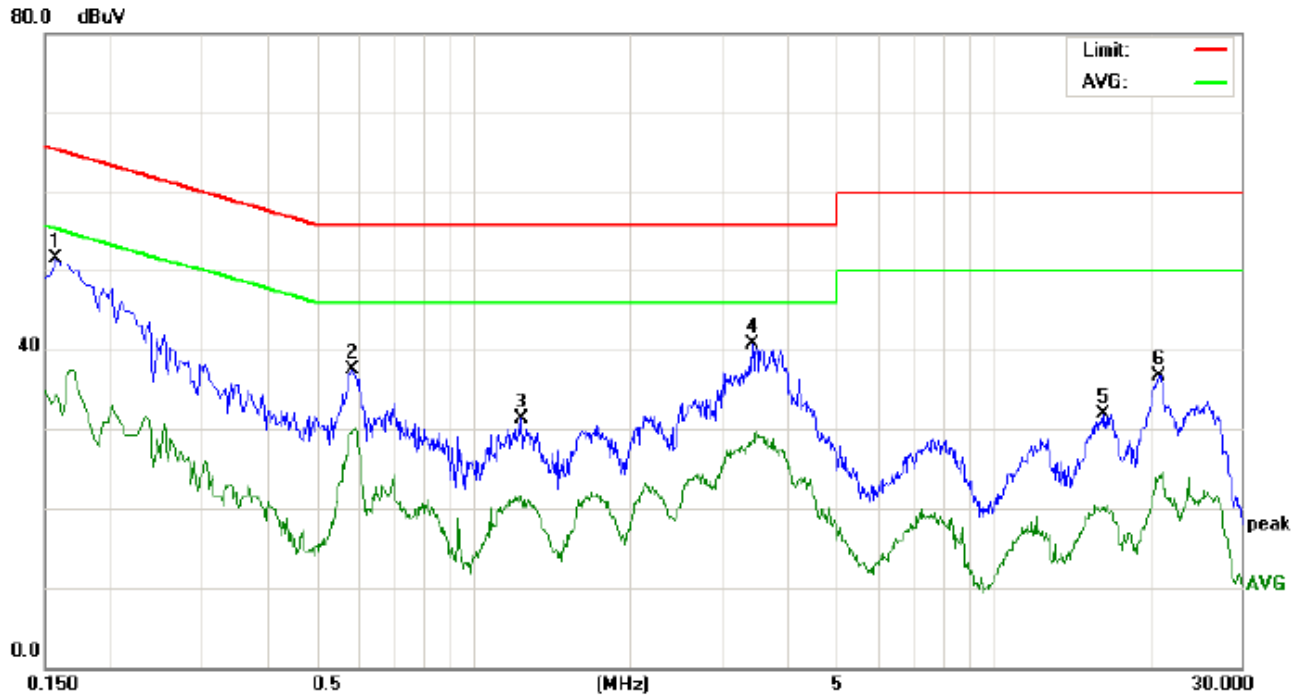

Site: Conduction Phase: **N** Temperature: 26
Limit: FCC Class B Conduction(QP) Power: Humidity: 60 %
EUT: Bluetooth Headset
M/N: SH26
Mode: Normal Operation
Note:

| No. | Freq. (MHz) | Reading_Level (dBuV) | | | Correct Factor | Measurement (dBuV) | | | Limit (dBuV) | | Margin (dB) | | P/F | Comment |
|-----|-------------|----------------------|----|-------|----------------|--------------------|------|-------|--------------|-------|-------------|--------|-----|---------|
| | | Peak | QP | AVG | | dB | Peak | QP | AVG | QP | AVG | QP | | |
| 1 | 0.1580 | 41.60 | | 24.15 | 10.17 | 51.77 | | 34.32 | 65.56 | 55.56 | -13.79 | -21.24 | P | |
| 2 | 0.5860 | 27.22 | | 19.15 | 10.32 | 37.54 | | 29.47 | 56.00 | 46.00 | -18.46 | -16.53 | P | |
| 3 | 1.2420 | 20.96 | | 11.23 | 10.37 | 31.33 | | 21.60 | 56.00 | 46.00 | -24.67 | -24.40 | P | |
| 4 | 3.4460 | 30.23 | | 17.99 | 10.51 | 40.74 | | 28.50 | 56.00 | 46.00 | -15.26 | -17.50 | P | |
| 5 | 16.3420 | 21.86 | | 10.05 | 10.12 | 31.98 | | 20.17 | 60.00 | 50.00 | -28.02 | -29.83 | P | |
| 6 | 20.9220 | 26.65 | | 13.71 | 10.13 | 36.78 | | 23.84 | 60.00 | 50.00 | -23.22 | -26.16 | P | |

APPENDIX A: PHOTOGRAPHS OF TEST SETUP
FCC LINE CONDUCTED EMISSION TEST SETUP



FCC RADIATED EMISSION TEST SETUP



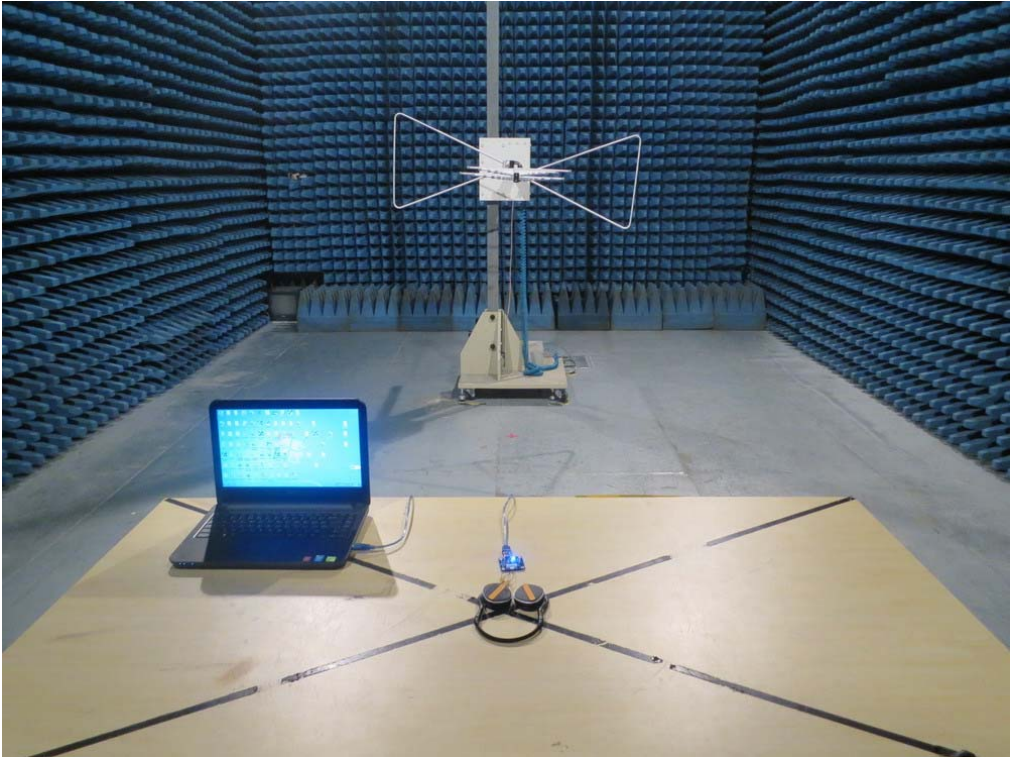

APPENDIX B: PHOTOGRAPHS OF EUT
TOP VIEW OF EUT



BOTTOM VIEW OF EUT



FRONT VIEW OF EUT



BACK VIEW OF EUT



LEFT VIEW OF EUT



RIGHT VIEW OF EUT



VIEW OF EUT (PORT)



OPEN VIEW OF EUT

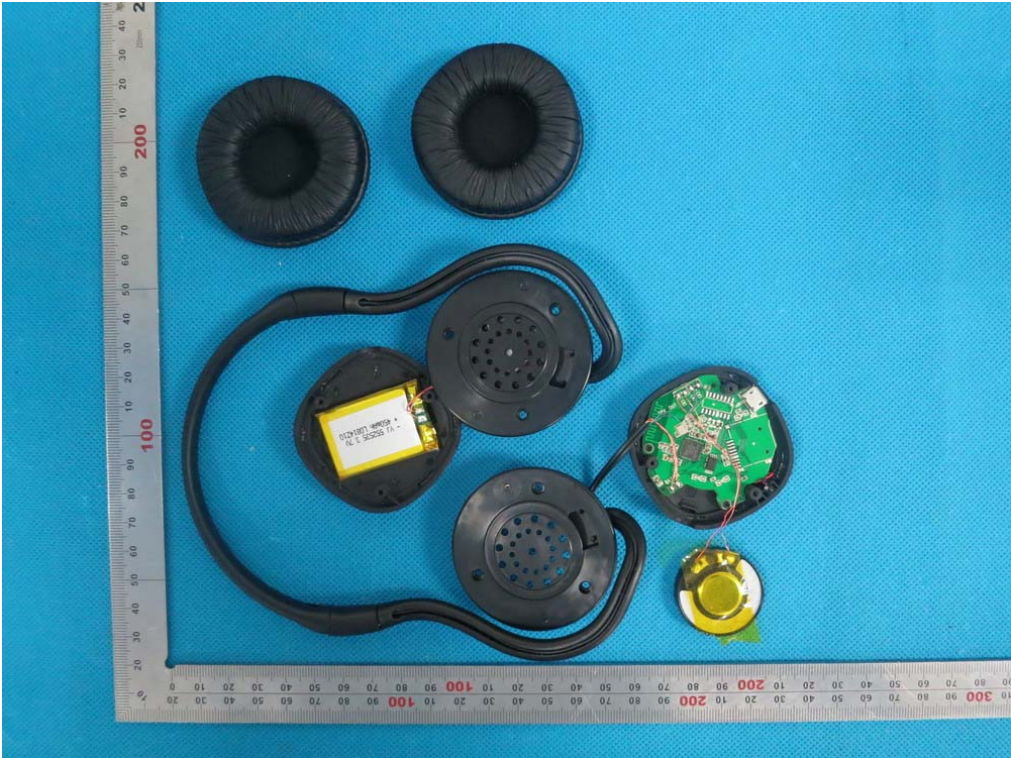

INTERNAL VIEW OF EUT-1

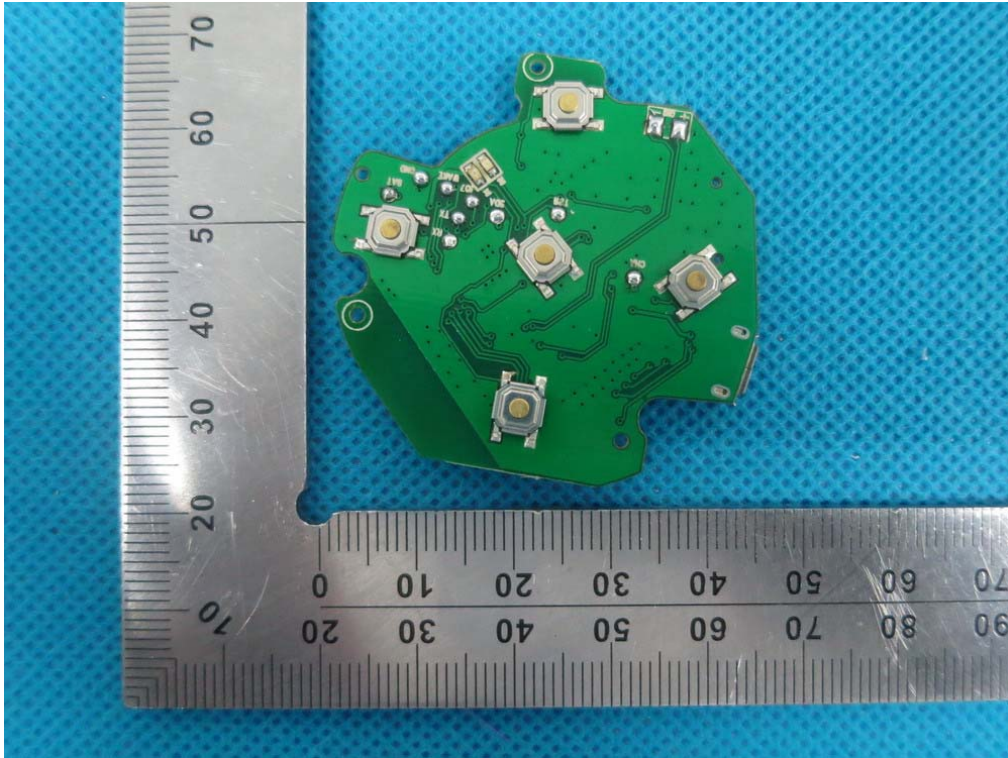

INTERNAL VIEW OF EUT-2

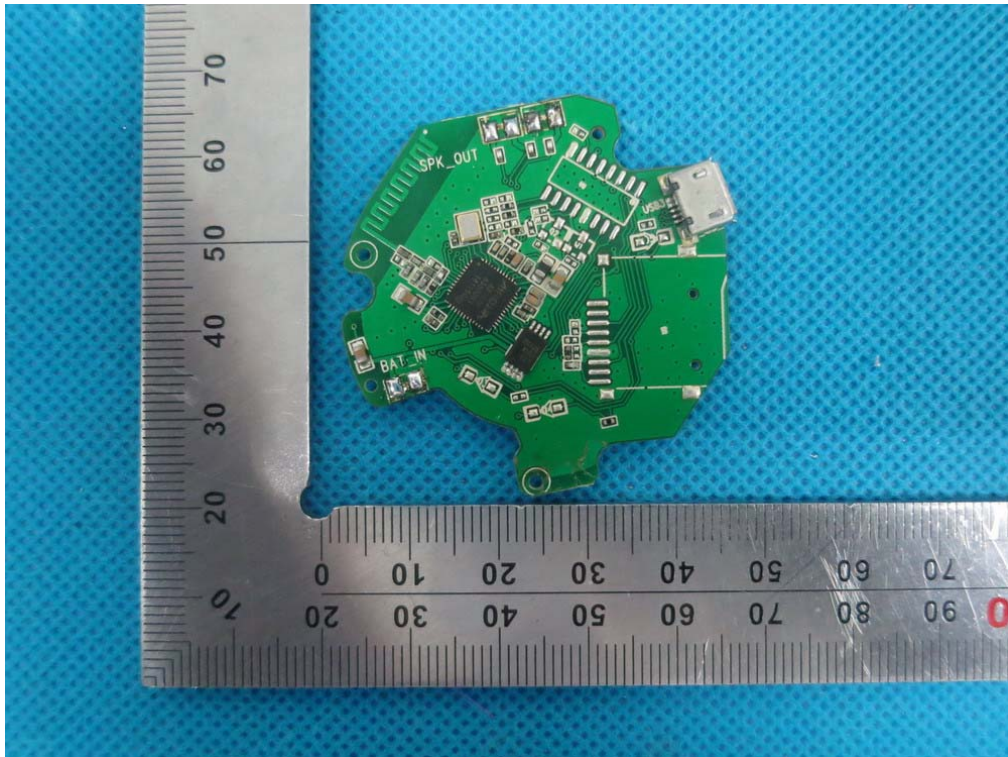

INTERNAL VIEW OF EUT-3

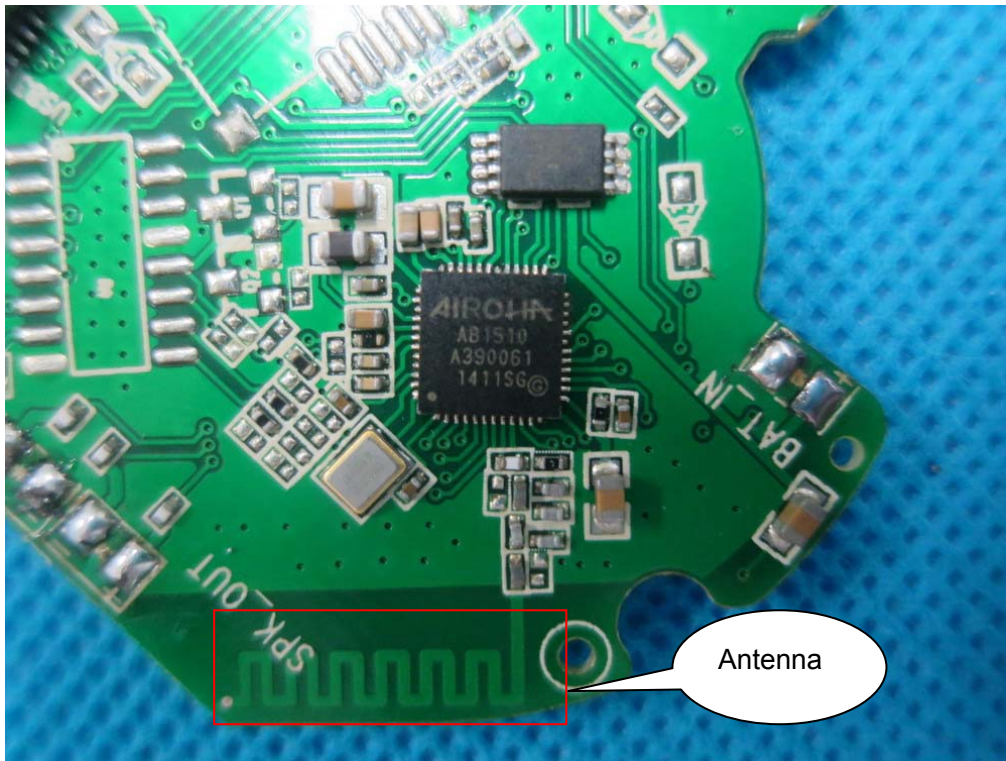

INTERNAL VIEW OF EUT-4

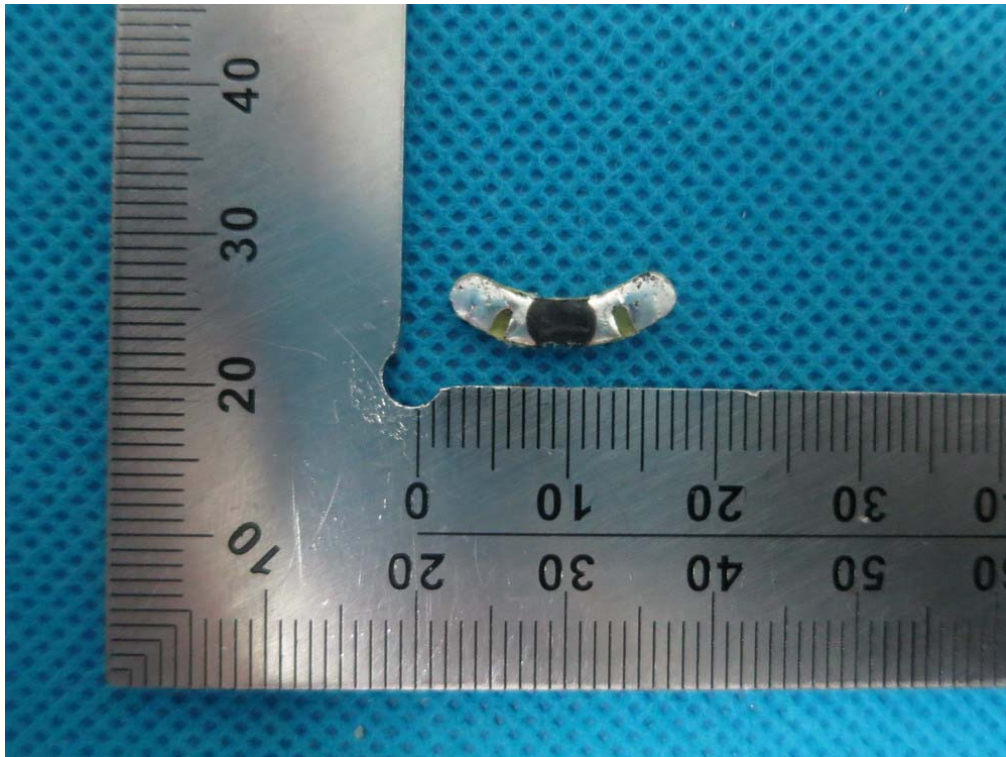

INTERNAL VIEW OF EUT-5



----END OF REPORT----