

TECHNICAL REPORT



Report No: FCC 1603086-05
File reference No: 2016-03-30

Applicant: JIANGSU SHUANGSHUANG TECHNOLOGY CO,LTD.

Product: smart phone

Model No: D351W

Trademark: N/A

Test Standards: FCC 47 CFR Part 2, 22(H), 24(E)

Test result: It is herewith confirmed and found to comply with the requirements set up by ANSI C63.4, FCC Part 22H and 24E for the evaluation of electromagnetic compatibility

Approved By

Jack Chung

Jack Chung

Manager

Dated: March 30, 2016

**Results appearing herein relate only to the sample tested
The technical reports is issued errors and omissions exempt and is subject to
withdrawal at**

SHENZHEN TIMEWAY TESTING LABORATORIES

Room 512-519, 5/F., East Tower, Building 4, Anhua Industrial Zone, Futian District,
Shenzhen, Guangdong, China

Tel (755) 83448688, Fax (755) 83442996, E-Mail:info@timeway-lab.com



Special Statement:

The testing quality ability of our laboratory meet with “Quality Law of People’s Republic of China” Clause 19.

The testing quality system of our laboratory meet with ISO/IEC-17025 requirements, which is approved by CNAL. This approval result is accepted by MRA of APLAC.

Our test facility is recognized, certified, or accredited by the following organizations:

CNAL-LAB Code: L2292

The EMC Laboratory has been assessed and in compliance with CNAL/AC01:2002 accreditation criteria for testing Laboratories (identical to ISO/IEC 17025:1999 General Requirements) for the Competence of testing Laboratories.

FCC-Registration No.: 899988

The EMC Laboratory has been registered and fully described in a report filed with the (FCC) Federal Communications commission. The acceptance letter from the FCC is maintained in our files. Registration No.: 899988.

IC- Registration No.: IC5205A-02

The EMC Laboratory has been registered and fully described in a report filed with the (IC) Industry Canada. The acceptance letter from the IC is maintained in our files. Registration IC No.: 5205A-02.

The report refers only to the sample tested and does not apply to the bulk.
This report is issued in confidence to the client and it will be strictly treated as such by the SHENZHEN TIMEWAY TESTING LABORATORIES. It may not be reproduced rather in its entirety or in part and it may not be used for adverting. The client to whom the report is issued may, however, show or send it . or a certified copy there of prepared by the SHENZHEN TIMEWAY TESTING LABORATORIES. to his customer. Supplier or others persons directly concerned. SHENZHEN TIMEWAY TESTING LABORATORIES. will not, without the consent of the client enter into any discussion of correspondence with any third party concerning the contents of the report.
In the event of the improper use of the report. The SHENZHEN TIMEWAY TESTING LABORATORIES. reserves the rights to withdraw it and to adopt any other remedies which may be appropriate.



Test Report Conclusion
Content

1.0	General Details	4
1.1	Test Lab Details.....	4
1.2	Applicant Details.....	4
1.3	Description of EUT	4
1.4	Submitted Sample.....	5
1.5	Test Duration.....	5
1.6	Test Uncertainty.....	5
1.7	Test By.....	5
2.0	Test Configuration of Equipment Under Test	7
2.1	Test Mode.....	7
2.2	Connection Diagram of Test System.....	9
3.0	Technical Details	10
3.1	Conducted Output Power Measurement.....	10
3.2	Effective Radiated Power and Effective Isotropic Radiated Power Measurement.....	12
3.3	Occupied Bandwidth Measurement.....	16
3.4	Band Edge Measurement.....	36
3.5	Conducted Emission Measurement.....	49
3.6	Field Strength of Spurious Radiation Measurement.....	62
3.7	Frequency Stability Measurement.....	68
3.8	Peak to Average Ratio.....	76
3.9	Mains Conducted Emissions.....	78
4.0	Test Equipment	81
5.0	Photographs	82

The report refers only to the sample tested and does not apply to the bulk.
 This report is issued in confidence to the client and it will be strictly treated as such by the SHENZHEN TIMEWAY TESTING LABORATORIES. It may not be reproduced rather in its entirety or in part and it may not be used for advertising. The client to whom the report is issued may, however, show or send it . or a certified copy there of prepared by the SHENZHEN TIMEWAY TESTING LABORATORIES. to his customer. Supplier or others persons directly concerned. SHENZHEN TIMEWAY TESTING LABORATORIES. will not, without the consent of the client enter into any discussion of correspondence with any third party concerning the contents of the report.
 In the event of the improper use of the report. The SHENZHEN TIMEWAY TESTING LABORATORIES. reserves the rights to withdraw it and to adopt any other remedies which may be appropriate.



1.0 General Details

1.1 Test Lab Details

Name : SHENZHEN TIMEWAY TESTING LABORATORIES.
 Address: Room 512-519,5/F., East Tower,Building 4, Anhua Industrial Zone, Futian District,Shenzhen, Guangdong China
 Telephone: (755) 83448688
 Fax: (755) 83442996
 Site on File with the Federal Communications Commission – United States
 Registration Number: 899988
 For 3m & 10 m OATS
 Site Listed with Industry Canada of Ottawa, Canada
 Registration Number: IC: 5205A-02
 For 3m & 10 m OATS

1.2 Applicant Details

Applicant: JIANGSU SHUANGSHUANG TECHNOLOGY CO,LTD.
 Address: No.188,West Coastal Road,Haian County,Jiangsu Province,P.R.China.
 Telephone: 0513-88355088
 Fax: 0513-88355618

1.3 Description of EUT

Product:	smart phone
Manufacturer:	JIANGSU SHUANGSHUANG TECHNOLOGY CO,LTD.
Address:	No.188,West Coastal Road,Haian County,Jiangsu Province,P.R.China.
Brand Name:	N/A
Model Number:	D351W
Additional Model Number:	N/A
Tx Frequency	GSM850 : 824.2 MHz ~ 848.8 MHz GSM1900 : 1850.2 MHz ~ 1909.8 MHz WCDMA Band V : 826.4 MHz ~ 846.6 MHz WCDMA Band II : 1852.4 MHz ~ 1907.6 MHz
Rx Frequency	GSM850 : 869.2 MHz ~ 893.8 MHz GSM1900 : 1930.2 MHz ~ 1989.8 MHz WCDMA Band V : 871.4 MHz ~ 891.6 MHz WCDMA Band II : 1932.4 MHz ~ 1987.6 MHz
Maximum Output Power to Antenna	GSM850 : 32.73dBm GSM1900 : 29.30 dBm WCDMA Band V : 22.03 dBm WCDMA Band II : 21.63 dBm
Antenna Type	Integral Antenna

The report refers only to the sample tested and does not apply to the bulk.

This report is issued in confidence to the client and it will be strictly treated as such by the SHENZHEN TIMEWAY TESTING LABORATORIES. It may not be reproduced rather in its entirety or in part and it may not be used for advertising. The client to whom the report is issued may, however, show or send it, or a certified copy thereof prepared by the SHENZHEN TIMEWAY TESTING LABORATORIES, to his customer. Supplier or other persons directly concerned. SHENZHEN TIMEWAY TESTING LABORATORIES, will not, without the consent of the client enter into any discussion of correspondence with any third party concerning the contents of the report.

In the event of the improper use of the report. The SHENZHEN TIMEWAY TESTING LABORATORIES, reserves the rights to withdraw it and to adopt any other remedies which may be appropriate.



Antenna Peak Gain	824 ~ 849 MHz : 1.6 dBi 1850~1910 MHz : 3.8dBi
Type of Modulation	GSM / GPRS : GMSK EDGE : GMSK/8PSK WCDMA : QPSK HSDPA : QPSK / 16QAM HSUPA : QPSK
EMISSION DESIGNATOR	GSM : 249KGXW EGPRS : 290KG7W WCDMA: 4M22F9W
Dual Card	SIM Card 1: WCDMA/GSM Card Slot SMI Card 2: GSM Card Slot Note: Card 1 can't transmit with Card 2 simultaneously.
FCC ID:	2ABDT-D351W

1.4 Submitted Sample: 2 Samples

1.5 Test Duration
2016-03-17 to 2016-03-28

1.6 Test Uncertainty
Conducted Emissions Uncertainty =3.6dB
Radiated Emissions Uncertainty =4.7dB

1.7 Test Engineer
The sample tested by Terry Tang

Print Name: Terry Tang

The report refers only to the sample tested and does not apply to the bulk.
This report is issued in confidence to the client and it will be strictly treated as such by the SHENZHEN TIMEWAY TESTING LABORATORIES. It may not be reproduced rather in its entirety or in part and it may not be used for advertising. The client to whom the report is issued may, however, show or send it . or a certified copy there of prepared by the SHENZHEN TIMEWAY TESTING LABORATORIES. to his customer. Supplier or others persons directly concerned. SHENZHEN TIMEWAY TESTING LABORATORIES. will not, without the consent of the client enter into any discussion of correspondence with any third party concerning the contents of the report.
In the event of the improper use of the report. The SHENZHEN TIMEWAY TESTING LABORATORIES. reserves the rights to withdraw it and to adopt any other remedies which may be appropriate.



SUMMARY OF TEST RESULT

Report Section	FCC Rule	Description	Limit	Result	Remark
3.1	§2.1046	Conducted Output Power	N/A	PASS	-
3.2	§22.913(a)(2)	Effective Radiated Power	< 7 Watts	PASS	-
3.2	§24.232(c)	Equivalent Isotropic Radiated Power	< 2 Watts	PASS	-
3.3	§2.1049 §22.917(a) §24.238(a)	Occupied Bandwidth	N/A	PASS	-
3.4	§2.1051 §22.917(a) §24.238(a)	Band Edge Measurement	< 43+10log10(P[Watts])	PASS	-
3.5	§2.1051 §22.917(a) §24.238(a)	Conducted Emission	< 43+10log10(P[Watts])	PASS	-
3.6	§2.1053 §22.917(a) §24.238(a)	Field Strength of Spurious Radiation	< 43+10log10(P[Watts])	PASS	-
3.7	§2.1055 §22.355 §24.235	Frequency Stability for Temperature & Voltage	< 2.5 ppm	PASS	-
3.8	§24.232(d)	Peak-to-Average Ratio	< 13 dB	PASS	-
3.9	Part 15B	Main Conducted Emissions	See part 15.107 and 207	PASS	-

The report refers only to the sample tested and does not apply to the bulk.

This report is issued in confidence to the client and it will be strictly treated as such by the SHENZHEN TIMEWAY TESTING LABORATORIES. It may not be reproduced rather in its entirety or in part and it may not be used for advertising. The client to whom the report is issued may, however, show or send it, or a certified copy thereof prepared by the SHENZHEN TIMEWAY TESTING LABORATORIES, to his customer. Supplier or other persons directly concerned. SHENZHEN TIMEWAY TESTING LABORATORIES, will not, without the consent of the client enter into any discussion of correspondence with any third party concerning the contents of the report.

In the event of the improper use of the report, the SHENZHEN TIMEWAY TESTING LABORATORIES, reserves the rights to withdraw it and to adopt any other remedies which may be appropriate.



2 Test Configuration of Equipment Under Test

2.1 Test Mode

During all testing, EUT is in link mode with base station emulator at maximum power level. The spurious emission measurements were carried out in semi-anechoic chamber with 3-meter test range. Frequency range investigated for radiated emission is as follows:

1. 30 MHz to 9000 MHz for GSM850 and WCDMA Band V.
2. 30 MHz to 19000 MHz for GSM1900 and WCDMA Band II.

Test Modes		
Band	Radiated TCs	Conducted TCs
GSM 850	<ul style="list-style-type: none"> ■ GSM Link ■ EDGE 8 Link 	<ul style="list-style-type: none"> ■ GSM Link ■ EDGE 8 Link
GSM 1900	<ul style="list-style-type: none"> ■ GSM Link ■ EDGE 8 Link 	<ul style="list-style-type: none"> ■ GSM Link ■ EDGE 8 Link
WCDMA Band V	<ul style="list-style-type: none"> ■ RMC 12.2Kbps Link 	<ul style="list-style-type: none"> ■ RMC 12.2Kbps Link
WCDMA Band II	<ul style="list-style-type: none"> ■ RMC 12.2Kbps Link 	<ul style="list-style-type: none"> ■ RMC 12.2Kbps Link

Note: The maximum power levels are GSM mode for GSMK link, EDGE multi-slot class 8 mode for 8PSK link, RMC 12.2Kbps mode for WCDMA band V, and RMC 12.2Kbps mode for WCDMA band II, only these modes were used for all tests.

The report refers only to the sample tested and does not apply to the bulk.

This report is issued in confidence to the client and it will be strictly treated as such by the SHENZHEN TIMEWAY TESTING LABORATORIES. It may not be reproduced rather in its entirety or in part and it may not be used for advertising. The client to whom the report is issued may, however, show or send it or a certified copy thereof prepared by the SHENZHEN TIMEWAY TESTING LABORATORIES to his customer. Supplier or other persons directly concerned. SHENZHEN TIMEWAY TESTING LABORATORIES will not, without the consent of the client enter into any discussion of correspondence with any third party concerning the contents of the report. In the event of the improper use of the report. The SHENZHEN TIMEWAY TESTING LABORATORIES reserves the rights to withdraw it and to adopt any other remedies which may be appropriate.



The conducted power tables are as follows: For SIM Card 1

Conducted Power (*Unit: dBm)						
Band	GSM850			GSM1900		
Channel	128	190	251	512	661	810
Frequency	824.2	836.6	848.8	1850.2	1880.0	1909.8
GSM	31.98	31.92	31.89	28.86	28.75	28.33
GPRS 8	32.73	32.66	32.63	29.30	29.08	28.76
GPRS 10	31.77	31.70	31.65	28.52	28.50	28.39
GPRS 12	28.93	28.89	28.77	25.44	25.32	25.27
EGPRS 8	27.38	27.32	27.31	24.20	24.19	24.08
EGPRS 10	26.69	26.55	26.52	23.52	23.39	23.28
EGPRS 12	23.56	23.46	23.52	21.89	21.76	21.72

Conducted Power (*Unit: dBm)						
Band	WCDMA Band V			WCDMA Band II		
Channel	4132	4183	4233	9262	9400	9538
Frequency	826.4	836.6	846.6	1852.4	1880.0	1907.6
RMC 12.2K	21.97	22.03	21.96	21.50	21.63	21.39
HSDPA Subtest-1	21.27	21.35	21.30	21.02	21.11	20.96
HSDPA Subtest-2	21.16	21.19	21.15	20.71	20.78	20.67
HSDPA Subtest-3	21.23	21.32	21.28	20.62	20.70	20.56
HSDPA Subtest-4	21.30	21.33	21.29	20.24	21.33	20.18
HSUPA Subtest-1	20.89	20.92	20.84	20.75	20.83	20.72
HSUPA Subtest-2	20.16	20.22	20.11	20.25	20.32	20.19
HSUPA Subtest-3	20.27	20.36	20.25	20.36	20.46	20.29
HSUPA Subtest-4	20.44	20.52	20.46	20.20	20.31	20.23
HSUPA Subtest-5	20.73	20.79	20.71	20.34	20.43	20.38

The report refers only to the sample tested and does not apply to the bulk.

This report is issued in confidence to the client and it will be strictly treated as such by the SHENZHEN TIMEWAY TESTING LABORATORIES. It may not be reproduced rather in its entirety or in part and it may not be used for advertising. The client to whom the report is issued may, however, show or send it or a certified copy thereof prepared by the SHENZHEN TIMEWAY TESTING LABORATORIES to his customer, Supplier or other persons directly concerned. SHENZHEN TIMEWAY TESTING LABORATORIES will not, without the consent of the client enter into any discussion of correspondence with any third party concerning the contents of the report.

In the event of the improper use of the report, the SHENZHEN TIMEWAY TESTING LABORATORIES reserves the rights to withdraw it and to adopt any other remedies which may be appropriate.



The conducted power tables are as follows: For SIM Card 2 (Only support GSM)

Conducted Power (*Unit: dBm)						
Band	GSM850			GSM1900		
Channel	128	190	251	512	661	810
Frequency	824.2	836.6	848.8	1850.2	1880.0	1909.8
GSM	31.86	31.73	31.75	28.82	28.70	28.35
GPRS 8	32.68	32.53	32.60	29.16	29.01	28.80
GPRS 10	31.70	31.59	31.62	28.48	28.43	28.36
GPRS 12	28.85	28.80	28.68	25.50	25.37	25.33
EGPRS 8	27.35	27.29	27.28	24.32	24.28	24.21
EGPRS 10	26.59	26.46	26.51	23.50	23.41	23.36
EGPRS 12	23.60	23.43	23.55	21.85	21.72	21.68

The report refers only to the sample tested and does not apply to the bulk.

This report is issued in confidence to the client and it will be strictly treated as such by the SHENZHEN TIMEWAY TESTING LABORATORIES. It may not be reproduced rather in its entirety or in part and it may not be used for advertising. The client to whom the report is issued may, however, show or send it or a certified copy thereof prepared by the SHENZHEN TIMEWAY TESTING LABORATORIES to his customer, Supplier or other persons directly concerned. SHENZHEN TIMEWAY TESTING LABORATORIES will not, without the consent of the client enter into any discussion of correspondence with any third party concerning the contents of the report. In the event of the improper use of the report, the SHENZHEN TIMEWAY TESTING LABORATORIES reserves the rights to withdraw it and to adopt any other remedies which may be appropriate.



2.2 Connection Diagram of Test System

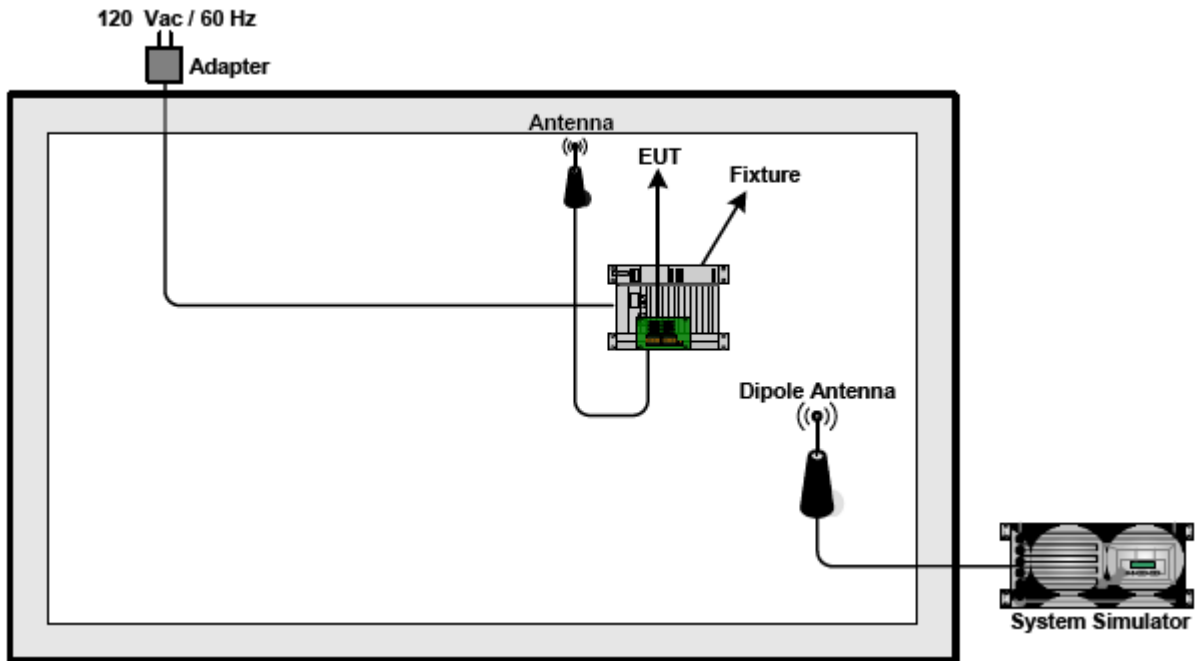

The report refers only to the sample tested and does not apply to the bulk.

This report is issued in confidence to the client and it will be strictly treated as such by the SHENZHEN TIMEWAY TESTING LABORATORIES. It may not be reproduced rather in its entirety or in part and it may not be used for advertising. The client to whom the report is issued may, however, show or send it, or a certified copy thereof prepared by the SHENZHEN TIMEWAY TESTING LABORATORIES, to his customer, Supplier or other persons directly concerned. SHENZHEN TIMEWAY TESTING LABORATORIES will not, without the consent of the client enter into any discussion of correspondence with any third party concerning the contents of the report.

In the event of the improper use of the report, the SHENZHEN TIMEWAY TESTING LABORATORIES reserves the rights to withdraw it and to adopt any other remedies which may be appropriate.



3 Test Result

3.1 Conducted Output Power Measurement

3.1.1 Description of the Conducted Output Power Measurement

A base station simulator was used to establish communication with the EUT. Its parameters were set to transmit the maximum power on the EUT. The measured power in the radio frequency on the transmitter output terminals shall be reported.

3.1.2 Measuring Instruments

See list of measuring instruments of this test report.

3.1.3 Test Procedures

1. The transmitter output port was connected to base station.
2. Set EUT at maximum power through base station.
3. Select lowest, middle, and highest channels for each band and different modulation.

3.1.4 Test Setup

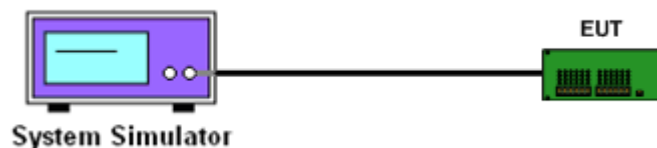

The report refers only to the sample tested and does not apply to the bulk.
This report is issued in confidence to the client and it will be strictly treated as such by the SHENZHEN TIMEWAY TESTING LABORATORIES. It may not be reproduced rather in its entirety or in part and it may not be used for advertising. The client to whom the report is issued may, however, show or send it, or a certified copy thereof prepared by the SHENZHEN TIMEWAY TESTING LABORATORIES, to his customer. Supplier or other persons directly concerned. SHENZHEN TIMEWAY TESTING LABORATORIES, will not, without the consent of the client enter into any discussion of correspondence with any third party concerning the contents of the report.
In the event of the improper use of the report. The SHENZHEN TIMEWAY TESTING LABORATORIES, reserves the rights to withdraw it and to adopt any other remedies which may be appropriate.



3.1.5 Test Result of Conducted Output Power

Cellular Band				
Modes	Channel	Frequency (MHz)	Conducted Power (dBm)	Conducted Power (Watts)
GSM850 (GSM)	128 (Low)	824.2	32.73	1.875
	190 (Mid)	836.6	32.66	1.845
	251 (High)	848.8	32.63	1.832
GSM850 (EDGE 8)	128 (Low)	824.2	27.38	0.5470
	190 (Mid)	836.4	27.32	0.5395
	251 (High)	848.8	27.31	0.5383
WCDMA Band V (RMC 12.2Kbps)	4132 (Low)	826.4	21.97	0.1574
	4183 (Mid)	836.6	22.03	0.1596
	4233 (High)	846.6	21.96	0.1570

PCS Band				
Modes	Channel	Frequency (MHz)	Conducted Power (dBm)	Conducted Power (Watts)
GSM1900 (GSM)	512 (Low)	1850.2	29.30	0.8511
	661 (Mid)	1880.0	29.08	0.8091
	810 (High)	1909.8	28.76	0.7516
GSM1900 (EDGE 8)	512 (Low)	1850.2	24.20	0.2630
	661 (Mid)	1880.0	24.19	0.2624
	810 (High)	1909.8	24.08	0.2559
WCDMA Band II (RMC 12.2Kbps)	9262 (Low)	1852.4	21.50	0.1413
	9400 (Mid)	1880.0	21.63	0.1455
	9538 (High)	1907.6	21.39	0.1377

The report refers only to the sample tested and does not apply to the bulk.

This report is issued in confidence to the client and it will be strictly treated as such by the SHENZHEN TIMEWAY TESTING LABORATORIES. It may not be reproduced rather in its entirety or in part and it may not be used for advertising. The client to whom the report is issued may, however, show or send it, or a certified copy thereof prepared by the SHENZHEN TIMEWAY TESTING LABORATORIES, to his customer. Supplier or other persons directly concerned. SHENZHEN TIMEWAY TESTING LABORATORIES, will not, without the consent of the client enter into any discussion of correspondence with any third party concerning the contents of the report.

In the event of the improper use of the report. The SHENZHEN TIMEWAY TESTING LABORATORIES, reserves the rights to withdraw it and to adopt any other remedies which may be appropriate.



3.2 Effective Radiated Power and Effective Isotropic Radiated Power Measurement

3.2.1 Description of the ERP/EIRP Measurement

The substitution method, in ANSI / TIA / EIA-603-C-2004, was used for ERP/EIRP measurement, and the spectrum analyzer configuration follows KDB 971168 D01 Power Meas. License Digital Systems v02r01. The ERP of mobile transmitters must not exceed 7 Watts and the EIRP of mobile transmitters are limited to 2 Watts.

3.2.2 Measuring Instruments

See list of measuring instruments of this test report.

3.2.3 Test Procedures

1. The EUT was placed on a turntable with 1.5 meter height in a fully anechoic chamber.
2. The EUT was set at 3 meters from the receiving antenna, which was mounted on the antenna tower.
3. GSM operating modes: Set RBW= 1MHz, VBW= 3MHz, RMS detector over burst;
UMTS operating modes: Set RBW= 100 kHz, VBW= 300 kHz, RMS detector over frame, and use channel power option with bandwidth=5MHz, per KDB 971168 D01.
4. The table was rotated 360 degrees to determine the position of the highest radiated power.
5. The height of the receiving antenna is adjusted to look for the maximum ERP/EIRP.
6. Taking the record of maximum ERP/EIRP.
7. A dipole antenna was substituted in place of the EUT and was driven by a signal generator.
8. The conducted power at the terminal of the dipole antenna is measured.
9. Repeat step 3 to step 5 to get the maximum ERP/EIRP of the substitution antenna.
10. $ERP/EIRP = P_s + E_t - E_s + G_s = P_s + R_t - R_s + G_s$

P_s (dBm) : Input power to substitution antenna.

G_s (dBi or dBd) : Substitution antenna Gain.

$E_t = R_t + AF$

$E_s = R_s + AF$

AF (dB/m) : Receive antenna factor

R_t : The highest received signal in spectrum analyzer for EUT.

R_s : The highest received signal in spectrum analyzer for substitution antenna.

The report refers only to the sample tested and does not apply to the bulk.

This report is issued in confidence to the client and it will be strictly treated as such by the SHENZHEN TIMEWAY TESTING LABORATORIES. It may not be reproduced rather in its entirety or in part and it may not be used for advertising. The client to whom the report is issued may, however, show or send it . or a certified copy there of prepared by the SHENZHEN TIMEWAY TESTING LABORATORIES. to his customer. Supplier or others persons directly concerned. SHENZHEN TIMEWAY TESTING LABORATORIES. will not, without the consent of the client enter into any discussion of correspondence with any third party concerning the contents of the report.

In the event of the improper use of the report. The SHENZHEN TIMEWAY TESTING LABORATORIES. reserves the rights to withdraw it and to adopt any other remedies which may be appropriate.



3.2.4 Test Setup

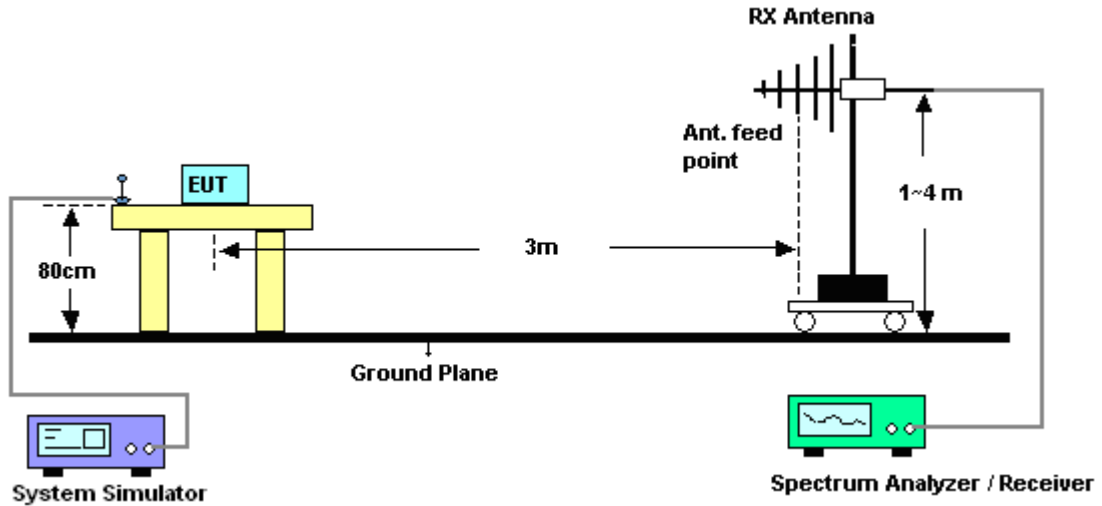

The report refers only to the sample tested and does not apply to the bulk.
This report is issued in confidence to the client and it will be strictly treated as such by the SHENZHEN TIMEWAY TESTING LABORATORIES. It may not be reproduced rather in its entirety or in part and it may not be used for advertising. The client to whom the report is issued may, however, show or send it, or a certified copy thereof prepared by the SHENZHEN TIMEWAY TESTING LABORATORIES, to his customer, Supplier or others persons directly concerned. SHENZHEN TIMEWAY TESTING LABORATORIES, will not, without the consent of the client enter into any discussion of correspondence with any third party concerning the contents of the report.
In the event of the improper use of the report. The SHENZHEN TIMEWAY TESTING LABORATORIES, reserves the rights to withdraw it and to adopt any other remedies which may be appropriate.



3.3.5 Test Result of ERP

GSM850 (GSM) Radiated Power ERP					
Frequency (MHz)	ERP (dBm)		ERP (W)		Result
	Polarization		Polarization		
	H	V	H	V	
824.20	28.68	27.96	0.7379	0.6252	Pass
836.60	28.59	27.86	0.7228	0.6109	Pass
848.80	28.52	27.82	0.7112	0.6053	Pass

GSM850 (EDGE8) Radiated Power ERP					
Frequency (MHz)	ERP (dBm)		ERP (W)		Result
	Polarization		Polarization		
	H	V	H	V	
824.20	23.51	22.92	0.2244	0.1959	Pass
836.60	23.45	22.83	0.2213	0.1919	Pass
848.80	23.43	22.76	0.2203	0.1888	Pass

WCDMA Band V (RMC 12.2Kbps) Radiated Power ERP					
Frequency (MHz)	ERP (dBm)		ERP (W)		Result
	Polarization		Polarization		
	H	V	H	V	
826.40	18.12	17.56	0.06486	0.05702	Pass
836.60	18.19	17.61	0.06592	0.05768	Pass
846.60	18.13	17.59	0.06501	0.05741	Pass

The report refers only to the sample tested and does not apply to the bulk.

This report is issued in confidence to the client and it will be strictly treated as such by the SHENZHEN TIMEWAY TESTING LABORATORIES. It may not be reproduced rather in its entirety or in part and it may not be used for advertising. The client to whom the report is issued may, however, show or send it, or a certified copy thereof prepared by the SHENZHEN TIMEWAY TESTING LABORATORIES, to his customer, Supplier or other persons directly concerned. SHENZHEN TIMEWAY TESTING LABORATORIES, will not, without the consent of the client enter into any discussion of correspondence with any third party concerning the contents of the report.

In the event of the improper use of the report, The SHENZHEN TIMEWAY TESTING LABORATORIES, reserves the rights to withdraw it and to adopt any other remedies which may be appropriate.



3.3.6 Test Result of EIRP

GSM1900 (GSM) Radiated Power EIRP					
Frequency (MHz)	EIRP (dBm)		EIRP (W)		Result
	Polarization		Polarization		
	H	V	H	V	
1850.20	27.46	26.82	0.5572	0.4808	Pass
1880.00	27.39	26.75	0.5483	0.4732	Pass
1909.80	27.28	26.52	0.5346	0.4487	Pass

GSM1900 (EDGE class 8) Radiated Power EIRP					
Frequency (MHz)	EIRP (dBm)		EIRP (W)		Result
	Polarization		Polarization		
	H	V	H	V	
1850.20	22.38	21.66	0.1730	0.1466	Pass
1880.00	22.33	21.58	0.1710	0.1439	Pass
1909.80	22.26	21.49	0.1683	0.1409	Pass

WCDMA Band II (RMC 12.2Kbps) Radiated Power EIRP					
Frequency (MHz)	EIRP (dBm)		EIRP (W)		Result
	Polarization		Polarization		
	H	V	H	V	
1852.40	19.36	18.70	0.08630	0.07413	Pass
1880.00	19.42	18.83	0.08750	0.07638	Pass
1907.60	19.22	18.61	0.08356	0.07261	Pass

The report refers only to the sample tested and does not apply to the bulk.

This report is issued in confidence to the client and it will be strictly treated as such by the SHENZHEN TIMEWAY TESTING LABORATORIES. It may not be reproduced rather in its entirety or in part and it may not be used for advertising. The client to whom the report is issued may, however, show or send it, or a certified copy thereof prepared by the SHENZHEN TIMEWAY TESTING LABORATORIES, to his customer, Supplier or other persons directly concerned. SHENZHEN TIMEWAY TESTING LABORATORIES, will not, without the consent of the client enter into any discussion of correspondence with any third party concerning the contents of the report.

In the event of the improper use of the report, The SHENZHEN TIMEWAY TESTING LABORATORIES, reserves the rights to withdraw it and to adopt any other remedies which may be appropriate.



3.3 Occupied Bandwidth Measurement

3.3.1 Description of Occupied Bandwidth Measurement

The 99% occupied bandwidth is the width of a frequency band such that, below the lower and above the upper frequency limits, the mean powers emitted are each equal to a specified percentage 0.5% of the total mean transmitted power.

The emission bandwidth is defined as the width of the signal between two points, located at the 2 sides of the carrier frequency, outside of which all emissions are attenuated at least 26 dB below the transmitter power.

3.3.2 Measuring Instruments

See list of measuring instruments of this test report.

3.3.3 Test Procedures

1. The EUT was connected to Spectrum Analyzer and Base Station via power divider.
2. The RF output of EUT was connected to the spectrum analyzer by RF cable and attenuator. The path loss was compensated to the results for each measurement.
3. The 99% occupied bandwidth were measured, set RBW= 1% of span, VBW= 10*RBW, Peak detector, trace maximum hold.
4. The 26dB bandwidth were measured, set RBW= 1% of EBW, VBW= 3*RBW, peak detector, trace maximum hold.

3.3.4 Test Setup

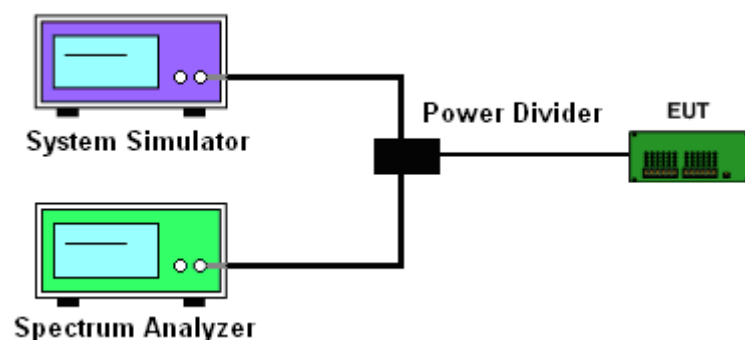

The report refers only to the sample tested and does not apply to the bulk.
This report is issued in confidence to the client and it will be strictly treated as such by the SHENZHEN TIMEWAY TESTING LABORATORIES. It may not be reproduced rather in its entirety or in part and it may not be used for advertising. The client to whom the report is issued may, however, show or send it . or a certified copy there of prepared by the SHENZHEN TIMEWAY TESTING LABORATORIES. to his customer. Supplier or others persons directly concerned. SHENZHEN TIMEWAY TESTING LABORATORIES. will not, without the consent of the client enter into any discussion of correspondence with any third party concerning the contents of the report.
In the event of the improper use of the report. The SHENZHEN TIMEWAY TESTING LABORATORIES. reserves the rights to withdraw it and to adopt any other remedies which may be appropriate.



3.4.5 Test Result of Occupied Bandwidth and 26dB Bandwidth

Cellular Band						
Modes	GSM850 (GSM)			GSM850 (EDGE class 8)		
Channel	128 (Low)	190 (Mid)	251 (High)	128 (Low)	190 (Mid)	251 (High)
Frequency (MHz)	824.2	836.6	848.8	824.2	836.6	848.8
99% OBW (kHz)	239.10	245.89	248.99	247.69	244.95	233.20
26dB BW (kHz)	318.83	318.67	321.95	320.56	323.28	306.16

PCS Band						
Modes	GSM1900 (GSM)			GSM1900 (EDGE class 8)		
Channel	512 (Low)	661 (Mid)	810 (High)	512 (Low)	661 (Mid)	810 (High)
Frequency (MHz)	1850.2	1880	1909.8	1850.2	1880	1909.8
99% OBW (kHz)	240.49	247.81	238.30	257.96	274.19	289.76
26dB BW (kHz)	309.56	320.50	311.97	335.86	373.66	386.03

Cellular Band			
Modes	WCDMA Band V (RMC 12.2Kbps)		
Channel	4132 (Low)	4182 (Mid)	4233 (High)
Frequency (MHz)	826.4	836.4	846.6
99% OBW (MHz)	4.16	4.18	4.14
26dB BW (MHz)	4.72	4.70	4.70

PCS Band			
Modes	WCDMA Band II (RMC 12.2Kbps)		
Channel	9262 (Low)	9400 (Mid)	9538 (High)
Frequency (MHz)	1852.4	1880	1907.6
99% OBW (MHz)	4.16	4.19	4.22

The report refers only to the sample tested and does not apply to the bulk.

This report is issued in confidence to the client and it will be strictly treated as such by the SHENZHEN TIMEWAY TESTING LABORATORIES. It may not be reproduced rather in its entirety or in part and it may not be used for advertising. The client to whom the report is issued may, however, show or send it, or a certified copy thereof prepared by the SHENZHEN TIMEWAY TESTING LABORATORIES, to his customer. Supplier or other persons directly concerned. SHENZHEN TIMEWAY TESTING LABORATORIES, will not, without the consent of the client enter into any discussion of correspondence with any third party concerning the contents of the report.

In the event of the improper use of the report. The SHENZHEN TIMEWAY TESTING LABORATORIES, reserves the rights to withdraw it and to adopt any other remedies which may be appropriate.



26dB BW (MHz)	4.71	4.77	4.84
----------------------	------	------	------

3.4.6 Test Result (Plots) of Occupied Bandwidth and 26dB Bandwidth

GSM 850MHz Channel = 128

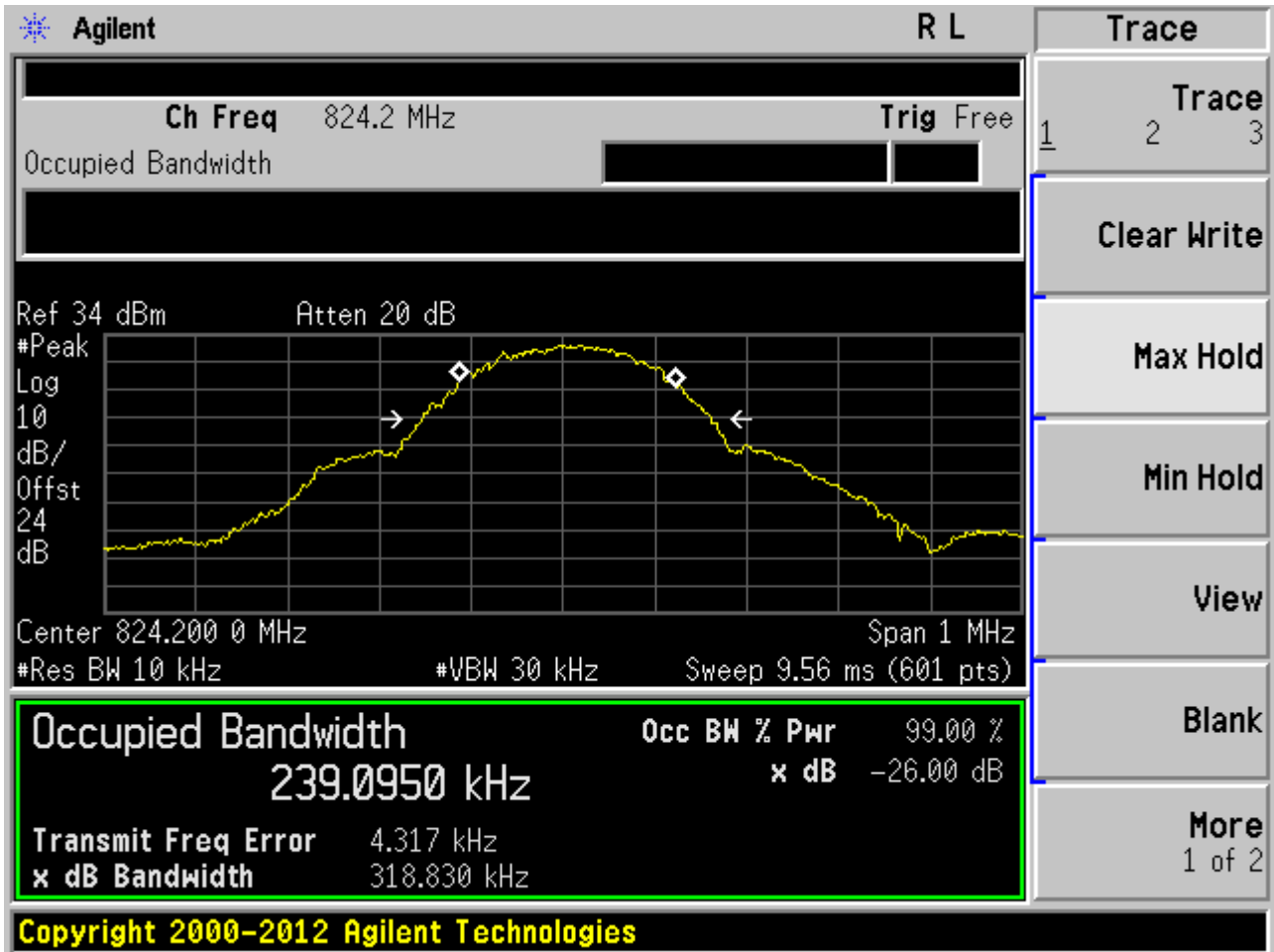

The report refers only to the sample tested and does not apply to the bulk. This report is issued in confidence to the client and it will be strictly treated as such by the SHENZHEN TIMEWAY TESTING LABORATORIES. It may not be reproduced rather in its entirety or in part and it may not be used for advertising. The client to whom the report is issued may, however, show or send it, or a certified copy thereof prepared by the SHENZHEN TIMEWAY TESTING LABORATORIES, to his customer. Supplier or others persons directly concerned. SHENZHEN TIMEWAY TESTING LABORATORIES, will not, without the consent of the client enter into any discussion of correspondence with any third party concerning the contents of the report. In the event of the improper use of the report. The SHENZHEN TIMEWAY TESTING LABORATORIES, reserves the rights to withdraw it and to adopt any other remedies which may be appropriate.



GSM 850MHz Channel = 190

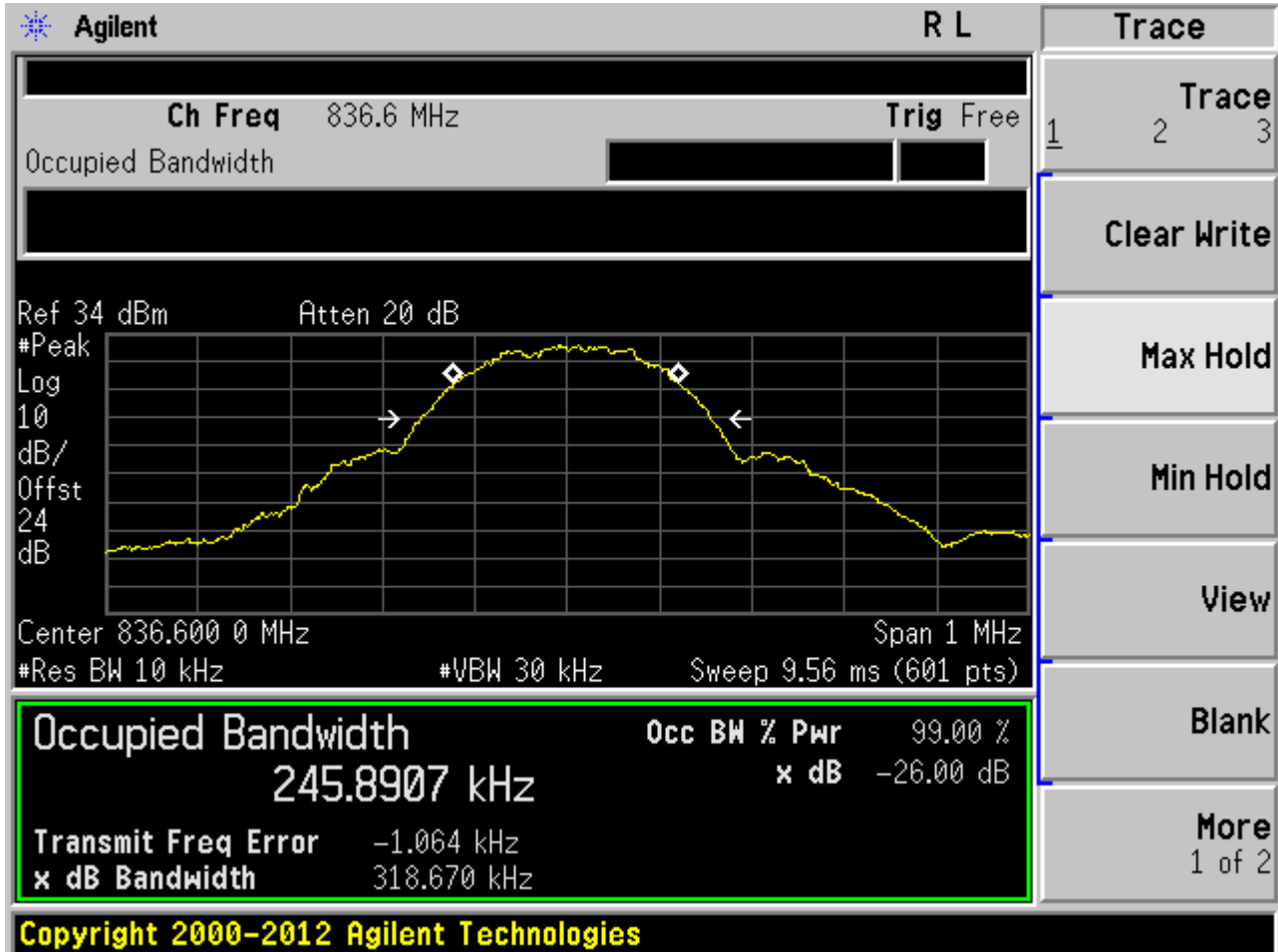

The report refers only to the sample tested and does not apply to the bulk. This report is issued in confidence to the client and it will be strictly treated as such by the SHENZHEN TIMEWAY TESTING LABORATORIES. It may not be reproduced rather in its entirety or in part and it may not be used for advertising. The client to whom the report is issued may, however, show or send it, or a certified copy thereof prepared by the SHENZHEN TIMEWAY TESTING LABORATORIES, to his customer. Supplier or others persons directly concerned. SHENZHEN TIMEWAY TESTING LABORATORIES, will not, without the consent of the client enter into any discussion of correspondence with any third party concerning the contents of the report. In the event of the improper use of the report. The SHENZHEN TIMEWAY TESTING LABORATORIES, reserves the rights to withdraw it and to adopt any other remedies which may be appropriate.



GSM 850MHz Channel = 251

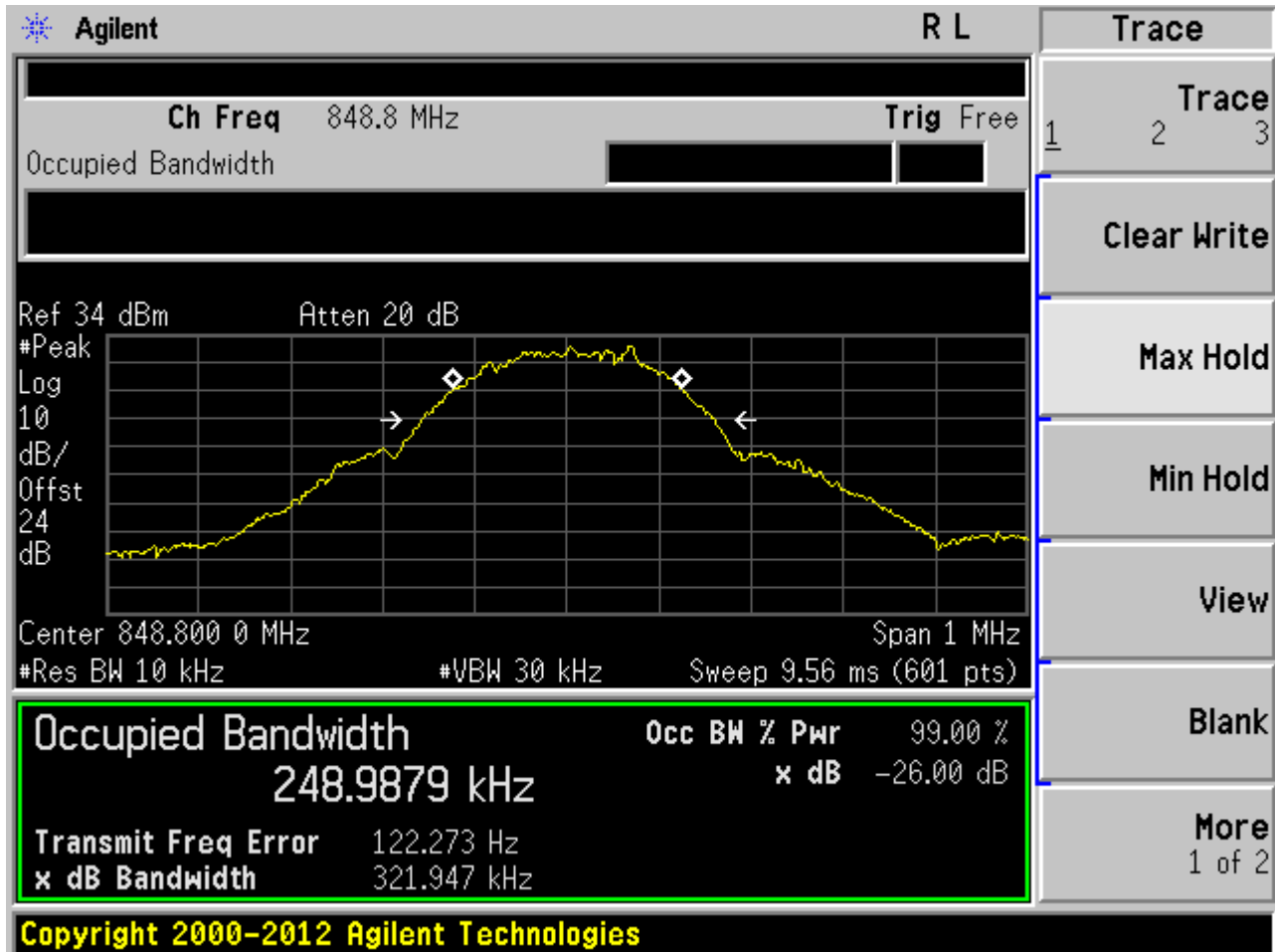

The report refers only to the sample tested and does not apply to the bulk.
 This report is issued in confidence to the client and it will be strictly treated as such by the SHENZHEN TIMEWAY TESTING LABORATORIES. It may not be reproduced rather in its entirety or in part and it may not be used for advertising. The client to whom the report is issued may, however, show or send it . or a certified copy there of prepared by the SHENZHEN TIMEWAY TESTING LABORATORIES. to his customer. Supplier or others persons directly concerned. SHENZHEN TIMEWAY TESTING LABORATORIES. will not, without the consent of the client enter into any discussion of correspondence with any third party concerning the contents of the report.
 In the event of the improper use of the report. The SHENZHEN TIMEWAY TESTING LABORATORIES. reserves the rights to withdraw it and to adopt any other remedies which may be appropriate.



GSM850 EDGE Class8 Channel = 128

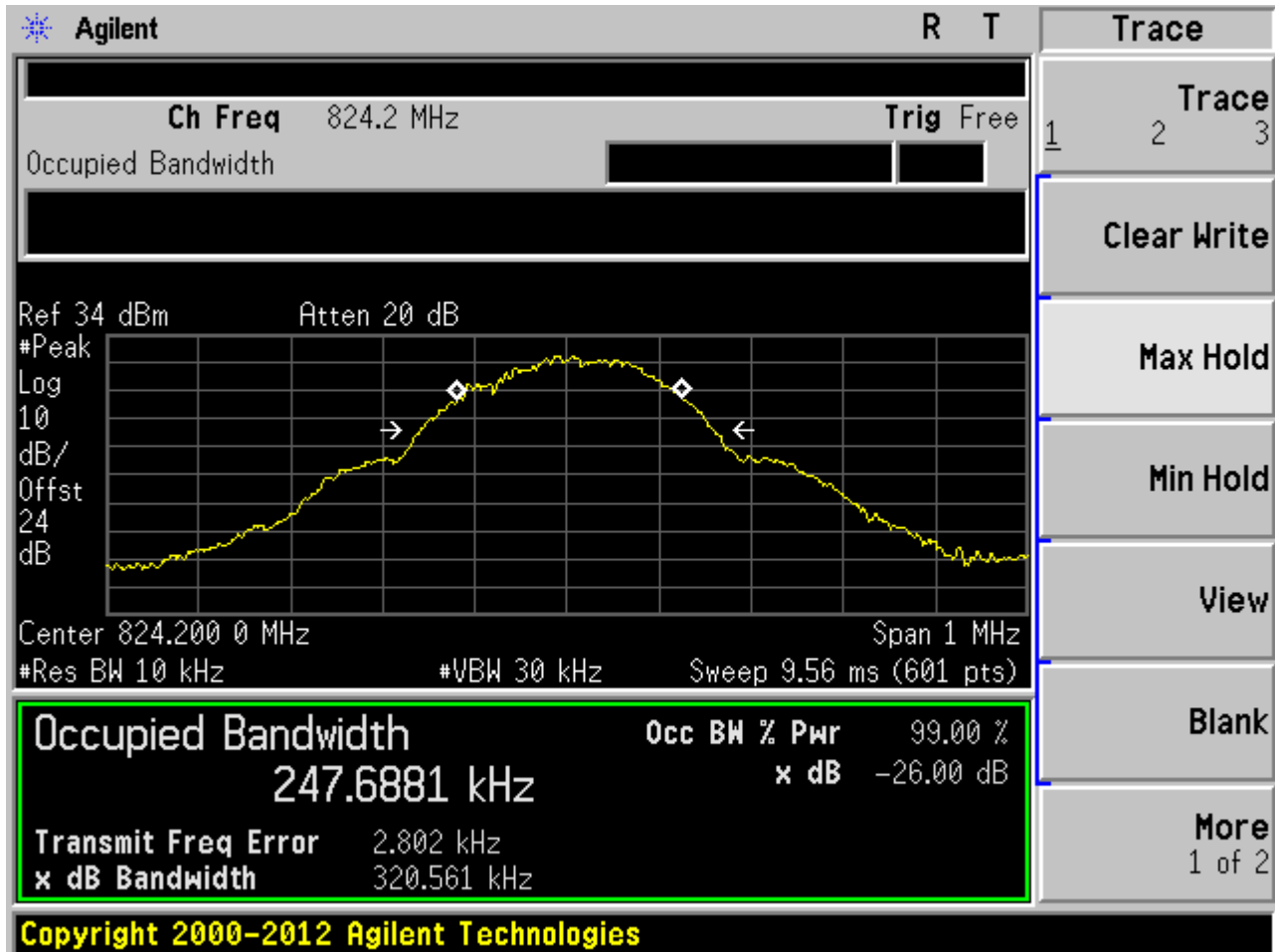

The report refers only to the sample tested and does not apply to the bulk.
 This report is issued in confidence to the client and it will be strictly treated as such by the SHENZHEN TIMEWAY TESTING LABORATORIES. It may not be reproduced rather in its entirety or in part and it may not be used for advertising. The client to whom the report is issued may, however, show or send it . or a certified copy there of prepared by the SHENZHEN TIMEWAY TESTING LABORATORIES. to his customer. Supplier or others persons directly concerned. SHENZHEN TIMEWAY TESTING LABORATORIES. will not, without the consent of the client enter into any discussion of correspondence with any third party concerning the contents of the report.
 In the event of the improper use of the report. The SHENZHEN TIMEWAY TESTING LABORATORIES. reserves the rights to withdraw it and to adopt any other remedies which may be appropriate.



GSM850 EDGE Class8 EDGE Channel = 190

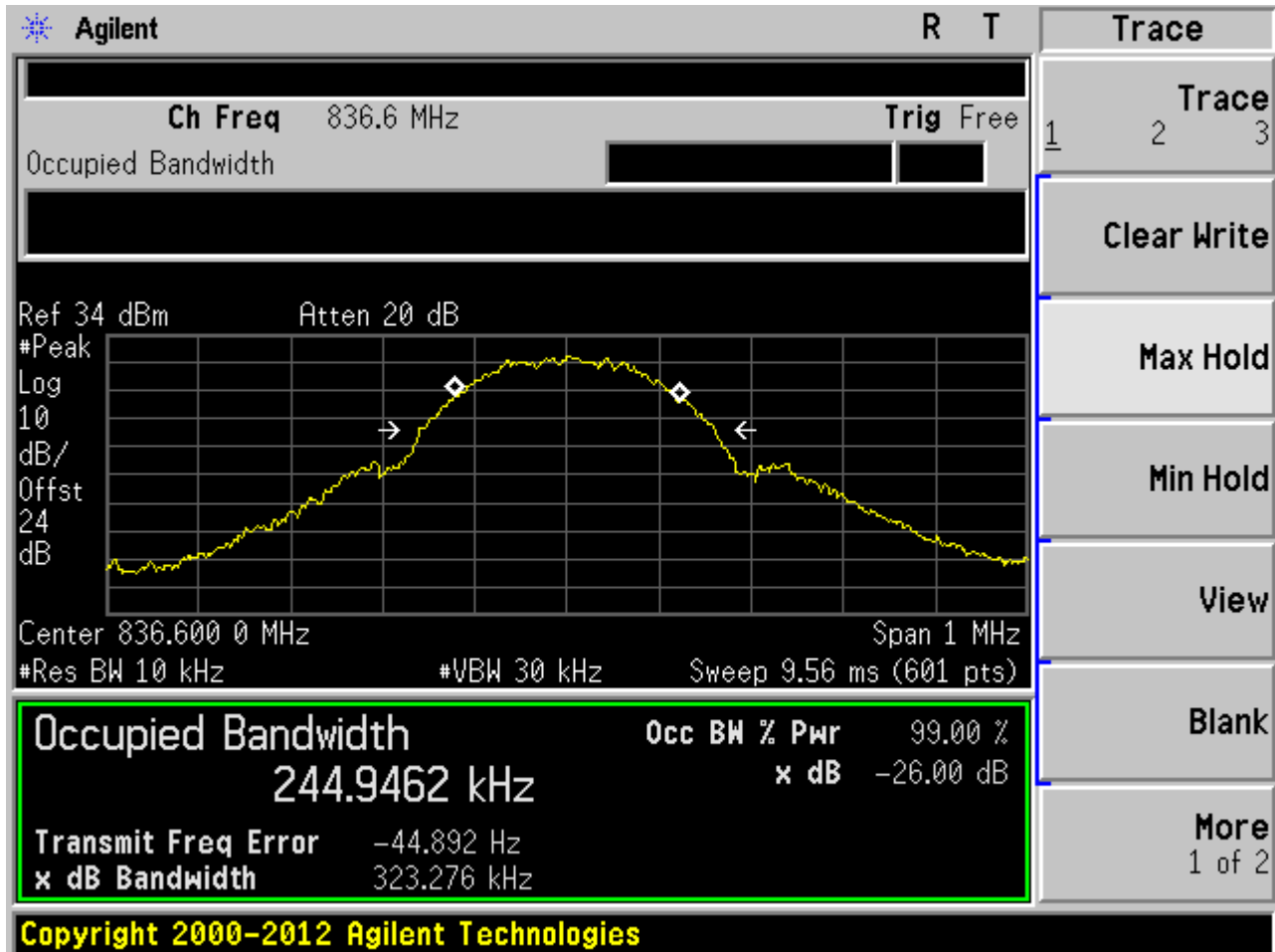

The report refers only to the sample tested and does not apply to the bulk.
 This report is issued in confidence to the client and it will be strictly treated as such by the SHENZHEN TIMEWAY TESTING LABORATORIES. It may not be reproduced rather in its entirety or in part and it may not be used for advertising. The client to whom the report is issued may, however, show or send it . or a certified copy there of prepared by the SHENZHEN TIMEWAY TESTING LABORATORIES. to his customer. Supplier or others persons directly concerned. SHENZHEN TIMEWAY TESTING LABORATORIES. will not, without the consent of the client enter into any discussion of correspondence with any third party concerning the contents of the report.
 In the event of the improper use of the report. The SHENZHEN TIMEWAY TESTING LABORATORIES. reserves the rights to withdraw it and to adopt any other remedies which may be appropriate.



GSM850 EDGE Class8 EDGE Channel = 251

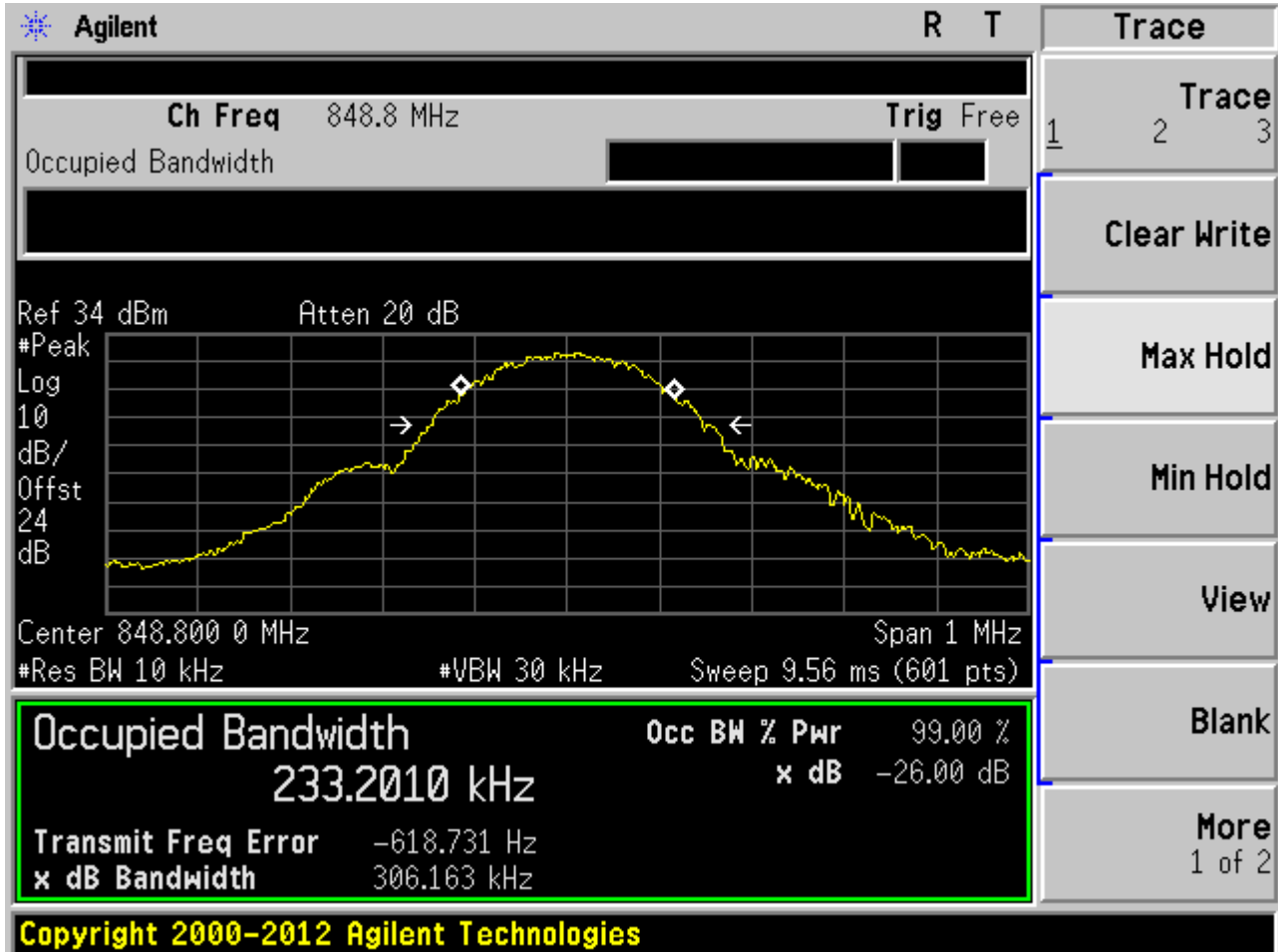

The report refers only to the sample tested and does not apply to the bulk. This report is issued in confidence to the client and it will be strictly treated as such by the SHENZHEN TIMEWAY TESTING LABORATORIES. It may not be reproduced rather in its entirety or in part and it may not be used for advertising. The client to whom the report is issued may, however, show or send it . or a certified copy there of prepared by the SHENZHEN TIMEWAY TESTING LABORATORIES. to his customer. Supplier or others persons directly concerned. SHENZHEN TIMEWAY TESTING LABORATORIES. will not, without the consent of the client enter into any discussion of correspondence with any third party concerning the contents of the report. In the event of the improper use of the report. The SHENZHEN TIMEWAY TESTING LABORATORIES. reserves the rights to withdraw it and to adopt any other remedies which may be appropriate.



GSM 1900MHz Channel = 512

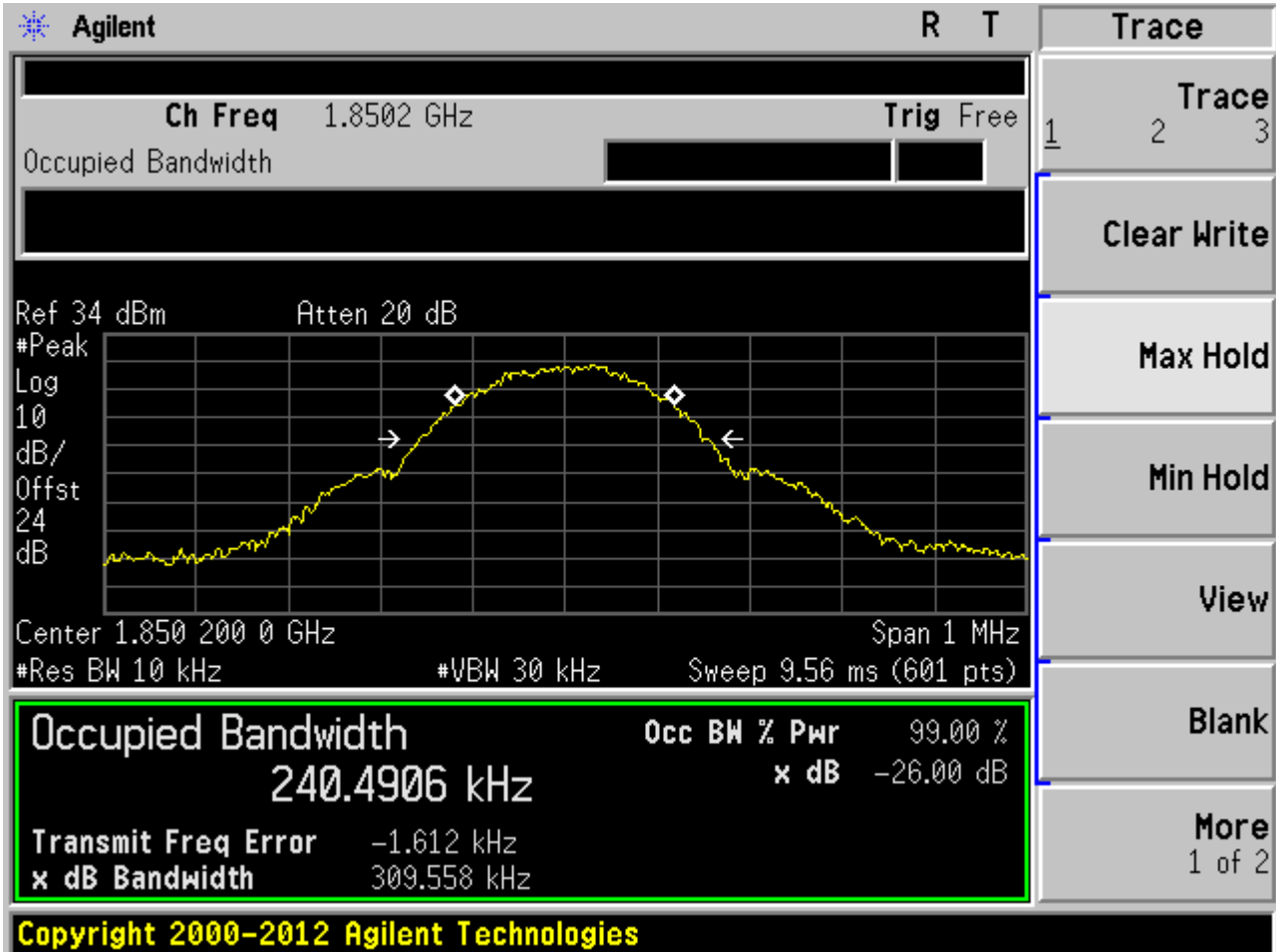

The report refers only to the sample tested and does not apply to the bulk.
 This report is issued in confidence to the client and it will be strictly treated as such by the SHENZHEN TIMEWAY TESTING LABORATORIES. It may not be reproduced rather in its entirety or in part and it may not be used for advertising. The client to whom the report is issued may, however, show or send it . or a certified copy there of prepared by the SHENZHEN TIMEWAY TESTING LABORATORIES. to his customer. Supplier or others persons directly concerned. SHENZHEN TIMEWAY TESTING LABORATORIES. will not, without the consent of the client enter into any discussion of correspondence with any third party concerning the contents of the report.
 In the event of the improper use of the report. The SHENZHEN TIMEWAY TESTING LABORATORIES. reserves the rights to withdraw it and to adopt any other remedies which may be appropriate.



GSM 1900MHz Channel = 661

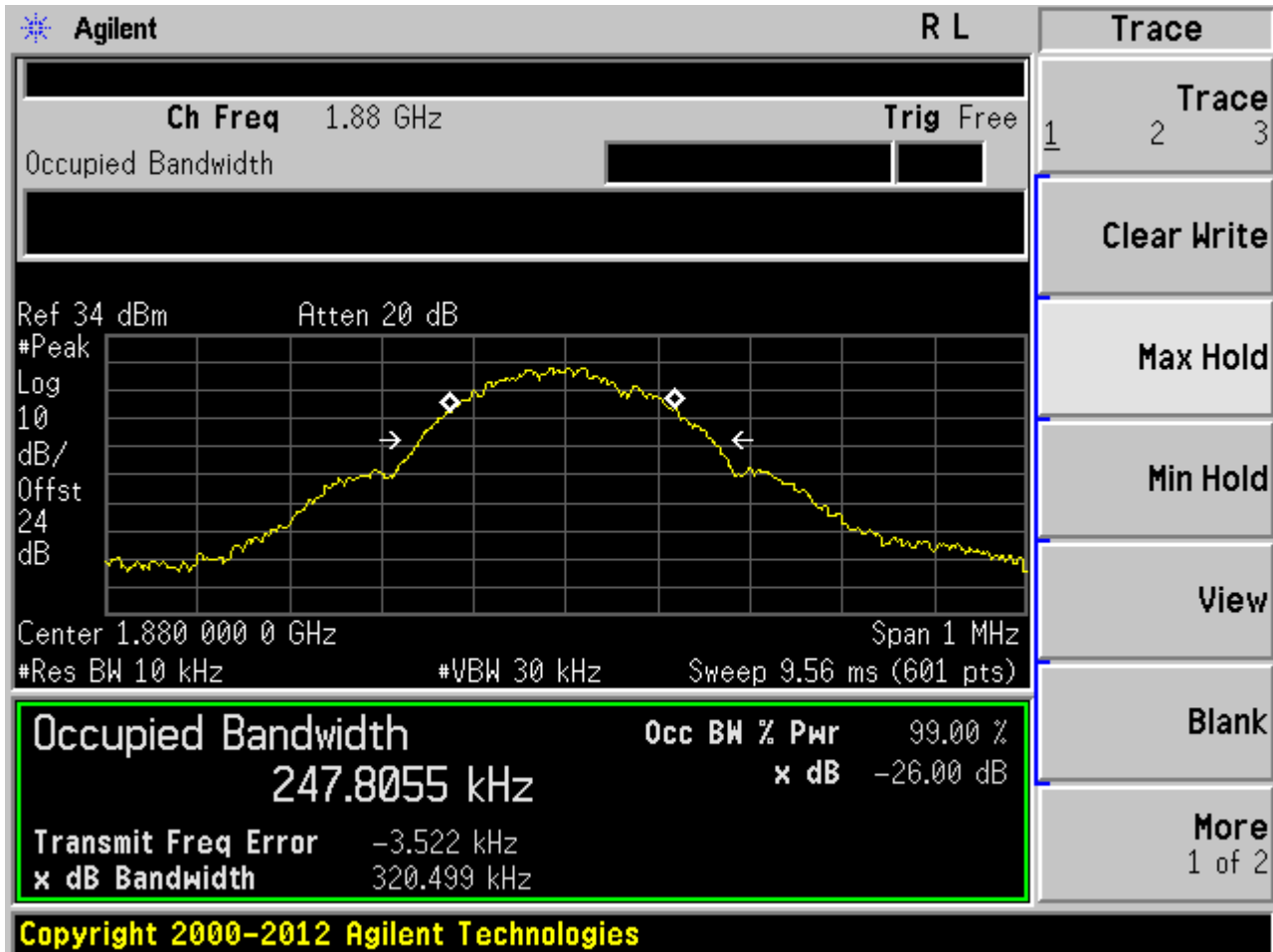

The report refers only to the sample tested and does not apply to the bulk.
 This report is issued in confidence to the client and it will be strictly treated as such by the SHENZHEN TIMEWAY TESTING LABORATORIES. It may not be reproduced rather in its entirety or in part and it may not be used for advertising. The client to whom the report is issued may, however, show or send it, or a certified copy thereof prepared by the SHENZHEN TIMEWAY TESTING LABORATORIES, to his customer. Supplier or others persons directly concerned. SHENZHEN TIMEWAY TESTING LABORATORIES, will not, without the consent of the client enter into any discussion of correspondence with any third party concerning the contents of the report.
 In the event of the improper use of the report. The SHENZHEN TIMEWAY TESTING LABORATORIES, reserves the rights to withdraw it and to adopt any other remedies which may be appropriate.



GSM 1900MHz Channel = 810

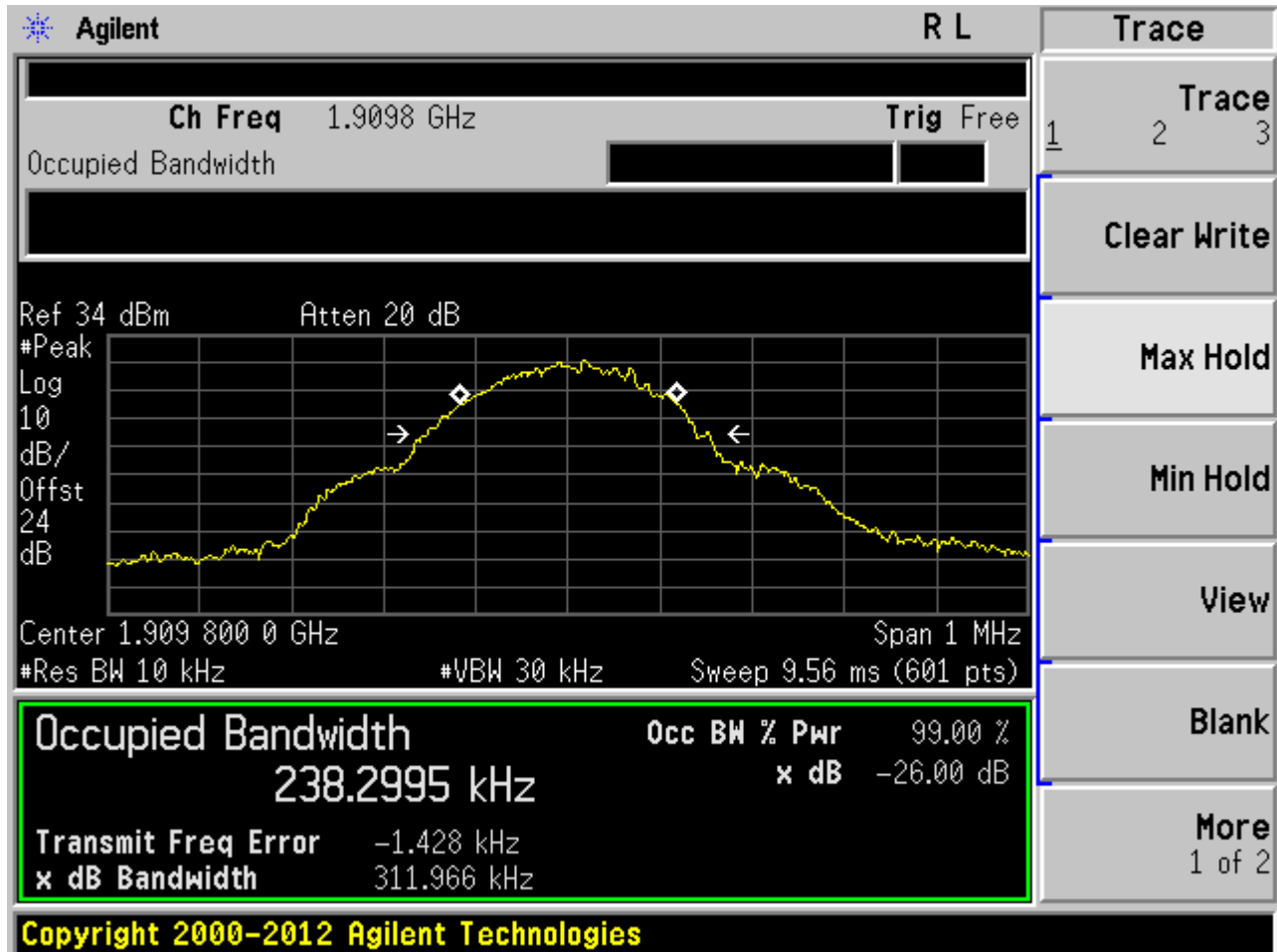

The report refers only to the sample tested and does not apply to the bulk. This report is issued in confidence to the client and it will be strictly treated as such by the SHENZHEN TIMEWAY TESTING LABORATORIES. It may not be reproduced rather in its entirety or in part and it may not be used for advertising. The client to whom the report is issued may, however, show or send it . or a certified copy there of prepared by the SHENZHEN TIMEWAY TESTING LABORATORIES. to his customer. Supplier or others persons directly concerned. SHENZHEN TIMEWAY TESTING LABORATORIES. will not, without the consent of the client enter into any discussion of correspondence with any third party concerning the contents of the report. In the event of the improper use of the report. The SHENZHEN TIMEWAY TESTING LABORATORIES. reserves the rights to withdraw it and to adopt any other remedies which may be appropriate.



GSM1900 EDGE Class8 Channel =512

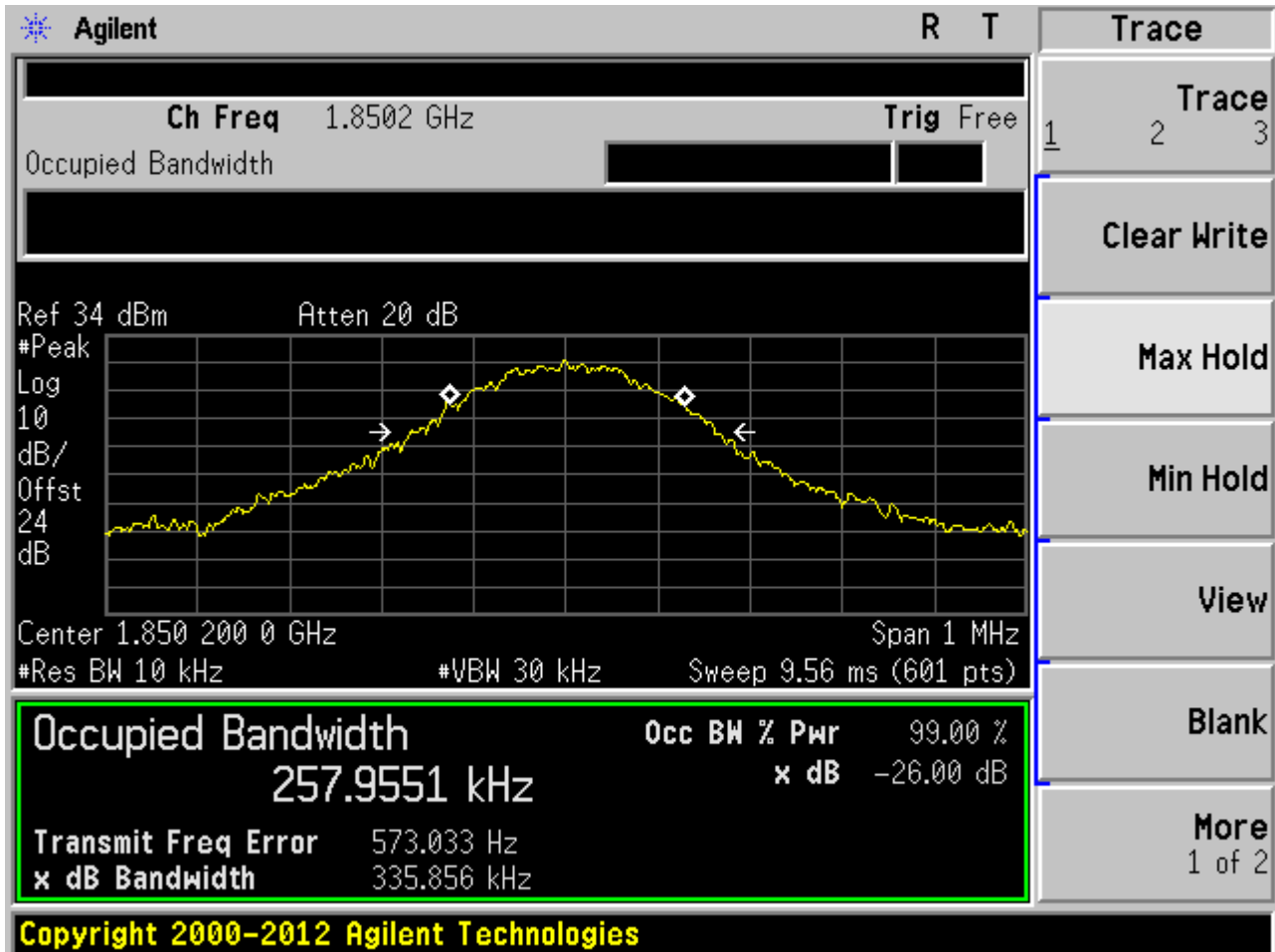

The report refers only to the sample tested and does not apply to the bulk.
 This report is issued in confidence to the client and it will be strictly treated as such by the SHENZHEN TIMEWAY TESTING LABORATORIES. It may not be reproduced rather in its entirety or in part and it may not be used for advertising. The client to whom the report is issued may, however, show or send it . or a certified copy there of prepared by the SHENZHEN TIMEWAY TESTING LABORATORIES. to his customer. Supplier or others persons directly concerned. SHENZHEN TIMEWAY TESTING LABORATORIES. will not, without the consent of the client enter into any discussion of correspondence with any third party concerning the contents of the report.
 In the event of the improper use of the report. The SHENZHEN TIMEWAY TESTING LABORATORIES. reserves the rights to withdraw it and to adopt any other remedies which may be appropriate.



GSM1900 EDGE Class8 Channel =661

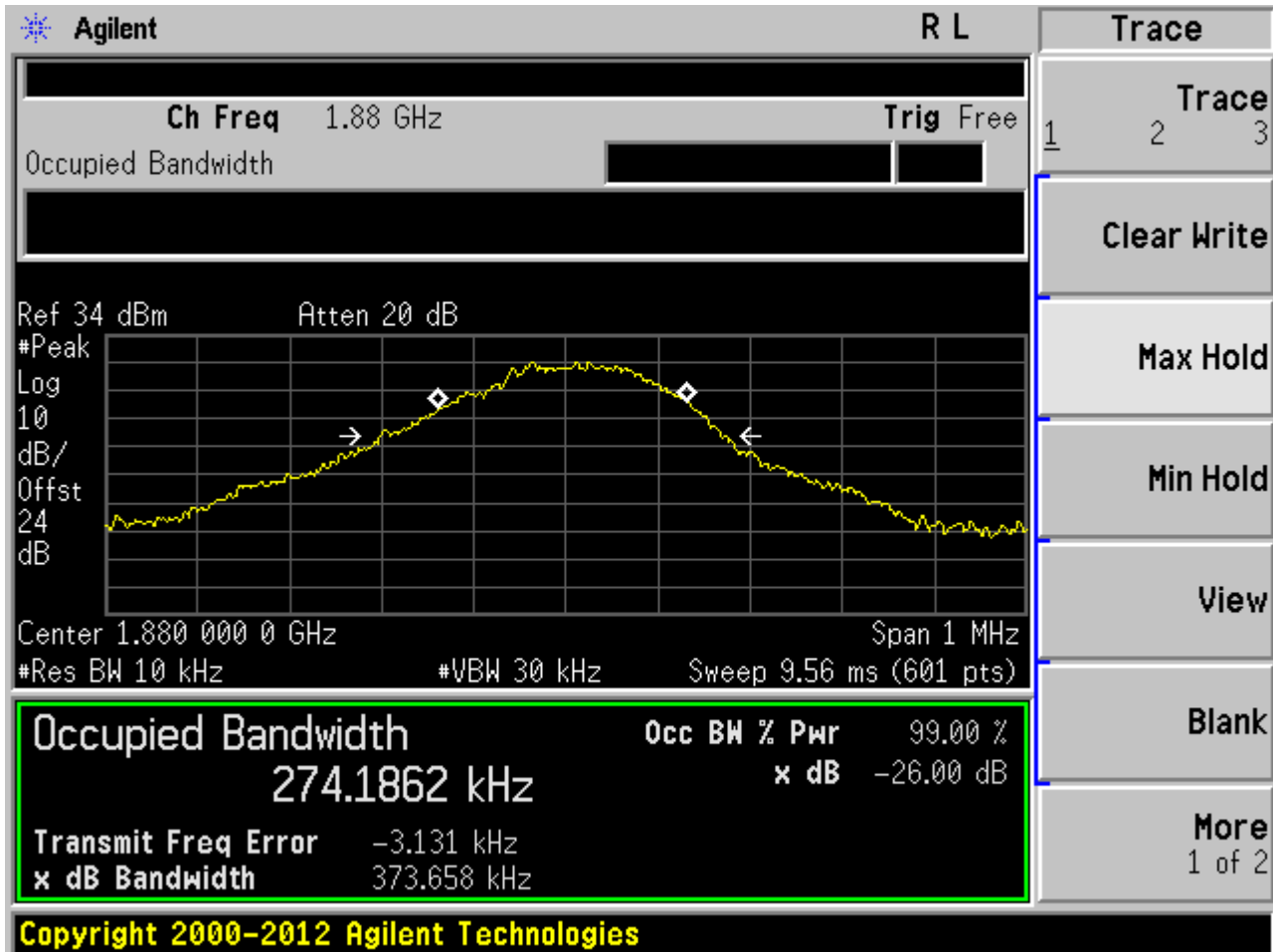

The report refers only to the sample tested and does not apply to the bulk.

This report is issued in confidence to the client and it will be strictly treated as such by the SHENZHEN TIMEWAY TESTING LABORATORIES. It may not be reproduced rather in its entirety or in part and it may not be used for advertising. The client to whom the report is issued may, however, show or send it or a certified copy thereof prepared by the SHENZHEN TIMEWAY TESTING LABORATORIES to his customer. Supplier or others persons directly concerned. SHENZHEN TIMEWAY TESTING LABORATORIES will not, without the consent of the client enter into any discussion of correspondence with any third party concerning the contents of the report.

In the event of the improper use of the report. The SHENZHEN TIMEWAY TESTING LABORATORIES reserves the rights to withdraw it and to adopt any other remedies which may be appropriate.



GSM1900 EDGE Class8 Channel =810

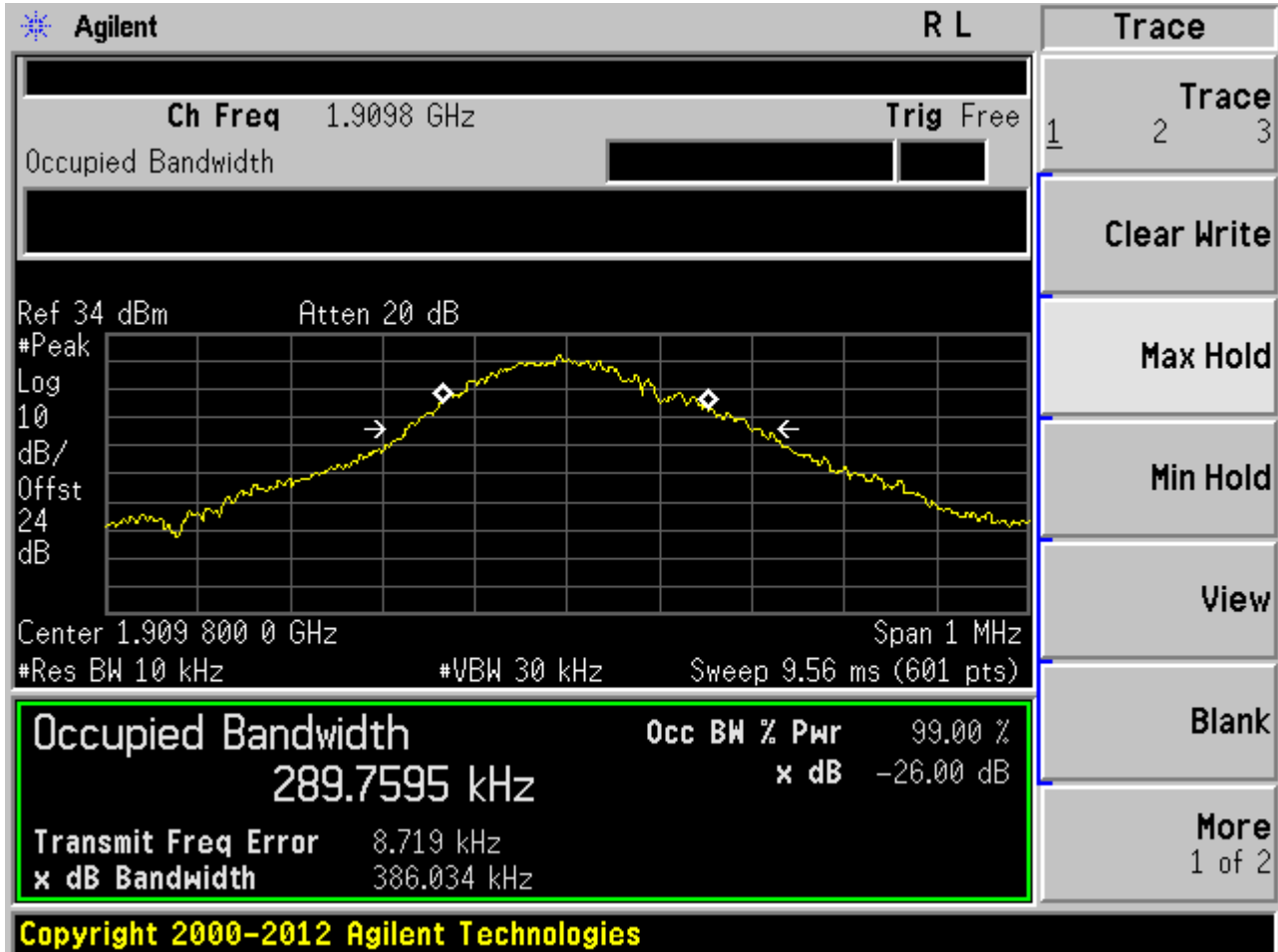

The report refers only to the sample tested and does not apply to the bulk.
 This report is issued in confidence to the client and it will be strictly treated as such by the SHENZHEN TIMEWAY TESTING LABORATORIES. It may not be reproduced rather in its entirety or in part and it may not be used for advertising. The client to whom the report is issued may, however, show or send it or a certified copy thereof prepared by the SHENZHEN TIMEWAY TESTING LABORATORIES to his customer. Supplier or others persons directly concerned. SHENZHEN TIMEWAY TESTING LABORATORIES will not, without the consent of the client enter into any discussion of correspondence with any third party concerning the contents of the report.
 In the event of the improper use of the report. The SHENZHEN TIMEWAY TESTING LABORATORIES reserves the rights to withdraw it and to adopt any other remedies which may be appropriate.



WCDMA 850MHz Channel = 4132

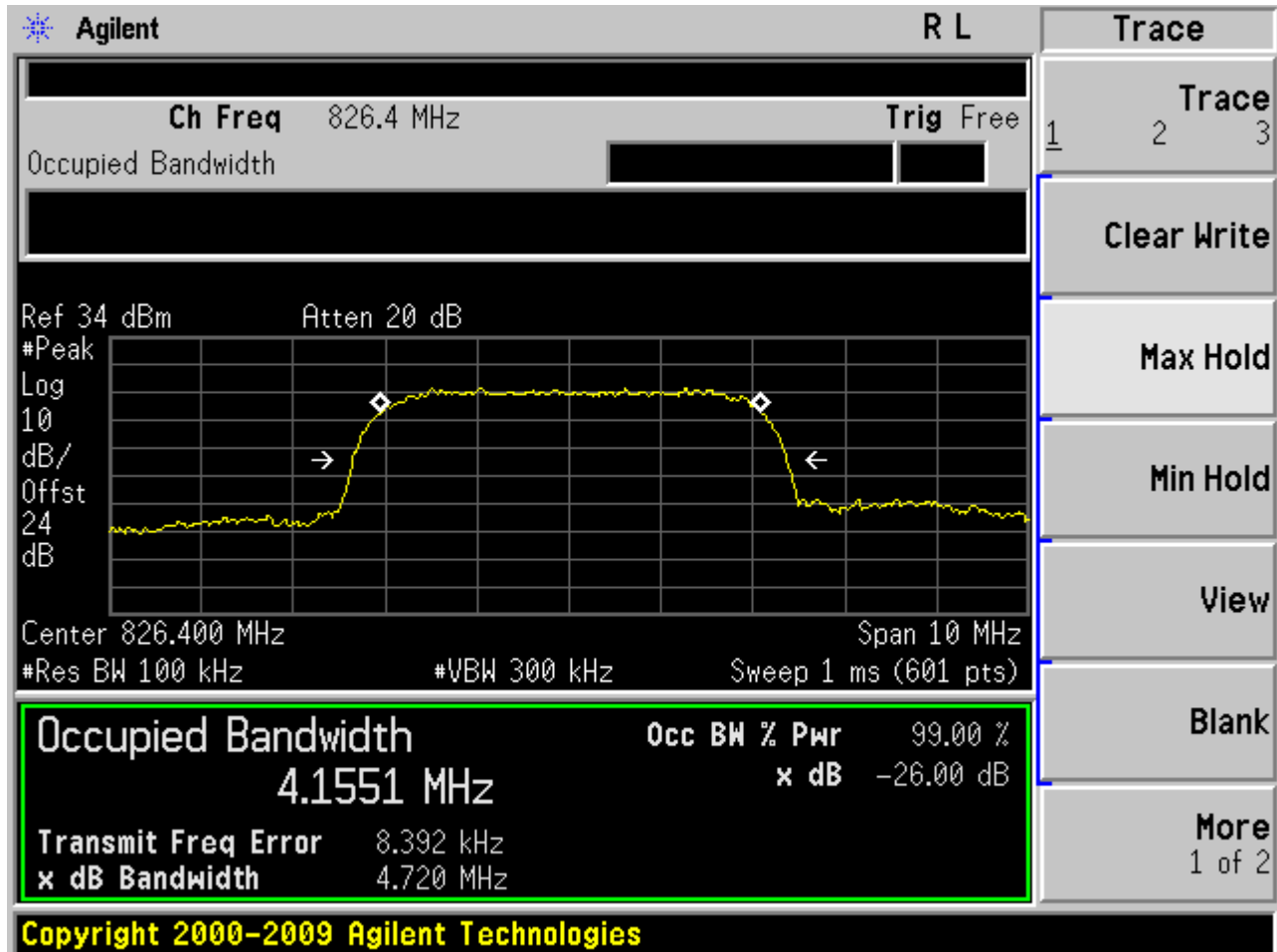

The report refers only to the sample tested and does not apply to the bulk.
 This report is issued in confidence to the client and it will be strictly treated as such by the SHENZHEN TIMEWAY TESTING LABORATORIES. It may not be reproduced rather in its entirety or in part and it may not be used for advertising. The client to whom the report is issued may, however, show or send it or a certified copy thereof prepared by the SHENZHEN TIMEWAY TESTING LABORATORIES to his customer. Supplier or others persons directly concerned. SHENZHEN TIMEWAY TESTING LABORATORIES will not, without the consent of the client enter into any discussion of correspondence with any third party concerning the contents of the report.
 In the event of the improper use of the report. The SHENZHEN TIMEWAY TESTING LABORATORIES reserves the rights to withdraw it and to adopt any other remedies which may be appropriate.



WCDMA 850MHz Channel = 4182

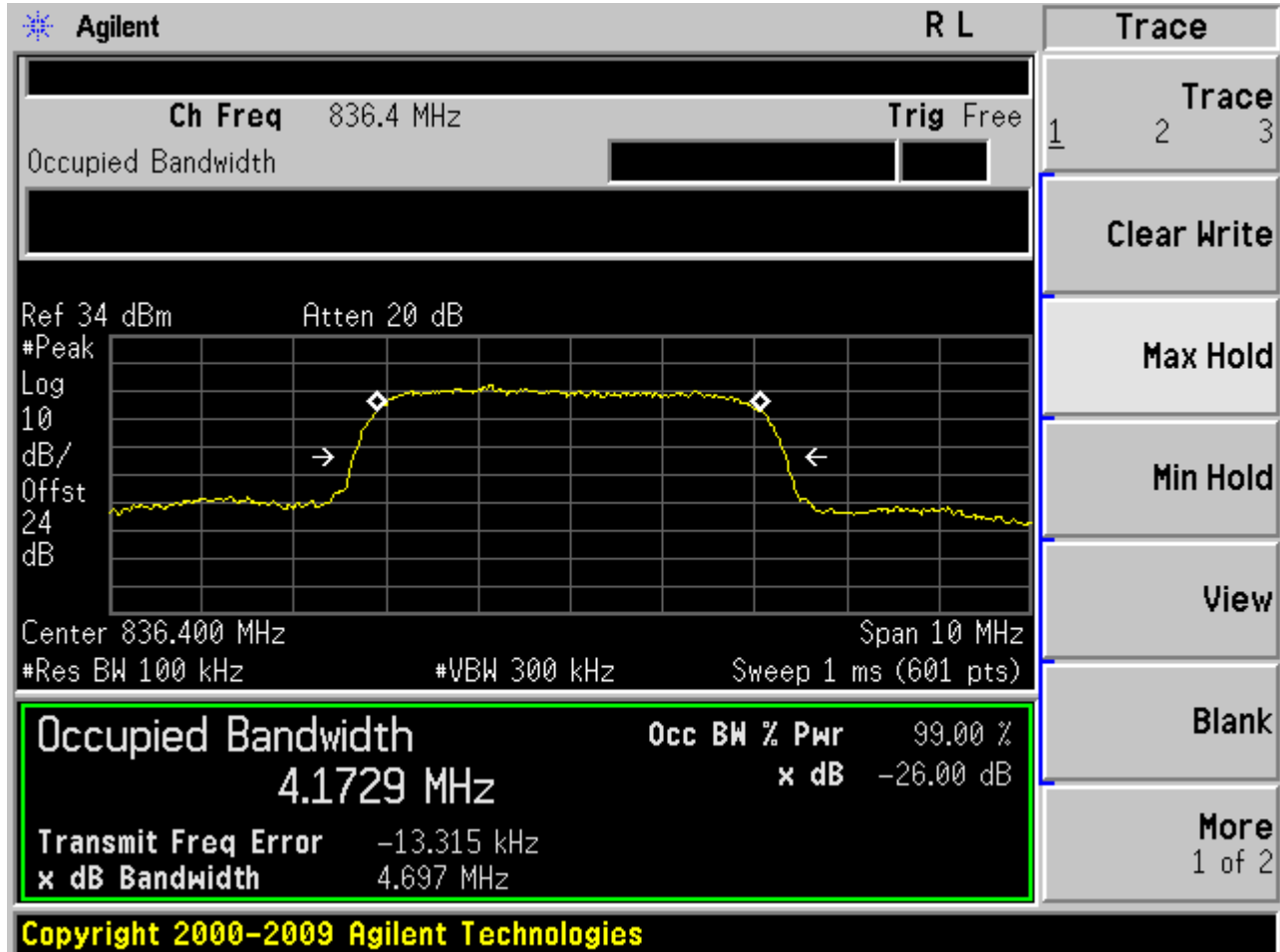

The report refers only to the sample tested and does not apply to the bulk.
 This report is issued in confidence to the client and it will be strictly treated as such by the SHENZHEN TIMEWAY TESTING LABORATORIES. It may not be reproduced rather in its entirety or in part and it may not be used for advertising. The client to whom the report is issued may, however, show or send it . or a certified copy there of prepared by the SHENZHEN TIMEWAY TESTING LABORATORIES. to his customer. Supplier or others persons directly concerned. SHENZHEN TIMEWAY TESTING LABORATORIES. will not, without the consent of the client enter into any discussion of correspondence with any third party concerning the contents of the report.
 In the event of the improper use of the report. The SHENZHEN TIMEWAY TESTING LABORATORIES. reserves the rights to withdraw it and to adopt any other remedies which may be appropriate.



WCDMA 850MHz Channel = 4233

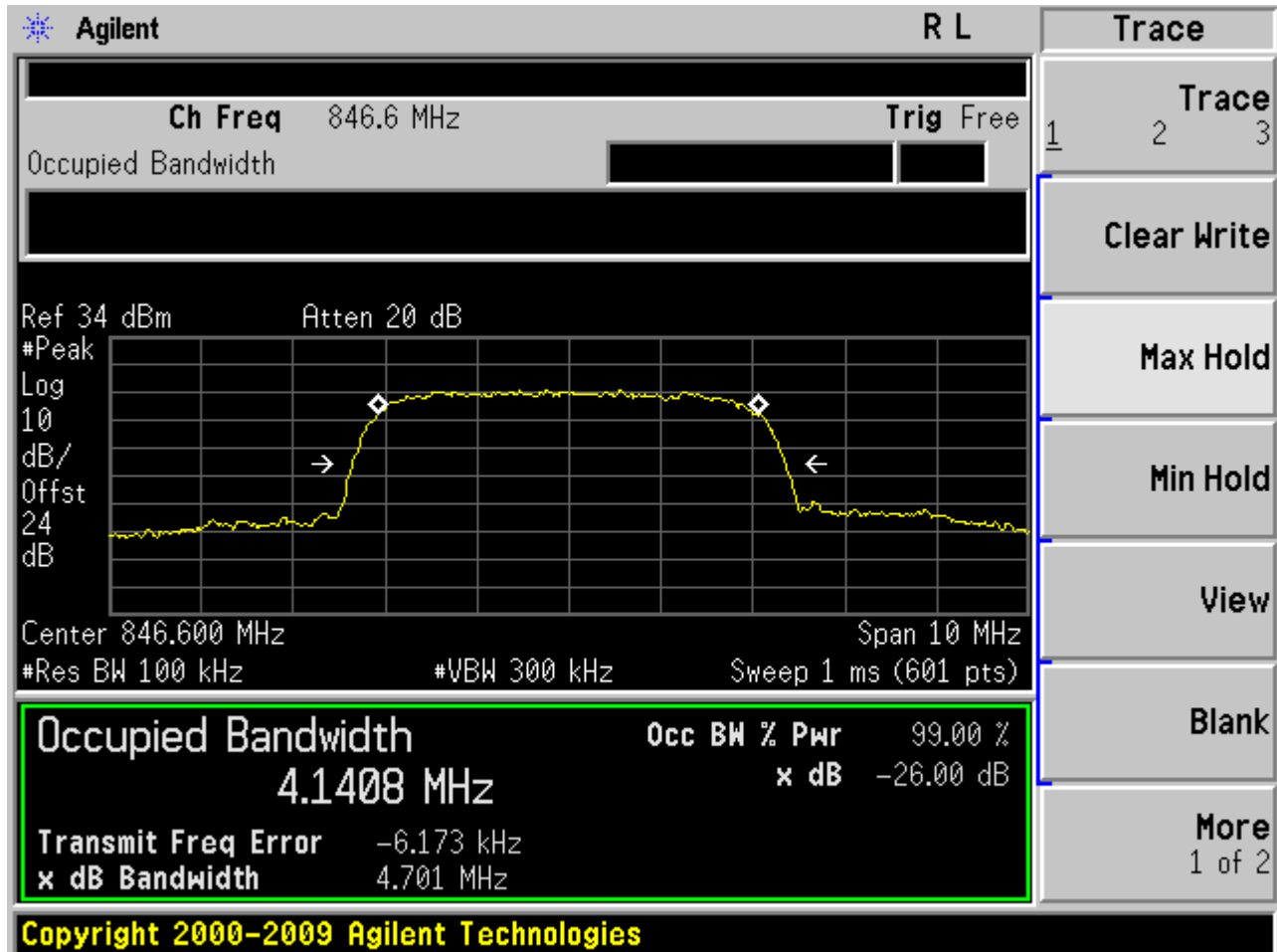

The report refers only to the sample tested and does not apply to the bulk.
 This report is issued in confidence to the client and it will be strictly treated as such by the SHENZHEN TIMEWAY TESTING LABORATORIES. It may not be reproduced rather in its entirety or in part and it may not be used for advertising. The client to whom the report is issued may, however, show or send it . or a certified copy there of prepared by the SHENZHEN TIMEWAY TESTING LABORATORIES. to his customer. Supplier or others persons directly concerned. SHENZHEN TIMEWAY TESTING LABORATORIES. will not, without the consent of the client enter into any discussion of correspondence with any third party concerning the contents of the report.
 In the event of the improper use of the report. The SHENZHEN TIMEWAY TESTING LABORATORIES. reserves the rights to withdraw it and to adopt any other remedies which may be appropriate.



WCDMA 1900MHz Channel = 9262

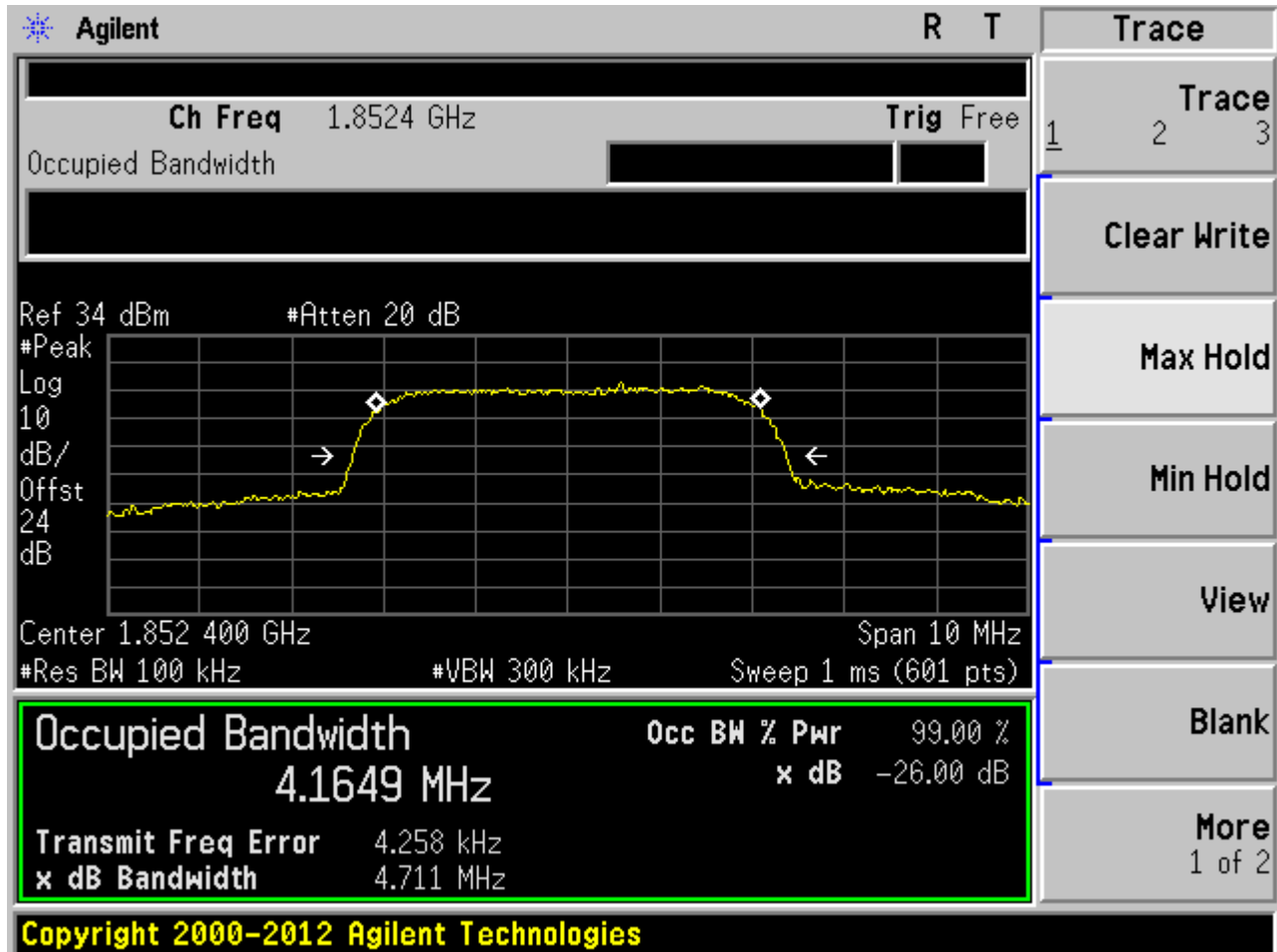

The report refers only to the sample tested and does not apply to the bulk.
 This report is issued in confidence to the client and it will be strictly treated as such by the SHENZHEN TIMEWAY TESTING LABORATORIES. It may not be reproduced rather in its entirety or in part and it may not be used for advertising. The client to whom the report is issued may, however, show or send it . or a certified copy there of prepared by the SHENZHEN TIMEWAY TESTING LABORATORIES. to his customer. Supplier or others persons directly concerned. SHENZHEN TIMEWAY TESTING LABORATORIES. will not, without the consent of the client enter into any discussion of correspondence with any third party concerning the contents of the report.
 In the event of the improper use of the report. The SHENZHEN TIMEWAY TESTING LABORATORIES. reserves the rights to withdraw it and to adopt any other remedies which may be appropriate.



WCDMA 1900MHz Channel = 9400

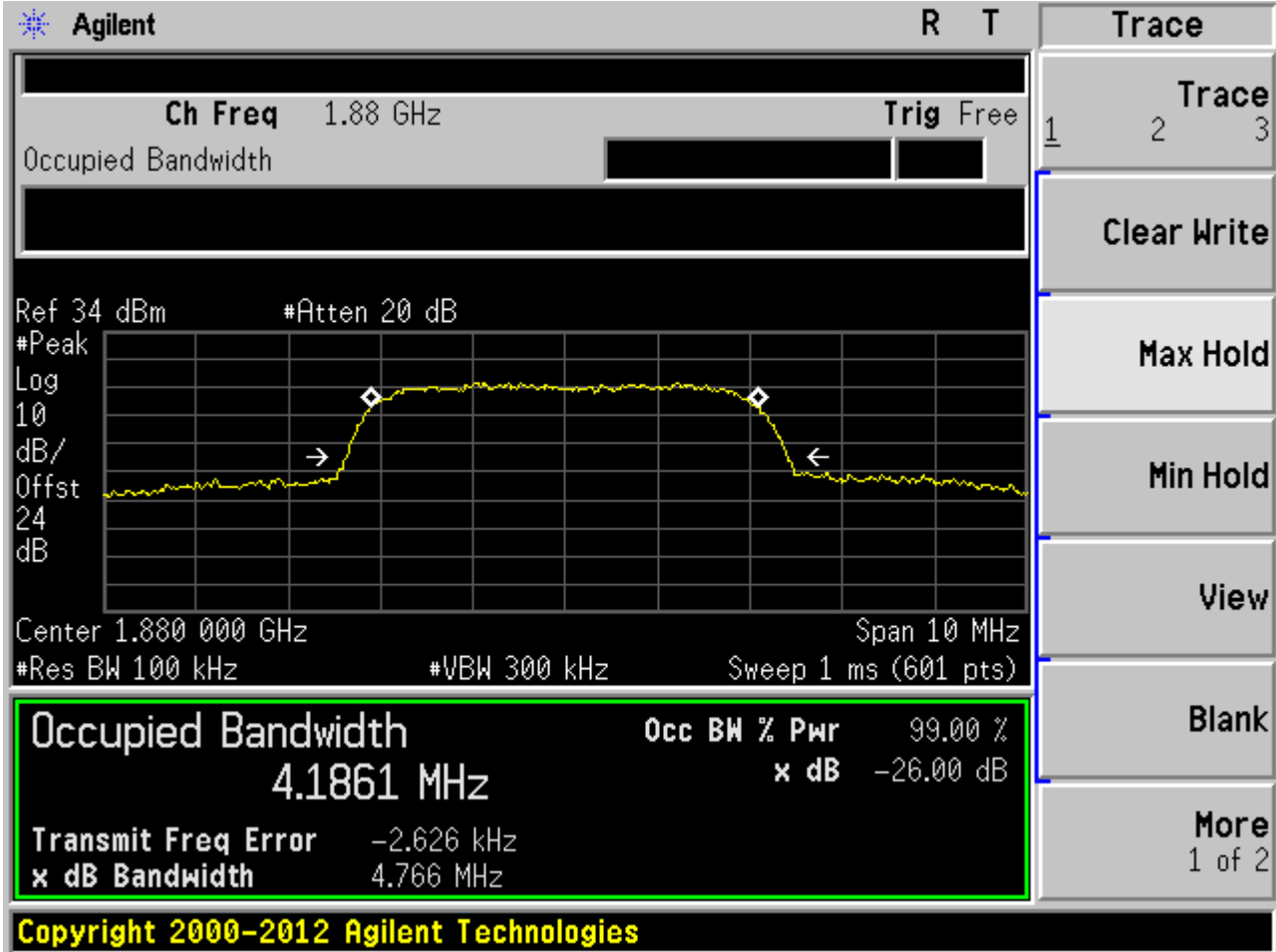

The report refers only to the sample tested and does not apply to the bulk.
 This report is issued in confidence to the client and it will be strictly treated as such by the SHENZHEN TIMEWAY TESTING LABORATORIES. It may not be reproduced rather in its entirety or in part and it may not be used for advertising. The client to whom the report is issued may, however, show or send it . or a certified copy there of prepared by the SHENZHEN TIMEWAY TESTING LABORATORIES. to his customer. Supplier or others persons directly concerned. SHENZHEN TIMEWAY TESTING LABORATORIES. will not, without the consent of the client enter into any discussion of correspondence with any third party concerning the contents of the report.
 In the event of the improper use of the report. The SHENZHEN TIMEWAY TESTING LABORATORIES. reserves the rights to withdraw it and to adopt any other remedies which may be appropriate.



WCDMA 1900MHz Channel = 9538

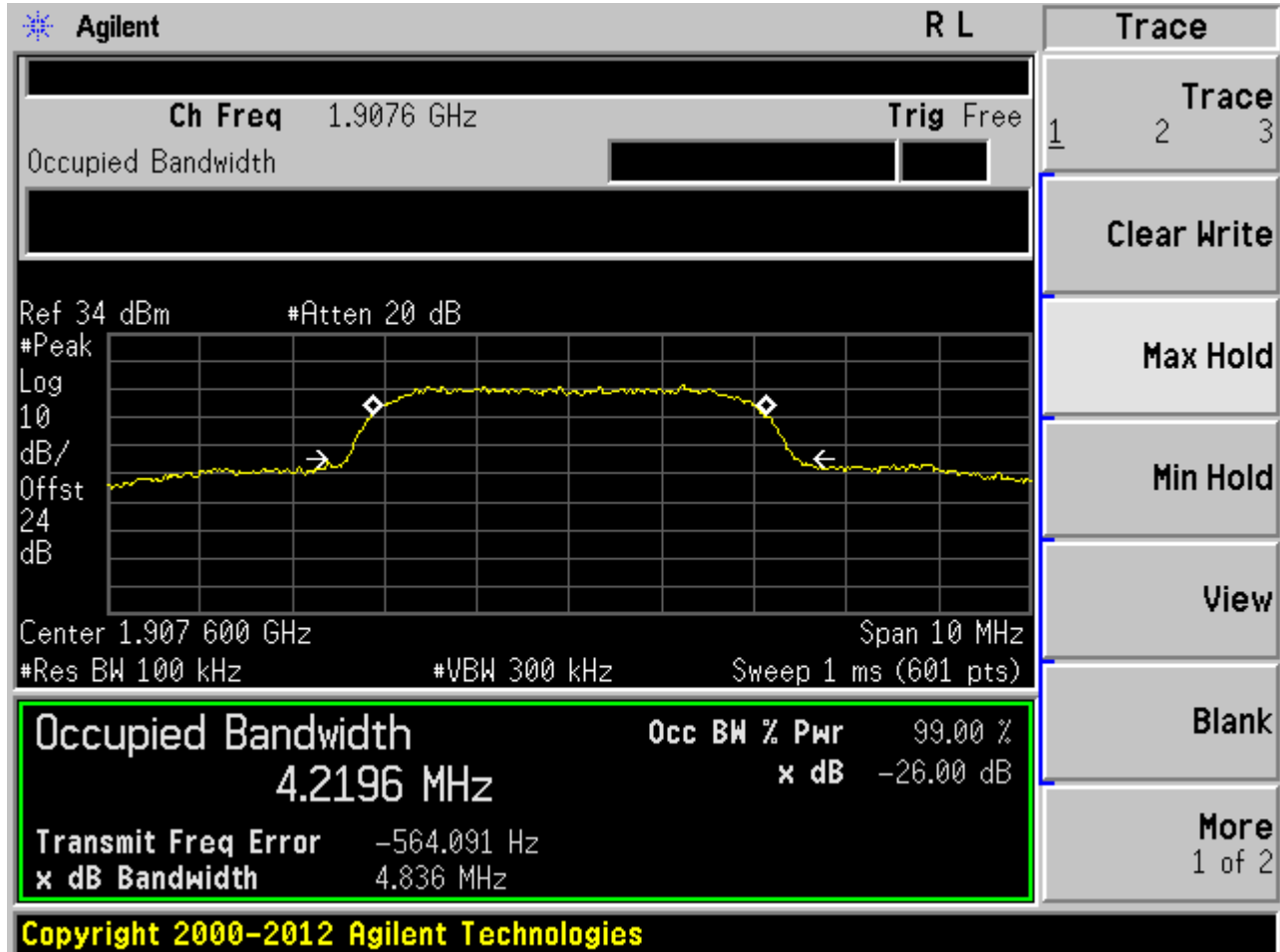

The report refers only to the sample tested and does not apply to the bulk. This report is issued in confidence to the client and it will be strictly treated as such by the SHENZHEN TIMEWAY TESTING LABORATORIES. It may not be reproduced rather in its entirety or in part and it may not be used for advertising. The client to whom the report is issued may, however, show or send it, or a certified copy thereof prepared by the SHENZHEN TIMEWAY TESTING LABORATORIES, to his customer. Supplier or others persons directly concerned. SHENZHEN TIMEWAY TESTING LABORATORIES, will not, without the consent of the client enter into any discussion of correspondence with any third party concerning the contents of the report. In the event of the improper use of the report. The SHENZHEN TIMEWAY TESTING LABORATORIES, reserves the rights to withdraw it and to adopt any other remedies which may be appropriate.



3.4 Band Edge Measurement

3.4.1 Description of Band Edge Measurement

The power of any emission outside of the authorized operating frequency ranges must be lower than the transmitter power (P) by a factor of at least $43 + 10 \log (P)$ dB.

3.4.2 Measuring Instruments

See list of measuring instruments of this test report.

3.4.3 Test Procedures

1. The EUT was connected to Spectrum Analyzer and Base Station via power divider.
2. The RF output of EUT was connected to the spectrum analyzer by RF cable and attenuator. The path loss was compensated to the results for each measurement.
3. The band edges of low and high channels for the highest RF powers were measured. Setting RBW as roughly $BW/100$.
4. The RF fundamental frequency should be excluded against the limit line in the operating frequency band.
5. The limit line is derived from $43 + 10 \log (P)$ dB below the transmitter power P(Watts)
 $= P(W) - [43 + 10 \log(P)]$ (dB)
 $= [30 + 10 \log(P)]$ (dBm) - $[43 + 10 \log(P)]$ (dB)
 $= -13 \text{dBm}$.

3.4.4 Test Setup

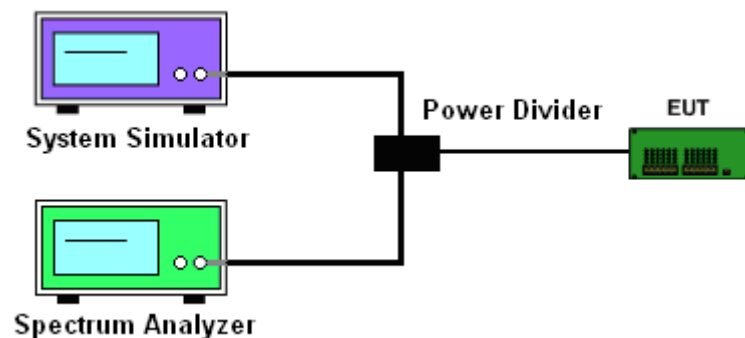

The report refers only to the sample tested and does not apply to the bulk.
This report is issued in confidence to the client and it will be strictly treated as such by the SHENZHEN TIMEWAY TESTING LABORATORIES. It may not be reproduced rather in its entirety or in part and it may not be used for advertising. The client to whom the report is issued may, however, show or send it or a certified copy thereof prepared by the SHENZHEN TIMEWAY TESTING LABORATORIES to his customer. Supplier or other persons directly concerned. SHENZHEN TIMEWAY TESTING LABORATORIES will not, without the consent of the client enter into any discussion of correspondence with any third party concerning the contents of the report.
In the event of the improper use of the report. The SHENZHEN TIMEWAY TESTING LABORATORIES reserves the rights to withdraw it and to adopt any other remedies which may be appropriate.



3.4.5 Test Result (Plots) of Conducted Band Edge

Band :	GSM850	Power Stage :	High
Test Mode :	GSM Link		

Lower Band Edge Plot on Channel 128

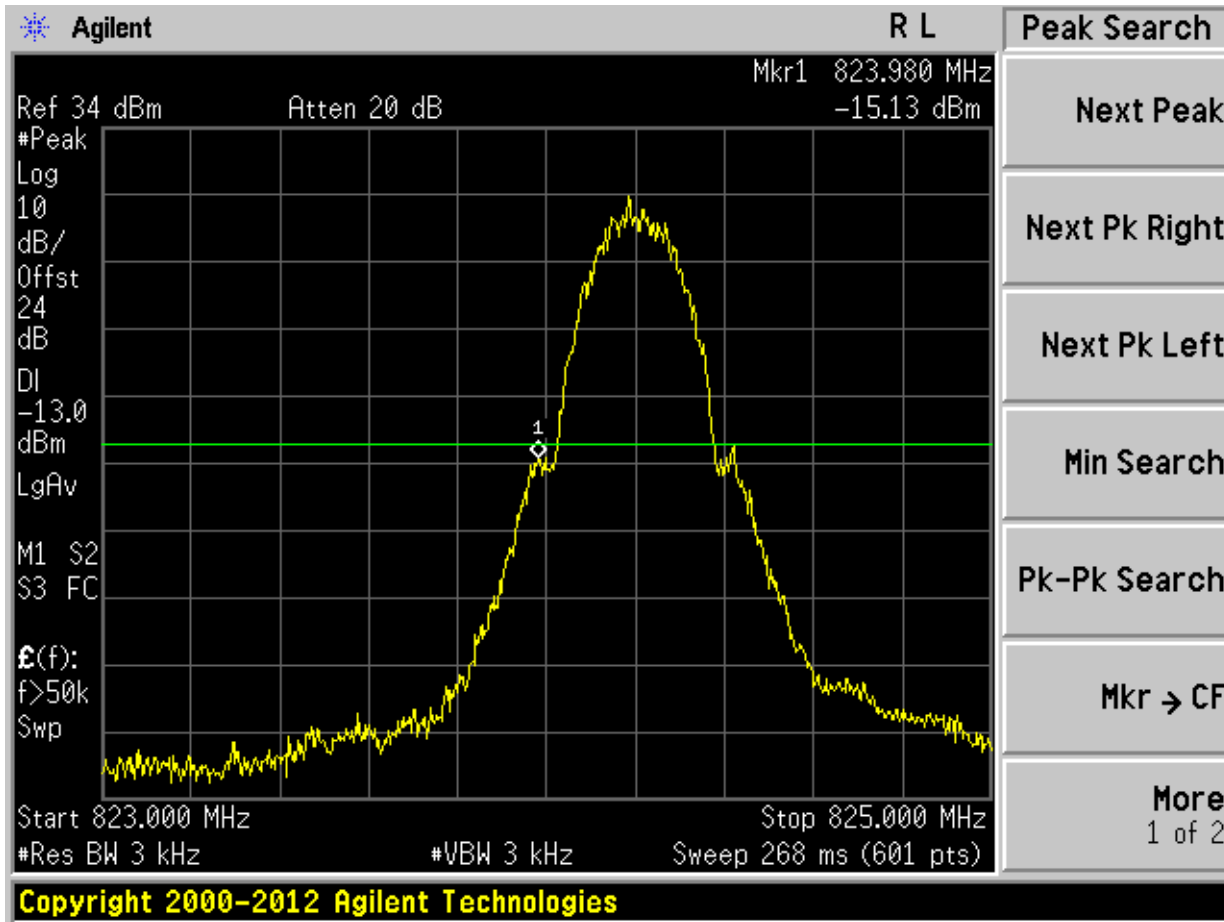

The report refers only to the sample tested and does not apply to the bulk.
 This report is issued in confidence to the client and it will be strictly treated as such by the SHENZHEN TIMEWAY TESTING LABORATORIES. It may not be reproduced rather in its entirety or in part and it may not be used for advertising. The client to whom the report is issued may, however, show or send it . or a certified copy there of prepared by the SHENZHEN TIMEWAY TESTING LABORATORIES. to his customer. Supplier or others persons directly concerned. SHENZHEN TIMEWAY TESTING LABORATORIES. will not, without the consent of the client enter into any discussion of correspondence with any third party concerning the contents of the report.
 In the event of the improper use of the report. The SHENZHEN TIMEWAY TESTING LABORATORIES. reserves the rights to withdraw it and to adopt any other remedies which may be appropriate.



Higher Band Edge Plot on Channel 251

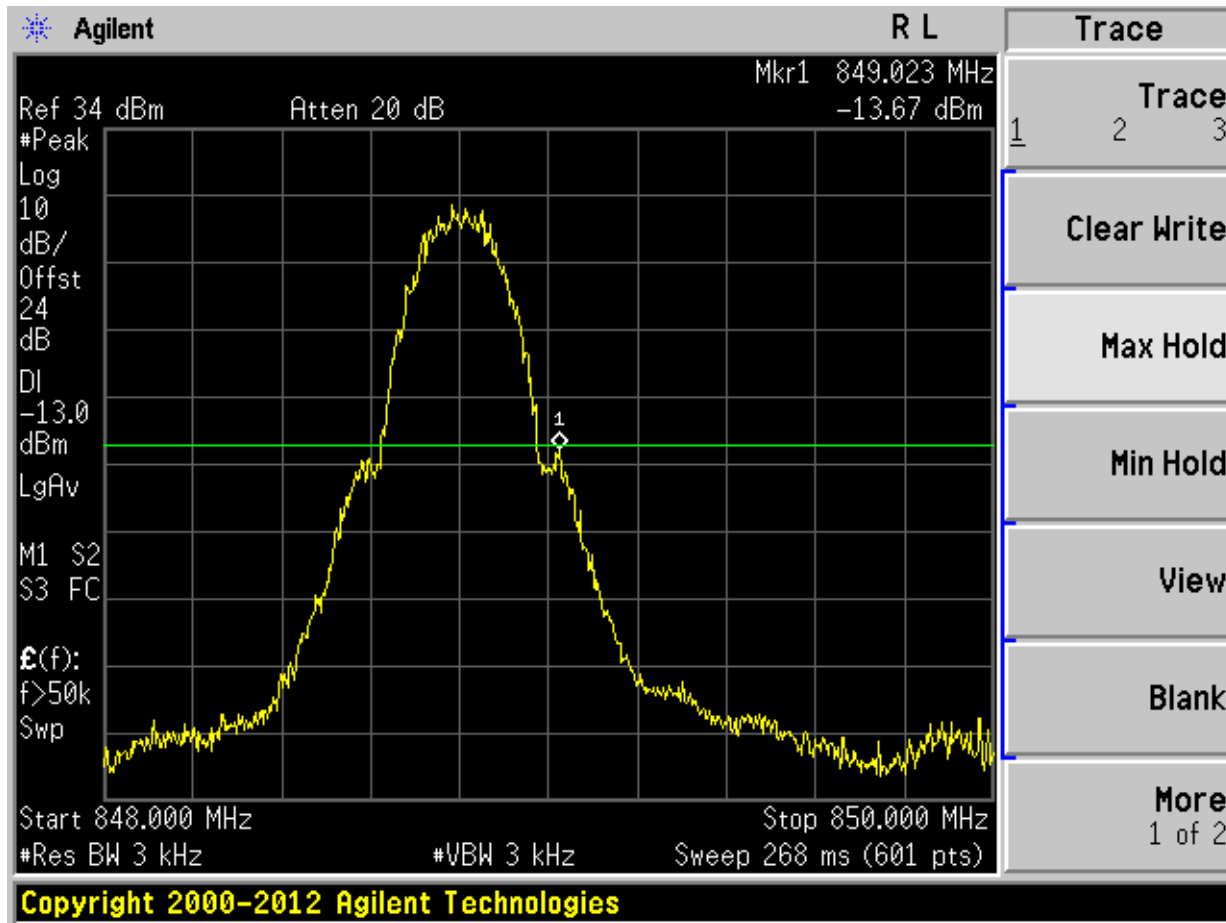

The report refers only to the sample tested and does not apply to the bulk.
 This report is issued in confidence to the client and it will be strictly treated as such by the SHENZHEN TIMEWAY TESTING LABORATORIES. It may not be reproduced rather in its entirety or in part and it may not be used for adverting. The client to whom the report is issued may, however, show or send it . or a certified copy there of prepared by the SHENZHEN TIMEWAY TESTING LABORATORIES. to his customer. Supplier or others persons directly concerned. SHENZHEN TIMEWAY TESTING LABORATORIES. will not, without the consent of the client enter into any discussion of correspondence with any third party concerning the contents of the report.
 In the event of the improper use of the report. The SHENZHEN TIMEWAY TESTING LABORATORIES. reserves the rights to withdraw it and to adopt any other remedies which may be appropriate.



Band :	GSM850	Power Stage :	High
Test Mode :	EDGE Class 8 Link		

Lower Band Edge Plot on Channel 128

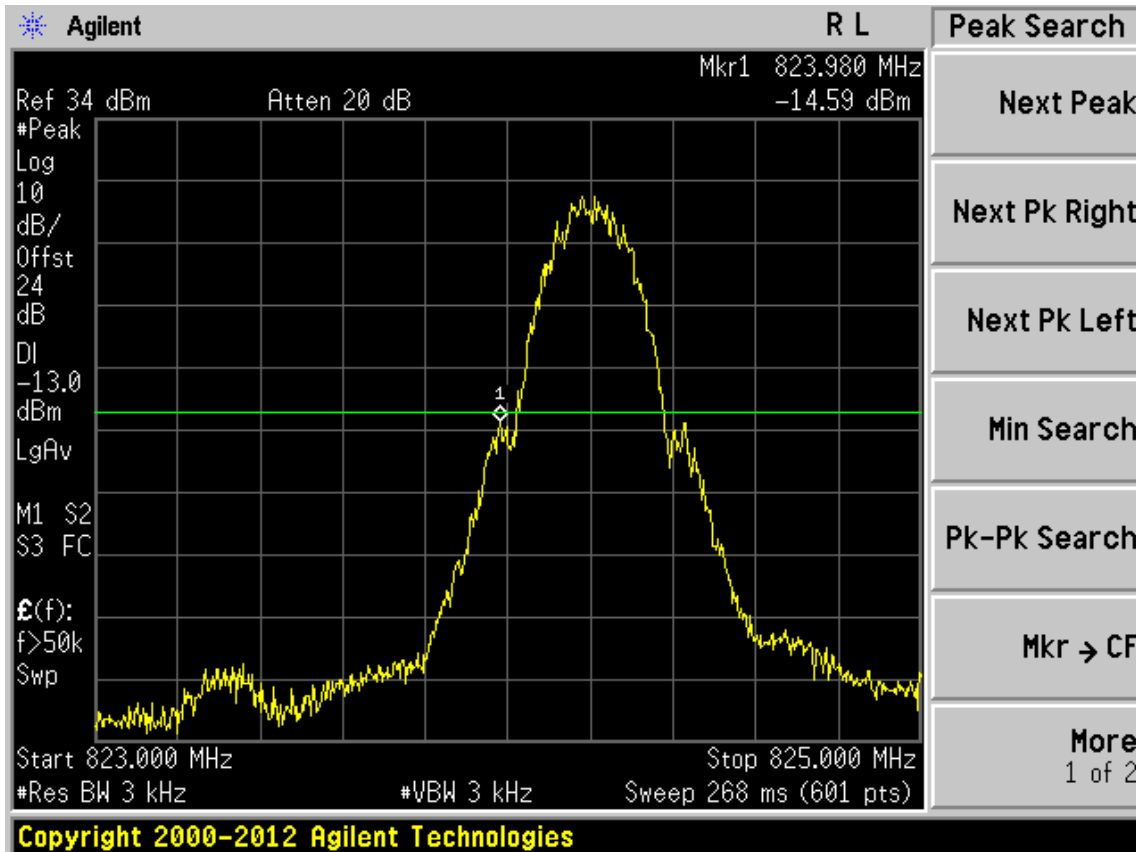

The report refers only to the sample tested and does not apply to the bulk.
 This report is issued in confidence to the client and it will be strictly treated as such by the SHENZHEN TIMEWAY TESTING LABORATORIES. It may not be reproduced rather in its entirety or in part and it may not be used for advertising. The client to whom the report is issued may, however, show or send it . or a certified copy there of prepared by the SHENZHEN TIMEWAY TESTING LABORATORIES. to his customer. Supplier or others persons directly concerned. SHENZHEN TIMEWAY TESTING LABORATORIES. will not, without the consent of the client enter into any discussion of correspondence with any third party concerning the contents of the report.
 In the event of the improper use of the report. The SHENZHEN TIMEWAY TESTING LABORATORIES. reserves the rights to withdraw it and to adopt any other remedies which may be appropriate.



Higher Band Edge Plot on Channel 251

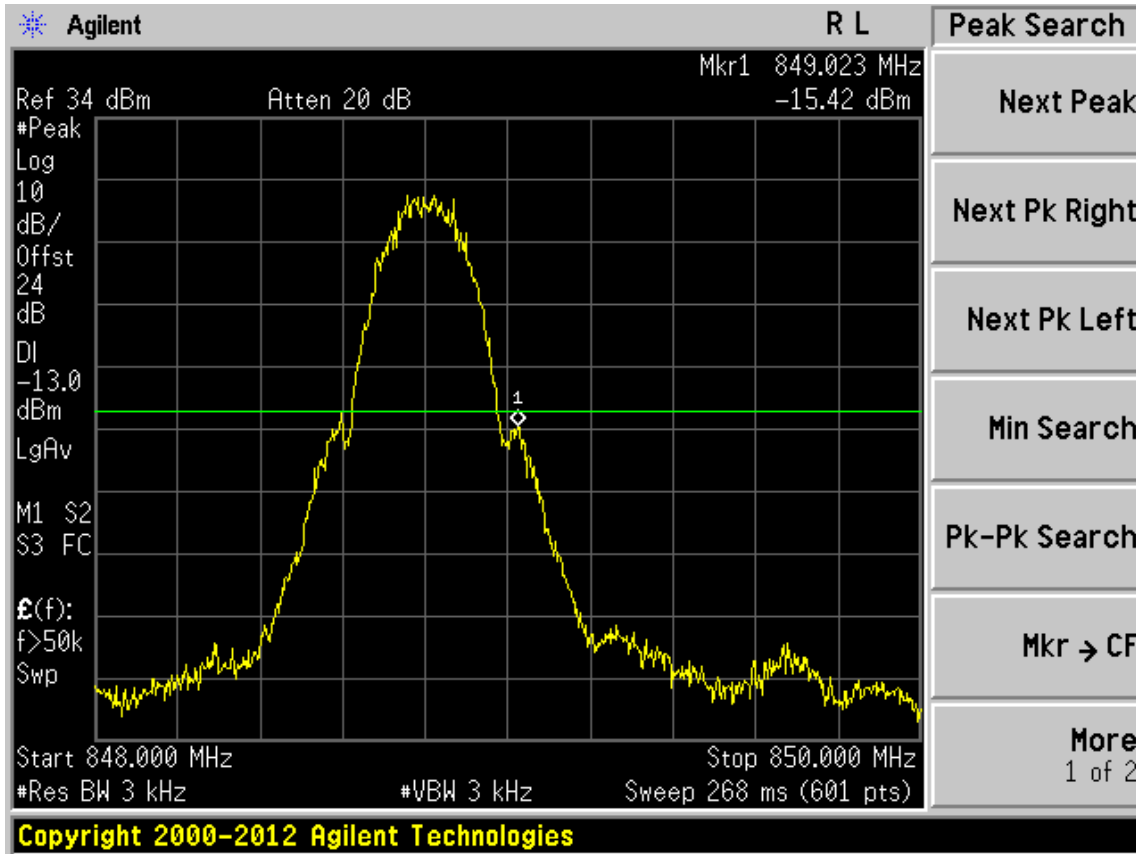

The report refers only to the sample tested and does not apply to the bulk.

This report is issued in confidence to the client and it will be strictly treated as such by the SHENZHEN TIMEWAY TESTING LABORATORIES. It may not be reproduced in its entirety or in part and it may not be used for advertising. The client to whom the report is issued may, however, show or send it or a certified copy thereof prepared by the SHENZHEN TIMEWAY TESTING LABORATORIES to his customer, Supplier or other persons directly concerned. SHENZHEN TIMEWAY TESTING LABORATORIES will not, without the consent of the client enter into any discussion of correspondence with any third party concerning the contents of the report.

In the event of the improper use of the report, the SHENZHEN TIMEWAY TESTING LABORATORIES reserves the rights to withdraw it and to adopt any other remedies which may be appropriate.



Band :	GSM1900	Power Stage :	High
Test Mode :	GSM Link		

Lower Band Edge Plot on Channel 512

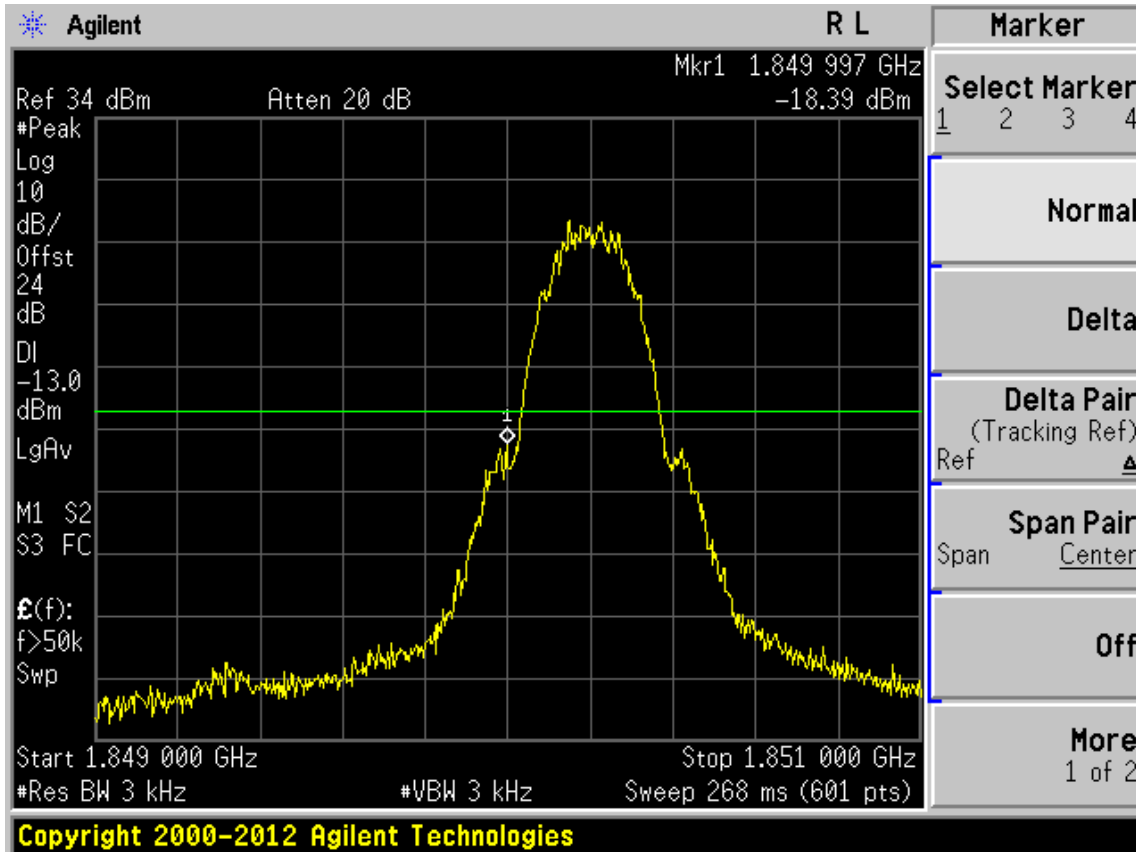

The report refers only to the sample tested and does not apply to the bulk.
 This report is issued in confidence to the client and it will be strictly treated as such by the SHENZHEN TIMEWAY TESTING LABORATORIES. It may not be reproduced rather in its entirety or in part and it may not be used for advertising. The client to whom the report is issued may, however, show or send it or a certified copy thereof prepared by the SHENZHEN TIMEWAY TESTING LABORATORIES to his customer. Supplier or others persons directly concerned. SHENZHEN TIMEWAY TESTING LABORATORIES will not, without the consent of the client enter into any discussion of correspondence with any third party concerning the contents of the report.
 In the event of the improper use of the report. The SHENZHEN TIMEWAY TESTING LABORATORIES reserves the rights to withdraw it and to adopt any other remedies which may be appropriate.



Higher Band Edge Plot on Channel 810

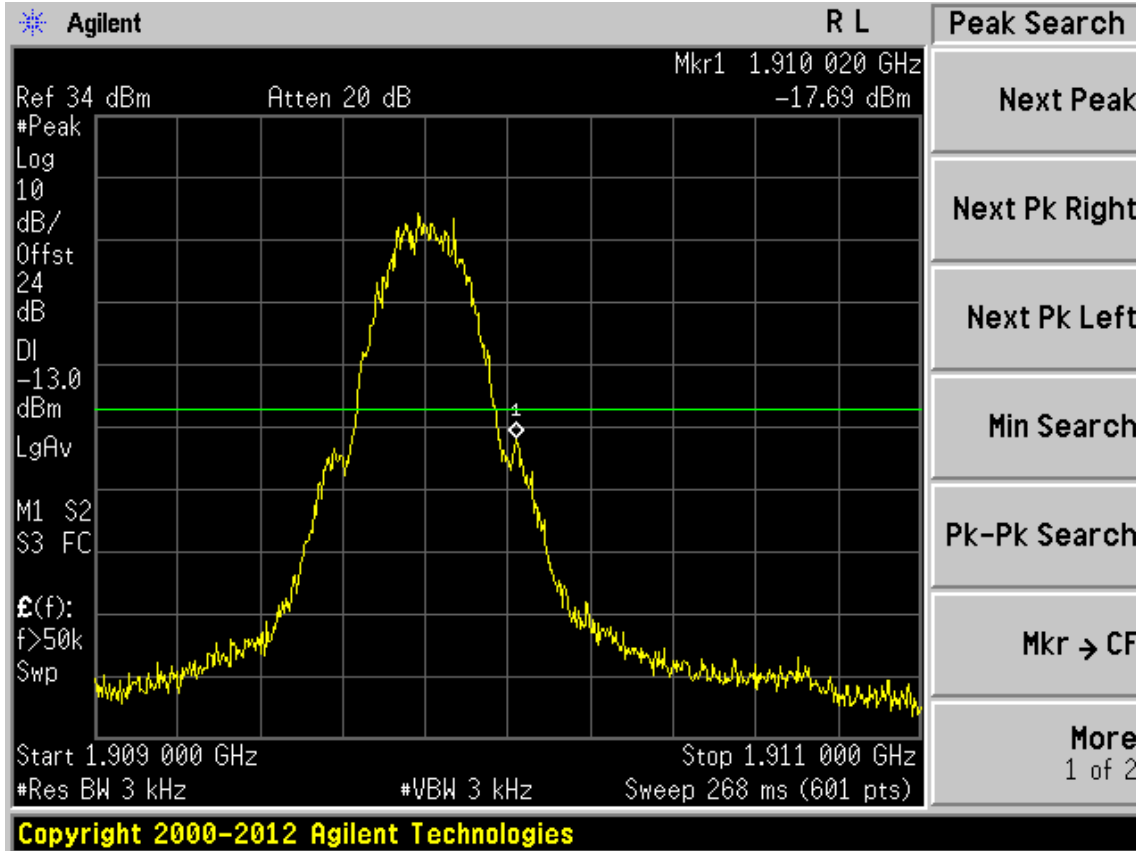

The report refers only to the sample tested and does not apply to the bulk.
 This report is issued in confidence to the client and it will be strictly treated as such by the SHENZHEN TIMEWAY TESTING LABORATORIES. It may not be reproduced in its entirety or in part and it may not be used for advertising. The client to whom the report is issued may, however, show or send it, or a certified copy thereof prepared by the SHENZHEN TIMEWAY TESTING LABORATORIES, to his customer, supplier or other persons directly concerned. SHENZHEN TIMEWAY TESTING LABORATORIES will not, without the consent of the client, enter into any discussion of correspondence with any third party concerning the contents of the report.
 In the event of the improper use of the report, the SHENZHEN TIMEWAY TESTING LABORATORIES reserves the right to withdraw it and to adopt any other remedies which may be appropriate.



Band :	GSM1900	Power Stage :	High
Test Mode :	EDGE Class 8 Link		

Lower Band Edge Plot on Channel 512

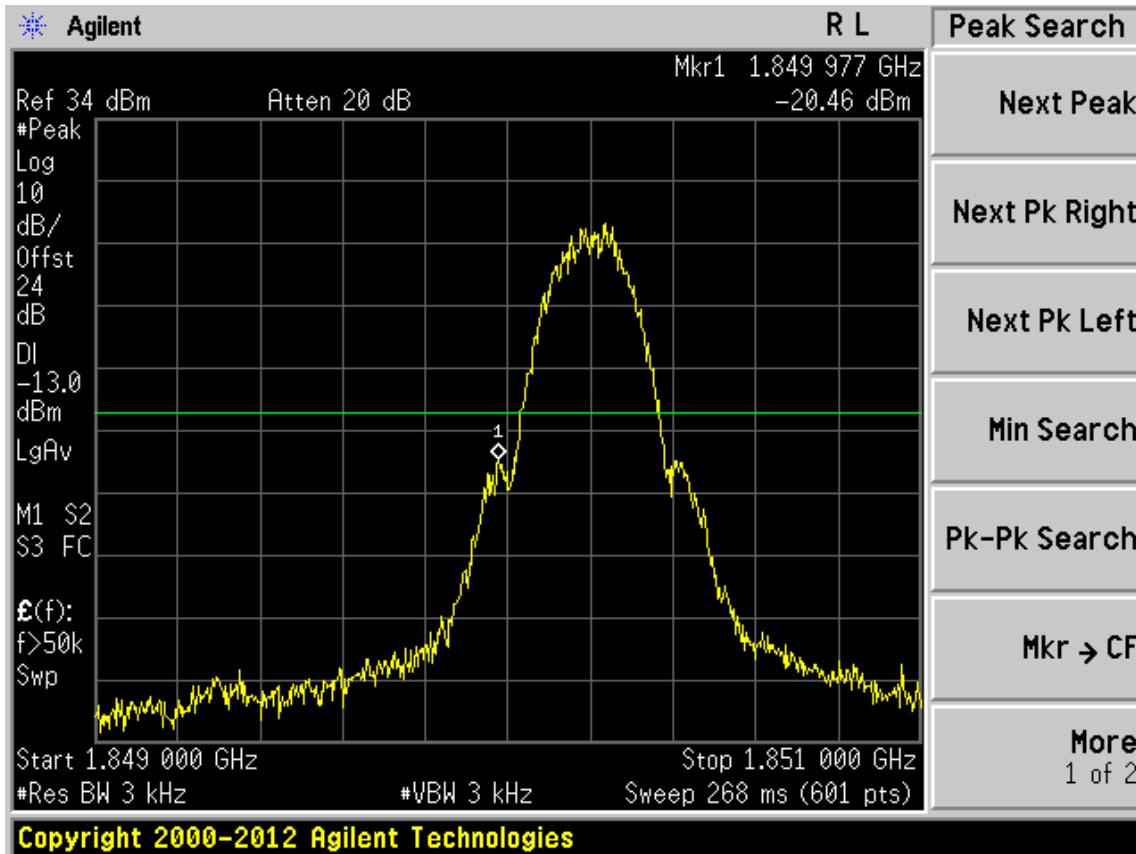

The report refers only to the sample tested and does not apply to the bulk.
 This report is issued in confidence to the client and it will be strictly treated as such by the SHENZHEN TIMEWAY TESTING LABORATORIES. It may not be reproduced rather in its entirety or in part and it may not be used for advertising. The client to whom the report is issued may, however, show or send it . or a certified copy there of prepared by the SHENZHEN TIMEWAY TESTING LABORATORIES. to his customer. Supplier or others persons directly concerned. SHENZHEN TIMEWAY TESTING LABORATORIES. will not, without the consent of the client enter into any discussion of correspondence with any third party concerning the contents of the report.
 In the event of the improper use of the report. The SHENZHEN TIMEWAY TESTING LABORATORIES. reserves the rights to withdraw it and to adopt any other remedies which may be appropriate.



Higher Band Edge Plot on Channel 810

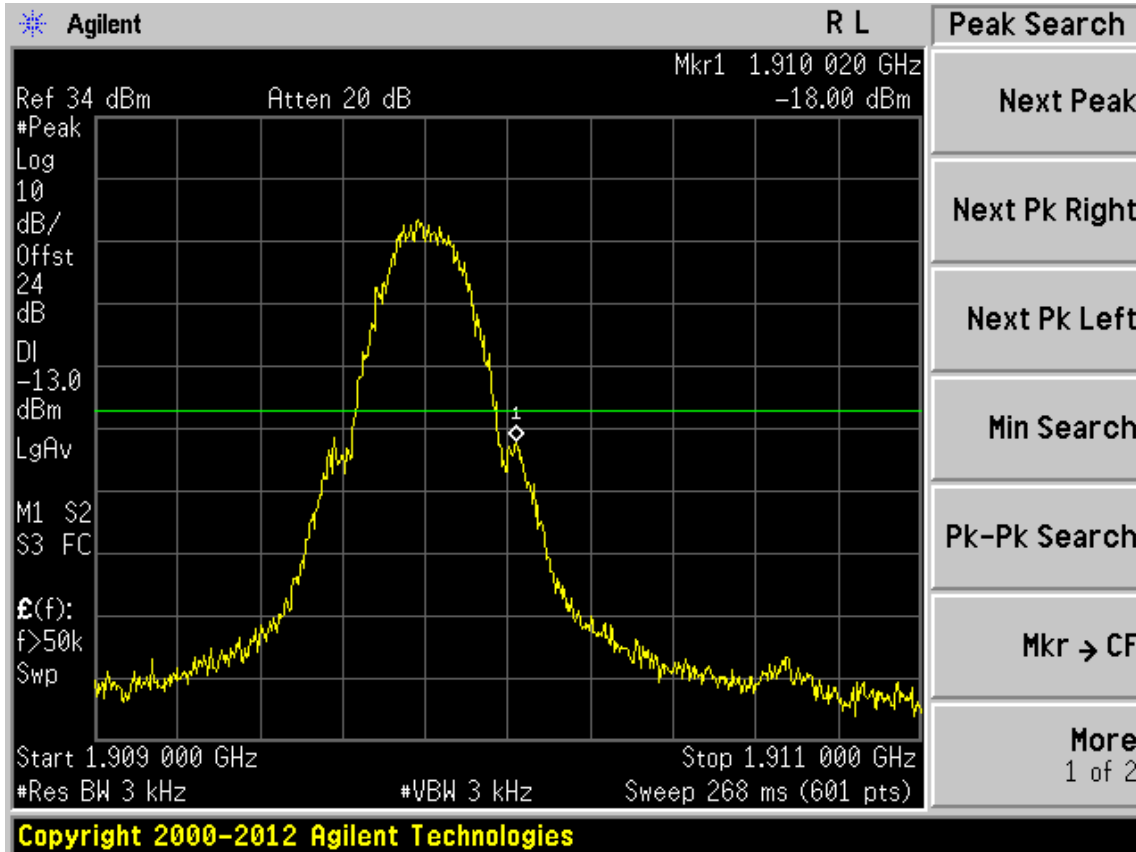

The report refers only to the sample tested and does not apply to the bulk.

This report is issued in confidence to the client and it will be strictly treated as such by the SHENZHEN TIMEWAY TESTING LABORATORIES. It may not be reproduced rather in its entirety or in part and it may not be used for advertising. The client to whom the report is issued may, however, show or send it . or a certified copy there of prepared by the SHENZHEN TIMEWAY TESTING LABORATORIES. to his customer. Supplier or others persons directly concerned. SHENZHEN TIMEWAY TESTING LABORATORIES. will not, without the consent of the client enter into any discussion of correspondence with any third party concerning the contents of the report.

In the event of the improper use of the report. The SHENZHEN TIMEWAY TESTING LABORATORIES. reserves the rights to withdraw it and to adopt any other remedies which may be appropriate.



Band :	WCDMA Band V	Power Stage :	High
Test Mode :	RMC 12.2Kbps Link		

Lower Band Edge Plot on Channel 4132

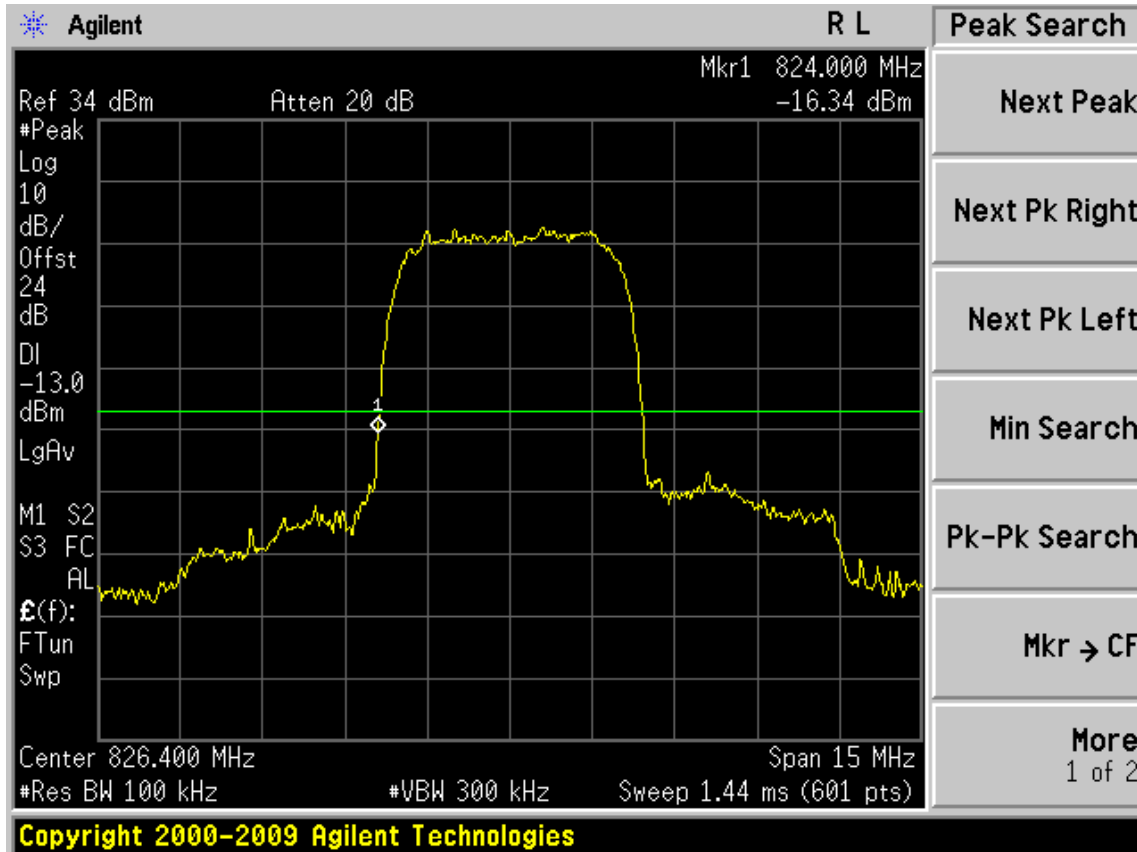

The report refers only to the sample tested and does not apply to the bulk.
 This report is issued in confidence to the client and it will be strictly treated as such by the SHENZHEN TIMEWAY TESTING LABORATORIES. It may not be reproduced rather in its entirety or in part and it may not be used for advertising. The client to whom the report is issued may, however, show or send it . or a certified copy there of prepared by the SHENZHEN TIMEWAY TESTING LABORATORIES. to his customer. Supplier or others persons directly concerned. SHENZHEN TIMEWAY TESTING LABORATORIES. will not, without the consent of the client enter into any discussion of correspondence with any third party concerning the contents of the report.
 In the event of the improper use of the report. The SHENZHEN TIMEWAY TESTING LABORATORIES. reserves the rights to withdraw it and to adopt any other remedies which may be appropriate.



Higher Band Edge Plot on Channel 4233

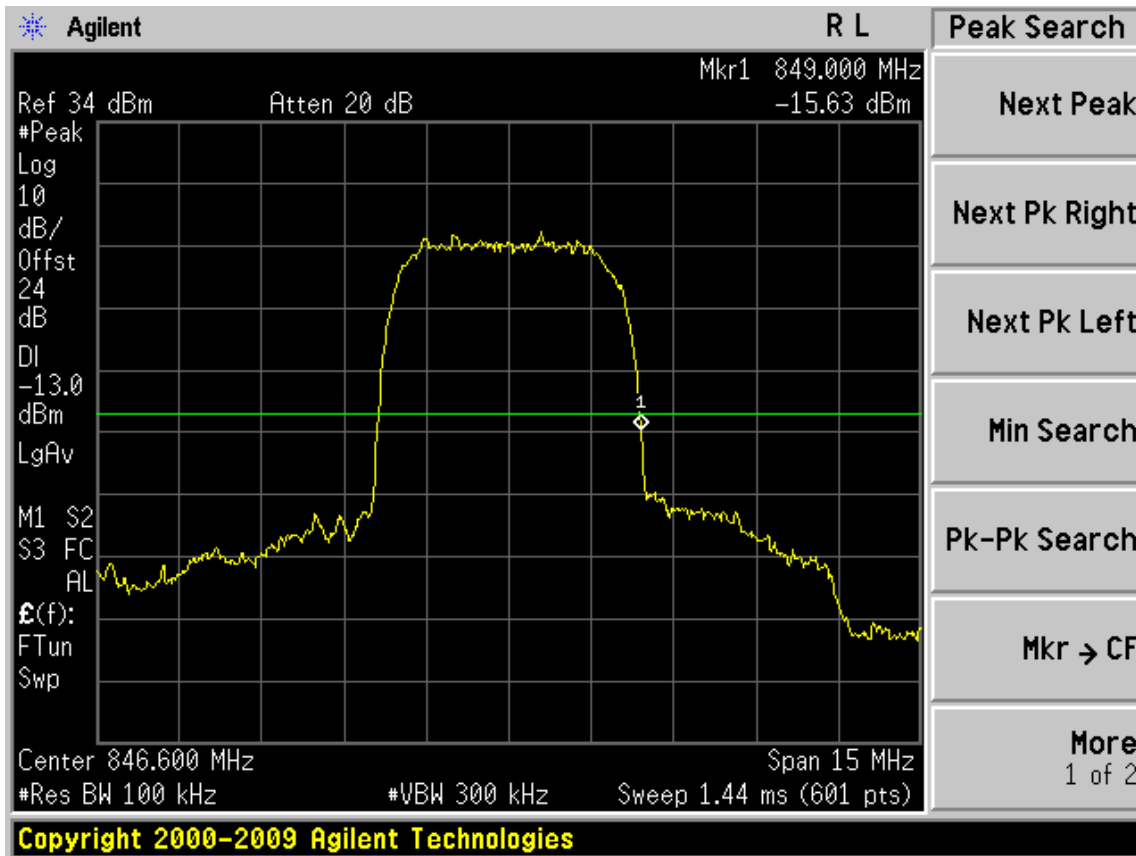

The report refers only to the sample tested and does not apply to the bulk.
 This report is issued in confidence to the client and it will be strictly treated as such by the SHENZHEN TIMEWAY TESTING LABORATORIES. It may not be reproduced in its entirety or in part and it may not be used for advertising. The client to whom the report is issued may, however, show or send it or a certified copy thereof prepared by the SHENZHEN TIMEWAY TESTING LABORATORIES to his customer. Supplier or other persons directly concerned. SHENZHEN TIMEWAY TESTING LABORATORIES will not, without the consent of the client enter into any discussion of correspondence with any third party concerning the contents of the report.
 In the event of the improper use of the report. The SHENZHEN TIMEWAY TESTING LABORATORIES reserves the rights to withdraw it and to adopt any other remedies which may be appropriate.



Band :	WCDMA Band II	Power Stage :	High
Test Mode :	RMC 12.2Kbps Link		

Lower Band Edge Plot on Channel 9262

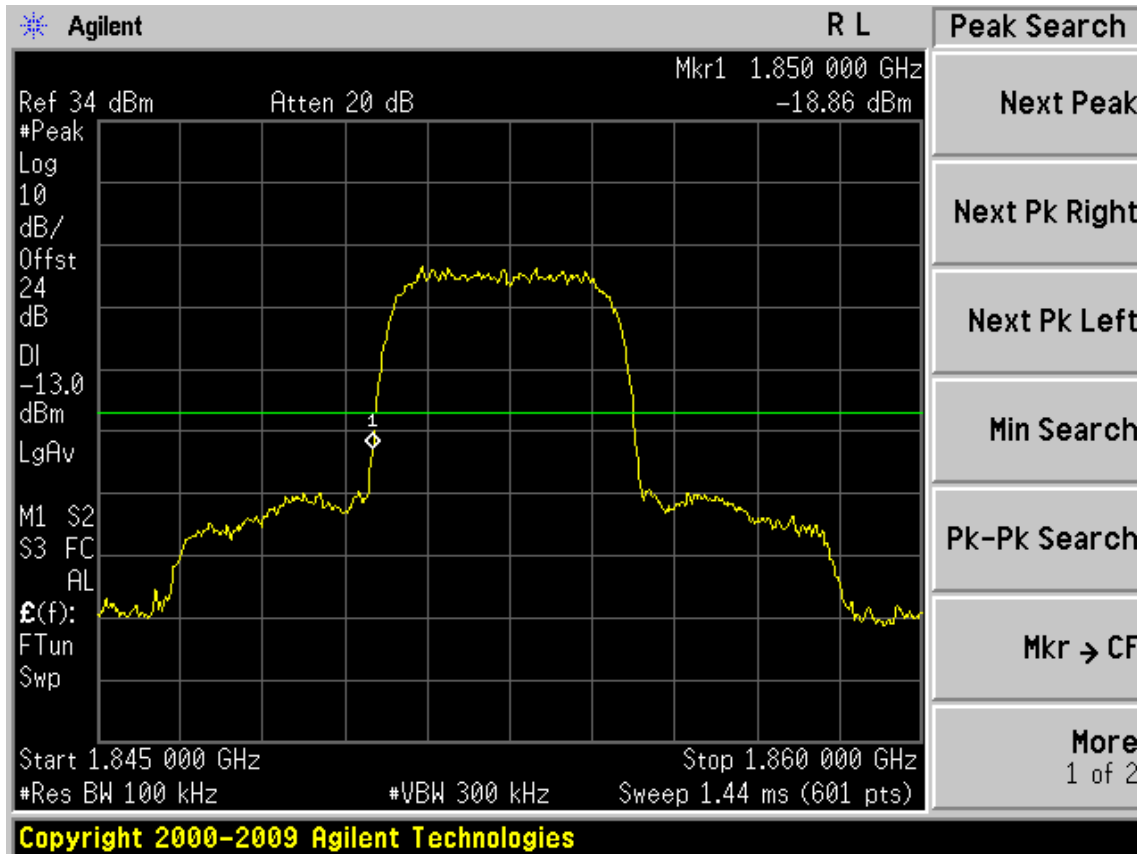

The report refers only to the sample tested and does not apply to the bulk.

This report is issued in confidence to the client and it will be strictly treated as such by the SHENZHEN TIMEWAY TESTING LABORATORIES. It may not be reproduced rather in its entirety or in part and it may not be used for advertising. The client to whom the report is issued may, however, show or send it . or a certified copy there of prepared by the SHENZHEN TIMEWAY TESTING LABORATORIES. to his customer. Supplier or others persons directly concerned. SHENZHEN TIMEWAY TESTING LABORATORIES. will not, without the consent of the client enter into any discussion of correspondence with any third party concerning the contents of the report.

In the event of the improper use of the report. The SHENZHEN TIMEWAY TESTING LABORATORIES. reserves the rights to withdraw it and to adopt any other remedies which may be appropriate.



Higher Band Edge Plot on Channel 9538

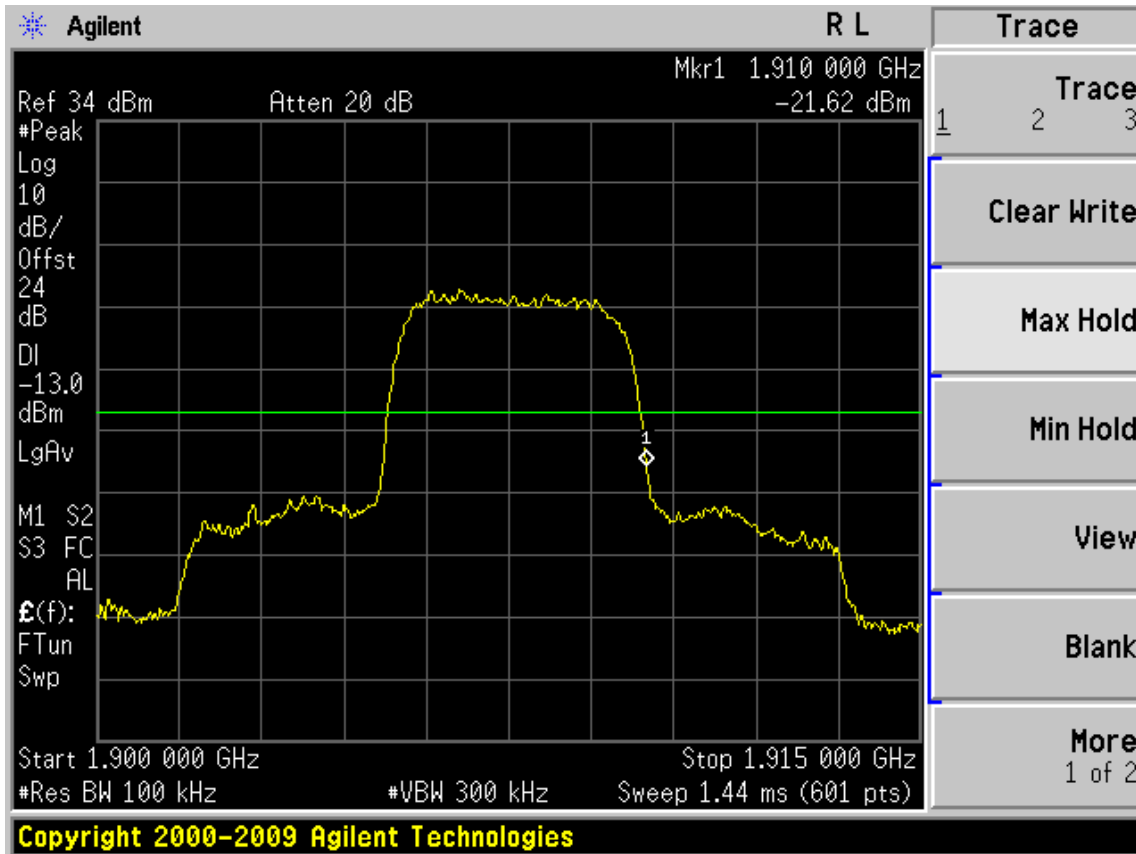

The report refers only to the sample tested and does not apply to the bulk.
 This report is issued in confidence to the client and it will be strictly treated as such by the SHENZHEN TIMEWAY TESTING LABORATORIES. It may not be reproduced in its entirety or in part and it may not be used for advertising. The client to whom the report is issued may, however, show or send it or a certified copy thereof prepared by the SHENZHEN TIMEWAY TESTING LABORATORIES to his customer. Supplier or other persons directly concerned. SHENZHEN TIMEWAY TESTING LABORATORIES will not, without the consent of the client enter into any discussion of correspondence with any third party concerning the contents of the report.
 In the event of the improper use of the report. The SHENZHEN TIMEWAY TESTING LABORATORIES reserves the rights to withdraw it and to adopt any other remedies which may be appropriate.

3.5 Conducted Emission Measurement

3.5.1 Description of Conducted Emission Measurement

The power of any emission outside of the authorized operating frequency ranges must be lower than the transmitter power (P) by a factor of at least $43 + 10 \log(P)$ dB.

It is measured by means of a calibrated spectrum analyzer and scanned from 30 MHz up to a frequency including its 10th harmonic.

3.5.2 Measuring Instruments

See list of measuring instruments of this test report.

3.5.3 Test Procedures

1. The EUT was connected to spectrum analyzer and base station via power divider.
2. The RF output of EUT was connected to the spectrum analyzer by RF cable and attenuator. The path loss was compensated to the results for each measurement.
3. The middle channel for the highest RF power within the transmitting frequency was measured.
4. The conducted spurious emission for the whole frequency range was taken.
5. The RF fundamental frequency should be excluded against the limit line in the operating frequency band.
6. The limit line is derived from $43 + 10\log(P)$ dB below the transmitter power P(Watts)

$$= P(W) - [43 + 10\log(P)] \text{ (dB)}$$

$$= [30 + 10\log(P)] \text{ (dBm)} - [43 + 10\log(P)] \text{ (dB)}$$

$$= -13\text{dBm}$$

3.5.4 Test Setup

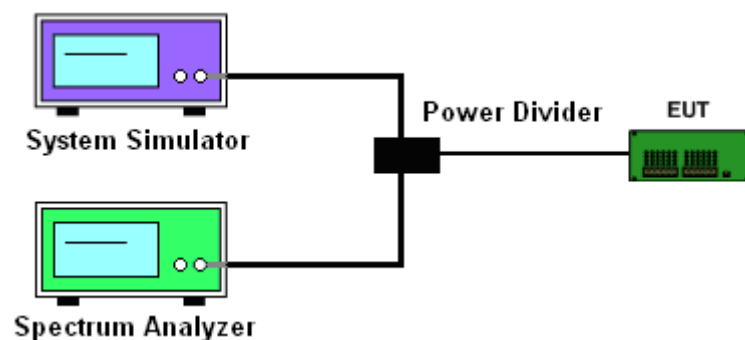

The report refers only to the sample tested and does not apply to the bulk.

This report is issued in confidence to the client and it will be strictly treated as such by the SHENZHEN TIMEWAY TESTING LABORATORIES. It may not be reproduced rather in its entirety or in part and it may not be used for advertising. The client to whom the report is issued may, however, show or send it, or a certified copy thereof prepared by the SHENZHEN TIMEWAY TESTING LABORATORIES, to his customer. Supplier or other persons directly concerned. SHENZHEN TIMEWAY TESTING LABORATORIES, will not, without the consent of the client enter into any discussion of correspondence with any third party concerning the contents of the report. In the event of the improper use of the report. The SHENZHEN TIMEWAY TESTING LABORATORIES, reserves the rights to withdraw it and to adopt any other remedies which may be appropriate.



3.5.5 Test Result (Plots) of Conducted Emission

Band :	GSM850	Channel :	CH190
Test Mode :	GSM Link		

Conducted Emission Plot between 30MHz ~ 1GHz

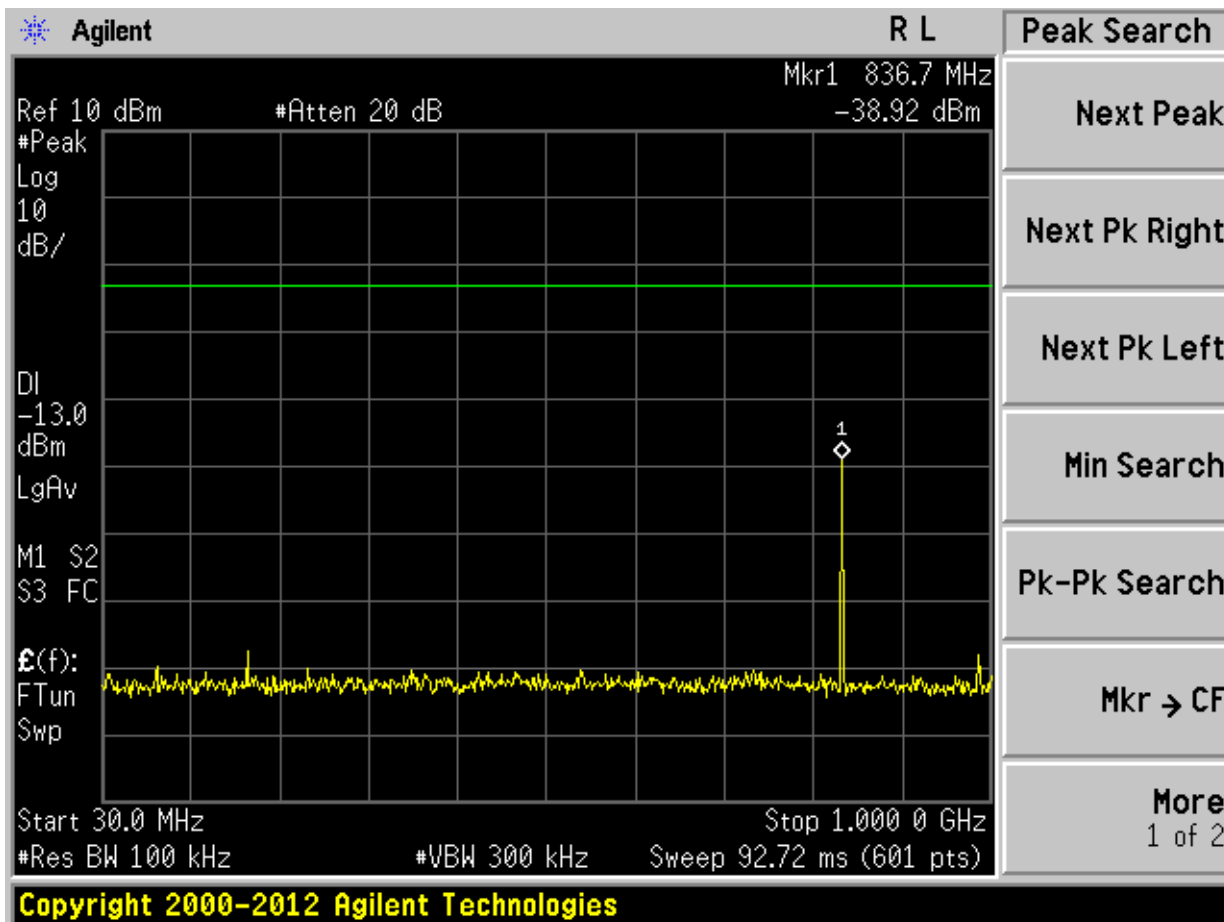

The report refers only to the sample tested and does not apply to the bulk.

This report is issued in confidence to the client and it will be strictly treated as such by the SHENZHEN TIMEWAY TESTING LABORATORIES. It may not be reproduced rather in its entirety or in part and it may not be used for advertising. The client to whom the report is issued may, however, show or send it or a certified copy thereof prepared by the SHENZHEN TIMEWAY TESTING LABORATORIES to his customer, Supplier or others persons directly concerned. SHENZHEN TIMEWAY TESTING LABORATORIES will not, without the consent of the client enter into any discussion of correspondence with any third party concerning the contents of the report.

In the event of the improper use of the report. The SHENZHEN TIMEWAY TESTING LABORATORIES reserves the rights to withdraw it and to adopt any other remedies which may be appropriate.



Conducted Emission Plot between 1GHz ~ 9GHz

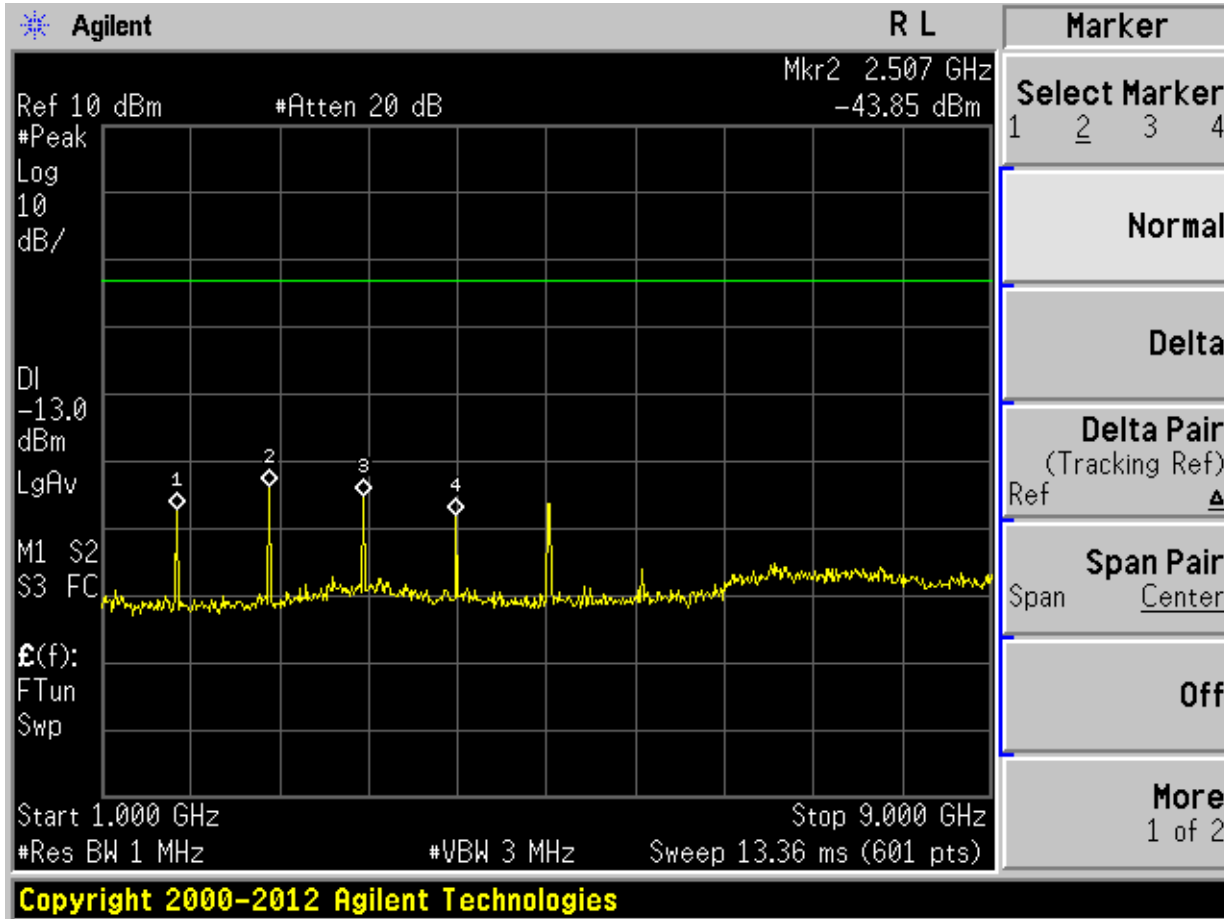

The report refers only to the sample tested and does not apply to the bulk.
 This report is issued in confidence to the client and it will be strictly treated as such by the SHENZHEN TIMEWAY TESTING LABORATORIES. It may not be reproduced rather in its entirety or in part and it may not be used for advertising. The client to whom the report is issued may, however, show or send it . or a certified copy there of prepared by the SHENZHEN TIMEWAY TESTING LABORATORIES. to his customer. Supplier or others persons directly concerned. SHENZHEN TIMEWAY TESTING LABORATORIES. will not, without the consent of the client enter into any discussion of correspondence with any third party concerning the contents of the report.
 In the event of the improper use of the report. The SHENZHEN TIMEWAY TESTING LABORATORIES. reserves the rights to withdraw it and to adopt any other remedies which may be appropriate.



Band :	GSM850	Channel :	CH190
Test Mode :	EDGE Class 8 Link		

Conducted Emission Plot between 30MHz ~ 1GHz

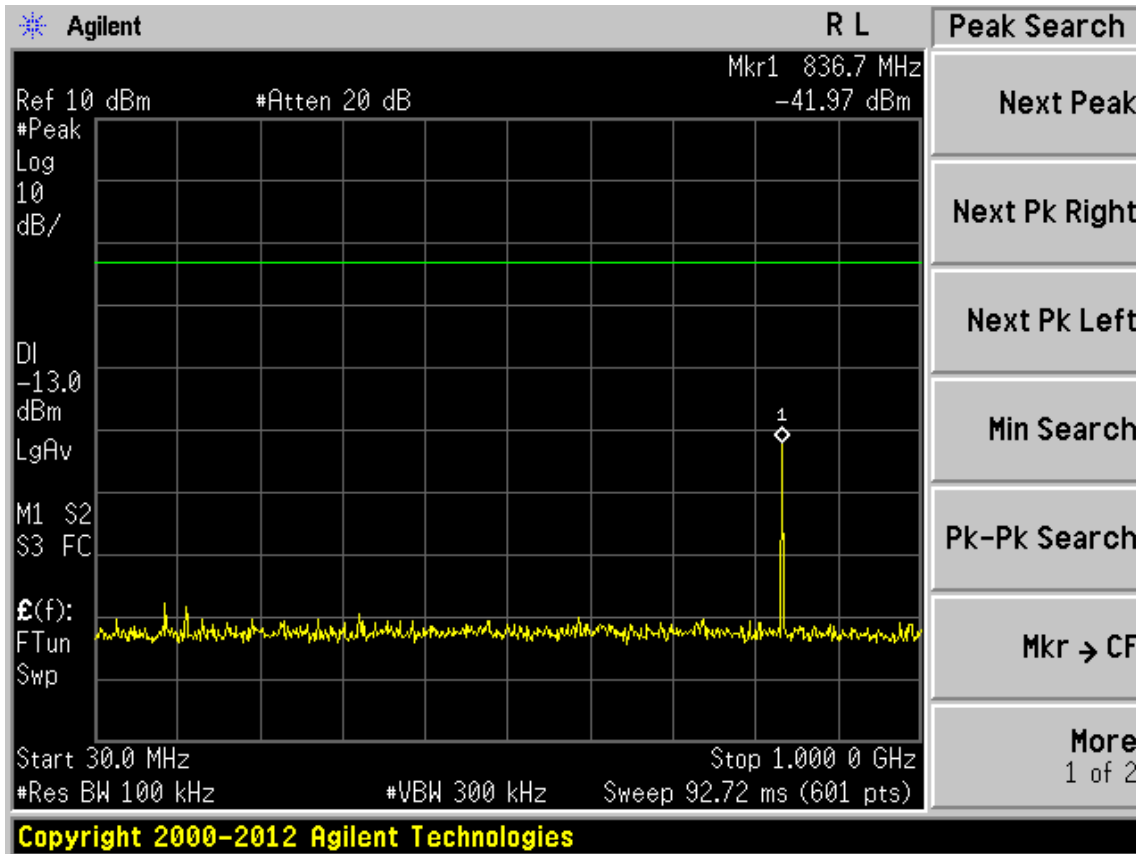

The report refers only to the sample tested and does not apply to the bulk.
 This report is issued in confidence to the client and it will be strictly treated as such by the SHENZHEN TIMEWAY TESTING LABORATORIES. It may not be reproduced in its entirety or in part and it may not be used for advertising. The client to whom the report is issued may, however, show or send it, or a certified copy thereof prepared by the SHENZHEN TIMEWAY TESTING LABORATORIES, to his customer. Supplier or other persons directly concerned. SHENZHEN TIMEWAY TESTING LABORATORIES. will not, without the consent of the client enter into any discussion of correspondence with any third party concerning the contents of the report.
 In the event of the improper use of the report. The SHENZHEN TIMEWAY TESTING LABORATORIES. reserves the rights to withdraw it and to adopt any other remedies which may be appropriate.



Conducted Emission Plot between 1GHz ~ 9GHz

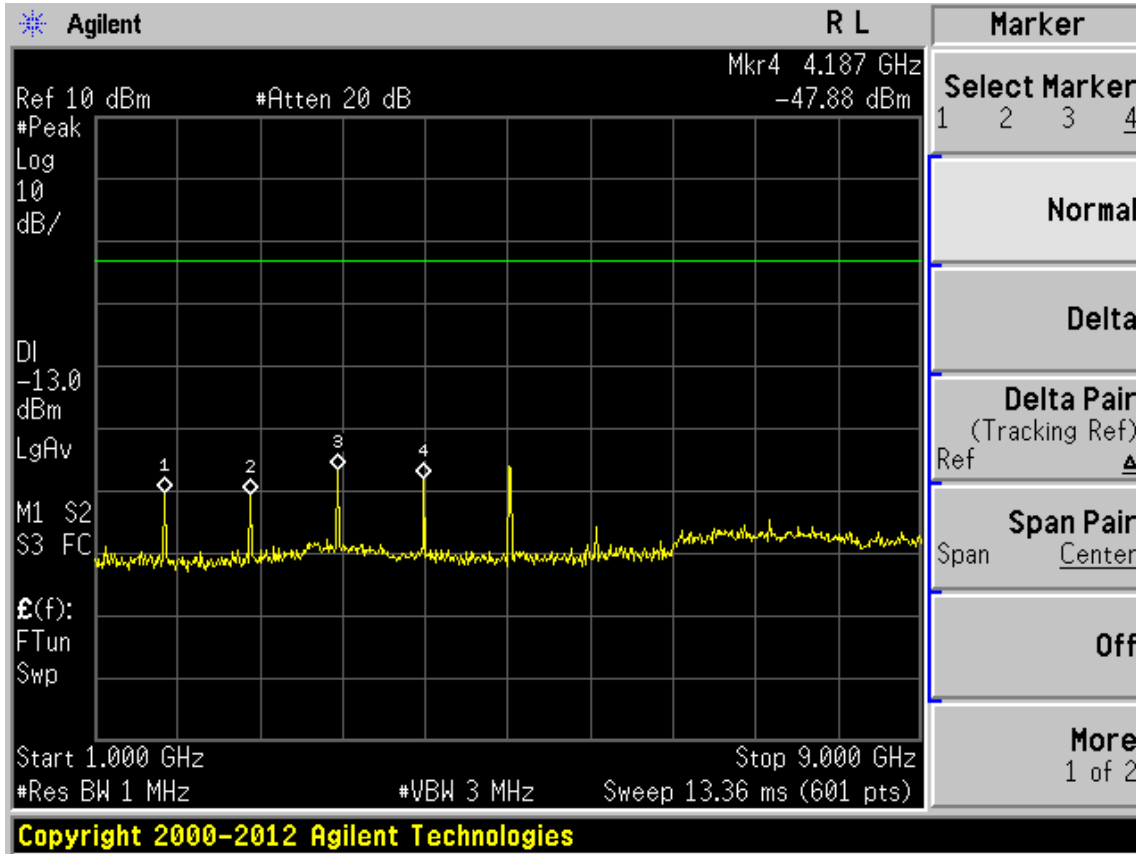

The report refers only to the sample tested and does not apply to the bulk.
 This report is issued in confidence to the client and it will be strictly treated as such by the SHENZHEN TIMEWAY TESTING LABORATORIES. It may not be reproduced in its entirety or in part and it may not be used for advertising. The client to whom the report is issued may, however, show or send it, or a certified copy thereof prepared by the SHENZHEN TIMEWAY TESTING LABORATORIES, to his customer. Supplier or other persons directly concerned. SHENZHEN TIMEWAY TESTING LABORATORIES will not, without the consent of the client enter into any discussion of correspondence with any third party concerning the contents of the report.
 In the event of the improper use of the report, The SHENZHEN TIMEWAY TESTING LABORATORIES reserves the rights to withdraw it and to adopt any other remedies which may be appropriate.



Band :	GSM1900	Channel :	CH661
Test Mode :	GSM Link		

Conducted Emission Plot between 30MHz ~ 1GHz

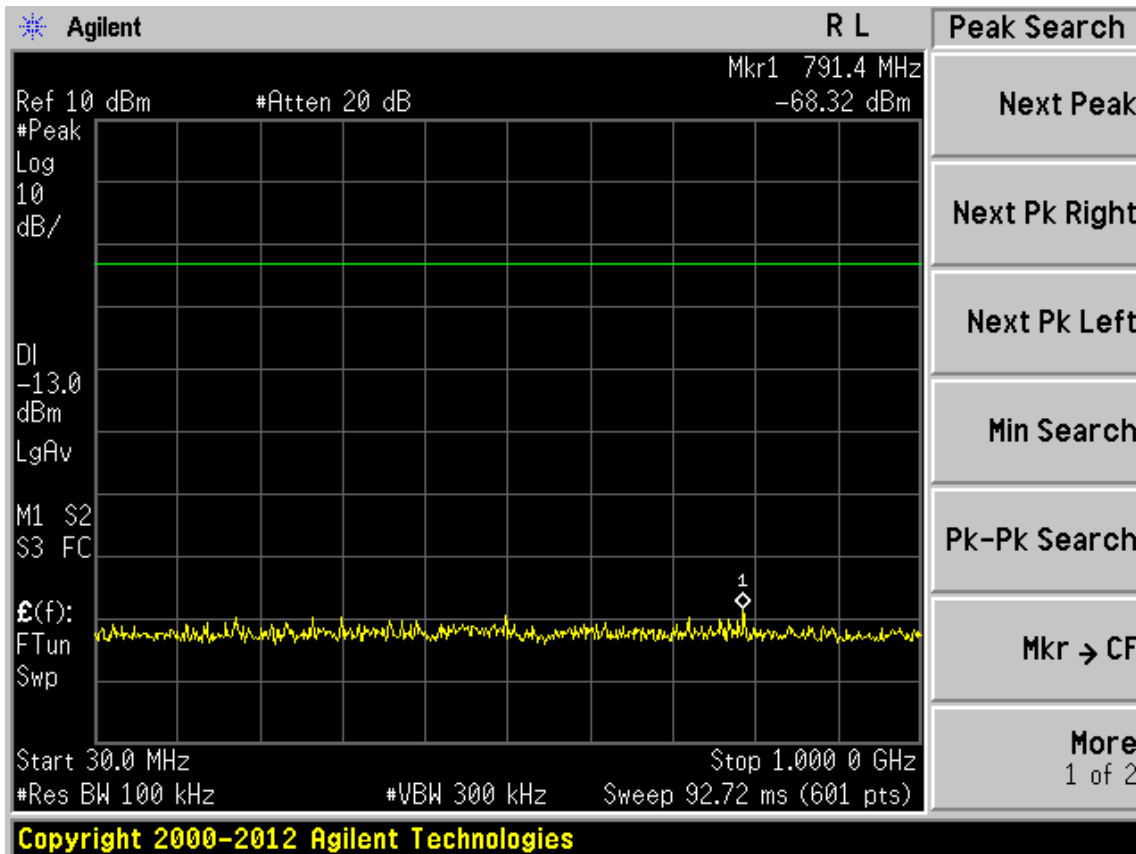

The report refers only to the sample tested and does not apply to the bulk.
 This report is issued in confidence to the client and it will be strictly treated as such by the SHENZHEN TIMEWAY TESTING LABORATORIES. It may not be reproduced rather in its entirety or in part and it may not be used for advertising. The client to whom the report is issued may, however, show or send it . or a certified copy there of prepared by the SHENZHEN TIMEWAY TESTING LABORATORIES. to his customer. Supplier or others persons directly concerned. SHENZHEN TIMEWAY TESTING LABORATORIES. will not, without the consent of the client enter into any discussion of correspondence with any third party concerning the contents of the report.
 In the event of the improper use of the report. The SHENZHEN TIMEWAY TESTING LABORATORIES. reserves the rights to withdraw it and to adopt any other remedies which may be appropriate.



Conducted Emission Plot between 1GHz ~ 20GHz

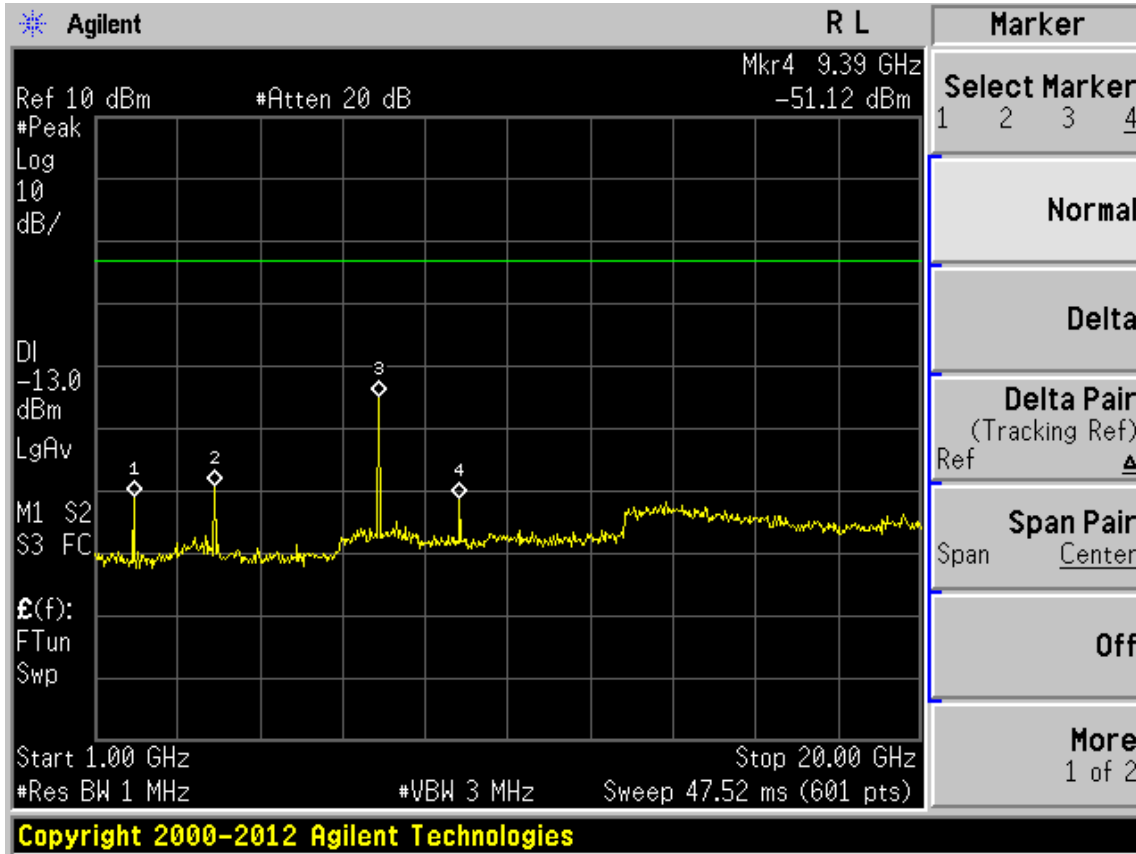

The report refers only to the sample tested and does not apply to the bulk.
 This report is issued in confidence to the client and it will be strictly treated as such by the SHENZHEN TIMEWAY TESTING LABORATORIES. It may not be reproduced in its entirety or in part and it may not be used for advertising. The client to whom the report is issued may, however, show or send it, or a certified copy thereof prepared by the SHENZHEN TIMEWAY TESTING LABORATORIES, to his customer. Supplier or other persons directly concerned. SHENZHEN TIMEWAY TESTING LABORATORIES will not, without the consent of the client enter into any discussion of correspondence with any third party concerning the contents of the report.
 In the event of the improper use of the report, The SHENZHEN TIMEWAY TESTING LABORATORIES reserves the rights to withdraw it and to adopt any other remedies which may be appropriate.



Band :	GSM1900	Channel :	CH661
Test Mode :	EDGE Class 8 Link		

Conducted Emission Plot between 30MHz ~ 1GHz

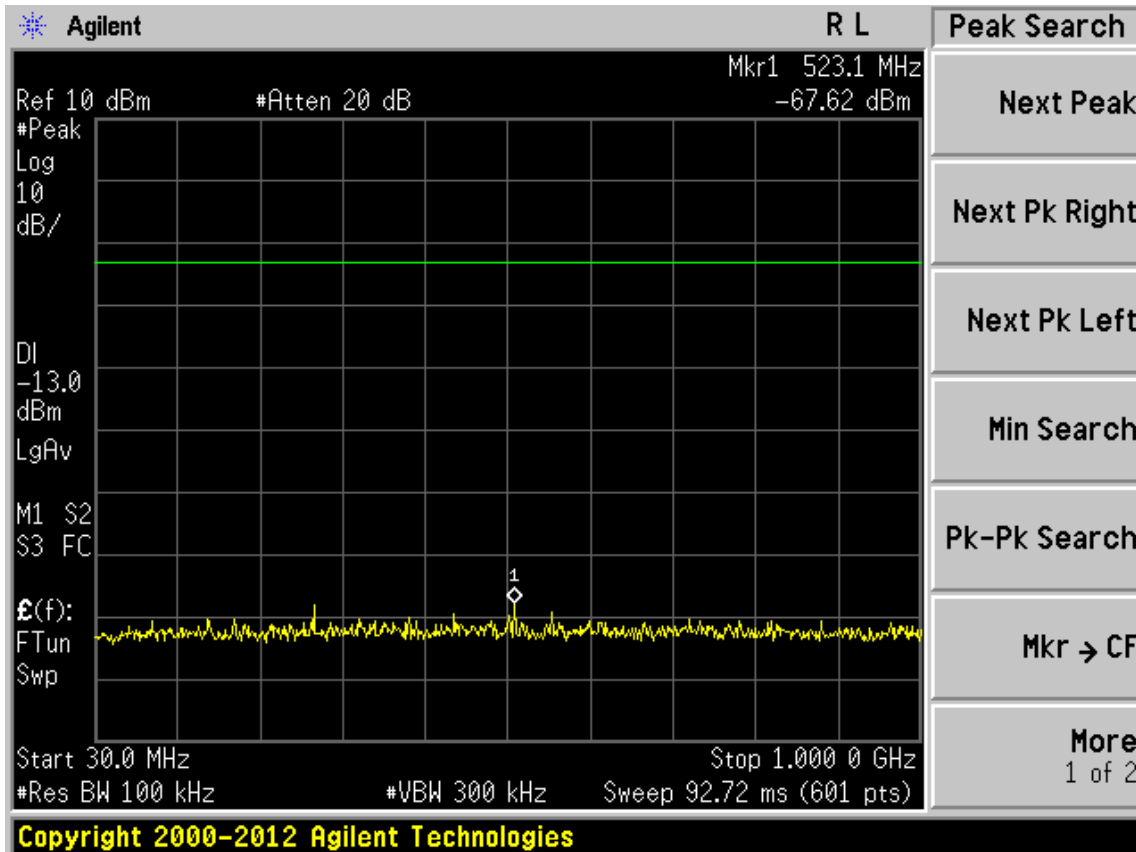

The report refers only to the sample tested and does not apply to the bulk. This report is issued in confidence to the client and it will be strictly treated as such by the SHENZHEN TIMEWAY TESTING LABORATORIES. It may not be reproduced in its entirety or in part and it may not be used for advertising. The client to whom the report is issued may, however, show or send it or a certified copy thereof prepared by the SHENZHEN TIMEWAY TESTING LABORATORIES to his customer. Supplier or others persons directly concerned. SHENZHEN TIMEWAY TESTING LABORATORIES will not, without the consent of the client enter into any discussion of correspondence with any third party concerning the contents of the report. In the event of the improper use of the report. The SHENZHEN TIMEWAY TESTING LABORATORIES reserves the rights to withdraw it and to adopt any other remedies which may be appropriate.



Conducted Emission Plot between 1GHz ~ 20GHz

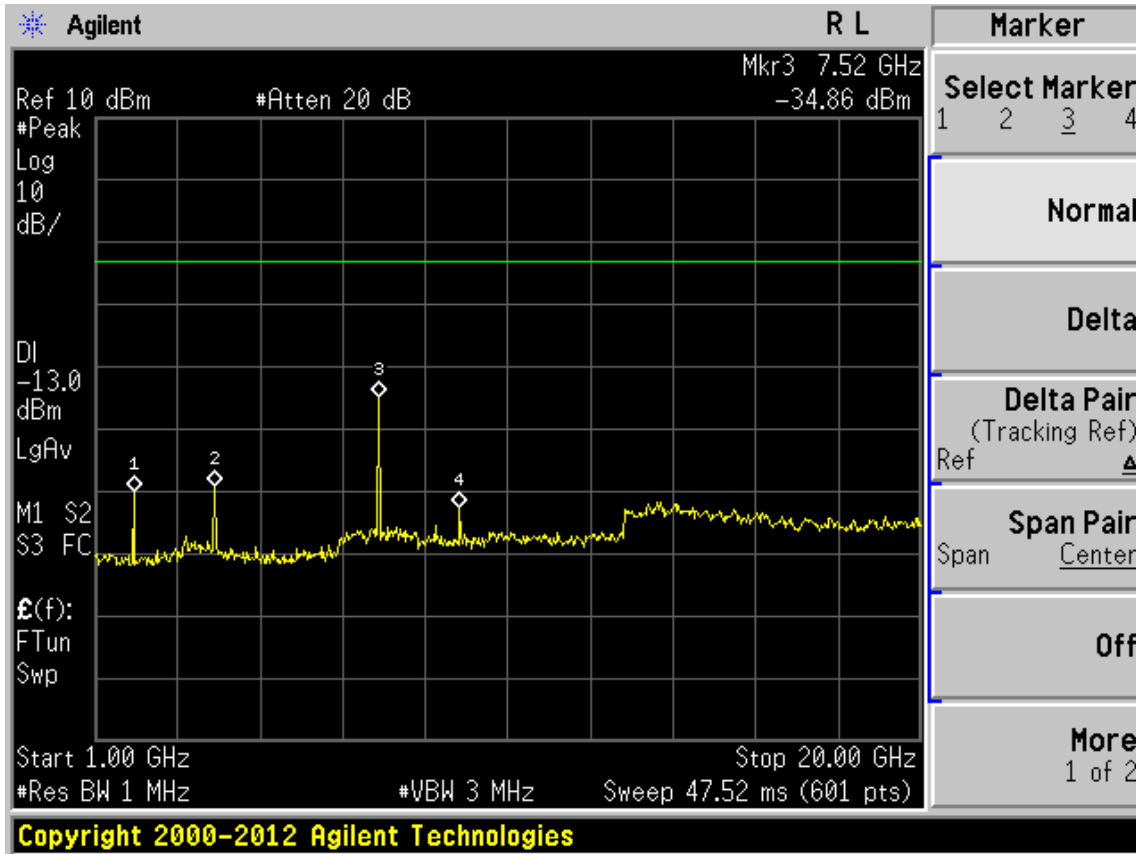

The report refers only to the sample tested and does not apply to the bulk.
 This report is issued in confidence to the client and it will be strictly treated as such by the SHENZHEN TIMEWAY TESTING LABORATORIES. It may not be reproduced in its entirety or in part and it may not be used for advertising. The client to whom the report is issued may, however, show or send it, or a certified copy thereof prepared by the SHENZHEN TIMEWAY TESTING LABORATORIES, to his customer. Supplier or others persons directly concerned. SHENZHEN TIMEWAY TESTING LABORATORIES will not, without the consent of the client enter into any discussion of correspondence with any third party concerning the contents of the report.
 In the event of the improper use of the report. The SHENZHEN TIMEWAY TESTING LABORATORIES reserves the rights to withdraw it and to adopt any other remedies which may be appropriate.



Band :	WCDMA Band V	Channel :	CH4183
Test Mode :	RMC 12.2Kbps Link		

Conducted Emission Plot between 30MHz ~ 1GHz

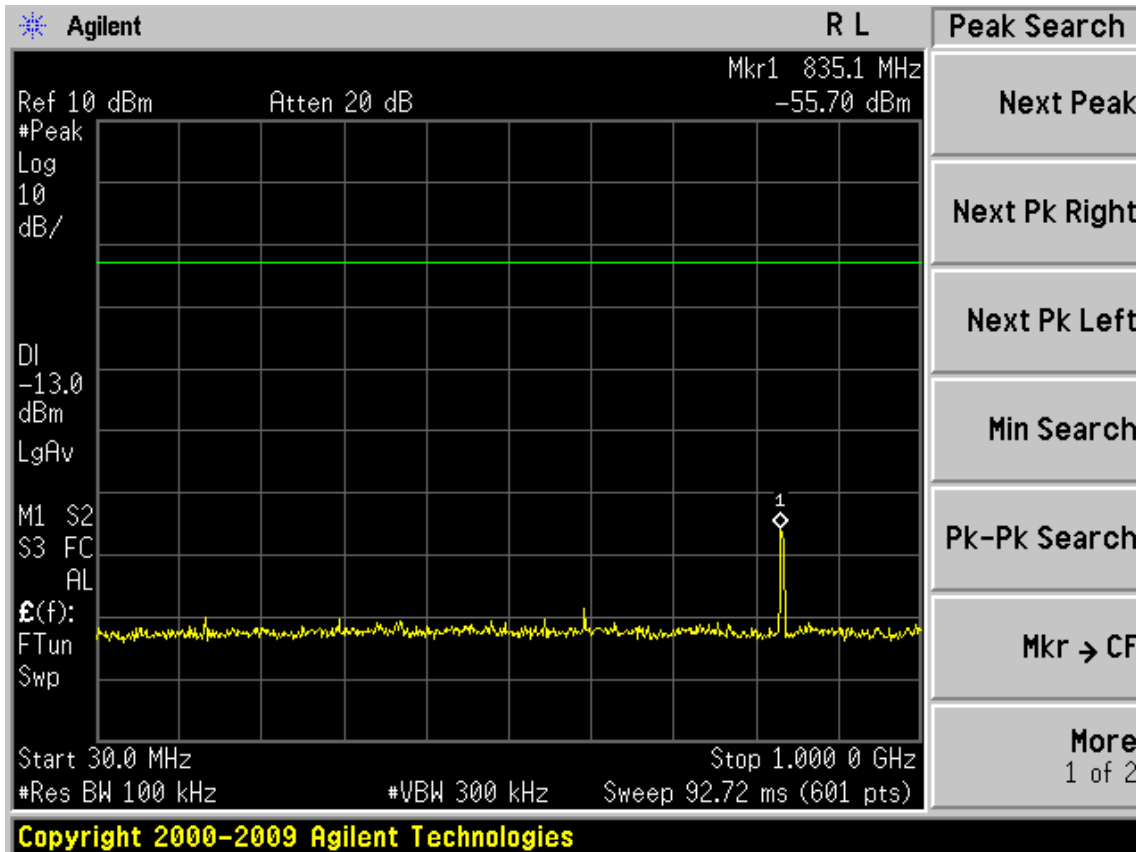

The report refers only to the sample tested and does not apply to the bulk. This report is issued in confidence to the client and it will be strictly treated as such by the SHENZHEN TIMEWAY TESTING LABORATORIES. It may not be reproduced in its entirety or in part and it may not be used for advertising. The client to whom the report is issued may, however, show or send it or a certified copy thereof prepared by the SHENZHEN TIMEWAY TESTING LABORATORIES to his customer. Supplier or other persons directly concerned. SHENZHEN TIMEWAY TESTING LABORATORIES will not, without the consent of the client enter into any discussion of correspondence with any third party concerning the contents of the report. In the event of the improper use of the report. The SHENZHEN TIMEWAY TESTING LABORATORIES reserves the rights to withdraw it and to adopt any other remedies which may be appropriate.



Conducted Emission Plot between 1GHz ~ 9GHz

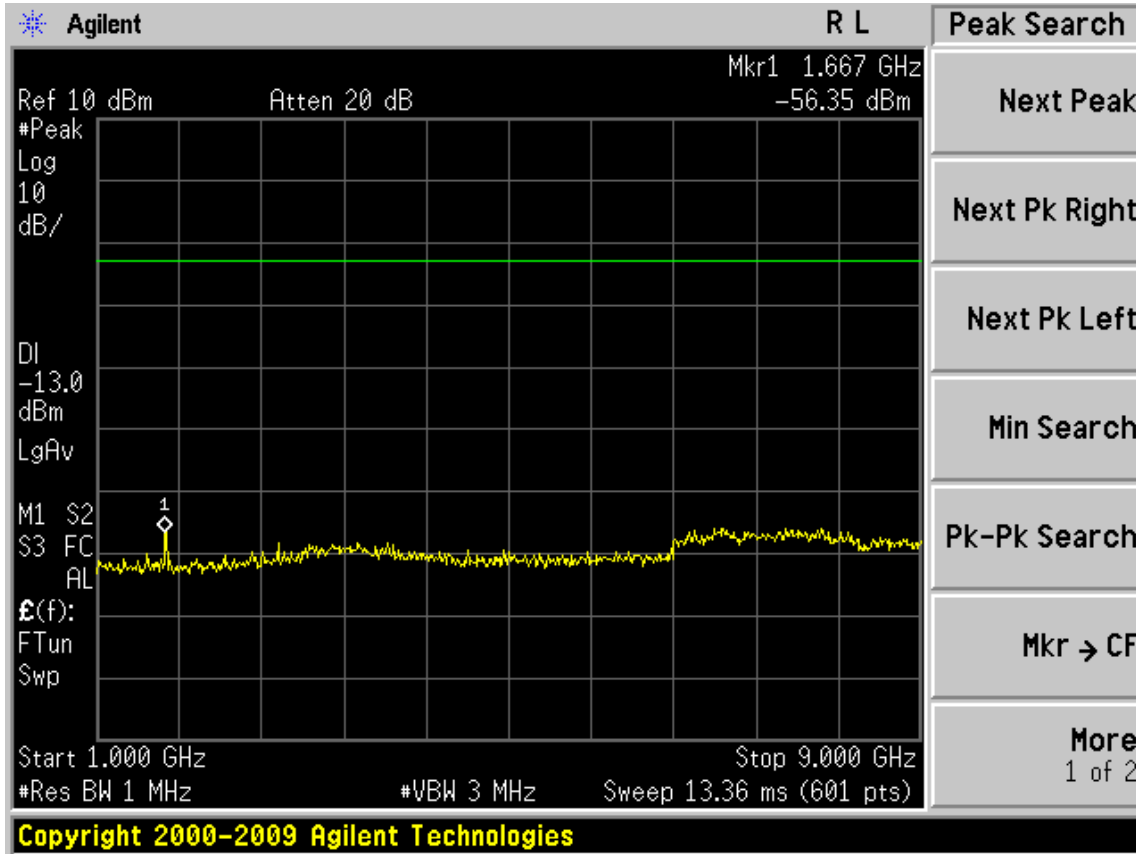

The report refers only to the sample tested and does not apply to the bulk.
 This report is issued in confidence to the client and it will be strictly treated as such by the SHENZHEN TIMEWAY TESTING LABORATORIES. It may not be reproduced in its entirety or in part and it may not be used for advertising. The client to whom the report is issued may, however, show or send it, or a certified copy thereof prepared by the SHENZHEN TIMEWAY TESTING LABORATORIES, to his customer. Supplier or other persons directly concerned. SHENZHEN TIMEWAY TESTING LABORATORIES. will not, without the consent of the client enter into any discussion of correspondence with any third party concerning the contents of the report.
 In the event of the improper use of the report. The SHENZHEN TIMEWAY TESTING LABORATORIES. reserves the rights to withdraw it and to adopt any other remedies which may be appropriate.



Band :	WCDMA Band II	Channel :	CH9400
Test Mode :	RMC 12.2Kbps Link		

Conducted Emission Plot between 30MHz ~ 1GHz

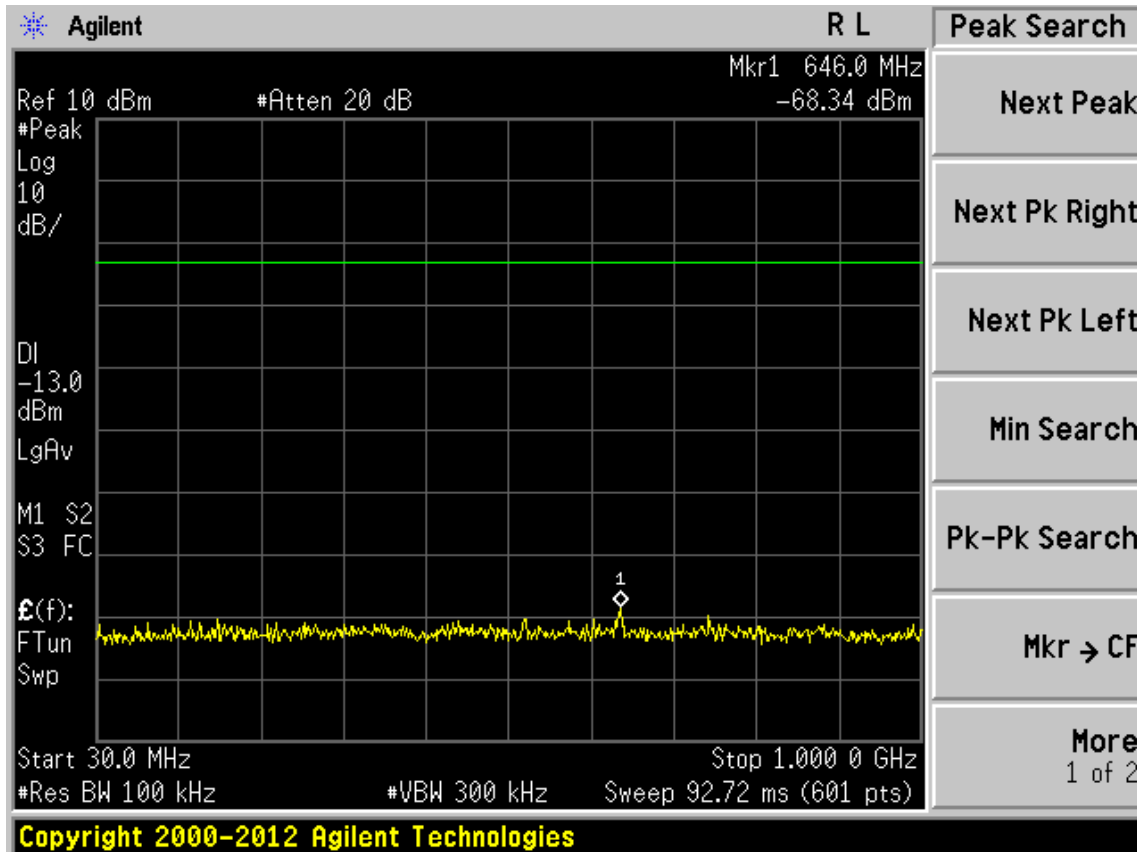

The report refers only to the sample tested and does not apply to the bulk. This report is issued in confidence to the client and it will be strictly treated as such by the SHENZHEN TIMEWAY TESTING LABORATORIES. It may not be reproduced rather in its entirety or in part and it may not be used for advertising. The client to whom the report is issued may, however, show or send it . or a certified copy there of prepared by the SHENZHEN TIMEWAY TESTING LABORATORIES. to his customer. Supplier or others persons directly concerned. SHENZHEN TIMEWAY TESTING LABORATORIES. will not, without the consent of the client enter into any discussion of correspondence with any third party concerning the contents of the report. In the event of the improper use of the report. The SHENZHEN TIMEWAY TESTING LABORATORIES. reserves the rights to withdraw it and to adopt any other remedies which may be appropriate.



Conducted Emission Plot between 1GHz ~ 20GHz

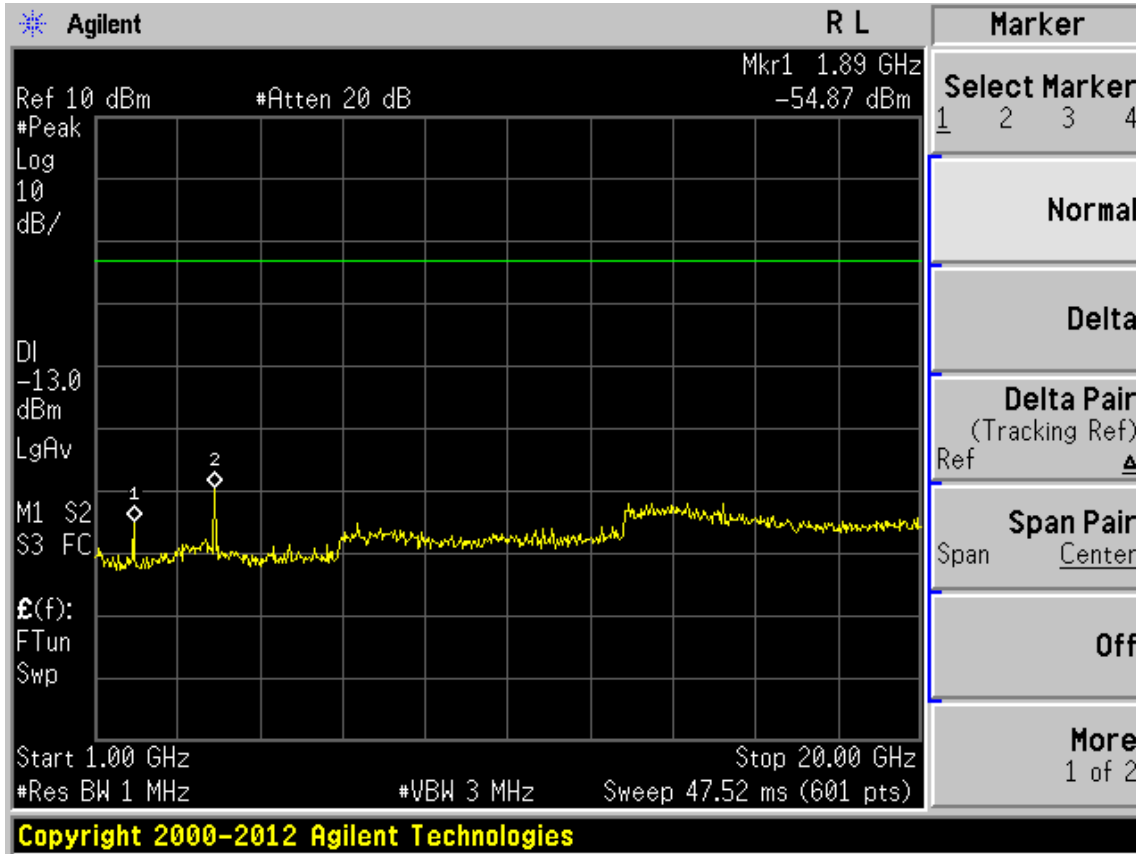

The report refers only to the sample tested and does not apply to the bulk.
 This report is issued in confidence to the client and it will be strictly treated as such by the SHENZHEN TIMEWAY TESTING LABORATORIES. It may not be reproduced in its entirety or in part and it may not be used for advertising. The client to whom the report is issued may, however, show or send it, or a certified copy thereof prepared by the SHENZHEN TIMEWAY TESTING LABORATORIES, to his customer. Supplier or other persons directly concerned. SHENZHEN TIMEWAY TESTING LABORATORIES will not, without the consent of the client enter into any discussion of correspondence with any third party concerning the contents of the report.
 In the event of the improper use of the report, The SHENZHEN TIMEWAY TESTING LABORATORIES reserves the rights to withdraw it and to adopt any other remedies which may be appropriate.



3.6 Field Strength of Spurious Radiation Measurement

3.6.1 Description of Field Strength of Spurious Radiated Measurement

The power of any emission outside of the authorized operating frequency ranges must be attenuated below the transmitter power (P) by a factor of at least $43 + 10 \log (P)$ dB. The spectrum is scanned from 30 MHz up to a frequency including its 10th harmonic.

3.6.2 Measuring Instruments

See list of measuring instruments of this test report.

3.6.3 Test Procedures

1. The EUT was placed on a rotatable wooden table with 0.8 meter above ground.
2. The EUT was set 3 meters from the receiving antenna, which was mounted on the antenna tower.
3. The table was rotated 360 degrees to determine the position of the highest spurious emission.
4. The height of the receiving antenna is varied between one meter and four meters to search the maximum spurious emission for both horizontal and vertical polarizations.
5. Make the measurement with the spectrum analyzer's RBW = 1MHz, VBW = 3MHz, taking the record of maximum spurious emission.
6. A horn antenna was substituted in place of the EUT and was driven by a signal generator.
7. Tune the output power of signal generator to the same emission level with EUT maximum spurious emission.
8. Taking the record of output power at antenna port.
9. Repeat step 7 to step 8 for another polarization.
10. The RF fundamental frequency should be excluded against the limit line in the operating frequency band.
11. The limit line is derived from $43 + 10\log(P)$ dB below the transmitter power P(Watts)

$$= P(W) - [43 + 10\log(P)] \text{ (dB)}$$

$$= [30 + 10\log(P)] \text{ (dBm)} - [43 + 10\log(P)] \text{ (dB)}$$

$$= -13\text{dBm}.$$
12. EIRP (dBm) = S.G. Power – Tx Cable Loss + Tx Antenna Gain
13. ERP (dBm) = EIRP - 2.15

The report refers only to the sample tested and does not apply to the bulk.

This report is issued in confidence to the client and it will be strictly treated as such by the SHENZHEN TIMEWAY TESTING LABORATORIES. It may not be reproduced rather in its entirety or in part and it may not be used for advertising. The client to whom the report is issued may, however, show or send it . or a certified copy there of prepared by the SHENZHEN TIMEWAY TESTING LABORATORIES. to his customer. Supplier or others persons directly concerned. SHENZHEN TIMEWAY TESTING LABORATORIES. will not, without the consent of the client enter into any discussion of correspondence with any third party concerning the contents of the report. In the event of the improper use of the report. The SHENZHEN TIMEWAY TESTING LABORATORIES. reserves the rights to withdraw it and to adopt any other remedies which may be appropriate.



3.6.4 Test Setup

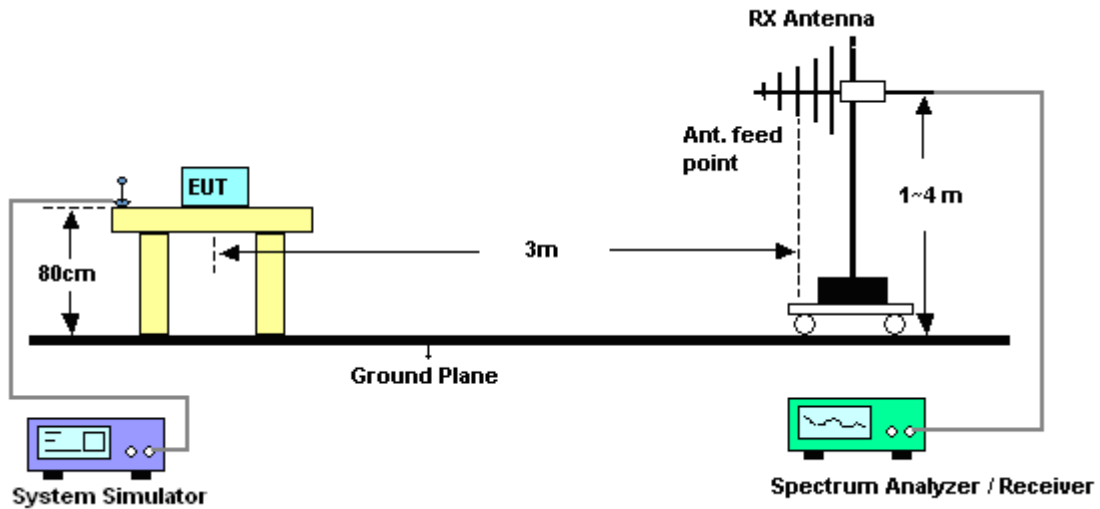

The report refers only to the sample tested and does not apply to the bulk.

This report is issued in confidence to the client and it will be strictly treated as such by the SHENZHEN TIMEWAY TESTING LABORATORIES. It may not be reproduced rather in its entirety or in part and it may not be used for advertising. The client to whom the report is issued may, however, show or send it or a certified copy thereof prepared by the SHENZHEN TIMEWAY TESTING LABORATORIES to his customer, supplier or other persons directly concerned. SHENZHEN TIMEWAY TESTING LABORATORIES will not, without the consent of the client enter into any discussion of correspondence with any third party concerning the contents of the report. In the event of the improper use of the report, the SHENZHEN TIMEWAY TESTING LABORATORIES reserves the right to withdraw it and to adopt any other remedies which may be appropriate.



3.6.5 Test Result of Field Strength of Spurious Radiated

Test Mode	GSM850 GSM		Test Channel	Low
Frequency (MHz)	Spurious Emissions		Limit (dBm)	Result
	Polarization	Level(dBm)		
1648.40	Vertical	-41.85	-13	Pass
2472.60	Vertical	-46.31	-13	Pass
1648.40	Horizontal	-38.37	-13	Pass
2472.60	Horizontal	-44.81	-13	Pass

Test Mode	GSM850 GSM		Test Channel	Middle
Frequency (MHz)	Spurious Emissions		Limit (dBm)	Result
	Polarization	Level(dBm)		
1673.20	Vertical	-42.93	-13	Pass
2509.80	Vertical	-45.55	-13	Pass
1673.20	Horizontal	-39.12	-13	Pass
2509.80	Horizontal	-45.08	-13	Pass

Test Mode	GSM850 GSM		Test Channel	High
Frequency (MHz)	Spurious Emissions		Limit (dBm)	Result
	Polarization	Level(dBm)		
1697.60	Vertical	-42.72	-13	Pass
2546.41	Vertical	-64.63	-13	Pass
1697.60	Horizontal	-39.36	-13	Pass
2546.41	Horizontal	-43.29	-13	Pass

The report refers only to the sample tested and does not apply to the bulk.

This report is issued in confidence to the client and it will be strictly treated as such by the SHENZHEN TIMEWAY TESTING LABORATORIES. It may not be reproduced rather in its entirety or in part and it may not be used for advertising. The client to whom the report is issued may, however, show or send it or a certified copy thereof prepared by the SHENZHEN TIMEWAY TESTING LABORATORIES to his customer. Supplier or other persons directly concerned. SHENZHEN TIMEWAY TESTING LABORATORIES will not, without the consent of the client enter into any discussion of correspondence with any third party concerning the contents of the report.

In the event of the improper use of the report. The SHENZHEN TIMEWAY TESTING LABORATORIES reserves the rights to withdraw it and to adopt any other remedies which may be appropriate.



Test Mode	GSM1900 GSM		Test Channel	Low
Frequency (MHz)	Spurious Emissions		Limit (dBm)	Result
	Polarization	Level(dBm)		
3700.40	Vertical	-43.39	-13	Pass
5550.60	Vertical	-48.92	-13	Pass
3700.40	Horizontal	-41.35	-13	Pass
5550.60	Horizontal	-46.28	-13	Pass

Test Mode	GSM1900 GSM		Test Channel	Middle
Frequency (MHz)	Spurious Emissions		Limit (dBm)	Result
	Polarization	Level(dBm)		
3760.00	Vertical	-43.10	-13	Pass
5640.00	Vertical	-47.82	-13	Pass
3760.00	Horizontal	-42.08	-13	Pass
5640.00	Horizontal	-46.76	-13	Pass

Test Mode	GSM1900 GSM		Test Channel	High
Frequency (MHz)	Spurious Emissions		Limit (dBm)	Result
	Polarization	Level(dBm)		
3819.60	Vertical	-42.87	-13	Pass
5729.40	Vertical	-46.52	-13	Pass
3819.60	Horizontal	-42.65	-13	Pass
5729.40	Horizontal	-45.92	-13	Pass

The report refers only to the sample tested and does not apply to the bulk.

This report is issued in confidence to the client and it will be strictly treated as such by the SHENZHEN TIMEWAY TESTING LABORATORIES. It may not be reproduced rather in its entirety or in part and it may not be used for advertising. The client to whom the report is issued may, however, show or send it or a certified copy thereof prepared by the SHENZHEN TIMEWAY TESTING LABORATORIES to his customer. Supplier or others persons directly concerned. SHENZHEN TIMEWAY TESTING LABORATORIES will not, without the consent of the client enter into any discussion of correspondence with any third party concerning the contents of the report.

In the event of the improper use of the report. The SHENZHEN TIMEWAY TESTING LABORATORIES reserves the rights to withdraw it and to adopt any other remedies which may be appropriate.



Test Mode	WCDMA Band V RMC 12.2Kbps		Test Channel	Low
Frequency (MHz)	Spurious Emissions		Limit (dBm)	Result
	Polarization	Level(dBm)		
1652.80	Vertical	-50.24	-13	Pass
2479.20	Vertical	-55.42	-13	Pass
1652.80	Horizontal	-47.16	-13	Pass
2479.20	Horizontal	-53.25	-13	Pass

Test Mode	WCDMA Band V RMC 12.2Kbps		Test Channel	Middle
Frequency (MHz)	Spurious Emissions		Limit (dBm)	Result
	Polarization	Level(dBm)		
1673.20	Vertical	-50.38	-13	Pass
2509.80	Vertical	-56.22	-13	Pass
1673.20	Horizontal	-48.08	-13	Pass
2509.80	Horizontal	-55.11	-13	Pass

Test Mode	WCDMA Band V RMC 12.2Kbps		Test Channel	High
Frequency (MHz)	Spurious Emissions		Limit (dBm)	Result
	Polarization	Level(dBm)		
1693.20	Vertical	-51.19	-13	Pass
2539.80	Vertical	-56.77	-13	Pass
1693.20	Horizontal	-47.65	-13	Pass
2539.80	Horizontal	-53.32	-13	Pass

The report refers only to the sample tested and does not apply to the bulk.

This report is issued in confidence to the client and it will be strictly treated as such by the SHENZHEN TIMEWAY TESTING LABORATORIES. It may not be reproduced rather in its entirety or in part and it may not be used for advertising. The client to whom the report is issued may, however, show or send it or a certified copy thereof prepared by the SHENZHEN TIMEWAY TESTING LABORATORIES to his customer. Supplier or other persons directly concerned. SHENZHEN TIMEWAY TESTING LABORATORIES will not, without the consent of the client enter into any discussion of correspondence with any third party concerning the contents of the report.

In the event of the improper use of the report. The SHENZHEN TIMEWAY TESTING LABORATORIES reserves the rights to withdraw it and to adopt any other remedies which may be appropriate.



Test Mode	WCDMA Band II RMC 12.2Kbps		Test Channel	Low
Frequency (MHz)	Spurious Emissions		Limit (dBm)	Result
	Polarization	Level(dBm)		
3704.80	Vertical	-51.22	-13	Pass
5557.20	Vertical	-57.17	-13	Pass
3704.80	Horizontal	-48.31	-13	Pass
5557.20	Horizontal	-52.83	-13	Pass

Test Mode	WCDMA Band V RMC 12.2Kbps		Test Channel	Middle
Frequency (MHz)	Spurious Emissions		Limit (dBm)	Result
	Polarization	Level(dBm)		
3760	Vertical	-51.23	-13	Pass
5640	Vertical	-57.64	-13	Pass
3760	Horizontal	-48.52	-13	Pass
5640	Horizontal	-54.02	-13	Pass

Test Mode	WCDMA Band V RMC 12.2Kbps		Test Channel	High
Frequency (MHz)	Spurious Emissions		Limit (dBm)	Result
	Polarization	Level(dBm)		
3815.20	Vertical	-51.25	-13	Pass
5722.80	Vertical	-56.93	-13	Pass
3815.20	Horizontal	-48.39	-13	Pass
5722.80	Horizontal	-54.11	-13	Pass

The report refers only to the sample tested and does not apply to the bulk.

This report is issued in confidence to the client and it will be strictly treated as such by the SHENZHEN TIMEWAY TESTING LABORATORIES. It may not be reproduced rather in its entirety or in part and it may not be used for advertising. The client to whom the report is issued may, however, show or send it or a certified copy thereof prepared by the SHENZHEN TIMEWAY TESTING LABORATORIES to his customer. Supplier or others persons directly concerned, SHENZHEN TIMEWAY TESTING LABORATORIES will not, without the consent of the client enter into any discussion of correspondence with any third party concerning the contents of the report. In the event of the improper use of the report, the SHENZHEN TIMEWAY TESTING LABORATORIES reserves the rights to withdraw it and to adopt any other remedies which may be appropriate.



3.7 Frequency Stability Measurement

3.7.1 Description of Frequency Stability Measurement

The frequency stability shall be measured by variation of ambient temperature and variation of primary supply voltage to ensure that the fundamental emission stays within the authorized frequency block. The frequency stability of the transmitter shall be maintained within $\pm 0.00025\%$ ($\pm 2.5\text{ppm}$) of the center frequency.

3.7.2 Measuring Instruments

See list of measuring instruments of this test report.

3.7.3 Test Procedures for Temperature Variation

1. The EUT was set up in the thermal chamber and connected with the base station.
2. With power OFF, the temperature was decreased to -30°C and the EUT was stabilized for three hours. Power was applied and the maximum change in frequency was recorded within one minute.
3. With power OFF, the temperature was raised in 10°C step up to 50°C . The EUT was stabilized at each step for at least half an hour. Power was applied and the maximum frequency change was recorded within one minute.
4. If the EUT can not be turned on at -30°C , the testing lowest temperature will be raised in 10°C step until the EUT can be turned on.

3.7.4 Test Procedures for Voltage Variation

1. The EUT was placed in a temperature chamber at $25\pm 5^{\circ}\text{C}$ and connected with the base station.
2. The power supply voltage to the EUT was varied from BEP to 115% of the nominal value measured at the input to the EUT.
3. The variation in frequency was measured for the worst case.

The report refers only to the sample tested and does not apply to the bulk.
This report is issued in confidence to the client and it will be strictly treated as such by the SHENZHEN TIMEWAY TESTING LABORATORIES. It may not be reproduced rather in its entirety or in part and it may not be used for advertising. The client to whom the report is issued may, however, show or send it, or a certified copy thereof prepared by the SHENZHEN TIMEWAY TESTING LABORATORIES, to his customer, Supplier or other persons directly concerned. SHENZHEN TIMEWAY TESTING LABORATORIES, will not, without the consent of the client enter into any discussion of correspondence with any third party concerning the contents of the report.
In the event of the improper use of the report, the SHENZHEN TIMEWAY TESTING LABORATORIES, reserves the rights to withdraw it and to adopt any other remedies which may be appropriate.



3.7.5 Test Setup

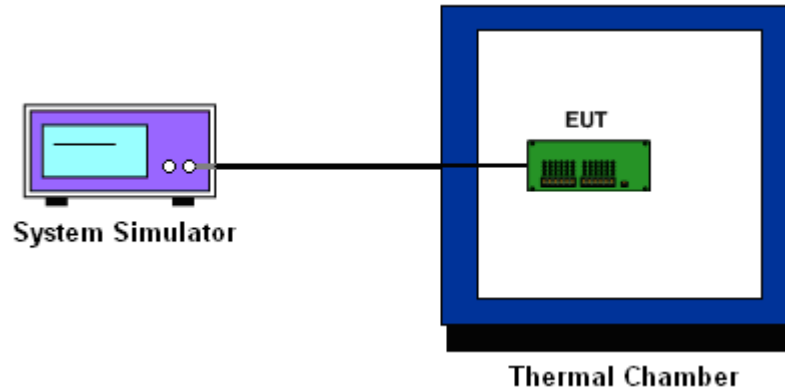

The report refers only to the sample tested and does not apply to the bulk.
This report is issued in confidence to the client and it will be strictly treated as such by the SHENZHEN TIMEWAY TESTING LABORATORIES. It may not be reproduced rather in its entirety or in part and it may not be used for advertising. The client to whom the report is issued may, however, show or send it or a certified copy thereof prepared by the SHENZHEN TIMEWAY TESTING LABORATORIES to his customer. Supplier or other persons directly concerned. SHENZHEN TIMEWAY TESTING LABORATORIES will not, without the consent of the client enter into any discussion of correspondence with any third party concerning the contents of the report.
In the event of the improper use of the report. The SHENZHEN TIMEWAY TESTING LABORATORIES reserves the rights to withdraw it and to adopt any other remedies which may be appropriate.



3.7.6 Test Result of Temperature and Voltage Variation

GSM850, Middle Channel

Middle channel, fo =836.6MHz				
Temperature (°C)	Power Supplied (V)	Frequency Error (Hz)	Error (ppm)	Limit (ppm)
-30	3.1	-35	-0.04	2.5
	3.7	-42	-0.05	2.5
	4.3	-28	-0.03	2.5
-20	3.1	-27	-0.03	2.5
	3.7	-23	-0.03	2.5
	4.3	-25	-0.03	2.5
-10	3.1	-42	-0.05	2.5
	3.7	-37	-0.04	2.5
	4.3	-26	-0.03	2.5
0	3.1	-37	-0.04	2.5
	3.7	-25	-0.03	2.5
	4.3	-32	-0.04	2.5
10	3.1	-35	-0.04	2.5
	3.7	-28	-0.03	2.5
	4.3	-32	-0.04	2.5
20	3.1	-47	-0.06	2.5
	3.7	-27	-0.03	2.5
	4.3	-36	-0.04	2.5
30	3.1	-54	-0.06	2.5
	3.7	-30	-0.04	2.5
	4.3	-41	-0.05	2.5
40	3.1	-32	-0.04	2.5
	3.7	-31	-0.04	2.5
	4.3	-26	-0.03	2.5
50	3.1	-47	-0.06	2.5
	3.7	-46	-0.05	2.5
	4.3	-53	-0.06	2.5

Note: The extreme voltage was declared by the manufacturer.

The report refers only to the sample tested and does not apply to the bulk.

This report is issued in confidence to the client and it will be strictly treated as such by the SHENZHEN TIMEWAY TESTING LABORATORIES. It may not be reproduced rather in its entirety or in part and it may not be used for advertising. The client to whom the report is issued may, however, show or send it . or a certified copy there of prepared by the SHENZHEN TIMEWAY TESTING LABORATORIES. to his customer. Supplier or others persons directly concerned. SHENZHEN TIMEWAY TESTING LABORATORIES. will not, without the consent of the client enter into any discussion of correspondence with any third party concerning the contents of the report.

In the event of the improper use of the report. The SHENZHEN TIMEWAY TESTING LABORATORIES. reserves the rights to withdraw it and to adopt any other remedies which may be appropriate.

**EDGE Class 8, Middle Channel**

Middle channel, fo =836.6MHz				
Temperature (°C)	Power Supplied (V)	Frequency Error (Hz)	Error (ppm)	Limit (ppm)
-30	3.1	-55	-0.07	2.5
	3.7	-42	-0.05	2.5
	4.3	-36	-0.04	2.5
-20	3.1	-37	-0.04	2.5
	3.7	-36	-0.04	2.5
	4.3	-24	-0.03	2.5
-10	3.1	-41	-0.05	2.5
	3.7	-36	-0.04	2.5
	4.3	-43	-0.05	2.5
0	3.1	-44	-0.05	2.5
	3.7	-38	-0.05	2.5
	4.3	-34	-0.04	2.5
10	3.1	-27	-0.03	2.5
	3.7	-24	-0.03	2.5
	4.3	-33	-0.04	2.5
20	3.1	-38	-0.05	2.5
	3.7	-46	-0.06	2.5
	4.3	-41	-0.05	2.5
30	3.1	-40	-0.05	2.5
	3.7	-52	-0.06	2.5
	4.3	-41	-0.05	2.5
40	3.1	-33	-0.04	2.5
	3.7	-37	-0.04	2.5
	4.3	-51	-0.06	2.5
50	3.1	-46	-0.05	2.5
	3.7	-42	-0.05	2.5
	4.3	-54	-0.06	2.5

Note: The extreme voltage was declared by the manufacturer.

The report refers only to the sample tested and does not apply to the bulk.

This report is issued in confidence to the client and it will be strictly treated as such by the SHENZHEN TIMEWAY TESTING LABORATORIES. It may not be reproduced rather in its entirety or in part and it may not be used for advertising. The client to whom the report is issued may, however, show or send it . or a certified copy there of prepared by the SHENZHEN TIMEWAY TESTING LABORATORIES. to his customer. Supplier or others persons directly concerned. SHENZHEN TIMEWAY TESTING LABORATORIES. will not, without the consent of the client enter into any discussion of correspondence with any third party concerning the contents of the report.

In the event of the improper use of the report. The SHENZHEN TIMEWAY TESTING LABORATORIES. reserves the rights to withdraw it and to adopt any other remedies which may be appropriate.

**GSM1900 Middle Channel:**

Middle channel, fo =1880.0MHz				
Temperature (°C)	Power Supplied (V)	Frequency Error (Hz)	Error (ppm)	Limit (ppm)
-30	3.1	-64	-0.04	2.5
	3.7	-76	-0.04	2.5
	4.3	-67	-0.04	2.5
-20	3.1	-50	-0.03	2.5
	3.7	-64	-0.03	2.5
	4.3	-60	-0.03	2.5
-10	3.1	-56	-0.03	2.5
	3.7	-39	-0.02	2.5
	4.3	-53	-0.03	2.5
0	3.1	-62	-0.03	2.5
	3.7	-68	-0.04	2.5
	4.3	-47	-0.03	2.5
10	3.1	-40	-0.02	2.5
	3.7	-55	-0.03	2.5
	4.3	-42	-0.02	2.5
20	3.1	-46	-0.02	2.5
	3.7	-51	-0.03	2.5
	4.3	-38	-0.02	2.5
30	3.1	-36	-0.02	2.5
	3.7	-63	-0.03	2.5
	4.3	-55	-0.03	2.5
40	3.1	-44	-0.02	2.5
	3.7	-40	-0.02	2.5
	4.3	-63	-0.03	2.5
50	3.1	-48	-0.03	2.5
	3.7	-54	-0.03	2.5
	4.3	-61	-0.03	2.5

Note: The extreme voltage was declared by the manufacturer.

The report refers only to the sample tested and does not apply to the bulk.

This report is issued in confidence to the client and it will be strictly treated as such by the SHENZHEN TIMEWAY TESTING LABORATORIES. It may not be reproduced rather in its entirety or in part and it may not be used for advertising. The client to whom the report is issued may, however, show or send it . or a certified copy there of prepared by the SHENZHEN TIMEWAY TESTING LABORATORIES. to his customer. Supplier or others persons directly concerned. SHENZHEN TIMEWAY TESTING LABORATORIES. will not, without the consent of the client enter into any discussion of correspondence with any third party concerning the contents of the report.

In the event of the improper use of the report. The SHENZHEN TIMEWAY TESTING LABORATORIES. reserves the rights to withdraw it and to adopt any other remedies which may be appropriate.

**EDGE Class 8 Middle Channel:**

Middle channel, fo =1880.0MHz				
Temperature (°C)	Power Supplied (V)	Frequency Error (Hz)	Error (ppm)	Limit (ppm)
-30	3.3	-78	-0.04	2.5
	3.7	-86	-0.05	2.5
	4.3	-75	-0.04	2.5
-20	3.3	-59	-0.03	2.5
	3.7	-62	-0.03	2.5
	4.3	-57	-0.03	2.5
-10	3.3	-64	-0.03	2.5
	3.7	-59	-0.03	2.5
	4.3	-55	-0.03	2.5
0	3.3	-67	-0.04	2.5
	3.7	-64	-0.03	2.5
	4.3	-52	-0.03	2.5
10	3.3	-66	-0.04	2.5
	3.7	-53	-0.03	2.5
	4.3	-48	-0.03	2.5
20	3.3	-47	-0.03	2.5
	3.7	-52	-0.03	2.5
	4.3	-64	-0.03	2.5
30	3.3	-56	-0.03	2.5
	3.7	-63	-0.03	2.5
	4.3	-60	-0.03	2.5
40	3.3	-44	-0.02	2.5
	3.7	-54	-0.03	2.5
	4.3	-63	-0.03	2.5
50	3.3	-71	-0.04	2.5
	3.7	-65	-0.03	2.5
	4.3	-76	-0.04	2.5

Note: The extreme voltage was declared by the manufacturer.

The report refers only to the sample tested and does not apply to the bulk.

This report is issued in confidence to the client and it will be strictly treated as such by the SHENZHEN TIMEWAY TESTING LABORATORIES. It may not be reproduced rather in its entirety or in part and it may not be used for advertising. The client to whom the report is issued may, however, show or send it, or a certified copy thereof prepared by the SHENZHEN TIMEWAY TESTING LABORATORIES, to his customer. Supplier or others persons directly concerned. SHENZHEN TIMEWAY TESTING LABORATORIES, will not, without the consent of the client enter into any discussion of correspondence with any third party concerning the contents of the report.

In the event of the improper use of the report. The SHENZHEN TIMEWAY TESTING LABORATORIES, reserves the rights to withdraw it and to adopt any other remedies which may be appropriate.

**WCDMA Band V**

Middle channel, fo =836.6MHz				
Temperature (°C)	Power Supplied (V)	Frequency Error (Hz)	Error (ppm)	Limit (ppm)
-30	3.3	-37	-0.04	2.5
	3.7	-52	-0.06	2.5
	4.3	-34	-0.04	2.5
-20	3.3	-58	-0.07	2.5
	3.7	-39	-0.05	2.5
	4.3	-43	-0.05	2.5
-10	3.3	-42	-0.05	2.5
	3.7	-34	-0.04	2.5
	4.3	-33	-0.04	2.5
0	3.3	-47	-0.06	2.5
	3.7	-35	-0.04	2.5
	4.3	-39	-0.05	2.5
10	3.3	-31	-0.04	2.5
	3.7	-29	-0.03	2.5
	4.3	-43	-0.05	2.5
20	3.3	-34	-0.04	2.5
	3.7	-47	-0.06	2.5
	4.3	-39	-0.05	2.5
30	3.3	-54	-0.06	2.5
	3.7	-45	-0.05	2.5
	4.3	-38	-0.05	2.5
40	3.3	-39	-0.05	2.5
	3.7	-31	-0.04	2.5
	4.3	-40	-0.05	2.5
50	3.3	-55	-0.07	2.5
	3.7	-49	-0.06	2.5
	4.3	-48	-0.06	2.5

Note: The extreme voltage was declared by the manufacturer.

The report refers only to the sample tested and does not apply to the bulk.

This report is issued in confidence to the client and it will be strictly treated as such by the SHENZHEN TIMEWAY TESTING LABORATORIES. It may not be reproduced rather in its entirety or in part and it may not be used for advertising. The client to whom the report is issued may, however, show or send it . or a certified copy there of prepared by the SHENZHEN TIMEWAY TESTING LABORATORIES. to his customer. Supplier or others persons directly concerned. SHENZHEN TIMEWAY TESTING LABORATORIES. will not, without the consent of the client enter into any discussion of correspondence with any third party concerning the contents of the report.

In the event of the improper use of the report. The SHENZHEN TIMEWAY TESTING LABORATORIES. reserves the rights to withdraw it and to adopt any other remedies which may be appropriate.

**WCDMA Band II**

Middle channel, fo =1880.0MHz				
Temperature (°C)	Power Supplied (V)	Frequency Error (Hz)	Error (ppm)	Limit (ppm)
-30	3.3	-58	-0.03	2.5
	3.7	-69	-0.04	2.5
	4.3	-74	-0.04	2.5
-20	3.3	-64	-0.03	2.5
	3.7	-71	-0.04	2.5
	4.3	-46	-0.02	2.5
-10	3.3	-52	-0.03	2.5
	3.7	-66	-0.04	2.5
	4.3	-64	-0.03	2.5
0	3.3	-67	-0.04	2.5
	3.7	-43	-0.02	2.5
	4.3	-55	-0.03	2.5
10	3.3	-51	-0.03	2.5
	3.7	-63	-0.03	2.5
	4.3	-48	-0.03	2.5
20	3.3	-42	-0.02	2.5
	3.7	-44	-0.02	2.5
	4.3	-59	-0.03	2.5
30	3.3	-47	-0.03	2.5
	3.7	-67	-0.04	2.5
	4.3	-51	-0.03	2.5
40	3.3	-46	-0.02	2.5
	3.7	-58	-0.03	2.5
	4.3	-56	-0.03	2.5
50	3.3	-50	-0.03	2.5
	3.7	-73	-0.04	2.5
	4.3	-65	-0.03	2.5

Note: The extreme voltage was declared by the manufacturer.

The report refers only to the sample tested and does not apply to the bulk.

This report is issued in confidence to the client and it will be strictly treated as such by the SHENZHEN TIMEWAY TESTING LABORATORIES. It may not be reproduced rather in its entirety or in part and it may not be used for advertising. The client to whom the report is issued may, however, show or send it . or a certified copy there of prepared by the SHENZHEN TIMEWAY TESTING LABORATORIES. to his customer. Supplier or others persons directly concerned. SHENZHEN TIMEWAY TESTING LABORATORIES. will not, without the consent of the client enter into any discussion of correspondence with any third party concerning the contents of the report.

In the event of the improper use of the report. The SHENZHEN TIMEWAY TESTING LABORATORIES. reserves the rights to withdraw it and to adopt any other remedies which may be appropriate.

3.8 Peak-to-Average Ratio

3.8.1 Description of the PAR Measurement

The peak-to-average ratio (PAR) of the transmission may not exceed 13 dB.

3.8.2 Measuring Instruments

The measuring equipment is listed in the section 4 of this test report.

3.8.3 Test Procedures

1. The EUT was connected to Spectrum Analyzer and System Simulator via power divider.
2. For GSM/EGPRS operating modes:
 - a. Set EUT in maximum power output.
 - b. Set the RBW = 1MHz, VBW = 3MHz, Peak detector in spectrum analyzer for first trace.
 - c. Set the RBW = 1MHz, VBW = 3MHz, RMS detector in spectrum analyzer for second trace.
 - d. The wanted burst signal is triggered by spectrum analyzer, and measured respectively the peak level and Mean level without burst-off time, after system simulator synchronized with the spectrum analyzer.
3. For UMTS operating modes:
 - a. Set the CCDF (Complementary Cumulative Distribution Function) option in spectrum analyzer.
 - b. The highest RF powers were measured and recorded the maximum PAPR level associated with a probability of 0.1 %.
4. Record the deviation as Peak to Average Ratio.

3.8.4 Test Setup

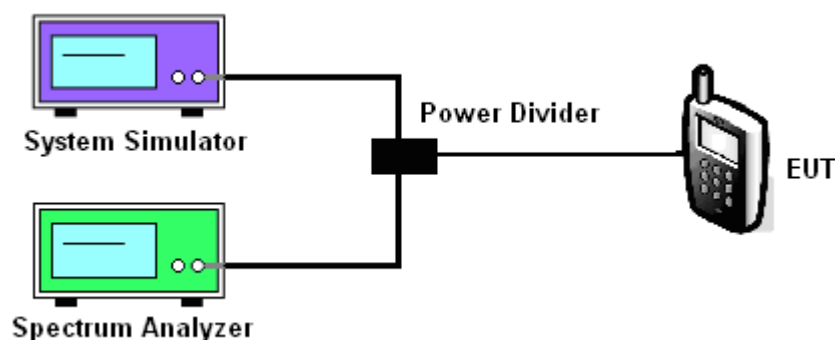

The report refers only to the sample tested and does not apply to the bulk.

This report is issued in confidence to the client and it will be strictly treated as such by the SHENZHEN TIMEWAY TESTING LABORATORIES. It may not be reproduced rather in its entirety or in part and it may not be used for advertising. The client to whom the report is issued may, however, show or send it, or a certified copy thereof prepared by the SHENZHEN TIMEWAY TESTING LABORATORIES, to his customer. Supplier or other persons directly concerned. SHENZHEN TIMEWAY TESTING LABORATORIES, will not, without the consent of the client enter into any discussion of correspondence with any third party concerning the contents of the report.

In the event of the improper use of the report. The SHENZHEN TIMEWAY TESTING LABORATORIES, reserves the rights to withdraw it and to adopt any other remedies which may be appropriate.



3.8.5 Test Result of Peak-to-Average Ratio

PCS Band									
Modes	GSM1900 (GSM)			GSM1900 (EDGE class 8)			WCDMA Band II (RMC 12.2Kbps)		
Channel	512 (Low)	661 (Mid)	810 (High)	512 (Low)	661 (Mid)	810 (High)	9262 (Low)	9400 (Mid)	9538 (High)
Frequency (MHz)	1850.2	1880	1909.8	1850.2	1880	1909.8	1852.4	1880	1907.6
Peak-to-Average Ratio (dB)	0.41	0.39	0.43	2.29	2.27	2.30	2.38	2.36	2.38

The report refers only to the sample tested and does not apply to the bulk.

This report is issued in confidence to the client and it will be strictly treated as such by the SHENZHEN TIMEWAY TESTING LABORATORIES. It may not be reproduced rather in its entirety or in part and it may not be used for advertising. The client to whom the report is issued may, however, show or send it or a certified copy thereof prepared by the SHENZHEN TIMEWAY TESTING LABORATORIES to his customer. Supplier or others persons directly concerned. SHENZHEN TIMEWAY TESTING LABORATORIES will not, without the consent of the client enter into any discussion of correspondence with any third party concerning the contents of the report.

In the event of the improper use of the report. The SHENZHEN TIMEWAY TESTING LABORATORIES reserves the rights to withdraw it and to adopt any other remedies which may be appropriate.



3.9 Mains Conducted Emissions

3.9.1 Measurement Method

The measurement procedure specified in ANSI C63.4-2003 was used for testing. Conducted Emission was measured with travel charger.

3.9.2 Provisions Applicable

Frequency of Emission (MHz)	Conducted Limit(dBuV)	
	Quasi-Peak	Average
0.15 – 0.5	66 to 56 *	56 to 46 *
0.5 – 5	56	46
5 – 30	60	50
*Decreases with the logarithm of the frequency.		
*The lower limit shall apply at the transition frequency.		

Note: The GSM850 mode is the worst condition and the test result as following:

The report refers only to the sample tested and does not apply to the bulk.
 This report is issued in confidence to the client and it will be strictly treated as such by the SHENZHEN TIMEWAY TESTING LABORATORIES. It may not be reproduced rather in its entirety or in part and it may not be used for advertising. The client to whom the report is issued may, however, show or send it . or a certified copy there of prepared by the SHENZHEN TIMEWAY TESTING LABORATORIES. to his customer. Supplier or others persons directly concerned. SHENZHEN TIMEWAY TESTING LABORATORIES. will not, without the consent of the client enter into any discussion of correspondence with any third party concerning the contents of the report.
 In the event of the improper use of the report. The SHENZHEN TIMEWAY TESTING LABORATORIES. reserves the rights to withdraw it and to adopt any other remedies which may be appropriate.



A: Conducted Emission on Live Terminal (150kHz to 30MHz)
EUT Operating Environment
 Temperature: 26°C Humidity: 65%RH Atmospheric Pressure: 101 KPa
EUT set Condition: Charging and Communication by GSM850
Equipment Level: Class B
Results: PASS
 Please refer to following diagram for individual

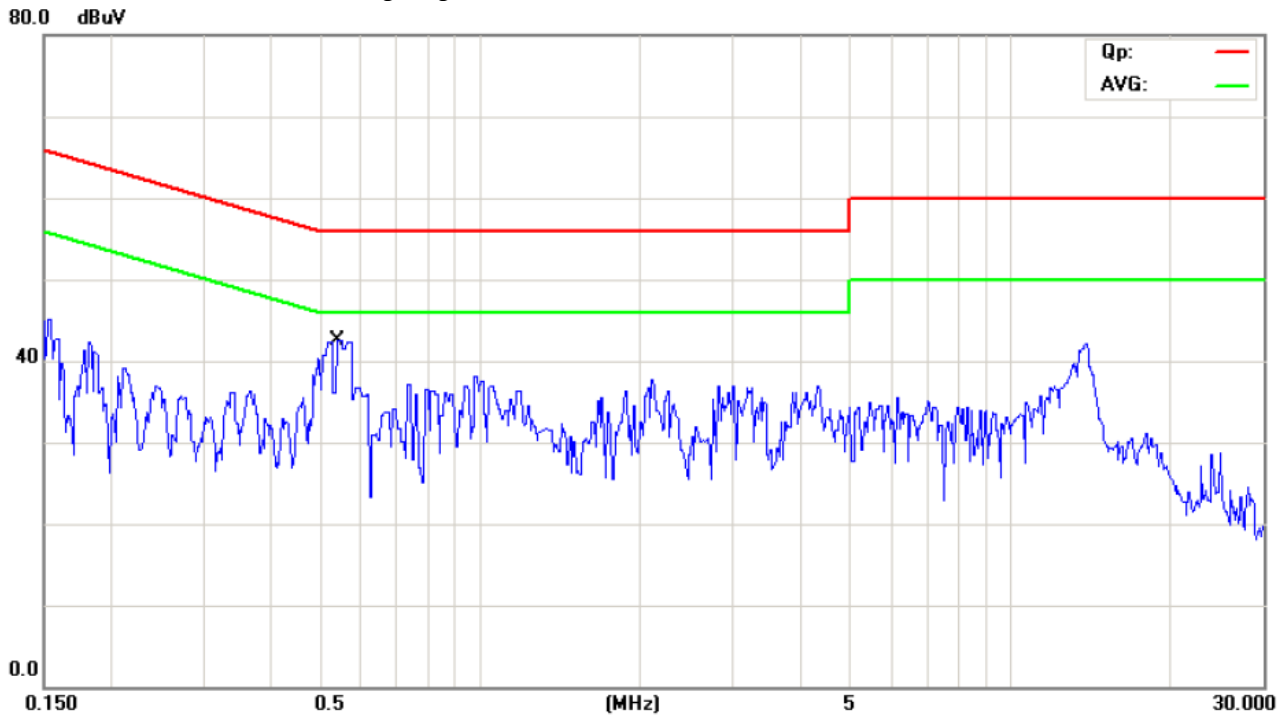

No.	Mk.	Freq. MHz	Reading Level dBuV	Correct Factor dB	Measure- ment dBuV	Limit dBuV	Over dB	Detector	Comment
1	*	0.5418	25.30	11.41	36.71	56.00	-19.29	QP	
2		0.5418	10.80	11.41	22.21	46.00	-23.79	AVG	

The report refers only to the sample tested and does not apply to the bulk.
 This report is issued in confidence to the client and it will be strictly treated as such by the SHENZHEN TIMEWAY TESTING LABORATORIES. It may not be reproduced rather in its entirety or in part and it may not be used for advertising. The client to whom the report is issued may, however, show or send it . or a certified copy there of prepared by the SHENZHEN TIMEWAY TESTING LABORATORIES. to his customer. Supplier or others persons directly concerned. SHENZHEN TIMEWAY TESTING LABORATORIES. will not, without the consent of the client enter into any discussion of correspondence with any third party concerning the contents of the report.
 In the event of the improper use of the report. The SHENZHEN TIMEWAY TESTING LABORATORIES. reserves the rights to withdraw it and to adopt any other remedies which may be appropriate.



B: Conducted Emission on Neutral Terminal (150kHz to 30MHz)
EUT Operating Environment
 Temperature: 26°C Humidity: 65%RH Atmospheric Pressure: 101 KPa
EUT set Condition: Charging and Communication by GSM850
Equipment Level: Class B
Results: PASS
 Please refer to following diagram for individual

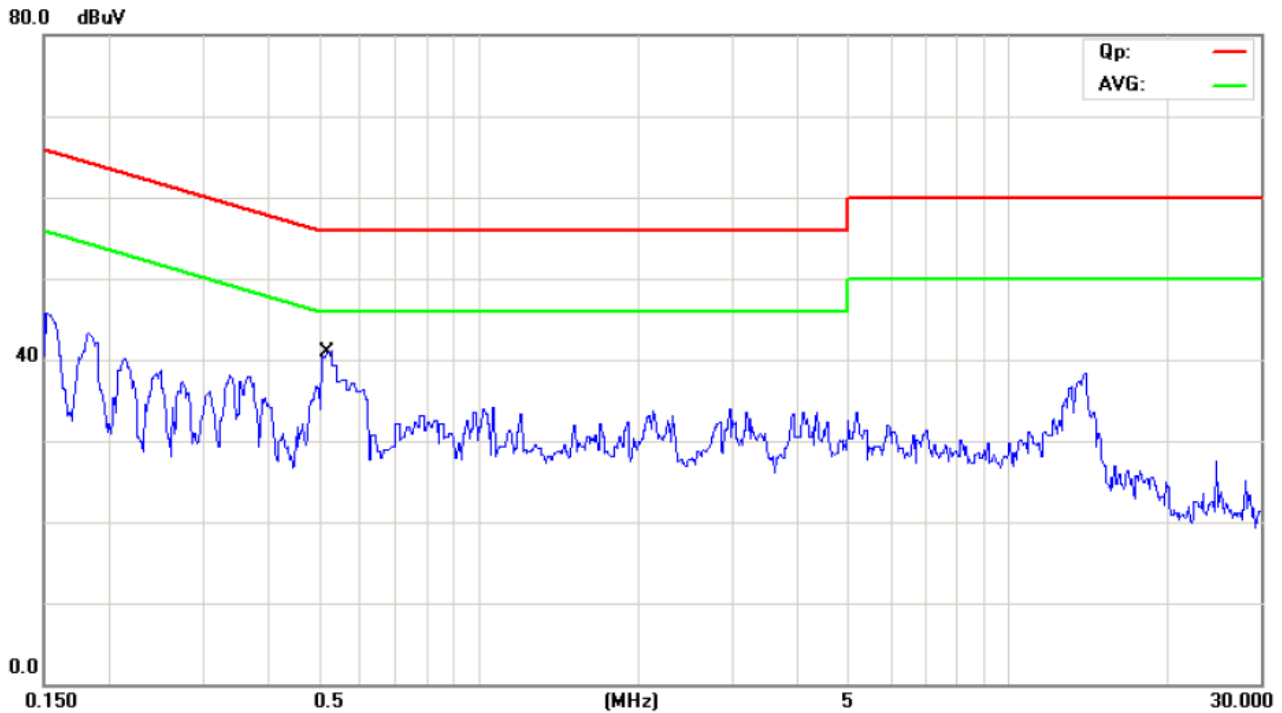

No.	Mk.	Freq. MHz	Reading Level dBuV	Correct Factor dB	Measure- ment dBuV	Limit dBuV	Over dB	Detector	Comment
1		0.5175	28.10	11.39	39.49	56.00	-16.51	QP	
2	*	0.5175	21.80	11.39	33.19	46.00	-12.81	AVG	

The report refers only to the sample tested and does not apply to the bulk.
 This report is issued in confidence to the client and it will be strictly treated as such by the SHENZHEN TIMEWAY TESTING LABORATORIES. It may not be reproduced rather in its entirety or in part and it may not be used for advertising. The client to whom the report is issued may, however, show or send it . or a certified copy there of prepared by the SHENZHEN TIMEWAY TESTING LABORATORIES. to his customer. Supplier or others persons directly concerned. SHENZHEN TIMEWAY TESTING LABORATORIES. will not, without the consent of the client enter into any discussion of correspondence with any third party concerning the contents of the report.
 In the event of the improper use of the report. The SHENZHEN TIMEWAY TESTING LABORATORIES. reserves the rights to withdraw it and to adopt any other remedies which may be appropriate.



4 List of Measuring Equipment

Test Equipments					
Instrument Type	Manufacturer	Model	Serial No.	Date of Cal.	Due Date
ESPI Test Receiver	R&S	ESPI 3	100379	2015-08-22	2016-08-21
TWO Line-V-NETW	R&S	EZH3-Z5	100294	2015-08-22	2016-08-21
TWO Line-V-NETW	R&S	EZH3-Z5	100253	2015-08-22	2016-08-21
Ultra Broadband ANT	R&S	HL562	100157	2015-08-23	2016-08-22
ESDV Test Receiver	R&S	ESDV	100008	2015-08-22	2016-08-21
Impuls-Begrenzer	R&S	ESH3-Z2	100281	2015-08-22	2016-08-21
System Controller	CT	SC100	-	--	--
Printer	EPSON	PHOTO EX3	CFNH234850	--	--
Computer	IBM	8434	1S8434KCE99BLXLO*	-	-
Loop Antenna	EMCO	6502	00042960	2015-08-23	2016-08-22
ESPI Test Receiver	R&S	ESI26	838786/013	2015-08-22	2016-08-21
3m OATS	--	--	N/A	2015-08-24	2016-08-23
Horn Antenna	R&S	BBHA 9170	BBHA9170265	2015-08-24	2016-08-23
Horn Antenna	R&S	BBHA 9120D	9120D-631	2015-08-24	2016-08-23
Power meter	Anritsu	ML2487A	6K00003613	2015-08-22	2016-08-21
Power sensor	Anritsu	MA2491A	32263	2015-08-22	2016-08-21
Bilog Antenna	Schwarebeck	VULB9163	9163/340	2015-08-23	2016-08-21
LISN	AFJ	LS16C	10010947251	2015-08-22	2016-08-21
LISN (Three Phase)	Schwarebeck	NSLK 8126	8126453	2015-08-23	2016-08-22
9*6*6 Anechoic	--	--	N/A	2015-08-24	2016-08-23
EMI Test Receiver	RS	ESCS30	100139	2015-08-22	2016-08-21

The report refers only to the sample tested and does not apply to the bulk.

This report is issued in confidence to the client and it will be strictly treated as such by the Shenzhen Timeway Technology Consulting Co., Ltd. It may not be reproduced rather in its entirety or in part and it may not be used for advertising. The client to whom the report is issued may, however, show or send it or a certified copy thereof prepared by the Shenzhen Timeway Technology Consulting Co., Ltd to his customer. Supplier or other persons directly concerned. Shenzhen Timeway Technology Consulting Co., Ltd will not, without the consent of the client enter into any discussion of correspondence with any third party concerning the contents of the report.

In the event of the improper use of the report. The Shenzhen Timeway Technology Consulting Co., Ltd reserves the rights to withdraw it and to adopt any other remedies which may be appropriate.



5.0 Photographs

Conducted Emission Test Setup:



The report refers only to the sample tested and does not apply to the bulk.
This report is issued in confidence to the client and it will be strictly treated as such by the Shenzhen Timeway Technology Consulting Co., Ltd. It may not be reproduced in its entirety or in part and it may not be used for advertising. The client to whom the report is issued may, however, show or send it or a certified copy thereof prepared by the Shenzhen Timeway Technology Consulting Co., Ltd. to his customer. Supplier or other persons directly concerned. Shenzhen Timeway Technology Consulting Co., Ltd. will not, without the consent of the client enter into any discussion of correspondence with any third party concerning the contents of the report.
In the event of the improper use of the report, the Shenzhen Timeway Technology Consulting Co., Ltd. reserves the rights to withdraw it and to adopt any other remedies which may be appropriate.



Radiated Emission Test Setup:

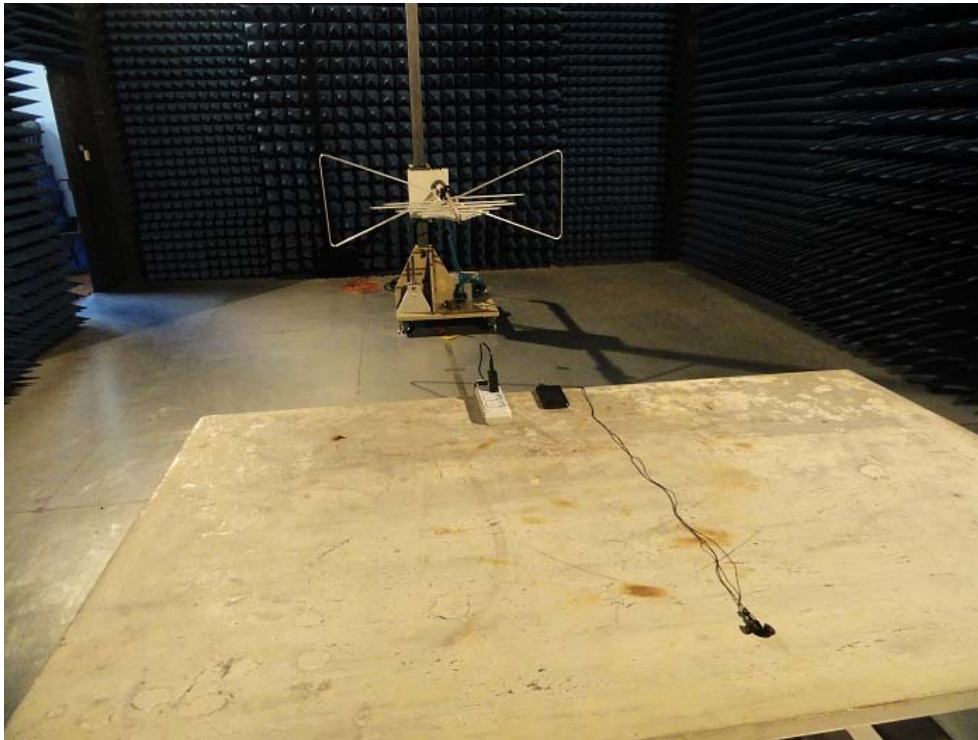

The report refers only to the sample tested and does not apply to the bulk.
This report is issued in confidence to the client and it will be strictly treated as such by the Shenzhen Timeway Technology Consulting Co., Ltd. It may not be reproduced in its entirety or in part and it may not be used for advertising. The client to whom the report is issued may, however, show or send it or a certified copy thereof prepared by the Shenzhen Timeway Technology Consulting Co., Ltd. to his customer, supplier or other persons directly concerned. Shenzhen Timeway Technology Consulting Co., Ltd. will not, without the consent of the client, enter into any discussion of correspondence with any third party concerning the contents of the report.
In the event of the improper use of the report, the Shenzhen Timeway Technology Consulting Co., Ltd. reserves the rights to withdraw it and to adopt any other remedies which may be appropriate.



Photographs – EUT

Outside view



The report refers only to the sample tested and does not apply to the bulk.
This report is issued in confidence to the client and it will be strictly treated as such by the Shenzhen Timeway Technology Consulting Co., Ltd. It may not be reproduced in its entirety or in part and it may not be used for advertising. The client to whom the report is issued may, however, show or send it or a certified copy thereof prepared by the Shenzhen Timeway Technology Consulting Co., Ltd. to his customer. Supplier or other persons directly concerned. Shenzhen Timeway Technology Consulting Co., Ltd. will not, without the consent of the client enter into any discussion of correspondence with any third party concerning the contents of the report.
In the event of the improper use of the report, the Shenzhen Timeway Technology Consulting Co., Ltd. reserves the rights to withdraw it and to adopt any other remedies which may be appropriate.



Outside view



The report refers only to the sample tested and does not apply to the bulk.
This report is issued in confidence to the client and it will be strictly treated as such by the Shenzhen Timeway Technology Consulting Co., Ltd. It may not be reproduced in its entirety or in part and it may not be used for advertising. The client to whom the report is issued may, however, show or send it or a certified copy thereof prepared by the Shenzhen Timeway Technology Consulting Co., Ltd. to his customer. Supplier or other persons directly concerned. Shenzhen Timeway Technology Consulting Co., Ltd. will not, without the consent of the client enter into any discussion of correspondence with any third party concerning the contents of the report.
In the event of the improper use of the report. The Shenzhen Timeway Technology Consulting Co., Ltd. reserves the rights to withdraw it and to adopt any other remedies which may be appropriate.



Outside view



The report refers only to the sample tested and does not apply to the bulk.
This report is issued in confidence to the client and it will be strictly treated as such by the Shenzhen Timeway Technology Consulting Co., Ltd. It may not be reproduced in its entirety or in part and it may not be used for advertising. The client to whom the report is issued may, however, show or send it or a certified copy thereof prepared by the Shenzhen Timeway Technology Consulting Co., Ltd. to his customer, supplier or other persons directly concerned. Shenzhen Timeway Technology Consulting Co., Ltd. will not, without the consent of the client, enter into any discussion of correspondence with any third party concerning the contents of the report.
In the event of the improper use of the report, the Shenzhen Timeway Technology Consulting Co., Ltd. reserves the rights to withdraw it and to adopt any other remedies which may be appropriate.



Outside view



The report refers only to the sample tested and does not apply to the bulk.
This report is issued in confidence to the client and it will be strictly treated as such by the Shenzhen Timeway Technology Consulting Co., Ltd. It may not be reproduced in its entirety or in part and it may not be used for advertising. The client to whom the report is issued may, however, show or send it or a certified copy thereof prepared by the Shenzhen Timeway Technology Consulting Co., Ltd. to his customer. Supplier or other persons directly concerned. Shenzhen Timeway Technology Consulting Co., Ltd. will not, without the consent of the client enter into any discussion of correspondence with any third party concerning the contents of the report.
In the event of the improper use of the report. The Shenzhen Timeway Technology Consulting Co., Ltd. reserves the rights to withdraw it and to adopt any other remedies which may be appropriate.



Outside view



The report refers only to the sample tested and does not apply to the bulk.
This report is issued in confidence to the client and it will be strictly treated as such by the Shenzhen Timeway Technology Consulting Co., Ltd. It may not be reproduced in its entirety or in part and it may not be used for advertising. The client to whom the report is issued may, however, show or send it or a certified copy thereof prepared by the Shenzhen Timeway Technology Consulting Co., Ltd. to his customer, supplier or other persons directly concerned. Shenzhen Timeway Technology Consulting Co., Ltd. will not, without the consent of the client, enter into any discussion of correspondence with any third party concerning the contents of the report.
In the event of the improper use of the report, the Shenzhen Timeway Technology Consulting Co., Ltd. reserves the rights to withdraw it and to adopt any other remedies which may be appropriate.



Inside view



The report refers only to the sample tested and does not apply to the bulk.
This report is issued in confidence to the client and it will be strictly treated as such by the Shenzhen Timeway Technology Consulting Co., Ltd. It may not be reproduced in its entirety or in part and it may not be used for advertising. The client to whom the report is issued may, however, show or send it or a certified copy thereof prepared by the Shenzhen Timeway Technology Consulting Co., Ltd. to his customer, supplier or other persons directly concerned. Shenzhen Timeway Technology Consulting Co., Ltd. will not, without the consent of the client, enter into any discussion of correspondence with any third party concerning the contents of the report.
In the event of the improper use of the report, the Shenzhen Timeway Technology Consulting Co., Ltd. reserves the rights to withdraw it and to adopt any other remedies which may be appropriate.



Inside view



The report refers only to the sample tested and does not apply to the bulk.
This report is issued in confidence to the client and it will be strictly treated as such by the Shenzhen Timeway Technology Consulting Co., Ltd. It may not be reproduced in its entirety or in part and it may not be used for advertising. The client to whom the report is issued may, however, show or send it or a certified copy thereof prepared by the Shenzhen Timeway Technology Consulting Co., Ltd. to his customer, supplier or other persons directly concerned. Shenzhen Timeway Technology Consulting Co., Ltd. will not, without the consent of the client, enter into any discussion of correspondence with any third party concerning the contents of the report.
In the event of the improper use of the report, the Shenzhen Timeway Technology Consulting Co., Ltd. reserves the rights to withdraw it and to adopt any other remedies which may be appropriate.



Inside view

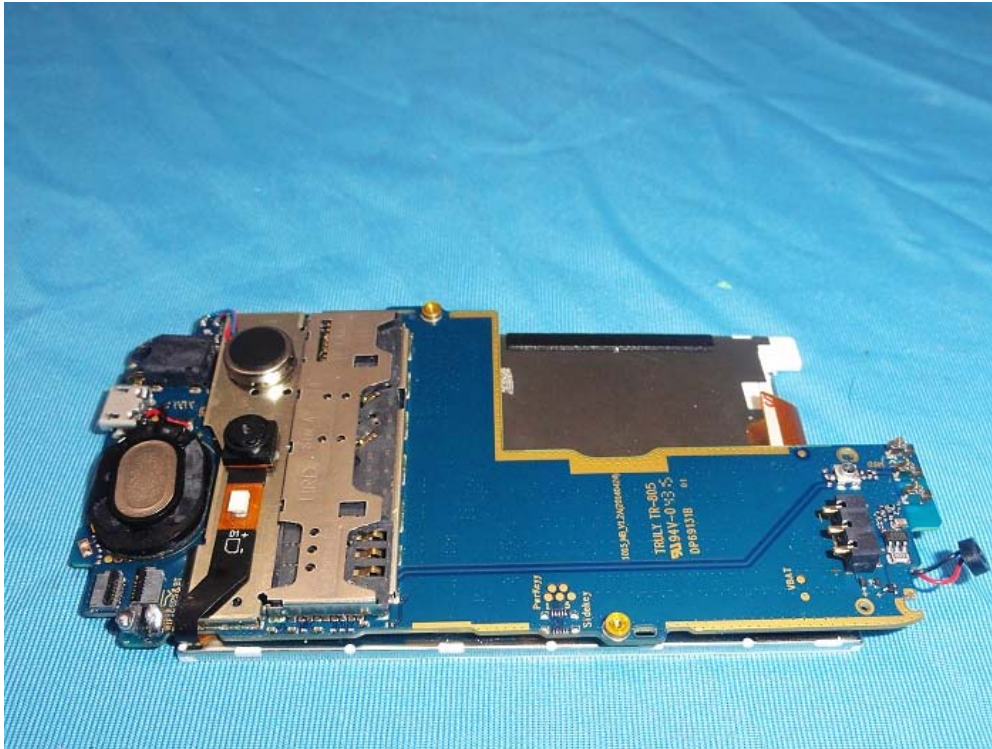

The report refers only to the sample tested and does not apply to the bulk. This report is issued in confidence to the client and it will be strictly treated as such by the Shenzhen Timeway Technology Consulting Co., Ltd. It may not be reproduced in its entirety or in part and it may not be used for advertising. The client to whom the report is issued may, however, show or send it or a certified copy thereof prepared by the Shenzhen Timeway Technology Consulting Co., Ltd. to his customer, supplier or other persons directly concerned. Shenzhen Timeway Technology Consulting Co., Ltd. will not, without the consent of the client, enter into any discussion of correspondence with any third party concerning the contents of the report. In the event of the improper use of the report, the Shenzhen Timeway Technology Consulting Co., Ltd. reserves the rights to withdraw it and to adopt any other remedies which may be appropriate.

Inside view

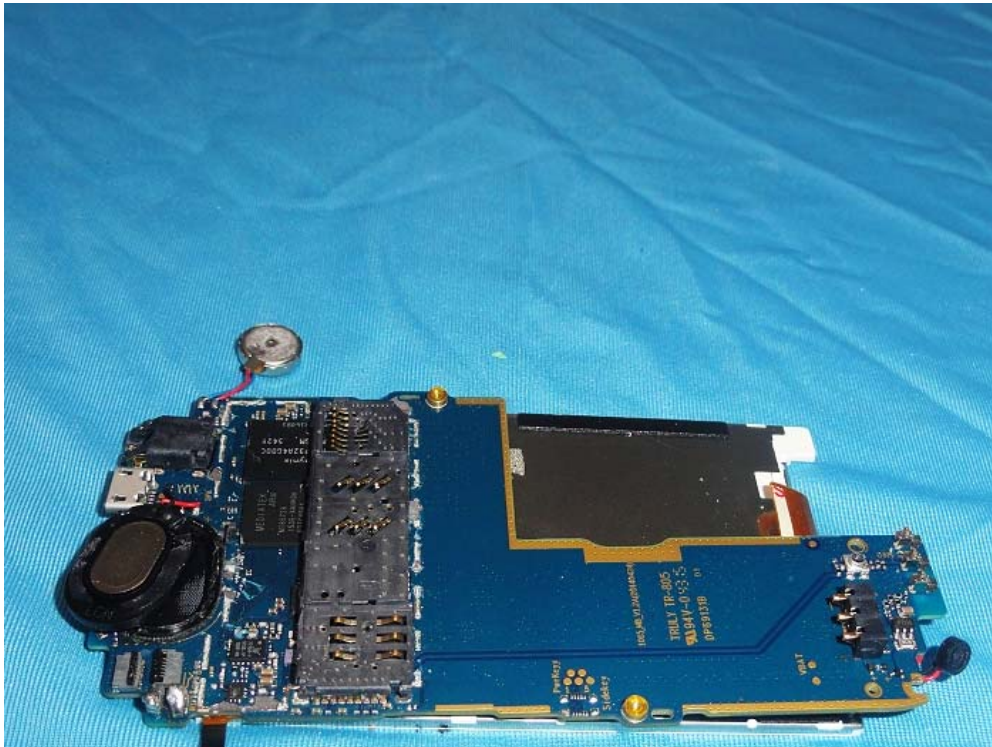

The report refers only to the sample tested and does not apply to the bulk.
This report is issued in confidence to the client and it will be strictly treated as such by the Shenzhen Timeway Technology Consulting Co., Ltd. It may not be reproduced in its entirety or in part and it may not be used for advertising. The client to whom the report is issued may, however, show or send it or a certified copy thereof prepared by the Shenzhen Timeway Technology Consulting Co., Ltd. to his customer, supplier or other persons directly concerned. Shenzhen Timeway Technology Consulting Co., Ltd. will not, without the consent of the client, enter into any discussion of correspondence with any third party concerning the contents of the report.
In the event of the improper use of the report, the Shenzhen Timeway Technology Consulting Co., Ltd. reserves the rights to withdraw it and to adopt any other remedies which may be appropriate.



Inside view

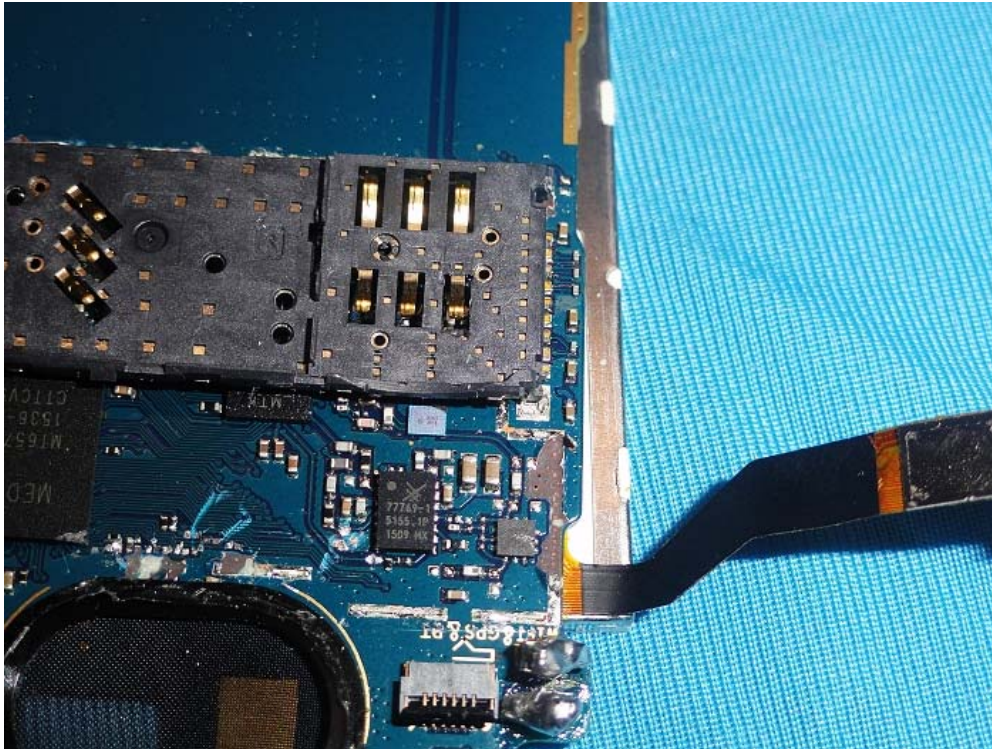

End of the report

The report refers only to the sample tested and does not apply to the bulk.
This report is issued in confidence to the client and it will be strictly treated as such by the Shenzhen Timeway Technology Consulting Co., Ltd. It may not be reproduced in its entirety or in part and it may not be used for advertising. The client to whom the report is issued may, however, show or send it or a certified copy thereof prepared by the Shenzhen Timeway Technology Consulting Co., Ltd. to his customer, supplier or other persons directly concerned. Shenzhen Timeway Technology Consulting Co., Ltd. will not, without the consent of the client, enter into any discussion of correspondence with any third party concerning the contents of the report.
In the event of the improper use of the report, the Shenzhen Timeway Technology Consulting Co., Ltd. reserves the rights to withdraw it and to adopt any other remedies which may be appropriate.