



# TEST REPORT

**APPLICANT** : Borqs BeiJing Ltd.  
**PRODUCT NAME** : Lively Mobile 2  
**MODEL NAME** : GCR4  
**BRAND NAME** : GreatCall  
**FCC ID** : 2ABDK-GCR4  
**STANDARD(S)** : 47 CFR Part 15 Subpart E  
**RECEIPT DATE** : 2018-09-29  
**TEST DATE** : 2018-12-14  
**ISSUE DATE** : 2019-01-19

Edited by:

*Zeng Xiaoying*  
Zeng Xiaoying (Rapporteur)

Approved by:

*Peng Huarui*  
Peng Huarui ( Supervisor )

**NOTE:** This document is issued by MORLAB, the test report shall not be reproduced except in full without prior written permission of the company. The test results apply only to the particular sample(s) tested and to the specific tests carried out which is available on request for validation and information confirmed at our website.





# DIRECTORY

<b>1. Technical Information</b> .....	<b>4</b>
<b>1.1. Applicant and Manufacturer Information</b> .....	<b>4</b>
<b>1.2. Companion Equipment(Master) Description</b> .....	<b>4</b>
<b>1.3. Equipment Under Test (EUT) Description</b> .....	<b>4</b>
<b>1.4. The channel number and frequency of EUT</b> .....	<b>6</b>
<b>1.5. Test Standards and Results</b> .....	<b>7</b>
<b>1.6. Environmental Conditions</b> .....	<b>7</b>
<b>2. 47 CFR Part 15C Requirements</b> .....	<b>8</b>
<b>2.1. Transmit Power Control (TPC) and Dynamic Frequency Selection (DFS)</b> .....	<b>8</b>
<b>Annex A The waveform of the radar</b> .....	<b>24</b>
<b>Annex B Test Uncertainty</b> .....	<b>27</b>
<b>Annex C Testing Laboratory Information</b> .....	<b>28</b>



<b>Change History</b>		
<b>Version</b>	<b>Date</b>	<b>Reason for change</b>
1.0	2019-01-19	First edition



# 1. Technical Information

Note: Provide by applicant.

## 1.1. Applicant and Manufacturer Information

<b>Applicant:</b>	Borqs BeiJing Ltd.
<b>Applicant Address:</b>	Tower A, Building B23, Universal Business Park, No. 10 Jiuxianqiao Road, Chaoyang District Beijing, 100015 China
<b>Manufacturer:</b>	Borqs BeiJing Ltd.
<b>Manufacturer Address:</b>	Tower A, Building B23, Universal Business Park, No. 10 Jiuxianqiao Road, Chaoyang District Beijing, 100015 China

## 1.2. Companion Equipment(Master) Description

<b>Product Name:</b>	Router
<b>Manufacturer:</b>	Cisco
<b>FCC ID:</b>	LDK102091
<b>Serial No:</b>	FGL1848X9S5
<b>Antenna Gain:</b>	2.1 dBi

## 1.3. Equipment Under Test (EUT) Description

<b>Product Name:</b>	Lively Mobile 2
<b>Serial No:</b>	(N/A, marked #1 by test site)
<b>Hardware Version:</b>	DVT3
<b>Software Version:</b>	054
<b>Modulation Type:</b>	OFDM
<b>Modulation Mode:</b>	802.11a, 802.11n(HT20), 802.11n(HT40) 802.11ac(VHT20), 802.11ac(VHT40), 802.11ac(VHT80),
<b>Operating Frequency Range:</b>	5.180 GHz- 5.240 GHz; 5.260 GHz -5.320 GHz ; 5.500 GHz -5.720 GHz ; 5.745GHz- 5.825GHz
<b>Channel Number:</b>	Refer to 1.4
<b>Antenna Type:</b>	FPC Antenna
<b>Antenna Gain:</b>	0.5 dBi



<b>Accessory Information:</b>	Battery	
	Brand Name:	N/A
	Model No.:	ZWD553634V
	Serial No.:	(N/A, marked #1 by test site)
	Capacity:	930mAh
	Rated Voltage:	3.8V
	Charge Limit:	4.35V

**Note 1:** For a more detailed description, please refer to Specification or User’s Manual supplied by the applicant and/or manufacturer.

## 1.4. The channel number and frequency of EUT

Frequency Range: 5180MHz-5240MHz				
Bandwidth	Channel	Frequency (MHz)	Channel	Frequency (MHz)
20MHz	<b>36</b>	<b>5180</b>	40	5200
	<b>44</b>	<b>5220</b>	<b>48</b>	<b>5240</b>
40MHz	<b>38</b>	<b>5190</b>	<b>46</b>	<b>5230</b>
80MHz	<b>42</b>	<b>5210</b>		
Frequency Range: 5260MHz-5320MHz				
Bandwidth	Channel	Frequency (MHz)	Channel	Frequency (MHz)
20MHz	<b>52</b>	<b>5260</b>	56	5280
	<b>60</b>	<b>5300</b>	<b>64</b>	<b>5320</b>
40MHz	<b>54</b>	<b>5270</b>	<b>62</b>	<b>5310</b>
80MHz	<b>58</b>	<b>5290</b>		
Frequency Range: 5500MHz-5720MHz				
Bandwidth	Channel	Frequency (MHz)	Channel	Frequency (MHz)
20MHz	<b>100</b>	<b>5500</b>	105	5520
			108	5540
			116	5580
			124	5620
			132	5660
			140	<b>144</b>
40MHz	<b>102</b>	<b>5510</b>	110	5550
			118	5590
			134	<b>142</b>
80MHz	<b>106</b>	<b>5530</b>	<b>122</b>	<b>5610</b>
	<b>138</b>	<b>5690</b>		
Frequency Range: 5745-5825MHz				
Bandwidth	Channel	Frequency (MHz)	Channel	Frequency (MHz)
20MHz	<b>149</b>	<b>5745</b>	153	5765
	<b>157</b>	<b>5785</b>	161	5805
	<b>165</b>	<b>5825</b>		
40MHz	<b>151</b>	<b>5775</b>	<b>159</b>	<b>5795</b>
80MHz	<b>155</b>	<b>5775</b>		

**Note 1:** The black bold channels were selected for test.



## 1.5. Test Standards and Results

The objective of the report is to perform testing according to 47 CFR Part 15 Subpart E (U-NII band) for the EUT FCC ID Certification:

No	Identity	Document Title
1	47 CFR Part 15 (5-1-14 Edition)	Radio Frequency Devices

Test detailed items/section required by FCC rules and results are as below:

No.	Section	Description	Test Date	Test Engineer	Result
1	15.407(h)	TPC and DFS	Dec 14, 2018	Wang Meng	PASS
<b>Note2:</b> The DFS section for U-NII band is applicable to this report, the other test items are documented in a separate report.					
<b>Note3:</b> These RF tests were performed according to the method of measurements prescribed in KDB 905462 D02 UNII DFS Compliance Procedures New Rules v02.					

## 1.6. Environmental Conditions

During the measurement, the environmental conditions were within the listed ranges:

Temperature (°C):	15 - 35
Relative Humidity (%):	30 -60
Atmospheric Pressure (kPa):	86-106



## 2.47 CFR Part 15C Requirements

### 2.1. Transmit Power Control (TPC) and Dynamic Frequency Selection (DFS)

#### 2.1.1. Requirement

According to FCC section 15.407(h), (1) Transmit power control (TPC). U-NII devices operating in the 5.25-5.35 GHz band and the 5.47-5.725 GHz band shall employ a TPC mechanism. The U-NII device is required to have the capability to operate at least 6 dB below the mean EIRP value of 30 dBm. A TPC mechanism is not required for systems with an e.i.r.p. of less than 500 mW. (2) Radar Detection Function of Dynamic Frequency Selection (DFS). U-NII devices operating with any part of its 26 dB emission bandwidth in the 5.25-5.35 GHz and 5.47-5.725 GHz bands shall employ a DFS radar detection mechanism to detect the presence of radar systems and to avoid co-channel operation with radar systems. Operators shall only use equipment with a DFS mechanism that is turned on when operating in these bands. The device must sense for radar signals at 100 percent of its emission bandwidth. The minimum DFS detection threshold for devices with a maximum e.i.r.p. of 200 mW to 1 W is -64 dBm. For devices that operate with less than 200 mW e.i.r.p. and a power spectral density of less than 10 dBm in a 1 MHz band, the minimum detection threshold is -62 dBm. The detection threshold is the received power averaged over 1 microsecond referenced to a 0 dBi antenna. For the initial channel setting, the manufacturers shall be permitted to provide for either random channel selection or manual channel selection.

A U-NII network will employ a DFS function to detect signals from radar systems and to avoid co-channel operation with these systems. This applies to the 5250-5350 MHz and/or 5470-5725 MHz bands.1

Within the context of the operation of the DFS function, a U-NII device will operate in either Master Mode or Client Mode. U-NII devices operating in Client Mode can only operate in a network controlled by a U-NII device operating in Master Mode.2

Tables 1 and 2 shown below summarize the information contained in sections 5.1.1 and 5.1.2.

**Table 1: Applicability of DFS Requirements Prior to Use of a Channel**

Requirement	Operational Mode		
	Master	Client Without Radar Detection	Client With Radar Detection
Non-Occupancy Period	Yes	Not required	Yes
DFS Detection Threshold	Yes	Not required	Yes
Channel Availability Check Time	Yes	Not required	Not required
U-NII Detection Bandwidth	Yes	Not required	Yes





**Table 2: Applicability of DFS requirements during normal operation**

Requirement	Operational Mode	
	Master	Client Without Radar Detection
DFS Detection Threshold	Yes	Not required
Channel Closing Transmission Time	Yes	Yes
Channel Move Time	Yes	Yes
U-NII Detection Bandwidth	Yes	Not required

Additional requirements for devices with multiple bandwidth modes	Master Device or Client with Radar Detection	Client Without Radar Detection
U-NII Detection Bandwidth and Statistical Performance Check	All BW modes must be tested	Not required
Channel Move Time and Channel Closing Transmission Time	Test using widest BW mode available	Test using the widest BW mode available for the link
All other tests	Any single BW mode	Not required
Note: Frequencies selected for statistical performance check (Section 7.8.4) should include several frequencies within the radar detection bandwidth and frequencies near the edge of the radar detection bandwidth. For 802.11 devices it is suggested to select frequencies in each of the bonded 20 MHz channels and the channel center frequency.		

The operational behavior and individual DFS requirements that are associated with these modes are as follows:

**Master Devices**

- a) The Master Device will use DFS in order to detect Radar Waveforms with received signal strength above the DFS Detection Threshold in the 5250 – 5350 MHz and 5470 – 5725 MHz bands. DFS is not required in the 5150 – 5250 MHz or 5725 – 5825 MHz bands.
- b) Before initiating a network on a Channel, the Master Device will perform a Channel Availability Check for specified time duration (Channel Availability Check Time) to ensure that there is no radar system operating on the Channel, using DFS described under subsection a) above.
- c) The Master Device initiates a U-NII network by transmitting control signals that will enable other U-NII devices to Associate with the Master Device.
- d) During normal operation, the Master Device will monitor the Channel (In-Service Monitoring) to ensure that there is no radar system operating on the Channel, using DFS described under a).
- e) If the Master Device has detected a Radar Waveform during In-Service Monitoring as described under d), the Operating Channel of the U-NII network is no longer an Available Channel. The Master Device will instruct all associated Client Device(s) to stop transmitting on this Channel within the Channel Move Time. The transmissions during the Channel Move Time will be limited to the Channel Closing Transmission Time.



f) Once the Master Device has detected a Radar Waveform it will not utilize the Channel for the duration of the Non-Occupancy Period. 3

g) If the Master Device delegates the In-Service Monitoring to a Client Device, then the combination will be tested to the requirements described under d) through f) above.

**Client Devices**

a) A Client Device will not transmit before having received appropriate control signals from a Master Device.

b) A Client Device will stop all its transmissions whenever instructed by a Master Device to which it is associated and will meet the Channel Move Time and Channel Closing Transmission Time requirements. The Client Device will not resume any transmissions until it has again received control signals from a Master Device.

c) If a Client Device is performing In-Service Monitoring and detects a Radar Waveform above the DFS Detection Threshold, it will inform the Master Device. This is equivalent to the Master Device detecting the Radar Waveform and d) through f) of section 5.1.1 apply.

d) Irrespective of Client Device or Master Device detection the Channel Move Time and Channel Closing Transmission Time requirements remain the same.

e) The client test frequency must be monitored to ensure no transmission of any type has occurred for 30 minutes. Note: If the client moves with the master, the device is considered compliant if nothing appears in the client non-occupancy period test. For devices that shut down (rather than moving channels), no beacons should appear.

**DFS Detection Thresholds**

Table 3 below provides the DFS Detection Thresholds for Master Devices as well as Client Devices incorporating In-Service Monitoring.

**Table 3: DFS Detection Thresholds for Master Devices and Client Devices with Radar Detection**

Maximum Transmit Power	Value (See Notes 1, 2, and 3)
EIRP $\geq$ 200 milliwatt	-64 dBm
EIRP < 200 milliwatt and power spectral density < 10 dBm/MHz	-62 dBm
EIRP < 200 milliwatt that do not meet the power spectral density requirement	-64 dBm
Note 1: This is the level at the input of the receiver assuming a 0 dBi receive antenna. Note 2: Throughout these test procedures an additional 1 dB has been added to the amplitude of the test transmission waveforms to account for variations in measurement equipment. This will ensure that the test signal is at or above the detection threshold level to trigger a DFS response. Note3: EIRP is based on the highest antenna gain. For MIMO devices refer to KDB Publication 662911 D01.	

Response Requirements

Table 4 provides the response requirements for Master and Client Devices incorporating DFS.

**Table 4: DFS Response Requirement Values**

Parameter	Value
Non-occupancy period	Minimum 30 minutes
Channel Availability Check Time	60 seconds
Channel Move Time	10 seconds See Note 1.
Channel Closing Transmission Time	200 milliseconds + an aggregate of 60 milliseconds over remaining 10 second period. See Notes 1 and 2.
U-NII Detection Bandwidth	Minimum 100% of the U-NII 99% transmission power bandwidth. See Note 3.

**Note 1:** Channel Move Time and the Channel Closing Transmission Time should be performed with Radar Type 0. The measurement timing begins at the end of the Radar Type 0 burst.

**Note 2:** The Channel Closing Transmission Time is comprised of 200 milliseconds starting at the beginning of the Channel Move Time plus any additional intermittent control signals required to facilitate a Channel move (an aggregate of 60 milliseconds) during the remainder of the 10 second period. The aggregate duration of control signals will not count quiet periods in between transmissions.

**Note 3:** During the U-NII Detection Bandwidth detection test, radar type 0 should be used. For each frequency step the minimum percentage of detection is 90 percent. Measurements are performed with no data traffic.

**2.1.2. Test Description**

According to Section 7.2 of KDB 905462 D02 V01R01

1. Setup for Master with injection at the Master

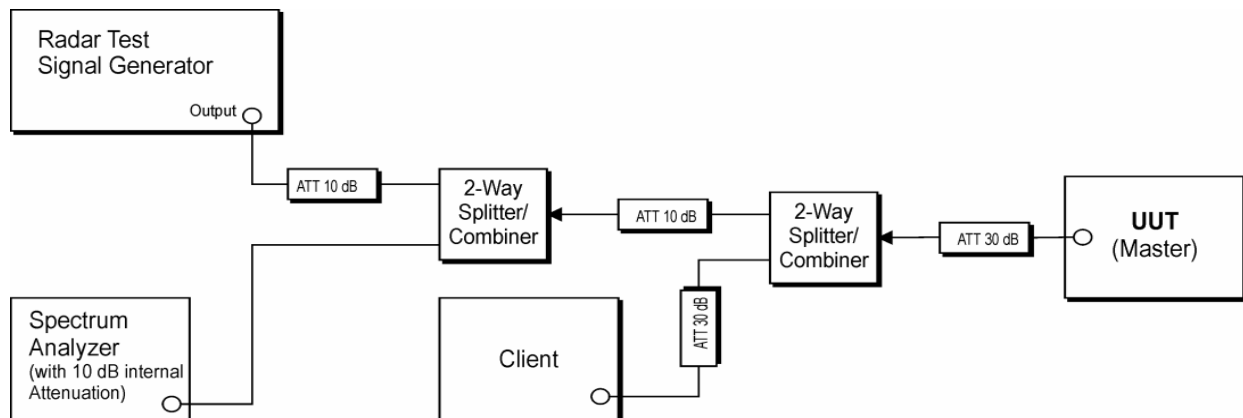

(Example Conducted Setup where UUT is a Master and Radar Test Waveforms are injected into the Master)

2. Setup for Client with injection at the Master

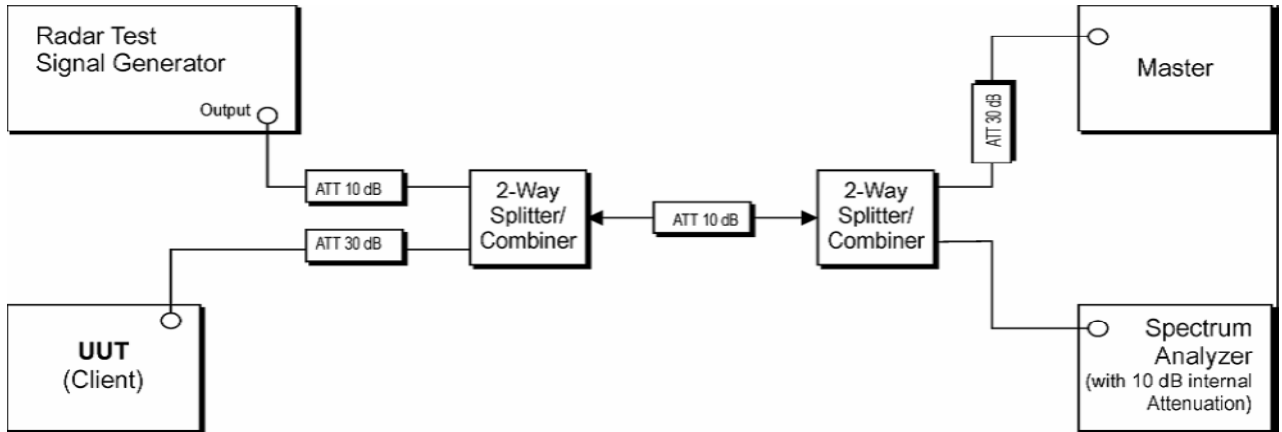

(Example Conducted Setup where UUT is a Client and Radar Test Waveforms are injected into the Master)

3. Setup for Client with injection at the Client

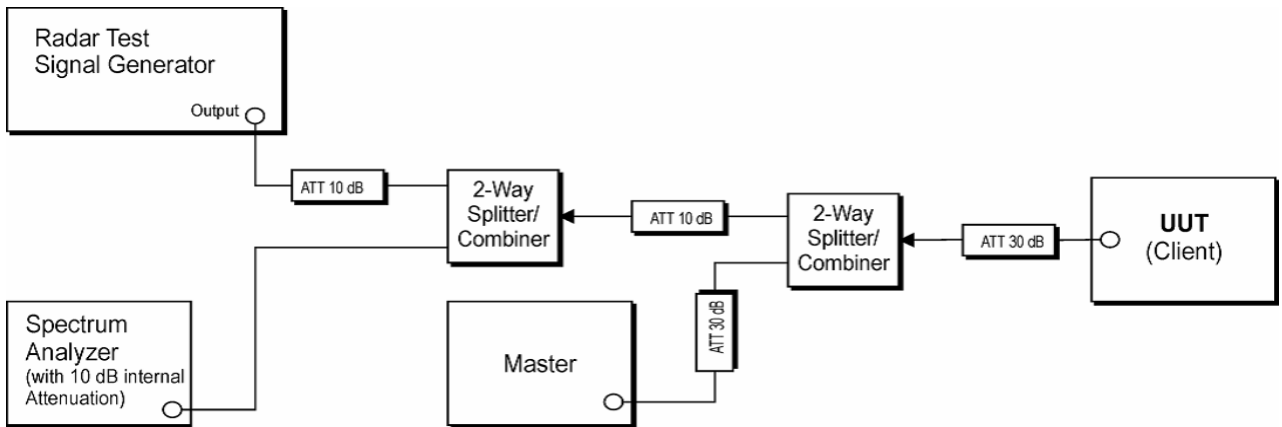

(Example Conducted Setup where UUT is a Client and Radar Test Waveforms are injected into the Client)



2.1.3. Test Result

a. Test sequence and Channel loading between Master and Client

Test Channel	Frequency(MHz)	Payload
62	5310	40.13%

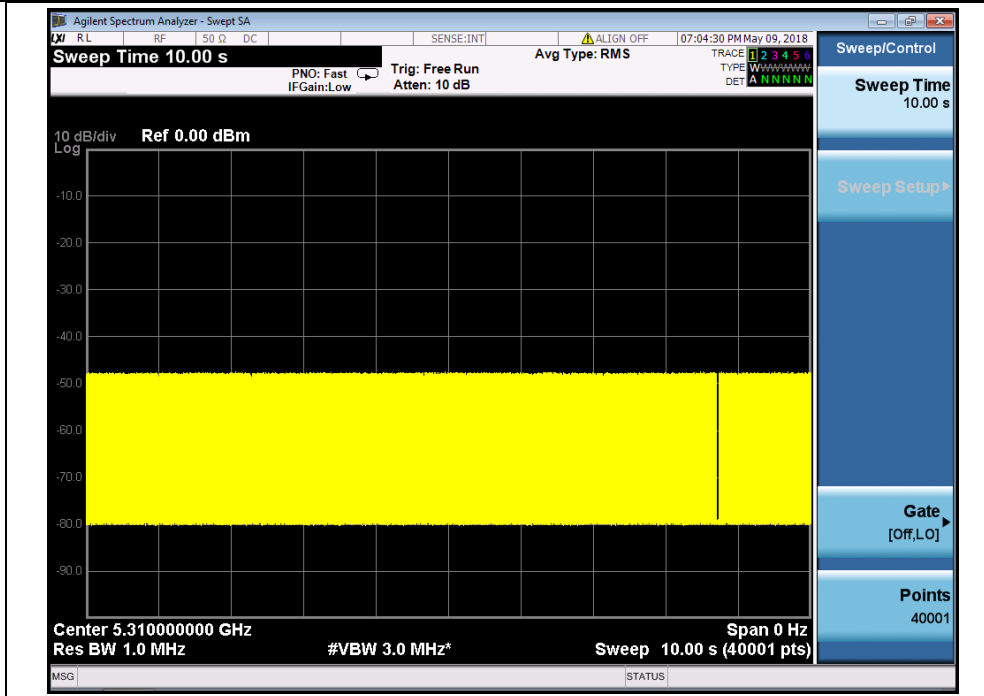

(Test sequence)

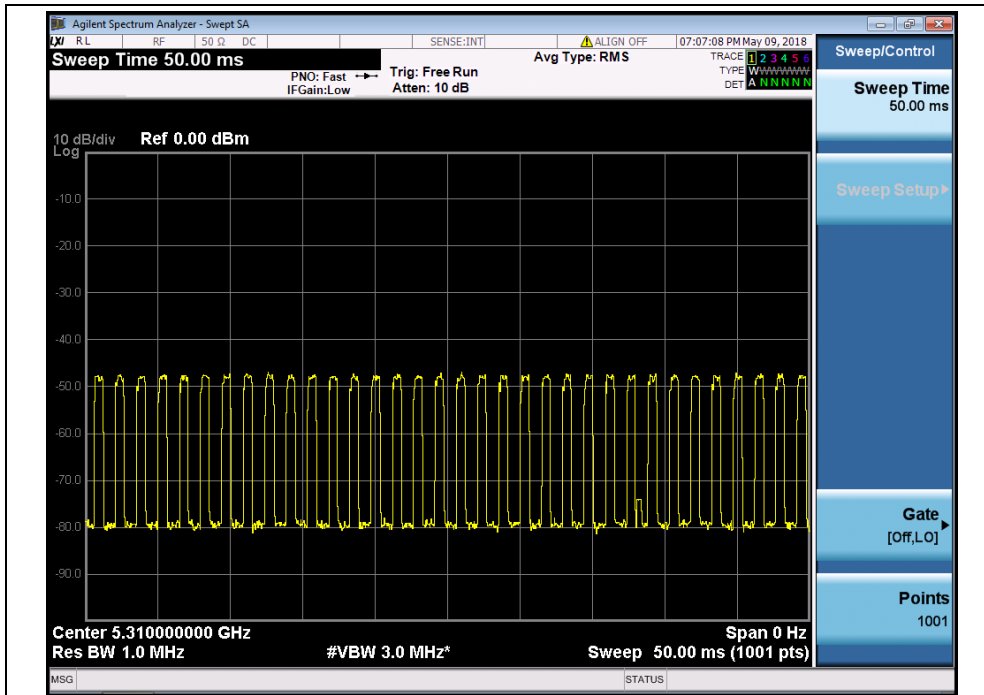

(Payload)



b. Radar Test Waveforms are injected into the Master:

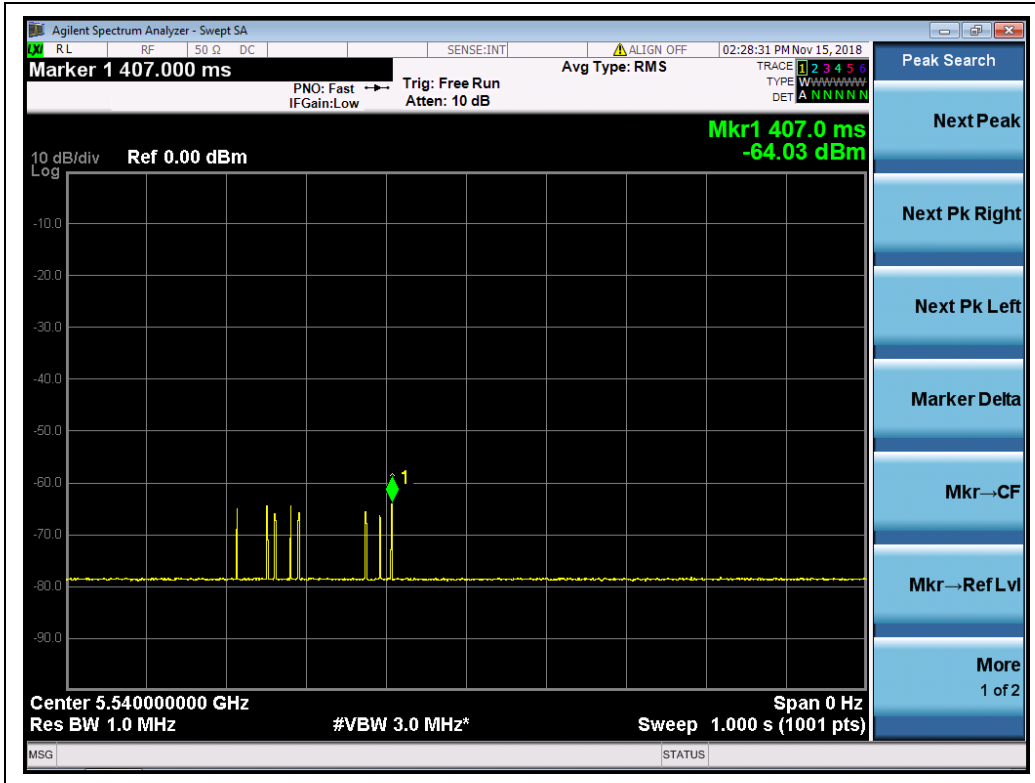

**c. EUT is a Client Device Without Radar Detection :**

Channel & Bandwidth	Requirement	Operational Mode	Test Result	Limit	Verdict
		Client Without Radar Detection			
802.11 a 5240MHz	Channel Move Time	Yes	1.246s	<10s	PASS
	Channel Closing Transmission Time	Yes	0.223s	<1s	PASS
802.11 a 5280MHz	Channel Move Time	Yes	0.598s	<10s	PASS
	Channel Closing Transmission Time	Yes	0.003s	<1s	PASS
802.11 a 5520MHz	Channel Move Time	Yes	0.686 s	<10s	PASS
	Channel Closing Transmission Time	Yes	0.003s	<1s	PASS
802.11 ac(VHT80) 5210MHz	Channel Move Time	Yes	0.623s	<10s	PASS
	Channel Closing Transmission Time	Yes	0.004s	<1s	PASS
802.11 ac(VHT80) 5290MHz	Channel Move Time	Yes	0.623s	<10s	PASS
	Channel Closing Transmission Time	Yes	0.004s	<1s	PASS
802.11 ac(VHT80) 5610MHz	Channel Move Time	Yes	0.580s	<10s	PASS
	Channel Closing Transmission Time	Yes	0.002s	<1s	PASS



**Test Plots**

**Note:** T0 denotes the start time of the Radar single transmitted, T1 denotes the end time of the Radar single transmit end. T2 denotes the data transmission time of 200ms from T1. T3 denotes the end of the Channel Move Time, the time of T3 from T1 is less than 12s.

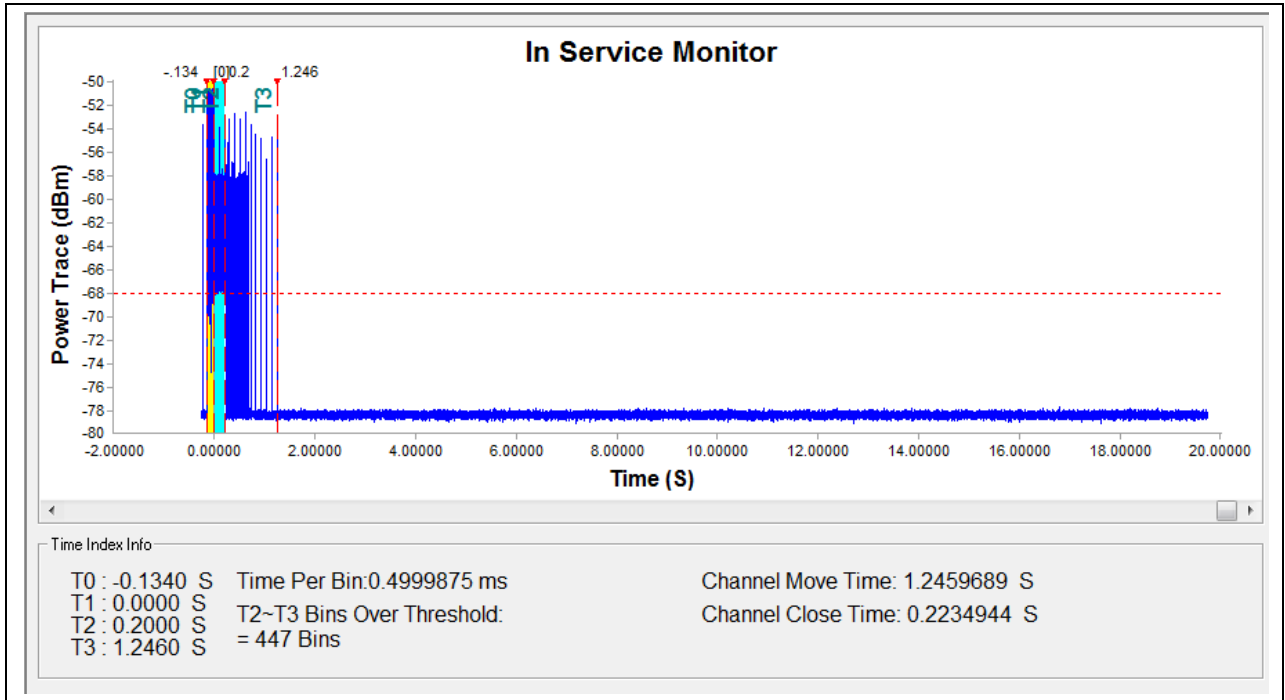

(5240MHz, 802.11a)

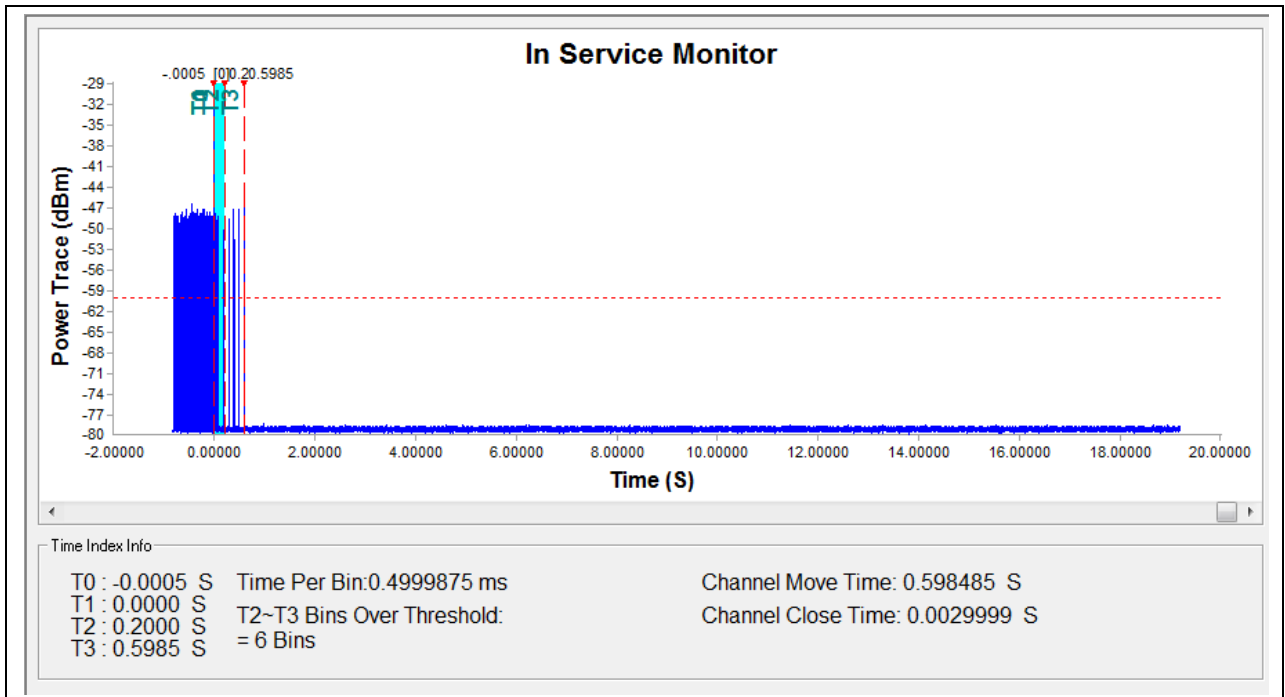

(5280MHz, 802.11a)



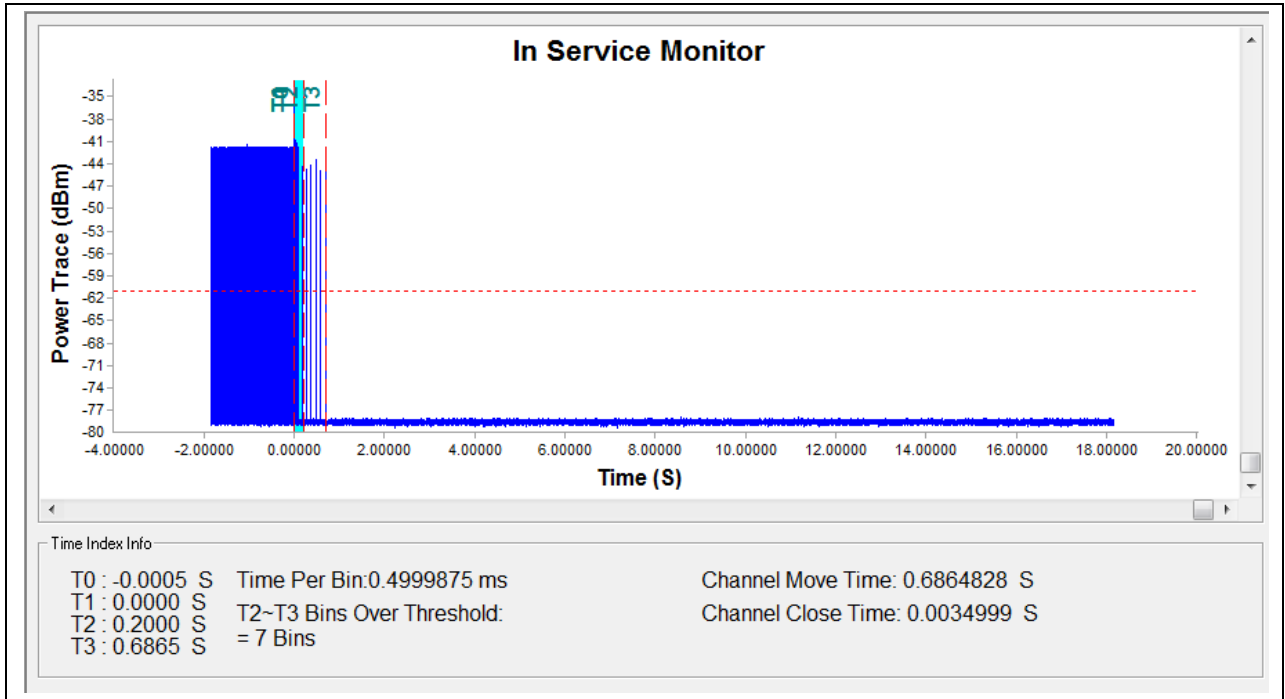

(5520MHz, 802.11a)

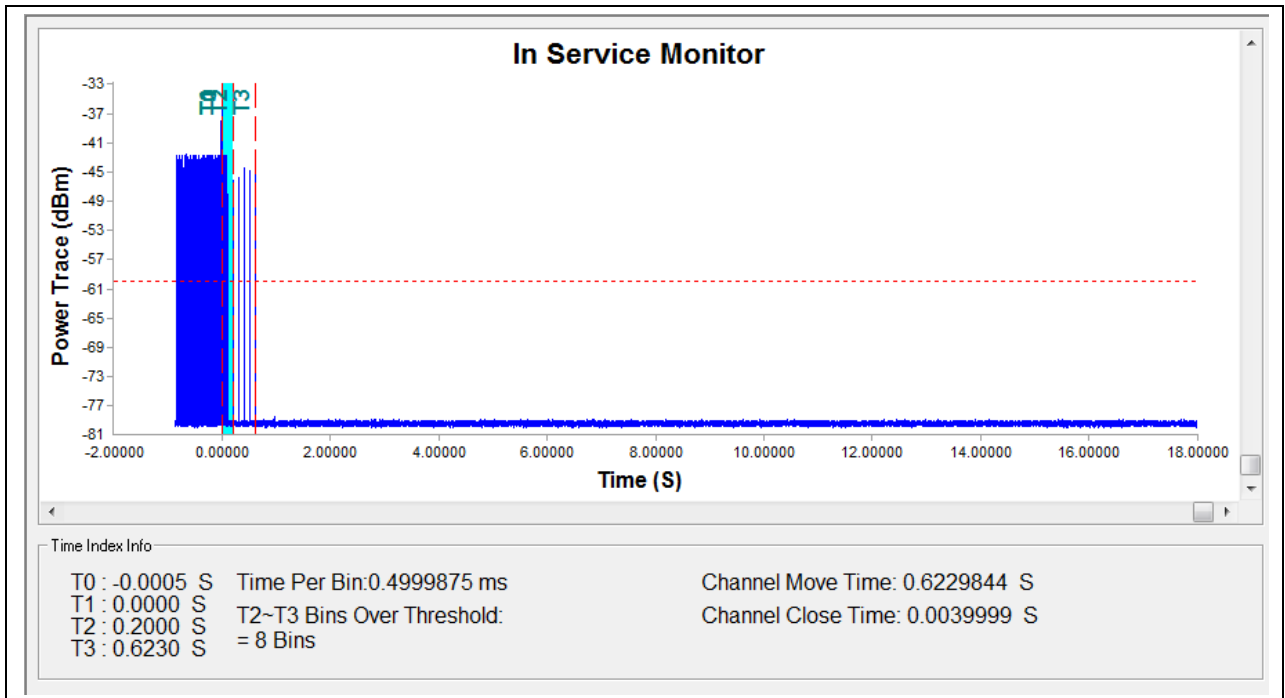

(5210MHz, 802.11ac (VHT80))

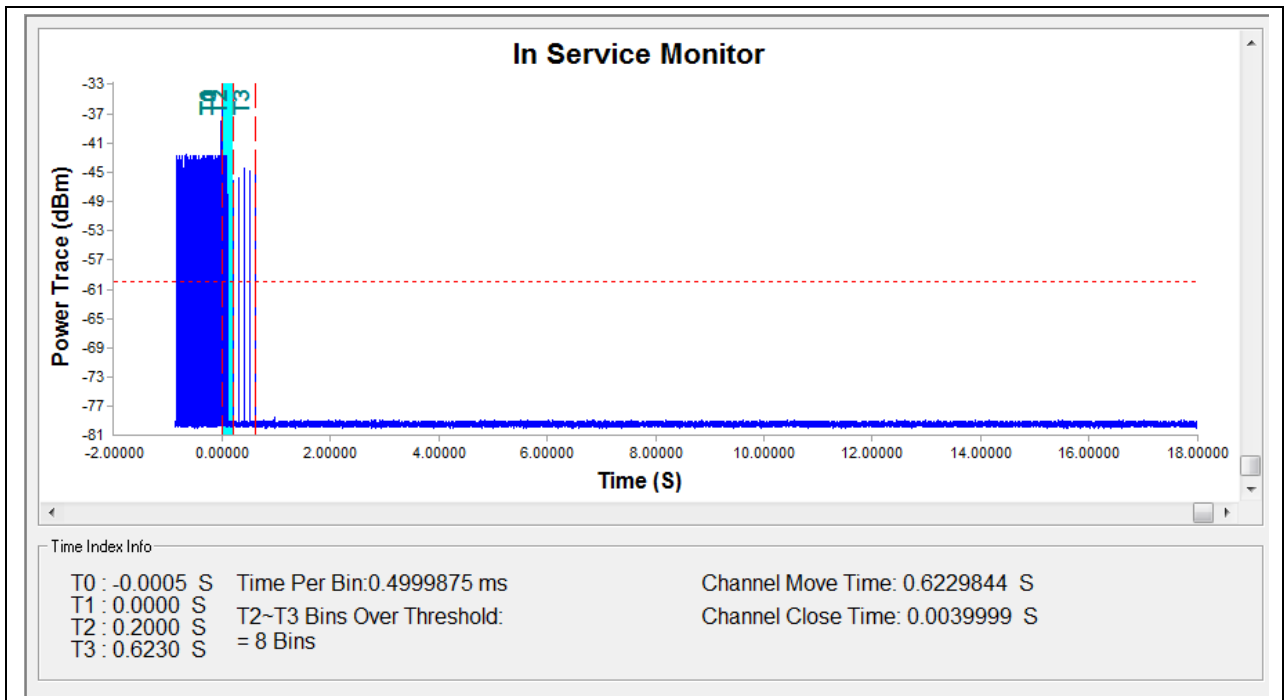

(5290MHz, 802.11ac (VHT80))

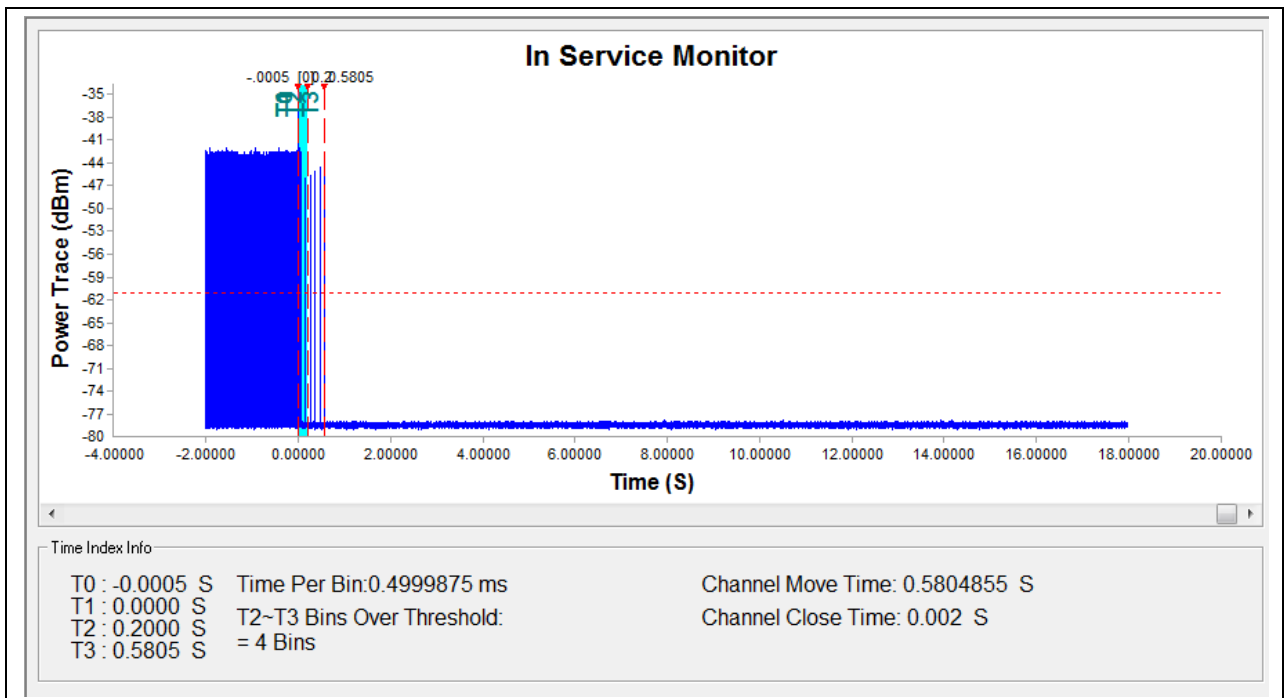

(5610MHz, 802.11ac (VHT80))



d. Time per bin

Channel	Frequency (MHz)	Time Per Bin (ms)
49	5240	0.50
56	5280	0.50
104	5520	0.50
42	5210	0.50
58	5290	0.50
122	5610	0.50

Test Plot

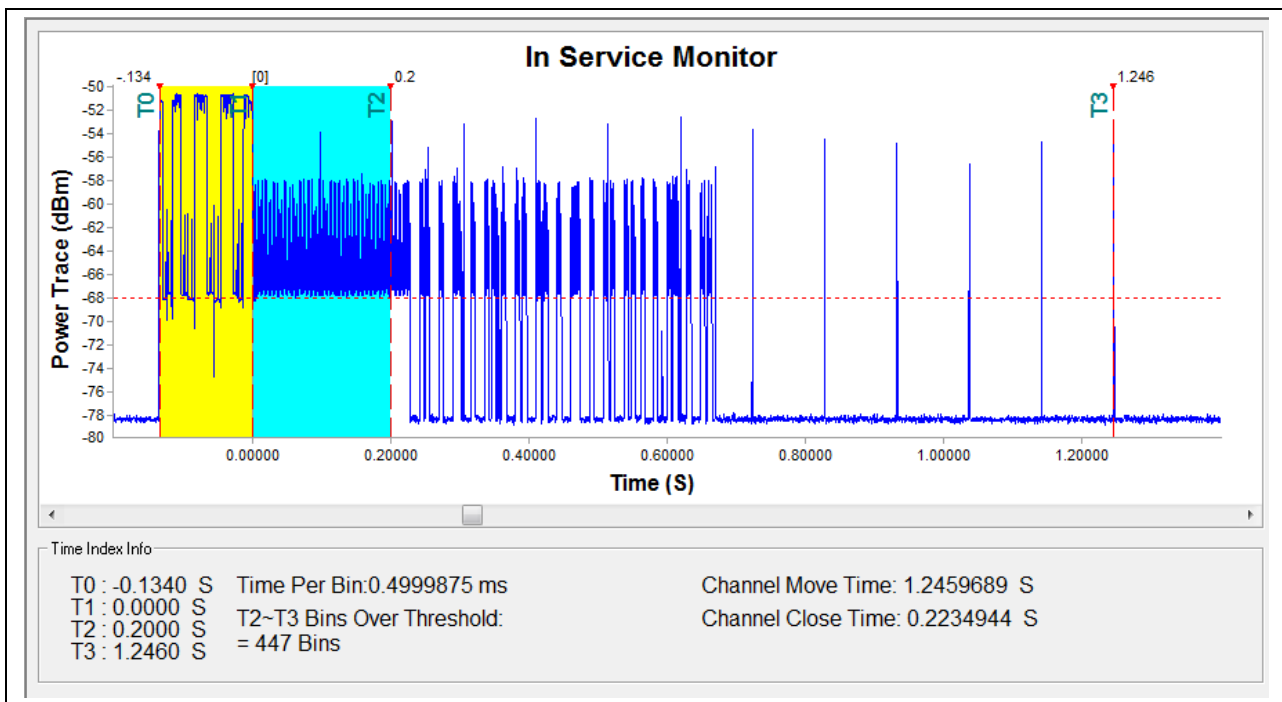

(5240MHz, 802.11a)

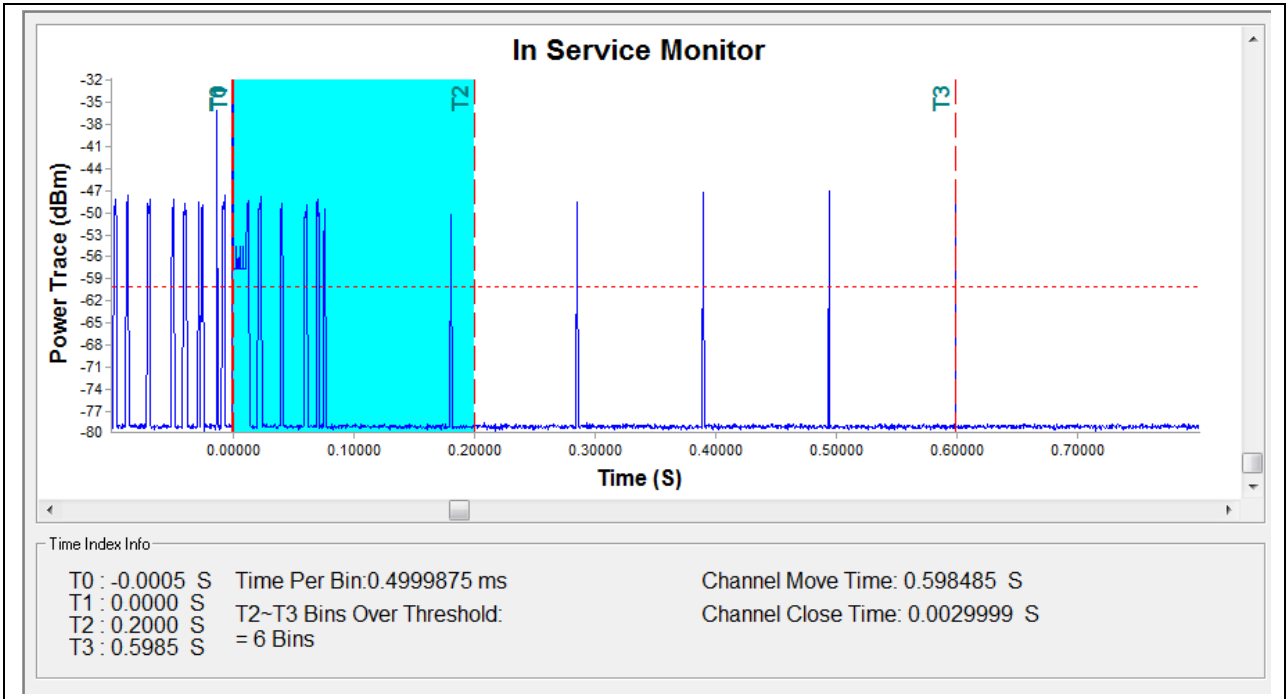

(5280MHz, 802.11a)

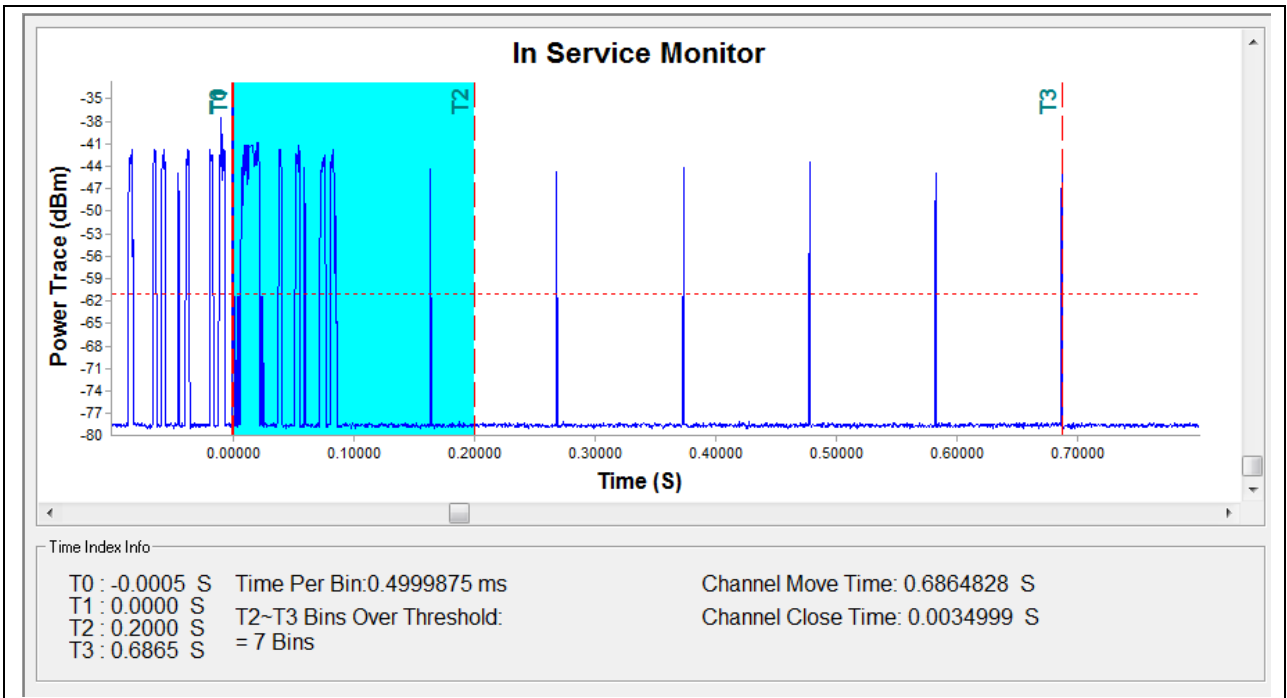

(5520MHz, 802.11a)

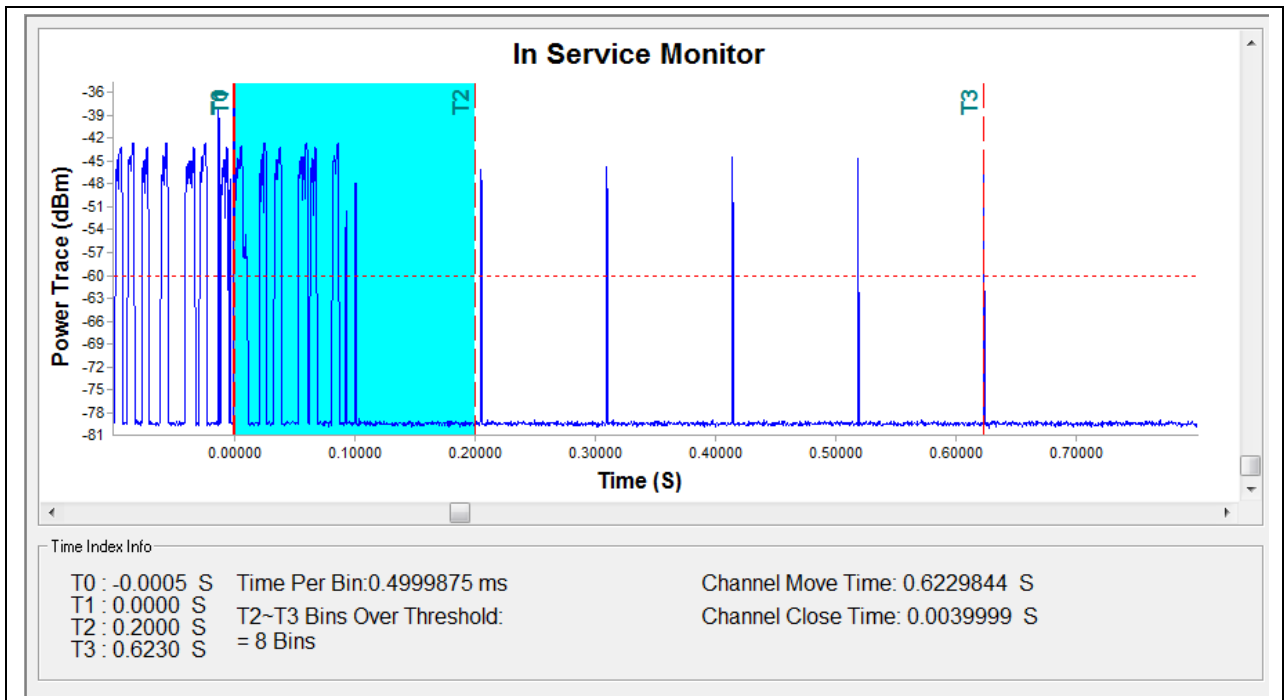

(5210MHz, 802.11ac (VHT80))

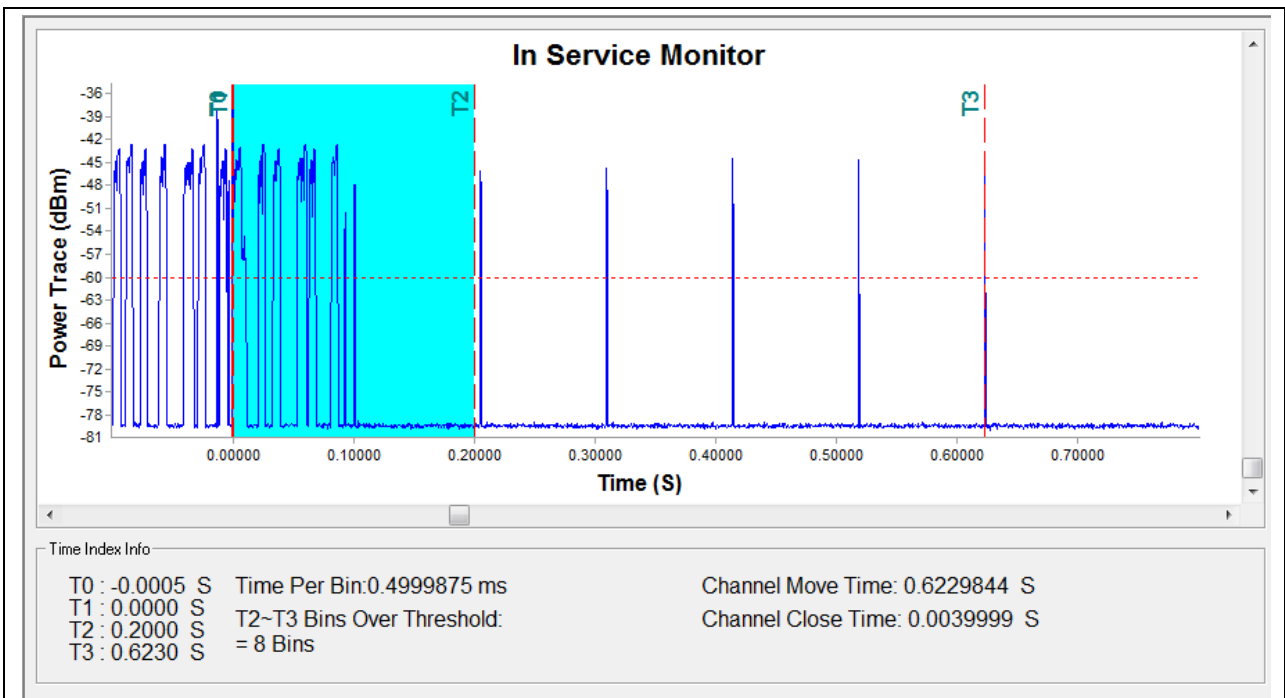

(5290MHz, 802.11ac (VHT80))

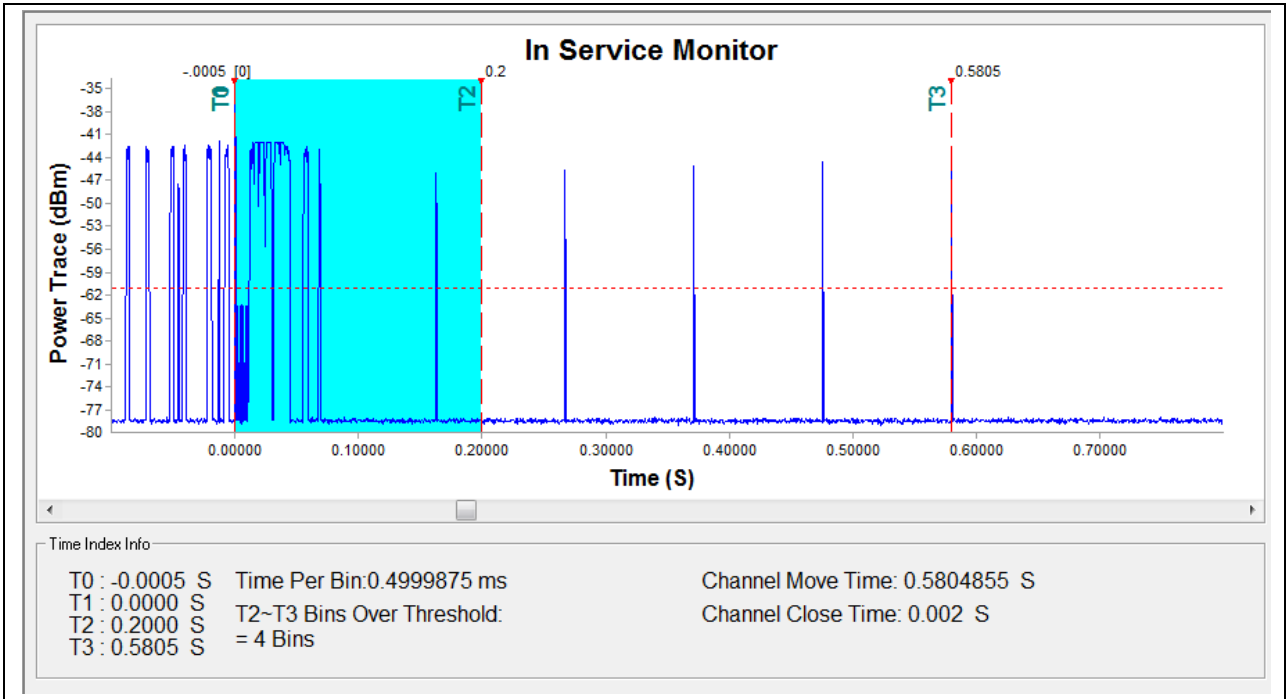

(5610MHz, 802.11ac (VHT80))



**verification of Non-occupancy time**

The sweep time is 2.1ks(35min) which is able to meet the requirements of Non-occupancy time.

Channel & Bandwidth	Test Result	Limit	Verdict
802.11 a 5520MHz	35min	≥30min	PASS

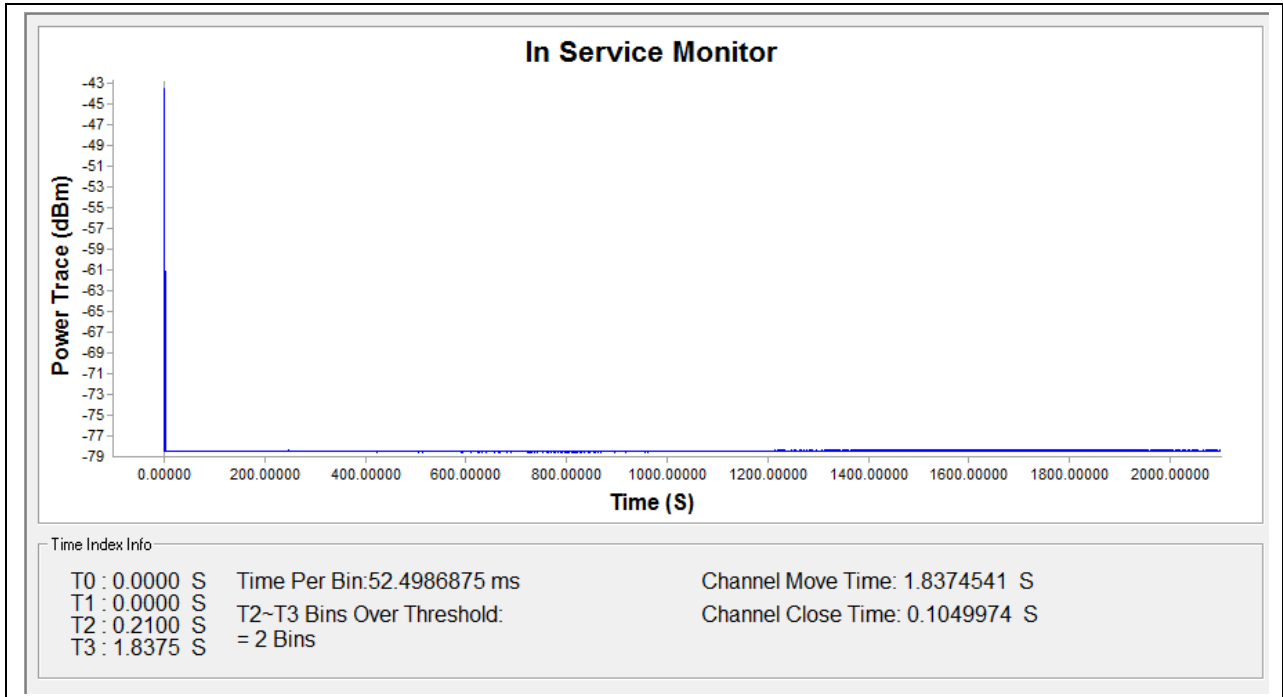

(Non-occupancy time, 5520MHz, 802.11a)

# Annex A The waveform of the radar



(Type 0)

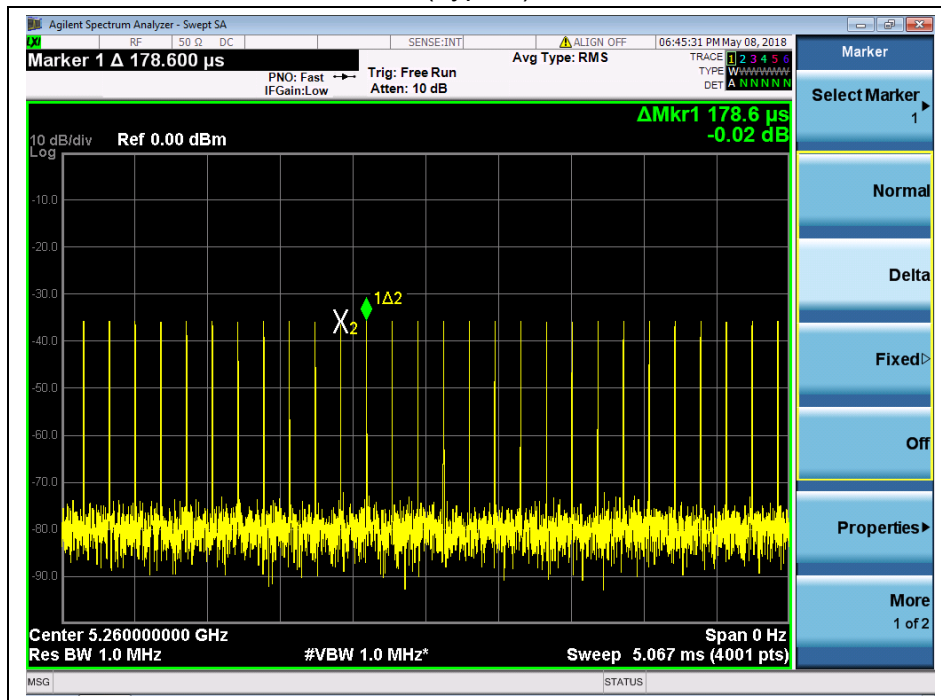

(Type 1)



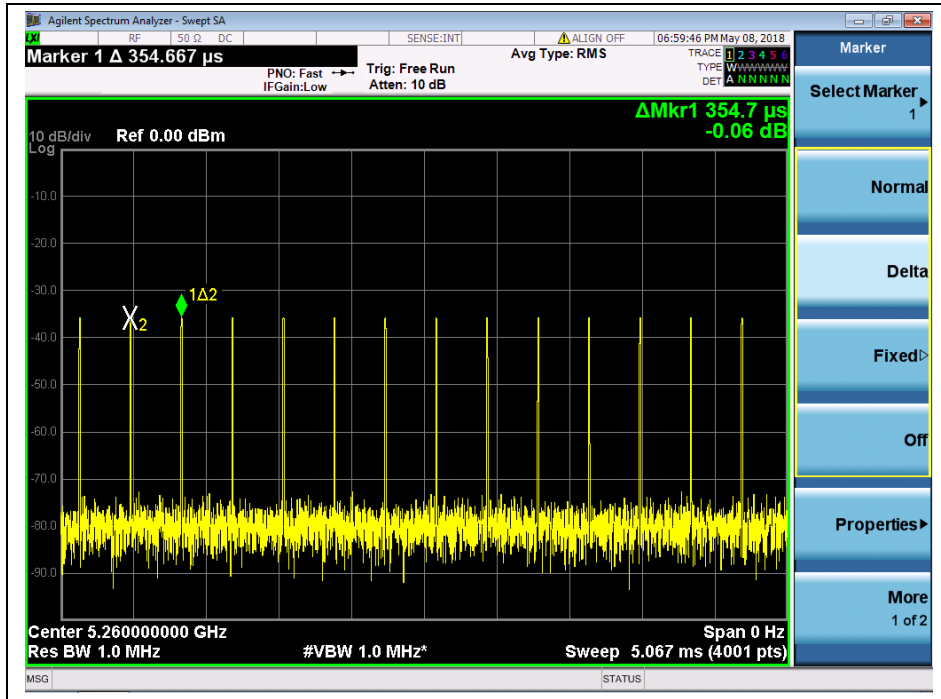

(Type 2)

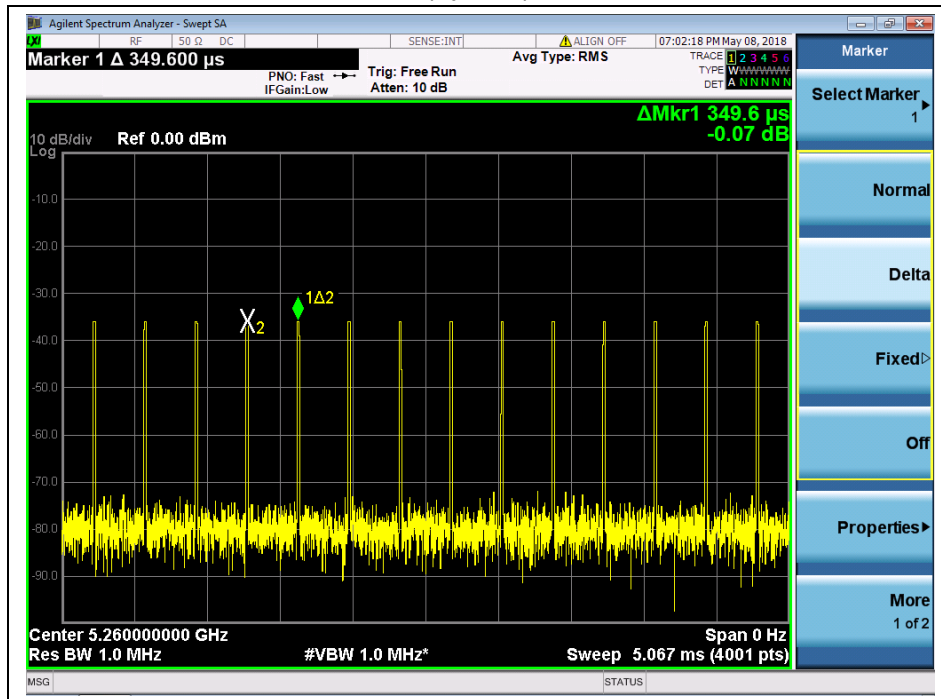

(Type 3)

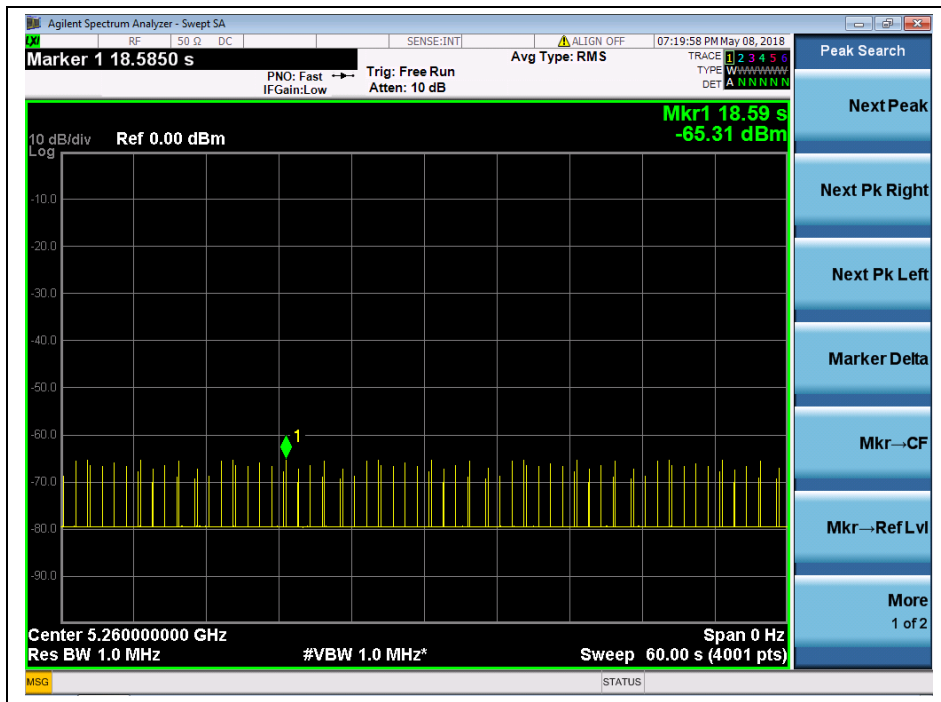

(Type 4)

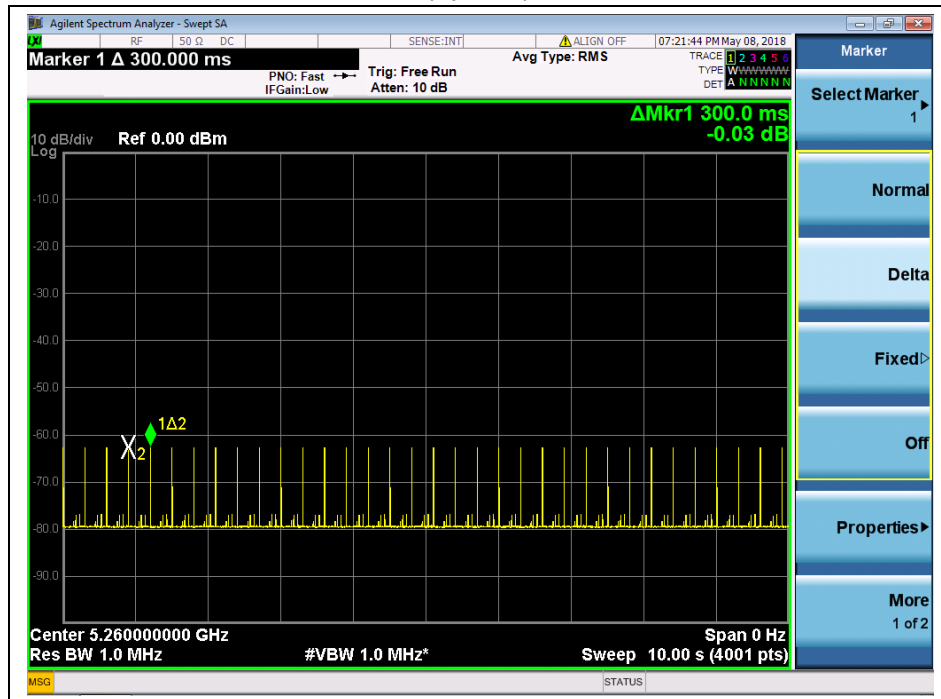

(Type 5)



## Annex B Test Uncertainty

Where relevant, the following measurement uncertainty levels have been estimated for test performed on the EUT as specified in CISPR 16-1-2:

Test items	Uncertainty
Bandwidth	±5%
Conducted Emission	±2.44dB

This uncertainty represent an expanded uncertainty expressed at approximately the 95% confidence level using a coverage factor of k=2



## Annex C Testing Laboratory Information

### 1. Identification of the Responsible Testing Laboratory

<b>Laboratory Name:</b>	Shenzhen Morlab Communications Technology Co., Ltd. Morlab Laboratory
<b>Laboratory Address:</b>	FL.3, Building A, FeiYang Science Park, No.8 LongChang Road, Block 67, BaoAn District, ShenZhen, GuangDong Province, P. R. China
<b>Telephone:</b>	+86 755 36698555
<b>Facsimile:</b>	+86 755 36698525

### 2. Identification of the Responsible Testing Location

<b>Name:</b>	Shenzhen Morlab Communications Technology Co., Ltd. Morlab Laboratory
<b>Address:</b>	FL.3, Building A, FeiYang Science Park, No.8 LongChang Road, Block 67, BaoAn District, ShenZhen, GuangDong Province, P. R. China

### 3. Facilities and Accreditations

All measurement facilities used to collect the measurement data are located at FL.3, Building A, FeiYang Science Park, Block 67, BaoAn District, Shenzhen, 518101 P. R. China. The test site is constructed in conformance with the requirements of ANSI C63.10-2013 and CISPR Publication 22; the FCC designation number is CN1192, the test firm registration number is 226174.



#### 4. Test Equipments Utilized

##### 4.1 Conducted Test Equipments

Equipment Name	Serial No.	Type	Manufacturer	Cal. Date	Cal. Due
Power Splitter	NW521	1506A	Weinschel	2018.04.17	2019.04.16
Attenuator 1	(N/A.)	10dB	Resnet	2018.04.17	2019.04.16
Attenuator 2	(N/A.)	3dB	Resnet	2018.04.17	2019.04.16
EXA Signal Analyzer	MY53470836	N9010A	Agilent	2018.11.06	2019.11.05
MXG Vector Signal Generator	Angilent	N5182B	MY53050961	2018.04.17	2019.04.16
RF cable (30MHz-26GHz)	CB01	RF01	Morlab	N/A	N/A
Coaxial cable	CB02	RF02	Morlab	N/A	N/A
SMA connector	CN01	RF03	HUBER-SUHNER	N/A	N/A
Computer	T430i	Think Pad	Lenovo	N/A	N/A

\_\_\_\_\_ END OF REPORT \_\_\_\_\_