



# TEST REPORT

*For*

**Applicant :** Ocean Digital Technology Ltd

**Address :** Flat B, 12/F., Yeung Yiu Chung (No.8) Ind. Bldg., 20  
Wang Hoi Road, Kowloon Bay, Hong Kong.

**Product Name :** Internet Radio

**Model Name :** MS-60i, WR-60

**Remark :** Only different in model name.

**Brand Name :** N/A

**FCC Number :** FCC ID: 2ABD3-MS60I00000

**Report No. :** MTE/CEC/S16092109

**Date of Issue :** Sep. 29, 2016

**Issued by :** Most Technology Service Co., Limited

**Address :** No.5, 2nd Langshan Road, North District, Hi-tech Industrial  
Park, Nanshan, Shenzhen, Guangdong, China

**Tel :** 86-755-8602 6850

**Fax :** 86-755-2601 3350

*The report consists 50 pages in total. It may be duplicated completely for legal use with the approval of the applicant. It should not be reproduced except in full, without the written approval of our laboratory. The client should not use it to claim product endorsement by MOST. The test results in the report only apply to the tested sample. The test report shall be invalid without all the signatures of testing engineers, reviewer and approver.*

## TABLE OF CONTENTS

<b>1. PRODUCT INFORMATION</b> .....	<b>4</b>
<b>2. GENERAL INFORMATION</b> .....	<b>5</b>
2.1 Product Information.....	5
2.2 Objective .....	5
2.3 Test Standards and Results.....	6
2.4 Environmental Conditions.....	6
<b>3. TEST METHODOLOGY</b> .....	<b>7</b>
3.1 TEST FACILITY .....	7
3.2 GENERAL TEST PROCEDURES .....	7
<b>4. SETUP OF EQUIPMENT UNDER TEST</b> .....	<b>8</b>
4.1 SETUP CONFIGURATION OF EUT .....	8
4.2 SUPPORT EQUIPMENT .....	8
4.3 TEST EQUIPMENT LIST .....	9
<b>5. ANTENNA REQUIREMENT</b> .....	<b>10</b>
5.1 Applicable Standard .....	10
5.1.1 Evaluation Criteria.....	10
5.1.2 Result: Compliance. ....	10
5.2 AC Power Line Conducted Emission.....	11
5.2.1 Requirement .....	11
5.2.2 Block Diagram of Test Setup .....	11
5.2.3 Test procedure .....	11
5.2.4 Test Result .....	11
5.3 Radiated Emission .....	14
5.3.1 Requirement .....	14
5.3.2 Test Configuration .....	14
5.3.3 Test Procedure: .....	15
5.3.4 Test Result .....	16
5.4 Conducted Peak Output Power.....	23
5.4.1 Requirement .....	23
5.4.2 Block Diagram of Test Setup .....	23
5.4.3 Test Procedure .....	23
5.4.4 Test Result .....	23
5.5 6dB Emission Bandwidth .....	24
5.5.1 Test Requirement .....	24
5.5.2 Block Diagram of Test Setup .....	24
5.5.3 Test Procedure .....	24
5.5.4 Test Result .....	24
5.6 POWER SPECTRAL DENSITY.....	29
5.6.1 Applicable Standard .....	29
5.6.2 Block Diagram of Test Setup .....	29
5.6.3 Test Procedure .....	29
5.6.4 Test Result .....	29
5.7 Band Edge and Conducted Spurious Emissions .....	34
5.7.1 Test Requirement .....	34
5.7.2 Test Procedure .....	34
5.7.3 Test Result .....	34
5.8 Restricted Frequency Bands.....	38

5.8.1 Test Requirement ..... 38  
5.8.2 Test Configuration ..... 38  
5.8.3 Test Procedure: ..... 38  
5.8.4 Test Result ..... 38



**1. PRODUCT INFORMATION**

<b>Equipment Under Test:</b>	Internet Radio
<b>Brand Name:</b>	N/A
<b>Model Number:</b>	MS-60i
<b>FCC Number:</b>	FCC ID: 2ABD3-MS60I00000
<b>Applicant:</b>	Ocean Digital Technology Ltd Flat B, 12/F., Yeung Yiu Chung (No.8) Ind. Bldg., 20 Wang Hoi Road, Kowloon Bay, Hong Kong.
<b>Manufacturer:</b>	Ocean Digital Technology Ltd Flat B, 12/F., Yeung Yiu Chung (No.8) Ind. Bldg., 20 Wang Hoi Road, Kowloon Bay, Hong Kong.
<b>Technical Standards:</b>	47 CFR Part 15 Subpart C (Part 15.247 of the FCC Rules)
<b>File Number:</b>	MTE/CEC/S16092109
<b>Date of test:</b>	Sep.13-28,2016
<b>Deviation:</b>	None
<b>Condition of Test Sample:</b>	Normal
<b>Test Result:</b>	PASS

The above equipment was tested by Most Technology Service Co., Limited for compliance with the requirements set forth in FCC rules and the Technical Standards mentioned above. This said equipment in the configuration described in this report shows the maximum emission levels emanating from equipment and the level of the immunity endurance of the equipment are within the compliance requirements.

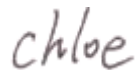
The test results of this report relate only to the tested sample identified in this report.

Tested by (+ signature):   
Chloe Cai(Engineer) Sep.13-28,2016

Review by (+ signature):    
John Lin(Engineer) Sep.29,2016

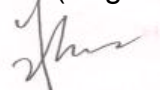
Approved by (+ signature):   
Yvette Zhou(Manager) Sep.29,2016

## 2. GENERAL INFORMATION

### 2.1 Product Information

<b>Product</b>	Internet Radio
<b>Brand Name</b>	iLuv
<b>Model Number</b>	MS-60i
<b>Series Model Name:</b>	WB-18
<b>Series Model Difference description:</b>	Only different in model name.
<b>Power Supply</b>	DC 9 V by Adapter
<b>Frequency Range</b>	802.11b/g/n(20MHz): 2412-2462MHz
<b>Modulation Type:</b>	IEEE 802.11b mode: DSSS IEEE 802.11g mode: OFDM IEEE 802.11n Standard-20 MHz Channel mode: OFDM
<b>Channel Number</b>	11
<b>Antenna Type</b>	Internal Antenna, Antenna Gain:, 3 dBi
<b>Temperature Range</b>	-10°C ~ +40°C

**NOTE:**

1. For a more detailed features description about the EUT, please refer to User's Manual.

### 2.2 Objective

The objective of the report is to perform tests according to FCC Part 15 Subpart C for the EUT FCC ID Certification:

No.	Identity	Document Title
1	47 CFR Part 15	Radio Frequency Devices
2	KDB 558074	Guidance for Performing Compliance Measurements on Digital Transmission Systems (DTS) Operating Under §15.247

## 2.3 Test Standards and Results

No.	Section	Test Items	Result	Date of Test
1	FCC 15.203	Antenna Requirement	PASS	2016-09-20
2	FCC15.207 (a)	AC Power Line Conducted Emission	PASS	2016-09-20
3	FCC15.209, 15.247(d)	Radiated Emission	PASS	2016-09-20
4	FCC15.247(b)(3)	Conducted Peak Output Power	PASS	2016-09-21
5	FCC15.247(a)(2)	6dB Emission Bandwidth	PASS	2016-09-21
6	FCC15.247(e)	Power Spectral Density	PASS	2016-09-21
7	FCC15.247(d)	Band Edge and Conducted Spurious Emissions	PASS	2016-09-21
8	FCC15.247(d)	Restricted Frequency Bands	PASS	2016-09-21

Note: 1. The test result judgment is decided by the limit of measurement standard  
 2. The information of measurement uncertainty is available upon the customer's request.

## 2.4 Environmental Conditions

During the measurement the environmental conditions were within the listed ranges:

- Temperature: 15-35°C
- Humidity: 30-60 %
- Atmospheric pressure: 86-106 kPa

### 3. TEST METHODOLOGY

#### 3.1 TEST FACILITY

<b>Test Site:</b>	Most Technology Service Co., Ltd
<b>Location:</b>	No.5, Langshan 2nd Rd., North Hi-Tech Industrial park, Nanshan, Shenzhen, Guangdong, China
<b>Description:</b>	There is one 3m semi-anechoic an area test sites and two line conducted labs for final test. The Open Area Test Sites and the Line Conducted labs are constructed and calibrated to meet the FCC requirements in documents ANSI C63.10:2013 and CISPR 16 requirements. The FCC Registration Number is <b>490827</b> . The IC Registration Number is <b>7103A-1</b> .
<b>Site Filing:</b>	The site description is on file with the Federal Communications Commission, 7435 Oakland Mills Road, Columbia, MD 21046.
<b>Instrument</b>	All measuring equipment is in accord with ANSI C63.10:2013 and CISPR 16
<b>Tolerance:</b>	requirements that meet industry regulatory agency and accreditation agency requirement.
<b>Ground Plane:</b>	Two conductive reference ground planes were used during the Line Conducted Emission, one in vertical and the other in horizontal. The dimensions of these ground planes are as below. The vertical ground plane was placed distancing 40 cm to the rear of the wooden test table on where the EUT and the support equipment were placed during test. The horizontal ground plane projected 50 cm beyond the footprint of the EUT system and distanced 80 cm to the wooden test table. For Radiated Emission Test, one horizontal conductive ground plane extended at least 1m beyond the periphery of the EUT and the largest measuring antenna, and covered the entire area between the EUT and the antenna.

#### 3.2 GENERAL TEST PROCEDURES

##### Radiated Emissions

The EUT is placed on a turn table, which is 1.5 m above ground plane. The turntable shall rotate 360 degrees to determine the position of maximum emission level. EUT is set 3m away from the receiving antenna, which varied from 1m to 4m to find out the highest emission. And also, each emission was to be maximized by changing the polarization of receiving antenna both horizontal and vertical. In order to find out the maximum emissions, exploratory radiated emission measurements were made according to the requirements in Section 6.5 of ANSI C63.10:2013.

##### Conducted Emissions

The EUT is placed on the turntable, which is 0.8 m above ground plane. According to the requirements in Section 6.2 of ANSI C63.10:2013, Conducted emissions from the EUT measured in the frequency range between 0.15 MHz and 30MHz using CISPR Quasi-peak and average detector modes.

## 4. SETUP OF EQUIPMENT UNDER TEST

### 4.1 SETUP CONFIGURATION OF EUT

See test photographs attached in Appendix 1 for the actual connections between EUT and support equipment.

### 4.2 SUPPORT EQUIPMENT

Device Type	Manufacturer	Model Name	Serial No.	Data Cable	Power Cable
---	---	---	---	---	---

*Remark:*

*All the equipment/cables were placed in the worst-case configuration to maximize the emission during the test. Grounding was established in accordance with the manufacturer's requirements and conditions for the intended use.*



### 4.3 TEST EQUIPMENT LIST

**Instrumentation:** The following list contains equipment used at Most for testing. The equipment conforms to the CISPR 16-1 / ANSI C63.2 Specifications for Electromagnetic Interference and Field Strength Instrumentation from 10 kHz to 1.0 GHz or above.

No.	Equipment	Manufacturer	Model No.	S/N	Calibration date	Calibration Interval
1	Test Receiver	Rohde & Schwarz	ESCI	100492	2016/03/10	1 Year
2	Spectrum Analyzer	Agilent	E7405A	US44210471	2016/03/14	1 Year
3	L.I.S.N.	Rohde & Schwarz	ENV216	100093	2016/03/10	1 Year
4	Coaxial Switch	Anritsu Corp	MP59B	6200283933	2016/03/07	1 Year
5	Terminator	Hubersuhner	50Ω	No.1	2016/03/07	1 Year
6	RF Cable	SchwarzBeck	N/A	No.1	2016/03/07	1 Year
7	Test Receiver	Rohde & Schwarz	ESPI	101202	2016/03/10	1 Year
8	Bilog Antenna	Sunol	JB3	A121206	2016/03/14	1 Year
9	Horn Antenna	SCHWARZBECK	BBHA9120D	756	2016/03/14	1 Year
10	Horn Antenna	Penn Engineering	9034	8376	2016/03/14	1 Year
11	Cable	Resenberger	N/A	NO.1	2016/03/07	1 Year
12	Cable	SchwarzBeck	N/A	NO.2	2016/03/07	1 Year
13	Cable	SchwarzBeck	N/A	NO.3	2016/03/07	1 Year
14	Single Phase Power Line Filter	DuoJi	FNF 202B30	N/A	2016/03/07	1 Year
15	Test Receiver	Rohde & Schwarz	ESCI	100492	2016/03/10	1 Year
16	Loop antenna	ARA	PLA-1030/B	1039	2016/03/14	1 Year
17	Power Meter	Anritsu	ML2495A	1204008	2016/03/10	1 Year

**NOTE:** Equipments listed above have been calibrated and are in the period of validation.

## **5. ANTENNA REQUIREMENT**

### **5.1 Applicable Standard**

According to FCC § 15.203 , An intentional radiator shall be designed to ensure that no antenna other than that furnished by the responsible party shall be used with the device. The use of a permanently attached antenna or of an antenna that uses a unique coupling to the intentional radiator shall be considered sufficient to comply with the provisions of this section. The manufacturer may design the unit so that a broken antenna can be replaced by the user, but the use of a standard antenna jack or electrical connector is prohibited. This requirement does not apply to carrier current devices or to devices operated under the provisions of §15.211, §15.213, §15.217, §15.219, or §15.221. Further, this requirement does not apply to intentional radiators that must be professionally installed, such as perimeter protection systems and some field disturbance sensors, or to other intentional radiators which, in accordance with §15.31(d), must be measured at the installation site. However, the installer shall be responsible for ensuring that the proper antenna is employed so that the limits in this part are not exceeded.

#### **5.1.1 Evaluation Criteria**

(a) Antenna must be permanently attached to the unit.

(b) Antenna must use a unique type of connector to attach to the EUT.

Unit must be professionally installed, Installer shall be responsible for verifying that the correct antenna is employed with the unit.

#### **5.1.2 Result: Compliance.**

The EUT has one integral antenna arrangement, which was permanently attached and the antenna gain is 3 dBi, fulfill the requirement of this section.

## 5.2 AC Power Line Conducted Emission

### 5.2.1 Requirement

A radio apparatus that is designed to be connected to the public utility (AC) power line shall ensure that the radio frequency voltage, which is conducted back onto the AC power line on any frequency or frequencies within the and 150 kHz-30 MHz, shall not exceed the limits in the following table:

Frequency	Maximum RF Line Voltage	
	Q.P.( dBuV)	Average( dBuV)
150kHz-500kHz	66-56	56-46
500kHz-5MHz	56	46
5MHz-30MHz	60	50

**\*\*Note:** 1. the lower limit shall apply at the band edges.  
2. The limit decreases linearly with the logarithm of the frequency in the range 0.15 MHz to 0.50 MHz

### 5.2.2 Block Diagram of Test Setup

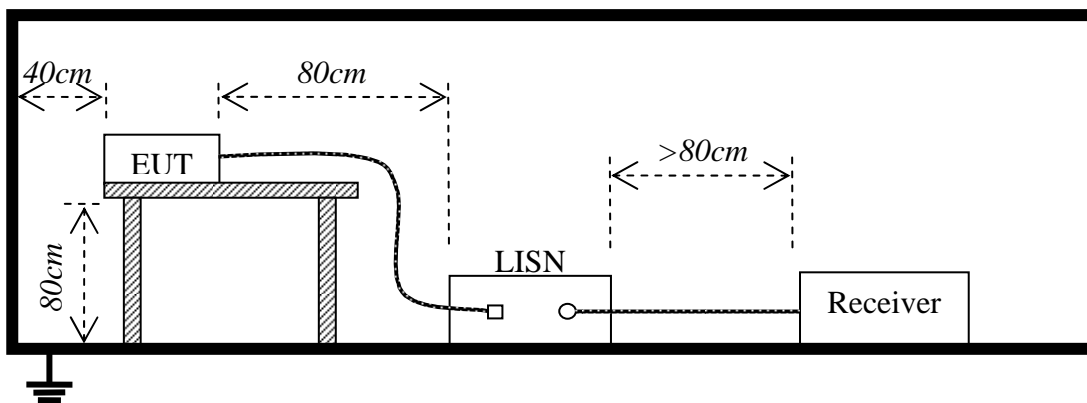

### 5.2.3 Test procedure

1. The E.U.T and simulators are connected to the main power through a line impedance stabilization network (L.I.S.N.). This provides a 50ohm/50uH coupling impedance for the measuring equipment.
2. Exploratory measurements were made to identify the frequency of the emission that has the highest amplitude relative to the limit;
3. The peripheral devices are also connected to the main power through a LISN that provides a 50ohm/50uH coupling impedance with 50ohm termination. (Please refer to the block diagram of the test setup and photographs).
4. Both sides of A.C. line are checked for maximum conducted interference. In order to find the maximum emission, the relative positions of equipment and all of the interface cables must be changed according to ANSI C63.10:2013 on conducted measurement.
5. The bandwidth of test receiver (ESCI) set at 9 KHz.
6. All data was recorded in the Quasi-peak and average detection mode.

### 5.2.4 Test Result

Pass

Note: All test modes are performed, only the worst case is recorded in this report.

Please refer the following pages.

EUT:	Internet Radio	M/N:	MS-60i
Mode:	Charging	Phase:	N
Tested by:	Windy Hu(Engineer)	Power:	DC 5V by USB Port
Temperature: / Humidity	24.4°C / 50.8%	Test date:	2016-09-20

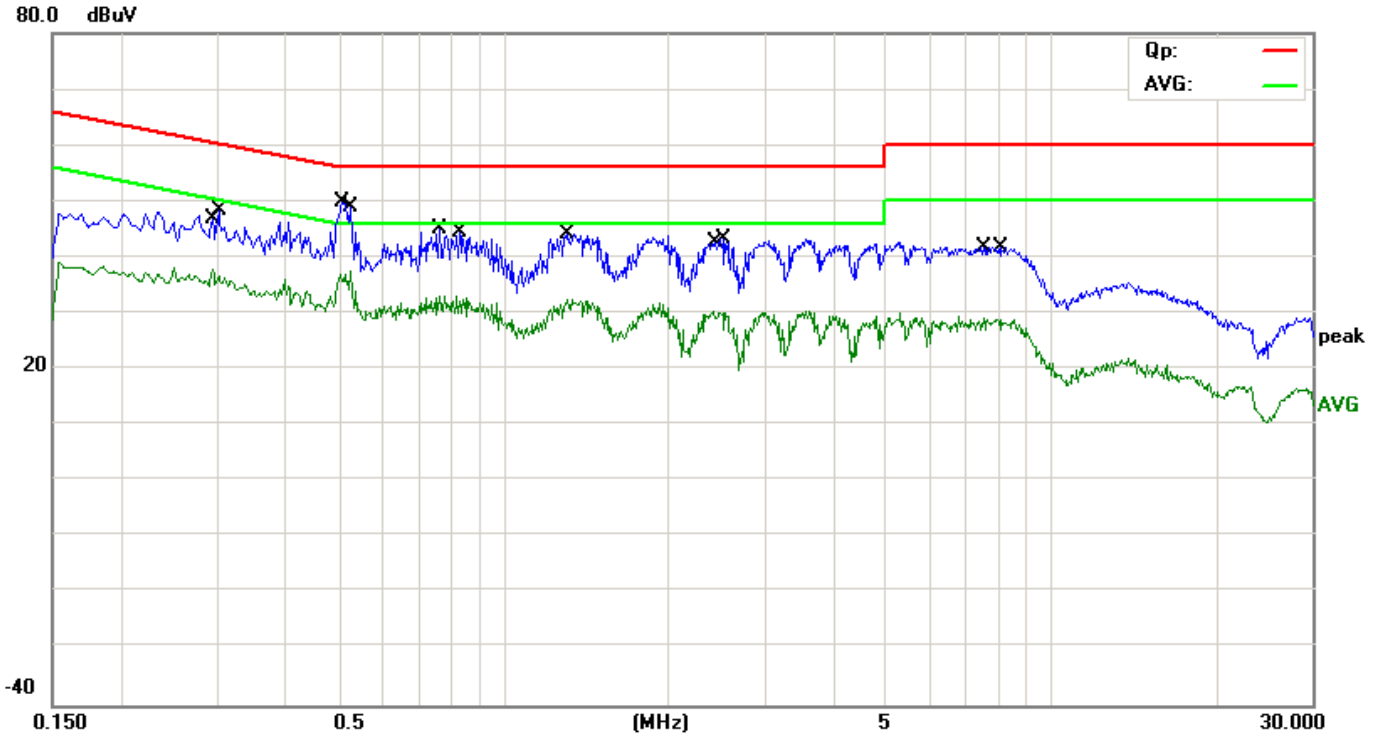

No.	Mk.	Freq. MHz	Reading Level dBuV	Correct Factor dB	Measure- ment dBuV	Limit dBuV	Over dB	Detector	Comment
1		0.2940	28.40	9.59	37.99	50.41	-12.42	AVG	
2		0.3020	38.74	9.59	48.33	60.19	-11.86	QP	
3	*	0.5100	40.13	9.59	49.72	56.00	-6.28	QP	
4		0.5260	27.96	9.59	37.55	46.00	-8.45	AVG	
5		0.7660	35.46	9.60	45.06	56.00	-10.94	QP	
6		0.8260	23.53	9.60	33.13	46.00	-12.87	AVG	
7		1.3140	34.63	9.60	44.23	56.00	-11.77	QP	
8		1.3140	22.74	9.60	32.34	46.00	-13.66	AVG	
9		2.4340	20.80	9.61	30.41	46.00	-15.59	AVG	
10		2.5260	33.58	9.61	43.19	56.00	-12.81	QP	
11		7.5620	19.57	9.66	29.23	50.00	-20.77	AVG	
12		8.1060	32.23	9.66	41.89	60.00	-18.11	QP	

\*:Maximum data    x:Over limit    !:over margin

EUT:	Internet Radio	M/N:	MS-60i
Mode:	Charging	Phase:	L1
Tested by:	Windy Hu(Engineer)	Power:	DC 5V by USB Port
Temperature: / Humidity	24.4°C / 50.8%	Test date:	2016-09-20

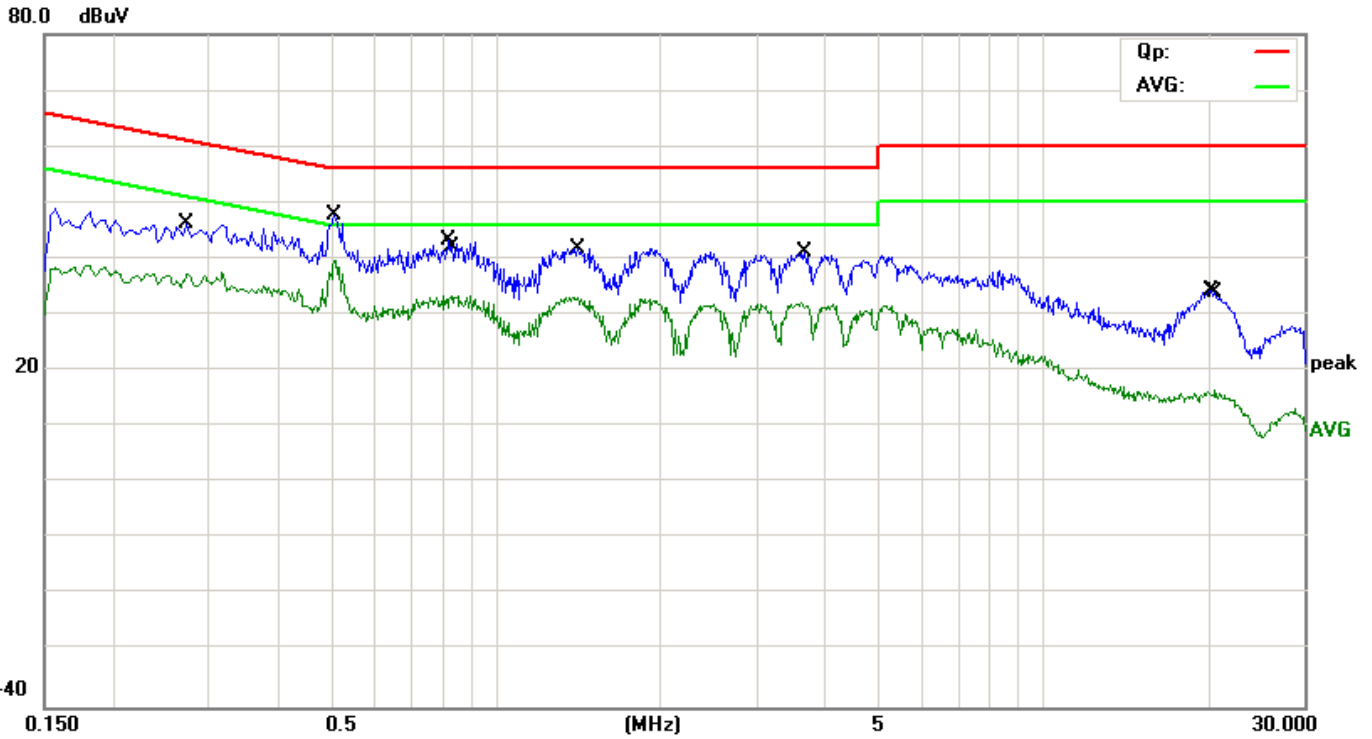

No.	Mk.	Freq. MHz	Reading Level dBuV	Correct Factor dB	Measure- ment dBuV	Limit dBuV	Over dB	Detector	Comment
1		0.2740	36.58	9.60	46.18	61.00	-14.82	QP	
2		0.2740	27.66	9.60	37.26	51.00	-13.74	AVG	
3		0.5100	38.30	9.59	47.89	56.00	-8.11	QP	
4	*	0.5100	29.98	9.59	39.57	46.00	-6.43	AVG	
5		0.8260	33.72	9.60	43.32	56.00	-12.68	QP	
6		0.8340	23.83	9.60	33.43	46.00	-12.57	AVG	
7		1.4180	32.08	9.60	41.68	56.00	-14.32	QP	
8		1.4180	23.54	9.60	33.14	46.00	-12.86	AVG	
9		3.6460	22.23	9.62	31.85	46.00	-14.15	AVG	
10		3.6780	31.65	9.62	41.27	56.00	-14.73	QP	
11		20.3660	24.67	9.73	34.40	60.00	-25.60	QP	
12		20.6180	6.95	9.73	16.68	50.00	-33.32	AVG	

\*:Maximum data    x:Over limit    !:over margin

## 5.3 Radiated Emission

### 5.3.1 Requirement

According to FCC section 15.247(d), In addition, radiated emissions which fall in the restricted bands, as defined in §15.205(a), must also comply with the radiated emission limits specified in §15.209(a) (see §15.205(c)).

According to FCC section 15.209(a), Except as provided elsewhere in this subpart, the emissions from an intentional radiator shall not exceed the field strength levels specified in the following table:

Frequency (MHz)	Field Strength ( $\mu\text{V}/\text{m}$ at 3-meter)	Test Distance (m)	Field Strength ( $\text{dB}\mu\text{V}/\text{m}$ at 3-meter)
0.009 - 0.490	2400/F(kHz)	300	
0.490 - 1.705	24000/F(kHz)	30	
1.705-30	30	30	
30-88	100	3	40
88-216	150	3	43.5
216-960	200	3	46
Above 960	500	3	54

Note:

1. For Above 1000MHz, the emission limit in this paragraph is based on measurement instrumentation employing an average detector, measurement using instrumentation with a peak detector function, corresponding to 20dB above the maximum permitted average limit.
2. For above 1000MHz, limit field strength of harmonics: 54dBuV/m@3m (AV) and 74dBuV/m@3m (PK)

In addition, radiated emissions which fall in the restricted bands, as defined in §15.205(a), must also comply with the radiated emission limits specified in §15.209(a) (see §15.205(c)).

### 5.3.2 Test Configuration

#### Test Setup:

- 1) For radiated emissions from 9kHz to 30MHz

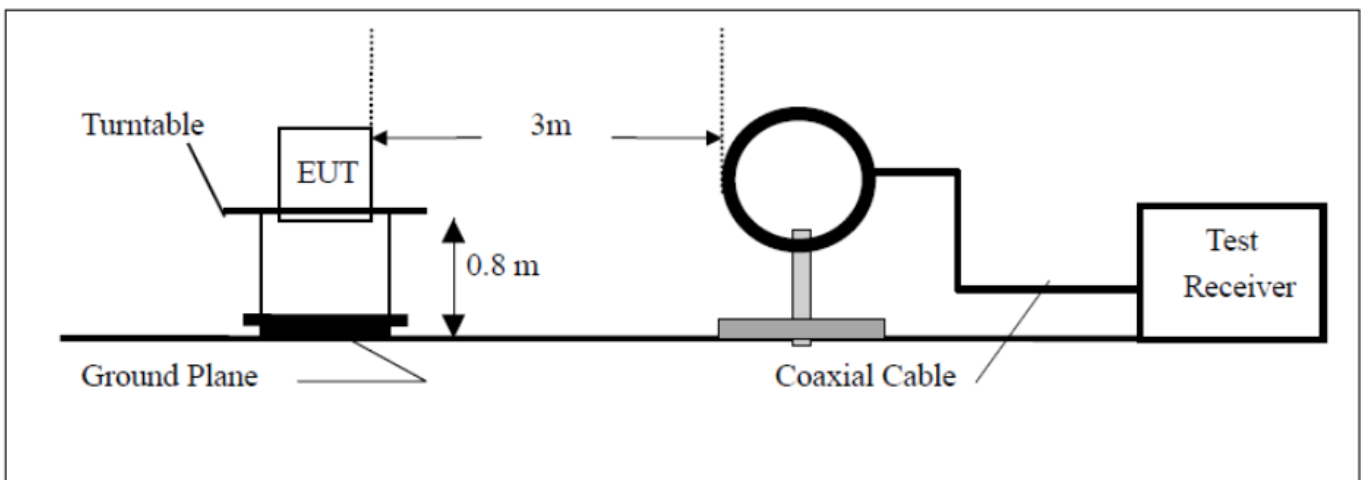

## 2) For radiated emissions from 30MHz to 1GHz

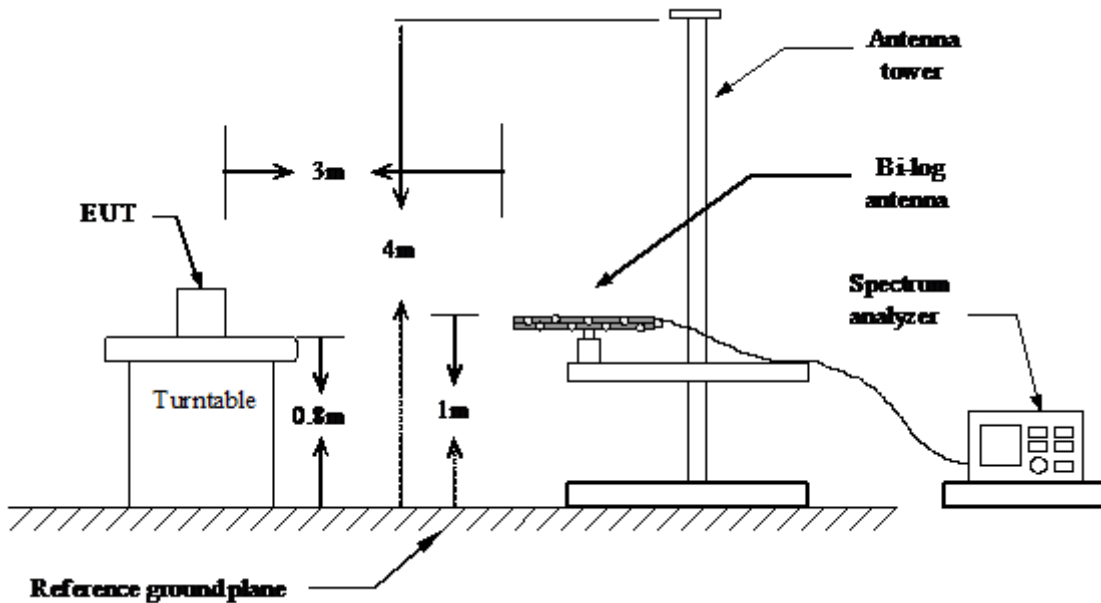

## 3) For radiated emissions above 1GHz

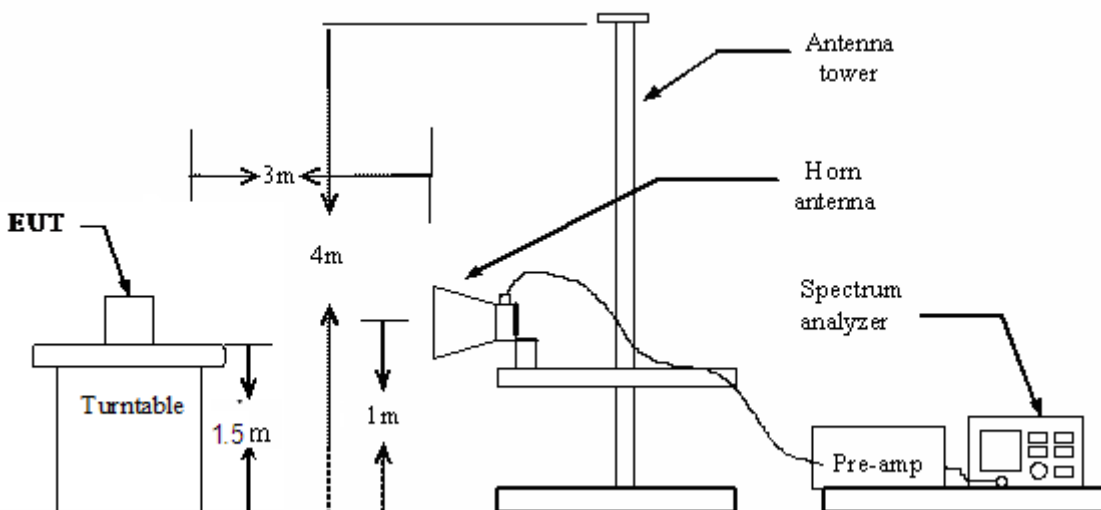
**5.3.3 Test Procedure:**

1. The EUT was placed on the top of a wooden table 0.8 meters (for measurement at frequency below 1GHz) and a wooden table 1.5 meters (for measurement at frequency above 1GHz) above the ground at a 3 meter semi-anechoic chamber. The table was rotated 360 degrees to determine the position of the highest radiation.
2. The EUT was set 3 meters away from the interference-receiving antenna, which was mounted on the top of a variable-height antenna tower.
3. The antenna height is varied from one meter to four meters above the ground to determine the maximum value of the field strength. Both horizontal and vertical polarizations of the antenna are set to make the measurement.
4. For each suspected emission, the EUT was arranged to its worst case and then the antenna was tuned to heights from 1 meter to 4 meters (for the test frequency of below 30MHz, the antenna was tuned to heights 1 meter, for the test frequency of above 1GHz, horn antenna opening in the test would have been facing the EUT when rise or fall) and the table was turned from 0 degrees to 360 degrees to find the maximum reading.

6. Set the spectrum analyzer in the following setting as:

Below 1GHz: PEAK: RBW=100 kHz / VBW=300 kHz / Sweep=AUTO QP: RBW=120 kHz / Sweep=AUTO  
Above 1GHz: (a)PEAK: RBW=VBW=1MHz / Sweep=AUTO  
(b)AVERAGE: RBW=1MHz / VBW=10Hz / Sweep=AUTO

The test-receiver system was set to Peak Detect Function and Specified Bandwidth with Maximum Hold Mode.

7. If the emission level of the EUT in peak mode was 10dB lower than the limit specified, then testing could be stopped and the peak values of the EUT would be reported. Otherwise the emissions that did not have 10dB margin would be re-tested one by one using peak, quasi-peak or average method as specified and then reported in a data sheet.

### 5.3.4 Test Result

Pass

#### Remark:

1. During the test, pre-scan the 802.11b, 802.11g, 802.11n (20M) modulation, and found the 802.11b modulation Low channel is worse case in above 1GHz and below 1GHz.
2. Pre-scan all kind of the place mode (X-axis, Y-axis, Z-axis), and found the Y-axis which it is worse case.
3. For radiated emissions from 9kHz to 30MHz, Test results show that the margin of over -20db.

Note: All test modes are performed, only the worst case is recorded in this report.

Please refer the following pages



**Below 1GHz:**

<b>EUT:</b>	Internet Radio	<b>M/N:</b>	MS-60i
<b>Mode:</b>	802.11b-CH1	<b>Polarization:</b>	Vertical
<b>Tested by:</b>	Windy Hu(Engineer)	<b>Power:</b>	DC 9V by Adapter
<b>Temperature: / Humidity</b>	23.9°C / 51.1%	<b>Test date:</b>	2016-09-20

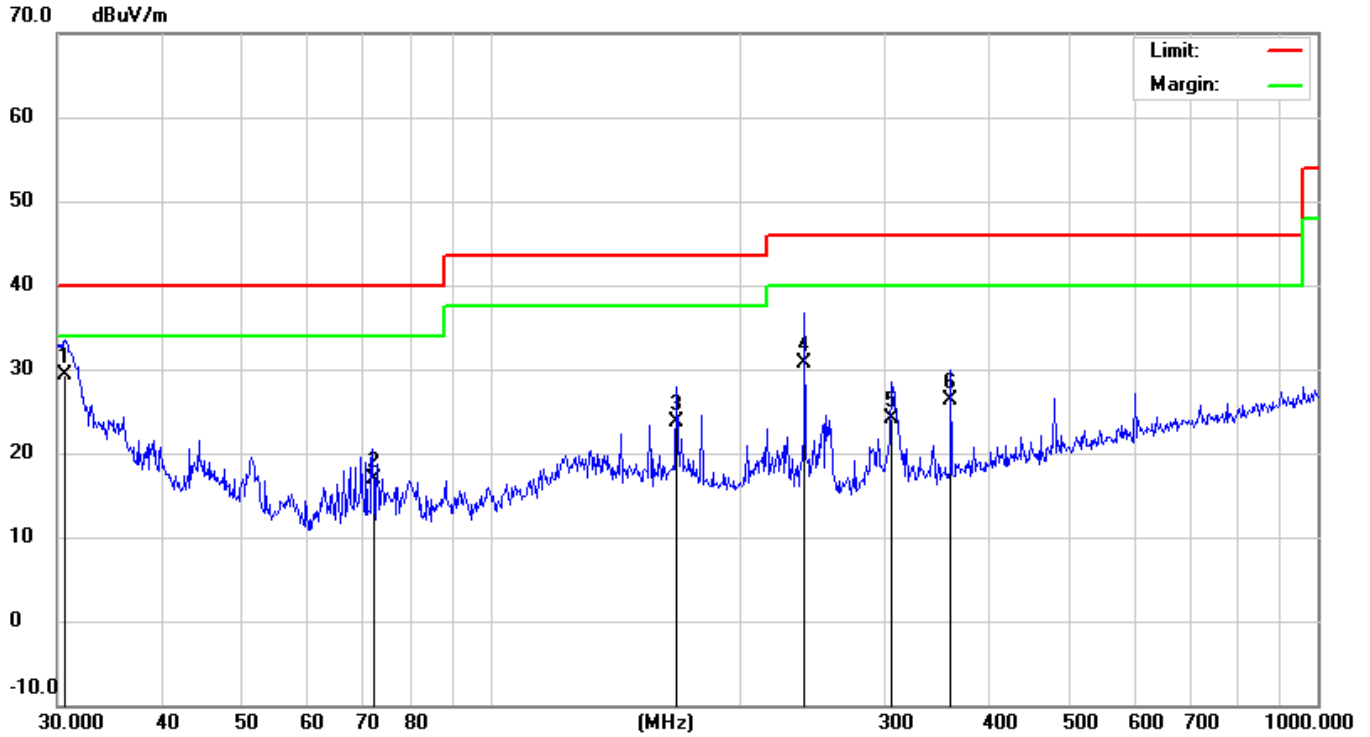

No.	Mk.	Freq. MHz	Reading Level dBuV	Correct Factor dB	Measure- ment dBuV/m	Limit dBuV/m	Over dB	Antenna Height cm	Table Degree	Comment
1	*	30.6378	8.90	20.47	29.37	40.00	-10.63	QP		
2		72.0843	8.70	8.26	16.96	40.00	-23.04	QP		
3		167.8242	11.60	12.04	23.64	43.50	-19.86	QP		
4		239.9873	18.80	11.88	30.68	46.00	-15.32	QP		
5		305.6799	10.40	13.61	24.01	46.00	-21.99	QP		
6		360.4476	11.70	14.65	26.35	46.00	-19.65	QP		

\*:Maximum data    x:Over limit    !:over margin

EUT:	Internet Radio	M/N:	MS-60i
Mode:	802.11b-CH1	Polarization:	Horizontal
Test by:	Windy Hu(Engineer)	Power:	DC 9V by Adapter
Temperature: / Humidity	23.9°C / 51.1%	Test date:	2016-09-20

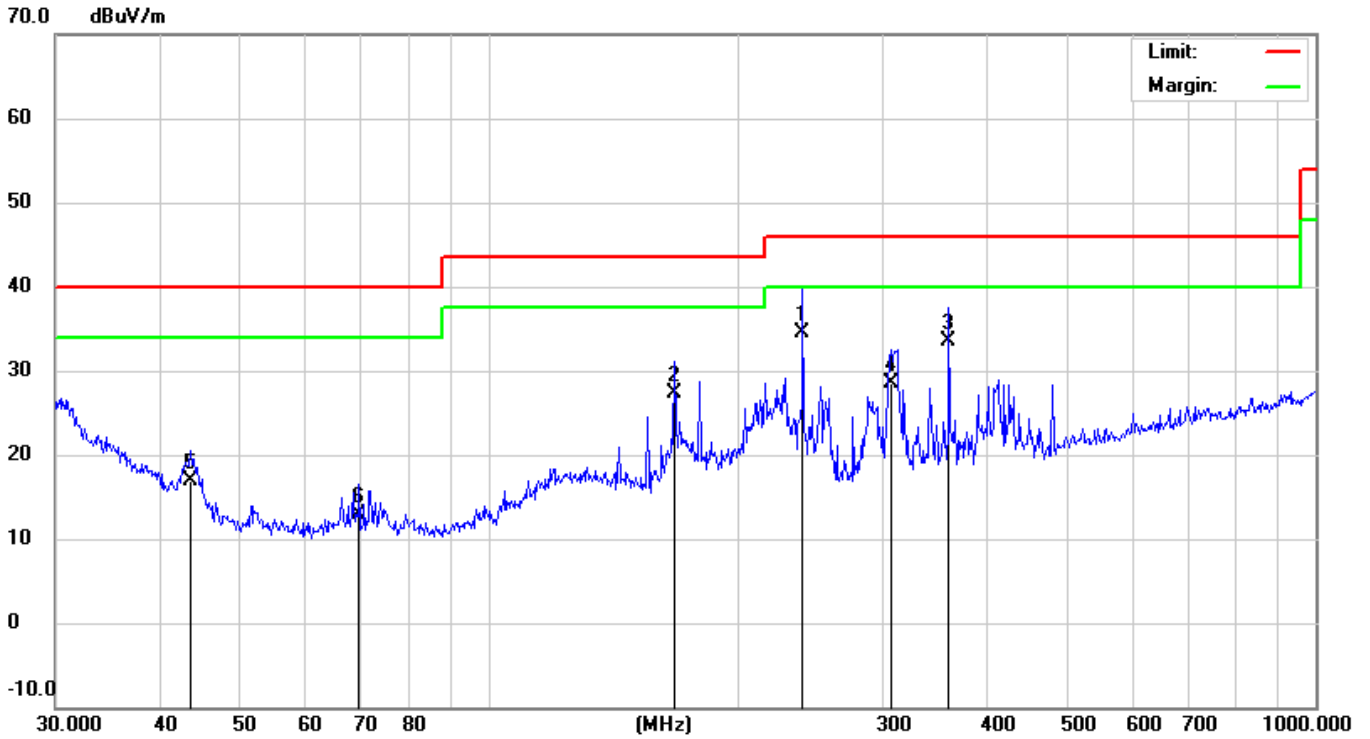

No.	Mk.	Freq.	Reading Level	Correct Factor	Measurement	Limit	Over	Antenna Height	Table Degree	
		MHz	dBuV	dB	dBuV/m	dBuV/m	dB	cm	degree	Comment
1	*	239.9873	22.60	11.88	34.48	46.00	-11.52	QP		
2		167.8242	15.20	12.04	27.24	43.50	-16.26	QP		
3		360.4476	18.80	14.65	33.45	46.00	-12.55	QP		
4		306.7537	14.90	13.63	28.53	46.00	-17.47	QP		
5		43.6584	5.50	11.39	16.89	40.00	-23.11	QP		
6		69.8449	4.60	8.29	12.89	40.00	-27.11	QP		

\*:Maximum data    x:Over limit    !:over margin

**Above 1GHz**

EUT:	Internet Radio	M/N:	MS-60i
Mode:	802.11b-CH1	Polarization:	Vertical
Tested by:	Windy Hu(Engineer)	Power:	DC 9V by Adapter
Temperature: / Humidity	23.7°C / 51.6%	Test date:	2016-09-20

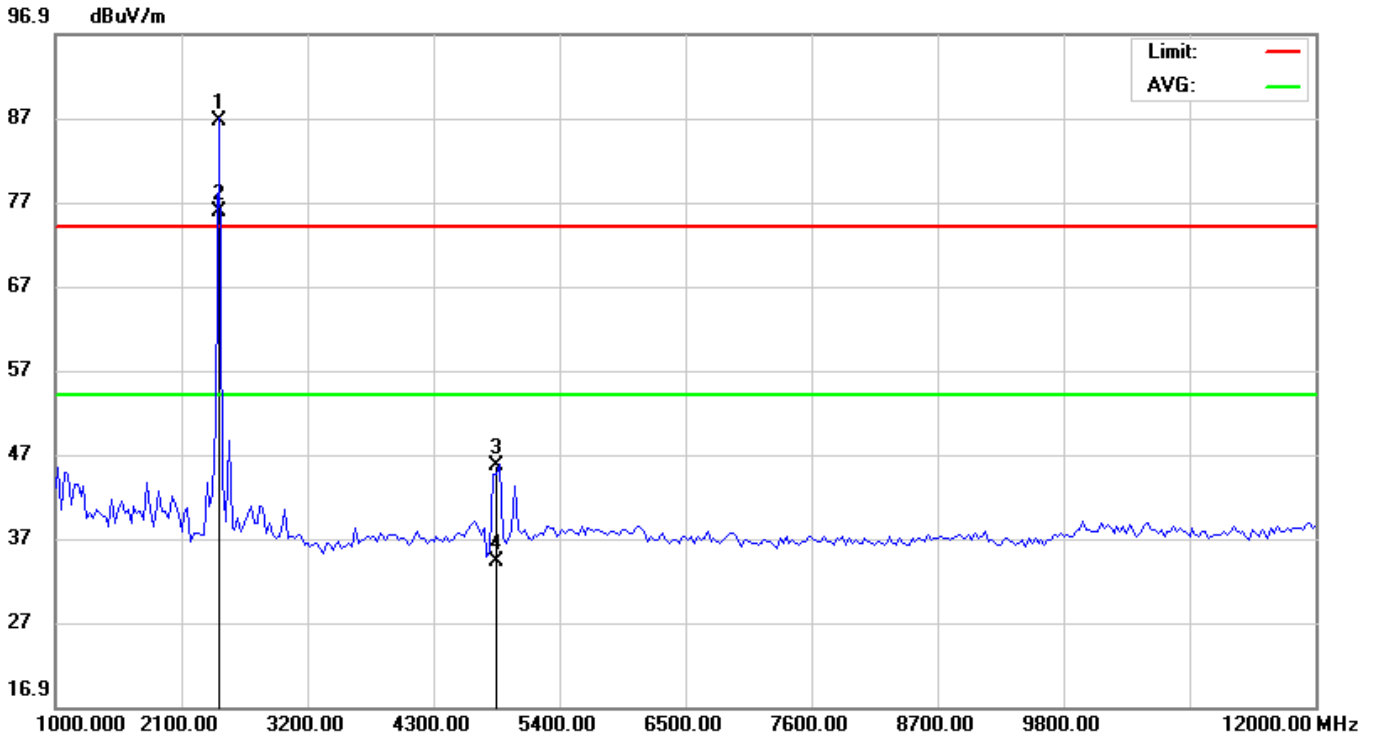

No.	Mk.	Freq. MHz	Reading Level dBuV	Correct Factor dB	Measur- ment dBuV/m	Limit dBuV/m	Over dB	Detector	Antenna Height cm	Table Degree degree	Comment
1	X	2412.100	95.03	-8.41	86.62	74.00	12.62	peak			
2	*	2412.100	84.16	-8.41	75.75	54.00	21.75	AVG			
3		4824.000	51.55	-5.91	45.64	74.00	-28.36	peak			
4		4824.000	40.03	-5.91	34.12	54.00	-19.88	AVG			

\*:Maximum data    x:Over limit    !:over margin

EUT:	Internet Radio	M/N:	MS-60i
Mode:	802.11b-CH1	Polarization:	Vertical
Tested by:	Windy Hu(Engineer)	Power:	DC 9V by Adapter
Temperature: / Humidity	23.7°C / 51.6%	Test date:	2016-09-20

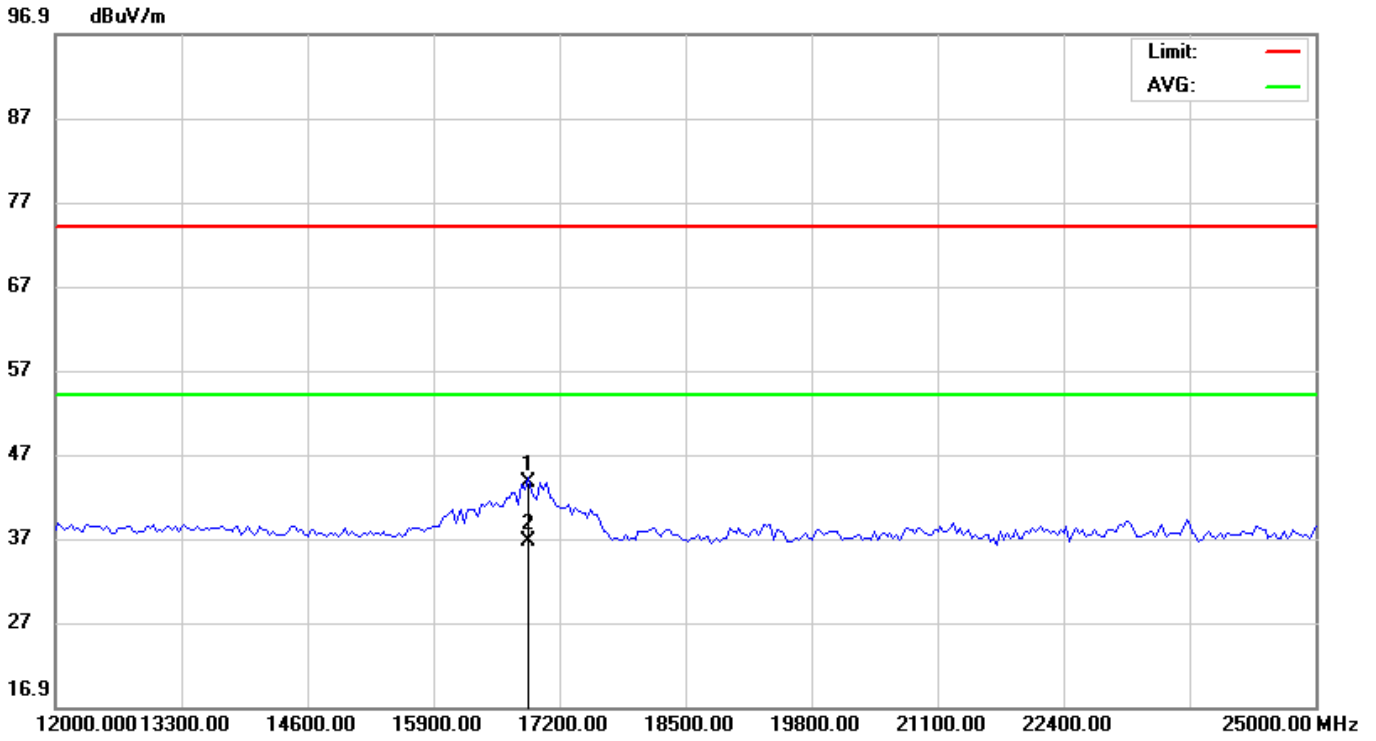

No.	Mk.	Freq. MHz	Reading Level dBuV	Correct Factor dB	Measure- ment dBuV/m	Limit dBuV/m	Over dB	Detector	Antenna Height cm	Table Degree	Comment
1		16875.00	37.13	6.51	43.64	74.00	-30.36	peak			
2	*	16875.00	30.01	6.51	36.52	54.00	-17.48	AVG			

\*:Maximum data    x:Over limit    !:over margin

EUT:	Internet Radio	M/N:	MS-60i
Mode:	802.11b-CH1	Polarization:	Horizontal
Tested by:	Windy Hu(Engineer)	Power:	DC 9V by Adapter
Temperature: / Humidity	23.7°C / 51.6%	Test date:	2016-09-20

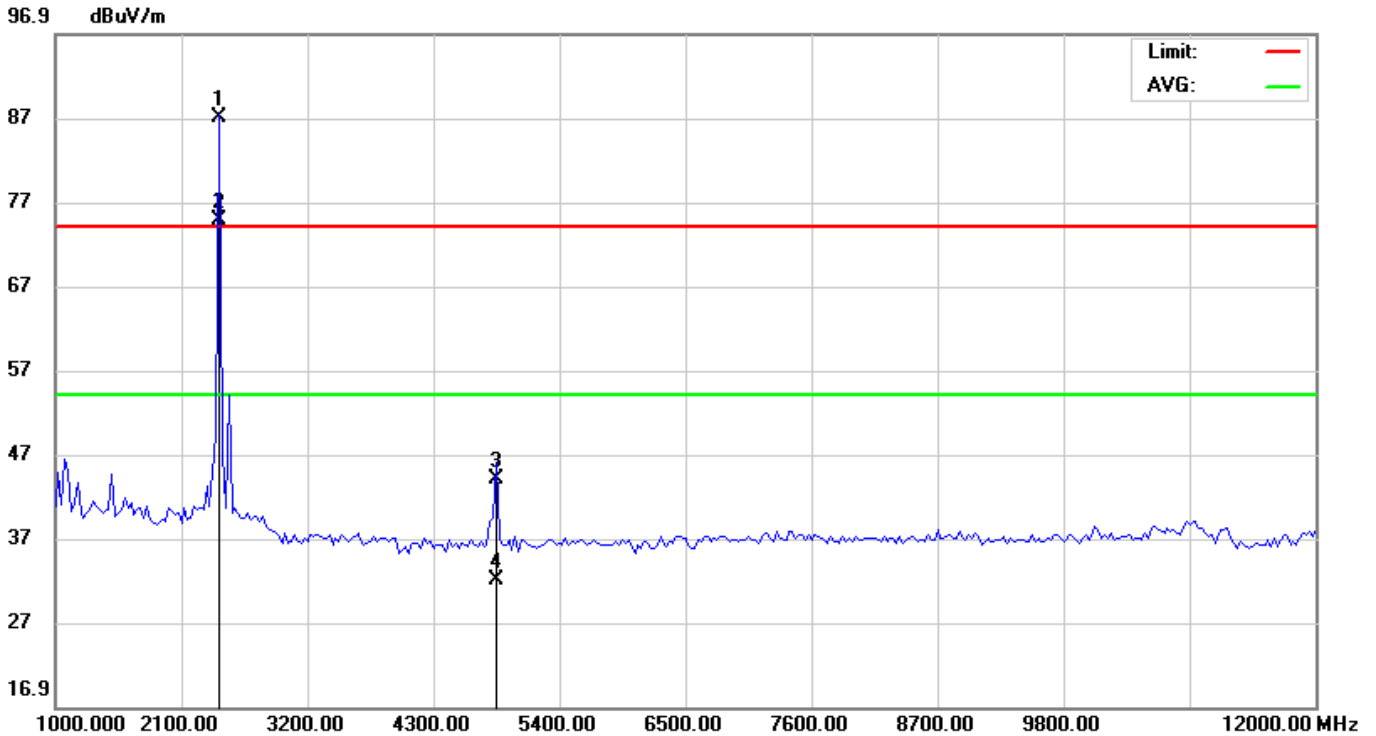

No.	Mk.	Freq. MHz	Reading Level dBuV	Correct Factor dB	Measure- ment dBuV/m	Limit dBuV/m	Over dB	Detector	Antenna Height cm	Table Degree degree	Comment
1	X	2412.000	95.46	-8.41	87.05	74.00	13.05	peak			
2	*	2412.000	83.12	-8.41	74.71	54.00	20.71	AVG			
3		4824.000	50.01	-5.91	44.10	74.00	-29.90	peak			
4		4824.000	37.86	-5.91	31.95	54.00	-22.05	AVG			

\*:Maximum data    x:Over limit    !:over margin

EUT:	Internet Radio	M/N:	MS-60i
Mode:	802.11b-CH1	Polarization:	Horizontal
Tested by:	Windy Hu(Engineer)	Power:	DC 9V by Adapter
Temperature: / Humidity	23.7°C / 51.6%	Test date:	2016-09-20

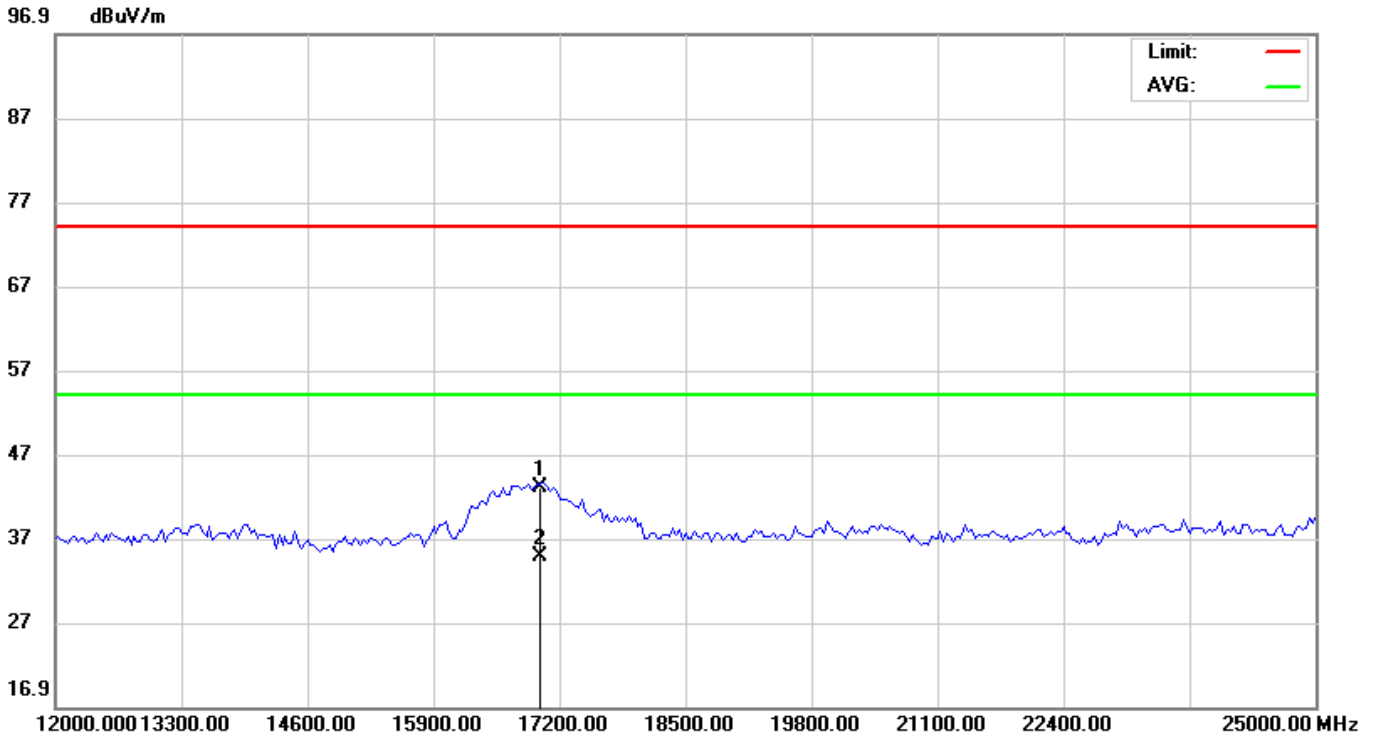

No.	Mk.	Freq. MHz	Reading Level dBuV	Correct Factor dB	Measure- ment dBuV/m	Limit dBuV/m	Over dB	Detector	Antenna Height cm	Table Degree degree	Comment
1		17005.00	36.13	6.90	43.03	74.00	-30.97	peak			
2	*	17005.00	27.84	6.90	34.74	54.00	-19.26	AVG			

\*:Maximum data    x:Over limit    !:over margin

## 5.4 Conducted Peak Output Power

### 5.4.1 Requirement

According to FCC section 15.247(b)(3), for systems using digital modulation in the 902-928 MHz, 2400-2483.5 MHz, and 5725-5850 MHz bands: 1 Watt. As an alternative to a peak power measurement, compliance with the one Watt limit can be based on a measurement of the maximum conducted output power. Maximum Conducted Output Power is defined as the total transmit power delivered to all antennas and antenna elements averaged across all symbols in the signaling alphabet when the transmitter is operating at its maximum power control level. Power must be summed across all antennas and antenna elements. The average must not include any time intervals during which the transmitter is off or is transmitting at a reduced power level. If multiple modes of operation are possible (e.g., alternative modulation methods), the maximum conducted output power is the highest total transmit power occurring in any mode.

### 5.4.2 Block Diagram of Test Setup

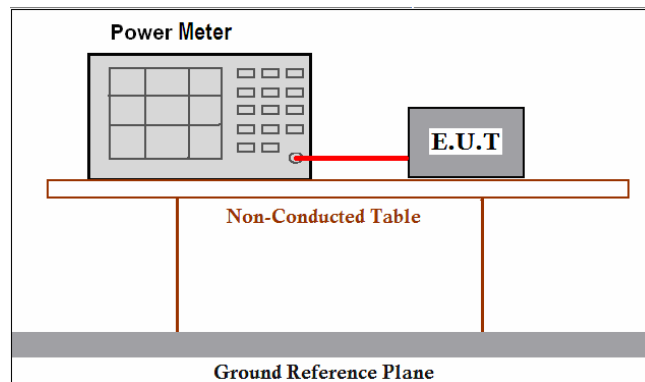

### 5.4.3 Test Procedure

1. Remove the antenna from the EUT and then connect a low attention attenuation RF cable (Cable loss =0.5dB) from the antenna port to the power meter.
2. Measurement using an RF peak power meter.
3. Report the worse case.

### 5.4.4 Test Result

Test Item:	Peak Output Power	Temperature :	20°C
Tested by:	Windy Hu (Engineer)	Relative Humidity :	55%

Mode	Channel	Frequency (MHz)	Peak Output Power(dBm)	Limit		Pass/Fail
				(mW)	(dBm)	
802.11b	Low	2412	7.89	1000	30	Pass
	Middle	2437	8.40	1000	30	Pass
	High	2462	8.61	1000	30	Pass
802.11g	Low	2412	9.37	1000	30	Pass
	Middle	2437	9.52	1000	30	Pass
	High	2462	9.74	1000	30	Pass
802.11n (20MHz)	Low	2412	8.87	1000	30	Pass
	Middle	2437	9.30	1000	30	Pass
	High	2462	9.59	1000	30	Pass

## 5.5 6dB Emission Bandwidth

### 5.5.1 Test Requirement

Systems using digital modulation techniques may operate in the 902–928 MHz, 2400–2483.5 MHz, and 5725–5850 MHz bands. The minimum 6 dB bandwidth shall be at least 500 kHz.

### 5.5.2 Block Diagram of Test Setup



### 5.5.3 Test Procedure

According to KDB 558074 D01 DTS Meas Guidance v03r02 clause 8.1 Option 1:

- a) Set RBW = 100 kHz.
- b) Set the video bandwidth (VBW)  $\geq 3 \times \text{RBW}$ .
- c) Detector = Peak.
- d) Trace mode = max hold.
- e) Sweep = auto couple.
- f) Allow the trace to stabilize.
- g) Measure the maximum width of the emission that is constrained by the frequencies associated with the two outermost amplitude points (upper and lower frequencies) that are attenuated by 6 dB relative to the maximum level measured in the fundamental emission.

### 5.5.4 Test Result

Pass



<b>Test Item:</b>	6dB Emission Bandwidth	<b>Temperature :</b>	23°C
<b>Tested by:</b>	Windy Hu(Engineer)	<b>Relative Humidity :</b>	55%

<b>Mode</b>	<b>Channel</b>	<b>Frequency (MHz)</b>	<b>6dB Bandwidth(MHz)</b>	<b>Limit(KHz)</b>
802.11b	Low	2412	14.903	$\geq 500$
	Middle	2437	14.915	$\geq 500$
	High	2462	14.902	$\geq 500$
802.11g	Low	2412	16.429	$\geq 500$
	Middle	2437	16.435	$\geq 500$
	High	2462	16.436	$\geq 500$
802.11n (20MHz)	Low	2412	17.624	$\geq 500$
	Middle	2437	17.624	$\geq 500$
	High	2462	17.629	$\geq 500$

802.11 b Mode

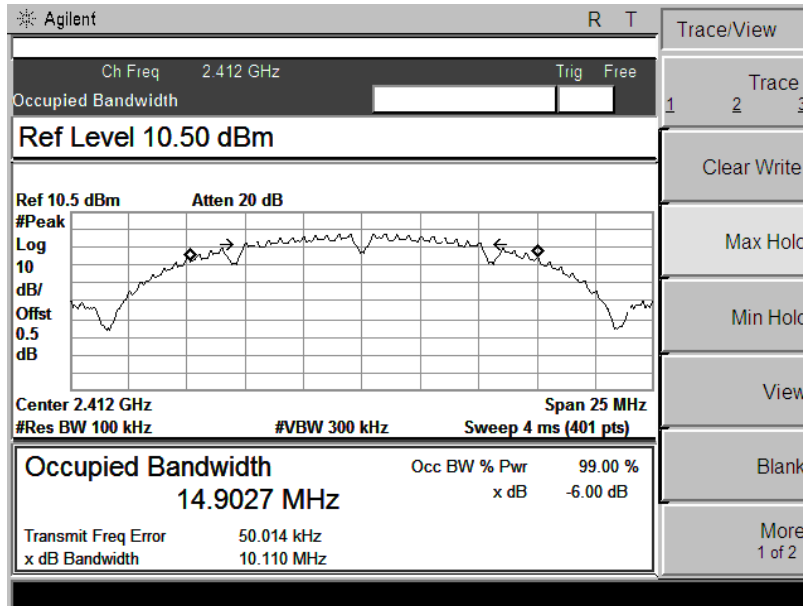

Ch 1

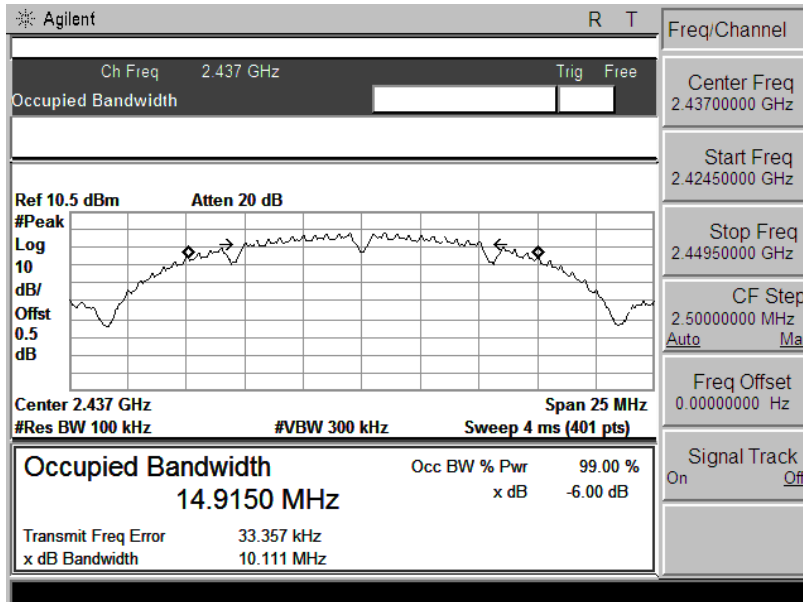

Ch 6

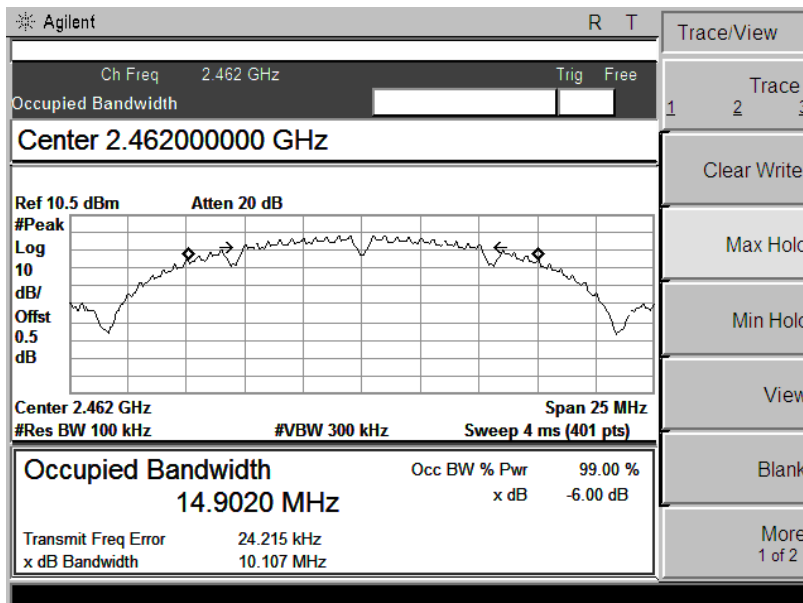

Ch 11

802.11 g Mode

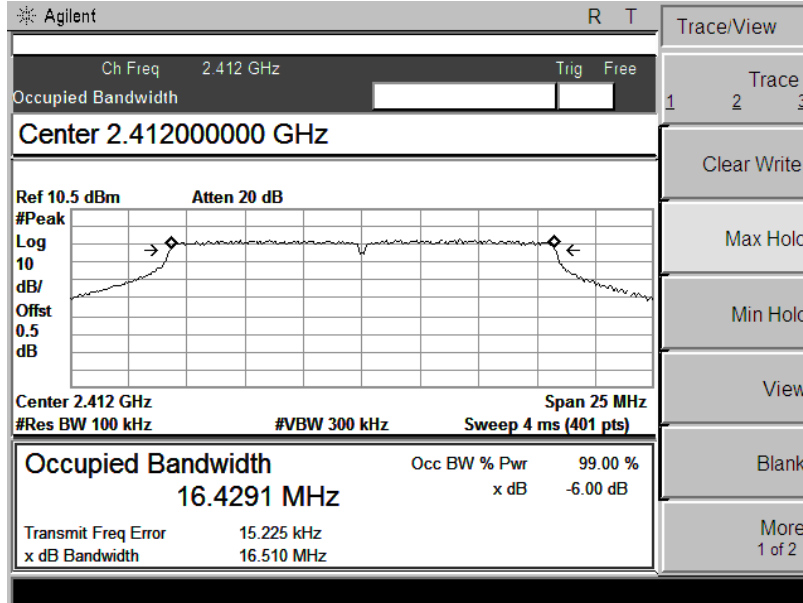

Ch 1

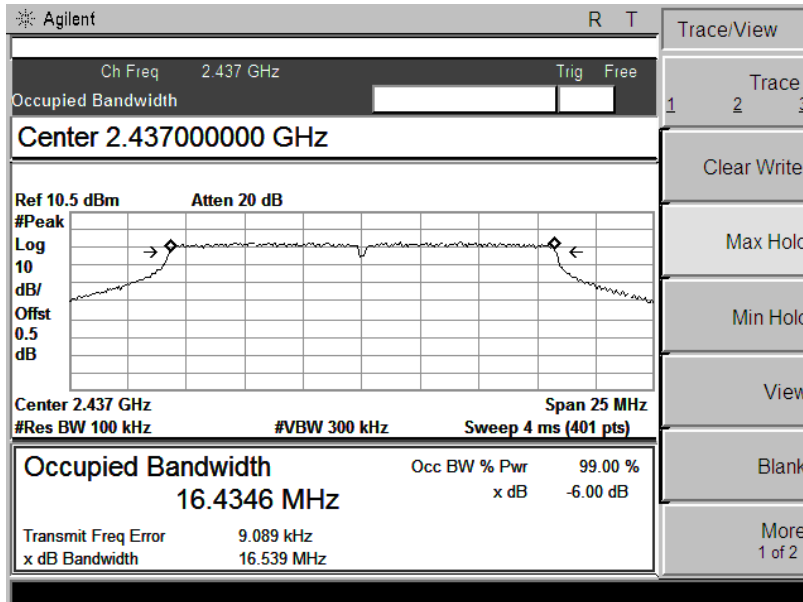

Ch 6

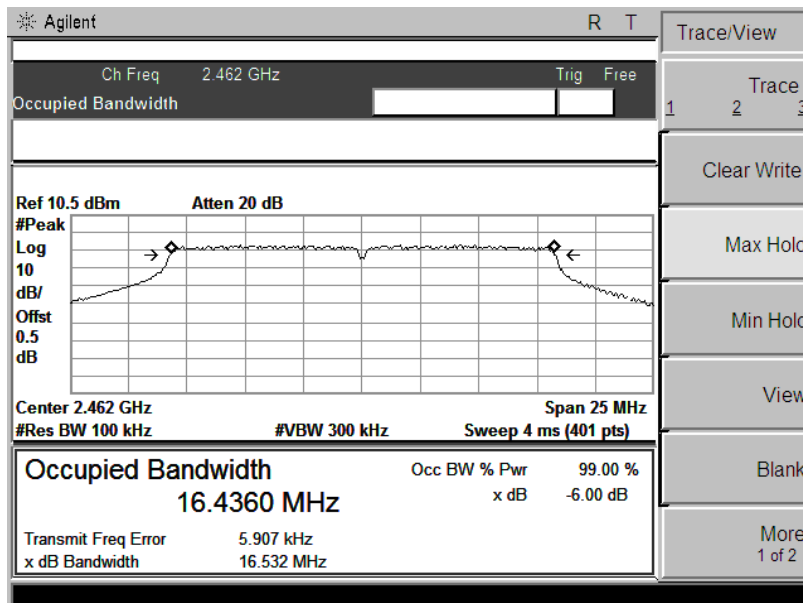

Ch 11

802.11 n(20M) Mode

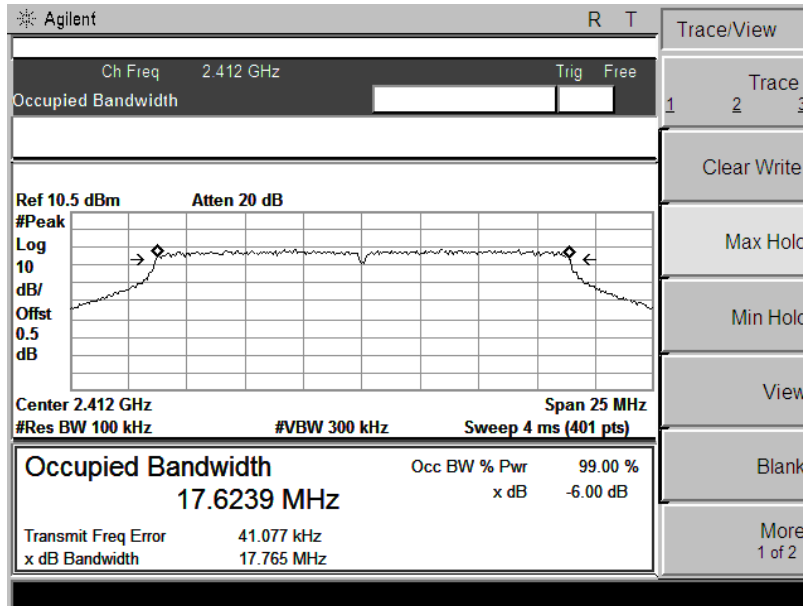

Ch 1

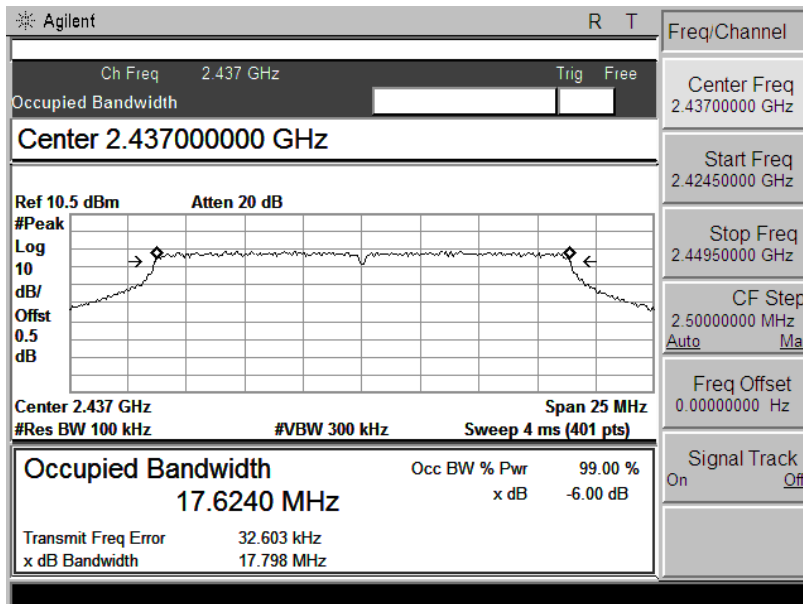

Ch 6

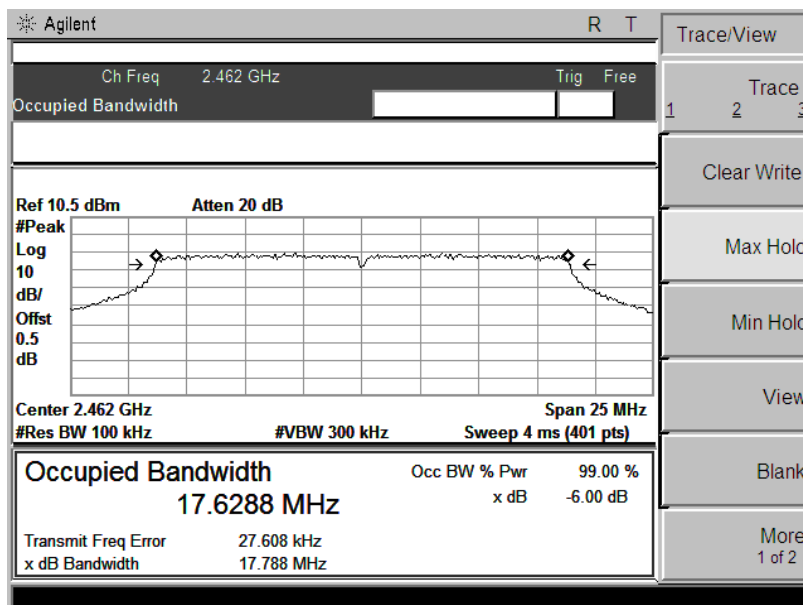

Ch 11

## 5.6 POWER SPECTRAL DENSITY

### 5.6.1 Applicable Standard

For digitally modulated systems, the power spectral density conducted from the intentional radiator to the antenna shall not be greater than 8 dBm in any 3 kHz band during any time interval of continuous transmission. This power spectral density shall be determined in accordance with the provisions of paragraph (b) of this section. The same method of determining the conducted output power shall be used to determine the power spectral density.

### 5.6.2 Block Diagram of Test Setup



### 5.6.3 Test Procedure

According to KDB 558074 D01 DTS Meas Guidance v03r01clause10.2:

- a) Set analyzer center frequency to DTS channel center frequency.
- b) Set the span to 1.5 times the DTS bandwidth.
- c) Set the RBW to:  $3 \text{ kHz} \leq \text{RBW} \leq 100 \text{ kHz}$ .
- d) Set the VBW  $\geq 3 \times \text{RBW}$ .
- e) Detector = peak.
- f) Sweep time = auto couple.
- g) Trace mode = max hold.
- h) Allow trace to fully stabilize.
- i) Use the peak marker function to determine the maximum amplitude level within the RBW.
- j) If measured value exceeds limit, reduce RBW (no less than 3 kHz) and repeat.

### 5.6.4 Test Result

Pass

<b>Test Item:</b>	POWER SPECTRAL DENSITY	<b>Temperature :</b>	20°C
<b>Tested by:</b>	Windy Hu(Engineer)	<b>Relative Humidity :</b>	55%

<b>Mode</b>	<b>Channel</b>	<b>Frequency (MHz)</b>	<b>PSD (dBm/100kHz)</b>	<b>Limit (dBm/100kHz)</b>	<b>Result</b>
802.11b	Low	2412	-21.16	≤8	Pass
	Middle	2437	-20.74	≤8	Pass
	High	2462	-21.14	≤8	Pass
802.11g	Low	2412	-20.98	≤8	Pass
	Middle	2437	-20.85	≤8	Pass
	High	2462	-24.65	≤8	Pass
802.11n (20MHz)	Low	2412	-24.90	≤8	Pass
	Middle	2437	-23.77	≤8	Pass
	High	2462	-23.57	≤8	Pass

802.11 b Mode

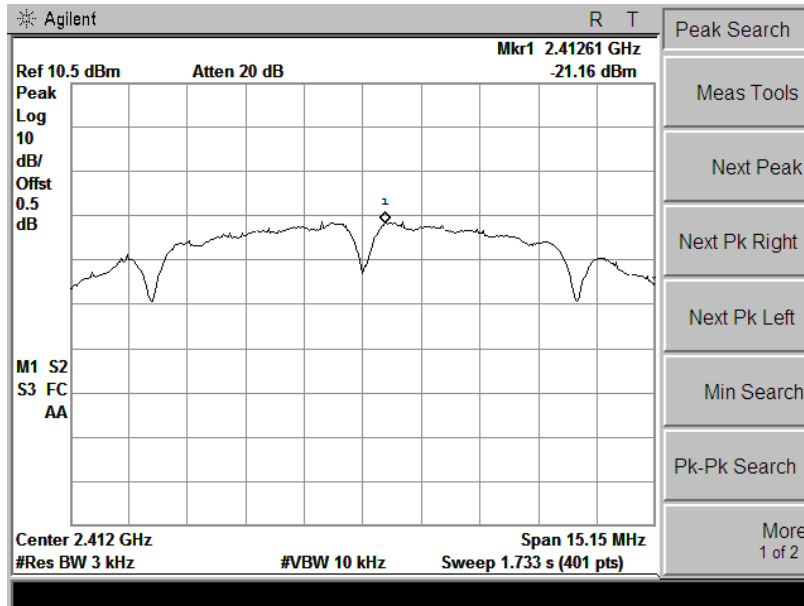

Ch 1

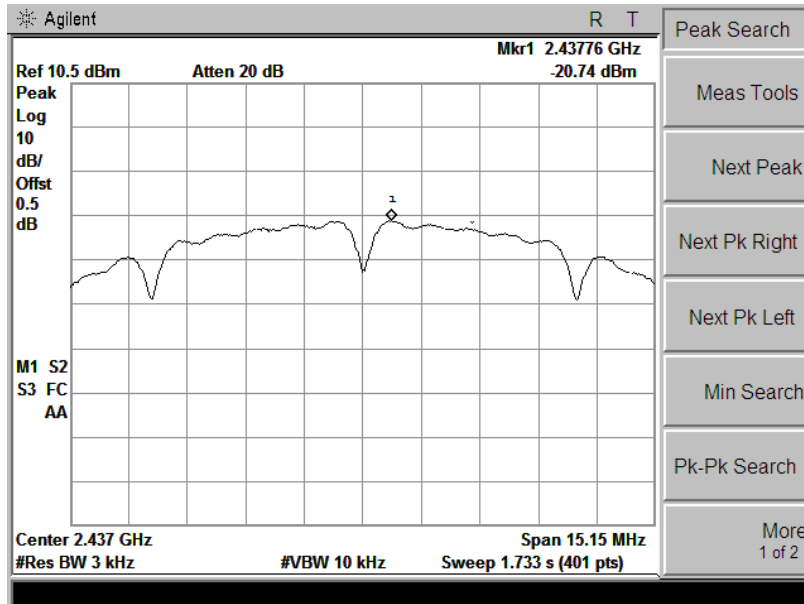

Ch 6

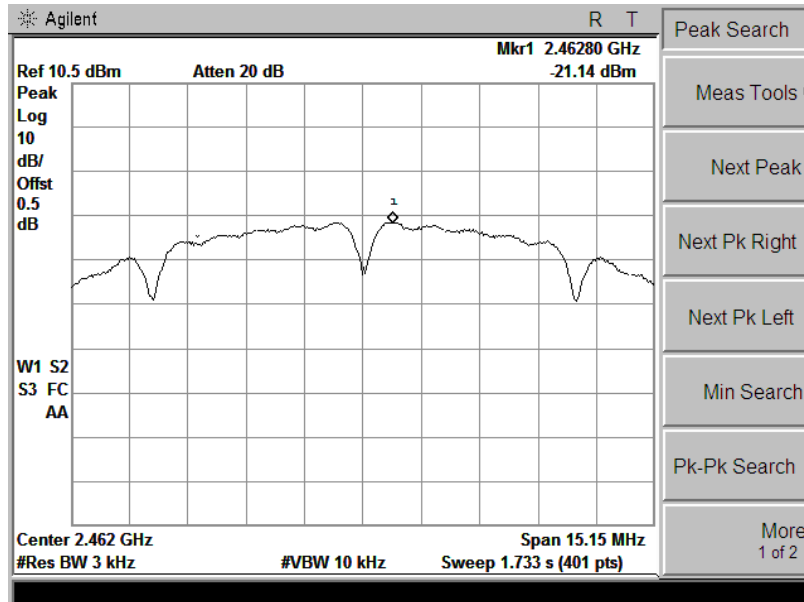

Ch 11

802.11 g Mode

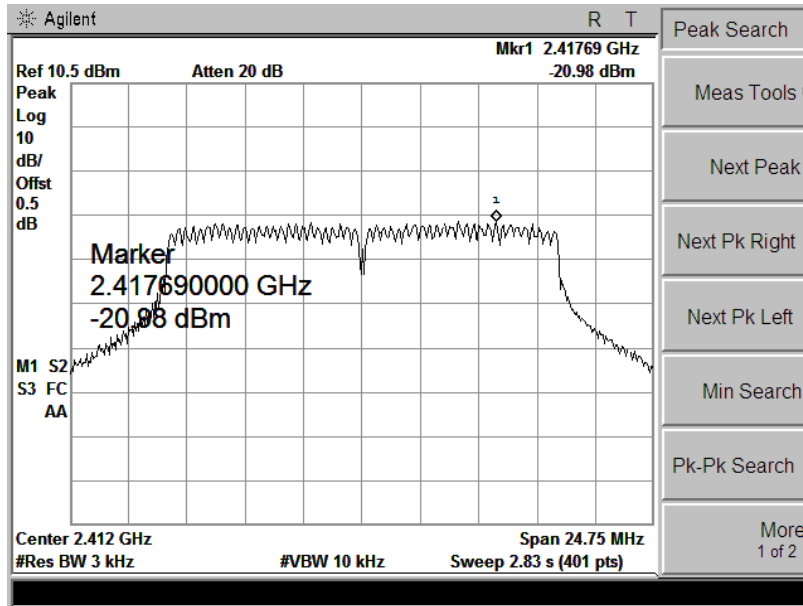

Ch 1

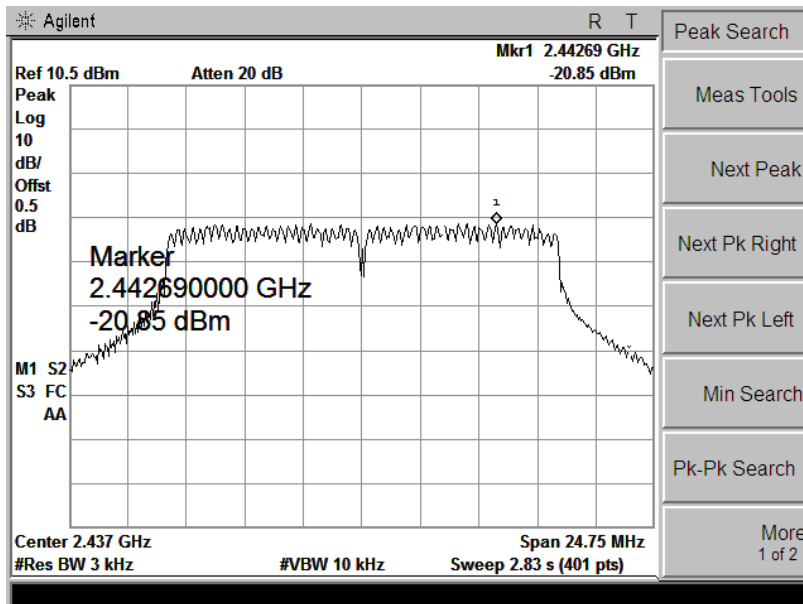

Ch 6

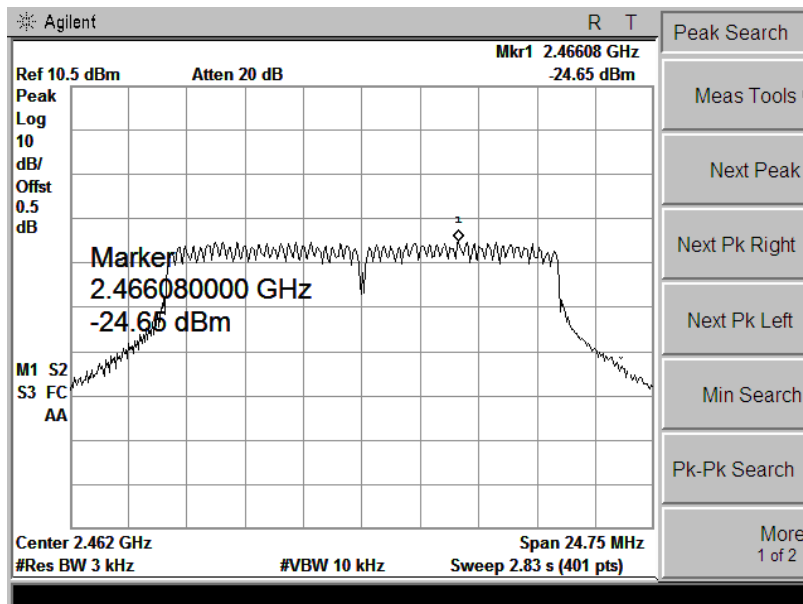

Ch 11



802.11 n(20M) Mode

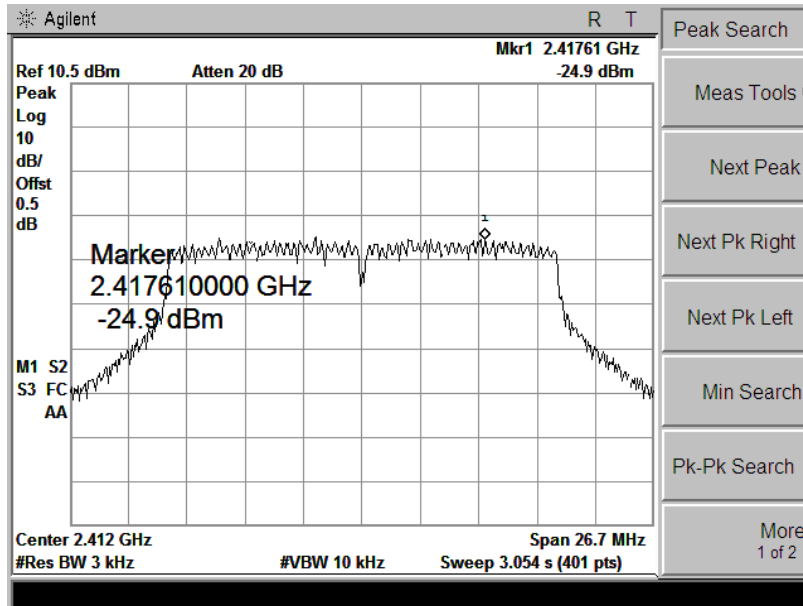

Ch 1

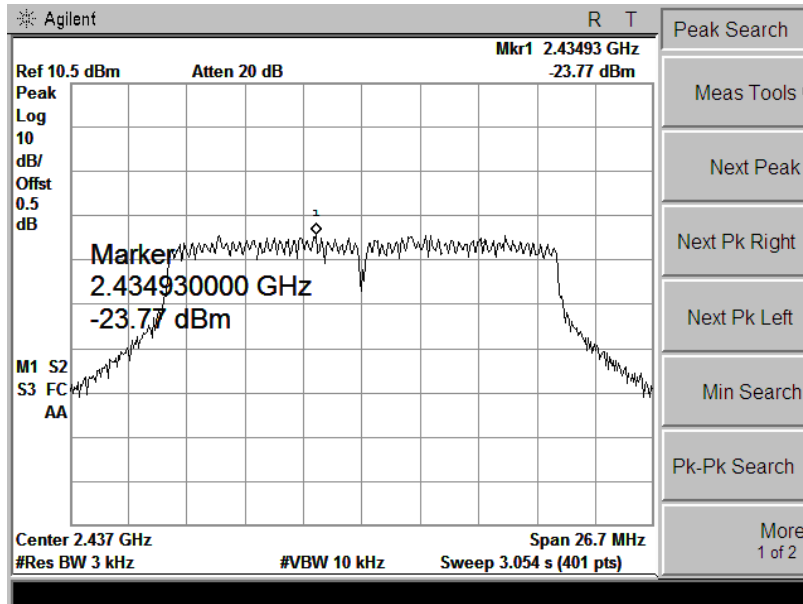

Ch 6

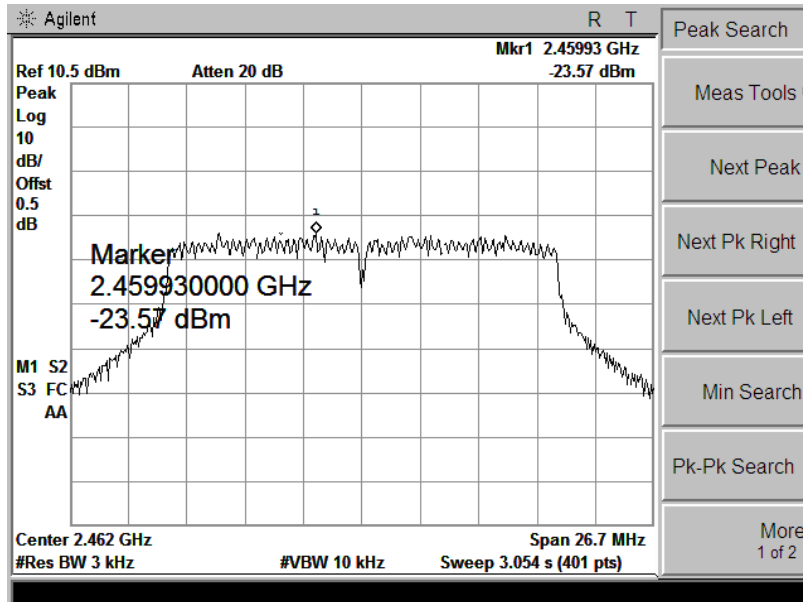

Ch 11

## 5.7 Band Edge and Conducted Spurious Emissions

### 5.7.1 Test Requirement

In any 100 kHz bandwidth outside the frequency band in which the spread spectrum or digitally modulated intentional radiator is operating, the radio frequency power that is produced by the intentional radiator shall be at least 20 dB below that in the 100 kHz bandwidth within the band that contains the highest level of the desired power, based on either an RF conducted or a radiated measurement, provided the transmitter demonstrates compliance with the peak conducted power limits. If the transmitter complies with the conducted power limits based on the use of RMS averaging over a time interval, as permitted under paragraph (b)(3) of this section, the attenuation required under this paragraph shall be 30 dB instead of 20 dB. Attenuation below the general limits specified in §15.209(a) is not required.

### 5.7.2 Test Procedure

1. Check the calibration of the measuring instrument using either an internal calibrator or a known signal from an external generator.
2. Remove the antenna from the EUT and then connect to a low loss RF cable from the antenna port to a EMI test receiver, then turn on the EUT and make it operate in transmitting mode. Then set it to Low Channel and High Channel within its operating range, and make sure the instrument is operated in its linear range.
3. Set both RBW and VBW of spectrum analyzer to 100 kHz with a convenient frequency span including 100 kHz bandwidth from band edge.
4. Measure the highest amplitude appearing on spectral display and set it as a reference level. Plot the graph with marking the highest point and edge frequency.
5. Repeat above procedures until all measured frequencies were complete.

### 5.7.3 Test Result

Pass

#### Remark:

During the Conducted Spurious Emissions test, pre-scan the 802.11b, 802.11g, 802.11n(20) modulation, and found the 802.11b modulation which it is worse case.

<b>Test Item:</b>	Band Edge	<b>Temperature :</b>	23°C
<b>Tested by:</b>	Windy Hu(Engineer)	<b>Relative Humidity :</b>	65%

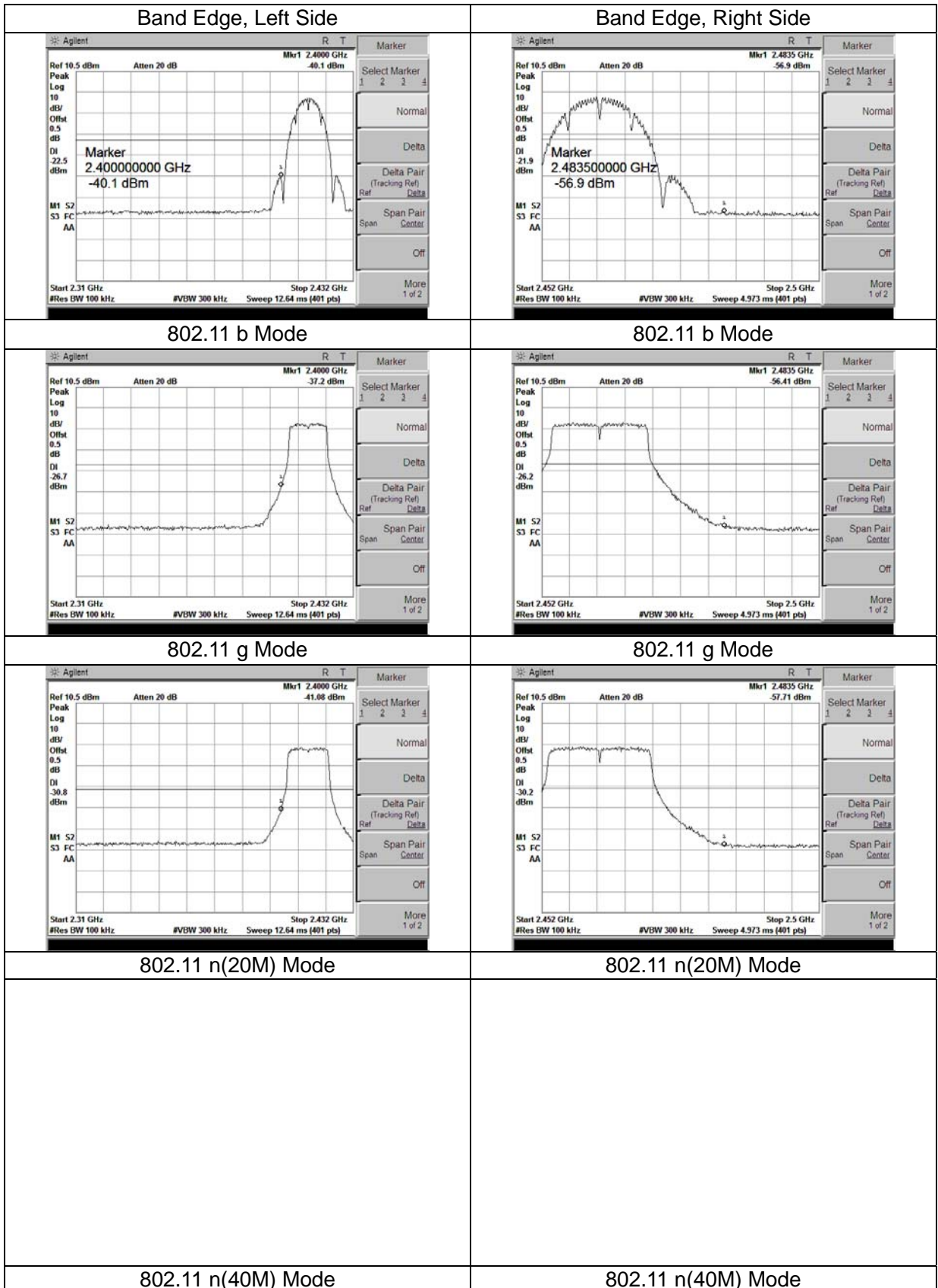

### Conducted Spurious Emissions

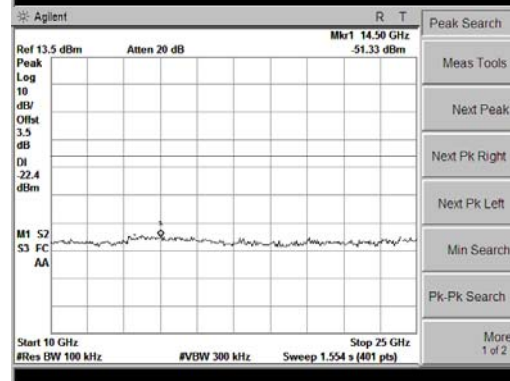
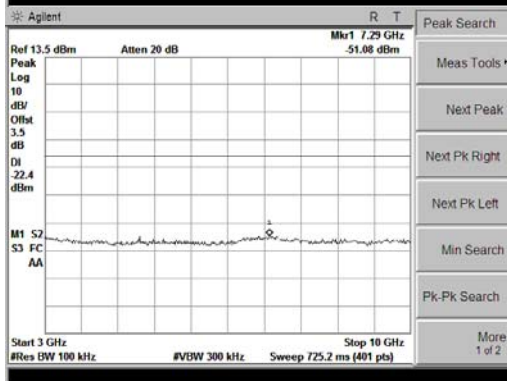
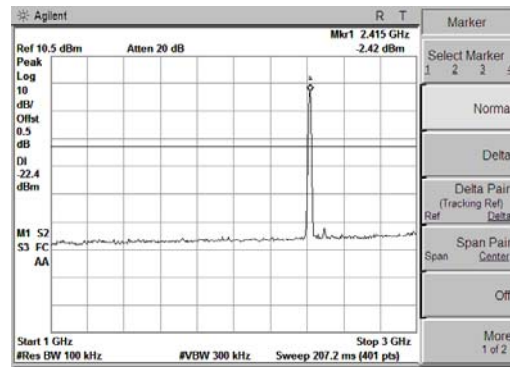
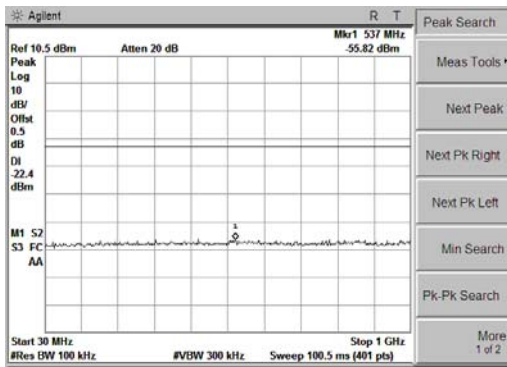

802.11b Mode, Ch1

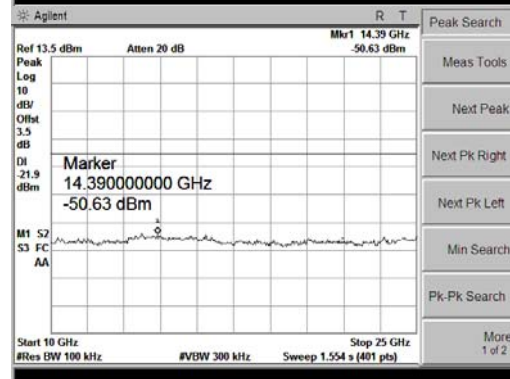
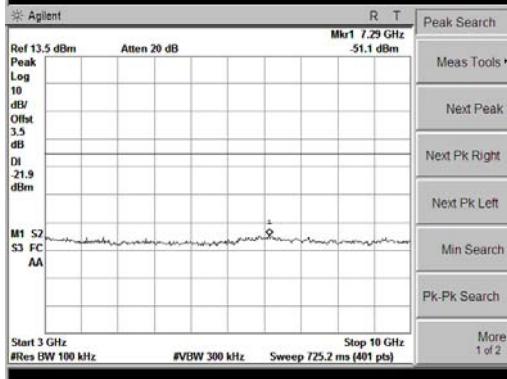
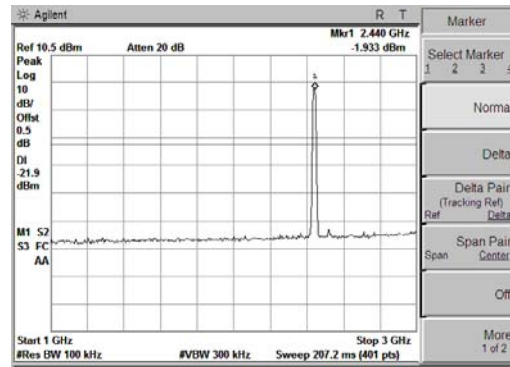
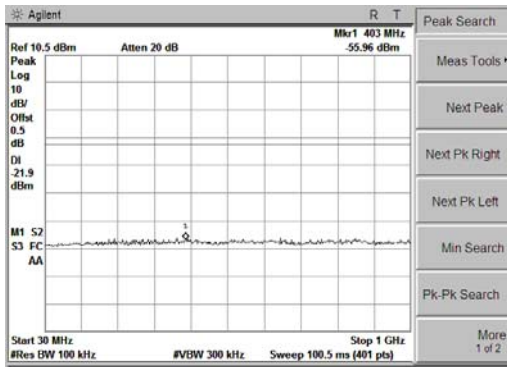

802.11b Mode, Ch6

### Conducted Spurious Emissions

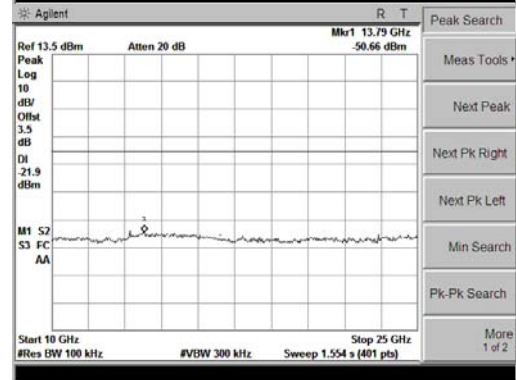
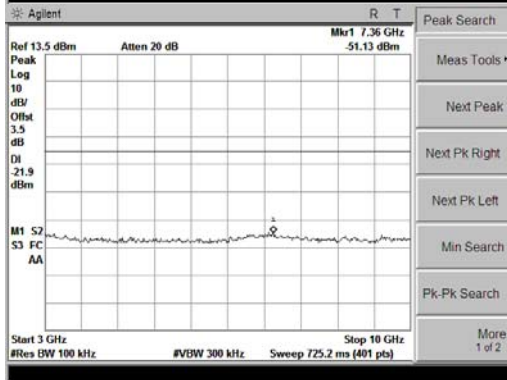
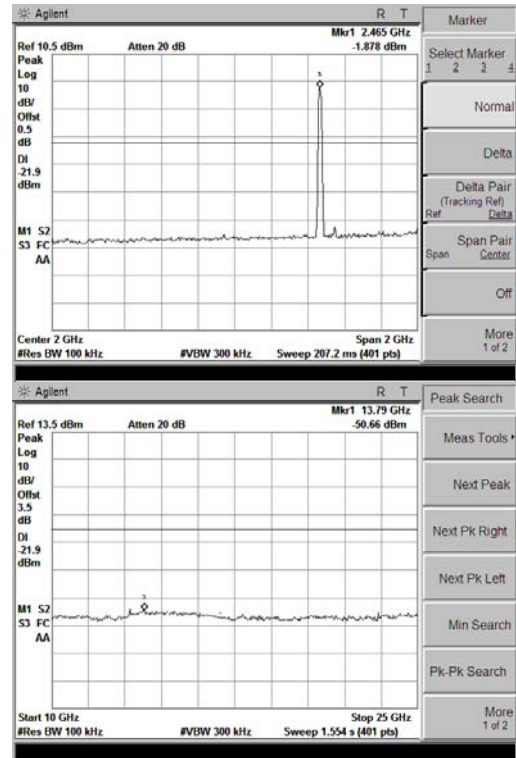

802.11b Mode, Ch11

## 5.8 Restricted Frequency Bands

### 5.8.1 Test Requirement

In any 100 kHz bandwidth outside the frequency band in which the spread spectrum or digitally modulated intentional radiator is operating, the radio frequency power that is produced by the intentional radiator shall be at least 20 dB below that in the 100 kHz bandwidth within the band that contains the highest level of the desired power. In addition, radiated emissions which fall in the restricted bands, as defined in §15.205(a), must also comply with the radiated emission limits specified in §15.209(a) (see §15.205(c)).

### 5.8.2 Test Configuration

#### Test Setup:

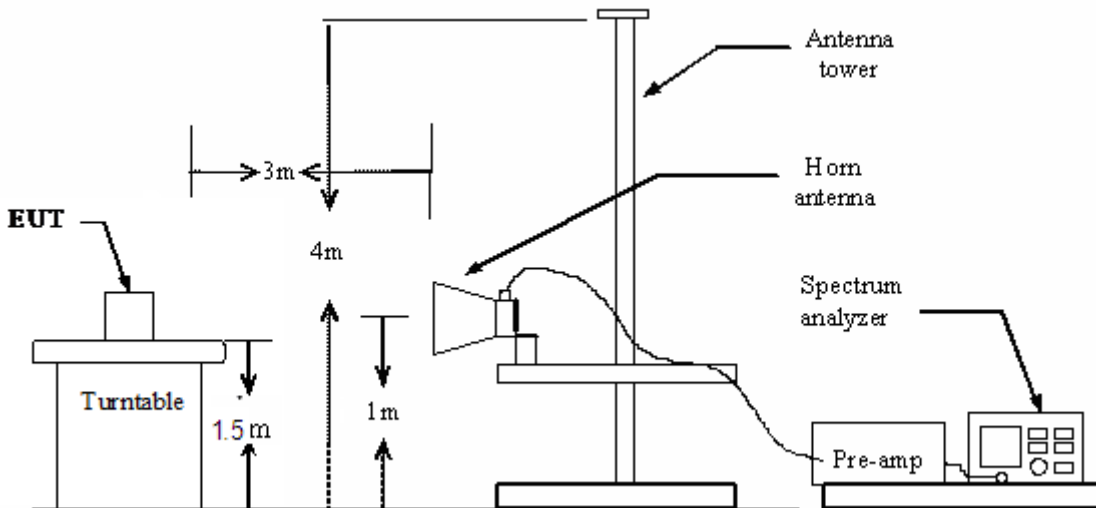

### 5.8.3 Test Procedure:

1. The EUT was placed on the top of a rotating table 1.5 meters above the ground at a 3 meter chamber. The table was rotated 360 degrees to determine the position of the highest radiation.
2. The EUT was set 3 meters away from the interference-receiving antenna, which was mounted on the top of a variable-height antenna tower.
3. The antenna height is varied from one meter to four meters above the ground to determine the maximum value of the field strength. Both horizontal and vertical polarizations of the antenna are set to make the measurement.
4. For each suspected emission, the EUT was arranged to its worst case and then the antenna was tuned to heights from 1 meter to 4 meters and the table was turned from 0 degrees to 360 degrees to find the maximum reading.

### 5.8.4 Test Result

Pass

Note: All test modes are performed, only the worst case is recorded in this report.

Please refer the following plots.

EUT:	Internet Radio	M/N:	MS-60i
Mode:	802.11b-CH1	Phase:	Vertical
Tested by:	Windy Hu(Engineer)	Power:	DC 9V by Adapter
Temperature: / Humidity	23.7°C / 51.6%	Test date:	2016-09-20

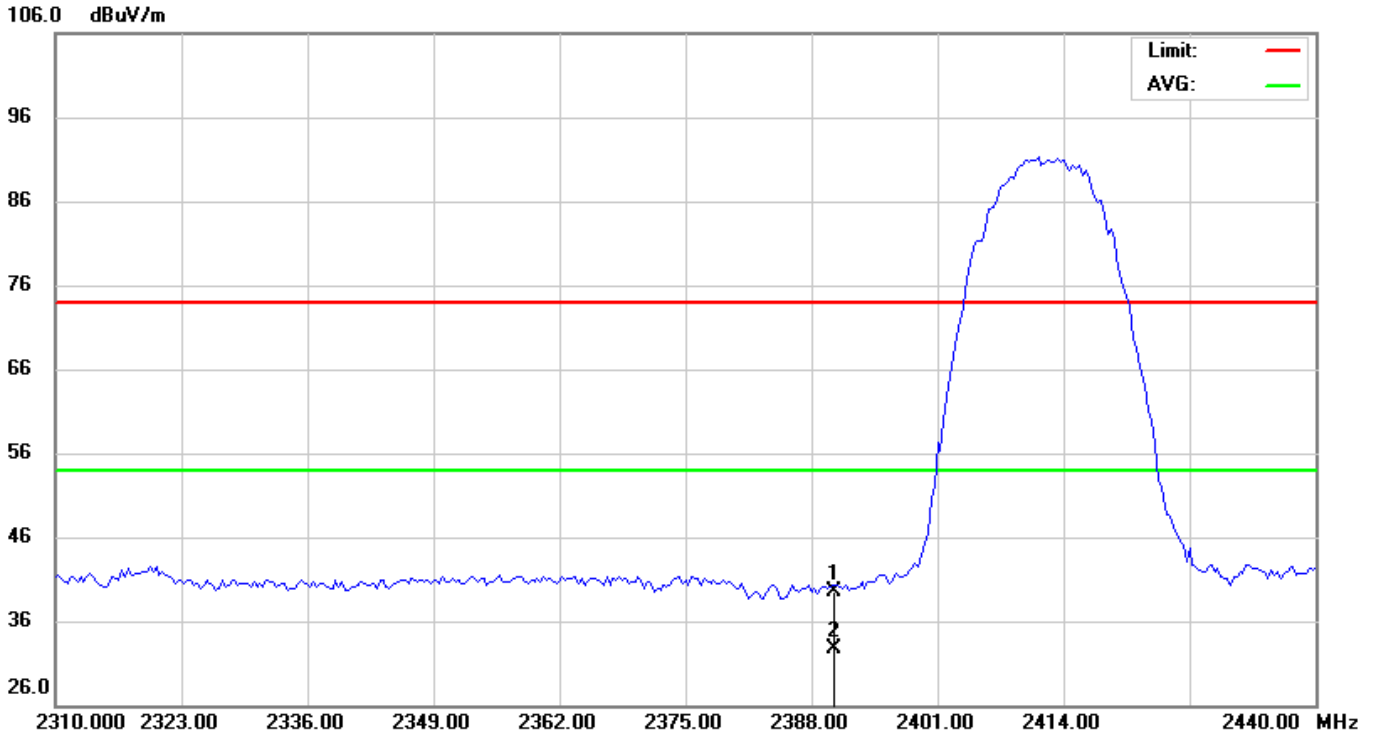

No.	Mk.	Freq.	Reading Level	Correct Factor	Measurement	Limit	Over	Antenna Height	Table Degree	
		MHz	dBuV	dB	dBuV/m	dBuV/m	dB	cm	degree	Comment
1		2390.000	47.86	-8.43	39.43	74.00	-34.57			peak
2	*	2390.000	41.03	-8.43	32.60	54.00	-21.40			AVG

\*:Maximum data    x:Over limit    !:over margin

<b>EUT:</b>	Internet Radio	<b>M/N:</b>	MS-60i
<b>Mode:</b>	802.11b-CH1	<b>Phase:</b>	Horizontal
<b>Tested by:</b>	Windy Hu(Engineer)	<b>Power:</b>	DC 9V by Adapter
<b>Temperature: / Humidity</b>	23.7°C / 51.6%	<b>Test date:</b>	2016-09-20

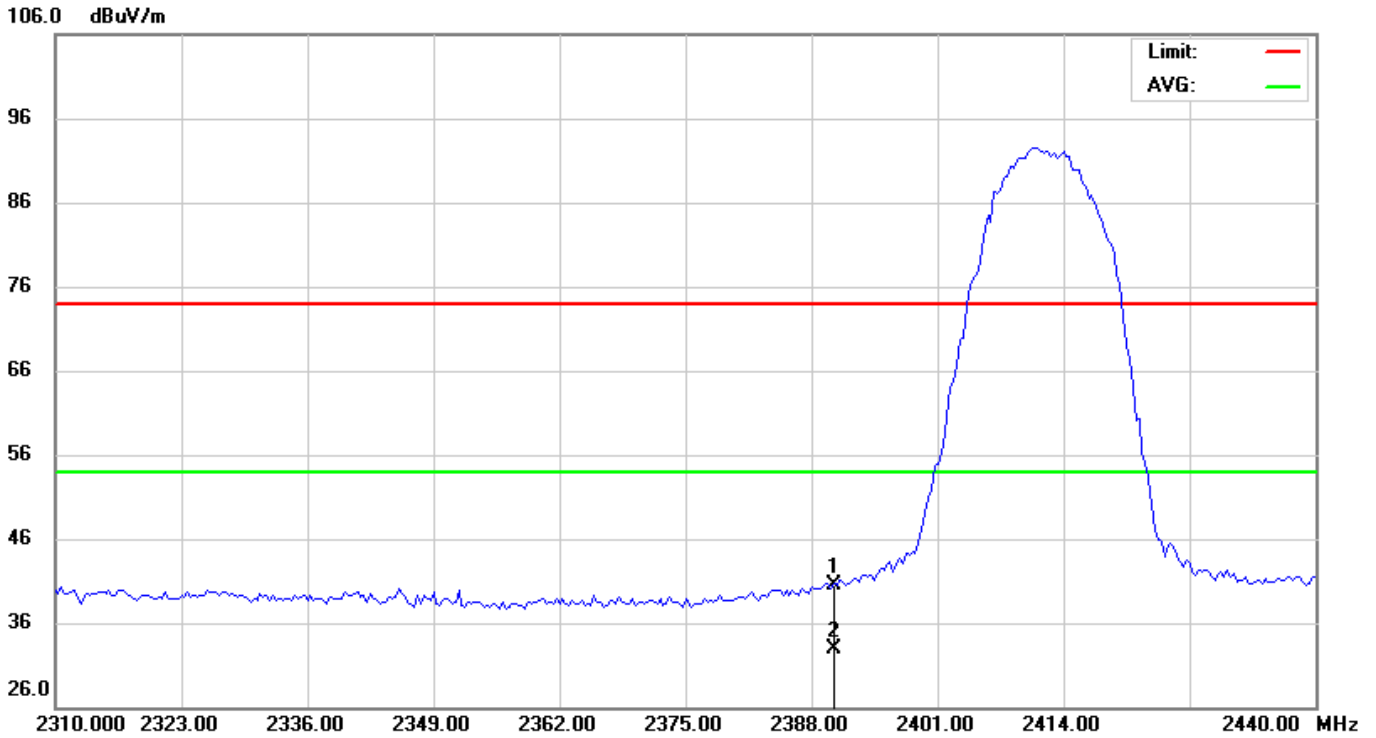

No.	Mk.	Freq. MHz	Reading Level dBuV	Correct Factor dB	Measure- ment dBuV/m	Limit dBuV/m	Over dB	Detector	Antenna Height cm	Table Degree	Comment
1		2390.000	49.01	-8.43	40.58	74.00	-33.42	peak			
2	*	2390.000	41.24	-8.43	32.81	54.00	-21.19	AVG			

\*:Maximum data    x:Over limit    !:over margin



<b>EUT:</b>	Internet Radio	<b>M/N:</b>	MS-60i
<b>Mode:</b>	802.11b-CH11	<b>Phase:</b>	Vertical
<b>Tested by:</b>	Windy Hu(Engineer)	<b>Power:</b>	DC 9V by Adapter
<b>Temperature: / Humidity</b>	23.7°C / 51.6%	<b>Test date:</b>	2016-09-20

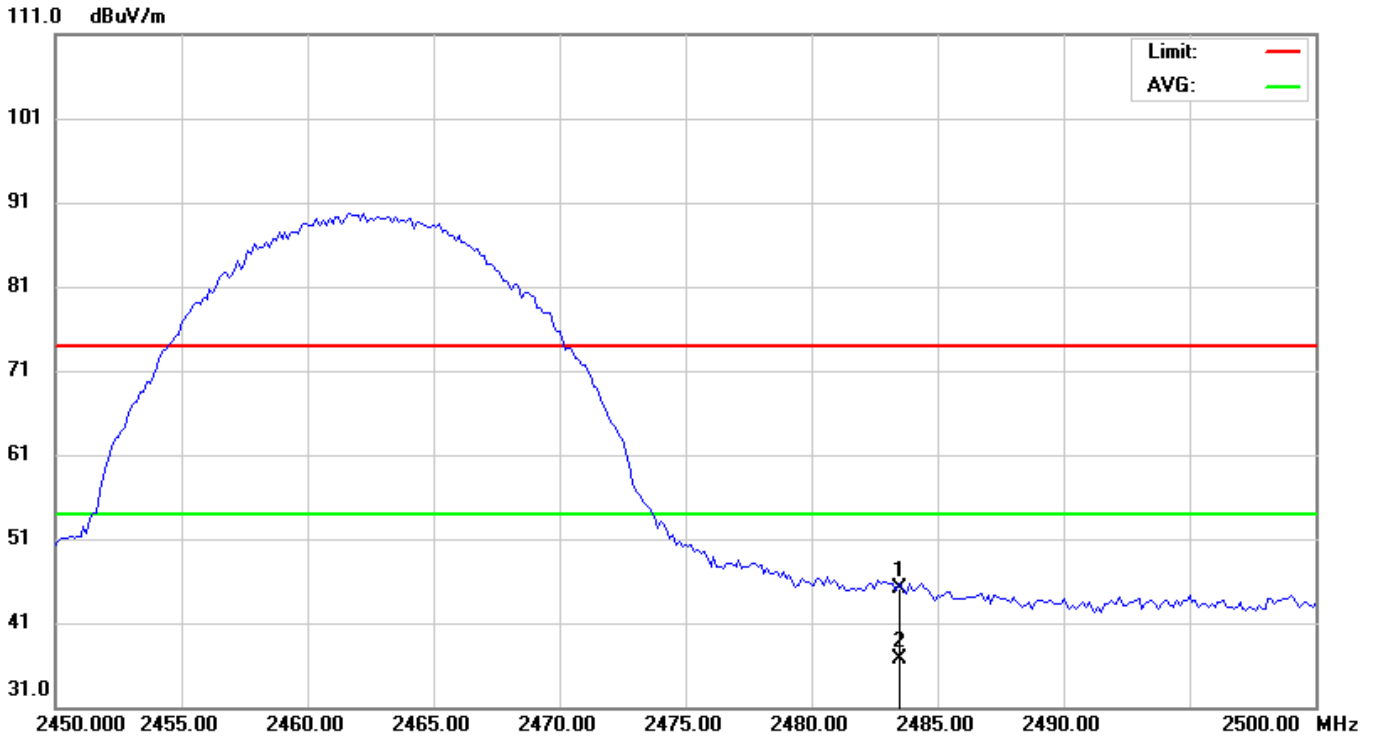

No.	Mk.	Freq.	Reading Level	Correct Factor	Measurement	Limit	Over	Antenna Height	Table Degree	
		MHz	dBuV	dB	dBuV/m	dBuV/m	dB	cm	degree	Comment
1		2483.500	53.43	-8.29	45.14	74.00	-28.86			peak
2	*	2483.500	45.01	-8.29	36.72	54.00	-17.28			AVG

\*:Maximum data    x:Over limit    !:over margin

<b>EUT:</b>	Internet Radio	<b>M/N:</b>	MS-60i
<b>Mode:</b>	802.11b-CH11	<b>Phase:</b>	Horizontal
<b>Tested by:</b>	Windy Hu(Engineer)	<b>Power:</b>	DC 9V by Adapter
<b>Temperature: / Humidity</b>	23.7°C / 51.6%	<b>Test date:</b>	2016-09-20

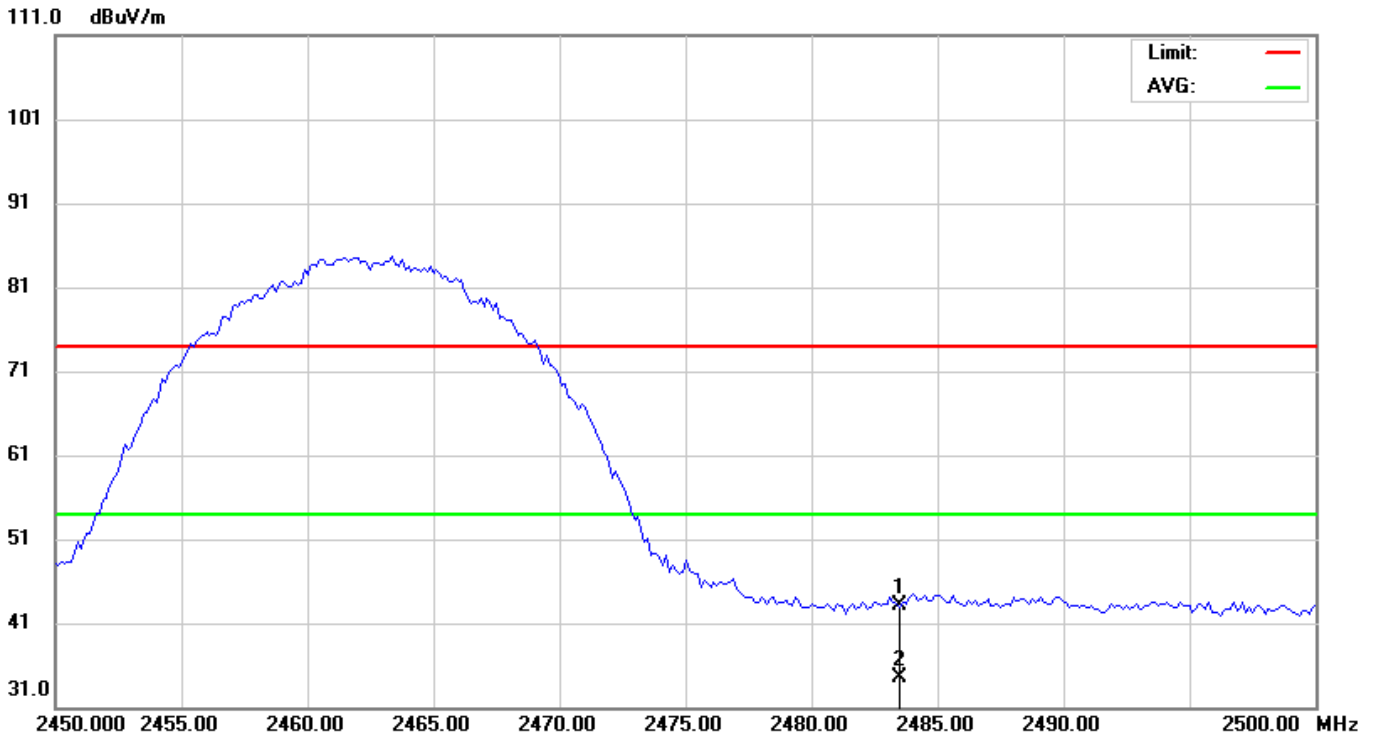

No.	Mk.	Freq. MHz	Reading Level dBuV	Correct Factor dB	Measure- ment dBuV/m	Limit dBuV/m	Over dB	Detector	Antenna Height cm	Table Degree degree	Comment
1		2483.500	51.43	-8.29	43.14	74.00	-30.86	peak			
2	*	2483.500	42.87	-8.29	34.58	54.00	-19.42	AVG			

\*:Maximum data    x:Over limit    !:over margin

EUT:	Internet Radio	M/N:	MS-60i
Mode:	802.11g-CH1	Phase:	Vertical
Tested by:	Windy Hu(Engineer)	Power:	DC 9V by Adapter
Temperature: / Humidity	23.7°C / 51.6%	Test date:	2016-09-20

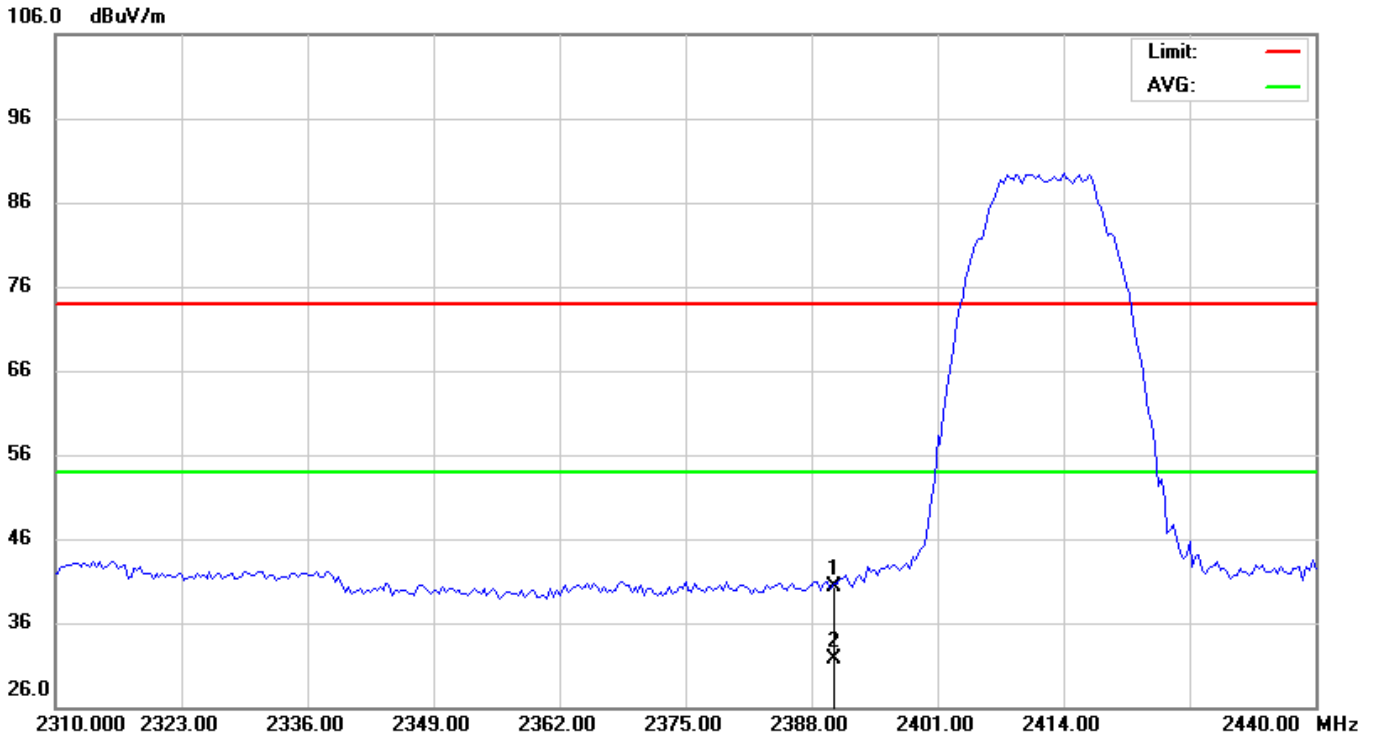

No.	Mk.	Freq.	Reading Level	Correct Factor	Measurement	Limit	Over	Antenna Height	Table Degree	
		MHz	dBuV	dB	dBuV/m	dBuV/m	dB	cm	degree	Comment
1		2390.000	48.76	-8.43	40.33	74.00	-33.67			peak
2	*	2390.000	40.03	-8.43	31.60	54.00	-22.40			AVG

\*:Maximum data    x:Over limit    !:over margin

EUT:	Internet Radio	M/N:	MS-60i
Mode:	802.11g-CH1	Phase:	Horizontal
Tested by:	Windy Hu(Engineer)	Power:	DC 9V by Adapter
Temperature: / Humidity	23.7°C / 51.6%	Test date:	2016-09-20

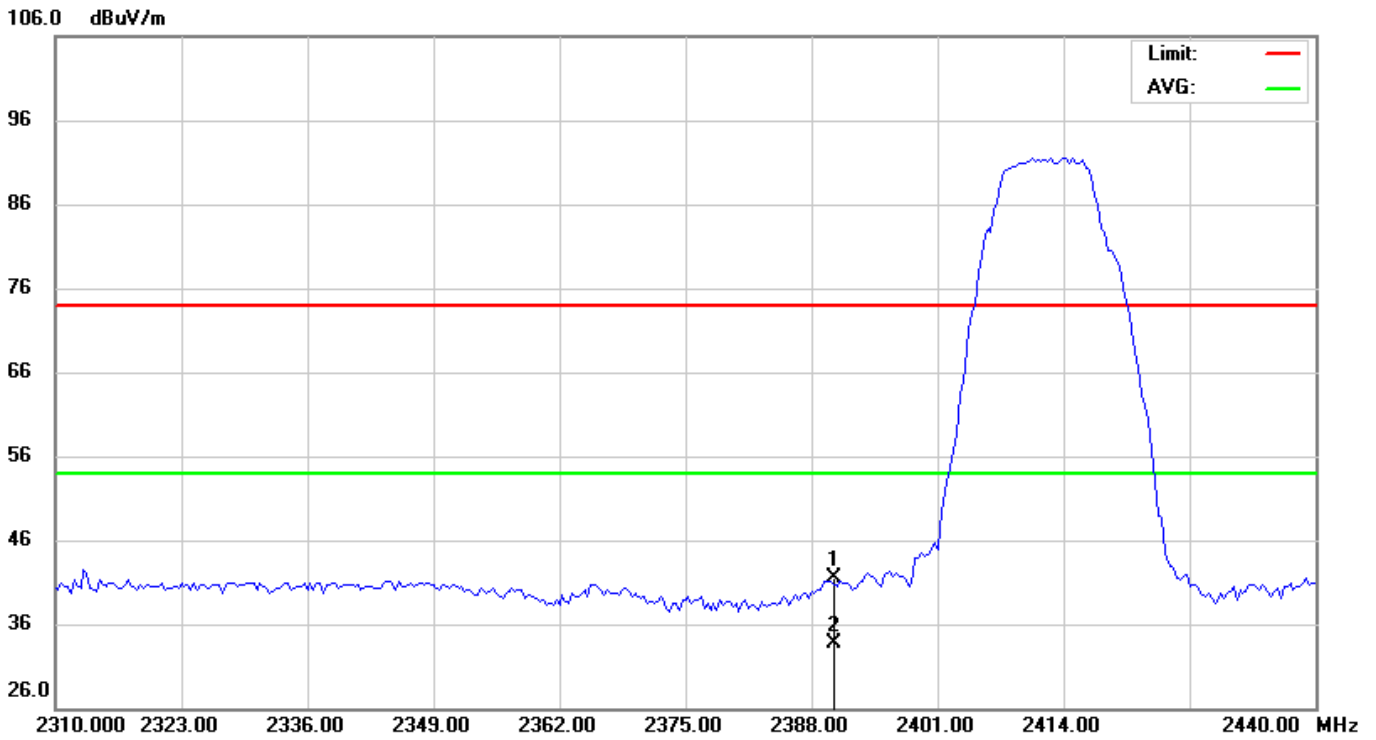

No.	Mk.	Freq.	Reading Level	Correct Factor	Measurement	Limit	Over	Antenna Height	Table Degree	Comment
		MHz	dBuV	dB	dBuV/m	dBuV/m	dB	cm	degree	
1		2390.000	49.85	-8.43	41.42	74.00	-32.58			peak
2	*	2390.000	42.03	-8.43	33.60	54.00	-20.40			AVG

\*:Maximum data    x:Over limit    !:over margin

EUT:	Internet Radio	M/N:	MS-60i
Mode:	802.11g-CH11	Phase:	Vertical
Tested by:	Windy Hu(Engineer)	Power:	DC 9V by Adapter
Temperature: / Humidity	23.7°C / 51.6%	Test date:	2016-09-20

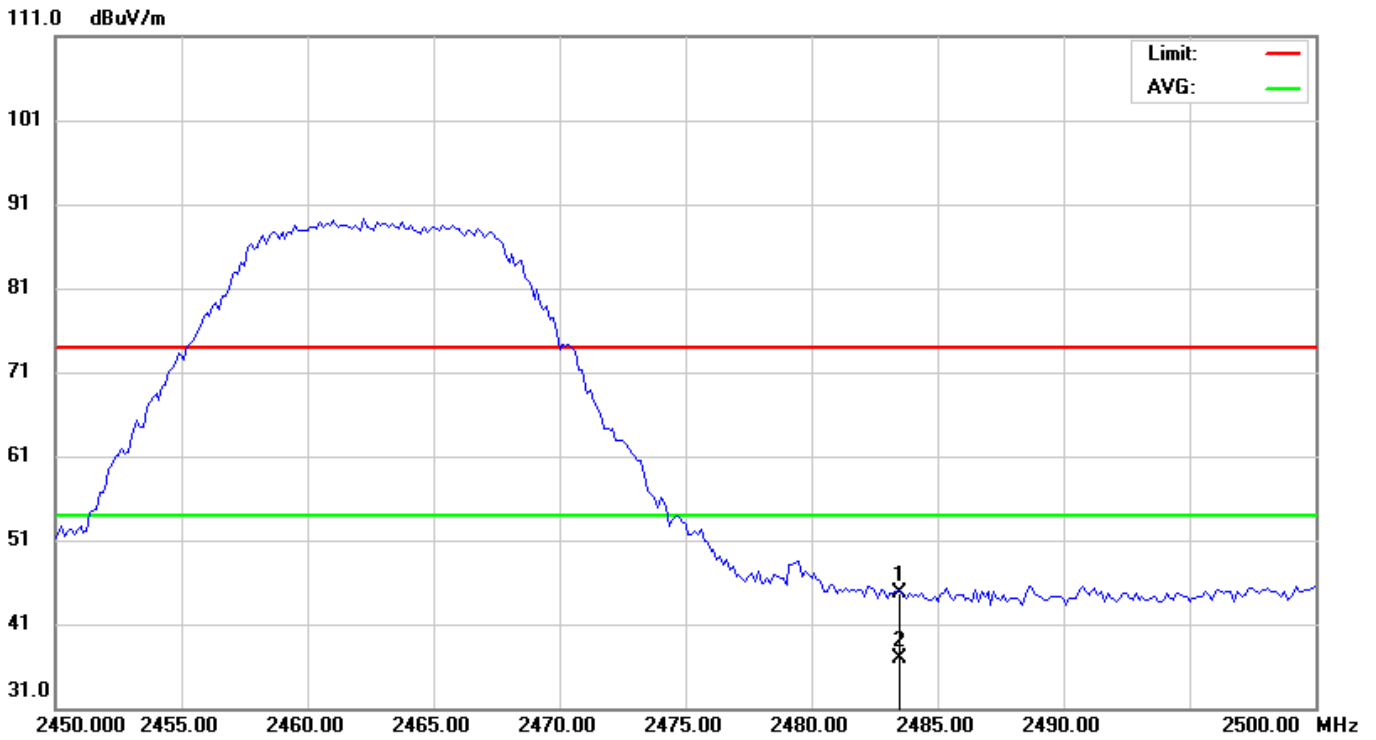

No.	Mk.	Freq.	Reading Level	Correct Factor	Measurement	Limit	Over	Antenna Height	Table Degree	
		MHz	dBuV	dB	dBuV/m	dBuV/m	dB	cm	degree	Comment
1		2483.500	53.03	-8.29	44.74	74.00	-29.26			peak
2	*	2483.500	45.21	-8.29	36.92	54.00	-17.08			AVG

\*:Maximum data    x:Over limit    !:over margin

EUT:	Internet Radio	M/N:	MS-60i
Mode:	802.11g-CH11	Phase:	Horizontal
Tested by:	Windy Hu(Engineer)	Power:	DC 9V by Adapter
Temperature: / Humidity	23.7°C / 51.6%	Test date:	2016-09-20

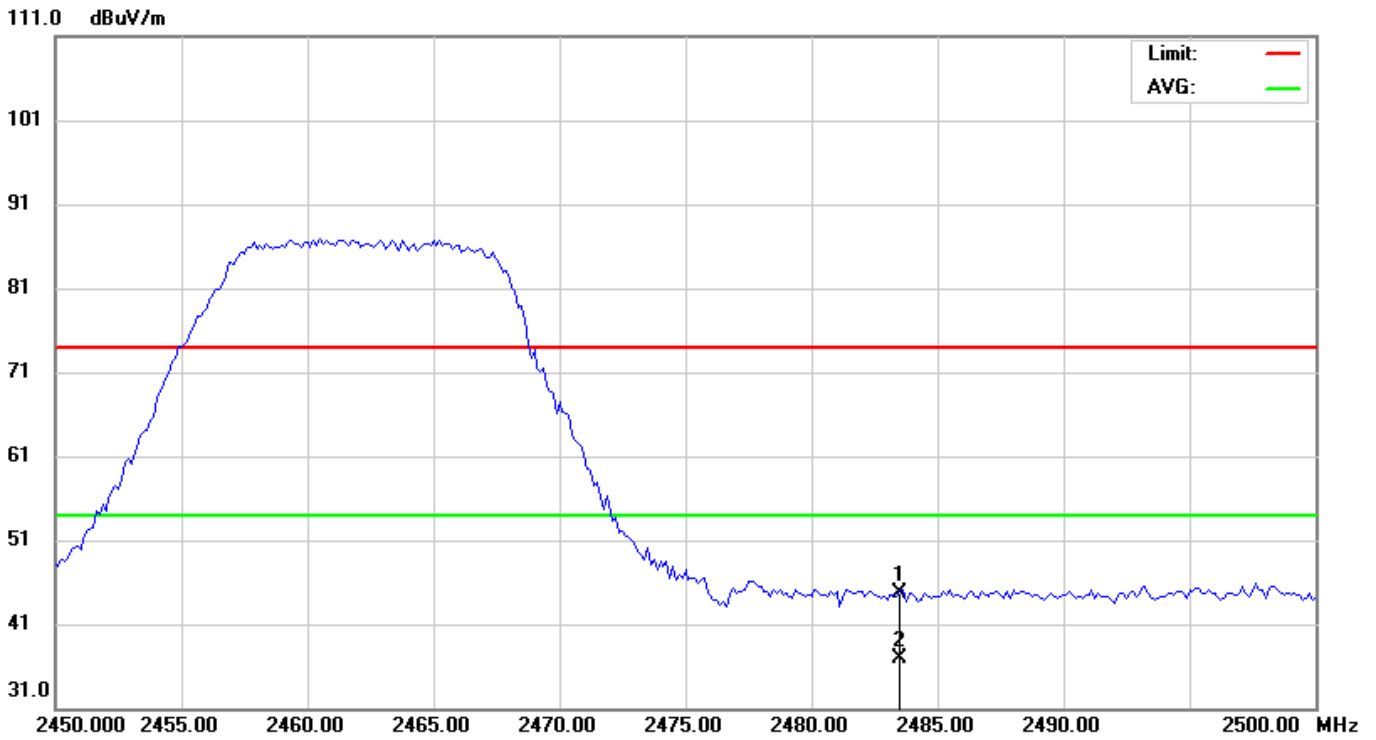

No.	Mk.	Freq. MHz	Reading Level dBuV	Correct Factor dB	Measure- ment dBuV/m	Limit dBuV/m	Over dB	Detector	Antenna Height cm	Table Degree	Comment
1		2483.500	53.02	-8.29	44.73	74.00	-29.27	peak			
2	*	2483.500	45.13	-8.29	36.84	54.00	-17.16	AVG			

\*:Maximum data    x:Over limit    !:over margin

EUT:	Internet Radio	M/N:	MS-60i
Mode:	802.11n(20M)-CH1	Phase:	Vertical
Tested by:	Windy Hu(Engineer)	Power:	DC 9V by Adapter
Temperature: / Humidity	23.7°C / 51.6%	Test date:	2016-09-20

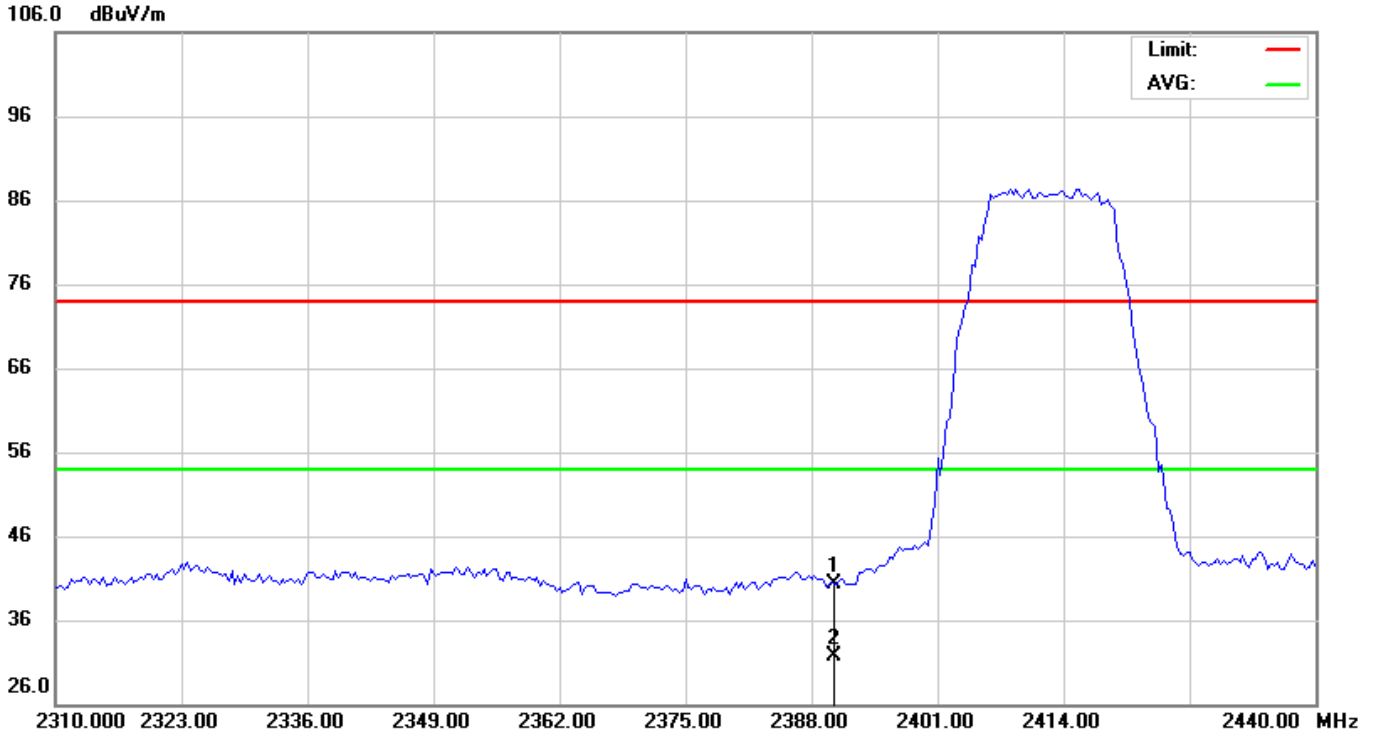

No.	Mk.	Freq. MHz	Reading Level dBuV	Correct Factor dB	Measure- ment dBuV/m	Limit dBuV/m	Over dB	Detector	Antenna Height cm	Table Degree degree	Comment
1		2390.000	48.76	-8.43	40.33	74.00	-33.67	peak			
2	*	2390.000	40.03	-8.43	31.60	54.00	-22.40	AVG			

\*:Maximum data    x:Over limit    !:over margin

EUT:	Internet Radio	M/N:	MS-60i
Mode:	802.11n(20M)-CH1	Phase:	Horizontal
Tested by:	Windy Hu(Engineer)	Power:	DC 9V by Adapter
Temperature: / Humidity	23.7°C / 51.6%	Test date:	2016-09-20

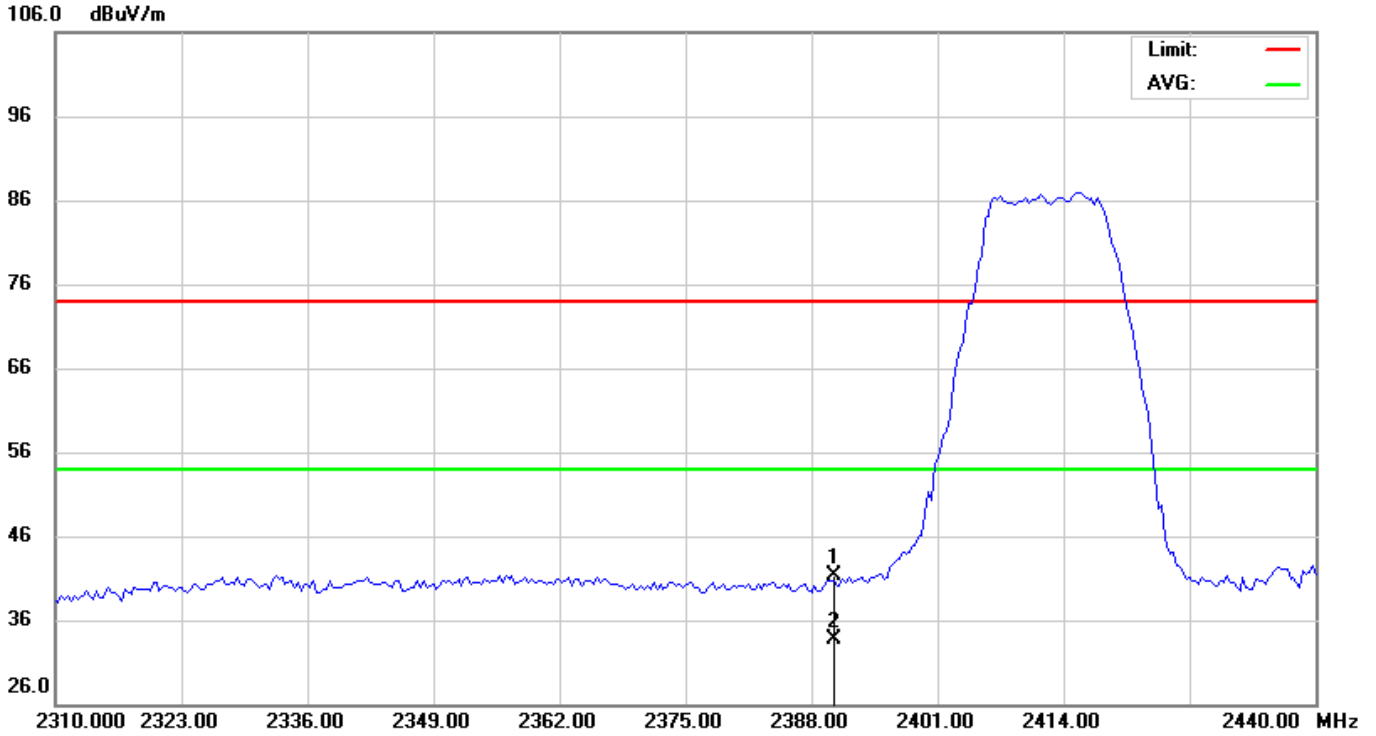

No.	Mk.	Freq. MHz	Reading Level dBuV	Correct Factor dB	Measure- ment dBuV/m	Limit dBuV/m	Over dB	Detector	Antenna Height cm	Table Degree degree	Comment
1		2390.000	49.76	-8.43	41.33	74.00	-32.67	peak			
2	*	2390.000	42.03	-8.43	33.60	54.00	-20.40	AVG			

\*:Maximum data    x:Over limit    !:over margin



EUT:	Internet Radio	M/N:	MS-60i
Mode:	802.11n(20M)-CH11	Phase:	Vertical
Tested by:	Windy Hu(Engineer)	Power:	DC 9V by Adapter
Temperature: / Humidity	23.7°C / 51.6%	Test date:	2016-09-20

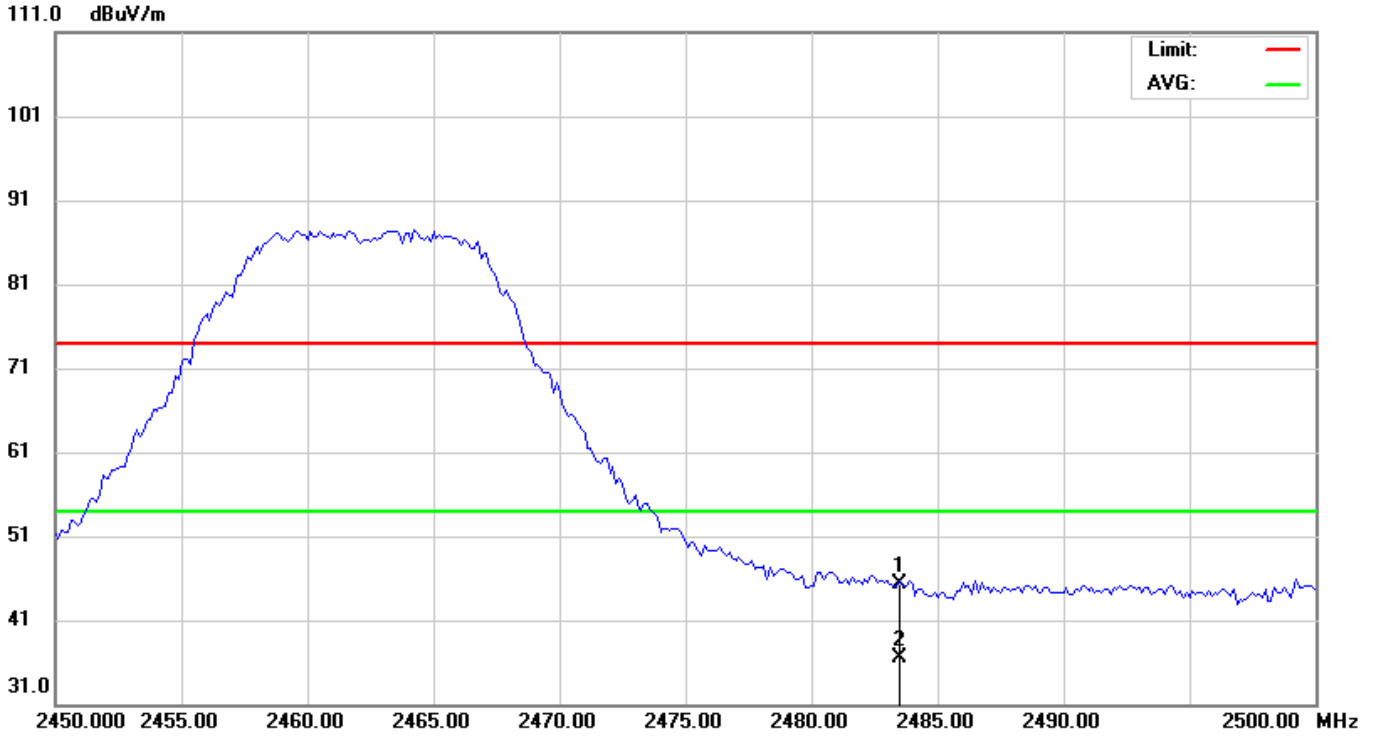

No.	Mk.	Freq.	Reading Level	Correct Factor	Measurement	Limit	Over	Antenna Height	Table Degree	
		MHz	dBuV	dB	dBuV/m	dBuV/m	dB	cm	degree	Comment
1		2483.500	53.60	-8.29	45.31	74.00	-28.69			peak
2	*	2483.500	44.70	-8.29	36.41	54.00	-17.59			AVG

\*:Maximum data    x:Over limit    !:over margin

EUT:	Internet Radio	M/N:	MS-60i
Mode:	802.11n(20M)-CH11	Phase:	Horizontal
Tested by:	Windy Hu(Engineer)	Power:	DC 9V by Adapter
Temperature: / Humidity	23.7°C / 51.6%	Test date:	2016-09-20

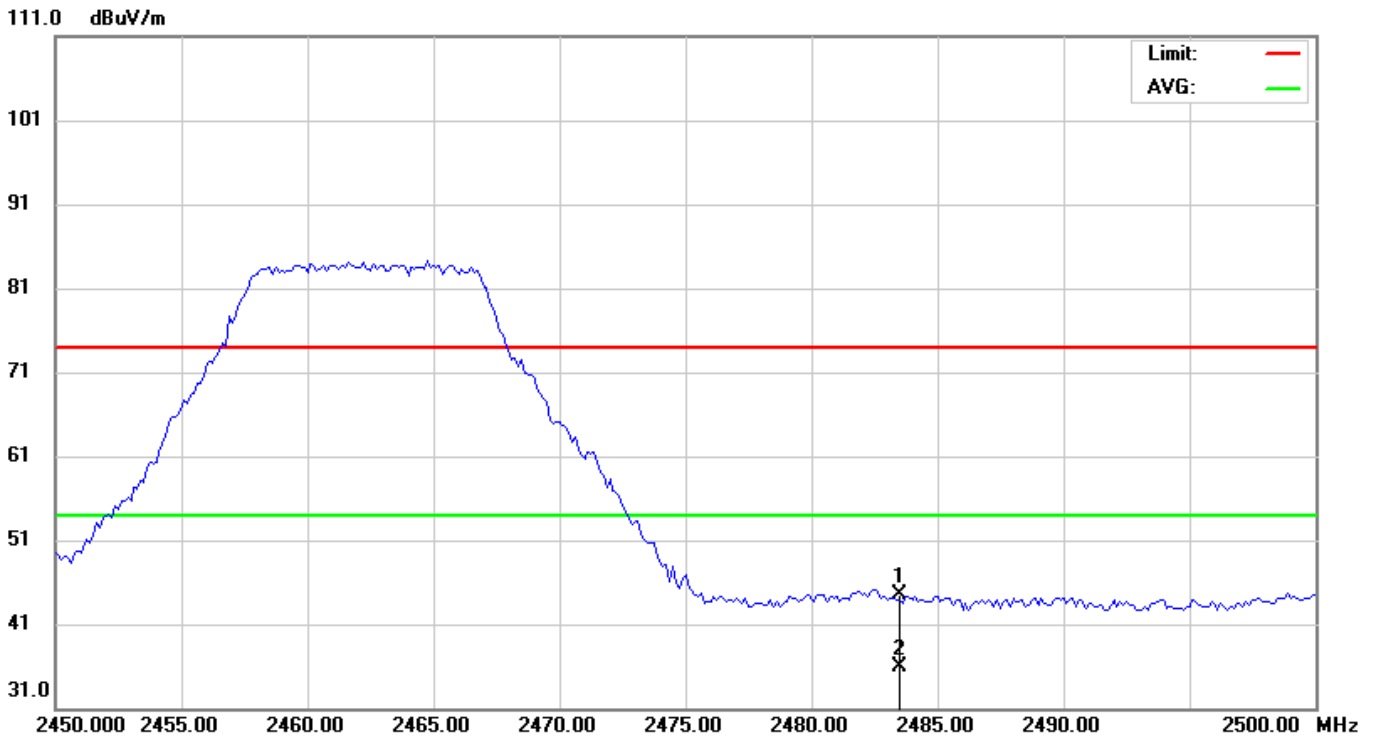

\*:Maximum data    x:Over limit    !:over margin

End of Report