

OPERATING MANUAL

ArtSound R99 Internet Radio Tuner

artsound
we speak sound

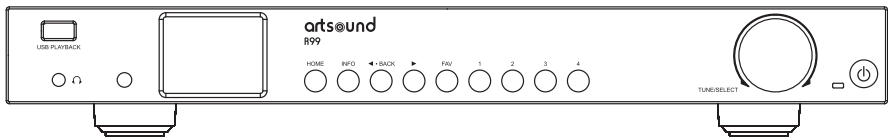

TABLE OF CONTENTS

1. Warnings and safety	2	16. Alarm Setting	11
2. Contents of the box	2	17. Sleep Timer Setting	12
3. Location of Controls	2	18. Configuration	12
4. Remote control	3	19. Web browser control via PC / Smart phone	
5. Entering security code for your wireless network	4	Tuning internet radio & manage favourite	15
6. Before you start	4	20. Trouble Shooting	17
7. Getting started	4	21. Helpful Tips	19
8. Network Setup	4	22. Technical Specification	19
9. Overview of features and functions	6	23. Warranty conditions	19
10. Internet Radio	6		
11. Media Centre	9		
12. USB playback	9		
13. DAB+/DAB Radio	10		
14. FM Radio	10		
15. Bluetooth playback	11		

Thank you for buying our ArtSound R99 radio. We hope you'll enjoy it for years to come. Please read these instructions carefully and keep this manual for later reference.

The R99 is a high-quality internet, DAB+ and FM radio with Bluetooth and stereo audio output and input.

1. WARNINGS AND SAFETY

- To prevent fire or electric shocks, the device must not be exposed to rain or humidity.
- For your own safety: to prevent electric shocks do not remove the housing.
- Do not try to repair any malfunctioning parts of the device yourself. Ask a professional expert to do this for you.
- When plugged into the mains, the device remains electrically charged even when switched off.

2. CONTENTS OF THE BOX

- Internet Radio Tuner
- Power adaptor
- Wire antenna
- External antenna x 2 pcs
- RCA cable
- Remote control (without batteries)
- User manual

3. LOCATION OF CONTROLS

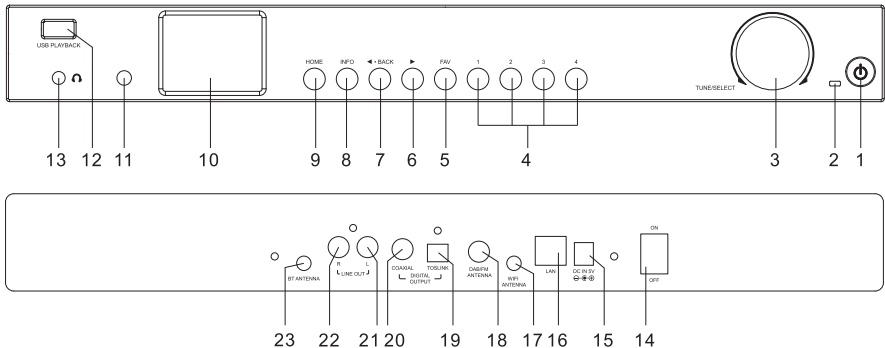















- Power**
Press to enter/exit from Standby mode
- Power LED**
Lit when DC-in has valid power
- Tune/Select**
Rotate to navigate menu
Rotate to adjust volume of headphone
Press to select an item
- Dedicated Preset button No.1-4**
Press and hold to preset 4 dedicated stations.
Press briefly to recall to play. These are independent presets and will not appear on the "My Favorite" list.
- FAV**
Press and hold to preset the favorite stations up to 150. Press it briefly to recall the list.
- ▶ (FORWARD)**
Press to cycle through the display option in radio playing mode / Enter edit menu in Favourite list / cursor right
- ◀ BACK**
Press to exit to previous menu / delete entry of character's input/ cursor left
- INFO**
Toggle to cycle through the station's info, the big clock display or return to now playing screen
- HOME**
Press to display Home screen to view different radio modes / setting options
- 2.4" TFT color display**
- IR sensor**
Receives Infra red signal from remote control

- 12. **USB Playback**
Play audios from USB thumb drive
- 13. **Headphone jack**
3.5 mm Headphone output with volume controlled by dial (for the line output volume control, please refer to the Line/Digital out setting on P.15)
- 14. **Power On/Off switch**
- 15. **DC-IN Jack**
- 16. **Ethernet (LAN) connector**
- 17. **WiFi antenna connector**
Connect the WiFi antenna before setting up the Tuner

- 18. **DAB/FM antenna**
- 19. **Digital out – Optical**
- 20. **Digital out - Co-axial**
- 21. **Line out - L**
- 22. **Line out - R**
- 23. **BT Antenna connector**
Connect the Bluetooth antenna before pairing with your bluetooth

4. REMOTE CONTROL

-  Mute
- 0-9** Input index number on the list / input characters for WiFi password
-  Preset the current playing station to Favorite
-  Cursor up
-  Cursor left / back to previous menu
-  Alarm button
-  Sleep Timer
- Mode** Switch between Internet radio/DAB/FM/Bluetooth/Media Centre
-  Main Menu
-  Previous station on the list/previous track on bluetooth/Media Centre
-  Access network info of the radio unit
-  Press to toggle between Standby and Operation
-  Recall the favorite list
- OK** confirm button
-  Cursor right
-  Cursor down
- Vol+** Volume up
- Vol-** Volume down
- EQ** Equalizer
-  Next station on the list/next track on bluetooth/Media Centre
-  Play/pause for Bluetooth/Media Centre Play/stop for Internet radio
- Dimmer** Access the Dimmer menu to adjust the brightness of the display
- Info** Toggle to cycle through the station's info, the big clock display or return to now playing screen

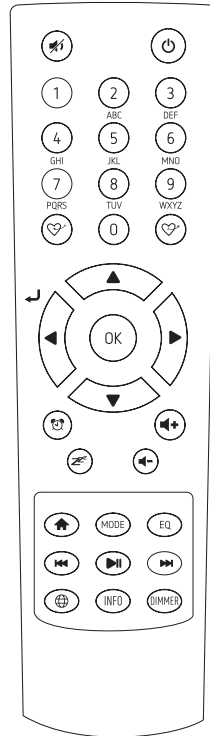

5. ENTERING SECURITY CODE FOR YOUR WIRELESS NETWORK

USING REMOTE CONTROL

On the alpha-numerical keypad, press buttons repeatedly to cycle through the letters, numbers and symbols as listed below.

To input a character, scroll to the correct one and when it is highlighted, press the [▶] button to input the next character. When it comes to the last character of the password and it is highlighted, press [OK] to confirm.

Button 1: 1 and different kind of symbols !@#\$%^&*()_+[]:;'"",./<>?	Button 4: 4GHlghi	Button 8: 8TUVtuv
Button 2: 2ABCabc	Button 5: 5JKLjkl	Button 9: 9WXYZwxyz
Button 3: 3DEFdef	Button 6: 6MNomno	Button 0: 0
	Button 7: 7PQRSpqrs	

USING CONTROL BUTTON ON THE RADIO UNIT

Use the [Tune/Select] knob to scroll through the characters, when the correct one is highlighted, press [▶] button to input the next character. When it comes to the last character of the password and it is highlighted, press and hold the [Tune/Select] to confirm.

Note: The security code is case sensitive.

6. BEFORE YOU START

Please ensure the following is ready:

You have a broadband internet connection.

A wireless broadband router is connected to the internet successfully. The radio supports Wireless B, G and N connection (Wireless N router can also be used with the setting on B or G). You know the Wired Equivalent Privacy (WEP) or Wi-Fi Protected Access (WPA) data encryption code/password. You need to key in the correct code when the radio is connected to the wireless router for network connection. If you do not know the code/password, please contact the person/technician who set up the router/network for you.

The radio can work via Wireless network connection (Wi-Fi connection) and Wired connection (Ethernet RJ45).

7. GETTING STARTED

- Remove internet radio tuner (called Tuner hereafter) from the package box. There are two external antennas included in the accessories. Both are identical. Connect them to the connectors at the back of the Tuner, labelled with BT Antenna and WiFi antenna respectively. Without the antennas installed, the WiFi and Bluetooth function do not work properly.
- Plug in the DC adapter and switch the Power on/off switch (on the rear cabinet) to ON. The Tuner will turn on automatically.
 - Caution: Use only the adaptor supplied with the radio. Connecting a power supply with a different rating will cause permanent damage to the radio and may be hazardous.
- The Tuner is intended to connect with external powered speaker. It does not have amplifier and speaker driver built-in. Please connect your stereo through the Analogue output or Digital output located on the rear panel of the Tuner for listening.

8. NETWORK SETUP

Internet connection can be setup via Wired LAN or Wireless LAN (WiFi).

Your Radio requires a broadband Internet connection through wired Ethernet or WiFi. The easiest way is use a CAT 5 or CAT 6 cable to connect through wired Ethernet to a Wifi router, which connects to an Adsl modem or a cable modem provided by your ISP.

WIRED LAN (ETHERNET)

For Wired Ethernet connection to a router with DHCP enabled, the network configuration for Internet connection is automatically done and the Radio can be used for Internet radio and UPnP sharing without user interaction. When the network is connected, the Ethernet icon  will appear on the top left corner.

WIRELESS LAN (WI-FI)

Connect the Wi-Fi antenna to the connector at the back side of the tuner. If this is first time use, the Configure Network wizard will be displayed. Choose Yes to start configuring network. Rotate the [TUNE/SELECT] knob to highlight Yes and press [TUNE/SELECT] to confirm.

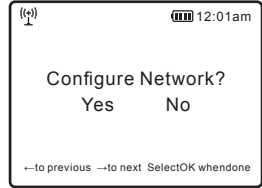

- Select Network and choose Add wireless network from the list, use the [TUNE/SELECT] knob to scroll and press it to confirm, then choose “Scan & select”:

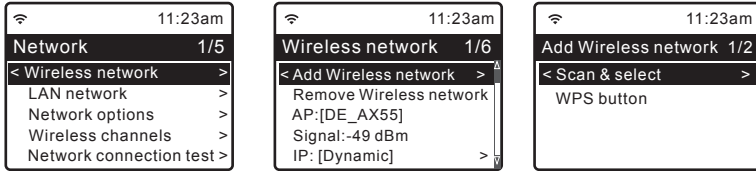

- It will start scanning the Wi-Fi networks available. Scroll to your network and press [Tune/Select] to confirm. If your wifi network has a password protected, it will ask you to enter the passphrase/password. Please refer to the above section '**How to input password for your wireless network**' on P.4.
Note: The password is case sensitive. Please consult with the one who setup your network if you don't know the password.

Alternatively, WPS connection is available if your router has a WPS button (Configuration > Network > Wireless Network > Add wireless network > WPS button).

- When the Wi-Fi connection is successful, the Association Complete will be shown briefly. The wifi signal bar will appear on the top left corner of the display

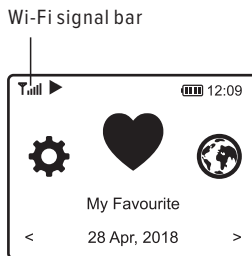

9. OVERVIEW OF FEATURES AND FUNCTIONS

Press [HOME] to enter the Home screen or the **⬆** on the remote control. Scroll by rotating the [Tune/Select] knob or the [◀ / ▶] button on remote:

My Favorite To show the list of favorite stations which have been assigned to the presets. There are up to 99 presets available.

Internet Radio Start exploring the worldwide radio stations and music here.

Media Centre You can browse and stream music from your network via UPnP or DLNA Compatible devices.

DAB+/DAB Radio

Pick up DAB+ and DAB radio signal if available in your local area (no internet connection required).

FM Radio Receive ordinary FM radio stations in your local area (no internet connection required).

BT Streaming Bluetooth playback, to play audio stream (receive) from another Bluetooth enabled device after pairing/connected each other.

Alarm Alarm clock. Two alarm settings available (works only when power is connected).

Sleep Timer Enable the timer to turn the radio in standby after the selected time elapsed.

Configuration More options/settings available to personalize as you desire.

Clock style Set the clock display in Digital or Analog as you like. Under Configuration > Date & Time > Set clock style.



Digital style

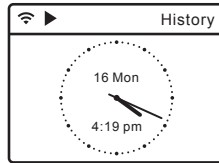

Analog style

10. INTERNET RADIO

On the Home screen, choose Internet Radio and you will find the options below:

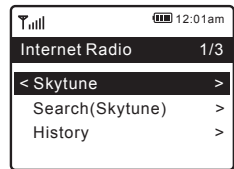

SKYTUNE

Select Skytune to start enjoying thousands of radio stations over the world. You can filter your search by Region, Music genre and talks.

The **Local Radio** let you access quickly the stations available in your local area through internet connection.

Note - You can change the Local Radio area under **Configuration> Local radio setup**. Please refer to section 12 for the details.

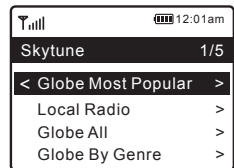

Note - When you scroll along the list of Globe All and want to quickly reach to a certain point of the long list, input the index number on the remote control to quickly jump to that point. For example, on the remote control, input 2 8 and press OK, it will highlight the station no. 28.

SEARCH

Instead of browsing the radio station list, you can input a few characters of the desired station to filter out / short list the stations.

HISTORY

The radio memorizes the stations you have listened up to 99 stations. If you have listened more than 99 stations, it will supersede the first station that you have listened.

START PLAYING INTERNET RADIO

When a radio station starts playing, more radio information can be displayed. Press the [INFO] button in the state of the playing screen below:



Every time you press the [INFO] button, it will show various information at a time such as the streaming bit rate, name of the song, artist name (if available), the big time clock and the radio's station logo (if available) or return to now playing screen:

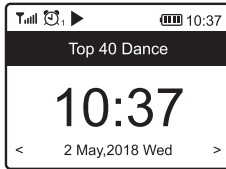
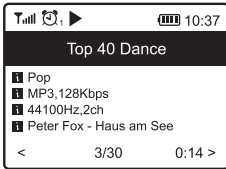

Press [HOME] to return home screen. To go back to the playback screen, press the [HOME] button again.

MY FAVORITE

This is to show the list of your Favorite stations which have been assigned to the presets.

PRESET A STATION

When a radio station is playing, press the button on the remote control, you will see the icon appears as below. It means the station is added to the Favorite list. Alternatively, you can press and hold the [FAV] button on the Tuner to save to Favorite.

The new added station will always show in the last item on the Favorite list. You can store up to 150 presets.

Preset icon

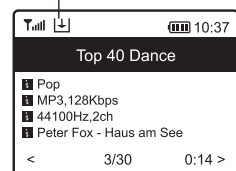

RECALL A STATION

Press the button on the remote control to recall the list of My favorite, or navigate to My Favourite on the Home screen and select it to confirm. On the Tuner, press the [FAV] button to recall the favorite list.

DEDICATED PRESET BUTTON #1-4

Program the 4 preset button to access the stations you play it most of time. Press and hold the 1-4 button on the Tuner to preset, press it briefly to recall.

Note - The 4 dedicated preset stations do not appear on the "My Favorite" list. To replace it with another station, play the station you want to replace with, then press and hold the preset number button on the Tuner.

CREATE NEW CATEGORIES - MAKE YOUR OWN FAVORITE LIST

There are two items in the My Favorite list as below, "All Favorites" and "Uncategorized":

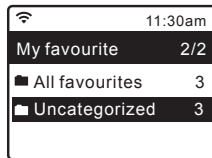

You can create new categories of your favorites and name it as you like, e.g., "Morning mix", "My Jazz", "After work"...etc to manage your favorites.

In the page of "My Favorite", press the [>] button, it will enter the edit menu with "Create Category" as below:

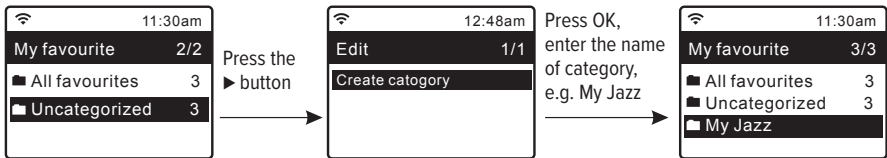

When a category is created (can create more categories as you like), you can now assign the stations to the category as desired. The "Uncategorized" means the stations which are not assigned to any categories yet.

To move the stations to the respective category, enter either the "All Favorites" or "Uncategorized" folder, choose the station from the list and select "move to category", then highlight the category to move it to and press OK to confirm.

You can always move the station from one category to the other.

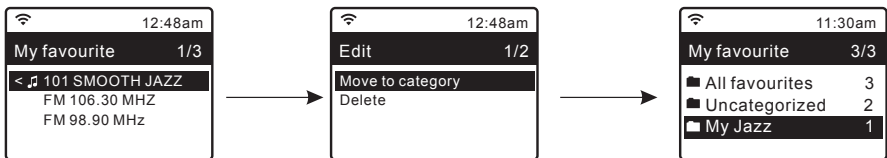

Highlight the station to move category press OK to confirm

Choose "Move to category", it will display the list and select the one you want to move it to. e.g., "My Jazz", then press OK.

The station is now moved to "My Jazz" folder.

11. MEDIA CENTRE

The device supports UPnP and is DLNA-compatible.

This provides the opportunity to stream music from your network. However, this requires you to have a compatible device in your network that can function as a server. This can be e.g., a network hard drive or a conventional PC with e.g., Windows 8 via which access to the shared folder or media sharing is permitted. The folders can then be browsed and played on the radio.

Note – Please make sure your computer laptop is on the same Wi-Fi network as the Radio before you start using this function.

MUSIC STREAMING

- Once the UPnP/DLNA compatible server is configured to share media files with your radio, you can start music streaming.
- On the main menu, select **Media Centre and choose UPnP**.
- It may take a few seconds for the radio to complete the scan for available UPnP servers. If no UPnP servers are found, it will show **Empty List**.
- After a successful scan is done, select your UPnP server.
- The radio will show the media categories available from the UPnP server, e.g. 'Music', 'Playlists' etc.
- Choose the media files that you wish to play.
You can set the mode of playback under **Configuration > Playback setup**.

MY PLAYLIST



You can make your own playlist for the UPnP music files. Choose and highlight the song you want to add to playlist, press and hold the [**FAV**] button or press the  button on remote, until the sign appears. The song will be added to **My playlist**.

CLEAR MY PLAYLIST

Remove all songs in “My Playlist” to allow a new playlist to be prepared.

Note – If you have DLNA compatible servers available, follow the steps described above to browse the audio files from DLNA compatible device on the radio to play.

12. USB PLAYBACK

Another option to listen to your favorite music is via the USB thumb drive. Insert the USB drive to the USB port on the Tuner. Press the Home button and navigate to "USB" and confirm the selection. It will take a moment to read the USB drive before it starts playing the music. To skip the next or previous track by remote control, press the [ / ] buttons. On the Tuner, press the [HOME] button will pop up the Hotkey menu to choose more control options.

To pause/play the music, press in the [TUNE/SELECT] knob on the Tuner or  on the remote control.

Note: If a USB thumb drive is not recognized, the list of files on the drive is corrupted or a file in the list is not played, please connect the USB drive to a PC, format the device and try again. The supported file system is FAT16 and FAT32.

A USB drive requires high power (more than 500mA or 5V) is not supported.

Compatible audio format: MP3, AAC, AAC+

13. DAB+/DAB RADIO

If there is Digital Audio Broadcasting (DAB) in your area, the Tuner can pick up the DAB stations as well (no internet connection is required). The Tuner supports both DAB and DAB+.

Connect the wire antenna (supplied in the box) to the antenna jack on the rear cabinet. Place the Tuner close to the window and extend the antenna as far as it can go to get the best reception.

On the Home screen (main menu), scroll to **DAB Radio** or use the [MODE] button on the remote to switch to DAB Radio and confirm the selection.

Choose **DAB full scan** to confirm scanning if this is the first time using the DAB radio. Confirm to start scanning and it will show the progress on the number of channels received. When it is done, a preset page will be displayed for your action.

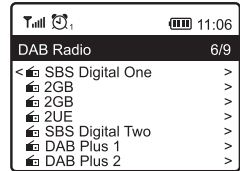

You can select the channel and start listening to it. Whenever you want to add to My Favourite, press the button on the remote or press and hold the [FAV] button on the Tuner, it will add to the favourite list.

Always press the [◀◀ / ▶▶] button on the remote to skip to previous or next preset. Press the [◀] button (or use the [TUNE/SELECT] knob on the Tuner) to return to the Preset list.

Note – When a DAB radio is playing, press the [INFO] button to view more radio information, each time you press the [INFO] button, it will display various information at a time such as radio frequency, rolling texts (if available) and big time clock.

New digital radio stations should be picked up automatically by the radio if they are part of a multiplex you already received. Otherwise you need to do the DAB full scan again.

14. FM RADIO

To receive the ordinary FM stations (no internet connection is required), place the radio close to the window and extend the antenna as far as it can go to get the best reception. You may need to adjust the direction of the antenna to improve reception.

On the main menu, scroll to FM Radio or use the [MODE] button on remote to switch to FM Radio. Press [OK] to start.

Choose **FM full scan** to confirm scanning if this is the first time using the DAB radio. Confirm to start scanning and it will show the progress on the number of channels received. When it is done, a preset page will be displayed for your action.

You can select the channel and start listening to it. Whenever you want to add to My Favourite, press the button on the remote or press and hold the [FAV] button on the Tuner, it will add to the favourite list.

Always press the [◀◀ / ▶▶] button on the remote to skip to previous or next preset. Press the [◀] button (or use the [TUNE/SELECT] knob on the Tuner) to return to the Preset list.

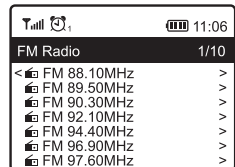

Note – When it is playing FM radio, press the [INFO] button to view more radio information, each time you press the [INFO] button, it will display various information at a time such as radio frequency and big clock display.

MANUAL TUNE

To manual tune to the frequency, long press the [OK] on remote or long press [Tune/Select] on the unit, until you see the "Tuning" appeared on the display, at the bottom right corner. Use the <| / >| button on remote to tune the frequency. When done, long press the [OK] button to exit manual tune.

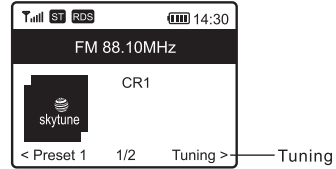

15. BLUETOOTH PLAYBACK

Before transmission between your Bluetooth device and the radio is possible, both devices must be coupled. This process is called "pairing". The radio is served as a receiver, to receive music stream to play on the radio.

If you have already coupled to a Bluetooth device before, this connection will be restored automatically when both devices are in range and Bluetooth operation has been selected on the radio. "Pairing" does not have to be repeated. This function may need to be activated in your Bluetooth device, however.

- Push the [HOME] button to display the selection menu for the different operating modes.

- Use the up/down button to select the operating mode Bluetooth and push the dial switch.
- Switch your Bluetooth device to which you want to connect the radio on and activate the pairing mode here. The device scans for Bluetooth devices in the reception range.
- When the radio is found, your bluetooth device shows its name ArtSoundR99-XXXX (the XXXX is an identification code for your radio unit).
- Select the radio at your bluetooth device.
- Start playback on your bluetooth device.
- Playback now takes place using the radio.

16. ALARM SETTING

- Choose **Alarm** from the main menu or press the [Alarm] button on the remote control.
- Select either Alarm 1 or Alarm 2, choose **Turn on** to activate the Alarm.
- Follow the alarm wizard instructions to set the alarm.
- The wizard will guide you through the settings below:

Time	Set the time for the alarm
Sound	You can choose Wake to Tone, My Favourite, Wake to FM Radio or Wake to DAB Radio as the alarm source. Note : <i>Wake to FM or Wake to DAB Radio - only the preset stations can be used for the radio alarm (if the preset scan has been completed).</i> Wake to My Favourite: Please preset your favorite station before setting this as the alarm source. △ The Presets in Preset button 1-4 cannot be selected direct as the alarm source. If you want those 4 presets to become one of the alarm sounds, add these stations to the "My Favorite" list by press and hold the [FAV] button or the ♡ button on remote.
Repeat	You can schedule the alarm as you desire -Everyday, Once or multiple days.
Alarm Volume	Adjust the volume of the alarm as you like by rotating the [TUNE/SELECT] knob or [▲/▼] button on remote.
Alarm duration	Set the duration of the alarm from the preset options ranging from 30 to 180 minutes. The radio will be turned to standby when the selected duration of time is due.

- After the above settings are completed, press the [◀] button to exit and make sure the Alarm is turned on. You will see the Alarm icon appeared on the display if it is activated.

17. SLEEP TIMER SETTING

You can set the timer to let the radio goes standby after the selected time elapsed in the range of 15 minutes to 180 minutes.

Press [] button on the remote control to set the timer, or navigate to Sleep Timer option on the main menu.

You will see the icon appeared on the display if the timer is set.

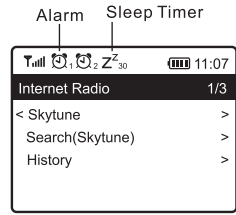

18. CONFIGURATION

Here you will find the complete settings / options available to configure your own radio. On the main menu, navigate to Configuration setting. Press OK and you will see a list of options available.

NETWORK

- **Wireless Network**

» Add wireless network

Scan & select - It will scan out a list of wireless networks around.

WPS button- Choose this option to connect your Wi-Fi router via WPS if the router has a WPS button.

» Remove wireless network

If you have already set up a network and want to remove it, choose this option.

Note - Always bring the Tuner within 2 meters of the Wi-Fi router for setup.

- **AP: []**

If you have added more than one routers on the radio and want to switch to another one, select this option to change.

- **Signal**

This is to show the strength of the Wi-Fi Signal of the Wi-Fi router as received by the radio. Usually signal levels lower than -70dBm is at weaker level and if it affects the reception of your radio, you may need to optimize the router location or check any problem of the router itself.

- **IP**

The IP is set **Dynamic** by default. Select to change **Fixed** IP according to your network condition.





- **DNS**

The DNS is set Dynamic by default. Select to change **<Fixed>** DNS according to your network condition.

LAN Network

Connect the radio's Ethernet port to one of the LAN ports in a router or Wi-Fi router using CAT 5 or CAT 6 cable. If your Router or Wi-Fi router is DHCP-enabled (recommended), you don't have anything to setup and the radio will connect to Internet with the parameters automatically assigned by the Router/Wi-Fi router.

Use the remote control for configuration if you want to use a fixed IP, scroll to IP:[Dynamic] and press **OK**.

Choose Fixed. Press the  button, you can then enter the IP, press ,  to tune to the required numbers: xxx.xxx.xxx.xxx. Switch among the 4 groups by pressing  . When done, press OK. Scroll to GW and NM to do the same.

You can also choose to use a DNS server other than the one from the DHCP server. Scroll to DNS and do the same.

Note : Use DHCP to get the network parameters unless you are familiar with network setup.

Network Options

Always on: The WLAN function remains switched on (faster access when switching from DAB or FM mode to Internet radio).

Auto off in 30s: The WLAN function shuts down after 30 seconds when not in use (to save energy).

Wi-Fi Channels

Not all of the Wi-Fi channels are available in every country. There may be variation between different countries. Therefore it is necessary to choose the Wi-Fi channels to ensure the Wi-Fi performs satisfactory.

We have already set the channels according to the requirement in different countries. Choose the country you are staying from the list to get the correct channel.

Network connection test

In case there are any issues in connecting Skytune, select this option to check out any failed items of the network parameters for further diagnosis.

DATE AND TIME

The radio will set your local time automatically after the internet connection is completed. If you want to do manual setting, change it by the following options:

- **Time zone**

Auto-set Time Zone: This option is set by default.

Manual-set Time Zone: Choose this option if you want to set the time in another region. Choose and highlight the region/city you prefer and press OK to confirm.

Coupled with NTP (use network time) and DST (Daylight time saving) will be adjusted automatically if you choose to use network time (NTP).

- **Set Time Format**

Choose either 12-hour or 24-hour notation you prefer.

- **Set clock style**

You can choose the clock display in digital form or Analog style. The selected style will apply in Standby as well as the big clock display in radio playback.

- **Set Date Format**

- **DST (Day Light Saving)**

Enable on/off

- **NTP (Use network time)**

NTP is designed to synchronize a device's clock with a time server. Your radio will synchronize the time server by default every time it powers up and connects to Internet. This ensures a very high degree of accuracy in the radio's clock. You can change to use other time server by inputting the URL address (see below NTP server). You can choose "Do not use network time" if you don't want it to.

If you choose not to use NTP for clock synchronization, highlight the NTP (Network time protocol) and press **OK** to make the change. You will see the Set Date & Time appeared on the menu. Select it and adjust the date and time as you desire.

- **NTP Server**

NTP is designed to synchronize a device's clock with a time server. Here it shows the server being used for the radio.

LANGUAGE

The default language is English, you can choose other languages as preferred. Scroll with the ▲▼ buttons on remote or [Tune/Select] knob to the item with  and press **OK**. Scroll to highlight and press **OK** to select your language of choice. English, French, Spanish, Italian, German, Dutch, Polish, Russian and more are available.

DAB SETUP

- **DAB full Scan**

You can always carry out a new scanning of DAB channels by selecting this option. All current presets and channels will be erased.

- **DAB station status**

This is to show the number of stations and signal received of each DAB frequency.

- **DAB station list**

The scanned DAB stations will be listed here for management. You can move the position or even delete any station. Scroll to the station and press [▶] button. A pop up window will be presented: Move up, Move down and Delete.

FM SETUP

- **Scan setting**

Either "All stations" or "strong stations" (with stronger signal) can be selected for the scan.

- **Audio setting**

If the signal is weak and stable stereo reception is not possible, select "Forced Mono" to get better reception.

- **FM full scan**

You can always carry out a new scanning of FM channels by selecting this option. All current presets and channels will be erased. The radio at the lowest frequency of the scanned values will be highlighted. The preset list will be saved unless a new preset scan is carried out.

- **FM station list**

You can adjust the preset ranking by Move down, Move up or Delete it. Highlight one of the preset and press the [▶] button (or [▶] on the unit), it will enter into the Edit menu. Always press the [◀] button (or [◀•Back] on the unit) to return to the Preset list.

- **Local Radio**

The radio is set by default to detect the radio stations in your local area automatically through internet connection and these stations can be accessed in the "Local Radio" under Skytune menu. You can also set Local in another region if you want. Highlight the Local Radio and press OK.

Choose Manual-set Local radio to change the region setting.

PLAYBACK SETUP

This is to set the mode of playback under UPnP/DLNA compatible streaming: Repeat All, Repeat Once or Shuffle.

POWER-ON OPTIONS

This is to select the state of the radio after a power reset / power cut, or the next power up from Standby. There are 3 options available:

- Go to Standby
- Resume once ready: the radio will resume playing the last listened station.
- Ready to use: the radio will stay in Home screen without action.

RESUME PLAY OPTIONS

This is to set the device whether to return to the last operating mode when it is switched on or displays the Home screen.

DIMMER

You can set the backlight level for the display as you prefer. There are two settings: Mode and Level

- **Mode – Normal or Power Saving**

Normal – the display will stay with the same level of brightness all the time without dim down.

Dim – the display will dim down after 20 seconds if no operation is made on the radio.

- **Level – Bright and Dim**

Bright – This is to adjust the level of brightness in Normal mode. Dim – This is to adjust the level of brightness in Dim mode.

- **Dimmer in Standby**

The highest backlight level in standby is set by system default. To further reduce the backlight or turn it completely off, adjust it by turning [TUNE/SELECT] knob anti-clockwise on the tuner or press the ▼ button on remote. Increasing the backlight beyond the system level will illuminate for 20 seconds and then dim to default setting automatically.

EQ (EQUALISER)

Various music genres can be set.

BUFFER TIME

Sometimes you may experience uneven playback of the internet radio. This can happen if the internet connection is slow or network congestion occurs. To help improving the situation, you can choose longer buffer time to get a few seconds of radio stream before beginning to play.

The default value is 2 seconds. You can choose 5 seconds if you prefer to have a longer buffering time.

LINE/DIGITAL OUT

The volume control on the Tuner can only adjust the volume from the headphone. If you would like to control the volume over the external speakers as well, choose this option and select "Follow headphone". The volume adjustment will apply on both the headphone and the external speakers the same time.

NETWORK INFORMATION

View the network signal and other parameters. To access quickly to this information, press the [🌐] button on the remote control. View the Network and System Information of your radio. To access quickly to this information, press the [INFO] button on the remote control.

When you use your PC to manage the My favorite stations, you have to use the IP address and you can view this info from here. Then type in the IP address (Configuration > Info > Network > IP) to your PC's browser input window.

SYSTEM INFORMATION

The model number, system MID and software version (App version) can be found here.

SOFTWARE UPDATE

There may be a software update to upgrade features of the radio from time to time.

RESET TO DEFAULT

You can do the reset to clear all the settings and return to default settings. ** Please note all the Station presets, Settings and configuration will be erased after you have performed the Reset.

19. WEB BROWSER CONTROL VIA PC / SMART PHONE - TUNING INTERNET RADIO & MANAGE FAVOURITE

Experience an easy way to control tuning internet radio channels and manage your favourite list via PC or Smart phone's web browser.

The supported browsers are Internet Explorer and Chrome.

- Connect your PC or Smart phone to the same Wi-Fi network as your radio.
- Visit www.skytune.net
- On the home page, click "Browse/Search"
- Browse or enter the name to search the radio channel, a list of internet radio channels will be displayed.
- Click the "♥" symbol



- It will prompt you whether to "Add Favourite" or "Listen to Station". Enter the IP address of your radio (e.g. 192.168.1.11):

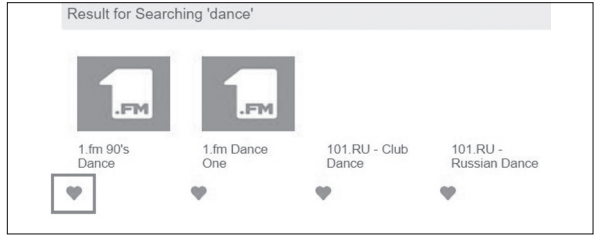

The IP address can be located on the radio unit as follow:

- On the remote control, press the (⊕) button, choose Network and scroll to IP to view the IP address
- On the radio, return to the main menu. Navigate to **Configuration > Information > Network Information > IP**

Select "Listen to Station", click "Send" and the radio unit will switch playing the channel and the "My Favourite" page will pop up on the web browser.

You can then choose to add the playing station to favourite or manage your list by other edit options. Any changes will synchronize to the radio unit immediately.

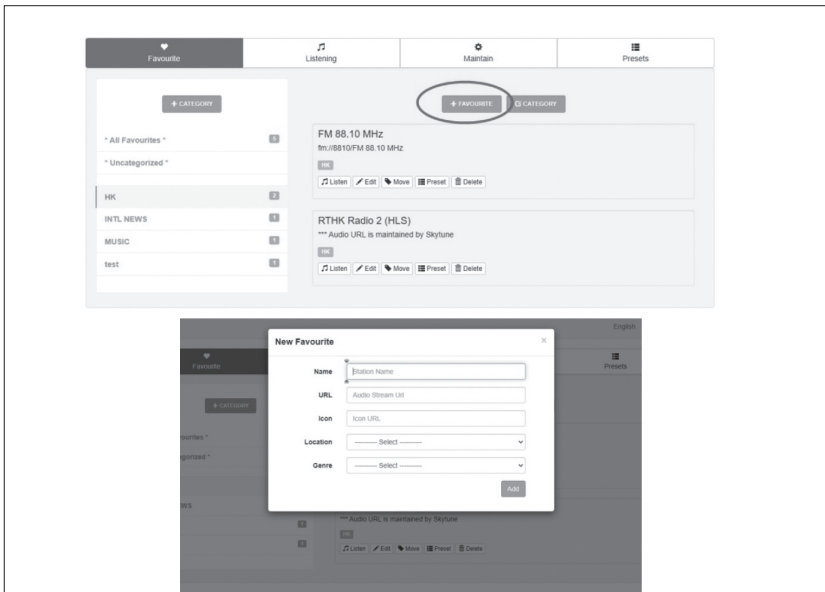
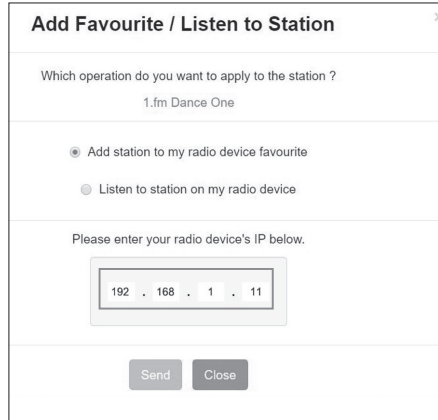

You can also add the radio channel if you know the published audio stream URL with the streaming format as follow:

1. Audio formats: MP3, AAC, AAC+
2. Stream formats: Shoutcast, Icecast (HTTP, HTTPS) and HLS
3. Playlist formats: PLS, M3U
4. Sampling frequency: 44.1 KHz and 48 KHz

20. TROUBLE SHOOTING

Problem	Cause	Solutions
Cannot connect to Wi-Fi network	Network down	<ul style="list-style-type: none"> • Confirm that a Wi-Fi or Ethernet Wired connected PC can access the internet (i.e. can browse the web) using the same network. • Check that a DHCP server is available, or that you have configured a static IP address on the radio. • Check that you firewall is not blocking any outgoing ports. As a minimum the radio needs access to UDP and TCP ports 80,443 and 8008, DNS port 53.
	Router restricts access to listed MAC addresses	Obtain the MAC address from Configuration > Information > Network > Wi-Fi MAC and add to the allowed equipment list on your access point. Note: The radio has separate MAC addresses for wired and wireless networks.
	Insufficient Wi-Fi signal strengt	<ul style="list-style-type: none"> • Check distance to router; see if a computer can connect to the network in this location • Optimize the distance of the router's location
	Unknown encryption method	Change encryption method on router. The radio supports WEP, WPA, WPA2
	Firewall preventing access	Windows Media Player: varies — non-Microsoft firewalls may require configuration for UPnP.
If your radio can connect to the network successfully, but is unable to play particular stations		<ul style="list-style-type: none"> • The station is not broadcasting at this time of the day (remember it may be located in a different time zone). • The station has too many people trying to attach to the radio station server and the server capacity is not large enough. • The station has reached the maximum allowed number of simultaneous listeners. • The link on the radio is out of date. The update of the link is done regularly. To get the updated list of stations, please access from Internet radio > Skytune. In case a particular stream is still not working, please contact us or report the case to Skytune.
No DAB/FM reception		<ul style="list-style-type: none"> • Please carry out "Factory Reset" on the radio and extend the antenna. • Move the radio close to the window.

DAB/FM radio reception is poor		<ul style="list-style-type: none"> • Please check that the aerial is extended for the maximum signal strength and adjust the direction to improve reception. • Check that you do not have other electrical equipment too close to your radio, causing interference.
No sound		<ul style="list-style-type: none"> • Please check if the volume is muted. Tune up the volume and see. • If that happens on a particular internet radio station, please try other channels and see if this is isolated issue on that station.

21. HELPFUL TIPS

1 If the Internet Radio keeps re-buffering radio station:

The Internet Radio is streaming the data from the radio station via your broadband connection, if there is a high error rate on your broadband connection, or the connection is intermittent, then it will cause the Internet Radio to pause until the connection is re-established and it has received enough data to start playing again. If your Internet Radio keeps stopping, please check the DSL modem to ensure that the Broadband line is not suffering a high error rate or disconnections. If you are experiencing these problems, you will need to contact your broadband supplier.

2. What is Buffering?

When playing a stream, the Internet Radio/Media player, downloads a small amount of the stream before it starts playing. This is used to fill in any gaps in the stream that may occur if the internet or the wireless network is busy.

The Internet Radio streams music data from the PC while you are listening. If a stream gets blocked or experiences Internet congestion while transferring it may stop/interfere with the quality of play. If this happens, check your internet connection speed- it must be faster than the speed of the streams.

3. My radio is working but some stations cannot be played.

The problem may be due to one or more of the followings:

- The radio station is no longer broadcasting.
- The radio station has reached the maximum allowed number of simultaneous listeners.
- The radio station has changed the stream arrangement and the link is no longer valid.
- The radio station is not broadcasting at the time of the day (not all stations are broadcasting 24 hours throughout the day).
- The Internet connection between your radio and the radio station server is too slow or unstable to support the data rate of the broadcast.

22. TECHNICAL SPECIFICATION

description	internet – DAB+ - FM - bluetooth radio
radio	internet radio (auto update) FM (RDS) / DAB+
memory	99 programmable radio stations
functions	search by genre, location or your favourites alarm / clock / sleep timer / internet clock sync (NTP) equalizer
antenna	telescopic
Bluetooth	V5.0 2.4 GHz
internet connection	WLAN -802.11b/g/n & 10 Mbps RJ45 uPnP & DLNA support
input	USB
output	stereo RCA, optical, coaxial, digital optical, headphone jack
display	2,4" color screen
control	remote control
power supply	5.0 V DC 1A (100 - 240 V)
dimensions (h x w x d)	48 x 430 x 243 mm
weight / piece	1,8kg
composition	metal / ABS plastic
colour	black

Remark: Specification may vary without notice

23. WARRANTY CONDITIONS

2 year warranty from date of purchase. The warranty is limited to the repair or replacement of the defective material insofar as this defect is a result of normal use and the device has not been damaged. Artsound is not responsible for any other costs that ensue as a result of the defect (e.g. transport). For details, please consult our general terms and conditions of sale.



This product bears the selective sorting symbol for waste electrical and electronic equipment (WEEE). This means that this product must be handled pursuant to European Directive 2002/96/EC in order to be recycled or dismantled to minimize its impact on the environment. For further information, please contact your local or regional authorities.



I, House Of Music NV, hereby declare that the type of radio equipment ARTSOUND complies with Directive 2014/53/EU. The full text of the EU Declaration of Conformity can be found at the following internet address: <http://www.artsound.be/en/support/downloads>

Disclaimer: All trademarks are the property of their respective owners. All specifications and information are subject to change without further notice. Slight variations and differences might appear between printed photos and actual product due to product enhancement.

House Of Music NV - Belgium

FCC Statement:

This device complies with part 15 of the FCC Rules. Operation is subject to the following two conditions:

- (1) This device may not cause harmful interference, and
- (2) this device

must accept any interference received, including interference that may cause undesired operation.

This equipment has been tested and found to comply with the limits for a Class B digital device, pursuant to part 15 of the FCC Rules. These limits are designed to provide reasonable protection against harmful interference in a residential installation. This equipment generates, uses and can radiate radio frequency energy and, if not installed and used in accordance with the instructions, may cause harmful interference to radio communications. However, there is no guarantee that interference will not occur in a particular installation. If this equipment does cause harmful interference to radio or television reception, which can be determined by turning the equipment off and on, the user is encouraged to try to correct the interference by one or more of the following measures:

- Reorient or relocate the receiving antenna.
- Increase the separation between the equipment and receiver.
- Connect the equipment into an outlet on a circuit different from that to which the receiver is connected.
- Consult the dealer or an experienced radio/TV technician for help.

Caution: Any changes or modifications not expressly approved by the party responsible for compliance could void the user's authority to operate the equipment.

This equipment complies with FCC radiation exposure limits set forth for an uncontrolled environment. This transmitter must not be co-located or operating in conjunction with any other antenna or transmitter.

To satisfy FCC RF exposure requirements, a separation distance of 20cm or more should be maintained between the antenna of this device and persons during device operation. To ensure compliance, operations at closer than this distance is not recommended.

artsound
we speak sound

House of Music nv

© www.artsound.be @ artsoundaudio f artsound.audio

artsound
we speak sound