

FCC PART 15 SUBPART C TEST REPORT

FCC PART 15.247

Report Reference No..... : MTEB23040071-R2

FCC ID..... : 2ABD3-MA336K

Compiled by

(position+printed name+signature)..: File administrators Alisa Luo



Supervised by

(position+printed name+signature)..: Test Engineer Sunny Deng



Approved by

(position+printed name+signature)..: Manager Yvette Zhou



Date of issue..... : **April 17,2023**

Representative Laboratory Name.: Shenzhen Most Technology Service Co., Ltd.

Address..... : No.5, 2nd Langshan Road, North District, Hi-tech Industrial Park,
Nanshan, Shenzhen, Guangdong, China.

Applicant's name..... : Ocean Digital Technology Ltd.

Address..... : Flat B, 12/F., Yeung Yiu Chung (No.8) Ind. Bldg., 20 Wang Hoi Road,
Kowloon Bay, Hong Kong

Test specification..... :

Standard..... : **FCC Part 15.247**

TRF Originator..... : Shenzhen Most Technology Service Co., Ltd.

Shenzhen Most Technology Service Co., Ltd. All rights reserved.

This publication may be reproduced in whole or in part for non-commercial purposes as long as the Shenzhen Most Technology Service Co., Ltd. is acknowledged as copyright owner and source of the material. Shenzhen Most Technology Service Co., Ltd. takes no responsibility for and will not assume liability for damages resulting from the reader's interpretation of the reproduced material due to its placement and context.

Test item description..... : Internet Radio

Trade Mark..... : N/A

Manufacturer..... : Ocean Digital Technology Ltd.

Model/Type reference..... : MA-336K

Listed Models : MA-336KP, WR-336K, WR-336KP, PR-100,SB-100

Modulation Type..... : CCK/DSSS/ OFDM

Operation Frequency..... : From 2412 - 2462MHz

Rating..... : DC 3.7V by Battery
DC 5V (by Adapter)

Hardware version..... : MA-336K_Main_PCB_Rev 1.1

Software version : N/A

Result..... : PASS

TEST REPORT

Equipment under Test : Internet Radio

Model /Type : MA-336K

Listed Models : MA-336KP, WR-336K, WR-336KP, PR-100,SB-100

Remark : Only the model name and appearance are different.

Applicant : Ocean Digital Technology Ltd.

Address : Flat B, 12/F., Yeung Yiu Chung (No.8) Ind. Bldg., 20 Wang Hoi Road, Kowloon Bay, Hong Kong

Manufacturer : Ocean Digital Technology Ltd.

Address : Flat B, 12/F., Yeung Yiu Chung (No.8) Ind. Bldg., 20 Wang Hoi Road, Kowloon Bay, Hong Kong

| | |
|---------------------|-------------|
| Test Result: | PASS |
|---------------------|-------------|

The test report merely corresponds to the test sample.

It is not permitted to copy extracts of these test result without the written permission of the test laboratory.

Contents

| | |
|---|-----------|
| 1 REVISION HISTORY | 4 |
| 2 TEST STANDARDS | 5 |
| 3 SUMMARY | 6 |
| 3.1 General Remarks | 6 |
| 3.2 Product Description | 6 |
| 3.3 Equipment Under Test | 6 |
| 3.4 Short description of the Equipment under Test (EUT) | 6 |
| 3.5 EUT operation mode | 7 |
| 3.6 Block Diagram of Test Setup | 7 |
| 3.7 Test Item (Equipment Under Test) Description* | 7 |
| 3.8 Auxiliary Equipment (AE) Description | 7 |
| 3.9 Antenna Information* | 7 |
| 3.10 Related Submittal(s) / Grant (s) | 8 |
| 3.11 Modifications | 8 |
| 4 TEST ENVIRONMENT | 9 |
| 4.1 Address of the test laboratory | 9 |
| 4.2 Test Facility | 9 |
| 4.3 Environmental conditions | 9 |
| 4.4 Test Description | 10 |
| 4.5 Statement of the measurement uncertainty | 10 |
| 4.6 Equipments Used during the Test | 11 |
| 5 TEST CONDITIONS AND RESULTS | 12 |
| 5.1 AC Power Conducted Emission | 12 |
| 5.2 Radiated Emission | 15 |
| 5.3 Maximum Conducted Output Power | 22 |
| 5.4 Power Spectral Density | 23 |
| 5.5 6dB Bandwidth | 24 |
| 5.6 Out-of-band Emissions | 25 |
| 5.7 Duty Cycle Information | 26 |
| 5.8 Antenna Requirement | 27 |
| 6 TEST SETUP PHOTOS OF THE EUT | 28 |
| 7 PHOTOS OF THE EUT | 29 |
| APPENDIX I. Conducted Peak Output Power | 30 |
| APPENDIX II. 99% Bandwidth | 31 |
| APPENDIX III. 6dB Bandwidth | 34 |
| APPENDIX IV. Conducted Out Of Band Emission | 37 |
| APPENDIX V. Duty Cycle | 43 |
| APPENDIX VI. Power Spectral Density | 50 |

1 Revision History

| Revision | Issue Date | Revisions | Revised By |
|----------|------------|---------------|------------|
| 00 | 2023-04-26 | Initial Issue | Alisa Luo |
| | | | |
| | | | |

2 TEST STANDARDS

The tests were performed according to following standards:

[FCC Rules Part 15.247](#): Frequency Hopping, Direct Spread Spectrum and Hybrid Systems that are in operation within the bands of 902-928 MHz, 2400-2483.5 MHz, and 5725-5850 MHz.

[ANSI C63.10-2013](#): American National Standard for Testing Unlicensed Wireless Devices

[KDB558074 D01 v05r02](#): Guidance for Compliance Measurements on Digital Transmission Systems (DTS) ,Frequency Hopping Spread Spectrum System(HFSS), and Hybrid System Devices Operating Under §15.247 of The FCC rules.

3 SUMMARY

3.1 General Remarks

| | | |
|--------------------------------|---|------------|
| Date of receipt of test sample | : | 2023.04.15 |
| Testing commenced on | : | 2023.04.16 |
| Testing concluded on | : | 2023.04.26 |

3.2 Product Description

| | |
|-----------------------|--|
| Product Name: | Internet Radio |
| Model/Type reference: | MA-336K |
| Power Supply: | DC3.7V(by Battery) DC 5V (by Adapter) |
| Testing sample ID: | MTYP02448 |
| WIFI : | |
| Supported type: | 802.11b/802.11g/802.11n(H20)/ 802.11n(HT40) |
| Modulation: | 802.11b: DSSS 802.11g/802.11n(H20)/ 802.11n(HT40): OFDM |
| Operation frequency: | 802.11b/802.11g/802.11n(H20)/ 802.11n(HT40): 2412MHz~2462MHz 802.11n(HT40): 2422MHz~2452MHz |
| Channel number: | 802.11b/802.11g/802.11n(H20):11 802.11n(HT40): 7 |
| Channel separation: | 5MHz |
| Antenna type: | PCB Antenna |
| Antenna gain: | 0dBi |

3.3 Equipment Under Test

Power supply system utilised

| | | | |
|----------------------|---|---|-----------------------------------|
| Power supply voltage | : | <input type="radio"/> 230V / 50 Hz | <input type="radio"/> 120V / 60Hz |
| | | <input type="radio"/> 12 V DC | <input type="radio"/> 24 V DC |
| | | <input checked="" type="radio"/> Other (specified in blank below) | |

DC 3.7V by Battery

DC 5V (by Adapter)

3.4 Short description of the Equipment under Test (EUT)

This is a Internet Radio For more details, refer to the user's manual of the EUT.

3.5 EUT operation mode

The application provider specific test software(AT command) to control sample in continuous TX and RX for testing meet KDB558074 test requirement

IEEE 802.11b/g/n: Thirteen channels are provided to the EUT.

| Channel | Frequency(MHz) | Channel | Frequency(MHz) |
|---------|----------------|---------|----------------|
| 1 | 2412 | 8 | 2447 |
| 2 | 2417 | 9 | 2452 |
| 3 | 2422 | 10 | 2457 |
| 4 | 2427 | 11 | 2462 |
| 5 | 2432 | | |
| 6 | 2437 | | |
| 7 | 2442 | | |

3.6 Block Diagram of Test Setup

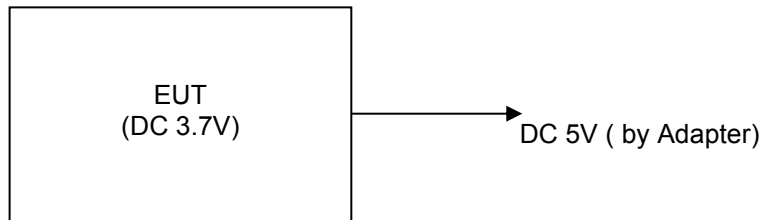

3.7 Test Item (Equipment Under Test) Description*

| Short designation | EUT Name | EUT Description | Serial number | Hardware status | Software status |
|-------------------|----------|-------------------|---------------|-----------------|-----------------|
| EUT A | ADAPTER | AS061A-0501000USU | / | / | / |
| EUT B | / | / | / | / | / |

*: declared by the applicant. According to customers information EUTs A and B are the same devices.

3.8 Auxiliary Equipment (AE) Description

| AE short designation | EUT Name (if available) | EUT Description | Serial number (if available) | Software (if used) |
|----------------------|-------------------------|-----------------|------------------------------|--------------------|
| AE 1 | / | / | / | / |
| AE 2 | / | / | / | / |

3.9 Antenna Information*

| Short designation | Antenna Name | Antenna Type | Frequency Range | Serial number | Antenna Peak Gain |
|-------------------|--------------|--------------|-----------------|---------------|-------------------|
| Antenna 1 | --- | PCB antenna | 2.4 – 2.5 GHz | --- | 0dbi |
| Antenna 2 | | | | | |

*: declared by the applicant.

3.10 Related Submittal(s) / Grant (s)

This submittal(s) (test report) is intended for **FCC ID: 2ABD3-MA336K** filing to comply with Section 15.247 of the FCC Part 15, Subpart C Rules.

3.11 Modifications

No modifications were implemented to meet testing criteria.

4 TEST ENVIRONMENT

4.1 Address of the test laboratory

Shenzhen Most Technology Service Co., Ltd.

No.5, 2nd Langshan Road, North District, Hi-tech Industrial Park, Nanshan, Shenzhen, Guangdong, China.
The 3m-Semi anechoic test site fulfils CISPR 16-1-4 according to ANSI C63.4:2014 and CISPR 16-1-4:2010 SVSWR requirement for radiated emission above 1GHz.

4.2 Test Facility

The test facility is recognized, certified, or accredited by the following organizations:

FCC-Registration No.: 0031192610

Shenzhen Most Technology Service Co., Ltd. EMC Laboratory has been registered and fully described in a report filed with the (FCC) Federal Communications Commission. The acceptance letter from the FCC is maintained in our files.

A2LA-Lab Cert. No.: 6343.01

Shenzhen Most Technology Service Co., Ltd. EMC Laboratory has been accredited by A2LA for technical competence in the field of electrical testing, and proved to be in compliance with ISO/IEC 17025: 2005 General Requirements for the Competence of Testing and Calibration Laboratories and any additional program requirements in the identified field of testing.

4.3 Environmental conditions

Radiated Emission:

| | |
|-----------------------|--------------|
| Temperature: | 24 ° C |
| Humidity: | 48 % |
| Atmospheric pressure: | 950-1050mbar |

AC Main Conducted testing:

| | |
|-----------------------|--------------|
| Temperature: | 24 ° C |
| Humidity: | 45 % |
| Atmospheric pressure: | 950-1050mbar |

Conducted testing:

| | |
|-----------------------|--------------|
| Temperature: | 24 ° C |
| Humidity: | 45 % |
| Atmospheric pressure: | 950-1050mbar |

4.4 Test Description

| | | |
|---------------------------------|--------------------------------|------|
| FCC PART 15.247 | | |
| FCC Part 15.207 | AC Power Conducted Emission | PASS |
| FCC Part 15.247(a)(2) | 6dB Bandwidth | PASS |
| FCC Part 15.247(d) | Spurious RF Conducted Emission | PASS |
| FCC Part 15.247(b) | Maximum Conducted Output Power | PASS |
| FCC Part 15.247(e) | Power Spectral Density | PASS |
| FCC Part 15.109/ 15.205/ 15.209 | Radiated Emissions | PASS |
| FCC Part 15.247(d) | Band Edge | PASS |
| FCC Part 15.203/15.247 (b) | Antenna Requirement | PASS |

Data Rate Used:

Preliminary tests were performed in different data rate to find the worst radiated emission. The data rate shown in the table below is the worst-case rate with respect to the specific test item. Investigation has been done on all the possible configurations for searching the worst cases. The following table is a list of the test modes shown in this test report.

| Test Items | Mode | Data Rate | Channel |
|--|-----------------|-----------|---------|
| Maximum Peak Conducted Output Power Power Spectral Density 6dB Bandwidth Spurious RF conducted emission Radiated Emission 9KHz~1GHz& Radiated Emission 1GHz~10 th Harmonic | 11b/DSSS | 1 Mbps | 1/6/11 |
| | 11g/OFDM | 6 Mbps | 1/6/11 |
| | 11n(20MHz)/OFDM | 6.5Mbps | 1/6/11 |
| | / | / | / |
| Band Edge | 11b/DSSS | 1 Mbps | 1/11 |
| | 11g/OFDM | 6 Mbps | 1/11 |
| | 11n(20MHz)/OFDM | 6.5Mbps | 1/11 |
| | 11n(40MHz)/OFDM | 6.5Mbps | 1/11 |

4.5 Statement of the measurement uncertainty

The data and results referenced in this document are true and accurate. The reader is cautioned that there may be errors within the calibration limits of the equipment and facilities. The measurement uncertainty was calculated for all measurements listed in this test report acc. to CISPR 16 - 4 „Specification for radio disturbance and immunity measuring apparatus and methods – Part 4: Uncertainty in EMC Measurements“ and is documented in the Shenzhen Most Technology Service Co., Ltd. quality system acc. to DIN EN ISO/IEC 17025. Furthermore, component and process variability of devices similar to that tested may result in additional deviation. The manufacturer has the sole responsibility of continued compliance of the device.

Hereafter the best measurement capability for Shenzhen Most Technology Service Co., Ltd. is reported:

| Test | Range | Measurement Uncertainty | Notes |
|-----------------------|------------|-------------------------|-------|
| Radiated Emission | 30~1000MHz | 4.10 dB | (1) |
| Radiated Emission | 1~18GHz | 4.32 dB | (1) |
| Radiated Emission | 18-40GHz | 5.54 dB | (1) |
| Conducted Disturbance | 0.15~30MHz | 3.12 dB | (1) |

(1) This uncertainty represents an expanded uncertainty expressed at approximately the 95% confidence level using a coverage factor of k=2.

4.6 Equipments Used during the Test

| Item | Equipment | Manufacturer | Model No. | Serial No. | Firmware versions | Last Cal. | Cal. Interval |
|------|--------------------------------------|------------------|-----------------|------------|-------------------|------------|---------------|
| 1. | L.I.S.N. | R&S | ENV216 | 100093 | / | 2023/03/17 | 1 Year |
| 2 | Three-phase artificial power network | Schwarzback Mess | NNLK8129 | 8129178 | / | 2023/03/17 | 1 Year |
| 3. | Receiver | R&S | ESCI | 100492 | V3.0-10-2 | 2023/03/17 | 1 Year |
| 4 | Receiver | R&S | ESPI | 101202 | V3.0-10-2 | 2023/03/17 | 1 Year |
| 5 | Spectrum analyzer | Agilent | 9020A | MT-E306 | A14.16 | 2023/03/17 | 1 Year |
| 6 | Bilong Antenna | Sunol Sciences | JB3 | A121206 | / | 2023/03/17 | 1 Year |
| 7 | Horn antenna | HF Antenna | HF Antenna | MT-E158 | / | 2023/03/17 | 1 Year |
| 8 | Loop antenna | Beijing Daze | ZN30900B | / | / | 2023/03/17 | 1 Year |
| 9 | Horn antenna | R&S | OBH100400 | 26999002 | / | 2023/03/17 | 1 Year |
| 10 | Wireless Communication Test Set | R&S | CMW500 | / | CMW-BASE-3.7.21 | 2023/03/17 | 1 Year |
| 11 | Spectrum analyzer | R&S | FSP | 100019 | V4.40 SP2 | 2023/03/17 | 1 Year |
| 12 | High gain antenna | Schwarzbeck | LB-180400KF | MT-E389 | / | 2023/03/17 | 1 Year |
| 13 | Preamplifier | Schwarzbeck | BBV 9743 | MT-E390 | / | 2023/03/17 | 1 Year |
| 14 | Pre-amplifier | EMCI | EMC051845S E | MT-E391 | / | 2023/03/17 | 1 Year |
| 15 | Pre-amplifier | Agilent | 83051A | MT-E392 | / | 2023/03/17 | 1 Year |
| 16 | High pass filter unit | Tonscend | JS0806-F | MT-E393 | / | 2023/03/17 | 1 Year |
| 17 | RF Cable(below1GHz) | Times | 9kHz-1GHz | MT-E394 | / | 2023/03/17 | 1 Year |
| 18 | RF Cable(above 1GHz) | Times | 1-40G | MT-E395 | / | 2023/03/17 | 1 Year |
| 19 | RF Cable (9KHz-40GHz) | Tonscend | 170660 | N/A | / | 2023/03/17 | 1 Year |

Note: The Cal.Interval was one year.

5 TEST CONDITIONS AND RESULTS

5.1 AC Power Conducted Emission

TEST CONFIGURATION

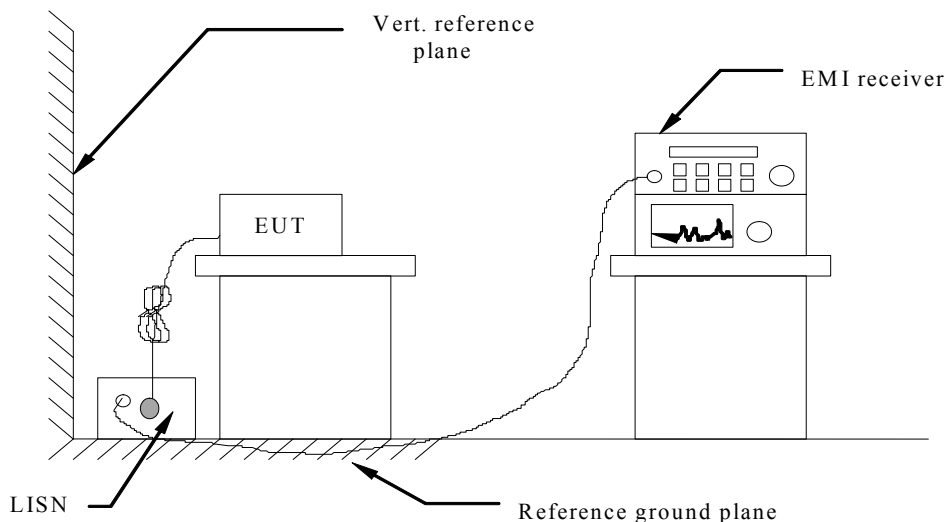

TEST PROCEDURE

- 1 The equipment was set up as per the test configuration to simulate typical actual usage per the user's manual. The EUT is a tabletop system, a wooden table with a height of 0.8 meters is used and is placed on the ground plane as per ANSI C63.10-2013.
- 2 Support equipment, if needed, was placed as per ANSI C63.10-2013
- 3 All I/O cables were positioned to simulate typical actual usage as per ANSI C63.10-2013
- 4 The EUT received DC 12V power from adapter, the adapter received AC120V/60Hz and AC 240V/60Hz power through a Line Impedance Stabilization Network (LISN) which supplied power source and was grounded to the ground plane.
- 5 All support equipments received AC power from a second LISN, if any.
- 6 The EUT test program was started. Emissions were measured on each current carrying line of the EUT using a spectrum Analyzer / Receiver connected to the LISN powering the EUT. The LISN has two monitoring points: Line 1 (Hot Side) and Line 2 (Neutral Side). Two scans were taken: one with Line 1 connected to Analyzer / Receiver and Line 2 connected to a 50 ohm load; the second scan had Line 1 connected to a 50 ohm load and Line 2 connected to the Analyzer / Receiver.
- 7 Analyzer / Receiver scanned from 150 KHz to 30MHz for emissions in each of the test modes.
- 8 During the above scans, the emissions were maximized by cable manipulation.

AC Power Conducted Emission Limit

For intentional device, according to § 15.207(a) AC Power Conducted Emission Limits is as following :

| Frequency range (MHz) | Limit (dBuV) | |
|-----------------------|--------------|-----------|
| | Quasi-peak | Average |
| 0.15-0.5 | 66 to 56* | 56 to 46* |
| 0.5-5 | 56 | 46 |
| 5-30 | 60 | 50 |

* Decreases with the logarithm of the frequency.

TEST RESULTS

Remark:

1. WIFI modes were test at 802.11b/802.11g/802.11n (H20) /802.11n (H40) (Low, Middle, and High channel); only the worst result of 802.11b Middle Channel was reported as below:

Power supply:

DC 5V (by Adapter)

Polarization

L

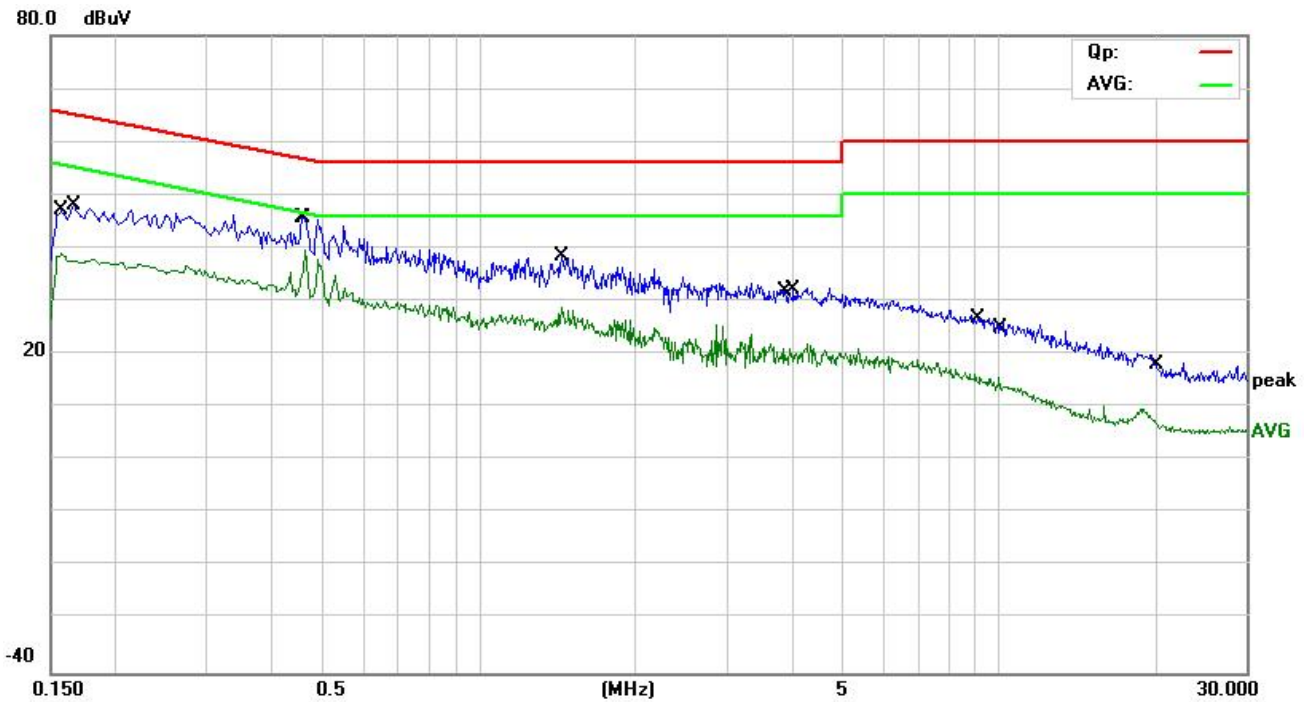

| No. | Mk. | Freq. MHz | Reading Level dBuV | Correct Factor dB | Measure- ment dBuV | Limit dBuV | Over dB | Detector | Comment |
|-----|-----|--------------|--------------------------|-------------------------|--------------------------|---------------|------------|----------|---------|
| 1 | | 0.1580 | 29.31 | 9.60 | 38.91 | 55.57 | -16.66 | AVG | |
| 2 | | 0.1660 | 38.51 | 9.61 | 48.12 | 65.16 | -17.04 | QP | |
| 3 | | 0.4580 | 35.98 | 9.59 | 45.57 | 56.73 | -11.16 | QP | |
| 4 | * | 0.4620 | 29.94 | 9.59 | 39.53 | 46.66 | -7.13 | AVG | |
| 5 | | 1.4460 | 28.96 | 9.60 | 38.56 | 56.00 | -17.44 | QP | |
| 6 | | 1.4460 | 19.21 | 9.60 | 28.81 | 46.00 | -17.19 | AVG | |
| 7 | | 3.8700 | 11.37 | 9.62 | 20.99 | 46.00 | -25.01 | AVG | |
| 8 | | 4.0380 | 22.55 | 9.62 | 32.17 | 56.00 | -23.83 | QP | |
| 9 | | 9.1500 | 17.18 | 9.68 | 26.86 | 60.00 | -33.14 | QP | |
| 10 | | 10.0300 | 5.94 | 9.69 | 15.63 | 50.00 | -34.37 | AVG | |
| 11 | | 20.0220 | -2.31 | 9.73 | 7.42 | 50.00 | -42.58 | AVG | |
| 12 | | 20.1620 | 8.47 | 9.73 | 18.20 | 60.00 | -41.80 | QP | |

*:Maximum data x:Over limit !:over margin

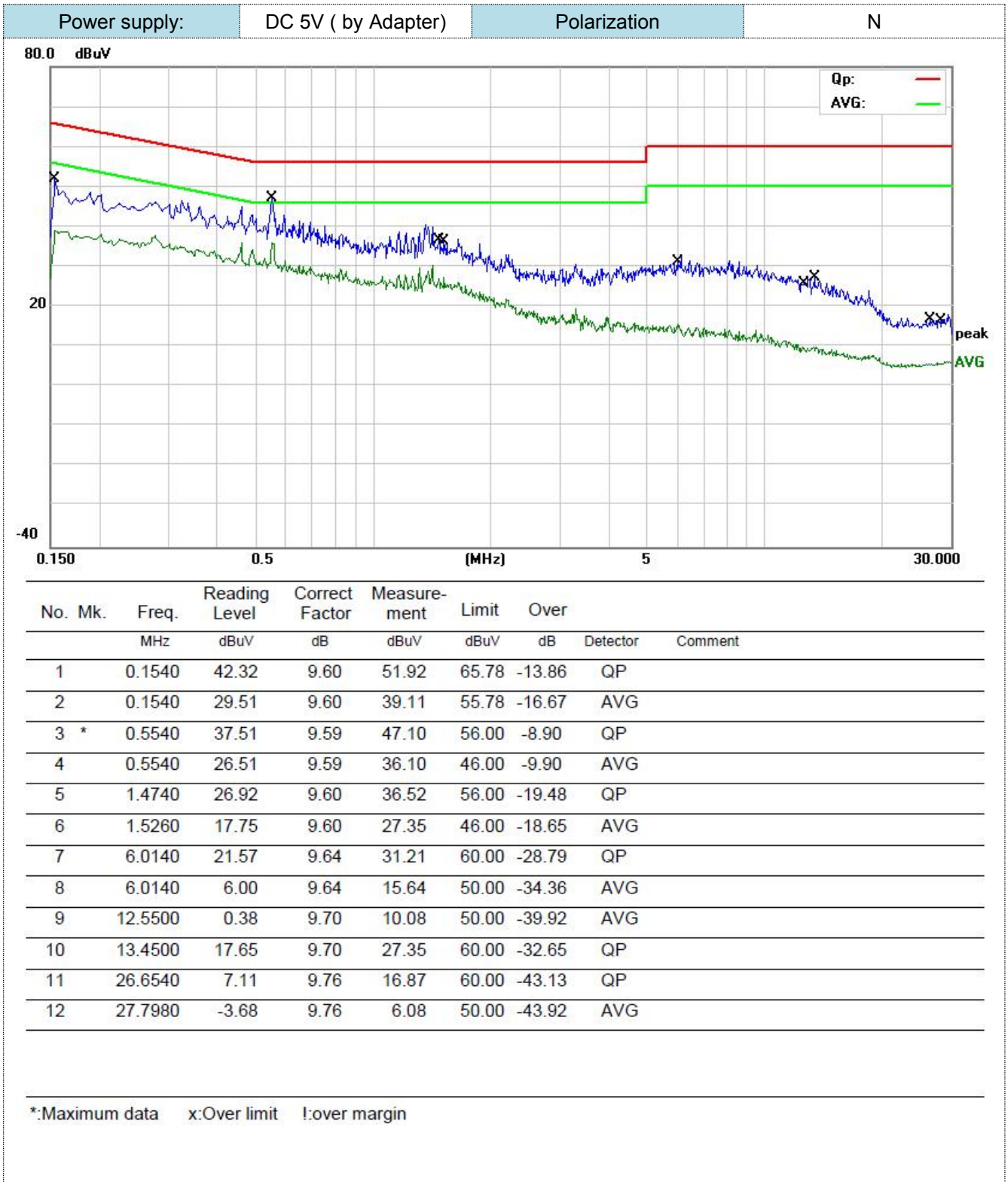

5.2 Radiated Emission

TEST CONFIGURATION

Frequency range 9 KHz – 30MHz

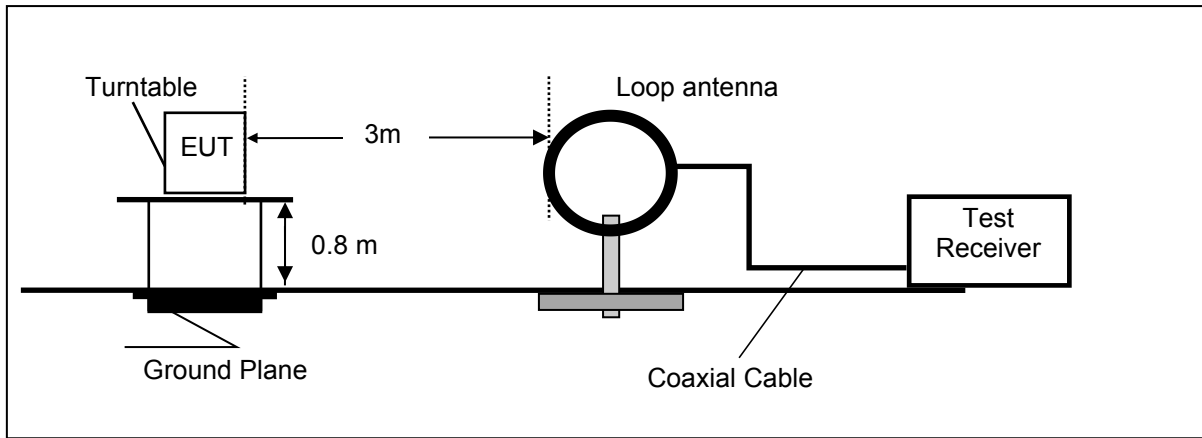

Frequency range 30MHz – 1000MHz

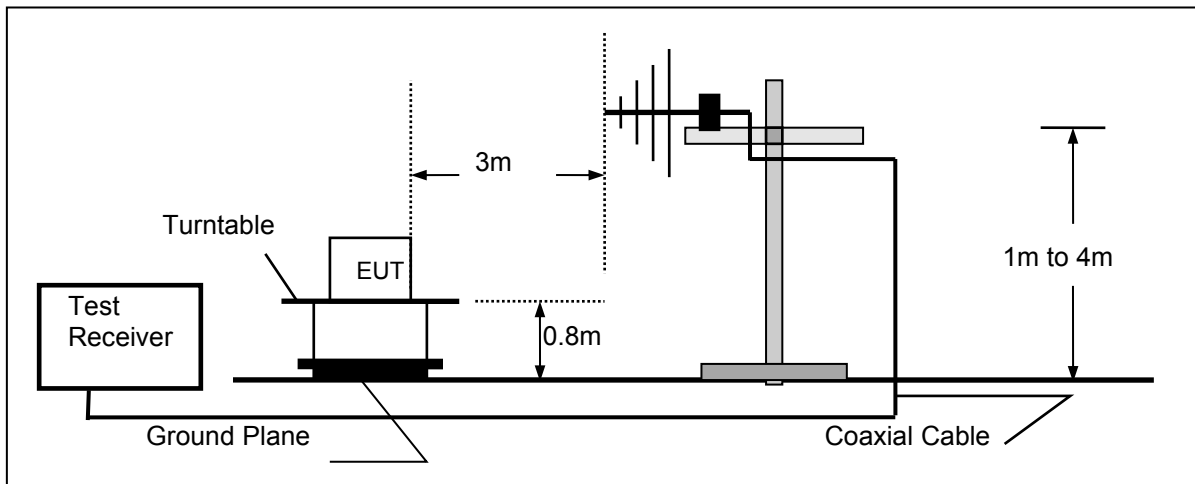

Frequency range above 1GHz-25GHz

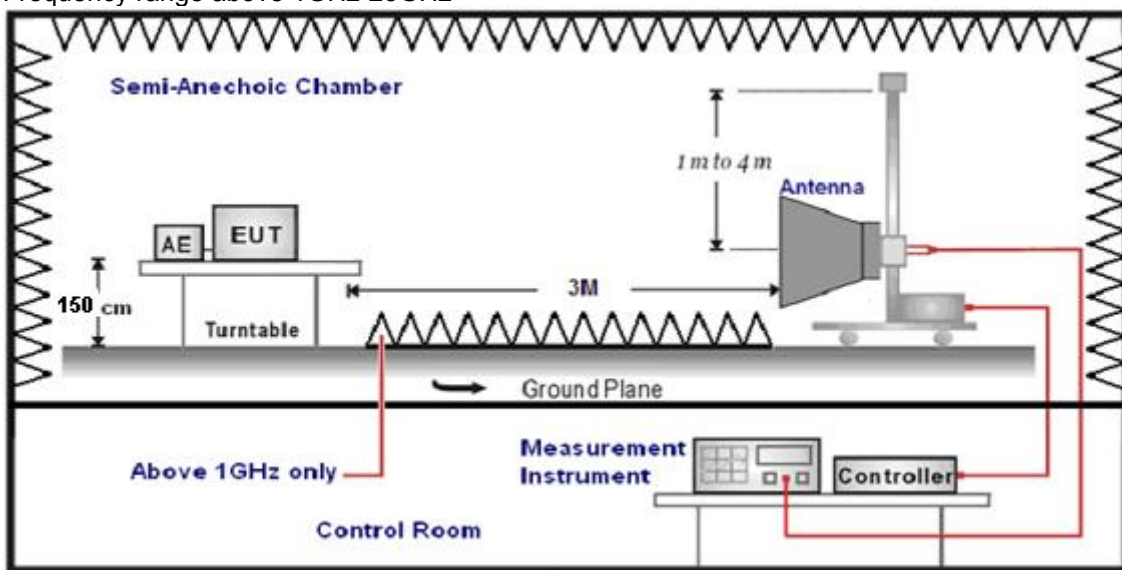

TEST PROCEDURE

1. The EUT was placed on a turn table which is 0.8m above ground plane when testing frequency range 9 KHz –1GHz;the EUT was placed on a turn table which is 1.5m above ground plane when testing frequency range 1GHz – 25GHz.
2. Maximum procedure was performed by raising the receiving antenna from 1m to 4m and rotating the turn table from 0° to 360° to acquire the highest emissions from EUT.
3. And also, each emission was to be maximized by changing the polarization of receiving antenna both horizontal and vertical.
4. Repeat above procedures until all frequency measurements have been completed.
5. Radiated emission test frequency band from 9KHz to 25GHz.
6. The distance between test antenna and EUT as following table states:

| Test Frequency range | Test Antenna Type | Test Distance |
|----------------------|----------------------------|---------------|
| 9KHz-30MHz | Active Loop Antenna | 3 |
| 30MHz-1GHz | Ultra-Broadband Antenna | 3 |
| 1GHz-18GHz | Double Ridged Horn Antenna | 3 |
| 18GHz-25GHz | Horn Antenna | 1 |

7. Setting test receiver/spectrum as following table states:

| Test Frequency range | Test Receiver/Spectrum Setting | Detector |
|----------------------|---|----------|
| 9KHz-150KHz | RBW=200Hz/VBW=3KHz,Sweep time=Auto | QP |
| 150KHz-30MHz | RBW=9KHz/VBW=100KHz,Sweep time=Auto | QP |
| 30MHz-1GHz | RBW=120KHz/VBW=1000KHz,Sweep time=Auto | QP |
| 1GHz-40GHz | Peak Value: RBW=1MHz/VBW=3MHz, Sweep time=Auto Average Value: RBW=1MHz/VBW=10Hz, Sweep time=Auto | Peak |

Field Strength Calculation

The field strength is calculated by adding the Antenna Factor and Cable Factor and subtracting the Amplifier Gain and Duty Cycle Correction Factor(if any) from the measured reading. The basic equation with a sample calculation is as follows:

FS = RA + AF + CL - AG

| | | |
|-------|------------------------|--|
| Where | FS = Field Strength | CL = Cable Attenuation Factor (Cable Loss) |
| | RA = Reading Amplitude | AG = Amplifier Gain |
| | AF = Antenna Factor | |

Transd=AF +CL-AG

RADIATION LIMIT

For intentional device, according to § 15.209(a), the general requirement of field strength of radiated emission from intentional radiators at a distance of 3 meters shall not exceed the following table. According to § 15.247(d), in any 100kHz bandwidth outside the frequency band in which the EUT is operating, the radio frequency power that is produced by the intentional radiator shall be at least 20dB below that in the100kHz bandwidth within the band that contains the highest level of desired power.

The pre-test have done for the EUT in three axes and found the worst emission at position shown in test setup photos.

| Frequency (MHz) | Distance (Meters) | Radiated (dBµV/m) | Radiated (µV/m) |
|-----------------|-------------------|----------------------------------|-----------------|
| 0.009-0.49 | 3 | 20log(2400/F(KHz))+40log(300/3) | 2400/F(KHz) |
| 0.49-1.705 | 3 | 20log(24000/F(KHz))+ 40log(30/3) | 24000/F(KHz) |
| 1.705-30 | 3 | 20log(30)+ 40log(30/3) | 30 |
| 30-88 | 3 | 40.0 | 100 |
| 88-216 | 3 | 43.5 | 150 |
| 216-960 | 3 | 46.0 | 200 |
| Above 960 | 3 | 54.0 | 500 |

TEST RESULTS

Remark:

1. This test was performed with EUT in X, Y, Z position and the worse case was found when EUT in X position.
2. All three channels (lowest/middle/highest) of each mode were measured below 1GHz and recorded worst case at 802.11b low channel.
3. Radiated emission test from 9 KHz to 10th harmonic of fundamental was verified, and no emission found except system noise floor in 9 KHz to 30MHz and not recorded in this report.
4. Remark: Result=Reading value+Factor

For 30MHz-1GHz

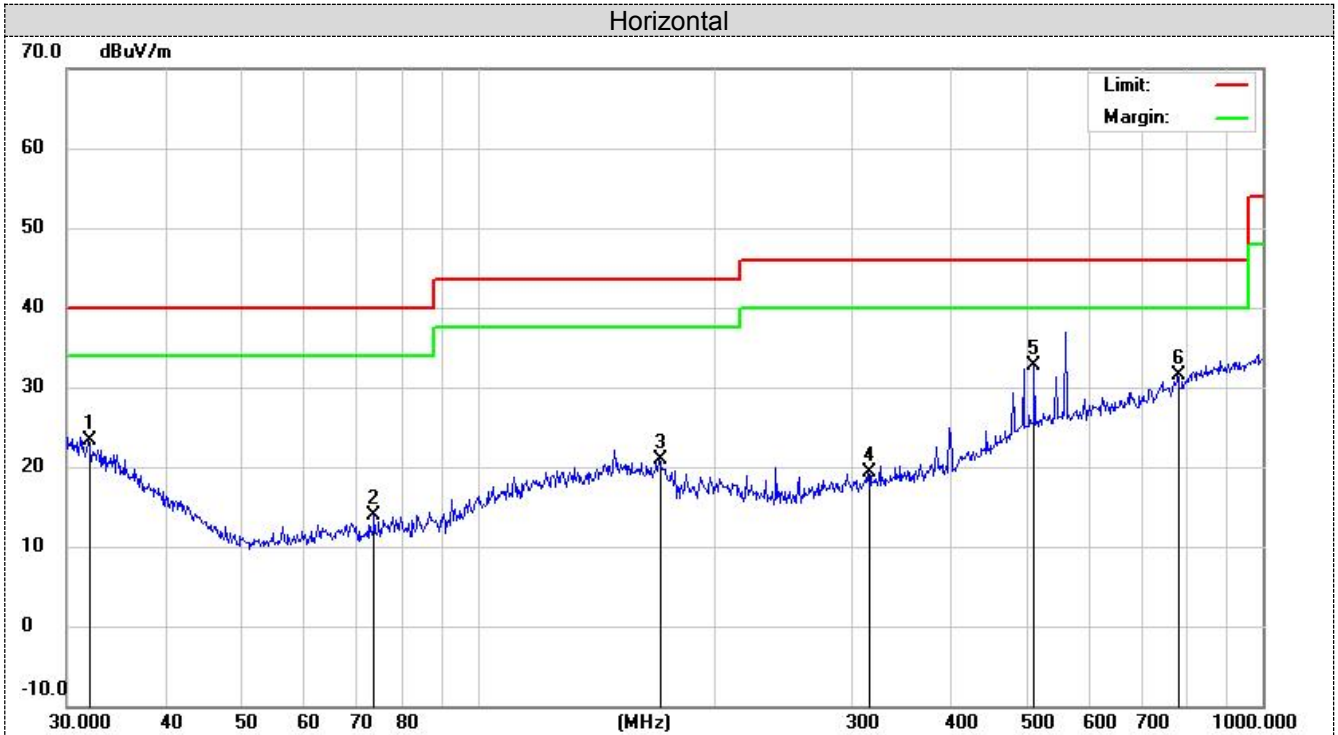

| No. | Mk. | Freq. | Reading Level | Correct Factor | Measurement | Limit | Over | Antenna Height | Table Degree | |
|-----|-----|----------|---------------|----------------|-------------|--------|--------|----------------|--------------|---------|
| | | MHz | dBuV | dB | dBuV/m | dBuV/m | dB | cm | degree | Comment |
| 1 | | 31.9546 | 3.64 | 19.57 | 23.21 | 40.00 | -16.79 | QP | 200 | 23 |
| 2 | | 73.8756 | 4.30 | 9.61 | 13.91 | 40.00 | -26.09 | QP | 200 | 66 |
| 3 | | 170.1948 | 3.93 | 16.96 | 20.89 | 43.50 | -22.61 | QP | 200 | 132 |
| 4 | | 314.3765 | 3.55 | 15.77 | 19.32 | 46.00 | -26.68 | QP | 200 | 196 |
| 5 | * | 511.8352 | 9.97 | 22.83 | 32.80 | 46.00 | -13.20 | QP | 200 | 253 |
| 6 | | 779.6068 | 4.18 | 27.33 | 31.51 | 46.00 | -14.49 | QP | 200 | 304 |

*:Maximum data x:Over limit !:over margin

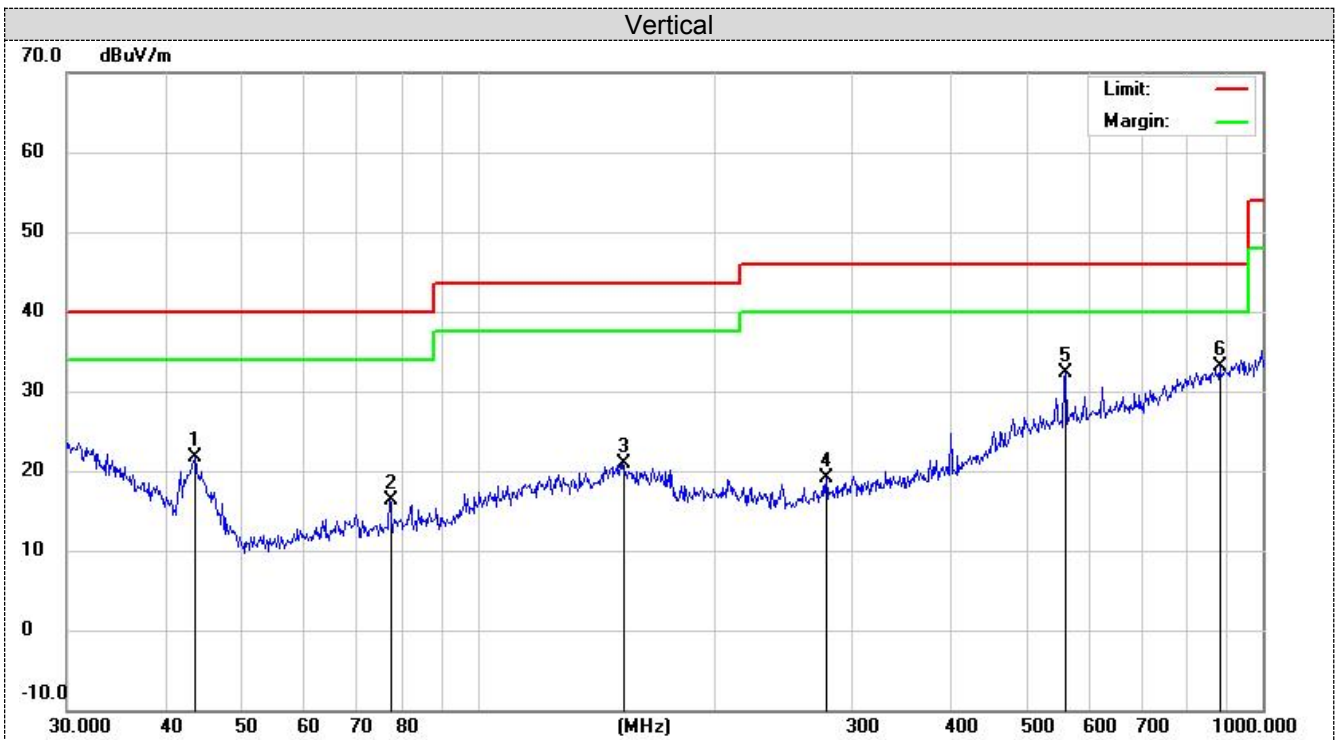

| No. | Mk. | Freq. MHz | Reading Level dBuV | Correct Factor dB | Measure- ment dBuV/m | Limit dBuV/m | Over dB | Detector | Antenna Height cm | Table Degree | Comment |
|-----|-----|--------------|--------------------------|-------------------------|----------------------------|-----------------|------------|----------|-------------------------|-----------------|---------|
| 1 | | 43.6584 | 10.31 | 11.39 | 21.70 | 40.00 | -18.30 | QP | 100 | 23 | |
| 2 | | 77.3212 | 6.38 | 9.89 | 16.27 | 40.00 | -23.73 | QP | 100 | 59 | |
| 3 | | 153.2004 | 3.33 | 17.57 | 20.90 | 43.50 | -22.60 | QP | 100 | 165 | |
| 4 | | 278.0668 | 4.34 | 14.75 | 19.09 | 46.00 | -26.91 | QP | 100 | 209 | |
| 5 | | 560.6928 | 9.00 | 23.37 | 32.37 | 46.00 | -13.63 | QP | 100 | 286 | |
| 6 | * | 881.4067 | 4.21 | 28.80 | 33.01 | 46.00 | -12.99 | QP | 100 | 324 | |

*:Maximum data x:Over limit !:over margin

For 1GHz to 25GHz

Note: 802.11b/802.11g/802.11n (H20) /802.11n (H40) all have been tested, only worse case 802.11b mode is reported

| Polar (H/V) | Frequency | Meter Reading | Antenna Factor | Cable loss | Preamp factor | Emission Level | Limits | Margin | Detector Type |
|-------------------------|-----------|---------------|----------------|------------|---------------|----------------|----------|--------|---------------|
| | (MHz) | (dBuV) | (dB) | (dB) | (dB) | (dBuV/m) | (dBuV/m) | (dB) | |
| 802.11b-2412MHz | | | | | | | | | |
| 4824 | 57.15 | 30.28 | 7.01 | 36.5 | 57.94 | 74 | 16.06 | PK | 4824 |
| 4824 | 41.04 | 30.28 | 7.01 | 36.5 | 41.83 | 54 | 12.17 | AV | 4824 |
| 4824 | 54.7 | 30.28 | 7.01 | 36.5 | 55.49 | 74 | 18.51 | PK | 4824 |
| 4824 | 42.18 | 30.28 | 7.01 | 36.5 | 42.97 | 54 | 11.03 | AV | 4824 |
| 7236 | 41.12 | 36.59 | 8.91 | 35.3 | 51.32 | 74 | 22.68 | PK | 7236 |
| 7236 | 29.85 | 36.59 | 8.91 | 35.3 | 40.05 | 54 | 13.95 | AV | 7236 |
| 7236 | 42.03 | 36.59 | 8.91 | 35.3 | 52.23 | 74 | 21.77 | PK | 7236 |
| 7236 | 29.71 | 36.59 | 8.91 | 35.3 | 39.91 | 54 | 14.09 | AV | 7236 |
| 802.11b -2437MHz | | | | | | | | | |
| 4874 | 55.04 | 30.36 | 7.62 | 36.5 | 56.52 | 74 | 17.48 | PK | 4874 |
| 4874 | 43.72 | 30.36 | 7.62 | 36.5 | 45.2 | 54 | 8.8 | AV | 4874 |
| 4874 | 57.65 | 30.36 | 7.62 | 36.5 | 59.13 | 74 | 14.87 | PK | 4874 |
| 4874 | 44.06 | 30.36 | 7.62 | 36.5 | 45.54 | 54 | 8.46 | AV | 4874 |
| 7311 | 43.32 | 36.61 | 8.84 | 35.3 | 53.47 | 74 | 20.53 | PK | 7311 |
| 7311 | 30.01 | 36.61 | 8.84 | 35.3 | 40.16 | 54 | 13.84 | AV | 7311 |
| 7311 | 43.26 | 36.61 | 8.84 | 35.3 | 53.41 | 74 | 20.59 | PK | 7311 |
| 7311 | 29.53 | 36.61 | 8.84 | 35.3 | 39.68 | 54 | 14.32 | AV | 7311 |
| 802.11b -2462MHz | | | | | | | | | |
| V | 4924 | 55.18 | 30.43 | 7.94 | 36.2 | 57.35 | 74 | 16.65 | PK |
| V | 4924 | 44.06 | 30.43 | 7.94 | 36.2 | 46.23 | 54 | 7.77 | AV |
| H | 4924 | 54.37 | 30.43 | 7.94 | 36.2 | 56.54 | 74 | 17.46 | PK |
| H | 4924 | 44.45 | 30.43 | 7.94 | 36.2 | 46.62 | 54 | 7.38 | AV |
| V | 7386 | 42.45 | 36.78 | 8.45 | 35.3 | 52.38 | 74 | 21.62 | PK |
| V | 7386 | 31.72 | 36.78 | 8.45 | 35.3 | 41.65 | 54 | 12.35 | AV |
| H | 7386 | 40.2 | 36.78 | 8.45 | 35.3 | 50.13 | 74 | 23.87 | PK |
| H | 7386 | 30.32 | 36.78 | 8.45 | 35.3 | 40.25 | 54 | 13.75 | AV |

Note:

- 1) Emission level (dBuV/m) = Meter Reading+ antenna Factor+ cable loss- preamp factor.
- 2) Margin value = Limits-Emission level.
- 3) -- Mean the PK detector measured value is below average limit.
- 4) The other emission levels were very low against the limit.
- 5) RBW1MHz VBW3MHz Peak detector is for PK value; RBW 1MHz VBW10Hz Peak detector is for AV value.

Results of Band Edges Test (Radiated)

| Polar (H/V) | Frequency | Meter Reading | Antenna Factor | Cable loss | Preamp factor | Emission Level | Limits | Margin | Detector Type |
|-------------------------|-----------|---------------|----------------|------------|---------------|----------------|----------|--------|---------------|
| | (MHz) | (dBuV) | (dB) | (dB) | (dB) | (dBuV/m) | (dBuV/m) | (dB) | |
| 802.11b -2412MHz | | | | | | | | | |
| V | 2390 | 56.24 | 27.49 | 3.32 | 36.22 | 50.83 | 74 | 23.17 | PK |
| V | 2390 | 45.48 | 27.49 | 3.32 | 36.22 | 40.07 | 54 | 13.93 | AV |
| H | 2390 | 58.22 | 27.49 | 3.32 | 36.22 | 52.81 | 74 | 21.19 | PK |
| H | 2390 | 47.66 | 27.49 | 3.32 | 36.22 | 42.25 | 54 | 11.75 | AV |
| V | 2400 | 58.37 | 27.55 | 3.41 | 36.22 | 53.11 | 74 | 20.89 | PK |
| V | 2400 | 43.4 | 27.55 | 3.41 | 36.22 | 38.14 | 54 | 15.86 | AV |
| H | 2400 | 58.59 | 27.55 | 3.41 | 36.22 | 53.33 | 74 | 20.67 | PK |
| H | 2400 | 46.67 | 27.55 | 3.41 | 36.22 | 41.41 | 54 | 12.59 | AV |
| 802.11b -2462MHz | | | | | | | | | |
| V | 2483.5 | 58.17 | 27.45 | 3.38 | 36.34 | 52.66 | 74 | 21.34 | PK |
| V | 2483.5 | 46.37 | 27.45 | 3.38 | 36.34 | 40.86 | 54 | 13.14 | AV |
| H | 2483.5 | 59.35 | 27.45 | 3.38 | 36.34 | 53.84 | 74 | 20.16 | PK |
| H | 2483.5 | 46.7 | 27.45 | 3.38 | 36.34 | 41.19 | 54 | 12.81 | AV |
| V | 2500 | 59.05 | 27.41 | 3.47 | 36.35 | 53.58 | 74 | 20.42 | PK |
| V | 2500 | 43.64 | 27.41 | 3.47 | 36.35 | 38.17 | 54 | 15.83 | AV |
| H | 2500 | 57.25 | 27.41 | 3.47 | 36.35 | 51.78 | 74 | 22.22 | PK |
| H | 2500 | 47.18 | 27.41 | 3.47 | 36.35 | 41.71 | 54 | 12.29 | AV |

| Polar (H/V) | Frequency | Meter Reading | Antenna Factor | Cable loss | Preamp factor | Emission Level | Limits | Margin | Detector Type |
|-------------------------|-----------|---------------|----------------|------------|---------------|----------------|----------|--------|---------------|
| | (MHz) | (dBuV) | (dB) | (dB) | (dB) | (dBuV/m) | (dBuV/m) | (dB) | |
| 802.11g -2412MHz | | | | | | | | | |
| V | 4824 | 56.25 | 30.28 | 7.01 | 36.5 | 57.04 | 74 | 16.96 | PK |
| V | 4824 | 43.96 | 30.28 | 7.01 | 36.5 | 44.75 | 54 | 9.25 | AV |
| H | 4824 | 55.38 | 30.28 | 7.01 | 36.5 | 56.17 | 74 | 17.83 | PK |
| H | 4824 | 44.32 | 30.28 | 7.01 | 36.5 | 45.11 | 54 | 8.89 | AV |
| V | 7236 | 40.43 | 36.59 | 8.91 | 35.3 | 50.63 | 74 | 23.37 | PK |
| V | 7236 | 31.74 | 36.59 | 8.91 | 35.3 | 41.94 | 54 | 12.06 | AV |
| H | 7236 | 44.29 | 36.59 | 8.91 | 35.3 | 54.49 | 74 | 19.51 | PK |
| H | 7236 | 31.14 | 36.59 | 8.91 | 35.3 | 41.34 | 54 | 12.66 | AV |
| 802.11g -2462MHz | | | | | | | | | |
| V | 4874 | 55.12 | 30.36 | 7.62 | 36.5 | 56.6 | 74 | 17.4 | PK |
| V | 4874 | 44.92 | 30.36 | 7.62 | 36.5 | 46.4 | 54 | 7.6 | AV |
| H | 4874 | 54.66 | 30.36 | 7.62 | 36.5 | 56.14 | 74 | 17.86 | PK |
| H | 4874 | 44.83 | 30.36 | 7.62 | 36.5 | 46.31 | 54 | 7.69 | AV |
| V | 7311 | 41.32 | 36.61 | 8.84 | 35.3 | 51.47 | 74 | 22.53 | PK |
| V | 7311 | 30.08 | 36.61 | 8.84 | 35.3 | 40.23 | 54 | 13.77 | AV |
| H | 7311 | 40.8 | 36.61 | 8.84 | 35.3 | 50.95 | 74 | 23.05 | PK |
| H | 7311 | 30.73 | 36.61 | 8.84 | 35.3 | 40.88 | 54 | 13.12 | AV |

| Polar (H/V) | Frequency | Meter Reading | Antenna Factor | Cable loss | Preamp factor | Emission Level | Limits | Margin | Detector Type |
|-------------------------------|-----------|---------------|----------------|------------|---------------|----------------|----------|--------|---------------|
| | (MHz) | (dBuV) | (dB) | (dB) | (dB) | (dBuV/m) | (dBuV/m) | (dB) | |
| 802.11n(HT20) -2412MHz | | | | | | | | | |
| V | 4924 | 55.88 | 30.43 | 7.94 | 36.2 | 58.05 | 74 | 15.95 | PK |
| V | 4924 | 44.83 | 30.43 | 7.94 | 36.2 | 47 | 54 | 7 | AV |
| H | 4924 | 53.12 | 30.43 | 7.94 | 36.2 | 55.29 | 74 | 18.71 | PK |
| H | 4924 | 40.53 | 30.43 | 7.94 | 36.2 | 42.7 | 54 | 11.3 | AV |
| V | 7386 | 40.13 | 36.78 | 8.45 | 35.3 | 50.06 | 74 | 23.94 | PK |
| V | 7386 | 29.46 | 36.78 | 8.45 | 35.3 | 39.39 | 54 | 14.61 | AV |
| H | 7386 | 43.81 | 36.78 | 8.45 | 35.3 | 53.74 | 74 | 20.26 | PK |
| H | 7386 | 31.97 | 36.78 | 8.45 | 35.3 | 41.9 | 54 | 12.1 | AV |
| 802.11n(HT20) -2462MHz | | | | | | | | | |
| V | 2390 | 56.27 | 27.49 | 3.32 | 36.22 | 50.86 | 74 | 23.14 | PK |
| V | 2390 | 43.52 | 27.49 | 3.32 | 36.22 | 38.11 | 54 | 15.89 | AV |
| H | 2390 | 55.56 | 27.49 | 3.32 | 36.22 | 50.15 | 74 | 23.85 | PK |
| H | 2390 | 46.95 | 27.49 | 3.32 | 36.22 | 41.54 | 54 | 12.46 | AV |
| V | 2400 | 56.71 | 27.55 | 3.41 | 36.22 | 51.45 | 74 | 22.55 | PK |
| V | 2400 | 44.6 | 27.55 | 3.41 | 36.22 | 39.34 | 54 | 14.66 | AV |
| H | 2400 | 57.16 | 27.55 | 3.41 | 36.22 | 51.9 | 74 | 22.1 | PK |
| H | 2400 | 45.41 | 27.55 | 3.41 | 36.22 | 40.15 | 54 | 13.85 | AV |

| Polar (H/V) | Frequency | Meter Reading | Antenna Factor | Cable loss | Preamp factor | Emission Level | Limits | Margin | Detector Type |
|-------------------------------|-----------|---------------|----------------|------------|---------------|----------------|----------|--------|---------------|
| | (MHz) | (dBuV) | (dB) | (dB) | (dB) | (dBuV/m) | (dBuV/m) | (dB) | |
| 802.11n(HT40) -2422MHz | | | | | | | | | |
| V | 2483.5 | 55.36 | 27.45 | 3.38 | 36.34 | 49.85 | 74 | 24.15 | PK |
| V | 2483.5 | 45.91 | 27.45 | 3.38 | 36.34 | 40.4 | 54 | 13.6 | AV |
| H | 2483.5 | 59.32 | 27.45 | 3.38 | 36.34 | 53.81 | 74 | 20.19 | PK |
| H | 2483.5 | 44.43 | 27.45 | 3.38 | 36.34 | 38.92 | 54 | 15.08 | AV |
| V | 2500 | 59.28 | 27.41 | 3.47 | 36.35 | 53.81 | 74 | 20.19 | PK |
| V | 2500 | 45.51 | 27.41 | 3.47 | 36.35 | 40.04 | 54 | 13.96 | AV |
| H | 2500 | 56.1 | 27.41 | 3.47 | 36.35 | 50.63 | 74 | 23.37 | PK |
| H | 2500 | 46.53 | 27.41 | 3.47 | 36.35 | 41.06 | 54 | 12.94 | AV |
| 802.11n(HT40) -2452MHz | | | | | | | | | |
| V | 4824 | 54.84 | 30.28 | 7.01 | 36.5 | 55.63 | 74 | 18.37 | PK |
| V | 4824 | 44 | 30.28 | 7.01 | 36.5 | 44.79 | 54 | 9.21 | AV |
| H | 4824 | 57.07 | 30.28 | 7.01 | 36.5 | 57.86 | 74 | 16.14 | PK |
| H | 4824 | 43.18 | 30.28 | 7.01 | 36.5 | 43.97 | 54 | 10.03 | AV |
| V | 7236 | 41.73 | 36.59 | 8.91 | 35.3 | 51.93 | 74 | 22.07 | PK |
| V | 7236 | 31.73 | 36.59 | 8.91 | 35.3 | 41.93 | 54 | 12.07 | AV |
| H | 7236 | 44.2 | 36.59 | 8.91 | 35.3 | 54.4 | 74 | 19.6 | PK |
| H | 7236 | 30.44 | 36.59 | 8.91 | 35.3 | 40.64 | 54 | 13.36 | AV |

Note:

- 1) Emission level (dBuV/m) = Meter Reading+ antenna Factor+ cable loss- preamp factor.
- 2) Margin value = Limits-Emission level.
- 3) -- Mean the PK detector measured value is below average limit.
- 4) The other emission levels were very low against the limit.
- 5) RBW1MHz VBW3MHz Peak detector is for PK value; RBW 1MHz VBW10Hz Peak detector is for AV value.

5.3 Maximum Conducted Output Power

Limit

The Maximum Peak Output Power Measurement is 30dBm.

Test Procedure

Remove the antenna from the EUT and then connect a low loss RF cable from the antenna port to the power sensor.

Test Configuration

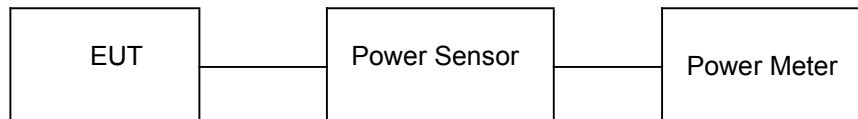

Test Results

See Appendix I

5.4 Power Spectral Density

Limit

For digitally modulated systems, the power spectral density conducted from the intentional radiator to the antenna shall not be greater than 8 dBm in any 3 kHz band during any time interval of continuous transmission.

Test Procedure

1. Use this procedure when the maximum peak conducted output power in the fundamental emission is used to demonstrate compliance.
2. Set the RBW \geq 3 kHz.
3. Set the VBW \geq 3 \times RBW.
4. Set the span to 1.5 times the DTS channel bandwidth.
5. Detector = peak.
6. Sweep time = auto couple.
7. Trace mode = max hold.
8. Allow trace to fully stabilize.
9. Use the peak marker function to determine the maximum power level.
10. If measured value exceeds limit, reduce RBW (no less than 3 kHz) and repeat.
11. The resulting peak PSD level must be 8dBm.

Test Configuration



Test Results

See APPENDIX VI

5.5 6dB Bandwidth

Limit

For digital modulation systems, the minimum 6 dB bandwidth shall be at least 500 kHz

Test Procedure

The transmitter output was connected to the spectrum analyzer through an attenuator. The bandwidth of the fundamental frequency was measured by spectrum analyzer with 100 KHz RBW and 300 KHz VBW. The 6dB bandwidth is defined as the total spectrum the power of which is higher than peak power minus 6dB.

Test Configuration

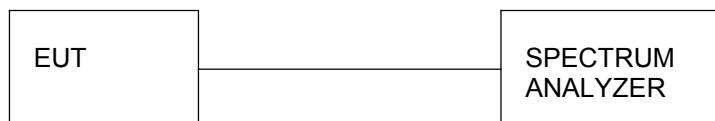

Test Results

See APPENDIX III

5.6 Out-of-band Emissions

Limit

In any 100 kHz bandwidth outside the frequency band in which the spread spectrum or digitally modulated intentional radiator is operating, the radio frequency power that is produced by the intentional radiator shall be at least 20 dB below that in the 100 kHz bandwidth within the band that contains the highest level of the desired power, based on either an RF conducted or a radiated measurement, provided the transmitter demonstrates compliance with the peak conducted power limits. If the transmitter complies with the conducted power limits based on the use of RMS averaging over a time interval, as permitted under paragraph (b)(3) of this section, the attenuation required under this paragraph shall be 30 dB instead of 20 dB. Attenuation below the general limits specified in §15.209(a) is not required.

Test Procedure

Connect the transmitter output to spectrum analyzer using a low loss RF cable, and set the spectrum analyzer to RBW=100 kHz, VBW= 300 kHz, peak detector, and max hold. Measurements utilizing these settings are made of the in-band reference level, band edge and out-of-band emissions.

Test Configuration



Test Results

See APPENDIX IV

5.7 Duty Cycle Information

See APPENDIX V

5.8 Antenna Requirement

Standard Applicable

For intentional device, according to FCC 47 CFR Section 15.203:

An intentional radiator shall be designed to ensure that no antenna other than that furnished by the responsible party shall be used with the device. The use of a permanently attached antenna or of an antenna that uses a unique coupling to the intentional radiator, the manufacturer may design the unit so that a broken antenna can be replaced by the user, but the use of a standard antenna jack or electrical connector is prohibited

FCC CFR Title 47 Part 15 Subpart C Section 15.247(c) (1) (I):

(i) Systems operating in the 2400-2483.5 MHz band that is used exclusively for fixed. Point-to-point operations may employ transmitting antennas with directional gain greater than 6dBi provided the maximum conducted output power of the intentional radiator is reduced by 1 dB for every 3 dB that the directional gain of the antenna exceeds 6dBi.

Test Result:

The directional gains of antenna used for transmitting is 0dBi, and the antenna is an PCB antenna and no consideration of replacement. Please see EUT photo for details.

Results: Compliance.

6 Test Setup Photos of the EUT

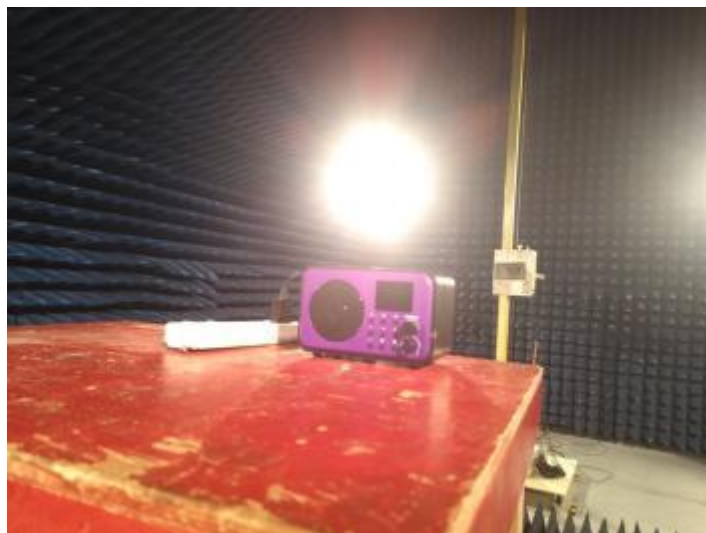
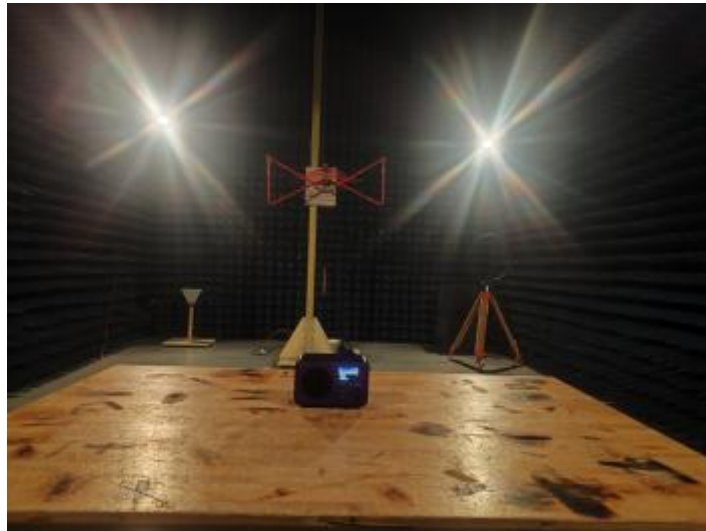

7 Photos of the EUT

See related photo report.

APPENDIX I. Conducted Peak Output Power**Test Result**

Conducted peak output power

| Mode | Channel | Ant. 0 (dBm) | Ant. 1 (dBm) | Ant. 2 (dBm) | Ant. 3 (dBm) | Total (dBm) | Limit (dBm) | Result |
|-----------------|---------|--------------|--------------|--------------|--------------|-------------|-------------|--------|
| IEEE 802.11b | 1 | 7.75 | / | / | / | N/A | 30 | PASS |
| | 6 | 8.23 | / | / | / | N/A | 30 | PASS |
| | 11 | 5.97 | / | / | / | N/A | 30 | PASS |
| IEEE 802.11g | 1 | 8.58 | / | / | / | N/A | 30 | PASS |
| | 6 | 9.47 | / | / | / | N/A | 30 | PASS |
| | 11 | 6.72 | / | / | / | N/A | 30 | PASS |
| IEEE 802.11n_20 | 1 | 8.64 | / | / | / | N/A | 30 | PASS |
| | 6 | 9.56 | / | / | / | N/A | 30 | PASS |
| | 11 | 6.52 | / | / | / | N/A | 30 | PASS |
| IEEE 802.11n_40 | 3 | 7.35 | / | / | / | N/A | 30 | PASS |
| | 6 | 9.10 | / | / | / | N/A | 30 | PASS |
| | 9 | 6.52 | / | / | / | N/A | 30 | PASS |

APPENDIX II.99% Bandwidth

Test Result

| Mode | Channel | Ant. | 99% BW (MHz) |
|-----------------|---------|------|--------------|
| IEEE 802.11b | 1 | 0 | 11.653 |
| | 6 | | 12.813 |
| | 11 | | 11.804 |
| IEEE 802.11g | 1 | | 16.150 |
| | 6 | | 16.590 |
| | 11 | | 15.949 |
| IEEE 802.11n_20 | 1 | | 17.283 |
| | 6 | | 17.699 |
| | 11 | | 17.037 |
| IEEE 802.11n_40 | 3 | | 35.699 |
| | 6 | | 36.732 |
| | 9 | | 34.598 |

Test Graphs

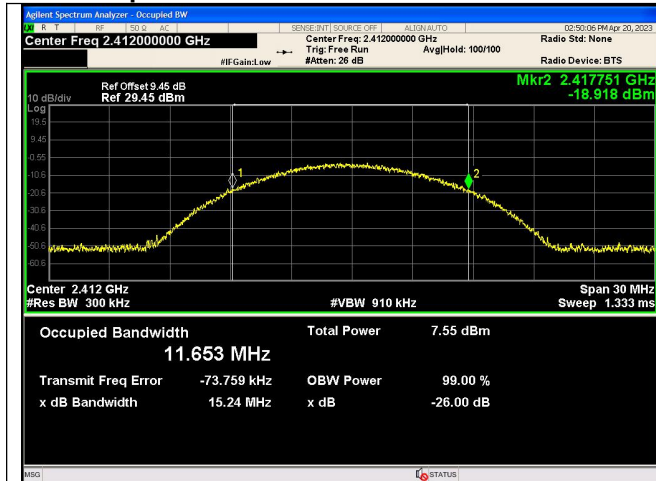

IEEE 802.11b_Channel 1_20MHz_Antenna 0



IEEE 802.11b_Channel 6_20MHz_Antenna 0



IEEE 802.11b_Channel 11_20MHz_Antenna 0



IEEE 802.11g_Channel 1_20MHz_Antenna 0

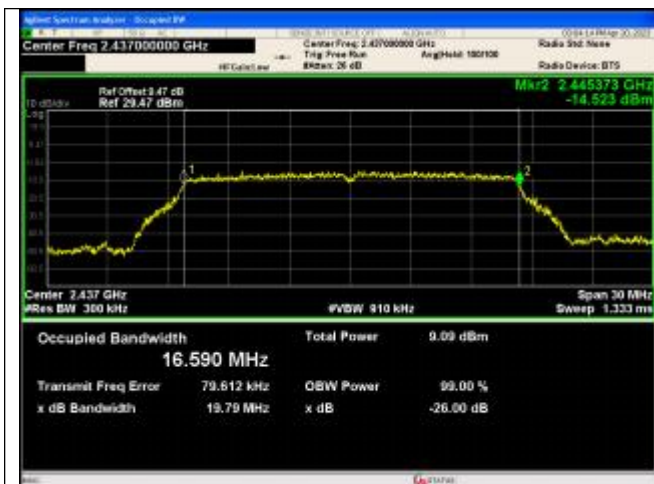

IEEE 802.11g Channel 6 20MHz Antenna 0



IEEE 802.11g Channel 11 20MHz Antenna 0



IEEE 802.11n Channel 1 20MHz Antenna 0



IEEE 802.11n Channel 6 20MHz Antenna 0



IEEE 802.11n Channel 11 20MHz Antenna 0



IEEE 802.11n Channel 3 40MHz Antenna 0



IEEE 802.11n_Channel 6_40MHz_Antenna 0



IEEE 802.11n_Channel 9_40MHz_Antenna 0

APPENDIX III.6dB Bandwidth

Test Result

| Mode | Channel | Ant. | Center Frequency (MHz) | 6 dB Bandwidth (MHz) | Limit (MHz) | Result |
|-----------------|---------|------|------------------------|----------------------|-------------|--------|
| IEEE 802.11b | 1 | 0 | 2412 | 6.982 | 0.5 | PASS |
| | 6 | | 2437 | 7.531 | | PASS |
| | 11 | | 2462 | 7.655 | | PASS |
| IEEE 802.11g | 1 | | 2412 | 12.50 | | PASS |
| | 6 | | 2437 | 16.47 | | PASS |
| | 11 | | 2462 | 10.60 | | PASS |
| IEEE 802.11n_20 | 1 | | 2412 | 12.59 | | PASS |
| | 6 | | 2437 | 17.30 | | PASS |
| | 11 | | 2462 | 10.96 | | PASS |
| IEEE 802.11n_40 | 3 | | 2422 | 21.32 | | PASS |
| | 6 | | 2437 | 35.80 | | PASS |
| | 9 | | 2452 | 15.07 | | PASS |

Test Graphs

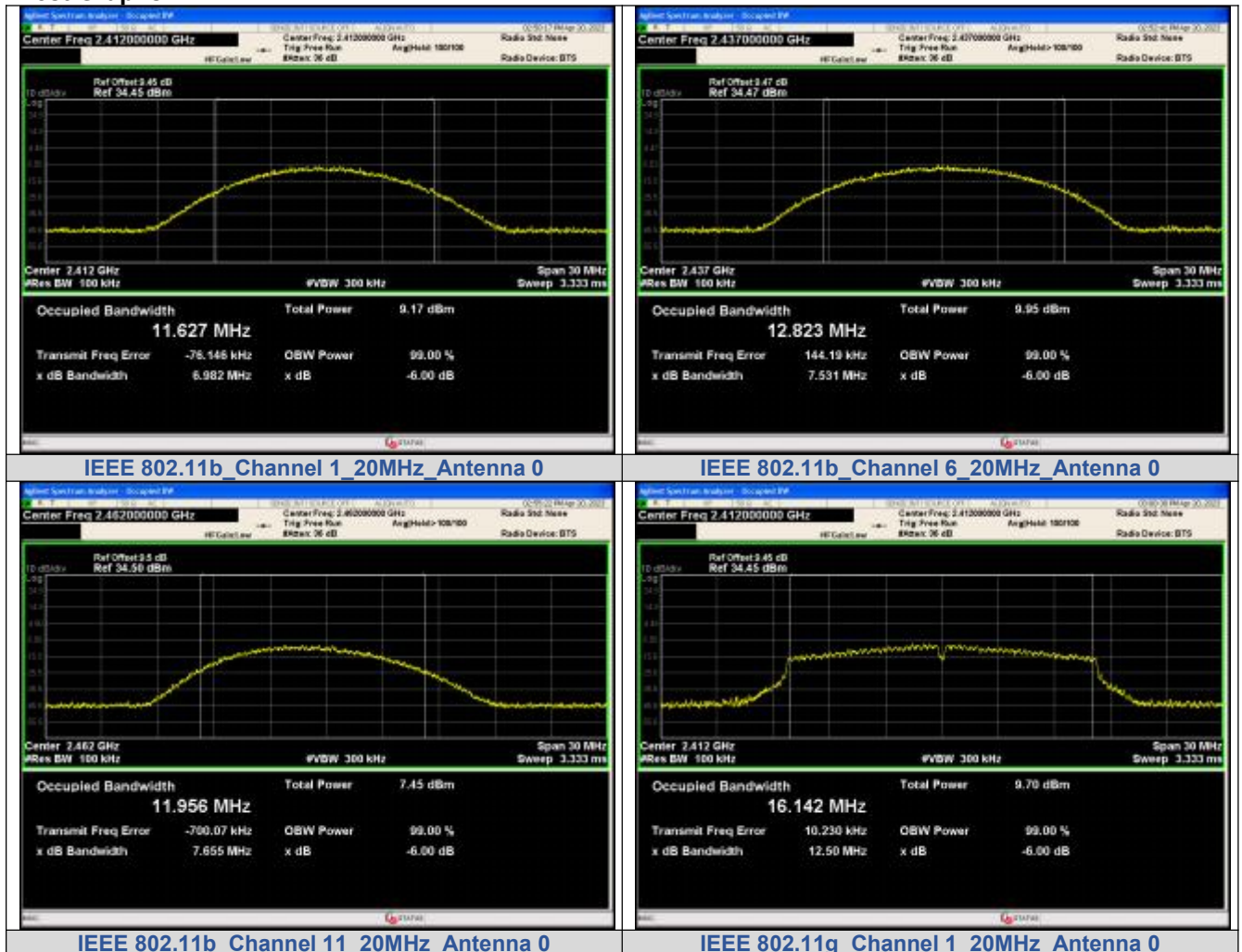

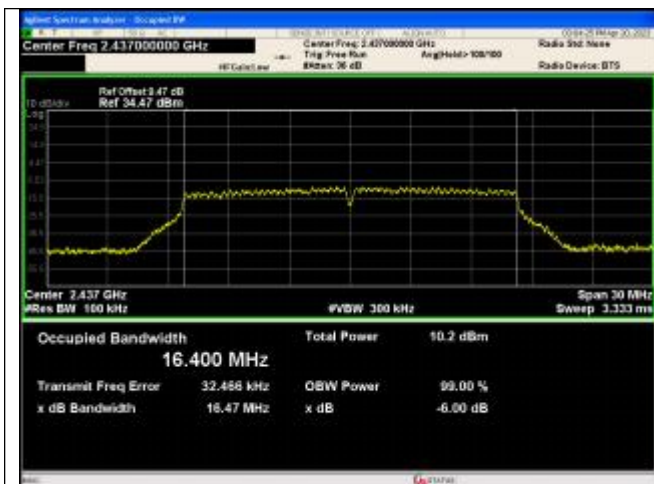

IEEE 802.11g Channel 6 20MHz Antenna 0

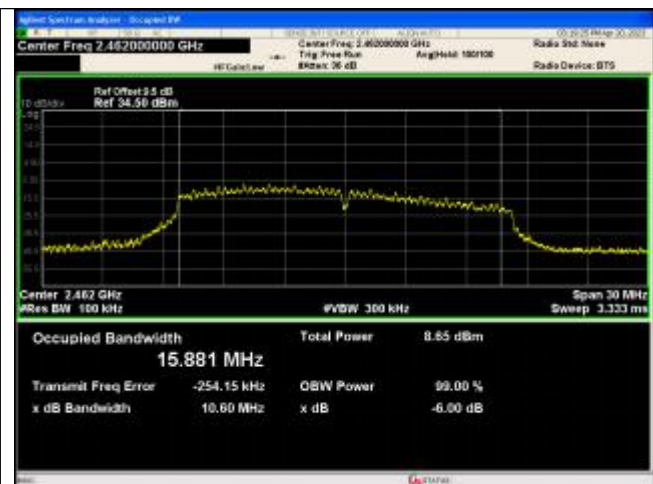

IEEE 802.11g Channel 11 20MHz Antenna 0



IEEE 802.11n Channel 1 20MHz Antenna 0

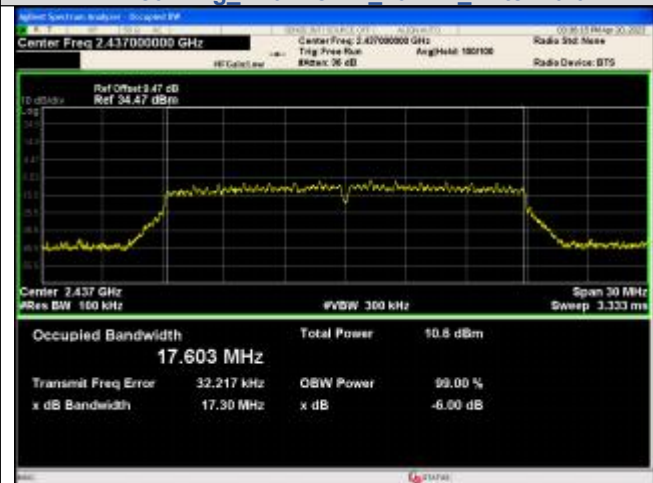

IEEE 802.11n Channel 6 20MHz Antenna 0



IEEE 802.11n Channel 11 20MHz Antenna 0



IEEE 802.11n Channel 3 40MHz Antenna 0

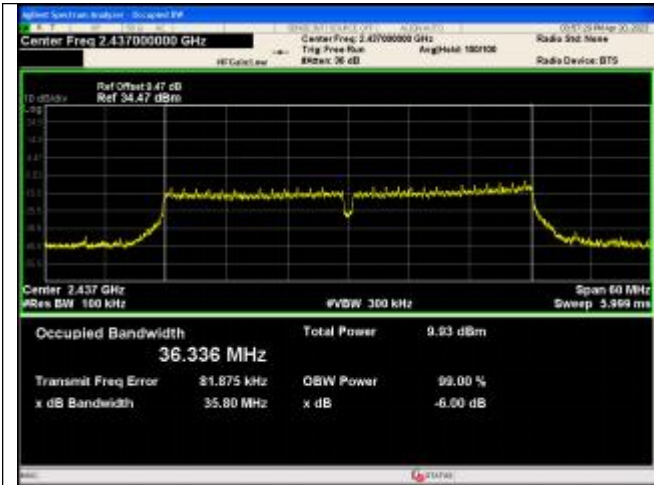

IEEE 802.11n_Channel 6_40MHz_Antenna 0

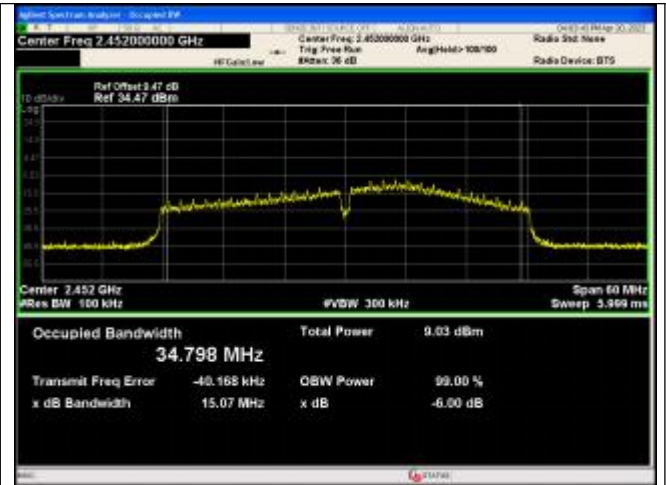

IEEE 802.11n_Channel 9_40MHz_Antenna 0

APPENDIX IV. Conducted Out Of Band Emission

Test Result

| Mode | Channel | Ant. | OOB Emission Frequency (MHz) | OOB Emission Level (dBm) | Limit (dBm) | Over Limit (dB) | Result | |
|-----------------|---------|---------|------------------------------|--------------------------|-------------|-----------------|--------|------|
| IEEE 802.11b | 1 | 0 | 2400.00 | -44.461 | -26.25 | -18.211 | PASS | |
| | | | 2376.95 | -41.995 | -26.25 | -15.745 | PASS | |
| | | | 24982.5 | -37.614 | -26.25 | -11.364 | PASS | |
| | 6 | | 899.60 | -36.577 | -25.4 | -11.177 | PASS | |
| | | | 11 | 2483.50 | -43.302 | -28.01 | -15 | PASS |
| | | | | 24993.8 | -37.652 | -28.01 | -9.642 | PASS |
| 2400.00 | -43.790 | | | -27.16 | -16.630 | PASS | | |
| IEEE 802.11g | 1 | | 2396.97 | -41.208 | -27.16 | -14.048 | PASS | |
| | | | 24935.7 | -37.623 | -27.16 | -10.463 | PASS | |
| | 6 | | 907.72 | -30.132 | -27.97 | -2.162 | PASS | |
| | | | 11 | 2483.50 | -44.047 | -27.71 | -16 | PASS |
| IEEE 802.11n_20 | 1 | | | 24933.8 | -37.448 | -27.71 | -9.738 | PASS |
| | | 2400.00 | -41.699 | -26.22 | -15.479 | PASS | | |
| | | 2398.27 | -38.280 | -26.22 | -12.060 | PASS | | |
| | 6 | 24908.2 | -37.640 | -26.22 | -11.420 | PASS | | |
| | | 11 | 24847.1 | -37.781 | -26.97 | -10.811 | PASS | |
| | | | 2483.50 | -43.272 | -27.7 | -16 | PASS | |
| IEEE 802.11n_40 | 3 | | 24928.8 | -36.896 | -27.7 | -9.196 | PASS | |
| | | 2400.00 | -43.652 | -28.14 | -15.512 | PASS | | |
| | | 2359.14 | -41.779 | -28.14 | -13.639 | PASS | | |
| | 6 | 24625.4 | -36.446 | -28.14 | -8.306 | PASS | | |
| | | 9 | 24847.7 | -37.541 | -28.25 | -9.291 | PASS | |
| | | | 2483.50 | -43.711 | -27.71 | -16 | PASS | |
| 24494.3 | -38.308 | | -27.71 | -10.598 | PASS | | | |

Test Graphs



In-Band Reference Level
 IEEE 802.11b_Channel 1_20MHz_Antenna 0

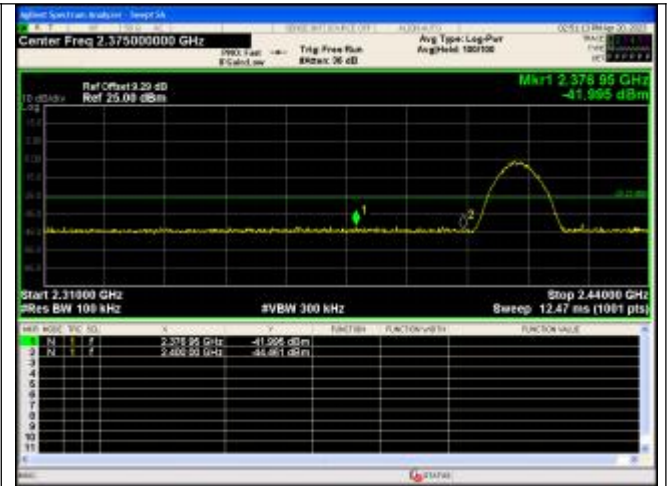

Out Of Band Emission
 IEEE 802.11b_Channel 1_20MHz_Antenna 0



Spurious Emission
IEEE 802.11b Channel 1 20MHz Antenna 0

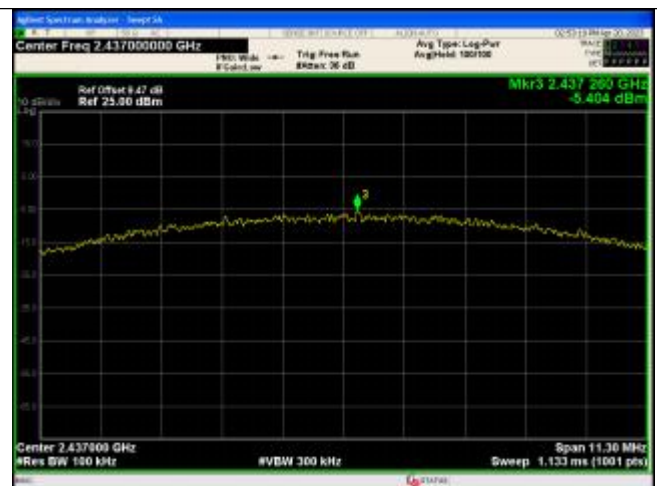

In-Band Reference Level
IEEE 802.11b Channel 6 20MHz Antenna 0



Spurious Emissions
IEEE 802.11b Channel 6 20MHz Antenna 0

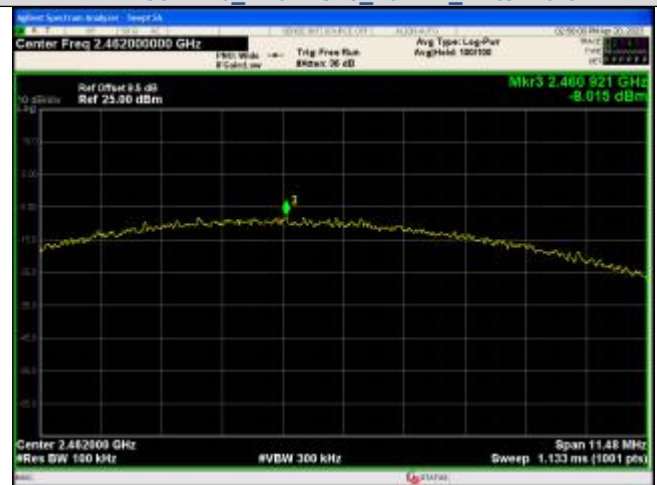

In-Band Reference Level
IEEE 802.11b Channel 11 20MHz Antenna 0

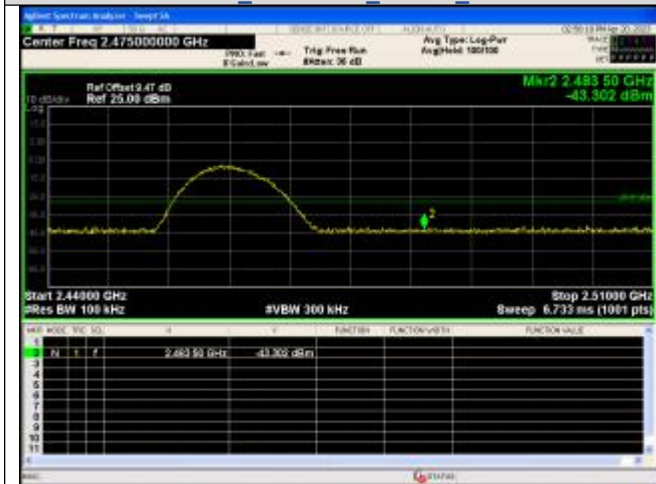

Out Of Band Emission
IEEE 802.11b Channel 11 20MHz Antenna 0

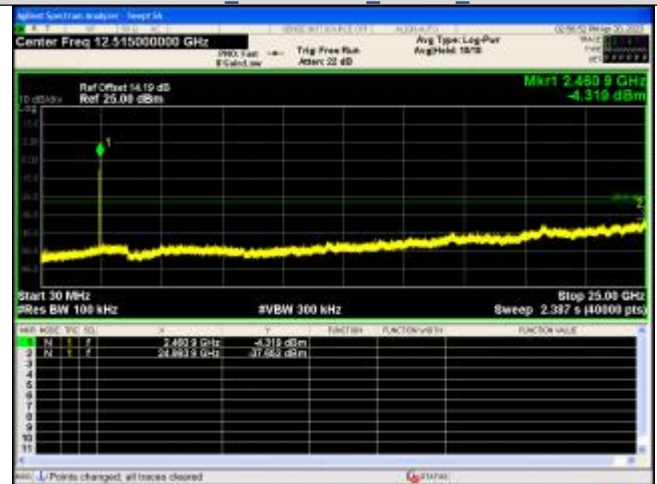

Spurious Emission
IEEE 802.11b Channel 11 20MHz Antenna 0



In-Band Reference Level
 IEEE 802.11g Channel 1 20MHz Antenna 0

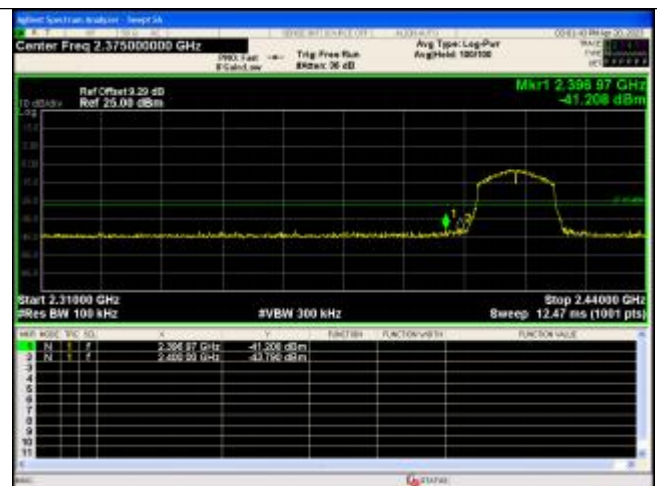

Out Of Band Emission
 IEEE 802.11g Channel 1 20MHz Antenna 0



Spurious Emission
 IEEE 802.11g Channel 1 20MHz Antenna 0

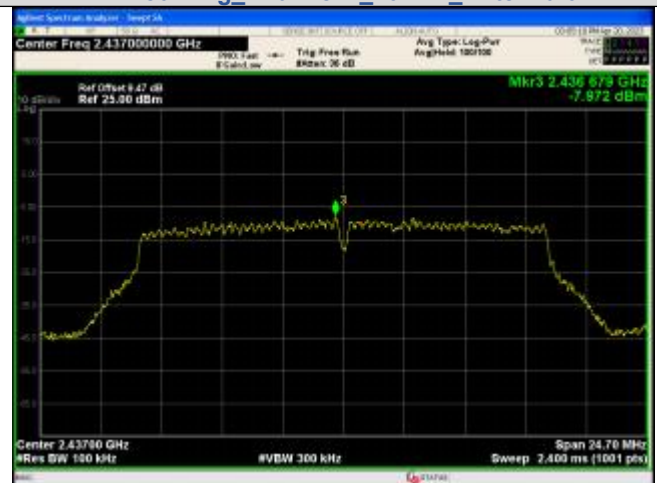

In-Band Reference Level
 IEEE 802.11g Channel 6 20MHz Antenna 0

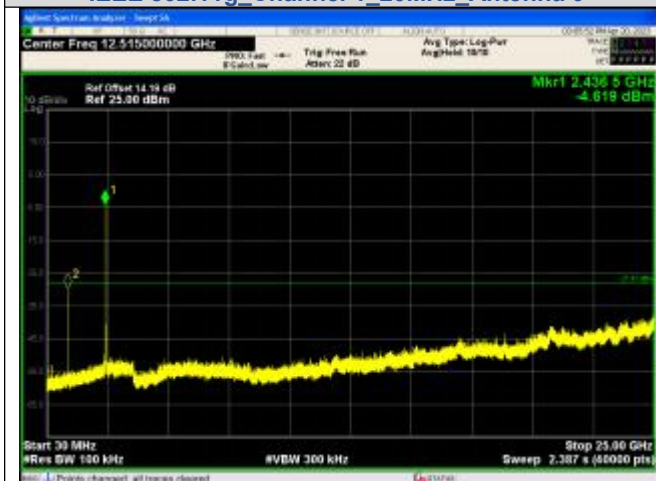

Spurious Emissions
 IEEE 802.11g Channel 6 20MHz Antenna 0



In-Band Reference Level
 IEEE 802.11g Channel 11 20MHz Antenna 0



Out Of Band Emission
 IEEE 802.11g_Channel 11_20MHz_Antenna 0

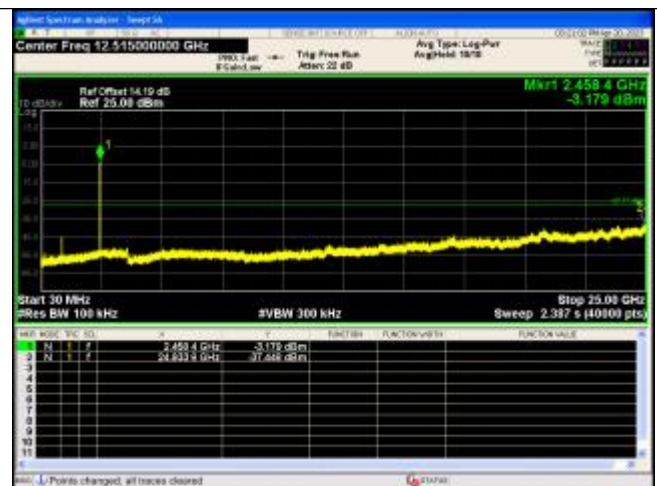

Spurious Emission
 IEEE 802.11g_Channel 11_20MHz_Antenna 0

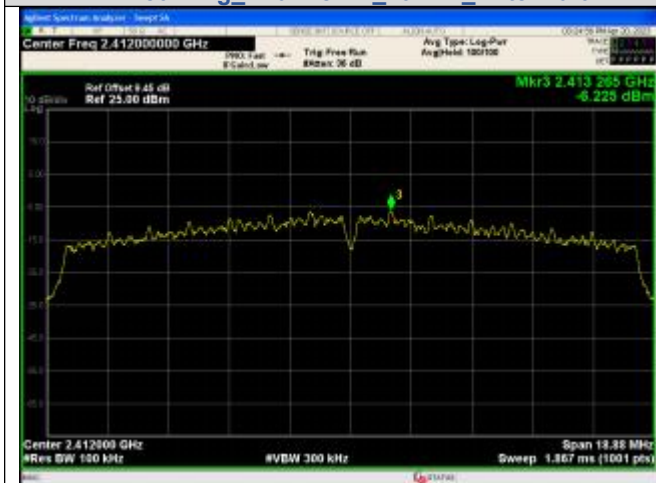

In-Band Reference Level
 IEEE 802.11n_Channel 1_20MHz_Antenna 0

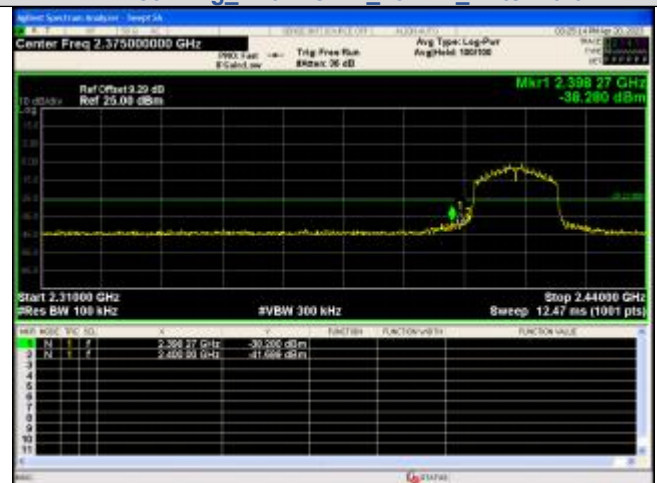

Out Of Band Emission
 IEEE 802.11n_Channel 1_20MHz_Antenna 0



Spurious Emission
 IEEE 802.11n_Channel 1_20MHz_Antenna 0



In-Band Reference Level
 IEEE 802.11n_Channel 6_20MHz_Antenna 0



Spurious Emissions
 IEEE 802.11n_Channel 6_20MHz_Antenna 0



In-Band Reference Level
 IEEE 802.11n_Channel 11_20MHz_Antenna 0



Out Of Band Emission
 IEEE 802.11n_Channel 11_20MHz_Antenna 0

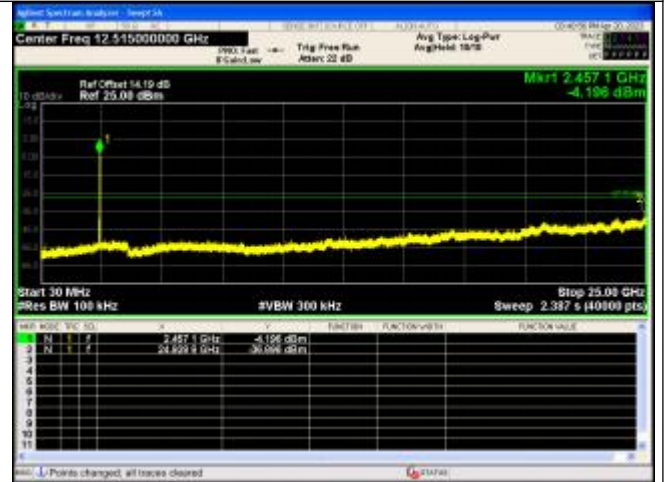

Spurious Emission
 IEEE 802.11n_Channel 11_20MHz_Antenna 0



In-Band Reference Level
 IEEE 802.11n_Channel 3_40MHz_Antenna 0



Out Of Band Emission
 IEEE 802.11n_Channel 3_40MHz_Antenna 0



Spurious Emission
 IEEE 802.11n Channel 3 40MHz Antenna 0

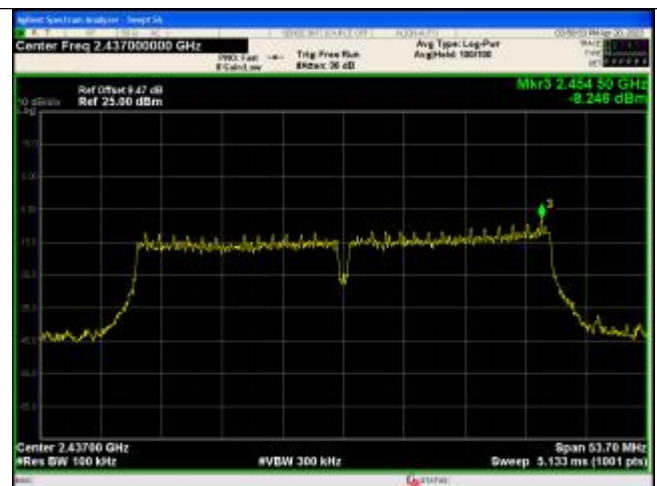

In-Band Reference Level
 IEEE 802.11n Channel 6 40MHz Antenna 0



Spurious Emissions
 IEEE 802.11n Channel 6 40MHz Antenna 0



In-Band Reference Level
 IEEE 802.11n Channel 9 40MHz Antenna 0



Out Of Band Emission
 IEEE 802.11n Channel 9 40MHz Antenna 0



Spurious Emission
 IEEE 802.11n Channel 9 40MHz Antenna 0

APPENDIX V.Duty Cycle

Test Result

| Mode | Data rates | Channel | On Time (ms) | Period (ms) | Duty Cycle (%) | Duty Cycle (linear) | Duty Cycle Factor (dB) |
|-----------------|------------|---------|--------------|-------------|----------------|---------------------|------------------------|
| IEEE 802.11b | 11 | 1 | 0.937 | 0.975 | 96.15 | 0.9615 | 0.1705 |
| | | 6 | 0.937 | 0.974 | 96.15 | 0.9615 | 0.1705 |
| | | 11 | 0.016 | 0.017 | 99.62 | 0.9962 | 0.0165 |
| IEEE 802.11g | 54 | 1 | 0.052 | 0.052 | 99.95 | 0.9995 | 0.0022 |
| | | 6 | 0.013 | 0.013 | 99.61 | 0.9961 | 0.017 |
| | | 11 | 0.000 | 0.000 | 93.85 | 0.9385 | 0.2757 |
| IEEE 802.11n_20 | MCS 7 | 1 | 0.018 | 0.018 | 99.79 | 0.9979 | 0.0091 |
| | | 6 | 0.030 | 0.075 | 40.74 | 0.4074 | 3.8998 |
| | | 11 | 0.014 | 0.059 | 24.28 | 0.2428 | 6.1475 |
| 3 | | 0.005 | 0.005 | 99.56 | 0.9956 | 0.0192 | |
| IEEE 802.11n_40 | | 6 | 0.004 | 0.004 | 99.52 | 0.9952 | 0.0209 |
| | | 9 | 0.064 | 0.108 | 59.48 | 0.5948 | 2.2563 |

Test Graphs

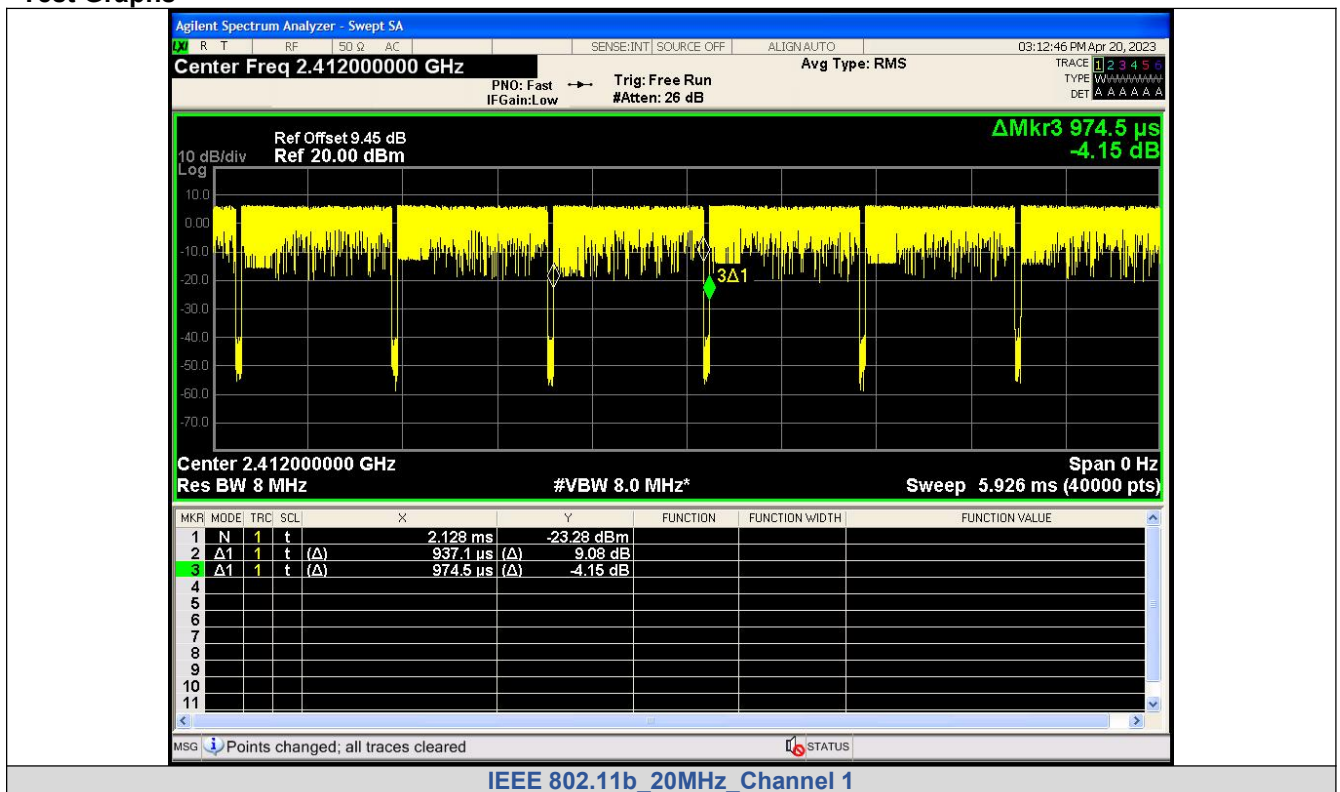

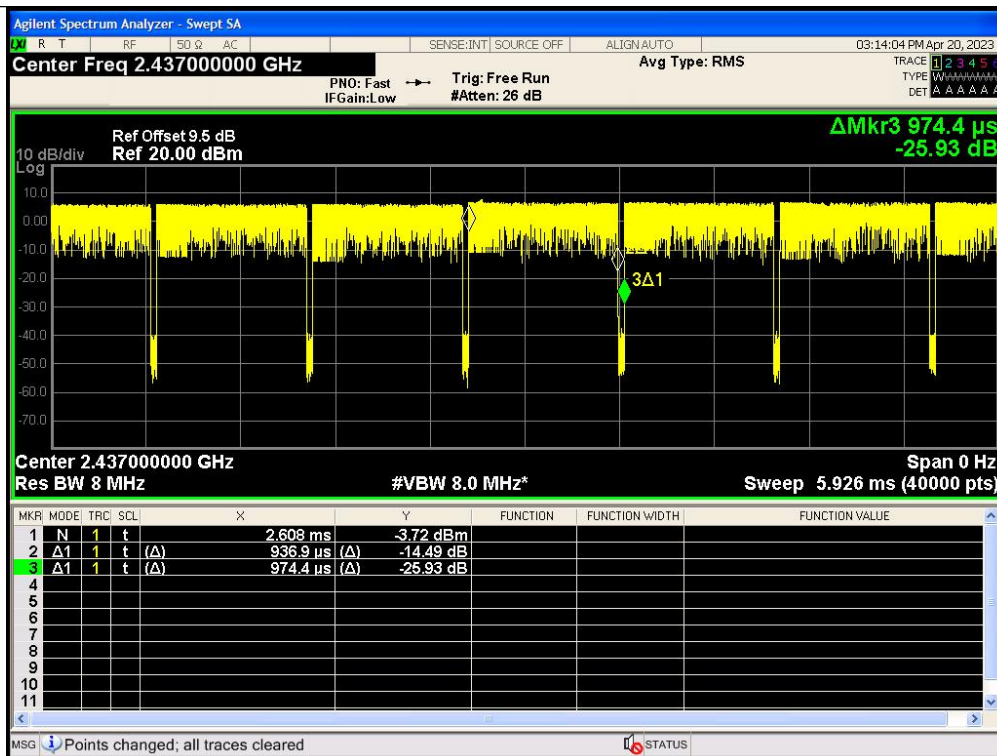

IEEE 802.11b 20MHz Channel 6

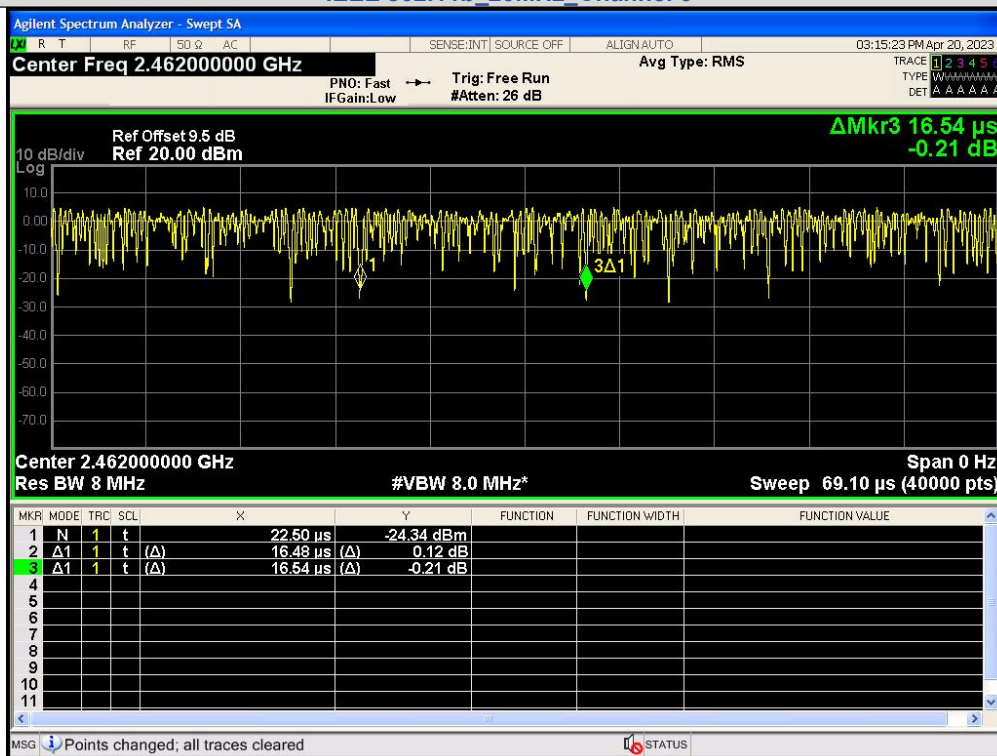

IEEE 802.11b 20MHz Channel 11

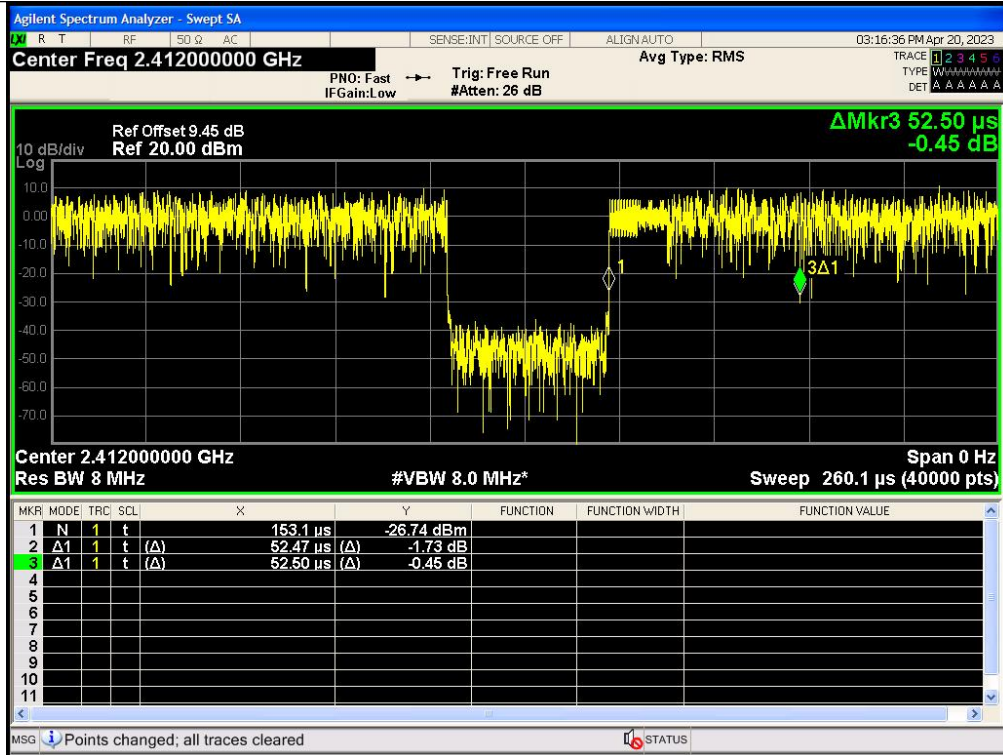

IEEE 802.11g_20MHz_Channel 1

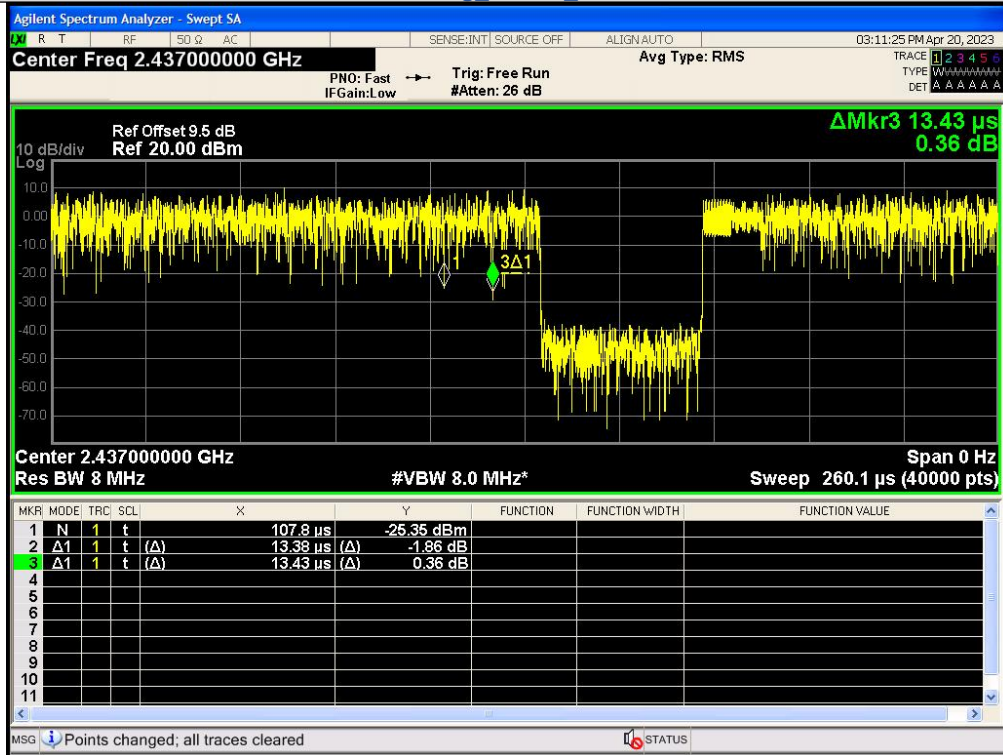

IEEE 802.11g_20MHz_Channel 6

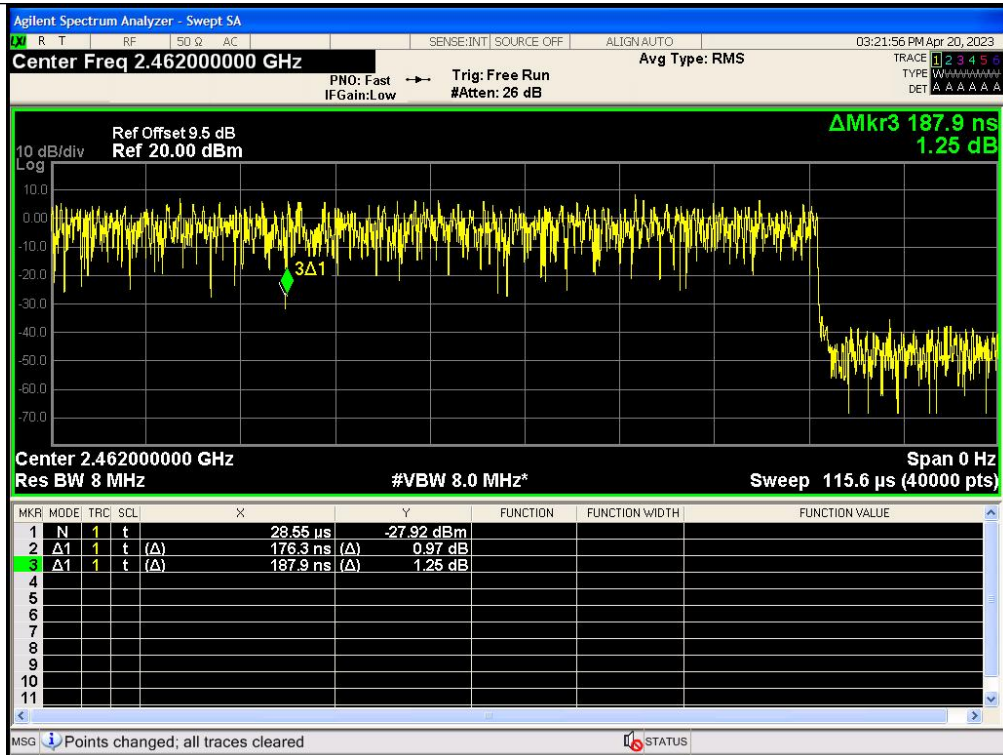

IEEE 802.11g_20MHz_Channel 11

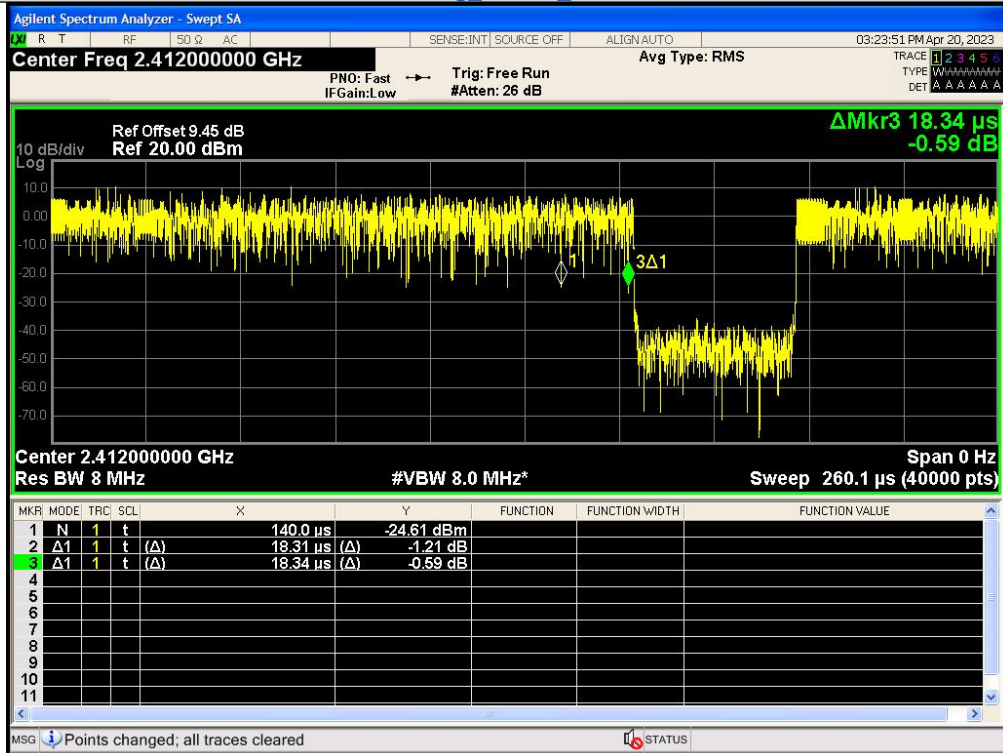

IEEE 802.11n_20MHz_Channel 1

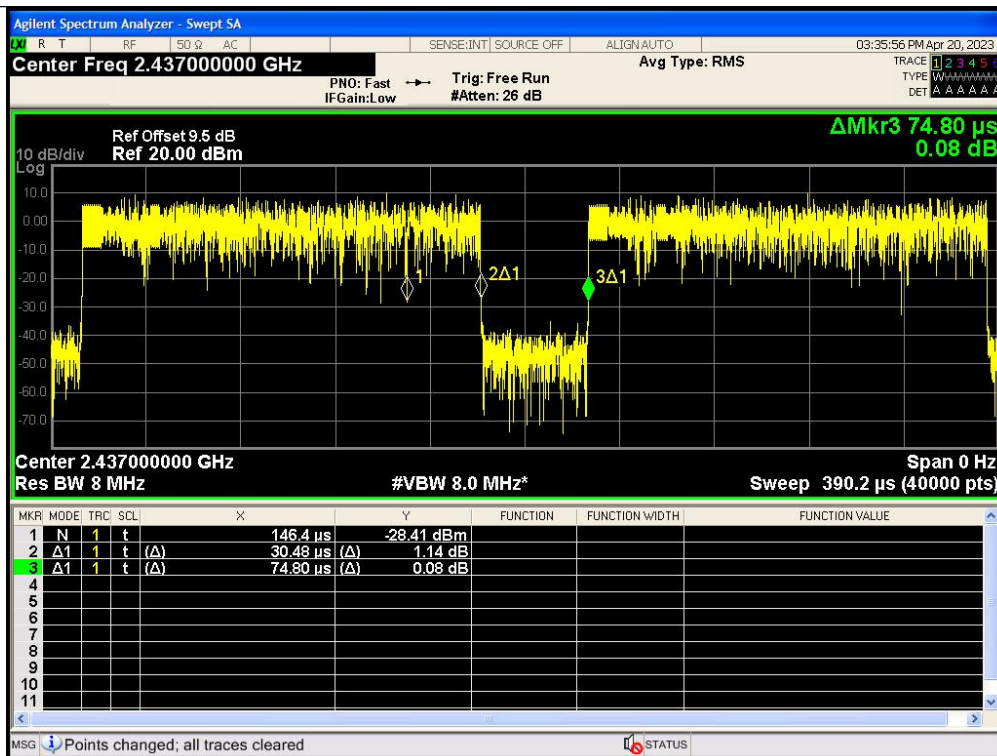

IEEE 802.11n 20MHz Channel 6

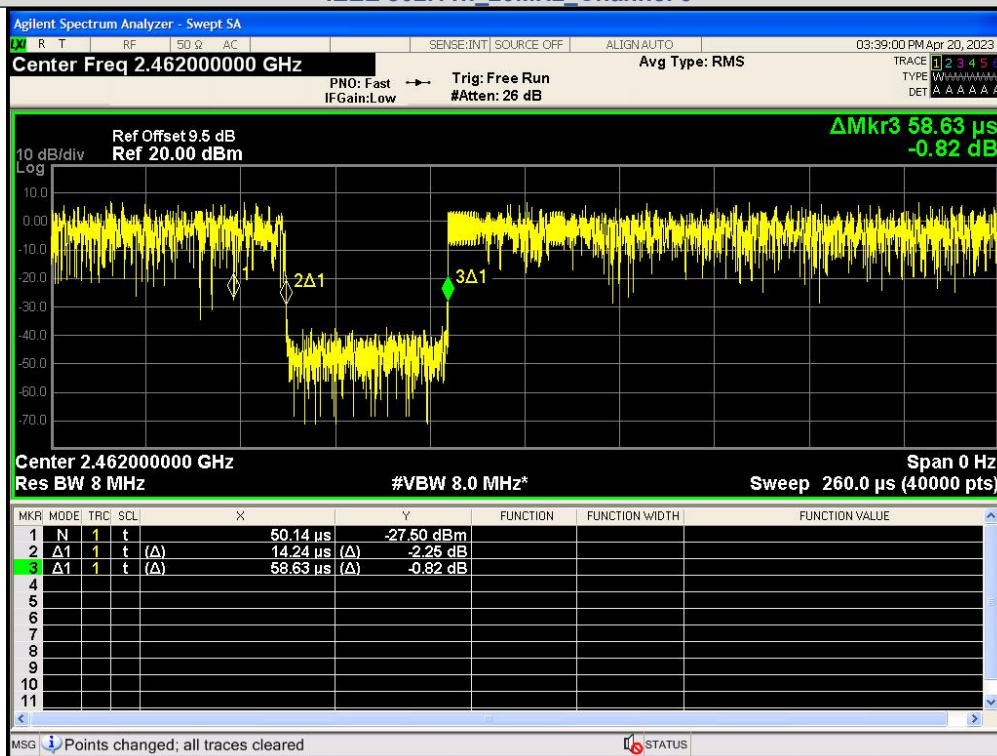

IEEE 802.11n 20MHz Channel 11

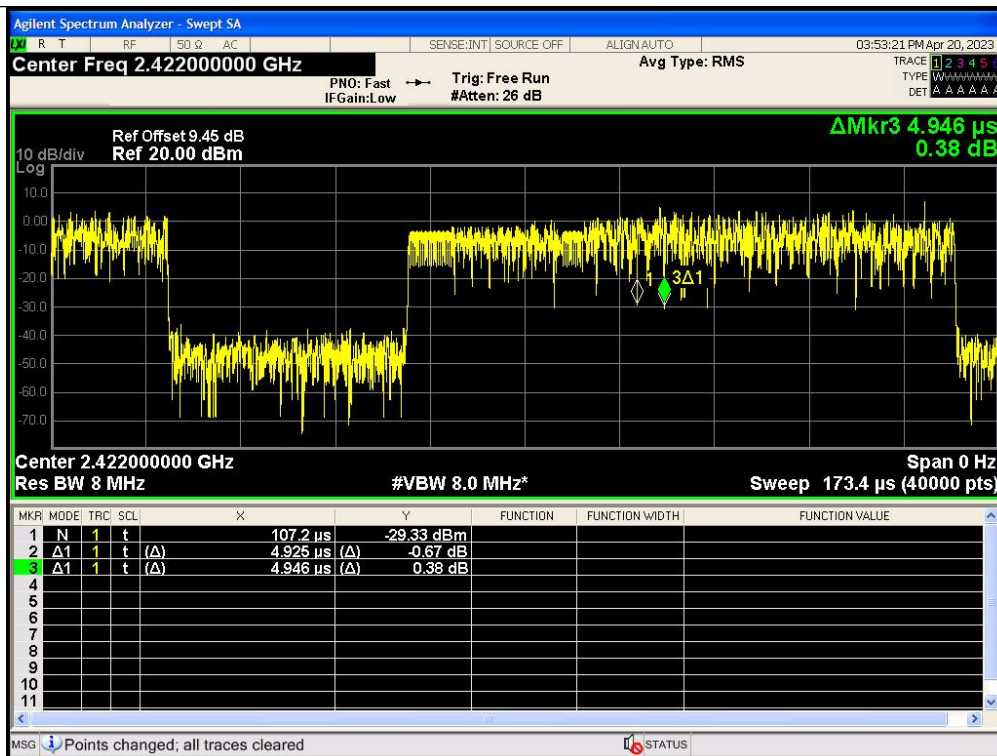

IEEE 802.11n_40MHz_Channel 3

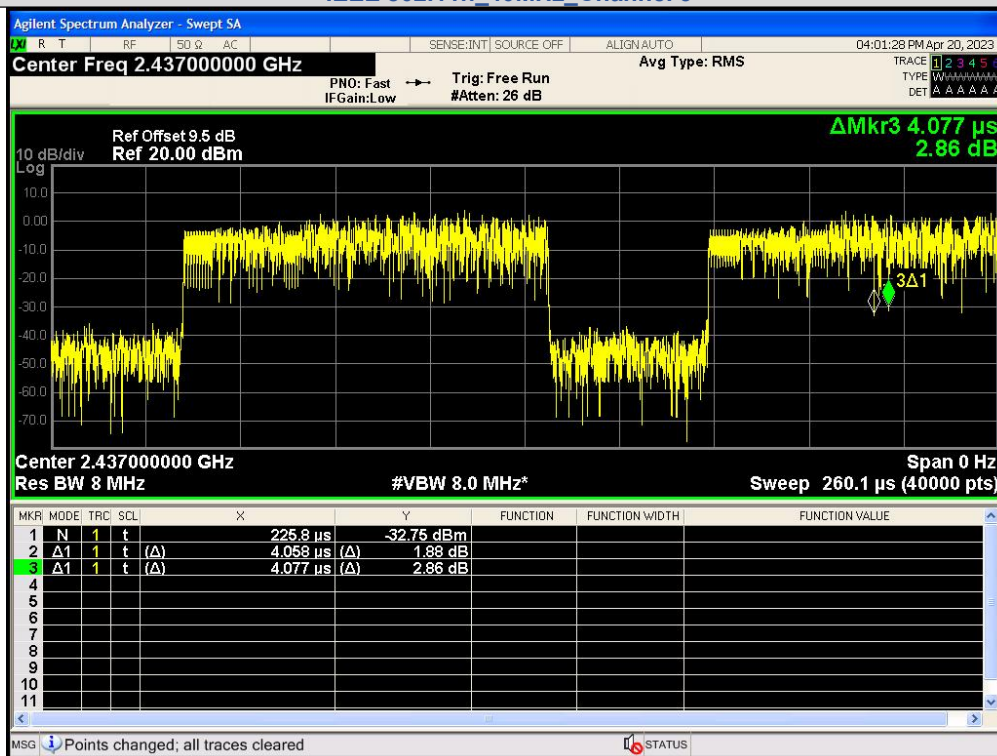

IEEE 802.11n_40MHz_Channel 6

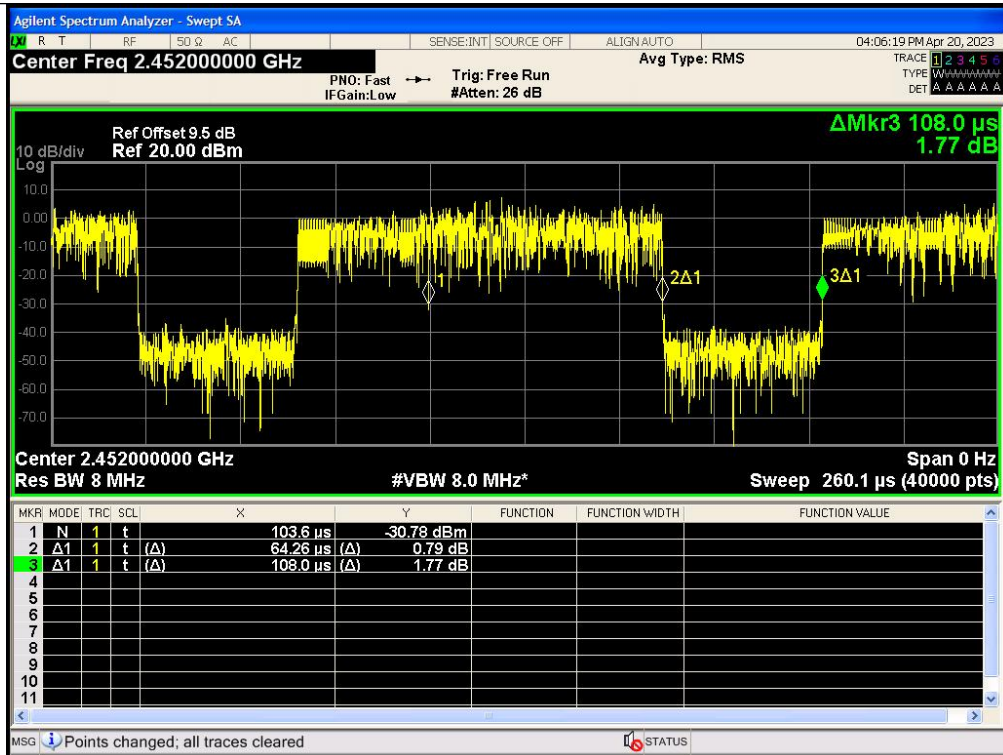

IEEE 802.11n_40MHz_Channel 9

APPENDIX VI. Power Spectral Density

Test Result

| Mode | Channel | PSD (dBm/3kHz) Ant. 0 | Limit (dBm/3kHz) | Result |
|-----------------|---------|--------------------------|------------------|--------|
| IEEE 802.11b | 1 | -20.747 | 8 | PASS |
| | 6 | -19.911 | | PASS |
| | 11 | -23.519 | | PASS |
| IEEE 802.11g | 1 | -20.835 | | PASS |
| | 6 | -21.744 | | PASS |
| | 11 | -22.521 | | PASS |
| IEEE 802.11n_20 | 1 | -21.114 | | PASS |
| | 6 | -21.433 | | PASS |
| | 11 | -21.467 | | PASS |
| IEEE 802.11n_40 | 3 | -22.369 | | PASS |
| | 6 | -23.234 | | PASS |
| | 9 | -23.171 | | PASS |

Test Graphs

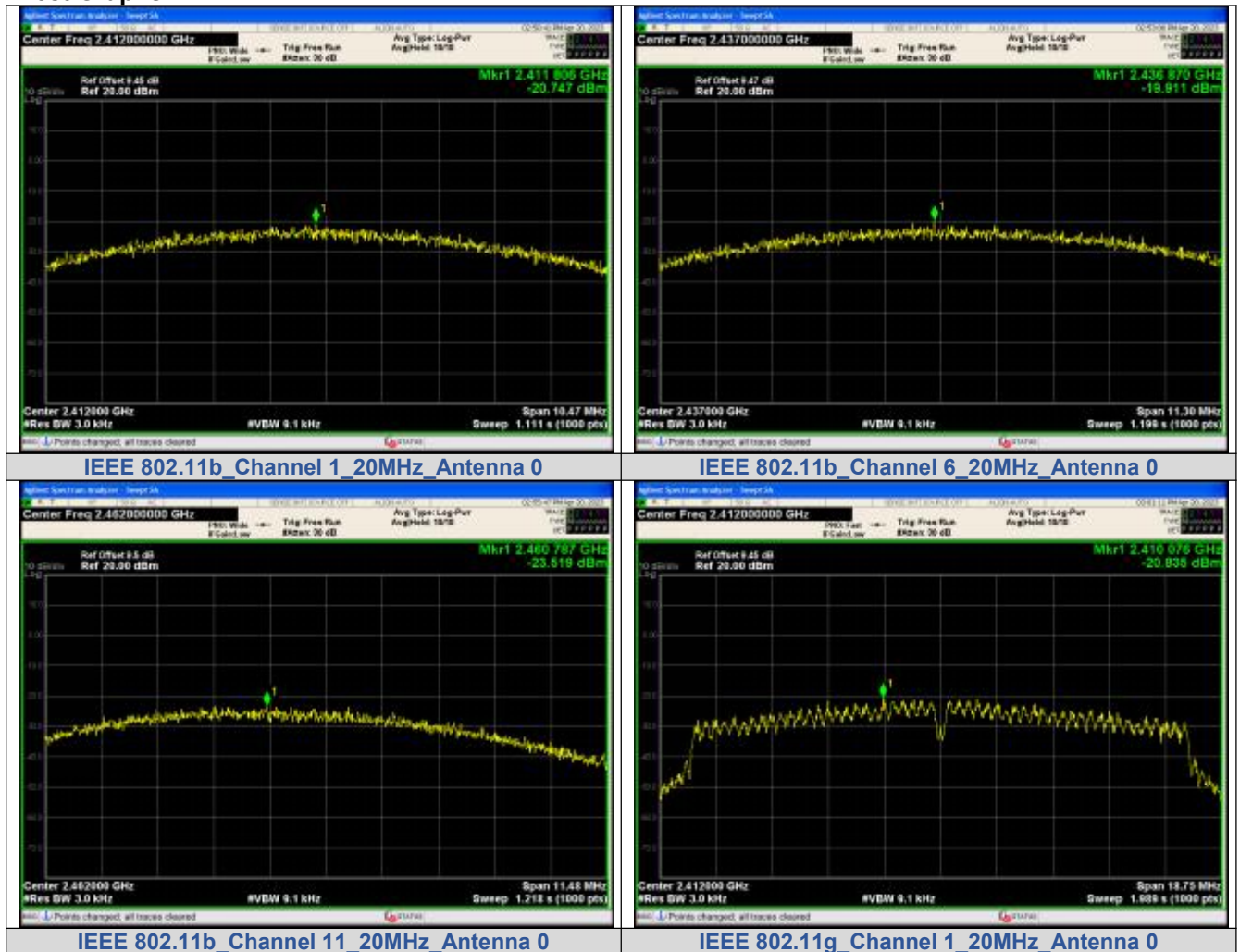

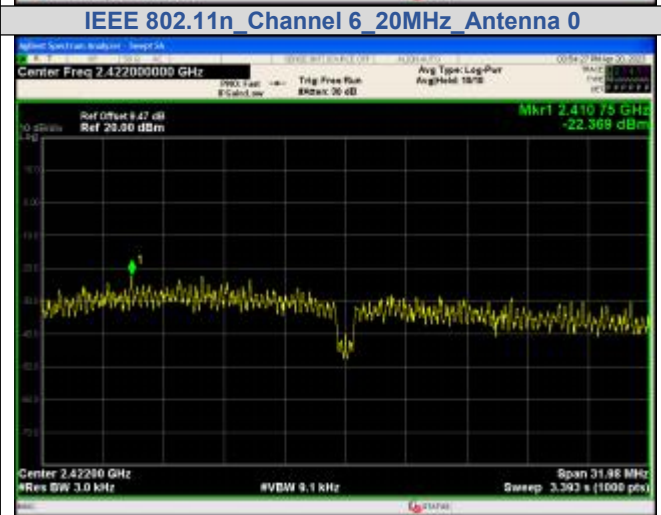
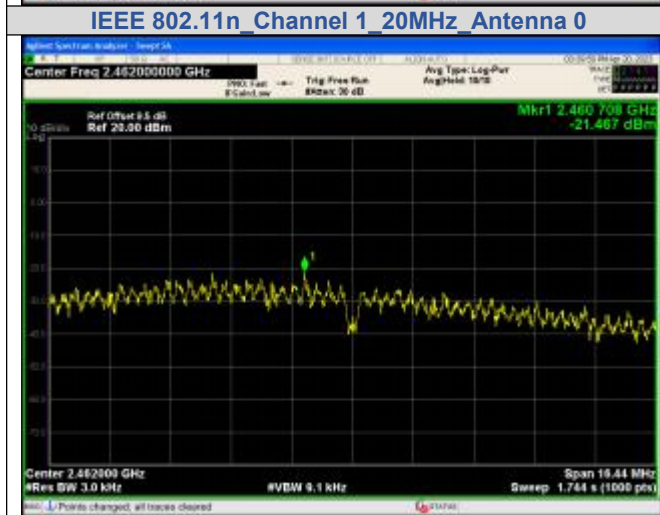
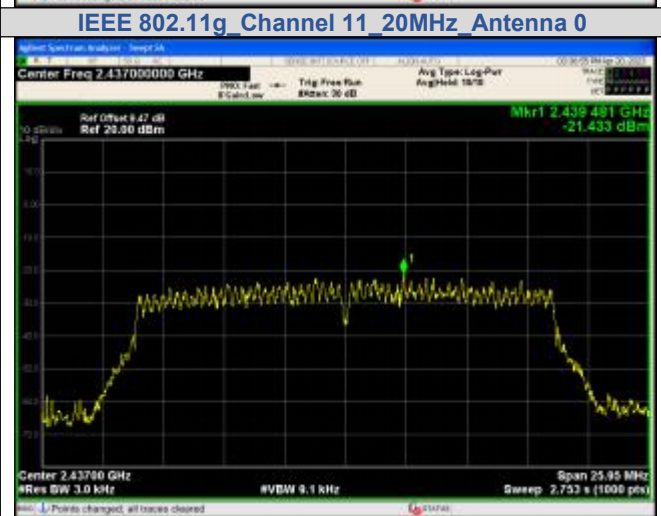
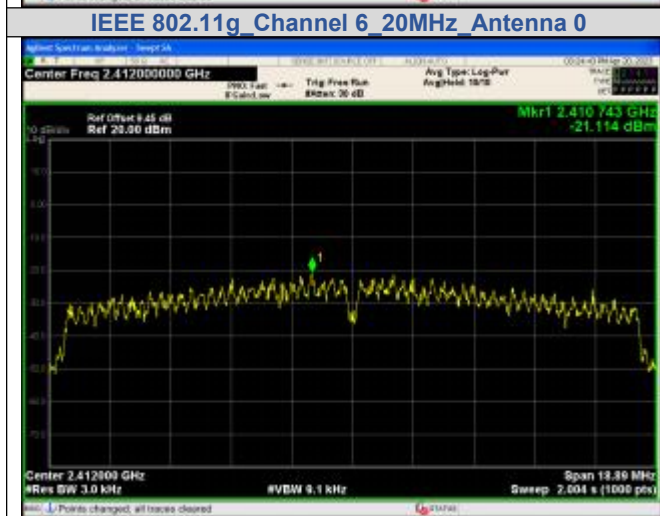
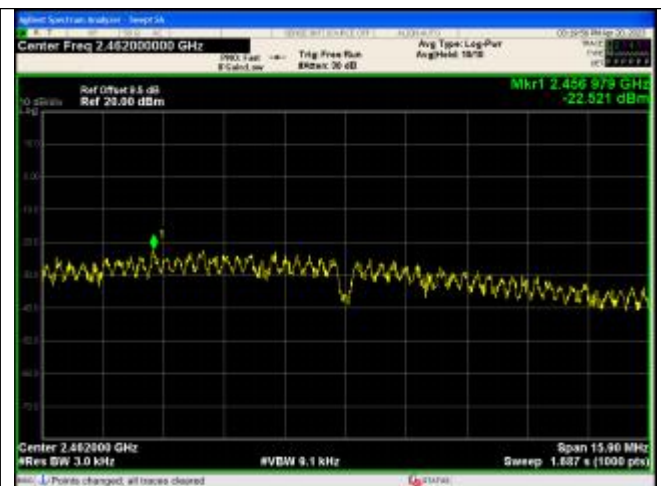

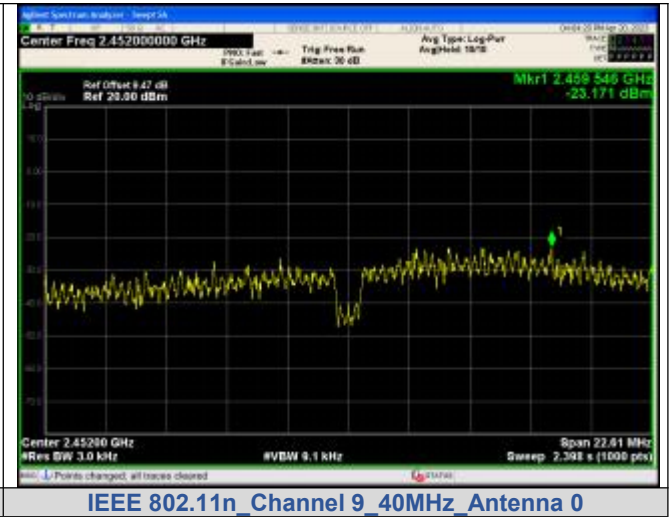
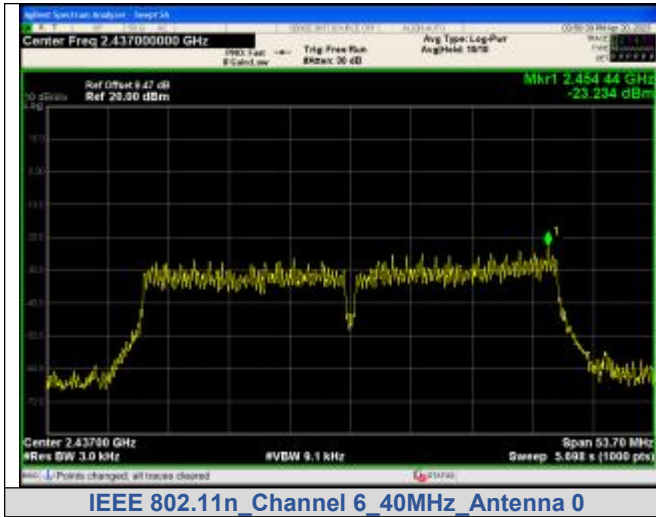

***** End of Report *****