



PHOTOS EXHIBIT

Report Number: R13337971-EP1

Applicant : Raspberry Pi (Trading) Ltd
Maurice Wilkes Building
Cowley Road
Cambridge
CB4 0DS
United Kingdom

Model : RPI-RM0 (Gamma)

FCC ID : 2ABCB-RPIRM0

IC : 20953-RPIRM0

EUT Description : Bluetooth and WiFi radio module

Test Standard(s) : FCC 47 CFR PART 15 SUBPART C
ISED RSS-247 ISSUE 2
ISED RSS-GEN ISSUE 5

Date Of Issue:
August 31, 2020

Prepared by:
UL LLC
12 Laboratory Dr.
Research Triangle Park, NC 27709 U.S.A.
TEL: (919) 549-1400

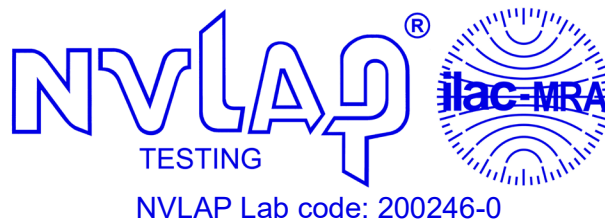

NVLAP Lab code: 200246-0

REPORT REVISION HISTORY

Rev.	Issue Date	Revisions	Revised By
V1	8/31/2020	Initial Issue	Cristian Melara
V2	10/26/2020	Added conducted emissions (mains) setup	Mike Antola

TABLE OF CONTENTS

REPORT REVISION HISTORY	2
TABLE OF CONTENTS	3
1. SETUP DIAGRAMS	4
2. SETUP PHOTOS.....	5

1. SETUP DIAGRAMS

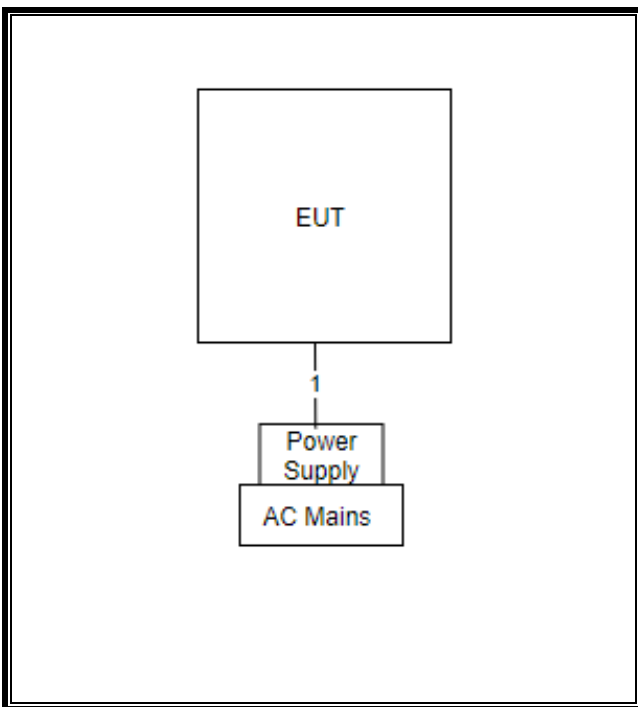

2. SETUP PHOTOS

RADIATED RF MEASUREMENT SETUP

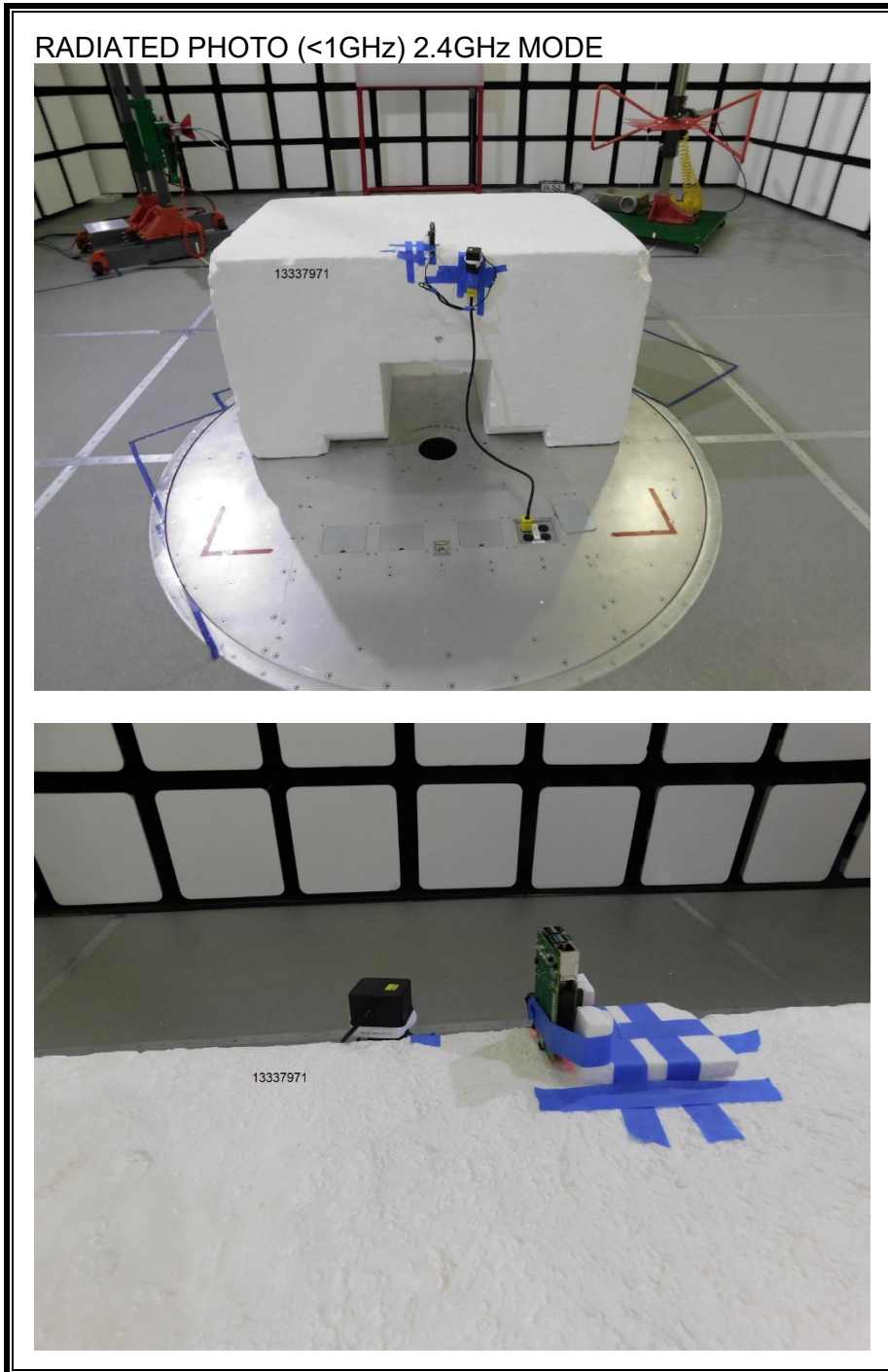

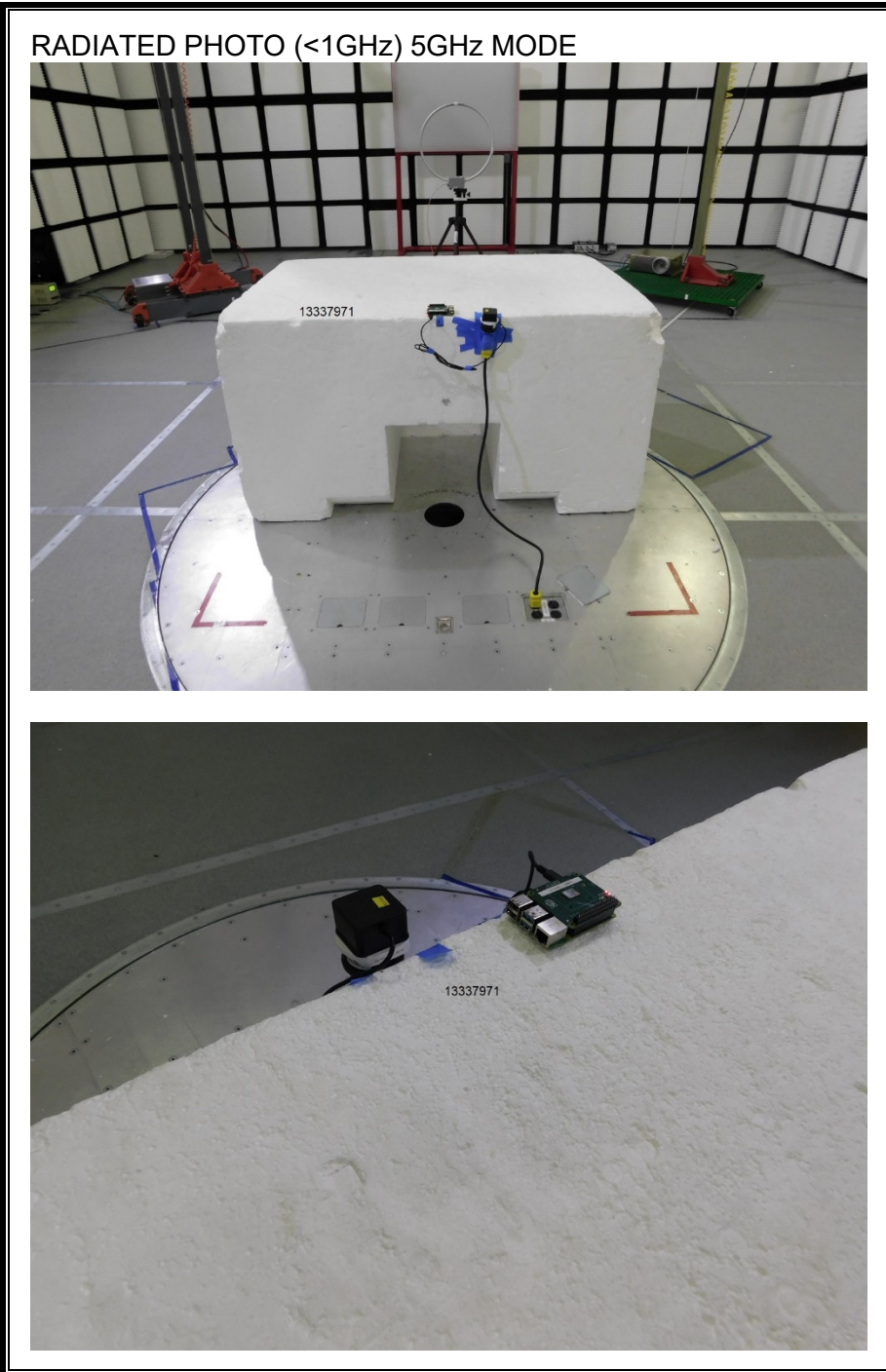





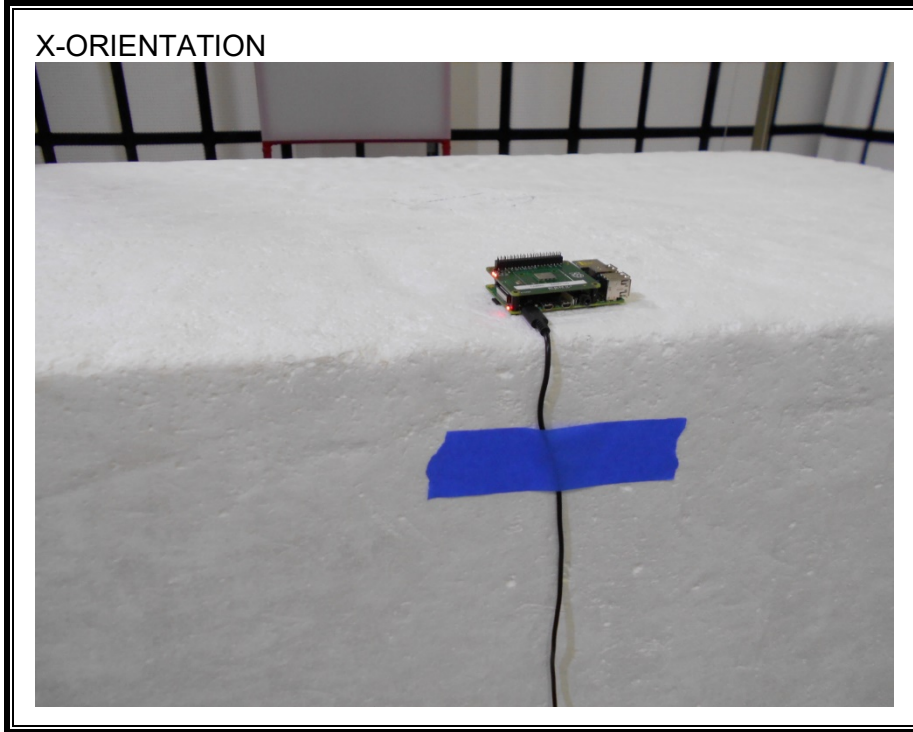

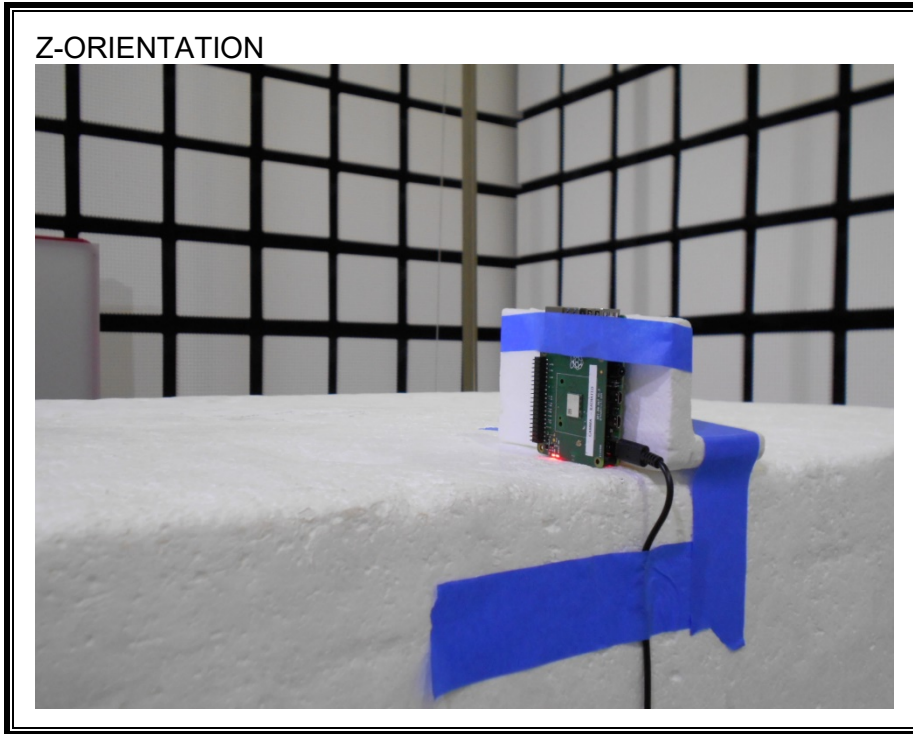

CONDUCTED EMISSIONS (MAINS) MEASUREMENT SETUP

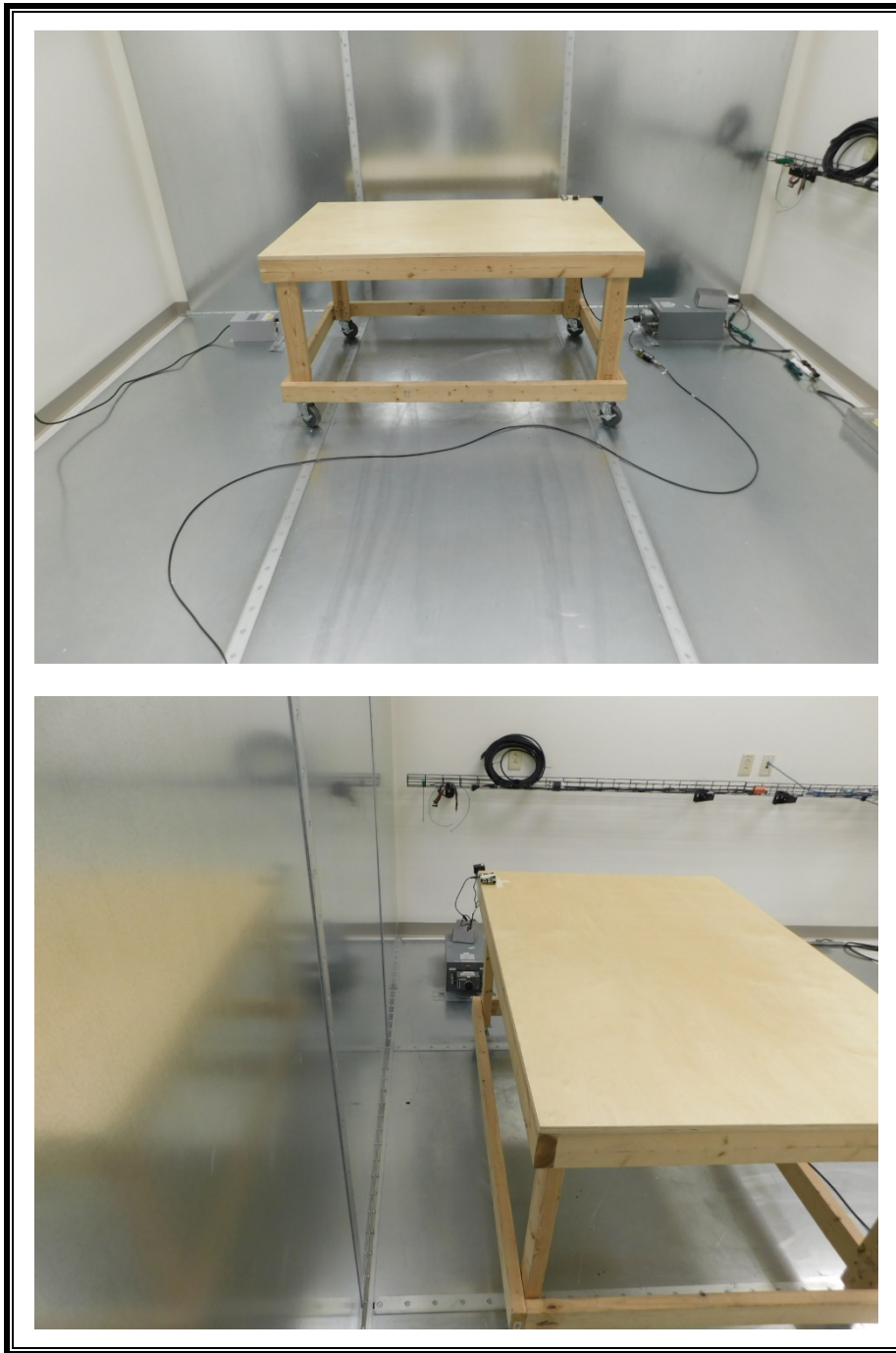

END OF PHOTOS EXHIBIT