



# TEST REPORT

**Test Report No. :** UL-RPT-RP12663640-1216A

**Customer** : Raspberry Pi (Trading) Ltd  
**Model No.** : Raspberry Pi 4 Model B  
**FCC ID** : 2ABCB-RPI4B  
**Technology** : *Bluetooth* – Basic Rate & EDR  
**Test Standard(s)** : FCC Parts 15.207, 15.209(a) & 15.247

**Test Laboratory** : UL VS LTD, Basingstoke, Hampshire, RG24 8AH, United Kingdom

1. This test report shall not be reproduced except in full, without the written approval of UL VS LTD.
2. The results in this report apply only to the sample(s) tested.
3. The sample tested is in compliance with the above standard(s).
4. The test results in this report are traceable to the national or international standards.
5. Version 1.0

**Date of Issue:** 10 May 2019

**Checked by:**   
Sarah Williams  
Senior Test Engineer, Radio Laboratory

**Company Signatory:**   
Ben Mercer  
Senior Test Engineer, Radio Laboratory  
UL VS LTD



The *Bluetooth*<sup>®</sup> word mark and logos are owned by the *Bluetooth* SIG, Inc. and any use of such marks by UL VS LTD is under licence. Other trademarks and trade names are those of their respective owners.

---

## UL VS LTD

Unit 1-3 Horizon, Kingsland Business Park, Wade Road, Basingstoke, Hampshire, RG24 8AH, UK  
Telephone: +44 (0)1256 312000  
Facsimile: +44 (0)1256 312001

**Customer Information**

<b>Company Name:</b>	Raspberry Pi (Trading) Ltd
<b>Address:</b>	Maurice Wilkes Building Cowley Road Cambridge CB4 0DS United Kingdom

**Report Revision History**

<b>Version Number</b>	<b>Issue Date</b>	<b>Revision Details</b>	<b>Revised By</b>
1.0	10/05/2019	Initial Version	Sarah Williams

## **Table of Contents**

<b>Customer Information.....</b>	<b>2</b>
<b>Report Revision History .....</b>	<b>2</b>
<b>1. Attestation of Test Results.....</b>	<b>4</b>
1.1. Description of EUT	4
1.2. General Information	4
1.3. Summary of Test Results	4
1.4. Deviations from the Test Specification	4
<b>2. Summary of Testing.....</b>	<b>5</b>
2.1. Facilities and Accreditation	5
2.2. Methods and Procedures	5
2.3. Calibration and Uncertainty	6
2.4. Test and Measurement Equipment	7
<b>3. Equipment Under Test (EUT) .....</b>	<b>9</b>
3.1. Identification of Equipment Under Test (EUT)	9
3.2. Modifications Incorporated in the EUT	9
3.3. Additional Information Related to Testing	10
3.4. Description of Available Antennas	10
3.5. Description of Test Setup	11
<b>4. Antenna Port Test Results .....</b>	<b>19</b>
4.1. Transmitter 20 dB Bandwidth	19
4.2. Transmitter Carrier Frequency Separation	23
4.3. Transmitter Number of Hopping Frequencies and Average Time of Occupancy	27
4.4. Transmitter Maximum Peak Output Power	29
<b>5. Radiated Test Results.....</b>	<b>36</b>
5.1. Transmitter Radiated Emissions <1 GHz	36
5.2. Transmitter Radiated Emissions >1 GHz	38
5.3. Transmitter Band Edge Radiated Emissions	41
<b>6. AC Power Line Conducted Emissions Test Results.....</b>	<b>54</b>
6.1. Transmitter AC Conducted Spurious Emissions	54

## 1. Attestation of Test Results









### 1.1. Description of EUT

The Equipment Under Test was a single board computer. It contains a *Bluetooth*, 2.4 GHz and 5 GHz WLAN module powered from an AC/DC power supply. The antenna is integral.

### 1.2. General Information

<b>Specification Reference:</b>	47CFR15.247
<b>Specification Title:</b>	Code of Federal Regulations Volume 47 (Telecommunications): Part 15 Subpart C (Intentional Radiators) - Section 15.247
<b>Specification Reference:</b>	47CFR15.207 and 47CFR15.209
<b>Specification Title:</b>	Code of Federal Regulations Volume 47 (Telecommunications): Part 15 Subpart C (Intentional Radiators) - Sections 15.207 and 15.209
<b>Site Registration:</b>	621311
<b>Location of Testing:</b>	UL VS LTD, Unit 3 Horizon, Wade Road, Kingsland Business Park, Basingstoke, Hampshire, RG24 8AH, United Kingdom
<b>Test Dates:</b>	10 April 2019 to 23 April 2019

### 1.3. Summary of Test Results

FCC Reference (47CFR)	Measurement	Result
Part 15.247(a)(1)	Transmitter 20 dB Bandwidth	
Part 15.247(a)(1)	Transmitter Carrier Frequency Separation	
Part 15.247(a)(1)(iii)	Transmitter Number of Hopping Frequencies and Average Time of Occupancy	
Part 15.247(b)(1)	Transmitter Maximum Peak Output Power	
Part 15.247(d) & 15.209(a)	Transmitter Radiated Emissions	
Part 15.247(d) & 15.209(a)	Transmitter Band Edge Radiated Emissions	
Part 15.207	Transmitter AC Conducted Emissions	
<b>Key to Results</b>		
 = Complied  = Did not comply		

### 1.4. Deviations from the Test Specification

For the measurements contained within this test report, there were no deviations from, additions to, or exclusions from the test specification identified above.

## **2. Summary of Testing**

### **2.1. Facilities and Accreditation**

The test site and measurement facilities used to collect data are located at Unit 3 Horizon, Wade Road, Kingsland Business Park, Basingstoke, Hampshire, RG24 8AH, United Kingdom. The following table identifies which facilities were utilised for radiated emission measurements documented in this report. Specific facilities are also identified in the test results sections.

Site 1	X
Site 2	
Site 17	

UL VS LTD is accredited by UKAS. The tests reported herein have been performed in accordance with its terms of accreditation.

### **2.2. Methods and Procedures**

<b>Reference:</b>	ANSI C63.10-2013
<b>Title:</b>	American National Standard of Procedures for Compliance Testing of Unlicensed Wireless Devices
<b>Reference:</b>	KDB 558074 D01 15.247 Meas Guidance v05r02, April 2, 2019
<b>Title:</b>	Guidance for Compliance Measurements on Digital Transmission System, Frequency Hopping Spread Spectrum System, and Hybrid System Devices Operating Under Section 15.247 of the FCC Rules
<b>Reference:</b>	KDB 174176 D01 Line Conducted FAQ v01r01 June 3, 2015
<b>Title:</b>	AC Power-Line Conducted Emissions Frequently Asked Questions

## **2.3. Calibration and Uncertainty**

### **Measuring Instrument Calibration**

In accordance with UKAS requirements all the measurement equipment is on a calibration schedule. All equipment was within the calibration period on the date of testing.

### **Measurement Uncertainty**

No measurement or test can ever be perfect and the imperfections give rise to error of measurement in the results. Consequently the result of a measurement is only an approximation to the value measured (the specific quantity subject to measurement) and is only complete when accompanied by a statement of the uncertainty of the approximation.

The expression of uncertainty of a measurement result allows realistic comparison of results with reference values and limits given in specifications and standards.

The uncertainty of the result may need to be taken into account when interpreting the measurement results.

The reported expanded uncertainties below are based on a standard uncertainty multiplied by an appropriate coverage factor such that a confidence level of approximately 95% is maintained. For the purposes of this document "approximately" is interpreted as meaning "effectively" or "for most practical purposes".

<b>Measurement Type</b>	<b>Range</b>	<b>Confidence Level (%)</b>	<b>Calculated Uncertainty</b>
20 dB Bandwidth	2.4 GHz to 2.4835 GHz	95%	±4.59 %
Carrier Frequency Separation	2.4 GHz to 2.4835 GHz	95%	±4.59 %
Average Time of Occupancy	2.4 GHz to 2.4835 GHz	95%	±3.53 ns
Conducted Maximum Peak Output Power	2.4 GHz to 2.4835 GHz	95%	±1.13 dB
Radiated Spurious Emissions	30 MHz to 1 GHz	95%	±4.65 dB
Radiated Spurious Emissions	1 GHz to 26.5 GHz	95%	±2.94 dB
AC Conducted Spurious Emissions	0.15 MHz to 30 MHz	95%	±2.40 dB

The methods used to calculate the above uncertainties are in line with those recommended within the various measurement specifications. Where measurement specifications do not include guidelines for the evaluation of measurement uncertainty the published guidance of the appropriate accreditation body is followed.

## **2.4. Test and Measurement Equipment**

### **Test Equipment Used for Transmitter Conducted Tests**

<b>Asset No.</b>	<b>Instrument</b>	<b>Manufacturer</b>	<b>Type No.</b>	<b>Serial No.</b>	<b>Date Calibration Due</b>	<b>Cal. Interval (Months)</b>
M2039	Thermohygrometer	Testo	608-H1	45124922	06 Jan 2020	12
M1794	Spectrum Analyser	Rohde & Schwarz	FSU26	100027	18 Mar 2021	24
A2508	Attenuator	AtlanTecRF	AN18-10	821846#3	Calibrated before use	-
M199	Power Meter	Rohde & Schwarz	NRVS	827023/075	20 Apr 2020	24
M1267	Power Sensor	Rohde & Schwarz	NRV-Z52	100155	20 Apr 2020	24
G0615	Signal Generator	Rohde & Schwarz	SMBV100A	260473	08 May 2020	36

### **Test Equipment Used for Transmitter Radiated Emissions**

<b>Asset No.</b>	<b>Instrument</b>	<b>Manufacturer</b>	<b>Type No.</b>	<b>Serial No.</b>	<b>Date Calibration Due</b>	<b>Cal. Interval (Months)</b>
M2040	Thermohygrometer	Testo	608-H1	45124934	06 Jan 2020	12
K0001	5m RSE Chamber	Rainford EMC	N/A	N/A	04 Oct 2019	12
M2044	Test Receiver	Rohde & Schwarz	ESU26	100122	01 Apr 2020	12
A3154	Pre-Amplifier	Com-Power	PAM-103	18020012	14 Sep 2019	12
A3155	Pre Amplifier	Com-Power	PAM-118A	18040037	14 Sep 2019	12
A3141	Pre Amplifier	Schwarzbeck	BBV 9718 B	00021	21 Nov 2019	12
A2896	Pre Amplifier	Schwarzbeck	BBV 9721	9721 – 023	08 Feb 2020	12
A553	Antenna	Chase	CBL6111A	1593	08 Oct 2019	12
A3138	Antenna	Schwarzbeck	BBHA 9120 B	00702	03 Oct 2019	12
A3139	Antenna	Schwarzbeck	HWRD750	00027	04 Oct 2019	12
A2895	Antenna	Schwarzbeck	BBHA 9170	9170-728	08 Feb 2020	12
A2523	Attenuator	AtlanTechRF	AN18W5-10	832827#1	04 Mar 2020	12
A3093	High Pass Filter	AtlanTechRF	AFH-03000	18051800077	09 Apr 2020	12
A3095	High Pass Filter	AtlanTechRF	AFH-07000	18051600012	09 Apr 2020	12
A3085	Low Pass Filter	AtlanTechRF	ALH-02000	18051600014	09 Apr 2020	12

**Test and Measurement Equipment (continued)****Test Equipment Used for Transmitter Band Edge Radiated Emissions**

Asset No.	Instrument	Manufacturer	Type No.	Serial No.	Date Calibration Due	Cal. Interval (Months)
M2040	Thermohygrometer	Testo	608-H1	45124934	06 Jan 2020	12
K0001	5m RSE Chamber	Rainford EMC	N/A	N/A	04 Oct 2019	12
M2044	Test Receiver	Rohde & Schwarz	ESU26	100122	17 Apr 2019	12
A3155	Pre-Amplifier	Com-Power	PAM-118A	18040037	14 Sep 2019	12
A3138	Antenna	Schwarzbeck	BBHA 9120 B	00702	03 Oct 2019	12
A2924	Attenuator	AtlanTechRF	AN18W5-20	832828#7	04 Mar 2020	12

**Test Equipment Used for Transmitter AC Conducted Emissions**

Asset No.	Instrument	Manufacturer	Type No.	Serial No.	Date Calibration Due	Cal. Interval (Months)
M2037	Thermohygrometer	Testo	608-H1	45124925	06 Jan 2020	12
A649	LISN	Rohde & Schwarz	ESH3-Z5	825562/008	23 Aug 2019	12
A1830	Pulse Limiter	Rohde & Schwarz	ESH3-Z2	100668	10 Apr 2020	12
M1273	Test Receiver	Rohde & Schwarz	ESIB 26	100275	18 Dec 2019	12



### **3. Equipment Under Test (EUT)**

#### **3.1. Identification of Equipment Under Test (EUT)**

<b>Brand Name:</b>	Raspberry Pi
<b>Model Name or Number:</b>	Raspberry Pi 4 Model B
<b>Test Sample Serial Number:</b>	0000000020d6f686 ( <i>Conducted sample #1</i> )
<b>Hardware Version:</b>	V1.0
<b>Software Version:</b>	V1.0
<b>FCC ID:</b>	2ABCB-RPI4B

<b>Brand Name:</b>	Raspberry Pi
<b>Model Name or Number:</b>	Raspberry Pi 4 Model B
<b>Test Sample Serial Number:</b>	000000003f9edf4a ( <i>Radiated sample #1</i> )
<b>Hardware Version:</b>	V1.0
<b>Software Version:</b>	V1.0
<b>FCC ID:</b>	2ABCB-RPI4B

<b>Brand Name:</b>	Raspberry Pi
<b>Model Name or Number:</b>	Raspberry Pi 4 Model B
<b>Test Sample Serial Number:</b>	0000000027a0c96b ( <i>Radiated sample #2</i> )
<b>Hardware Version:</b>	V1.0
<b>Software Version:</b>	V1.0
<b>FCC ID:</b>	2ABCB-RPI4B

#### **3.2. Modifications Incorporated in the EUT**

No modifications were applied to the EUT during testing.

**3.3. Additional Information Related to Testing**

<b>Tested Technology:</b>	<i>Bluetooth</i>		
<b>Power Supply Requirement:</b>	Nominal	5.0 VDC	
<b>Type of Unit:</b>	Transceiver		
<b>Channel Spacing:</b>	1 MHz		
<b>Mode:</b>	Basic Rate	Enhanced Data Rate	
<b>Modulation:</b>	GFSK	$\pi/4$ -DQPSK	8DPSK
<b>Packet Type: (Maximum Payload)</b>	DH5	2DH5	3DH5
<b>Data Rate (Mbps):</b>	1	2	3
<b>Maximum Conducted Output Power:</b>	4.9 dBm		
<b>Transmit Frequency Range:</b>	2402 MHz to 2480 MHz		
<b>Transmit Channels Tested:</b>	<b>Channel ID</b>	<b>Channel Number</b>	<b>Channel Frequency (MHz)</b>
	Bottom	0	2402
	Middle	39	2441
	Top	78	2480

**3.4. Description of Available Antennas**

The radio utilizes an integrated antenna, with the following maximum gain:

Frequency Range (MHz)	Antenna Gain (dBi)
2400-2480	3.5

### **3.5. Description of Test Setup**

#### **Support Equipment**

The following support equipment was used to exercise the EUT during testing:

<b>Description:</b>	LCD Monitor
<b>Brand Name:</b>	Logik
<b>Model Name or Number:</b>	L22FE12A
<b>Serial Number:</b>	1309020661

<b>Description:</b>	USB Mouse
<b>Brand Name:</b>	Raspberry Pi
<b>Model Name or Number:</b>	RPI-MOUSE
<b>Serial Number:</b>	Not marked or stated

<b>Description:</b>	USB Keyboard
<b>Brand Name:</b>	Raspberry Pi
<b>Model Name or Number:</b>	RPI-KYB
<b>Serial Number:</b>	Not marked or stated

<b>Description:</b>	Power Supply. 100-230 VAC Input / 5 VDC output
<b>Brand Name:</b>	Belkin
<b>Model Name or Number:</b>	F7U011dr
<b>Serial Number:</b>	Not marked or stated

<b>Description:</b>	16 GB Micro SD card
<b>Brand Name:</b>	SanDisk
<b>Model Name or Number:</b>	HCI
<b>Serial Number:</b>	Not marked or stated

<b>Description:</b>	HDMI Cable Type A to Type D. Quantity 1. Length 1.05 metres
<b>Brand Name:</b>	Not marked or stated
<b>Model Name or Number:</b>	Not marked or stated
<b>Serial Number:</b>	Not marked or stated

<b>Description:</b>	Ethernet cable. Quantity 1. Length 1.0 metres
<b>Brand Name:</b>	Not marked or stated
<b>Model Name or Number:</b>	Not marked or stated
<b>Serial Number:</b>	Not marked or stated

**Support Equipment (continued)**

<b>Description:</b>	USB cable. Quantity 3. Length 3.0 metres
<b>Brand Name:</b>	Not marked or stated
<b>Model Name or Number:</b>	Not marked or stated
<b>Serial Number:</b>	Not marked or stated

<b>Description:</b>	USB Hub
<b>Brand Name:</b>	Hama
<b>Model Name or Number:</b>	00078498
<b>Serial Number:</b>	09825891600

<b>Description:</b>	Ethernet Router
<b>Brand Name:</b>	Netgear
<b>Model Name or Number:</b>	GS605
<b>Serial Number:</b>	1YG194390218E

<b>Description:</b>	HDMI Hub
<b>Brand Name:</b>	Sumvision
<b>Model Name or Number:</b>	Cyclone Micro
<b>Serial Number:</b>	SUM091104017

<b>Description:</b>	Cat 5 Ethernet Cable. Quantity 1. Length 2.0 metres
<b>Brand Name:</b>	AWN
<b>Model Name or Number:</b>	2835
<b>Serial Number:</b>	E87647

<b>Description:</b>	Test Laptop
<b>Brand Name:</b>	Lenovo
<b>Model Name or Number:</b>	L440
<b>Serial Number:</b>	R9-019EA1 14/04

<b>Description:</b>	Generic Headphones (ear buds)
<b>Brand Name:</b>	Not marked or stated
<b>Model Name or Number:</b>	Not marked or stated
<b>Serial Number:</b>	Not marked or stated

**Support Equipment (continued)**

<b>Description:</b>	USB Thumb Drive
<b>Brand Name:</b>	Sandisk
<b>Model Name or Number:</b>	Ultra flair USB 3.0
<b>Serial Number:</b>	BM182025896Z

<b>Description:</b>	USB Thumb Drive
<b>Brand Name:</b>	Sandisk
<b>Model Name or Number:</b>	Ultra flair USB 3.0
<b>Serial Number:</b>	BM190125896Z

## **Operating Modes**

The EUT was tested in the following operating mode(s):

- Continuously transmitting at maximum power on bottom, middle and top channels in Basic Rate (DH5 packets) or EDR (2DH5 or 3DH5 packets) as required.
- Continuously transmitting at maximum power in hopping mode on all channels in Basic Rate (DH5 packets) or EDR (2DH5 or 3DH5 packets) as required.

## **Configuration and Peripherals**

The EUT was tested in the following configuration(s):

- The customer's test application and supplied instructions were used to place the EUT into *Bluetooth* test mode. The supplied commands were entered into the console menu on the EUT. Test commands stated in the `bt_testing.sh` file located on the `/home/pi` drive of the EUT were used to configure the EUT to enable a continuous transmission and to select the test channels as required.
- The EUT was powered via an AC/DC switch mode power supply.
- Both EDR/Basic rate modes were compared and tests were performed with the mode that presented the worst case result. For output power, bandwidth, band edge and channel separation, all modes were tested.
- AC conducted emissions test was tested with the EUT transmitting on the Middle channel using DH5 packet type, as this mode was found to transmit the highest power.
- Radiated spurious emissions were performed with the EUT in the Y plane (worst case) while connected to its power supply. Tests were performed with the EUT connected to its AC adaptor and USB cable. All other ports were terminated with suitable terminations.
- The LCD monitor was connected to the EUT using a 1.05 metre long HDMI cable.
- The keyboard and mouse were connected to the USB port on the EUT.

**Test Setup Diagrams**

**Conducted Tests:**

**Test Setup for Transmitter 20 dB Bandwidth, Carrier Frequency Separation, Number of Hopping Frequencies and Average Time of Occupancy & Maximum Peak Output Power**

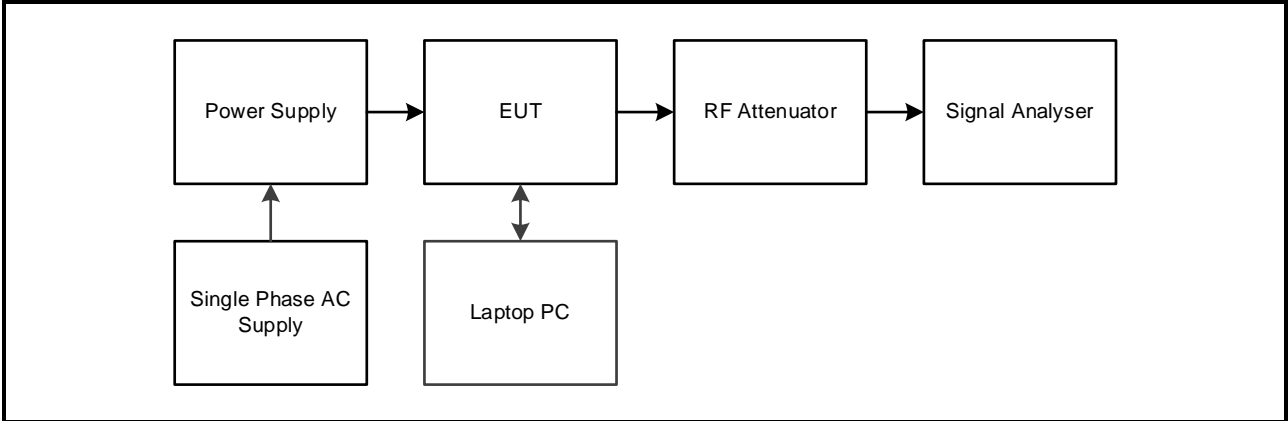

**Test Setup Diagrams (continued)**

**Radiated Tests:**

**Test Setup for Transmitter Radiated Emissions**

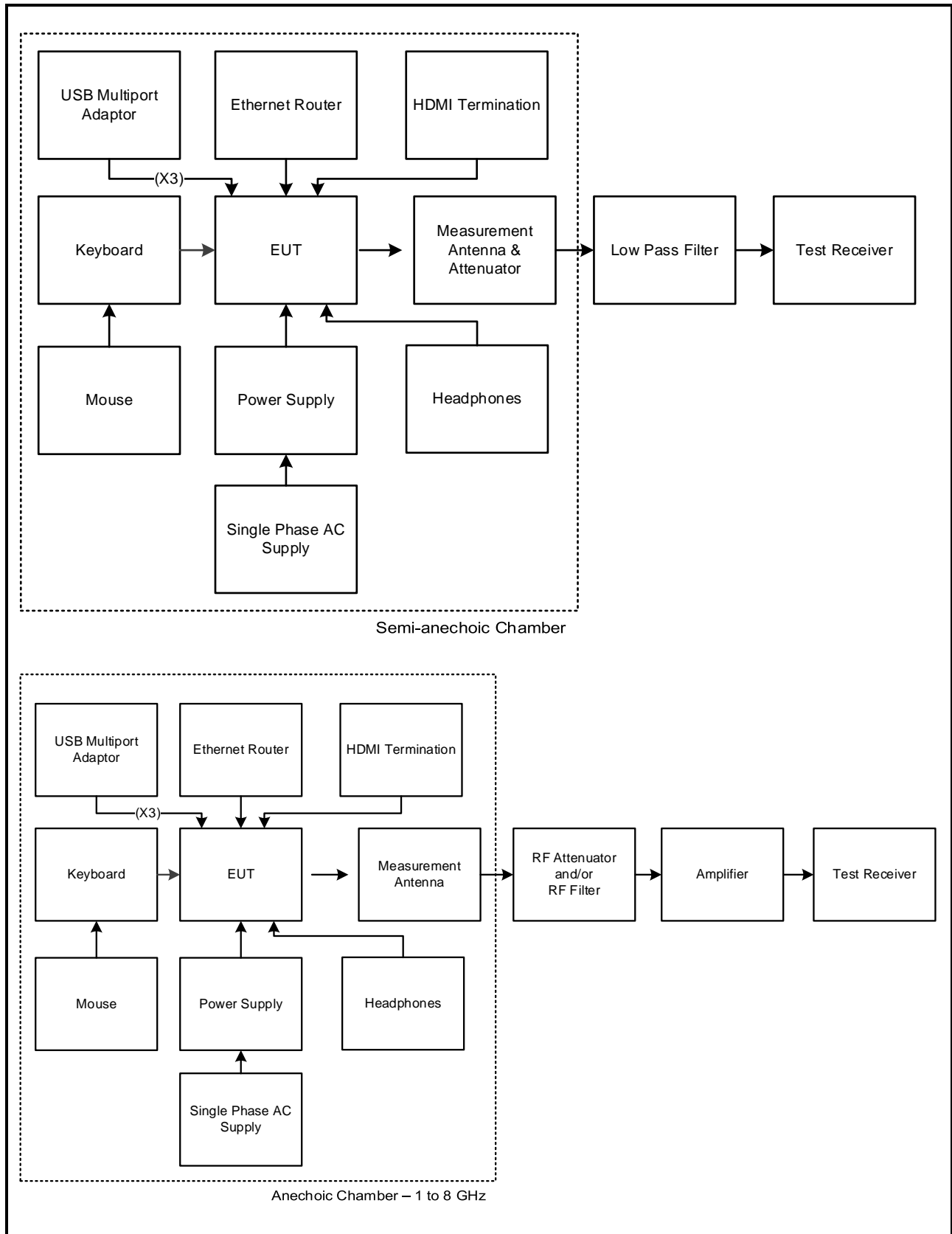



**Test Setup Diagrams (continued)**

**Test setup for radiated measurements (continued):**

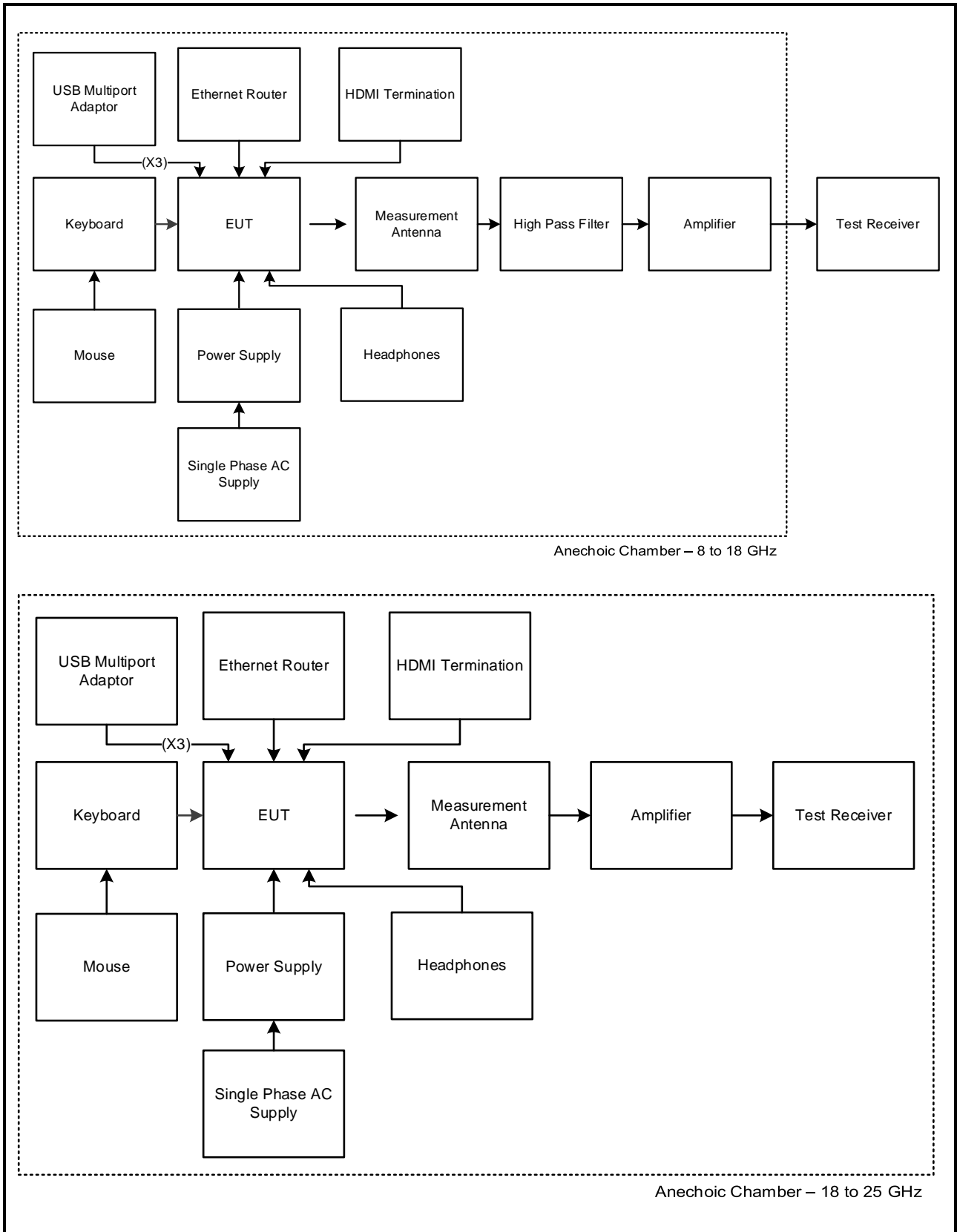

**Test Setup Diagrams (continued)**

**Test Setup for Transmitter AC Conducted Emissions**

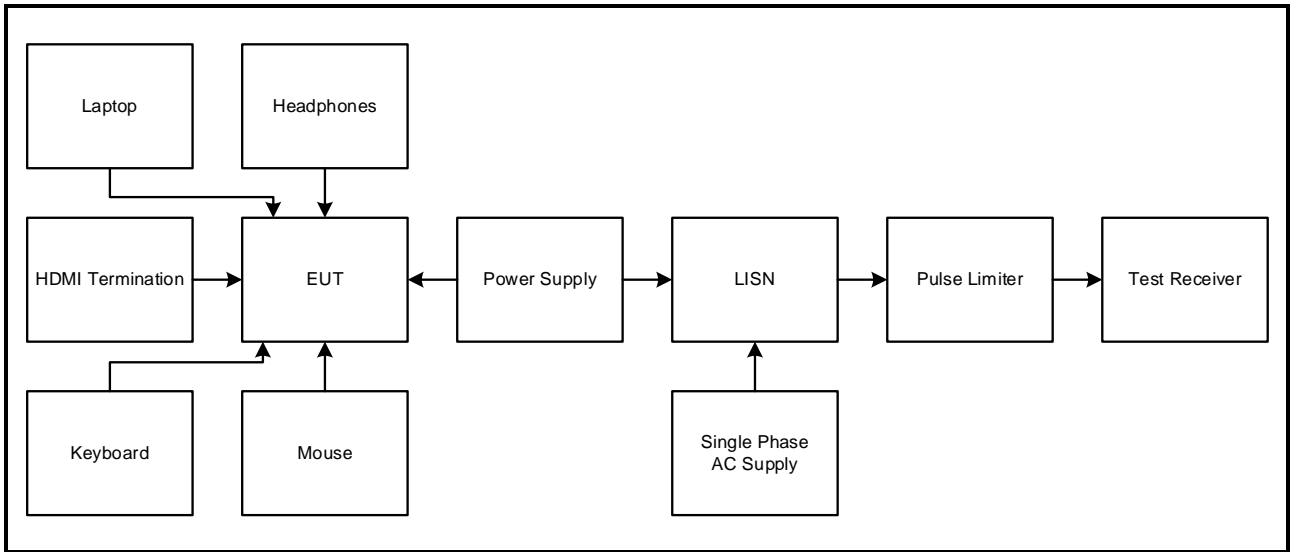

## **4. Antenna Port Test Results**

### **4.1. Transmitter 20 dB Bandwidth**

#### **Test Summary:**

<b>Test Engineers:</b>	Victor Carmon & Matthew Botfield	<b>Test Date:</b>	16 April 2019
<b>Test Sample Serial Number:</b>	0000000020d6f686		

<b>FCC Reference:</b>	Part 15.247(a)(1)
<b>Test Method Used:</b>	ANSI C63.10 Section 6.9.2

#### **Environmental Conditions:**

<b>Temperature (°C):</b>	22
<b>Relative Humidity (%):</b>	43

#### **Note(s):**

1. The spectrum analyser resolution bandwidth was set to 30 kHz and video bandwidth 100 kHz. A peak detector was used, sweep time was set to auto and the trace mode was Max Hold. The span was set to 3 MHz. Normal and delta markers were placed 20 dB down from the peak of the carrier.
2. The spectrum analyser was connected to the RF port on the EUT using suitable attenuation and RF cable.

**Transmitter 20 dB Bandwidth (continued)**

**Results DH5:**

Channel	20 dB Bandwidth (kHz)
Bottom	1009.615
Middle	1004.368
Top	1009.698

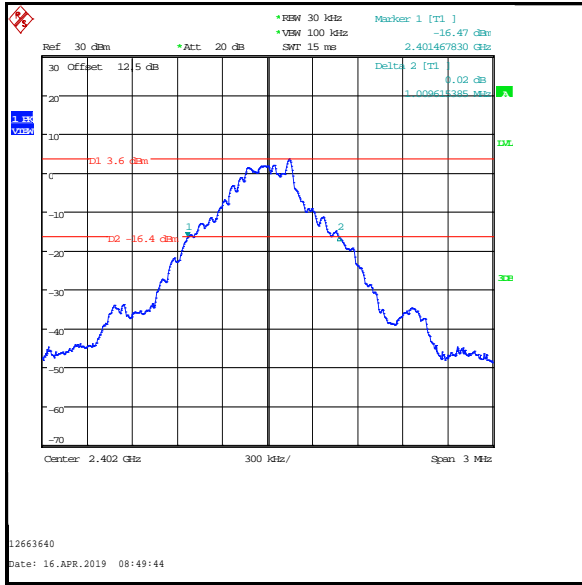

**Bottom Channel**

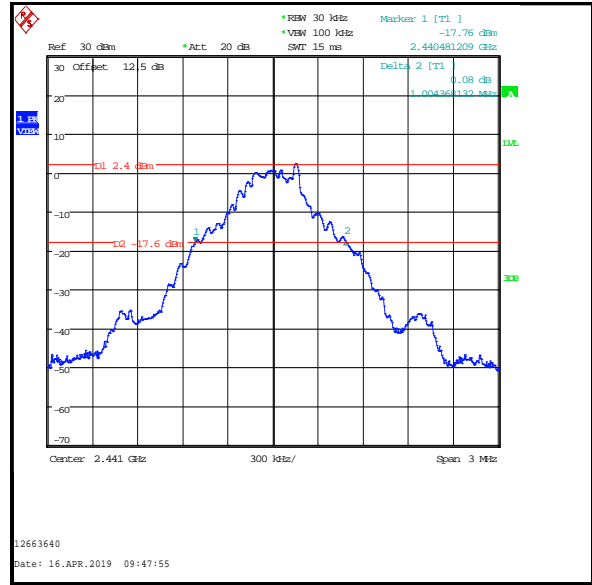

**Middle Channel**

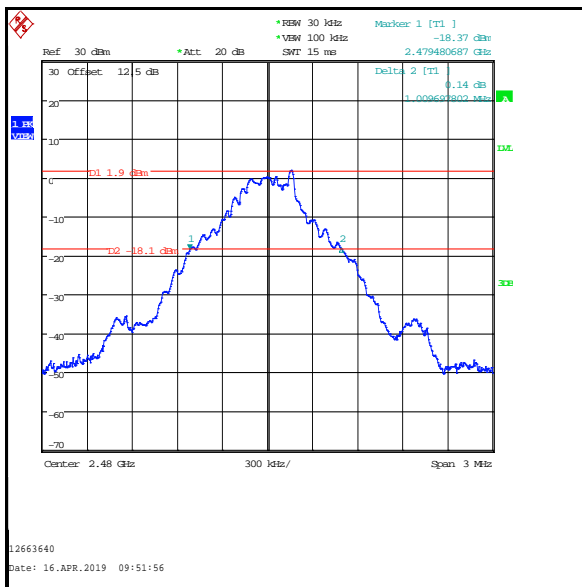

**Top Channel**

**Transmitter 20 dB Bandwidth (continued)**

**Results 2DH5:**

Channel	20 dB Bandwidth (kHz)
Bottom	1369.231
Middle	1364.505
Top	1364.505

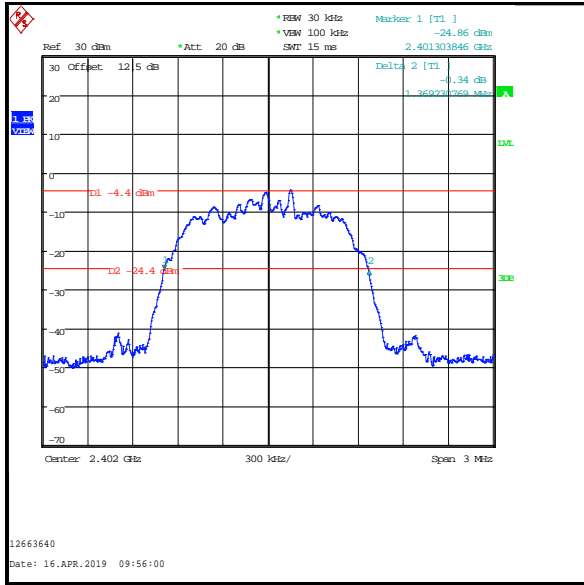

**Bottom Channel**

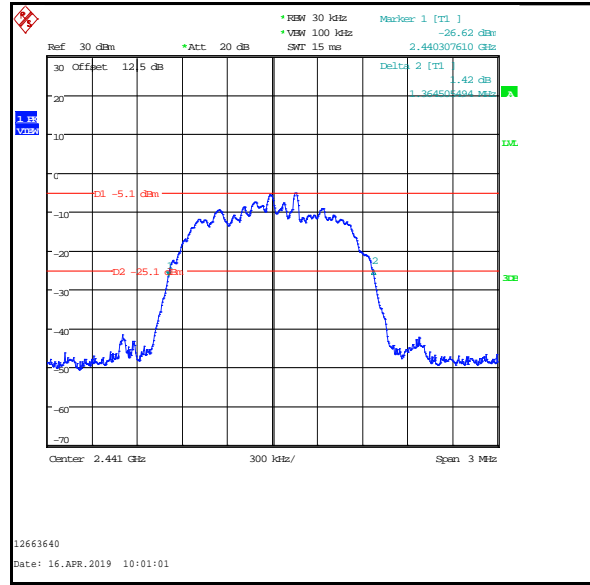

**Middle Channel**

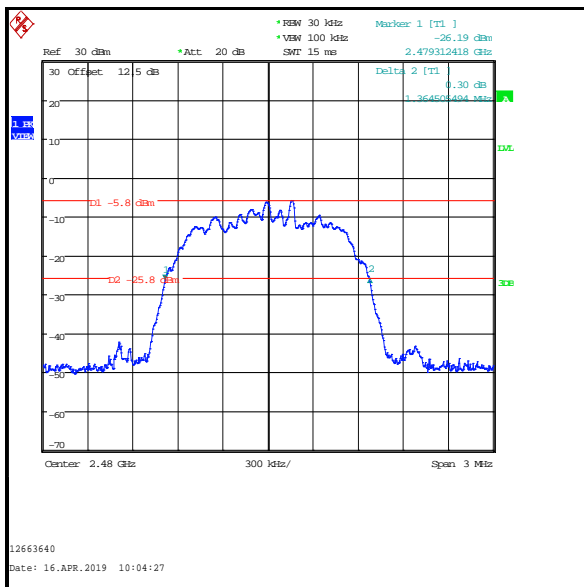

**Top Channel**

**Transmitter 20 dB Bandwidth (continued)**

**Results 3DH5:**

Channel	20 dB Bandwidth (kHz)
Bottom	1335.055
Middle	1334.615
Top	1335.137

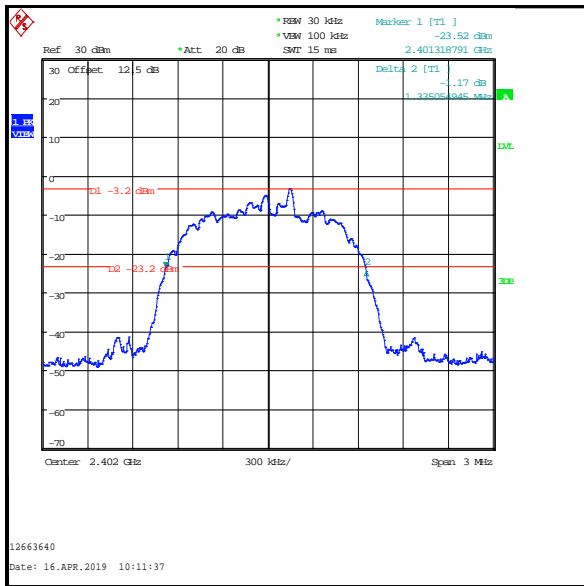

**Bottom Channel**

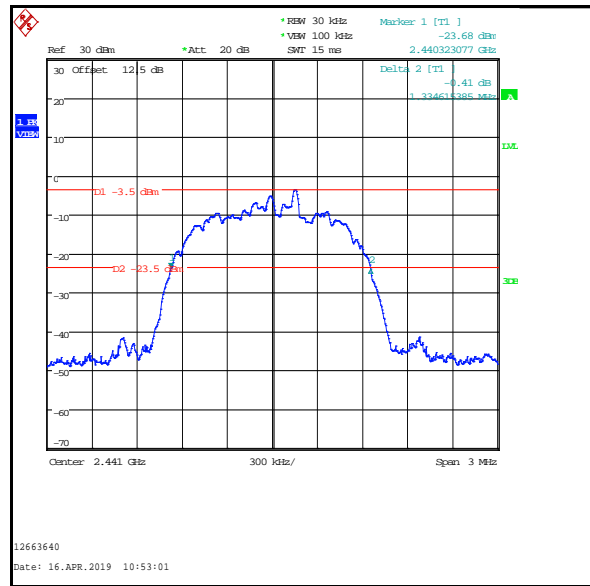

**Middle Channel**

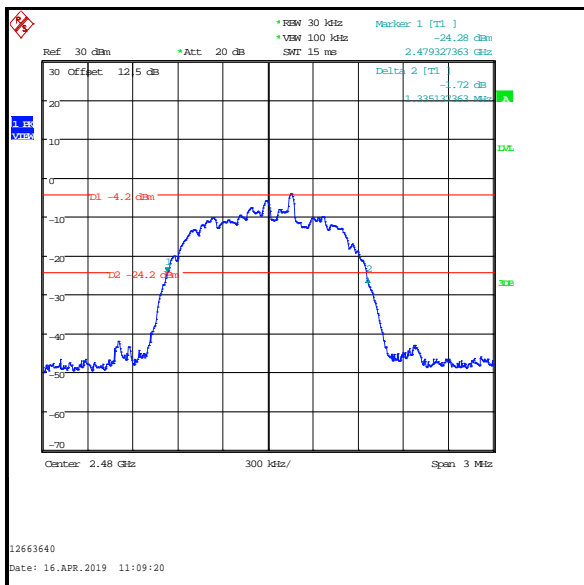

**Top Channel**

## **4.2. Transmitter Carrier Frequency Separation**

### **Test Summary:**

<b>Test Engineers:</b>	Victor Carmon & Matthew Botfield	<b>Test Date:</b>	16 April 2019
<b>Test Sample Serial Number:</b>	0000000020d6f686		

<b>FCC Reference:</b>	Part 15.247(a)(1)
<b>Test Method Used:</b>	ANSI C63.10 Section 7.8.2

### **Environmental Conditions:**

<b>Temperature (°C):</b>	22
<b>Relative Humidity (%):</b>	43

### **Note(s):**

1. The 20 dB bandwidth measured for the middle channel operating at 2441 MHz was used to calculate the limit.

**Transmitter Carrier Frequency Separation (continued)**

**Results: DH5**

Carrier Frequency Separation (kHz)	Limit ( $2/3$ of 20 dB BW) (kHz)	Margin (kHz)	Result
1002.857	669.579	333.278	Complied

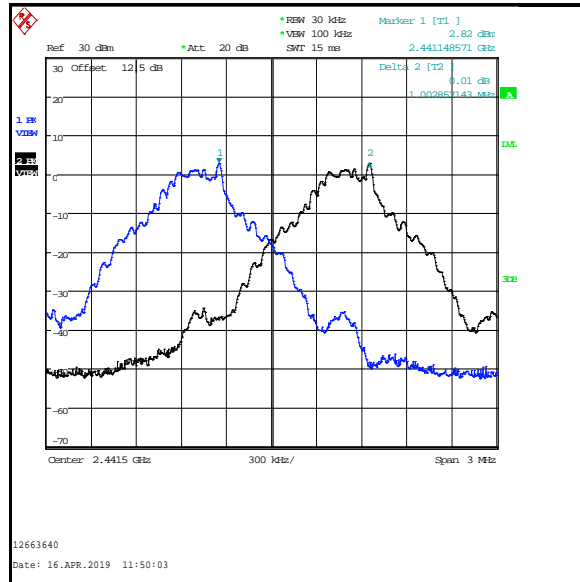



**Transmitter Carrier Frequency Separation (continued)**

**Results: 2DH5**

Carrier Frequency Separation (kHz)	Limit ( $2/3$ of 20 dB BW) (kHz)	Margin (kHz)	Result
1007.665	909.670	97.995	Complied

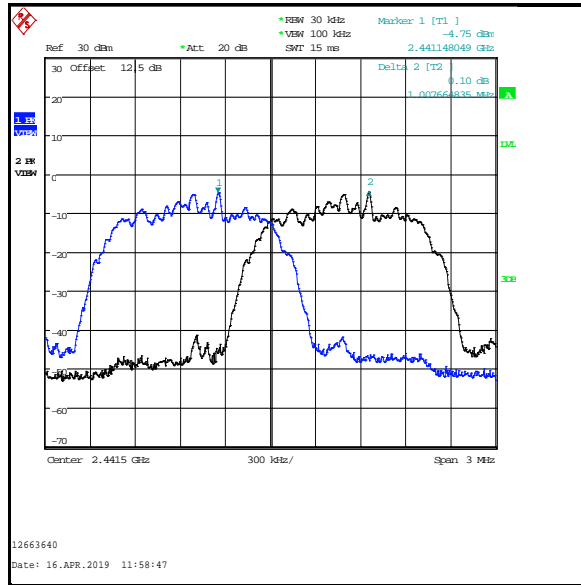

**Transmitter Carrier Frequency Separation (continued)**

**Results: 3DH5**

Carrier Frequency Separation (kHz)	Limit ( $2/3$ of 20 dB BW) (kHz)	Margin (kHz)	Result
1002.857	889.743	113.114	Complied

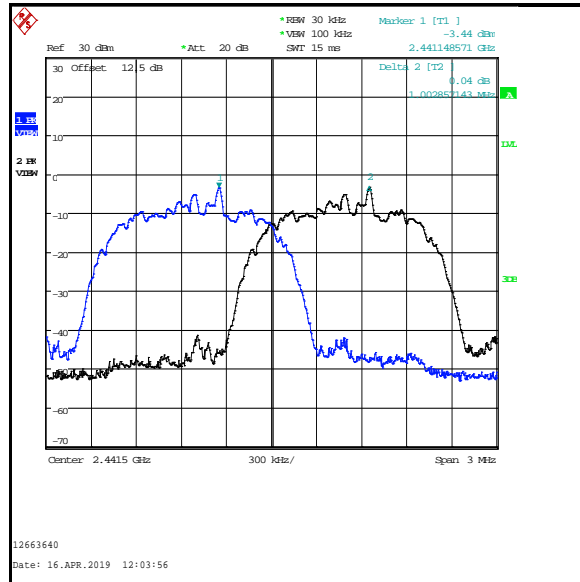

### **4.3. Transmitter Number of Hopping Frequencies and Average Time of Occupancy**

#### **Test Summary:**

<b>Test Engineers:</b>	Victor Carmon & Matthew Botfield	<b>Test Date:</b>	16 April 2019
<b>Test Sample Serial Number:</b>	0000000020d6f686		

<b>FCC Reference:</b>	Part 15.247(a)(1)(iii)
<b>Test Method Used:</b>	ANSI C63.10 Sections 7.8.3 & 7.8.4

#### **Environmental Conditions:**

<b>Temperature (°C):</b>	22
<b>Relative Humidity (%):</b>	43

#### **Note(s):**

1. Tests were performed to identify the average time of occupancy in number of channels (79) x 0.4 seconds. The calculated period is 31.6 seconds.
2. The spectrum analyser was set up for the Number of Hopping Frequencies measurement as follows: the resolution bandwidth was set to 100 kHz and video bandwidth of 300 kHz. A peak detector was used, sweep time was set to auto and trace mode was Max Hold. The span was set to 83.5 MHz.
3. The spectrum analyser was set up for the Emission Width measurement as follows: the resolution bandwidth was set to 30 kHz and video bandwidth of 100 kHz. A peak detector was used and sweep time was set to auto with a span of zero Hz. The spectrum analyser was set to trigger at 0.5 ms, with a marker placed at the start of the emission and a delta marked place at the end of the emission. The emission width is recorded in the table below
4. The spectrum analyser was set up for the Number of Hopping Frequencies in 32 seconds measurement as follows: the resolution bandwidth was set to 30 kHz and video bandwidth of 100 kHz. A peak detector was used and sweep time was set to 32 seconds. The EUT was set to transmit in a hopping frequency mode with zero span. The total number of hopping frequencies were recorded in the table below.
5. The spectrum analyser was connected to the RF port on the EUT using suitable attenuation and RF cable.

**Transmitter Number of Hopping Frequencies and Average Time of Occupancy (continued)**

**Results:**

Emission Width ( $\mu$ s)	Number of Hops in 31.6 Seconds	Average Time of Occupancy (s)	Limit (s)	Margin (s)	Result
2932.692	109	0.320	0.4	0.080	Complied

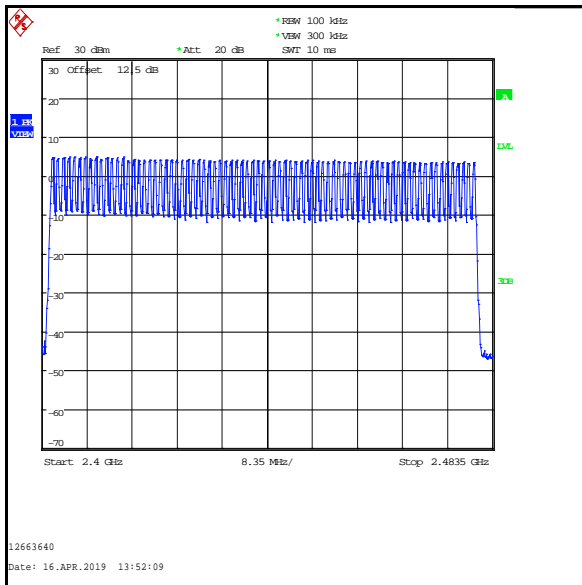

**Number of Hopping Frequencies**

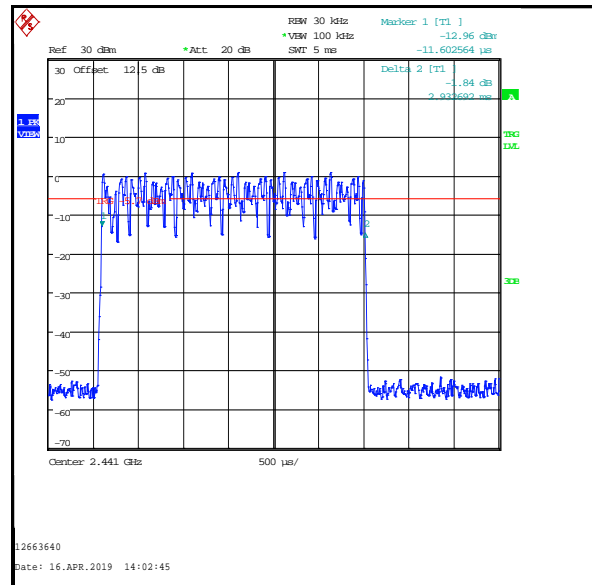

**Emission Width**

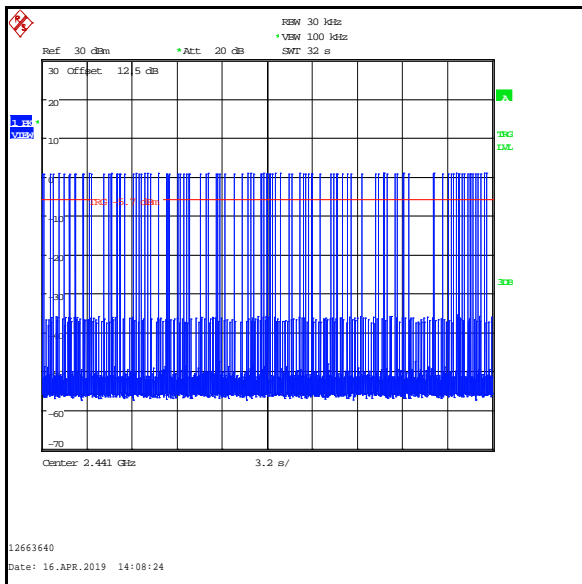

**Number of Hopping Frequencies in 32 s**

**4.4. Transmitter Maximum Peak Output Power****Test Summary:**

<b>Test Engineers:</b>	Victor Carmon & Matthew Botfield	<b>Test Date:</b>	16 April 2019
<b>Test Sample Serial Number:</b>	0000000020d6f686		

<b>FCC Reference:</b>	Part 15.247(b)(1)
<b>Test Method Used:</b>	ANSI C63.10 Section 7.8.5

**Environmental Conditions:**

<b>Temperature (°C):</b>	22
<b>Relative Humidity (%):</b>	43

**Note(s):**

1. The spectrum analyser resolution bandwidth was set to 2 MHz (>20 dB bandwidth) and video bandwidth of 10 MHz. A peak detector was used, sweep time was set to auto and trace mode was Max Hold. The span was set to 5 MHz for DH5 and 6.5 MHz 2DH5 and 3DH5 (approximately five times the 20 dB bandwidth). A marker was placed at the peak of the signal and the results recorded in the tables below.
2. The declared antenna gain was added to the conducted peak power to obtain the EIRP.
3. The spectrum analyser was connected to the RF port on the EUT using suitable attenuation and RF cable. An RF offset level was entered on the spectrum analyser to compensate for the loss of the attenuator and RF cable.

**Transmitter Maximum Peak Output Power (continued)****Results: DH5**

Channel	Conducted Peak Power (dBm)	Conducted Peak Power Limit (dBm)	Margin (dB)	Result
Bottom	4.9	30.0	25.1	Complied
Middle	4.2	30.0	25.8	Complied
Top	3.6	30.0	26.4	Complied

Channel	Conducted Peak Power (dBm)	Declared Antenna Gain (dBi)	EIRP (dBm)	De Facto EIRP Limit (dBm)	Margin (dB)	Result
Bottom	4.9	3.5	8.4	36.0	27.6	Complied
Middle	4.2	3.5	7.7	36.0	28.3	Complied
Top	3.6	3.5	7.1	36.0	28.9	Complied

### Transmitter Maximum Peak Output Power (continued)

#### Results: DH5

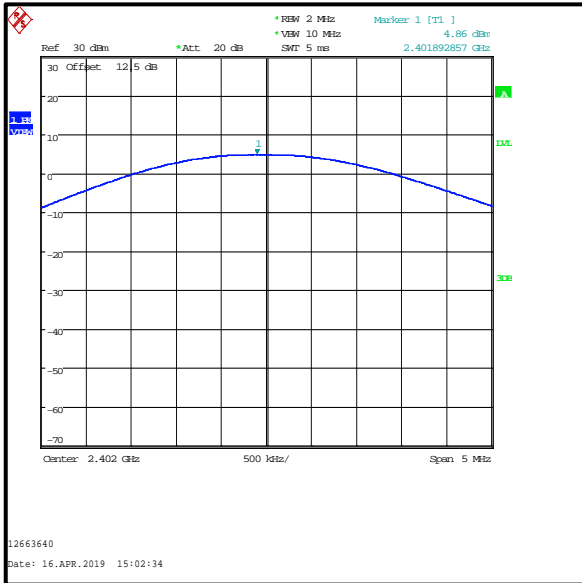

Bottom Channel

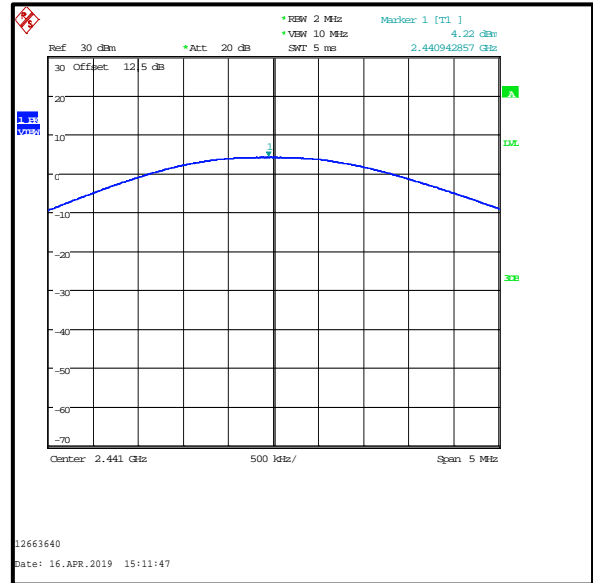

Middle Channel

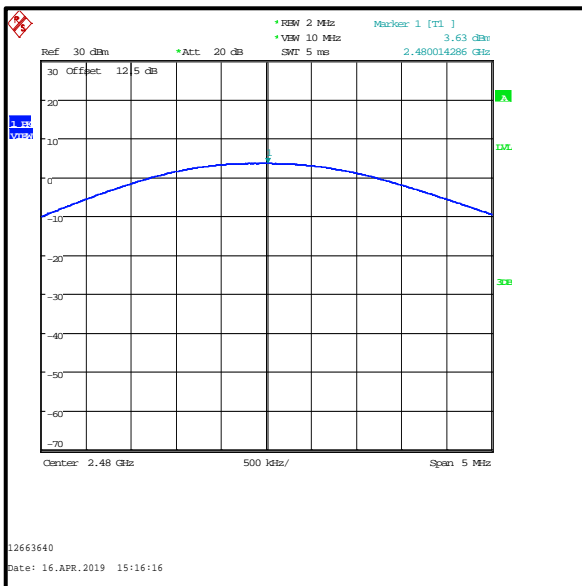

Top Channel

**Transmitter Maximum Peak Output Power (continued)****Results: 2DH5**

Channel	Conducted Peak Power (dBm)	Conducted Peak Power Limit (dBm)	Margin (dB)	Result
Bottom	1.0	21.0	20.0	Complied
Middle	0.3	21.0	20.7	Complied
Top	-0.4	21.0	21.4	Complied

Channel	Conducted Peak Power (dBm)	Declared Antenna Gain (dBi)	EIRP (dBm)	De Facto EIRP Limit (dBm)	Margin (dB)	Result
Bottom	1.0	3.5	4.5	27.0	22.5	Complied
Middle	0.3	3.5	3.8	27.0	23.2	Complied
Top	-0.4	3.5	3.1	27.0	23.9	Complied



### Transmitter Maximum Peak Output Power (continued)

#### Results: 2DH5

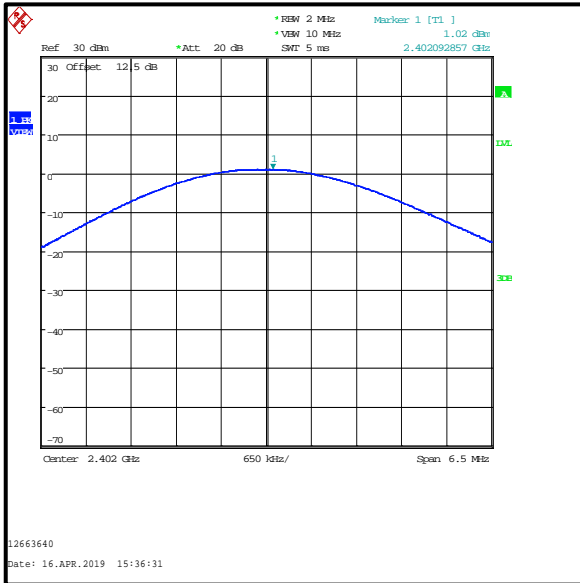

Bottom Channel

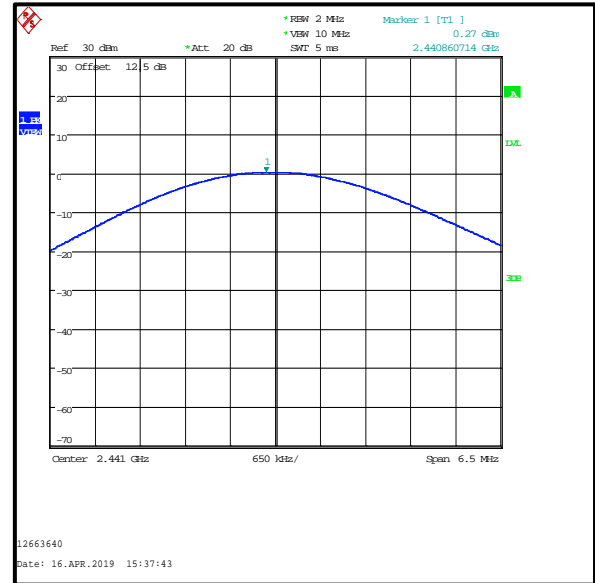

Middle Channel

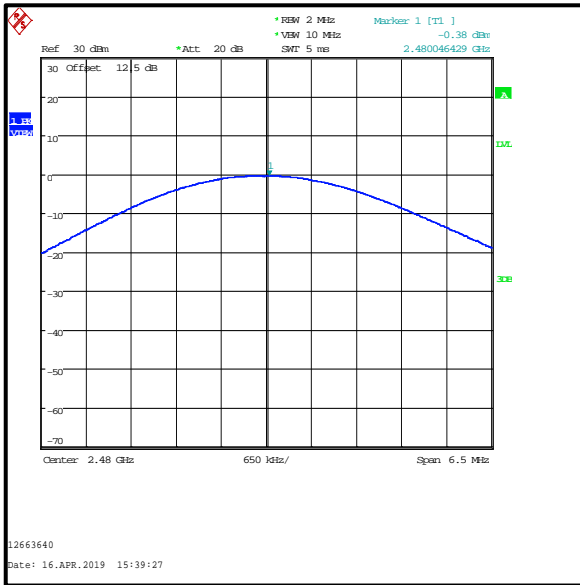

Top Channel

**Transmitter Maximum Peak Output Power (continued)****Results: 3DH5**

Channel	Conducted Peak Power (dBm)	Conducted Peak Power Limit (dBm)	Margin (dB)	Result
Bottom	1.5	21.0	19.5	Complied
Middle	0.8	21.0	20.2	Complied
Top	0.2	21.0	20.8	Complied

Channel	Conducted Peak Power (dBm)	Declared Antenna Gain (dBi)	EIRP (dBm)	De Facto EIRP Limit (dBm)	Margin (dB)	Result
Bottom	1.5	3.5	5.0	27.0	22.0	Complied
Middle	0.8	3.5	4.3	27.0	22.7	Complied
Top	0.2	3.5	3.7	27.0	23.3	Complied

**Transmitter Maximum Peak Output Power (continued)**

**Results: 3DH5**

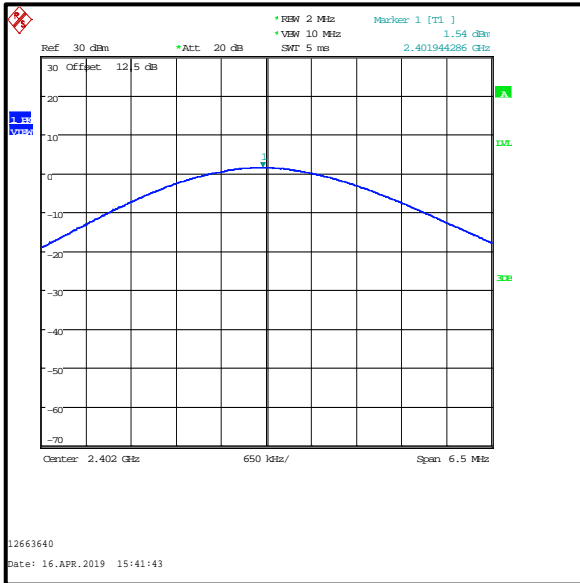

**Bottom Channel**

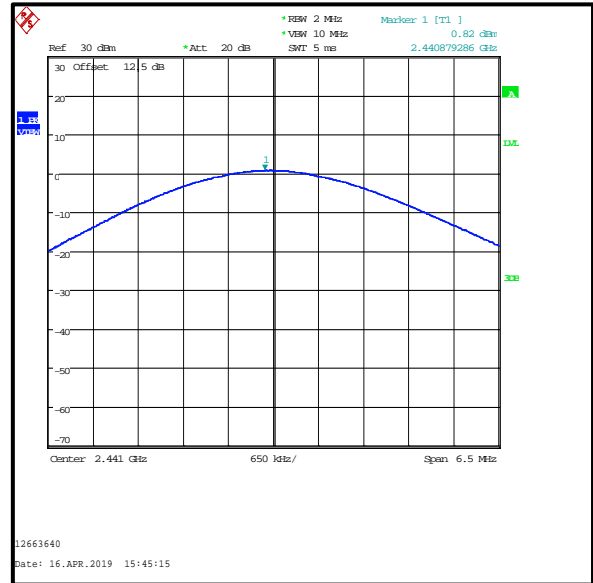

**Middle Channel**

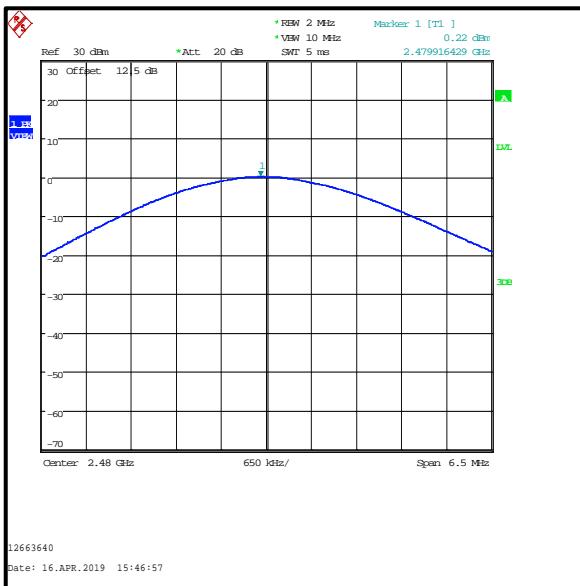

**Top Channel**

## **5. Radiated Test Results**

### **5.1. Transmitter Radiated Emissions <1 GHz**

#### **Test Summary:**

<b>Test Engineer:</b>	David Doyle	<b>Test Date:</b>	11 April 2019
<b>Test Sample Serial Number:</b>	000000003f9edf4a		

<b>FCC Reference:</b>	Parts 15.247(d) & 15.209(a)
<b>Test Method Used:</b>	ANSI C63.10 Sections 6.3 and 6.5
<b>Frequency Range</b>	30 MHz to 1000 MHz

#### **Environmental Conditions:**

<b>Temperature (°C):</b>	19
<b>Relative Humidity (%):</b>	38

#### **Note(s):**

1. Transmitter radiated spurious emissions tests were performed with the EUT transmitting in DH5 mode as this was found to transmit the highest power and therefore deemed worst case.
2. The final measured value, for the given emission, in the table below incorporates the calibrated antenna factor and cable loss.
3. All other emissions shown on the pre-scans were investigated and found to be ambient, or > 20 dB below the appropriate limit or below the noise floor of the measurement system.
4. The preliminary scans showed similar emission levels below 1 GHz, for each channel of operation. Therefore final radiated emissions measurements were performed with the EUT set to the middle channel only.
5. Measurements below 1 GHz were performed in a semi-anechoic chamber (Asset Number K0001) at a distance of 3 metres. The EUT was placed at a height of 80 cm above the reference ground plane in the centre of the chamber turntable. Maximum emission levels were determined by height searching the measurement antenna over the range 1 metre to 4 metres.
6. Pre-scans were performed and markers placed on the highest measured levels. The test receiver resolution bandwidth was set to 120 kHz and video bandwidth 500 kHz. A peak detector was used, sweep time was set to auto and trace mode was Max Hold.
7. Final measurements were performed on the marker frequencies and the results entered into the table below. The test receiver resolution bandwidth was set to 120 kHz, using a CISPR quasi-peak detector and span wide enough to see the whole emission.

**Transmitter Radiated Emissions (continued)**

**Results: Quasi-Peak / DH5**

Frequency (MHz)	Antenna Polarity	Level (dB $\mu$ V/m)	Limit (dB $\mu$ V/m)	Margin (dB)	Result
108.263	Horizontal	35.8	43.5	7.7	Complied
120.288	Horizontal	33.5	43.5	10.0	Complied
278.347	Horizontal	32.6	46.0	13.4	Complied
960.279	Horizontal	49.7	54.0	4.3	Complied

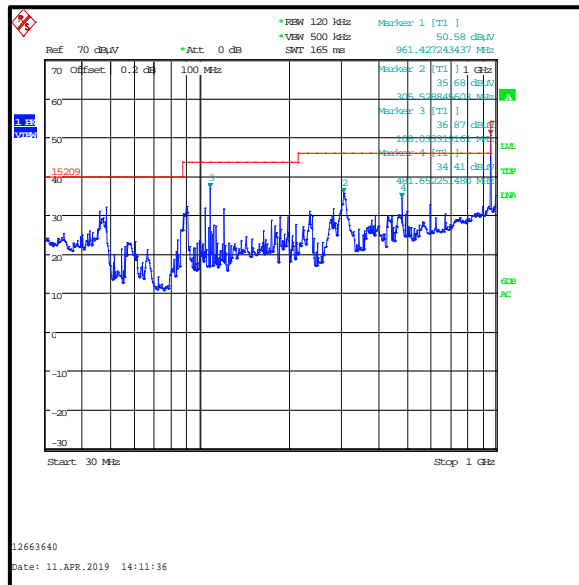

Note: This plot is a pre-scan and for indication purposes only. For final measurements, see accompanying table.

## **5.2. Transmitter Radiated Emissions >1 GHz**

### **Test Summary:**

<b>Test Engineer:</b>	David Doyle	<b>Test Dates:</b>	10 April 2019 to 12 April 2019
<b>Test Sample Serial Number:</b>	000000003f9edf4a		

<b>FCC Reference:</b>	Parts 15.247(d) & 15.209(a)
<b>Test Method Used:</b>	ANSI C63.10 Sections 6.3 and 6.6
<b>Frequency Range</b>	1 GHz to 25 GHz

### **Environmental Conditions:**

<b>Temperature (°C):</b>	19 to 20
<b>Relative Humidity (%):</b>	38 to 41

### **Note(s):**

1. Transmitter radiated spurious emissions tests were performed with the EUT transmitting in DH5 mode as this was found to transmit the highest power and therefore deemed worst case.
2. The final measured value, for the given emission, in the table below incorporates the calibrated antenna factor and cable loss.
3. The emission shown on the 1 GHz to 3 GHz plot is the EUT fundamental at 2441 MHz.
4. In accordance with ANSI C63.10 Section 6.6.4.3 (Note 1), if the peak measured value complies with the average limit, it is unnecessary to perform an average measurement.
5. All other emissions shown on the pre-scans were investigated and found to be ambient, or > 20 dB below the appropriate limit or below the noise floor of the measurement system.
6. Pre-scans above 1 GHz were performed in a fully anechoic chamber (Asset Number K0001) at a distance of 3 metres. The EUT was placed at a height of 1.5 metres above the test chamber floor in the centre of the chamber turntable. All measurement antennas were placed at a fixed height of 1.5 metres above the test chamber floor, in line with the EUT. Final measurements were performed at a distance of 3 metres. The EUT was placed at a height of 1.5 m above the reference ground plane in the centre of the chamber turntable. Maximum emission levels were determined by height searching the measurement antenna over the range 1 metre to 4 metres.
7. Pre-scans were performed and a marker placed on the highest measured level of the appropriate plot. The test receiver resolution bandwidth was set to 1 MHz and video bandwidth 3 MHz. The sweep time was set to auto. Peak and average measurements were performed with their own appropriate detectors during the pre-scan measurements.

**Transmitter Radiated Emissions (continued)****Results: Bottom Channel / DH5**

Frequency (MHz)	Antenna Polarity	Peak Level (dB $\mu$ V/m)	Average Limit (dB $\mu$ V/m)	Margin (dB)	Result
3843.150	Horizontal	47.9	54.0	6.1	Complied
4724.721	Vertical	51.9	54.0	2.1	Complied

**Results: Middle Channel / DH5**

Frequency (MHz)	Antenna Polarity	Peak Level (dB $\mu$ V/m)	Average Limit (dB $\mu$ V/m)	Margin (dB)	Result
3905.429	Horizontal	47.8	54.0	6.2	Complied
4724.971	Vertical	51.7	54.0	2.3	Complied

**Results: Top Channel / DH5**

Frequency (MHz)	Antenna Polarity	Peak Level (dB $\mu$ V/m)	Average Limit (dB $\mu$ V/m)	Margin (dB)	Result
3967.993	Horizontal	47.6	54.0	6.4	Complied
4725.193	Vertical	51.3	54.0	2.7	Complied

**Results: Hopping Mode / DH5**

Frequency (MHz)	Antenna Polarity	Peak Level (dB $\mu$ V/m)	Average Limit (dB $\mu$ V/m)	Margin (dB)	Result
3870.683	Horizontal	47.8	54.0	6.2	Complied
4725.036	Vertical	51.8	54.0	2.2	Complied

### Transmitter Radiated Emissions (continued)

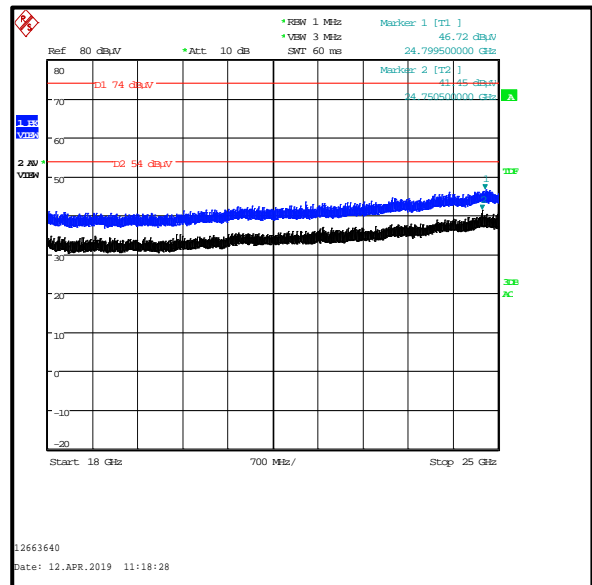
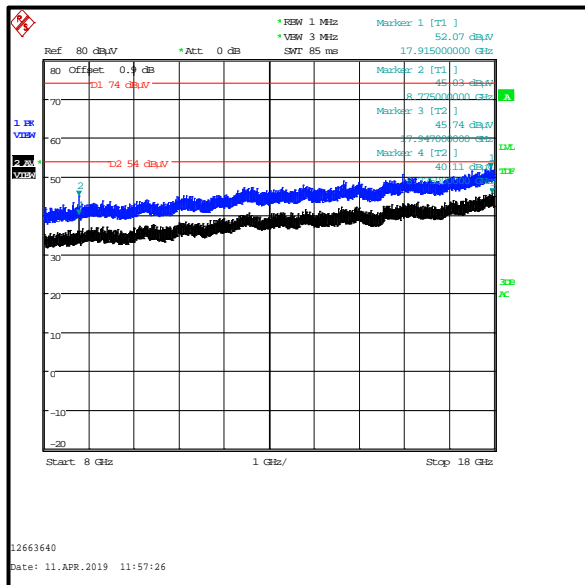
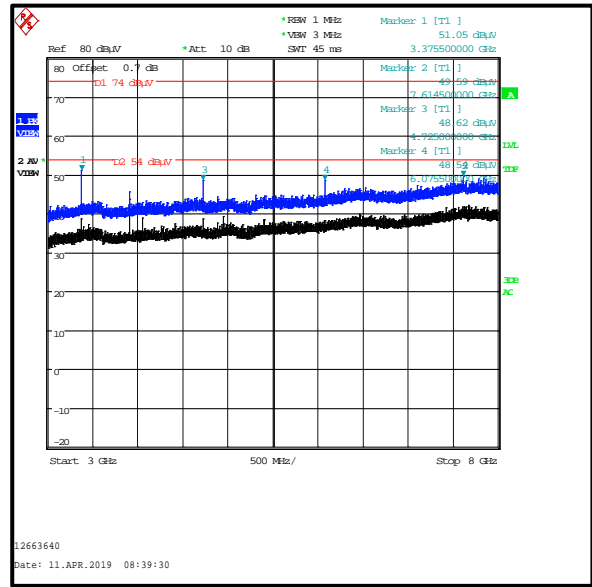
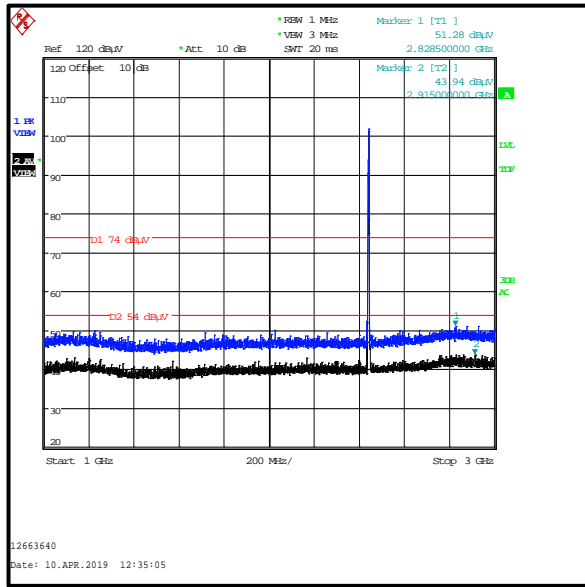

Note: These plots are pre-scans and for indication purposes only. For final measurements, see accompanying tables.



### **5.3. Transmitter Band Edge Radiated Emissions**

#### **Test Summary:**

<b>Test Engineer:</b>	David Doyle	<b>Test Date:</b>	10 April 2019
<b>Test Sample Serial Number:</b>	000000003f9edf4a		

<b>FCC Reference:</b>	Parts 15.247(d) & 15.209(a)
<b>Test Method Used:</b>	ANSI C63.10 Section 6.10

#### **Environmental Conditions:**

<b>Temperature (°C):</b>	20
<b>Relative Humidity (%):</b>	41

#### **Note(s):**

1. The final measured value, for the given emission, in the table below incorporates the calibrated antenna factor and cable loss.
2. The lower band edge is adjacent to a non-restricted band. The test receiver resolution bandwidth was set to 100 kHz and video bandwidth 300 kHz. A peak detector was used, sweep time was set to auto and trace mode was Max Hold. The test receiver was left to sweep for a sufficient length of time in order to maximise the carrier level and out-of-band emissions. A marker and corresponding reference level line were placed on the peak of the carrier. A marker was placed on the band edge spot frequencies and a second marker placed on the highest emission level in the adjacent band (where a higher level emission was present). Marker frequencies and levels were recorded.
3. The upper band edge is adjacent to a restricted band. The test receiver resolution bandwidth was set to 1 MHz and video bandwidth 3 MHz. Peak and average measurements were performed with their respective detectors, sweep time was set to auto and trace mode was Max Hold. The test receiver was left to sweep for a sufficient length of time in order to maximise the carrier level and out-of-band emissions. A marker was placed on the band edge spot frequencies and a second marker placed on the highest emission level in the adjacent band (where a higher level emission was present). Marker frequencies and levels were recorded.
4. There is a restricted band 10 MHz below the lower band edge. The test receiver was set up as follows: the RBW set to 1 MHz, the VBW set to 3 MHz, with the sweep time set to auto couple. Peak and average measurements were performed with their respective detectors. Markers were placed on the highest point on each trace.
5. \* -20 dBc limit.

**Transmitter Band Edge Radiated Emissions (continued)****Results: Static Mode / DH5**

Frequency (MHz)	Antenna Polarity	Peak Level (dB $\mu$ V/m)	Limit (dB $\mu$ V/m)	Margin (dB)	Result
2394.151	Horizontal	46.5	78.8*	32.3	Complied
2400.0	Horizontal	40.2	78.8*	38.6	Complied
2483.5	Horizontal	50.8	74.0	23.2	Complied
2484.061	Horizontal	52.0	74.0	22.0	Complied

Frequency (MHz)	Antenna Polarity	Average Level (dB $\mu$ V/m)	Limit (dB $\mu$ V/m)	Margin (dB)	Result
2483.5	Horizontal	46.5	54.0	7.5	Complied
2484.141	Horizontal	49.4	54.0	4.6	Complied

**Results: 2310 MHz to 2390 MHz Restricted Band / Peak**

Frequency (MHz)	Antenna Polarity	Level (dB $\mu$ V/m)	Limit (dB $\mu$ V/m)	Margin (dB)	Result
2384.231	Horizontal	52.3	74.0	21.7	Complied

**Results: 2310 MHz to 2390 MHz Restricted Band / Average**

Frequency (MHz)	Antenna Polarity	Level (dB $\mu$ V/m)	Limit (dB $\mu$ V/m)	Margin (dB)	Result
2348.205	Horizontal	44.6	54.0	9.4	Complied

### Transmitter Band Edge Radiated Emissions (continued)

#### Results: Static Mode / DH5

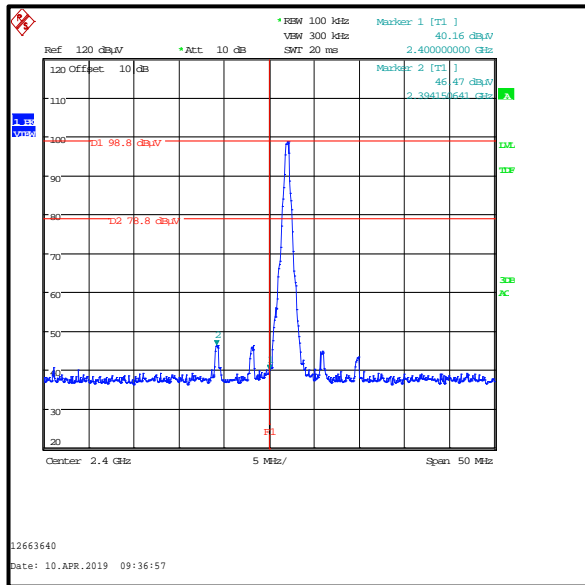

Lower Band Edge

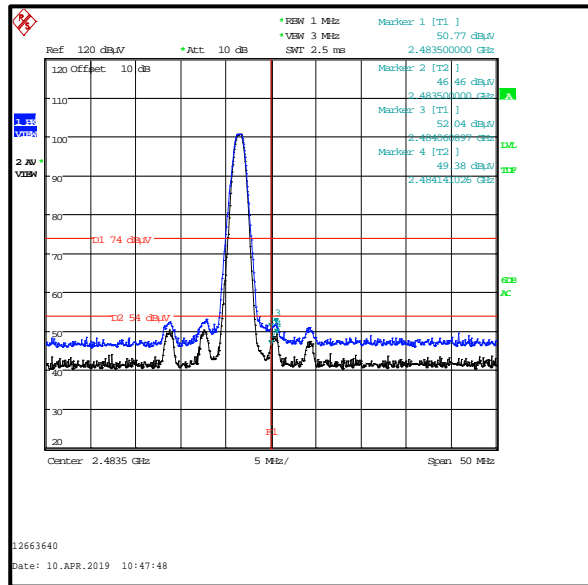

Upper Band Edge

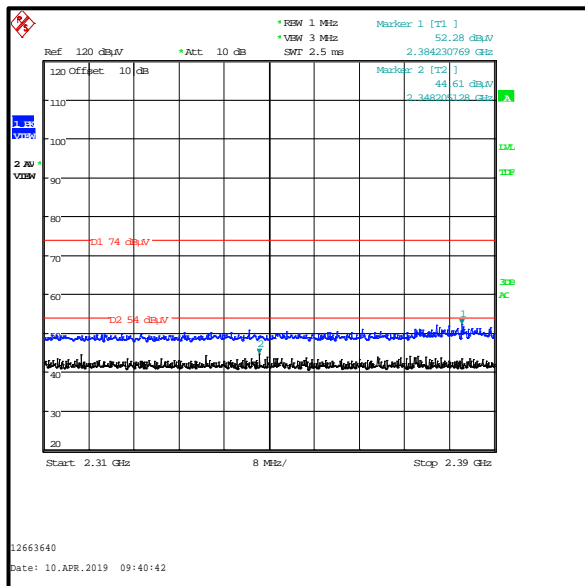

2310 MHz to 2390 MHz Restricted Band

**Transmitter Band Edge Radiated Emissions (continued)****Results: Hopping Mode / DH5**

Frequency (MHz)	Antenna Polarity	Peak Level (dB $\mu$ V/m)	Limit (dB $\mu$ V/m)	Margin (dB)	Result
2394.071	Horizontal	46.4	78.8*	32.4	Complied
2400.0	Horizontal	44.3	78.8*	34.5	Complied
2483.5	Horizontal	49.9	74.0	24.1	Complied
2483.740	Horizontal	52.1	74.0	21.9	Complied

Frequency (MHz)	Antenna Polarity	Average Level (dB $\mu$ V/m)	Limit (dB $\mu$ V/m)	Margin (dB)	Result
2483.5	Horizontal	46.4	54.0	7.6	Complied
2483.740	Horizontal	48.1	54.0	5.9	Complied

**Results: 2310 MHz to 2390 MHz Restricted Band / Peak**

Frequency (MHz)	Antenna Polarity	Level (dB $\mu$ V/m)	Limit (dB $\mu$ V/m)	Margin (dB)	Result
2379.359	Horizontal	51.6	74.0	22.4	Complied

**Results: 2310 MHz to 2390 MHz Restricted Band / Average**

Frequency (MHz)	Antenna Polarity	Level (dB $\mu$ V/m)	Limit (dB $\mu$ V/m)	Margin (dB)	Result
2376.410	Horizontal	45.1	54.0	8.9	Complied

### Transmitter Band Edge Radiated Emissions (continued)

#### Results: Hopping Mode / DH5

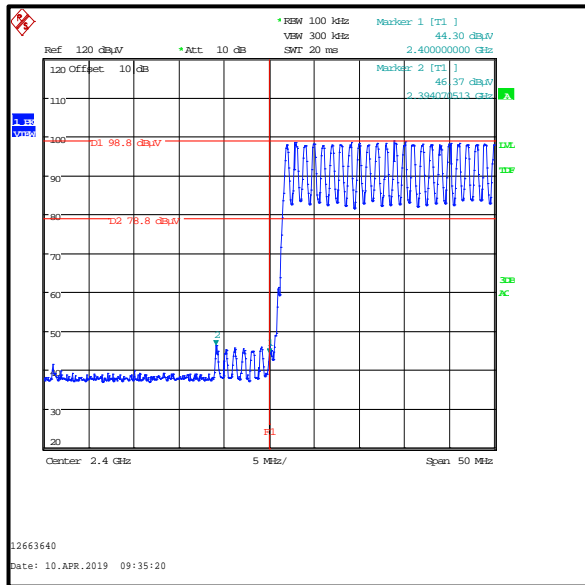

Lower Band Edge

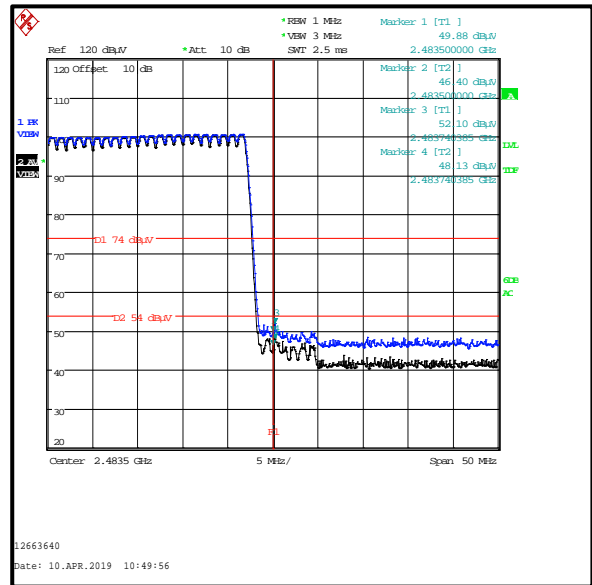

Upper Band Edge

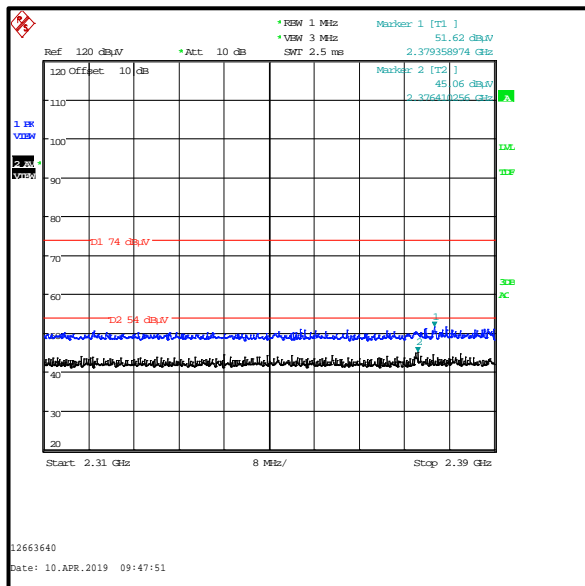

2310 MHz to 2390 MHz Restricted Band

**Transmitter Band Edge Radiated Emissions (continued)****Results: Static Mode / 2DH5**

Frequency (MHz)	Antenna Polarity	Peak Level (dB $\mu$ V/m)	Limit (dB $\mu$ V/m)	Margin (dB)	Result
2394.071	Horizontal	42.6	71.1*	28.5	Complied
2400.0	Horizontal	39.0	71.1*	32.1	Complied
2483.5	Horizontal	48.3	74.0	25.7	Complied
2484.141	Horizontal	48.9	74.0	25.1	Complied

Frequency (MHz)	Antenna Polarity	Average Level (dB $\mu$ V/m)	Limit (dB $\mu$ V/m)	Margin (dB)	Result
2483.5	Horizontal	43.5	54.0	10.5	Complied
2484.221	Horizontal	44.6	54.0	9.4	Complied

**Results: 2310 MHz to 2390 MHz Restricted Band / Peak**

Frequency (MHz)	Antenna Polarity	Level (dB $\mu$ V/m)	Limit (dB $\mu$ V/m)	Margin (dB)	Result
2388.846	Horizontal	51.9	74.0	22.1	Complied

**Results: 2310 MHz to 2390 MHz Restricted Band / Average**

Frequency (MHz)	Antenna Polarity	Level (dB $\mu$ V/m)	Limit (dB $\mu$ V/m)	Margin (dB)	Result
2386.282	Horizontal	44.7	54.0	9.3	Complied

### Transmitter Band Edge Radiated Emissions (continued)

#### Results: Static Mode / 2DH5

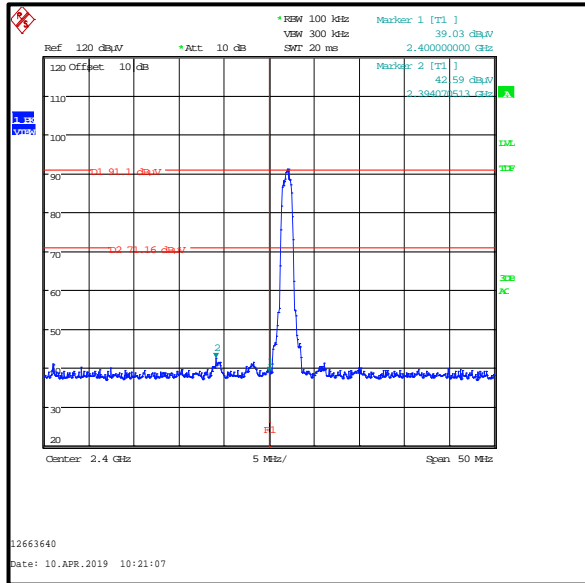

Lower Band Edge

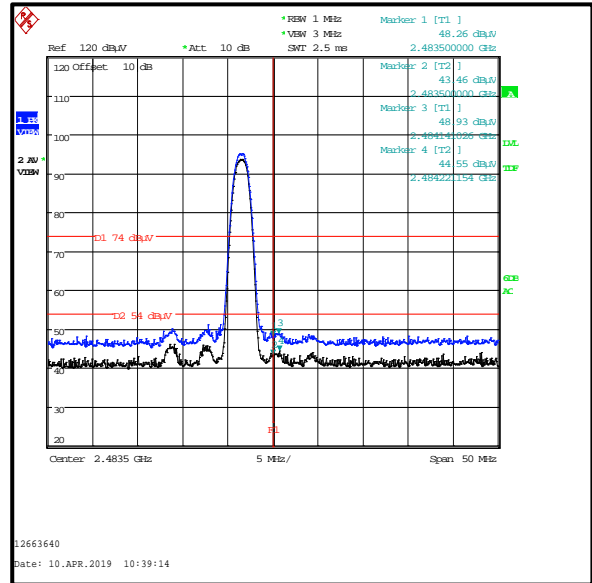

Upper Band Edge

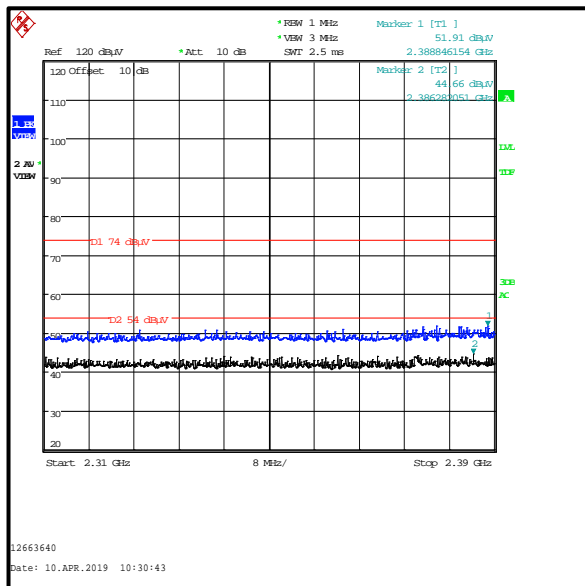

2310 MHz to 2390 MHz Restricted Band

**Transmitter Band Edge Radiated Emissions (continued)****Results: Hopping Mode / 2DH5**

Frequency (MHz)	Antenna Polarity	Peak Level (dB $\mu$ V/m)	Limit (dB $\mu$ V/m)	Margin (dB)	Result
2395.353	Horizontal	41.0	71.6*	30.6	Complied
2400.0	Horizontal	39.2	71.6*	32.4	Complied
2483.5	Horizontal	46.3	74.0	27.7	Complied

Frequency (MHz)	Antenna Polarity	Average Level (dB $\mu$ V/m)	Limit (dB $\mu$ V/m)	Margin (dB)	Result
2483.5	Horizontal	41.8	54.0	12.2	Complied
2484.141	Horizontal	45.3	54.0	8.7	Complied

**Results: 2310 MHz to 2390 MHz Restricted Band / Peak**

Frequency (MHz)	Antenna Polarity	Level (dB $\mu$ V/m)	Limit (dB $\mu$ V/m)	Margin (dB)	Result
2380.385	Horizontal	53.1	74.0	20.9	Complied

**Results: 2310 MHz to 2390 MHz Restricted Band / Average**

Frequency (MHz)	Antenna Polarity	Level (dB $\mu$ V/m)	Limit (dB $\mu$ V/m)	Margin (dB)	Result
2376.026	Horizontal	46.1	54.0	7.9	Complied



### Transmitter Band Edge Radiated Emissions (continued)

#### Results: Hopping Mode / 2DH5

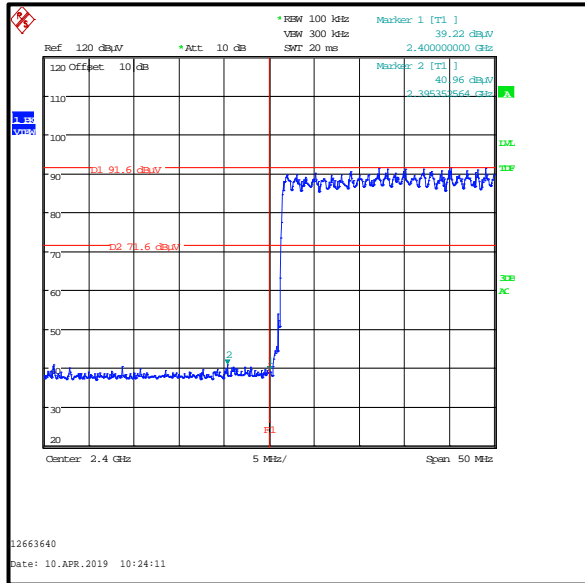

Lower Band Edge

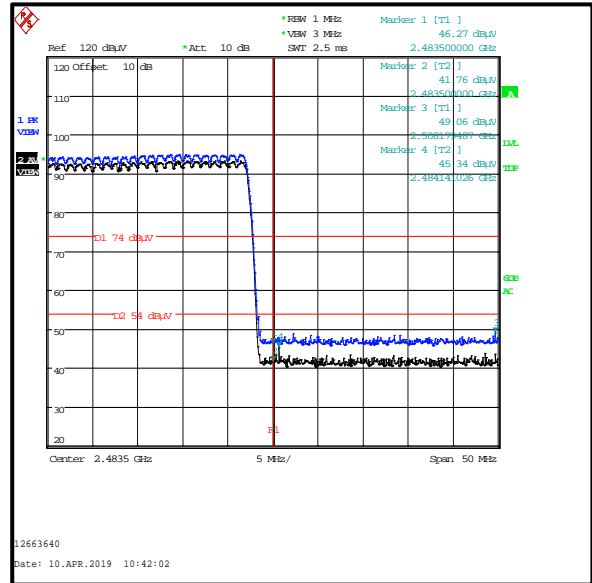

Upper Band Edge

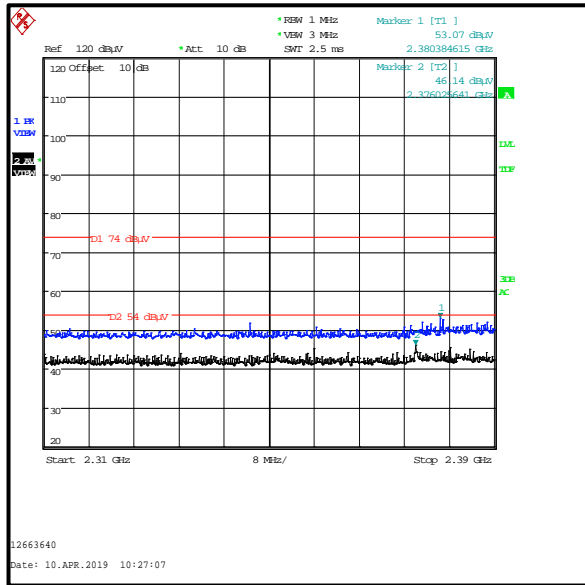

2310 MHz to 2390 MHz Restricted Band

**Transmitter Band Edge Radiated Emissions (continued)****Results: Static Mode / 3DH5**

Frequency (MHz)	Antenna Polarity	Peak Level (dB $\mu$ V/m)	Limit (dB $\mu$ V/m)	Margin (dB)	Result
2400.0	Horizontal	39.1	71.3*	32.2	Complied
2483.5	Horizontal	48.0	74.0	26.0	Complied
2483.981	Horizontal	48.3	74.0	25.7	Complied

Frequency (MHz)	Antenna Polarity	Average Level (dB $\mu$ V/m)	Limit (dB $\mu$ V/m)	Margin (dB)	Result
2483.5	Horizontal	44.2	54.0	9.8	Complied

**Results: 2310 MHz to 2390 MHz Restricted Band / Peak**

Frequency (MHz)	Antenna Polarity	Level (dB $\mu$ V/m)	Limit (dB $\mu$ V/m)	Margin (dB)	Result
2382.692	Horizontal	53.6	74.0	20.4	Complied

**Results: 2310 MHz to 2390 MHz Restricted Band / Average**

Frequency (MHz)	Antenna Polarity	Level (dB $\mu$ V/m)	Limit (dB $\mu$ V/m)	Margin (dB)	Result
2376.154	Horizontal	46.3	54.0	7.7	Complied

### Transmitter Band Edge Radiated Emissions (continued)

#### Results: Static Mode / 3DH5

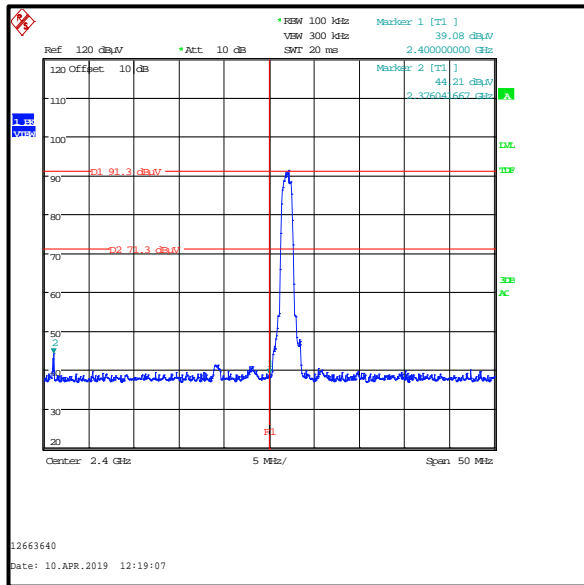

Lower Band Edge

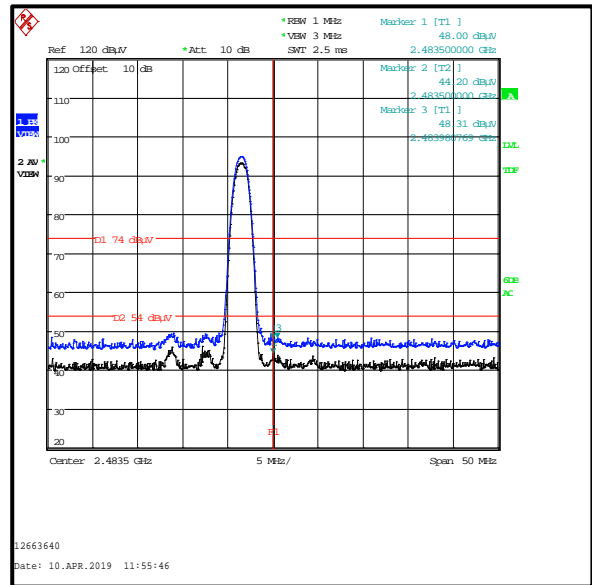

Upper Band Edge

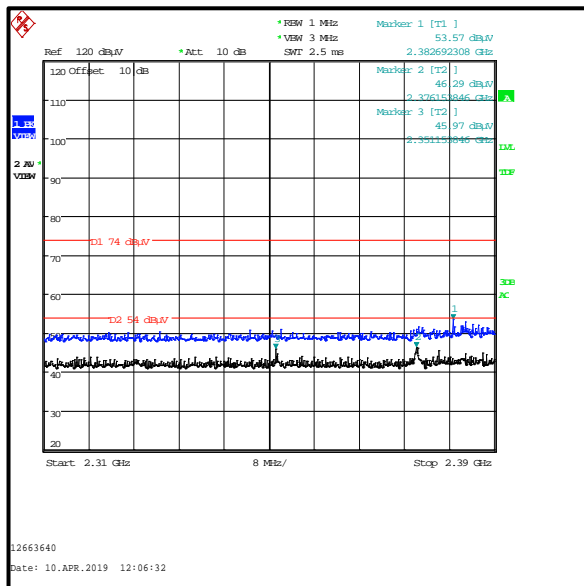

2310 MHz to 2390 MHz Restricted Band

**Transmitter Band Edge Radiated Emissions (continued)****Results: Hopping Mode / 3DH5**

Frequency (MHz)	Antenna Polarity	Peak Level (dB $\mu$ V/m)	Limit (dB $\mu$ V/m)	Margin (dB)	Result
2400.0	Horizontal	40.2	71.7*	31.5	Complied
2483.5	Horizontal	46.9	74.0	27.1	Complied
2484.462	Horizontal	48.9	74.0	25.1	Complied

Frequency (MHz)	Antenna Polarity	Average Level (dB $\mu$ V/m)	Limit (dB $\mu$ V/m)	Margin (dB)	Result
2483.5	Horizontal	42.1	54.0	11.9	Complied
2490.471	Horizontal	44.1	54.0	9.9	Complied

**Results: 2310 MHz to 2390 MHz Restricted Band / Peak**

Frequency (MHz)	Antenna Polarity	Level (dB $\mu$ V/m)	Limit (dB $\mu$ V/m)	Margin (dB)	Result
2380.385	Horizontal	52.5	74.0	21.5	Complied

**Results: 2310 MHz to 2390 MHz Restricted Band / Average**

Frequency (MHz)	Antenna Polarity	Level (dB $\mu$ V/m)	Limit (dB $\mu$ V/m)	Margin (dB)	Result
2376.410	Horizontal	46.0	54.0	8.0	Complied

### Transmitter Band Edge Radiated Emissions (continued)

#### Results: Hopping Mode / 3DH5

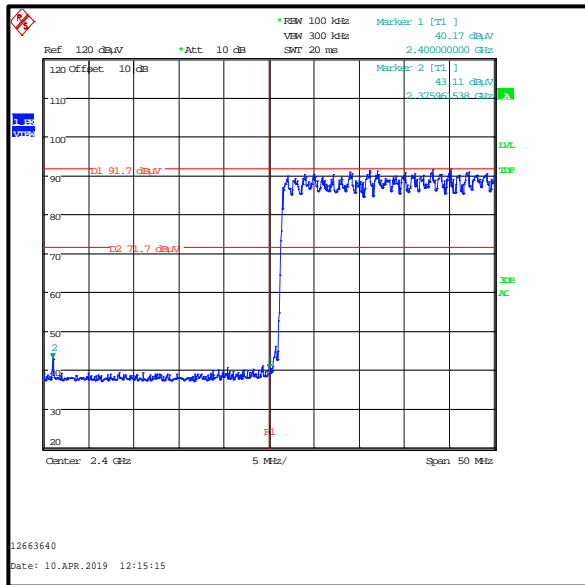

Lower Band Edge

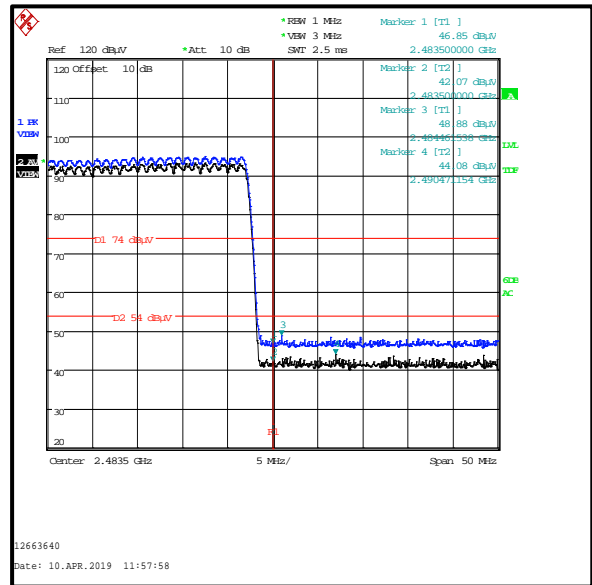

Upper Band Edge

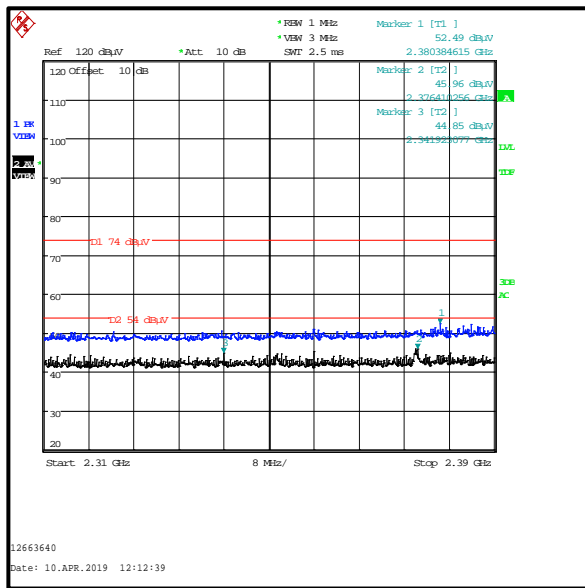

2310 MHz to 2390 MHz Restricted Band

## **6. AC Power Line Conducted Emissions Test Results**

### **6.1. Transmitter AC Conducted Spurious Emissions**

#### **Test Summary:**

<b>Test Engineer:</b>	Victor Carmon	<b>Test Dates:</b>	18 April 2019 & 23 April 2019
<b>Test Sample Serial Number:</b>	0000000027a0c96b		

<b>FCC Reference:</b>	Part 15.207
<b>Test Method Used:</b>	ANSI C63.10 Section 6.2 / FCC KDB 174176 and notes below

#### **Environmental Conditions:**

<b>Temperature (°C):</b>	21 to 23
<b>Relative Humidity (%):</b>	43 to 45

#### **Note(s):**

1. The EUT was connected to the AC to DC switch mode power supply which was connected to 120 VAC 60 Hz single phase supply via a LISN.
2. In accordance with FCC KDB 174176 Q4, tests were performed with a 240 VAC 60 Hz single phase supply as this was within the voltage range marked on the EUT's power supply.
3. A pulse limiter was fitted between the LISN and the test receiver.
4. Pre-scans were performed and markers placed on the highest live and neutral measured levels. Final measurements were performed on the marker frequencies and the results entered into the tables below.

**Transmitter AC Conducted Spurious Emissions (continued)****Results: Live / Quasi Peak / 120 VAC 60 Hz**

Frequency (MHz)	Line	Level (dB $\mu$ V)	Limit (dB $\mu$ V)	Margin (dB)	Result
0.150	Live	53.9	66.0	12.1	Complied
0.191	Live	50.3	64.0	13.7	Complied
0.276	Live	43.5	60.9	17.4	Complied
0.362	Live	37.3	58.7	21.4	Complied
11.747	Live	27.3	60.0	32.7	Complied
14.348	Live	23.3	60.0	36.7	Complied

**Results: Live / Average / 120 VAC 60 Hz**

Frequency (MHz)	Line	Level (dB $\mu$ V)	Limit (dB $\mu$ V)	Margin (dB)	Result
0.155	Live	28.8	55.8	27.0	Complied
0.195	Live	25.7	53.8	28.1	Complied
0.447	Live	25.4	46.9	21.5	Complied
0.515	Live	25.9	46.0	20.1	Complied
11.963	Live	20.3	50.0	29.7	Complied

**Results: Neutral / Quasi Peak / 120 VAC 60 Hz**

Frequency (MHz)	Line	Level (dB $\mu$ V)	Limit (dB $\mu$ V)	Margin (dB)	Result
0.150	Neutral	52.7	66.0	13.3	Complied
0.186	Neutral	49.3	64.2	14.9	Complied
0.281	Neutral	41.1	60.8	19.7	Complied
11.922	Neutral	30.5	60.0	29.5	Complied
15.509	Neutral	26.2	60.0	33.8	Complied
16.755	Neutral	20.6	60.0	39.4	Complied

**Results: Neutral / Average / 120 VAC 60 Hz**

Frequency (MHz)	Line	Level (dB $\mu$ V)	Limit (dB $\mu$ V)	Margin (dB)	Result
0.159	Neutral	27.6	55.5	27.9	Complied
0.447	Neutral	23.7	46.9	23.2	Complied
0.515	Neutral	23.6	46.0	22.4	Complied
11.715	Neutral	21.4	50.0	28.6	Complied

**Transmitter AC Conducted Spurious Emissions (continued)**

**Results: 120 VAC 60 Hz**

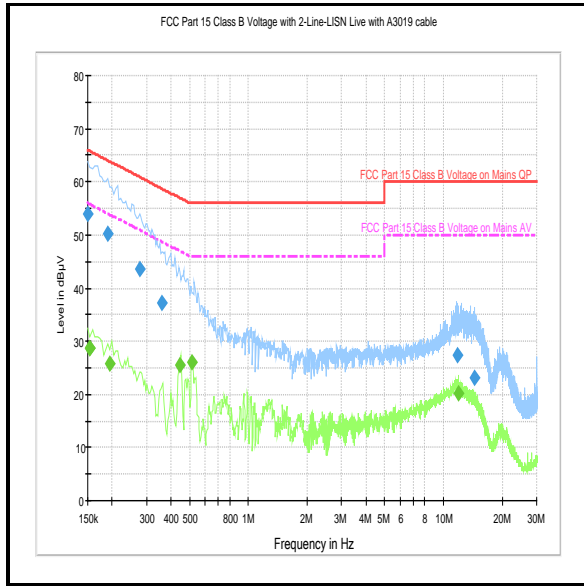

**Live**

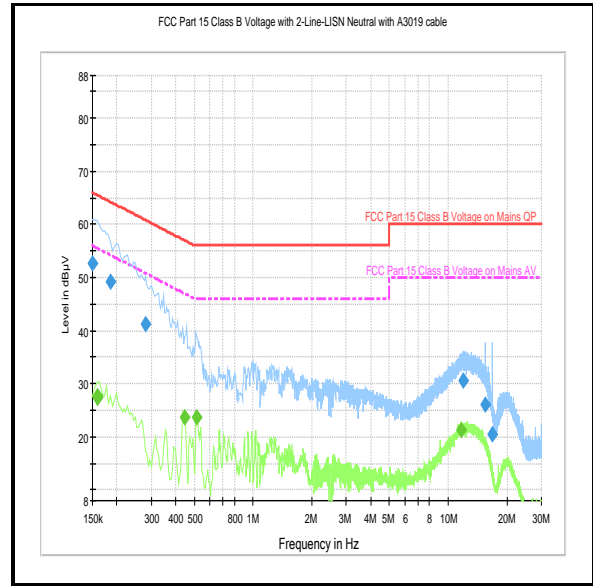

**Neutral**

*Note: These plots are pre-scans and for indication purposes only. For final measurements, see accompanying tables.*



**Transmitter AC Conducted Spurious Emissions (continued)****Results: Live / Quasi Peak / 240 VAC 60 Hz**

Frequency (MHz)	Line	Level (dB $\mu$ V)	Limit (dB $\mu$ V)	Margin (dB)	Result
0.150	Live	38.3	66.0	27.7	Complied
0.510	Live	35.7	56.0	20.3	Complied
1.271	Live	29.3	56.0	26.7	Complied
5.204	Live	26.5	60.0	33.5	Complied
11.648	Live	26.7	60.0	33.3	Complied

**Results: Live / Average / 240 VAC 60 Hz**

Frequency (MHz)	Line	Level (dB $\mu$ V)	Limit (dB $\mu$ V)	Margin (dB)	Result
0.168	Live	23.8	55.1	31.3	Complied
0.371	Live	23.7	48.5	24.8	Complied
0.501	Live	25.0	46.0	21.0	Complied
0.762	Live	23.5	46.0	22.5	Complied
1.190	Live	22.0	46.0	24.0	Complied
11.594	Live	21.2	50.0	28.8	Complied

**Results: Neutral / Quasi Peak / 240 VAC 60 Hz**

Frequency (MHz)	Line	Level (dB $\mu$ V)	Limit (dB $\mu$ V)	Margin (dB)	Result
0.150	Neutral	35.4	66.0	30.6	Complied
0.159	Neutral	34.5	65.5	31.0	Complied
0.510	Neutral	36.2	56.0	19.8	Complied
0.708	Neutral	31.9	56.0	24.1	Complied
7.188	Neutral	24.0	60.0	36.0	Complied
10.275	Neutral	26.9	60.0	33.1	Complied

**Results: Neutral / Average / 240 VAC 60 Hz**

Frequency (MHz)	Line	Level (dB $\mu$ V)	Limit (dB $\mu$ V)	Margin (dB)	Result
0.168	Neutral	23.1	55.1	32.0	Complied
0.366	Neutral	22.9	48.6	25.7	Complied
0.501	Neutral	24.5	46.0	21.5	Complied
0.789	Neutral	23.0	46.0	23.0	Complied
1.185	Neutral	22.5	46.0	23.5	Complied
10.271	Neutral	18.0	50.0	32.0	Complied

**Transmitter AC Conducted Spurious Emissions (continued)**

**Results: 240 VAC 60 Hz**

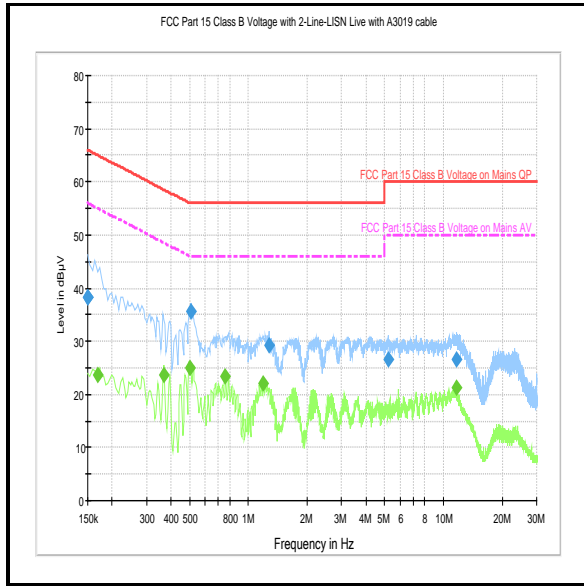

**Live**

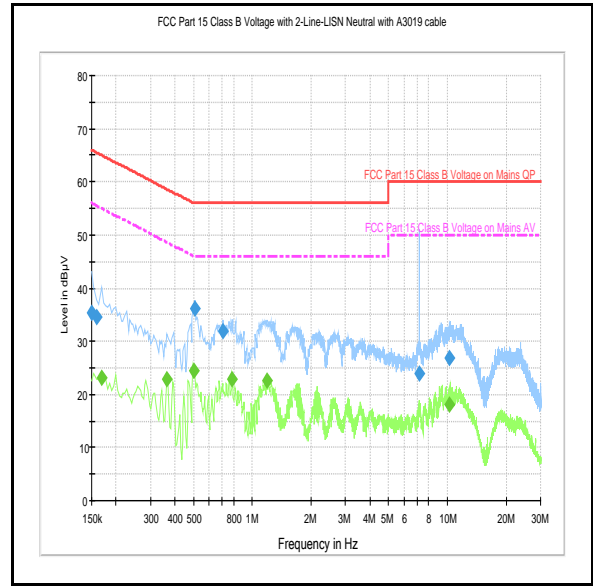

**Neutral**

*Note: These plots are pre-scans and for indication purposes only. For final measurements, see accompanying tables.*

**--- END OF REPORT ---**