

Document	Datasheet
Type	Dielectric Chip Antenna
Application	2.4GHz
Part No.	AMAN402012ST01
Revision	1.0

DATASHEET

Application

Bluetooth
Zigbee
WLAN (IEEE 802.11 b/g)
ISM 2.4GHz Wireless Devices

Features

PIFA Structure
Small Size ($4.0 \times 2.0 \times 1.2 \text{mm}^3$)
Easy Optimizing
with external lumped matching components
SMT Available under Pb-free Condition
RoHS Compliant

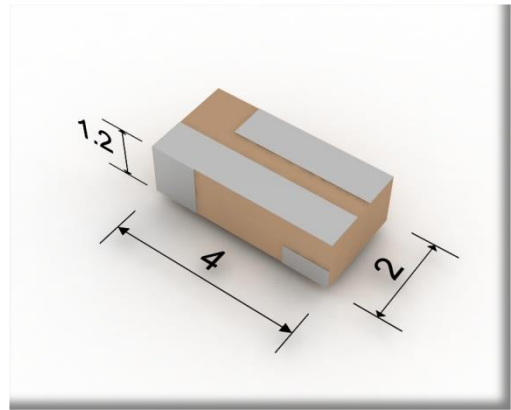

AMOTECH

Notes

The contents of this datasheet are subject to change without notice. Please confirm the specifications and delivery conditions when placing your order.

Revision History

Rev. No	Date	Title	Contents	Page
0	'08.09.05		New Published	
1.0	'10.01.19	Format	Changed document format	

Table of Content

1. Specifications	3
1.1 Electrical Specifications	3
1.2 Mechanical Specifications	3
1.3 Appearance and Material	3
2. PCB Design for Test	4
2.1 Evaluation Board Dimension	4
2.2 PCB Design Guide	4
3. Measurement Result	5
3.1 Typical Measurement Result (VSWR/RL, Smithchart)	5
3.2 Typical Measurement Result (Gain, Radiation Pattern)	6
4. Reliability	7
5. Soldering Reflow Profile	7
6. Packaging	8
6.1 Carrier Tape Dimension	8
6.2 Packaging Quantity	8
6.3 Packaging Label	8

1. Specifications

1.1 Electrical Specifications

No	Item	Spec.	Remark
1	Frequency Range [GHz]	2.4 ~2.485	
2	VSWR	Max 3.0:1	
3	Peak Gain [dBi]	typ. 2.9	
4	Total Avg. Gain [dBi]	typ. -0.5	
5	Efficiency [%]	typ. 90	
6	Polarization	Linear	
7	Impedance [Ω]	Nominal 50	

- ✓ The results are measured on the 50x50mm² evaluation board(EVB).
- ✓ See Page 6. for more detail gain parameter

1.2 Mechanical Specifications

No	Item	Spec.	Remark
1	Dimensions (LxWxH)	4.0x2.0x1.2 mm ³	
2	Unit Weight	typ. 35 mg	
3	Operating Temperature	-40 ~ +85 °C	

1.3 Appearance & Material

No	Item	Function	Material
①	Marking	Feeding Index	Ink
②	Electrode	Radiation Element	Ag
③	Ceramic Body	-	Ceramic

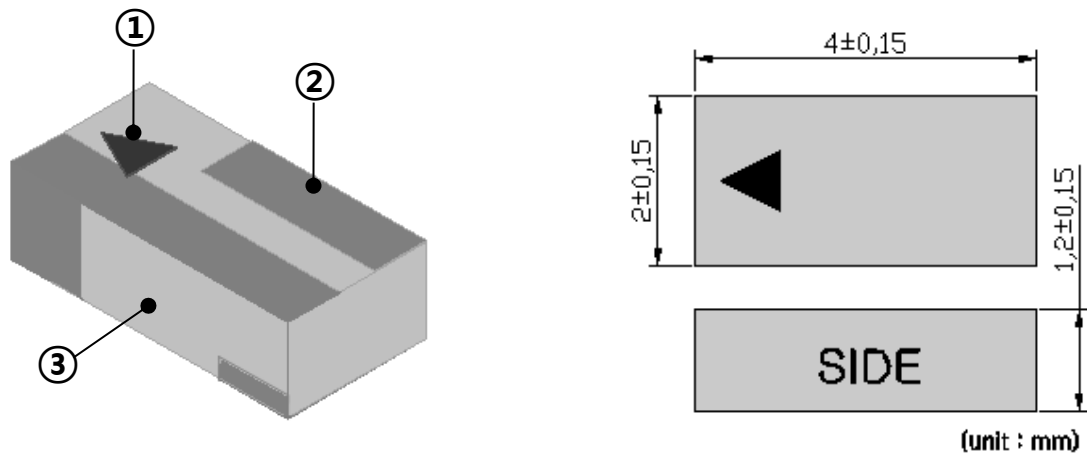

2. PCB Design for Test

2.1 Evaluation Board Dimension

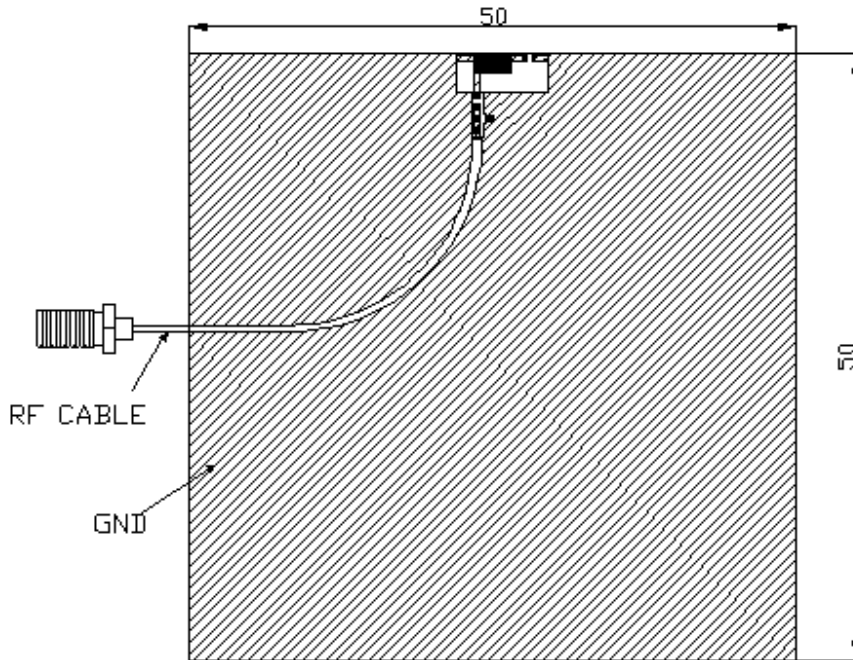

- ✓ Evaluation board size ~ 50x50
- ✓ Fill Cut Area (GND Clearance) ~ 8.5x3.8

2.2 PCB Design Guide

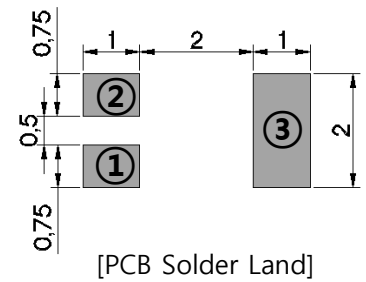
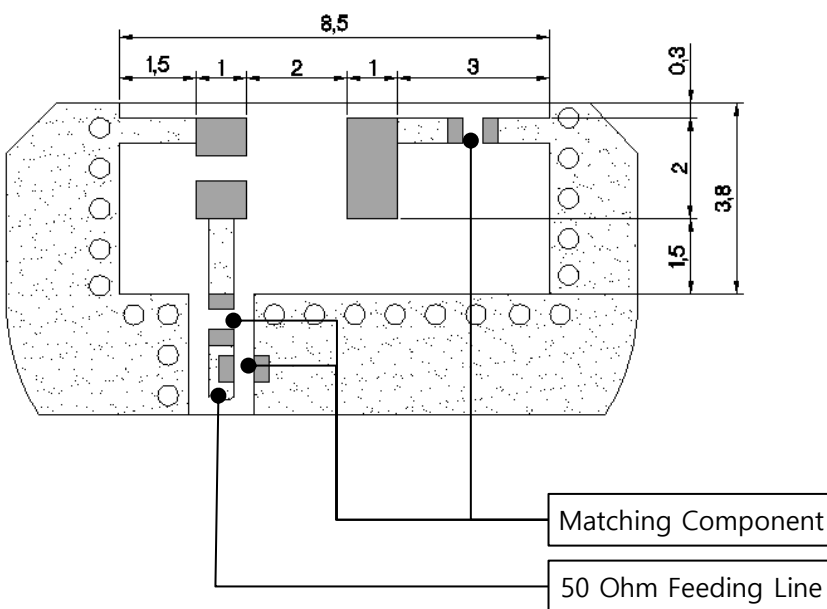

[PCB Solder Land]

No	Pin Assignment
①	Feeding
②	GND
③	GND

[unit : mm]

3. Measurement Result

3.1 Typical Measurement Result (VSWR/RL, Smithchart)

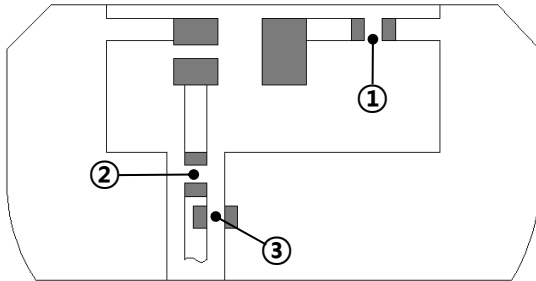

No	Matching Value
①	7.5 pF
②	1.8 nH
③	N.C

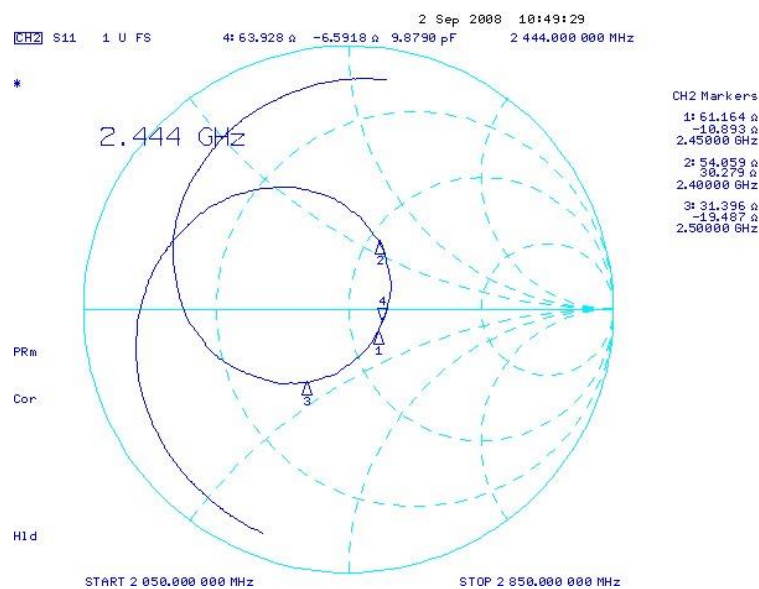
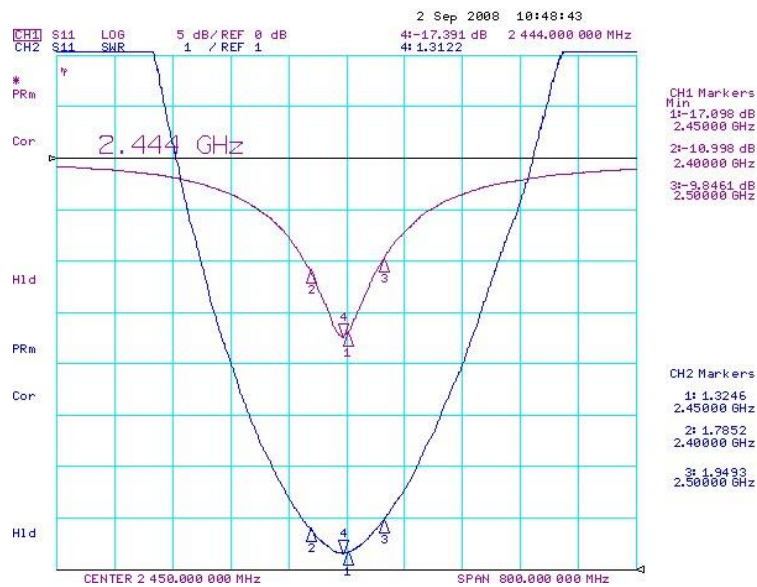

✓ The results are measured on the 50x50mm² evaluation board(EVB).

3.2 Typical Measurement Result (Gain, Radiation Pattern)

	Peak Gain (dBi)	Avg. Gain (dBi)	Total Avg. Gain (dBi)	Efficiency (%)
Azimuth	2.2	0.2	-0.45	90
Elevation 1	2.2	-0.8		
Elevation 2	2.7	-1.9		

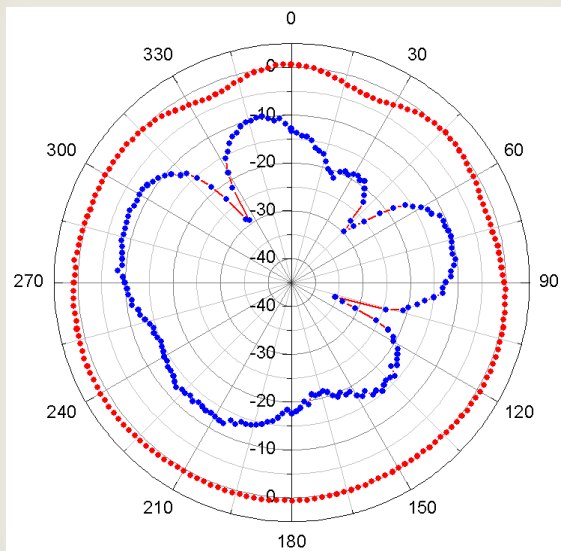
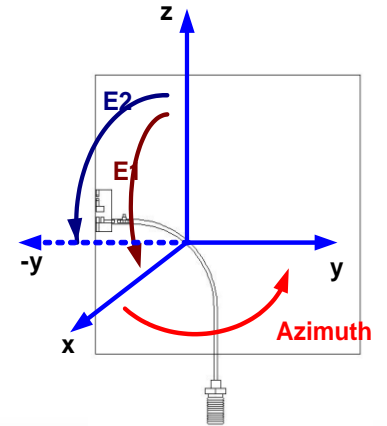

[Azimuth plane @2.45GHz]

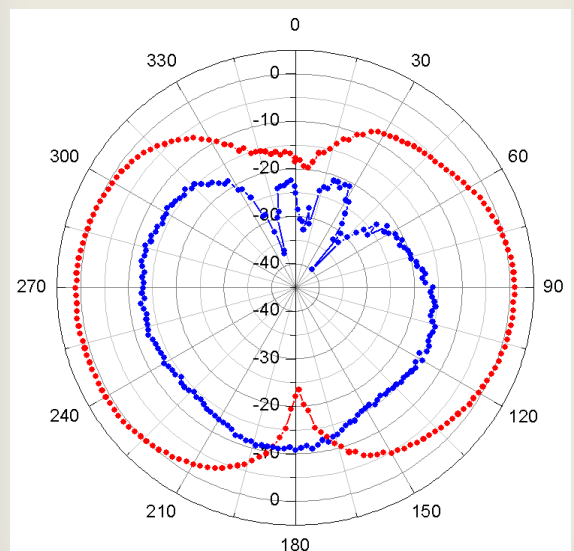

[Elevation1 plane @2.45GHz]

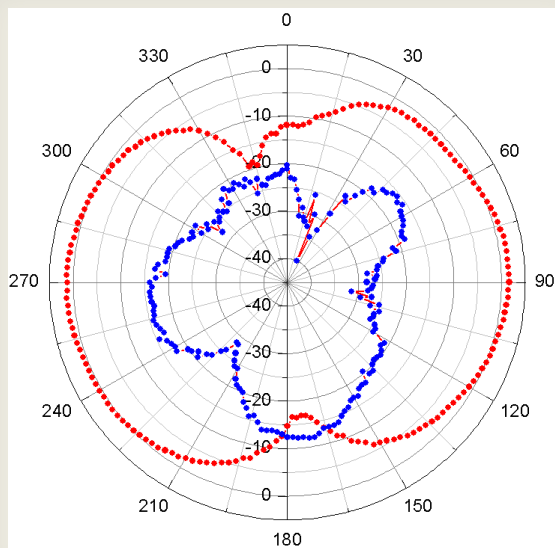

[Elevation2 plane @2.45GHz]

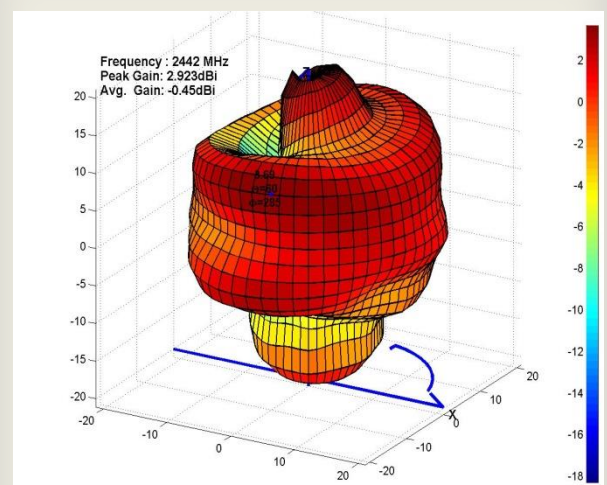

[3D Radiation Pattern]

4. Reliability

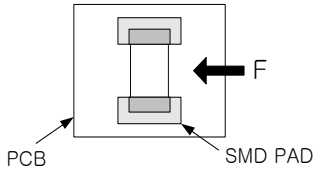
No	Item	Test Condition	Test Requirements
1	Adhesive Strength of Termination	1. Applied force on SMT chip till detached point from PCB. 	1. No mechanical damage by applied force 2. Strength (F) > 3 kgf
2	Thermal Shock (Cycle)	1. Step 1 : $-40 \pm 3^\circ\text{C}$, 30 min Step 2 : $+125 \pm 3^\circ\text{C}$, 30 min 2. Number of cycle : 30	1. No visual damage 2. Within electric spec (VSWR)
3	High Temperature Resistance	1. Temperature : $+125 \pm 5^\circ\text{C}$ 2. Time : 1000 ± 24 hrs	1. No visual damage 2. Within electric spec (VSWR)
4	Low Temperature Resistance	1. Temperature : $-40 \pm 5^\circ\text{C}$ 2. Time : 1000 ± 24 hrs	1. No visual damage 2. Within electric spec (VSWR)
5	Humidity	1. Humidity : 85 % RH Temperature : $+85 \pm 3^\circ\text{C}$ 2. Time : 1000 ± 24 hrs	1. No visual damage 2. Within electric spec (VSWR)

5. Soldering Reflow Profile

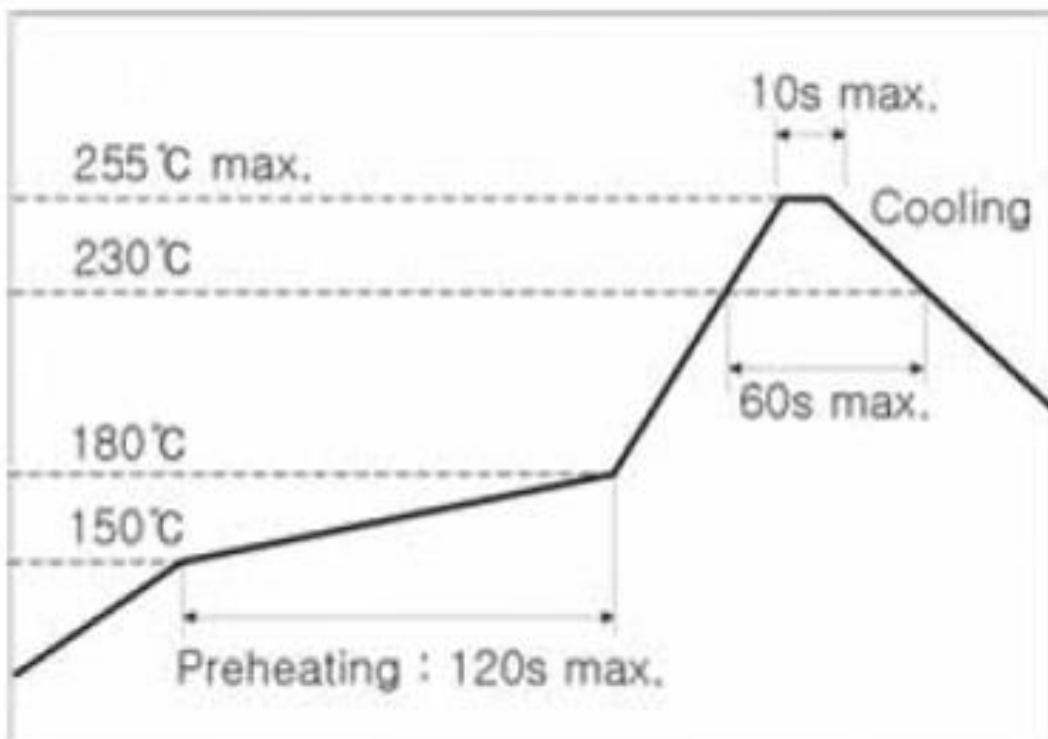

6. Packaging

6.1 Carrier Tape Dimension

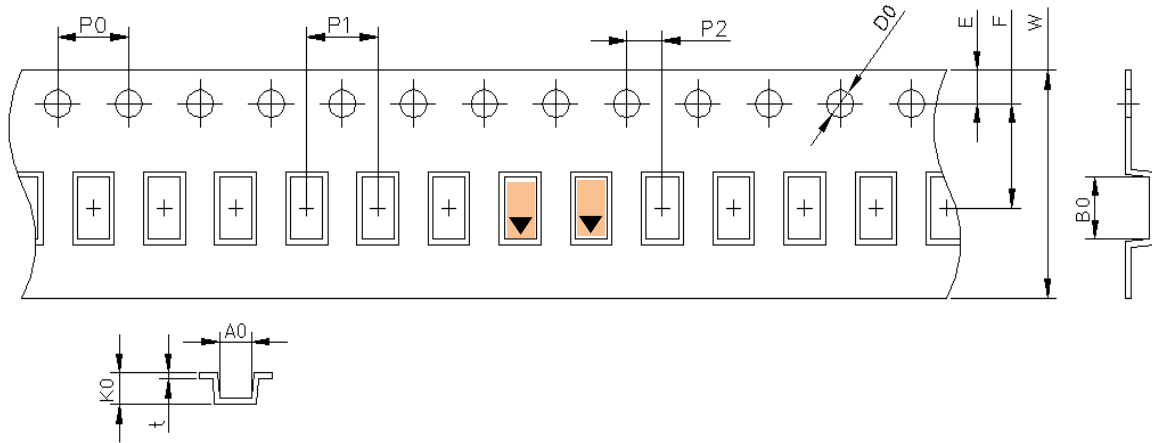

Item	Spec.	Item	Spec.	Item	Spec.
A0	2.20 ±0.10	P0	4.00 ±0.10	E	1.75 ±0.10
B0	4.30 ±0.10	P1	4.00 ±0.10	F	7.50 ±0.10
K0	1.60 ±0.10	P2	2.00 ±0.10	W	12.00 ±0.30
D0	1.55 ±0.05	-	-	t	0.30 ±0.05

6.2 Packaging Quantity

Item	Quantity	Dimension
Reel	2,000ea	Φ7" * 16mm
Inner Box	6,000 ea (3 reel)	183 * 70 * 185 (mm ³)
Outer Box1	30,000 ea (5 Inner Box)	375 * 200 * 205 (mm ³)
Outer Box2	60,000 ea (10 Inner Box)	390 * 375 * 205 (mm ³)

6.3 Packaging Label

AMOTECH Co., Ltd.

5BL-1Lot, 617, Namchon-Dong, Namdong-Gu, Incheon, Korea

Dielectric Chip Antenna

P/N : AMAN402012ST01

Lot No :

Quantity : 2,000 pcs Date : 2010/01/19