

# FCC Test Report

**Report No.:** RWAZ202300093A

**Applicant:** SHENZHEN ELECTRON TECHNOLOGY CO.,LTD.

**Address:** Bld.2, Yingfeng Industrial Zone, Tantou Community, Songgang Street, Baoan, Shenzhen, China.

**Product Name:** Smart photo frame

**Product Model:** DPF97

**Multiple Models:** N/A

**Trade Mark:** N/A

**FCC ID:** 2ABC5-E0050

**Standards:** FCC CFR Title 47 Part 15C (§15.247)

**Test Date:** 2023-12-26 to 2024-01-05

**Test Result:** Complied

**Report Date:** 2024-01-09

**Reviewed by:**

*Abel chen*

Abel Chen  
Project Engineer

**Approved by:**

*Jacob Kong*

Jacob Kong  
Manager

**Prepared by:**

World Alliance Testing and Certification (Shenzhen) Co., Ltd

No. 1002, East Block, Laobing Building, Xingye Road 3012, Xixiang street, Bao'an District, Shenzhen, Guangdong, People's Republic of China



This report may contain data that are not covered by the NVLAP accreditation and shall be marked with an asterisk “★”

## Announcement

1. This test report shall not be reproduced in full or partial, without the written approval of World Alliance Testing and Certification (Shenzhen) Co., Ltd
2. The results in this report apply only to the sample tested.
3. This sample tested is in compliance with the limits of the above regulation.
4. This report must not be used by the client to claim product certification, approval, or endorsement by NVLAP, NIST, or any agency of the U.S. Government.
5. The information marked “#” is provided by the applicant, the laboratory is not responsible for its authenticity and this information can affect the validity of the result in the test report. Customer model name, addresses, names, trademarks etc. are included.

## Revision History

Version No.	Issued Date	Description
00	2024-01-09	Original

# Contents

<b>1</b>	<b>General Information .....</b>	<b>4</b>
1.1	Client Information .....	4
1.2	Product Description of EUT .....	4
1.3	Antenna information .....	4
1.4	Related Submittal(s)/Grant(s).....	5
1.5	Measurement Uncertainty .....	5
1.6	Laboratory Location.....	5
1.7	Test Methodology .....	5
<b>2</b>	<b>Description of Measurement.....</b>	<b>6</b>
2.1	Test Configuration.....	6
2.2	Test Auxiliary Equipment .....	6
2.3	Test Setup.....	7
2.4	Test Procedure .....	9
2.5	Measurement Method.....	10
2.6	Measurement Equipment .....	11
<b>3</b>	<b>Test Results .....</b>	<b>12</b>
3.1	Test Summary.....	12
3.2	Limit .....	13
3.3	AC Line Conducted Emissions Test Data.....	14
3.4	Radiated emission Test Data.....	16
3.5	RF Conducted Test Data .....	24
3.5.1	6 dB Emission Bandwidth and 99% Occupied Bandwidth.....	24
3.5.2	Maximum Conducted Peak Output Power.....	24
3.5.3	Power Spectral Density.....	25
3.5.4	100 kHz Bandwidth of Frequency Band Edge .....	25
3.5.5	Duty Cycle .....	25
<b>4</b>	<b>Test Setup Photo.....</b>	<b>35</b>
<b>5</b>	<b>E.U.T Photo.....</b>	<b>36</b>

# 1 General Information

## 1.1 Client Information

Applicant:	SHENZHEN ELECTRON TECHNOLOGY CO.,LTD.
Address:	Bld.2,Yingfeng Industrial Zone,Tantou Community, Songgang Street,Baoan, Shenzhen,China.
Manufacturer:	SHENZHEN ELECTRON TECHNOLOGY CO.,LTD.
Address:	Bld.2,Yingfeng Industrial Zone,Tantou Community, Songgang Street,Baoan, Shenzhen,China.

## 1.2 Product Description of EUT

The EUT is Smart photo frame that contains 2.4G WLAN radios, this report covers the full testing of the 2.4G WLAN radio.

Sample Serial Number	1Z-2&1Z-4 for CE test, 1Z-1&1Z-3 for RE & RF test conducted test(assigned by WATC)
Sample Received Date	2023-12-25
Sample Status	Good Condition
Frequency Range	2412MHz - 2472MHz(802.11b, g, n-HT20) 2422MHz - 2462MHz(802.11n-HT40)
Maximum Conducted Peak Output Power	8.88dBm
Modulation Technology	DSSS, OFDM
Antenna Gain <sup>#</sup>	2.69dBi
Spatial Streams <sup>#</sup>	SISO (1TX, 1RX)
Power Supply	DC 12V/1500mA from adapter
Operating temperature <sup>#</sup>	0 deg.C to +45 deg.C
Adapter Information	Model: JHD-AP024U-120150BA-A Input: AC100-240V, 50/60Hz, 0.55A Output: DC 12V/1500mA
Modification	Sample No Modification by the test lab

## 1.3 Antenna information

### 15.203 requirement:

An intentional radiator shall be designed to ensure that no antenna other than that furnished by the responsible party shall be used with the device. The use of a permanently attached antenna or of an antenna that uses a unique coupling to the intentional radiator, the manufacturer may design the unit so that a broken antenna can be replaced by the user, but the use of a standard antenna jack or electrical connector is prohibited.

### Device Antenna information:

The Wi-Fi antenna is an internal antenna which cannot replace by end-user. Please see product internal photos for details.

## 1.4 Related Submittal(s)/Grant(s)

No Related Submittal(s)/Grant(s)

## 1.5 Measurement Uncertainty

Parameter	Expanded Uncertainty (Confidence of 95%(U = 2Uc(y)))	
AC Power Lines Conducted Emissions	±3.14dB	
Emissions, Radiated	Below 30MHz	±2.78dB
	Below 1GHz	±4.84dB
	Above 1GHz	±5.44dB
Conducted Power	0.74dB	
Frequency Error	150Hz	
Bandwidth	0.34%	
Power Spectral Density	0.74dB	

**Note 1:** The extended uncertainty given in this report is obtained by combining the standard uncertainty times the coverage factor K with the 95% confidence interval. Otherwise required by the applicant or Product Regulations, Decision Rule in this report did not consider the uncertainty.

**Note 2:** The Decision Rule is based on simple acceptance with ISO Guide 98-4:2012 Clause 8.2 (Measurement uncertainty is not taken into account when stating conformity with a specified requirement.)

## 1.6 Laboratory Location

World Alliance Testing and Certification (Shenzhen) Co., Ltd

No. 1002, East Block, Laobing Building, Xingye Road 3012, Xixiang street, Bao'an District, Shenzhen, Guangdong, People's Republic of China

Tel: +86-755-29691511, Email: [qa@watc.com.cn](mailto:qa@watc.com.cn)

The lab has been recognized as the FCC accredited lab under the KDB 974614 D01 and is listed in the FCC Public Access Link (PAL) database, FCC Registration No. : 463912, the FCC Designation No. : CN5040.

The lab has been recognized by Innovation, Science and Economic Development Canada to test to Canadian radio equipment requirements, the CAB identifier: CN0160.

## 1.7 Test Methodology

FCC CFR 47 Part 2

FCC CFR 47 Part 15

KDB 558074 D01 DTS Meas Guidance v05r02

ANSI C63.10-2020

## 2 Description of Measurement

### 2.1 Test Configuration

Operating channels:					
Channel No.	Frequency (MHz)	Channel No.	Frequency (MHz)	Channel No.	Frequency (MHz)
1	2412	6	2437	11	2462
2	2417	7	2442	12	2467
3	2422	8	2447	13	2472
4	2427	9	2452	/	/
5	2432	10	2457	/	/

According to ANSI C63.10-2020 chapter 5.6.1 Table 11 requirement, select lowest channel, middle channel, and highest channel in the frequency range in which device operates for testing. The detailed frequency points are as follows:

802.11b, 802.11g, 802.11n-HT20					
Lowest channel		Middle channel		Highest channel	
Channel No.	Frequency (MHz)	Channel No.	Frequency (MHz)	Channel No.	Frequency (MHz)
1	2412	7	2442	13	2472

802.11n-HT40					
Lowest channel		Middle channel		Highest channel	
Channel No.	Frequency (MHz)	Channel No.	Frequency (MHz)	Channel No.	Frequency (MHz)
3	2422	7	2442	11	2462

Test Mode:				
Transmitting mode:	Keep the EUT in continuous transmitting with modulation			
Exercise software <sup>#</sup> :	rtwpriv			
Mode	Worst-case Data rate	Power Level Setting <sup>#</sup>		
		Low Channel	Middle Channel	High Channel
802.11b	1Mbps	13	13	13
802.11g	6Mbps	7	7	7
802.11n-HT20	6.5Mbps	7	7	7
802.11n-HT40	13.5Mbps	2	2	2

The exercise software and the maximum power setting that provided by manufacturer.

Worst-Case Configuration:
For AC power line conducted emission and radiated emission 9kHz-1GHz and above 18GHz were performed with the EUT transmits at the channel with highest output power as worst-case scenario.

### 2.2 Test Auxiliary Equipment

Manufacturer	Description	Model	Serial Number
--------------	-------------	-------	---------------

/	/	/	/
---	---	---	---

## 2.3 Test Setup

### 1) Conducted emission measurement:

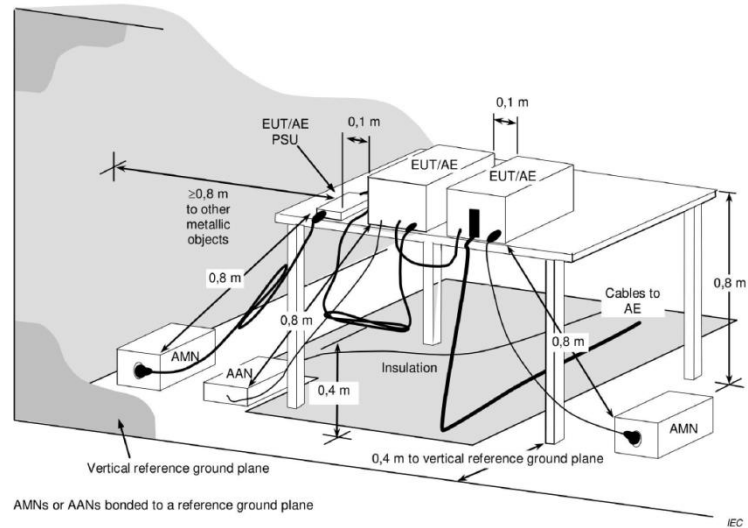

**Note:** The 0.8 m distance specified between EUT/AE/PSU and AMN/AAN, is applicable only to the EUT being measured. If the device is AE then it shall be >0.8 m.

### 2) Radiated emission measurement:

Below 30MHz (3m SAC)

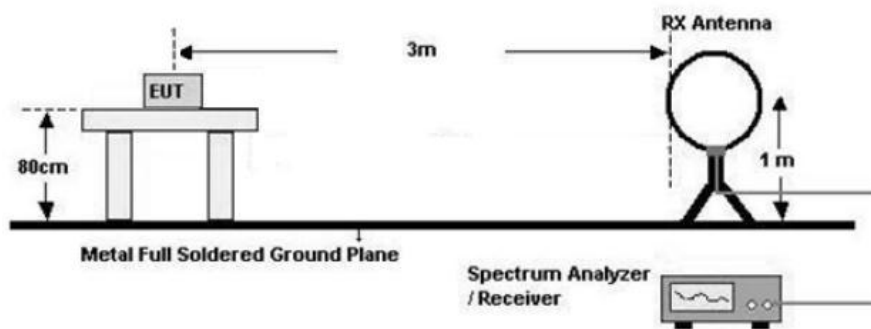

30MHz-1GHz (3m SAC)

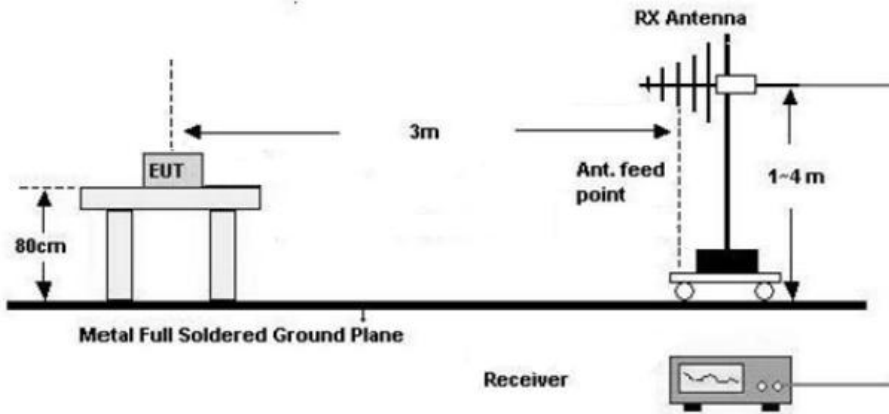

1GHz-18GHz(3m FAC)

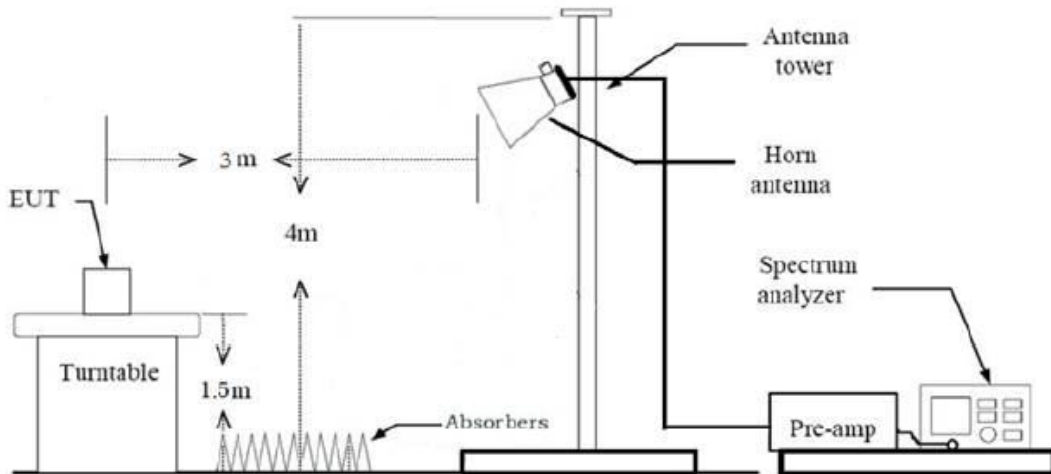

Above 18GHz (3m FAC)

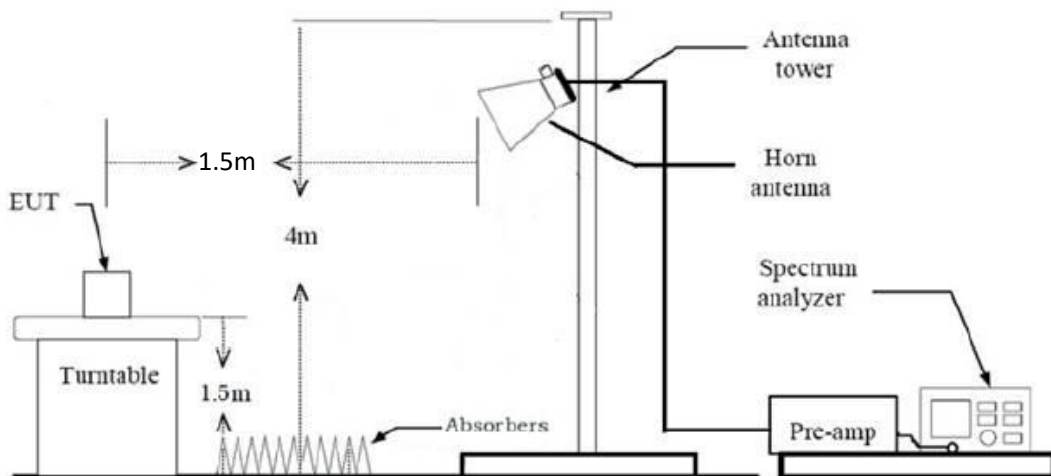



### 3) RF Conducted Test

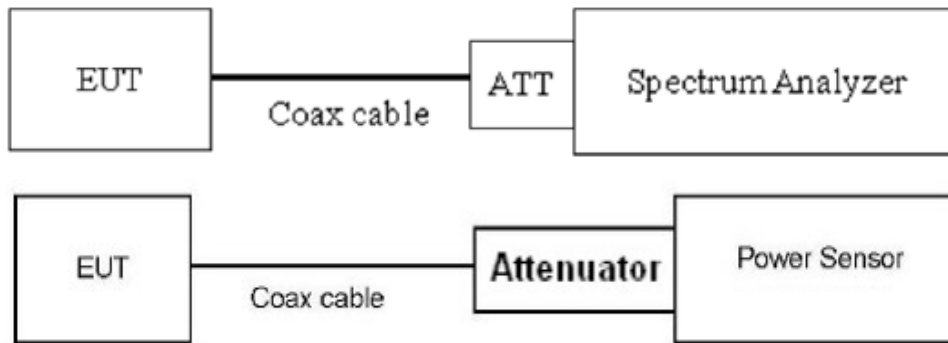

## 2.4 Test Procedure

### Conducted emission:

1. The E.U.T is placed on a non-conducting table 40cm from the vertical ground plane and 80cm above the horizontal ground plane (Please refer to the block diagram of the test setup and photographs).
2. Both sides of A.C. line are checked for maximum conducted interference. In order to find the maximum emission, the relative positions of equipment and all of the interface cables must be changed according to ANSI C63.10 on conducted measurement.
3. Line conducted data is recorded for both Line and Neutral

### Radiated Emission Procedure:

#### a) For below 30MHz

1. All measurements were made at a test distance of 3 m. The measured data was extrapolated from the test distance (3m) to the specification distance (300 m from 9-490 kHz and 30 m from 490 kHz- 30 MHz) to clearly show the relative levels of fundamental and spurious emissions and demonstrate compliance with the requirement that the level of any spurious emissions be below the level of the intentionally transmitted signal. The extrapolation factor for the limits were  $40 \cdot \log(\text{test distance} / \text{specification distance})$ .
2. Loop antenna use, investigation was done on the three antenna orientations (parallel, perpendicular, ground-parallel)

#### b) For 30MHz-1GHz:

1. The EUT was placed on the tabletop of a rotating table 0.8 m the ground at a 3 m semi anechoic chamber. The measurement distance from the EUT to the receiving antenna is 3 m.
2. EUT works in each mode of operation that needs to be tested. The highest signal levels relative to the limit shall be determined by rotating the EUT from 0° to 360° and with varying the measurement antenna height between 1 m and 4 m in vertical and horizontal polarizations.

#### c) For above 1GHz:

1. The EUT was placed on the tabletop of a rotating table 1.5 m the ground at a 3 m fully anechoic room. The measurement distance from the EUT to the receiving antenna is 3 m (1-18GHz) and 1.5 m (above 18GHz).

2. EUT works in each mode of operation that needs to be tested, and having the EUT continuously working. The highest signal levels relative to the limit shall be determined by rotating the EUT from 0° to 360° and with varying the measurement antenna height between 1 m and 4 m in vertical and horizontal polarizations.
3. Open the test software to control the test antenna and test turntable. Perform the test, save the test results, and export the test data.
4. Base on FCC 15.31 (f) (2): measurements may be performed at a distance closer than that specified in the regulations; however, an attempt should be made to avoid making measurements in the near field.

**RF Conducted Test:**

1. The antenna port of EUT was connected to the RF port of the test equipment (Power Meter or Spectrum analyzer) through Attenuator and RF cable.
2. The cable assembly insertion loss of 7.0dB (including 6.0 dB Attenuator and 1.0 dB cable) was entered as an offset in the power meter. Note: Actual cable loss was unavailable at the time of testing, therefore a loss of 1.0dB was assumed as worst case. This was later verified to be true by laboratory. ( if the RF cable provided by client, the cable loss declared by client)
3. The EUT is keeping in continuous transmission mode and tested in all modulation modes.

## 2.5 Measurement Method

Description of Test	Measurement Method
AC Line Conducted Emissions	ANSI C63.10-2020 Section 6.2
Maximum Conducted Output Power	ANSI C63.10-2020 Section 11.9.1.2 PKPM1 Peak power meter method or ANSI C63.10-2020 Section 11.9.2.3.2 Method AVGPM-G
Power Spectral Density	ANSI C63.10-2020 Section 11.10.2 Method PKPSD (peak PSD)
6 dB Emission Bandwidth	ANSI C63.10-2020 Section 11.8.1
99% Occupied Bandwidth	ANSI C63.10-2020 Section 6.9.3
100kHz Bandwidth of Frequency Band Edge	ANSI C63.10-2020 Section 6.10
Radiated emission	ANSI C63.10-2020 Section 11.11&11.12
Duty Cycle	ANSI C63.10-2020 Section 11.6

## 2.6 Measurement Equipment

Manufacturer	Description	Model	Management No.	Calibration Date	Calibration Due Date
<b>AC Line Conducted Emission Test</b>					
ROHDE& SCHWARZ	EMI TEST RECEIVER	ESR	101817	2023/7/3	2024/7/2
R&S	LISN	ENV216	101748	2023/8/1	2024/7/31
N/A	Coaxial Cable	NO.12	N/A	2023/7/3	2024/7/2
Farad	Test Software	EZ-EMC	Ver. EMEC-3A1	/	/
<b>Radiated Emission Test</b>					
R&S	EMI test receiver	ESR3	102758	2023/7/3	2024/7/2
ROHDE& SCHWARZ	SPECTRUM ANALYZER	FSV40-N	101608	2023/7/3	2024/7/2
SONOMA INSTRUMENT	Low frequency amplifier	310	186014	2023/7/12	2024/7/11
COM-POWER	preamplifier	PAM-118A	18040152	2023/8/21	2024/8/20
COM-POWER	Amplifier	PAM-840A	461306	2023/8/8	2024/8/7
ETS	Passive Loop Antenna	6512	29604	2023/7/7	2024/7/6
SCHWARZBECK	Log - periodic wideband antenna	VULB 9163	9163-872	2023/7/7	2024/7/6
Astro Antenna Ltd	Horn antenna	AHA-118S	3015	2023/7/6	2024/7/5
Ducommun technologies	Horn Antenna	ARH-4223-02	1007726-03	2023/7/10	2024/7/9
Oulitong	Band Reject Filter	OBSF-2400-248 3.5-50N	OE02103119	2023/9/15	2024/9/14
N/A	Coaxial Cable	N/A	NO.9	2023/8/8	2024/8/7
N/A	Coaxial Cable	N/A	NO.10	2023/8/8	2024/8/7
N/A	Coaxial Cable	N/A	NO.11	2023/8/8	2024/8/7
Audix	Test Software	E3	191218 V9	/	/
<b>RF Conducted Test</b>					
ROHDE& SCHWARZ	SPECTRUM ANALYZER	FSU-26	200680/026	2023/7/12	2024/7/11
ANRITSU	USB Power Sensor	MA24418A	12620	2023/7/12	2024/7/11
narda	6dB attenuator	603-06-1	N/A	2023/7/26	2024/7/25

Note: All equipment is calibrated with valid calibrations. Each measurement data is traceable to the national or International standards.

### 3 Test Results

#### 3.1 Test Summary

FCC Rules	Description of Test	Result
§15.203	Antenna Requirement	Compliance
§15.207 (a)	AC Line Conducted Emissions	Compliance
§15.247(b)(3)	Maximum Conducted Output Power	Compliance
§15.247(e)	Power Spectral Density	Compliance
§15.247 (a)(2)	6 dB Emission Bandwidth	Compliance
-	99% Occupied Bandwidth	Report only
§15.247(d)	100kHz Bandwidth of Frequency Band Edge	Compliance
§15.205, §15.209, §15.247(d)	Radiated emission	Compliance
-	Duty Cycle	Report only

### 3.2 Limit

Test items	Limit
AC Line Conducted Emissions	See details §15.207 (a)
Conducted Output Power	For systems using digital modulation in the 902-928 MHz, 2400-2483.5 MHz, and 5725-5850 MHz bands: 1 Watt.
6dB Emission Bandwidth	The minimum 6 dB bandwidth shall be at least 500 kHz.
Power Spectral Density	For digitally modulated systems, the power spectral density conducted from the intentional radiator to the antenna shall not be greater than 8 dBm in any 3 kHz band during any time interval of continuous transmission.
Spurious Emissions, 100kHz Bandwidth of Frequency Band Edge	In any 100 kHz bandwidth outside the frequency band in which the spread spectrum or digitally modulated intentional radiator is operating, the radio frequency power that is produced by the intentional radiator shall be at least 20 dB below that in the 100 kHz bandwidth within the band that contains the highest level of the desired power, based on either an RF conducted or a radiated measurement, provided the transmitter demonstrates compliance with the peak conducted power limits. If the transmitter complies with the conducted power limits based on the use of RMS averaging over a time interval, as permitted under paragraph (b)(3) of this section, the attenuation required under this paragraph shall be 30 dB instead of 20 dB. Attenuation below the general limits specified in §15.209(a) is not required. In addition, radiated emissions which fall in the restricted bands, as defined in §15.205(a), must also comply with the radiated emission limits specified in §15.209(a) (see §15.205(c)).

### 3.3 AC Line Conducted Emissions Test Data

<b>Test Date:</b>	2023-12-27	<b>Test By:</b>	Lirou Li
<b>Environment condition:</b>	Temperature: 22.5°C; Relative Humidity:43%; ATM Pressure: 101.2kPa		

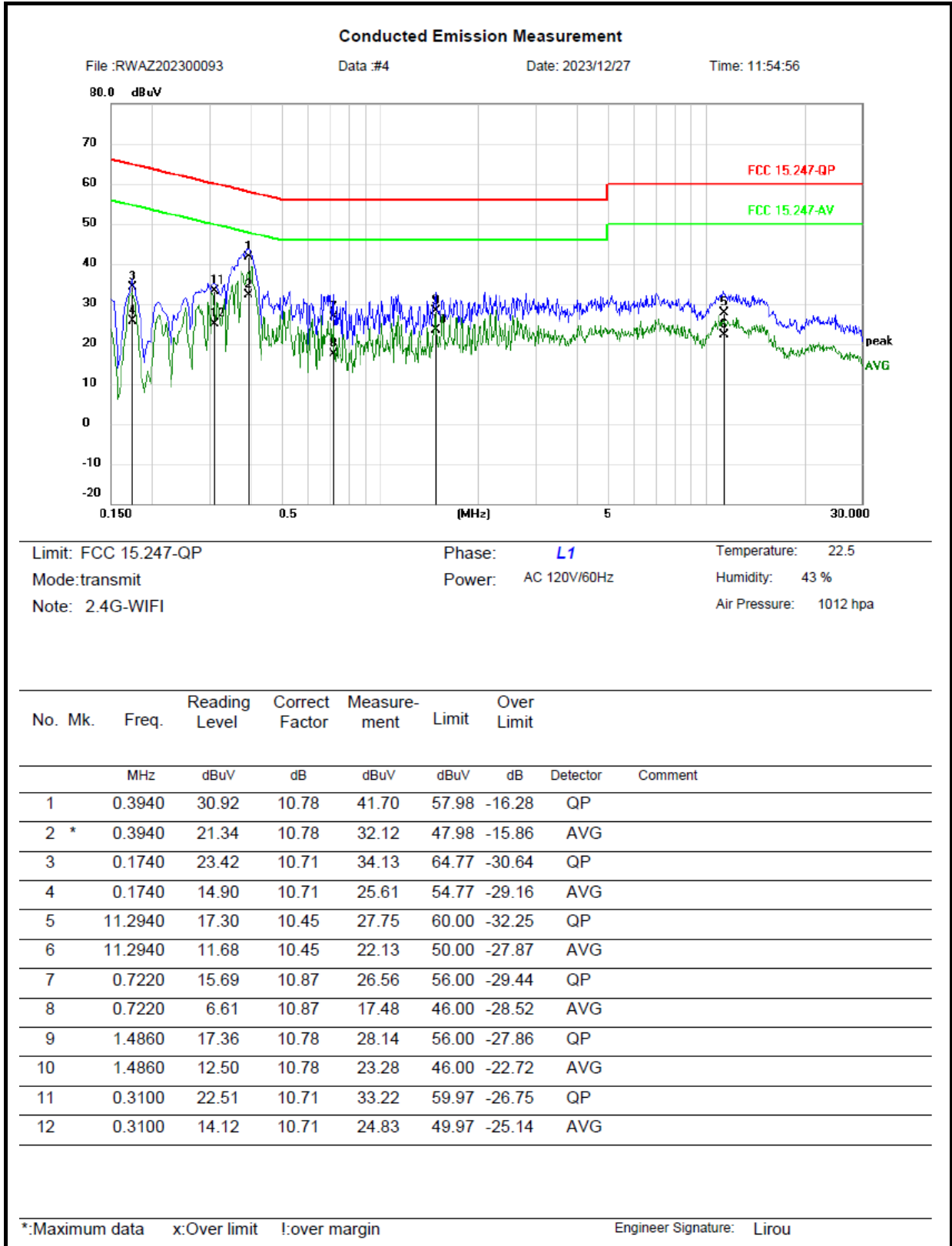

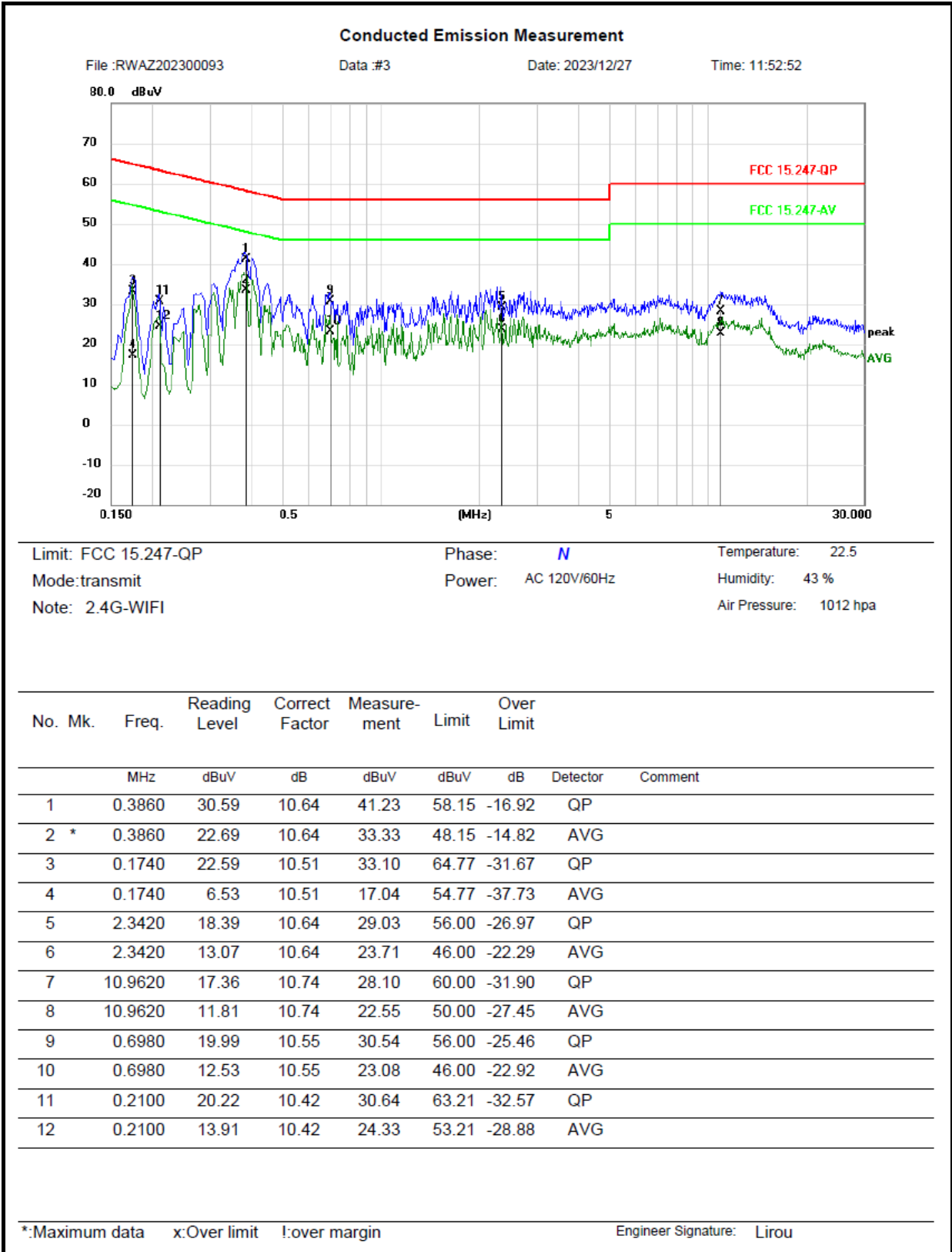

**Remark:**

Measurement (dBuV)= Reading Level (dBuV) + Correct Factor(dB)

Correct Factor (dB)= LISN Voltage Division Factor (dB)+ Cable loss(dB)

Over Limit = Measurement – Limit

### 3.4 Radiated emission Test Data

9 kHz-30MHz:

<b>Test Date:</b>	2023-12-26	<b>Test By:</b>	Bard Huang
<b>Environment condition:</b>	Temperature: 22.3°C; Relative Humidity: 31%; ATM Pressure: 101.8kPa		

For radiated emissions below 30MHz, there were no emissions found within 20dB of limit.



**30MHz-1GHz:**

<b>Test Date:</b>	2023-12-26	<b>Test By:</b>	Bard Huang
<b>Environment condition:</b>	Temperature: 22.3°C; Relative Humidity: 31%; ATM Pressure: 101.8kPa		

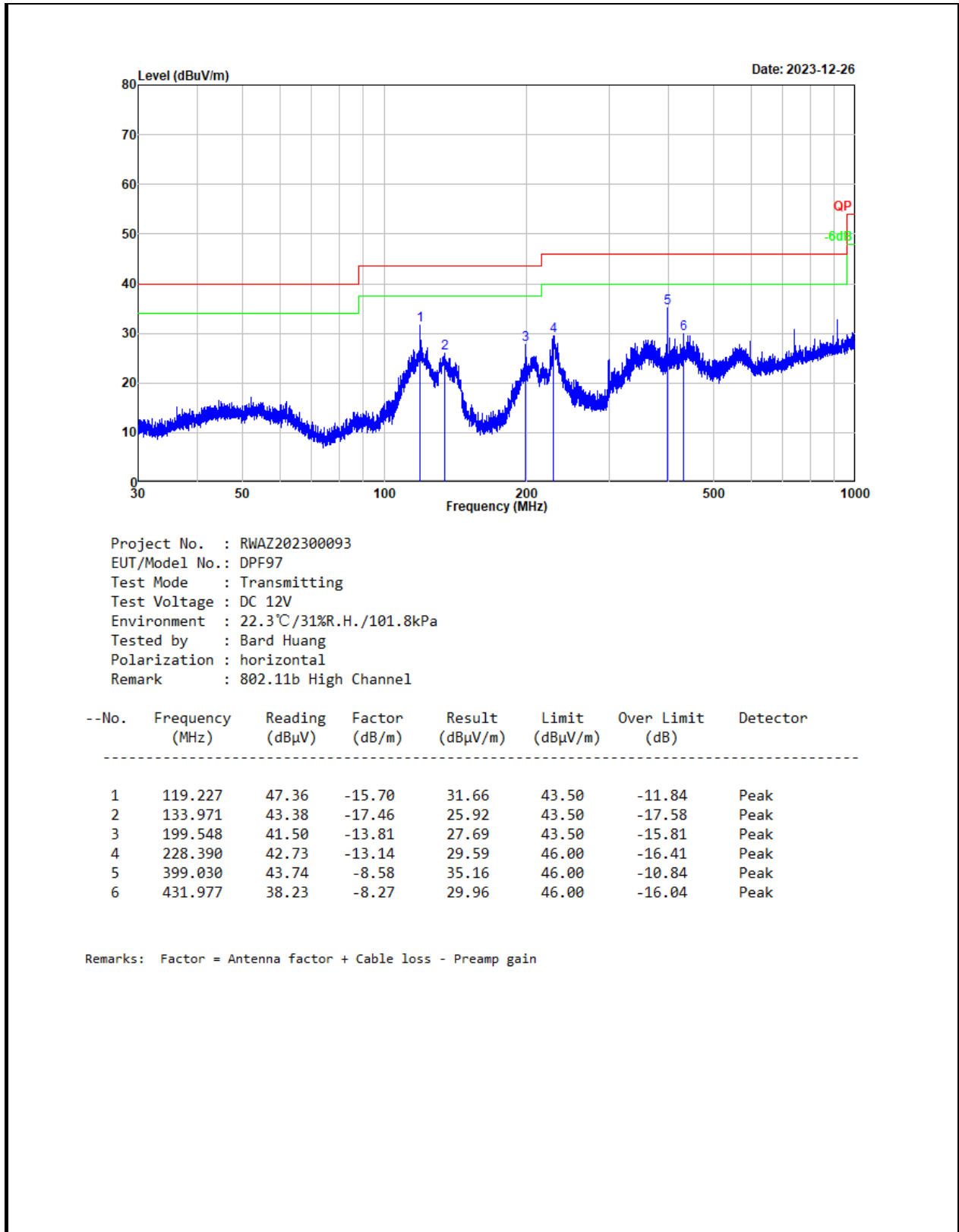

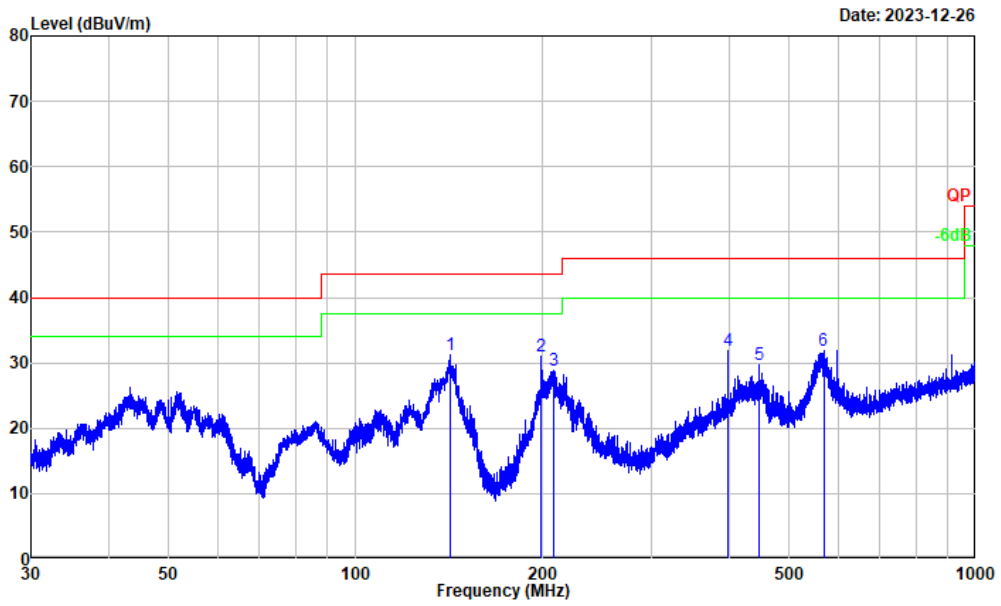

Project No. : RWAZ202300093  
 EUT/Model No.: DPF97  
 Test Mode : Transmitting  
 Test Voltage : DC 12V  
 Environment : 22.3°C/31%R.H./101.8kPa  
 Tested by : Bard Huang  
 Polarization : vertical  
 Remark : 802.11b High Channel

--No.	Frequency (MHz)	Reading (dBμV)	Factor (dB/m)	Result (dBμV/m)	Limit (dBμV/m)	Over Limit (dB)	Detector
1	141.951	48.76	-17.61	31.15	43.50	-12.35	Peak
2	199.460	44.72	-13.81	30.91	43.50	-12.59	Peak
3	208.763	42.63	-13.90	28.73	43.50	-14.77	Peak
4	399.030	40.42	-8.58	31.84	46.00	-14.16	Peak
5	447.982	37.96	-8.23	29.73	46.00	-16.27	Peak
6	568.364	37.70	-5.92	31.78	46.00	-14.22	Peak

Remarks: Factor = Antenna factor + Cable loss - Preamp gain

**Remark:**

*Level = Reading + Factor*

*Factor = Antenna factor + Cable loss – Amplifier gain*

*Over Limit = Level – Limit*

**Above 1GHz:**

<b>Test Date:</b>	2024-01-04	<b>Test By:</b>	Bard Huang
<b>Environment condition:</b>	Temperature: 24.5°C; Relative Humidity:49%; ATM Pressure: 101.4kPa		

Frequency (MHz)	Reading level (dBμV)	Polar	Corrected Factor (dB/m)	Corrected Amplitude (dBμV/m)	Limit (dBμV/m)	Margin (dB)	Remark
802.11b							
Low Channel							
2390.000	36.33	horizontal	8.25	44.58	54.00	-9.42	Average
2390.000	48.55	horizontal	8.25	56.80	74.00	-17.20	Peak
2390.000	36.78	vertical	8.25	45.03	54.00	-8.97	Average
2390.000	50.06	vertical	8.25	58.31	74.00	-15.69	Peak
4824.000	50.30	horizontal	0.26	50.56	54.00	-3.44	Average
4824.000	55.03	horizontal	0.26	55.29	74.00	-18.71	Peak
4824.000	50.12	vertical	0.26	50.38	54.00	-3.62	Average
4824.000	52.48	vertical	0.26	52.74	74.00	-21.26	Peak
Middle Channel							
4884.000	50.40	horizontal	0.46	51.86	54.00	-3.14	Average
4884.000	55.01	horizontal	0.46	55.47	74.00	-18.53	Peak
4884.000	49.95	vertical	0.46	51.41	54.00	-3.59	Average
4884.000	53.73	vertical	0.46	54.19	74.00	-19.81	Peak
High Channel							
2483.652	38.91	horizontal	8.25	47.16	54.00	-6.84	Average
2483.652	60.90	horizontal	8.25	69.15	74.00	-4.85	Peak
2483.512	40.90	vertical	8.25	49.15	54.00	-4.85	Average
2483.512	62.47	vertical	8.25	70.72	74.00	-3.28	Peak
4944.000	50.07	horizontal	0.83	50.90	54.00	-3.10	Average
4944.000	53.54	horizontal	0.83	54.37	74.00	-19.63	Peak
4944.000	49.92	vertical	0.83	50.75	54.00	-3.25	Average
4944.000	53.71	vertical	0.83	54.54	74.00	-19.46	Peak
802.11g							
Low Channel							
2390.000	37.12	horizontal	8.25	45.37	54.00	-8.63	Average
2390.000	49.01	horizontal	8.25	57.26	74.00	-16.74	Peak
2390.000	37.34	vertical	8.25	45.59	54.00	-8.41	Average
2390.000	49.70	vertical	8.25	57.95	74.00	-16.05	Peak
4824.000	39.32	horizontal	0.26	39.58	54.00	-14.42	Average

4824.000	48.93	horizontal	0.26	49.19	74.00	-24.81	Peak
4824.000	38.96	vertical	0.26	39.22	54.00	-14.78	Average
4824.000	48.55	vertical	0.26	48.81	74.00	-25.19	Peak
Middle Channel							
4884.000	39.34	horizontal	0.46	39.80	54.00	-14.20	Average
4884.000	47.48	horizontal	0.46	47.94	74.00	-26.06	Peak
4884.000	38.81	vertical	0.46	39.27	54.00	-14.73	Average
4884.000	48.90	vertical	0.46	49.36	74.00	-24.64	Peak
High Channel							
2483.552	40.10	horizontal	8.25	48.35	54.00	-5.65	Average
2483.552	61.11	horizontal	8.25	69.36	74.00	-4.64	Peak
2483.512	40.80	vertical	8.25	49.05	54.00	-4.95	Average
2483.512	62.60	vertical	8.25	70.85	74.00	-3.15	Peak
4944.000	39.63	horizontal	0.83	40.46	54.00	-13.54	Average
4944.000	48.53	horizontal	0.83	49.36	74.00	-24.64	Peak
4944.000	39.41	vertical	0.83	40.24	54.00	-13.76	Average
4944.000	48.92	vertical	0.83	49.75	74.00	-24.25	Peak
802.11n20							
Low Channel							
2390.000	37.80	horizontal	8.25	46.05	54.00	-7.95	Average
2390.000	50.48	horizontal	8.25	58.73	74.00	-15.27	Peak
2390.000	37.68	vertical	8.25	45.93	54.00	-8.07	Average
2390.000	49.50	vertical	8.25	57.75	74.00	-16.25	Peak
4824.000	39.31	horizontal	0.26	39.57	54.00	-14.43	Average
4824.000	49.04	horizontal	0.26	49.30	74.00	-24.70	Peak
4824.000	38.91	vertical	0.26	39.17	54.00	-14.83	Average
4824.000	48.78	vertical	0.26	49.04	74.00	-24.96	Peak
Middle Channel							
4884.000	38.94	horizontal	0.46	39.40	54.00	-14.60	Average
4884.000	49.71	horizontal	0.46	50.17	74.00	-23.83	Peak
4884.000	38.69	vertical	0.46	39.15	54.00	-14.85	Average
4884.000	48.72	vertical	0.46	49.18	74.00	-24.82	Peak
High Channel							
2483.500	39.67	horizontal	8.25	47.92	54.00	-6.08	Average
2483.500	59.14	horizontal	8.25	67.39	74.00	-6.61	Peak
2483.552	40.84	vertical	8.25	49.09	54.00	-4.91	Average
2483.552	62.70	vertical	8.25	70.95	74.00	-3.05	Peak
4944.000	39.06	horizontal	0.83	39.89	54.00	-14.11	Average

4944.000	49.56	horizontal	0.83	50.39	74.00	-23.61	Peak
4944.000	39.13	vertical	0.83	39.96	54.00	-14.04	Average
4944.000	48.92	vertical	0.83	49.75	74.00	-24.25	Peak
802.11n40							
Low Channel							
2390.000	37.73	horizontal	8.25	45.98	54.00	-8.02	Average
2390.000	49.24	horizontal	8.25	57.49	74.00	-16.51	Peak
2390.000	37.94	vertical	8.25	46.19	54.00	-7.81	Average
2390.000	50.06	vertical	8.25	58.31	74.00	-15.69	Peak
4844.000	36.67	horizontal	0.30	36.97	54.00	-17.03	Average
4844.000	50.27	horizontal	0.30	50.57	74.00	-23.43	Peak
4844.000	38.91	vertical	0.30	39.21	54.00	-14.79	Average
4844.000	49.23	vertical	0.30	49.53	74.00	-24.47	Peak
Middle Channel							
4884.000	38.59	horizontal	0.46	39.05	54.00	-14.95	Average
4884.000	48.21	horizontal	0.46	48.67	74.00	-25.33	Peak
4884.000	38.67	vertical	0.46	39.13	54.00	-14.87	Average
4884.000	48.33	vertical	0.46	48.79	74.00	-25.21	Peak
High Channel							
2483.972	40.81	horizontal	8.25	49.06	54.00	-4.94	Average
2483.972	56.67	horizontal	8.25	64.92	74.00	-9.08	Peak
2483.582	42.35	vertical	8.25	50.60	54.00	-3.40	Average
2483.582	59.16	vertical	8.25	67.41	74.00	-6.59	Peak
4924.000	38.68	horizontal	0.69	39.37	54.00	-14.63	Average
4924.000	48.03	horizontal	0.69	48.72	74.00	-25.28	Peak
4924.000	38.59	vertical	0.69	39.28	54.00	-14.72	Average
4924.000	49.14	vertical	0.69	49.83	74.00	-24.17	Peak

Remark:

Corrected Amplitude= Reading level + corrected Factor

Corrected Factor = Antenna factor + Cable loss – Amplifier gain

Margin = Corrected Amplitude – Limit

The emission levels of other frequencies that were lower than the limit 20dB not show in test report.

For emissions in 18GHz-25GHz range, all emissions were investigated and in the noise floor level.

**Test plot for example as below:**

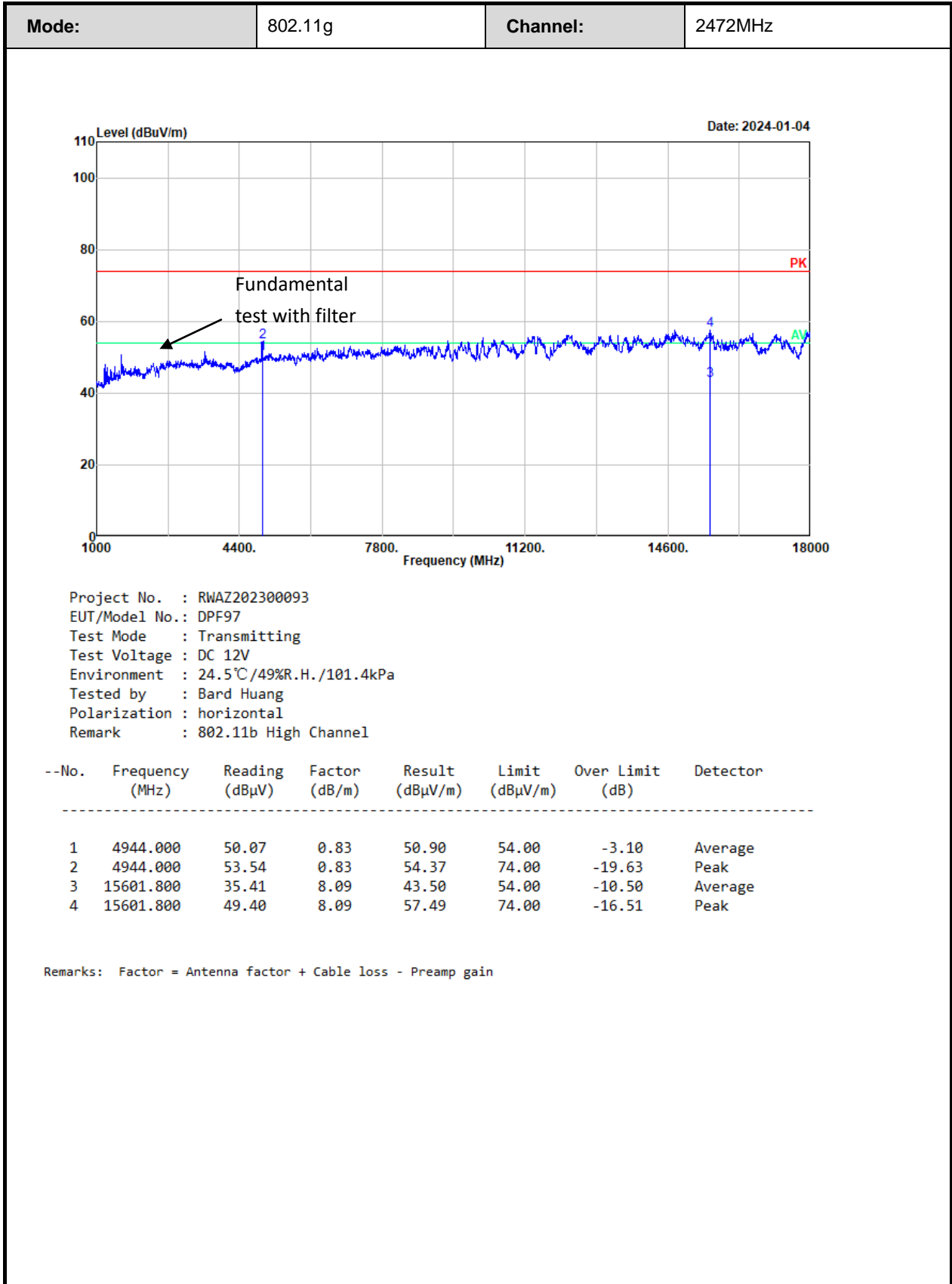

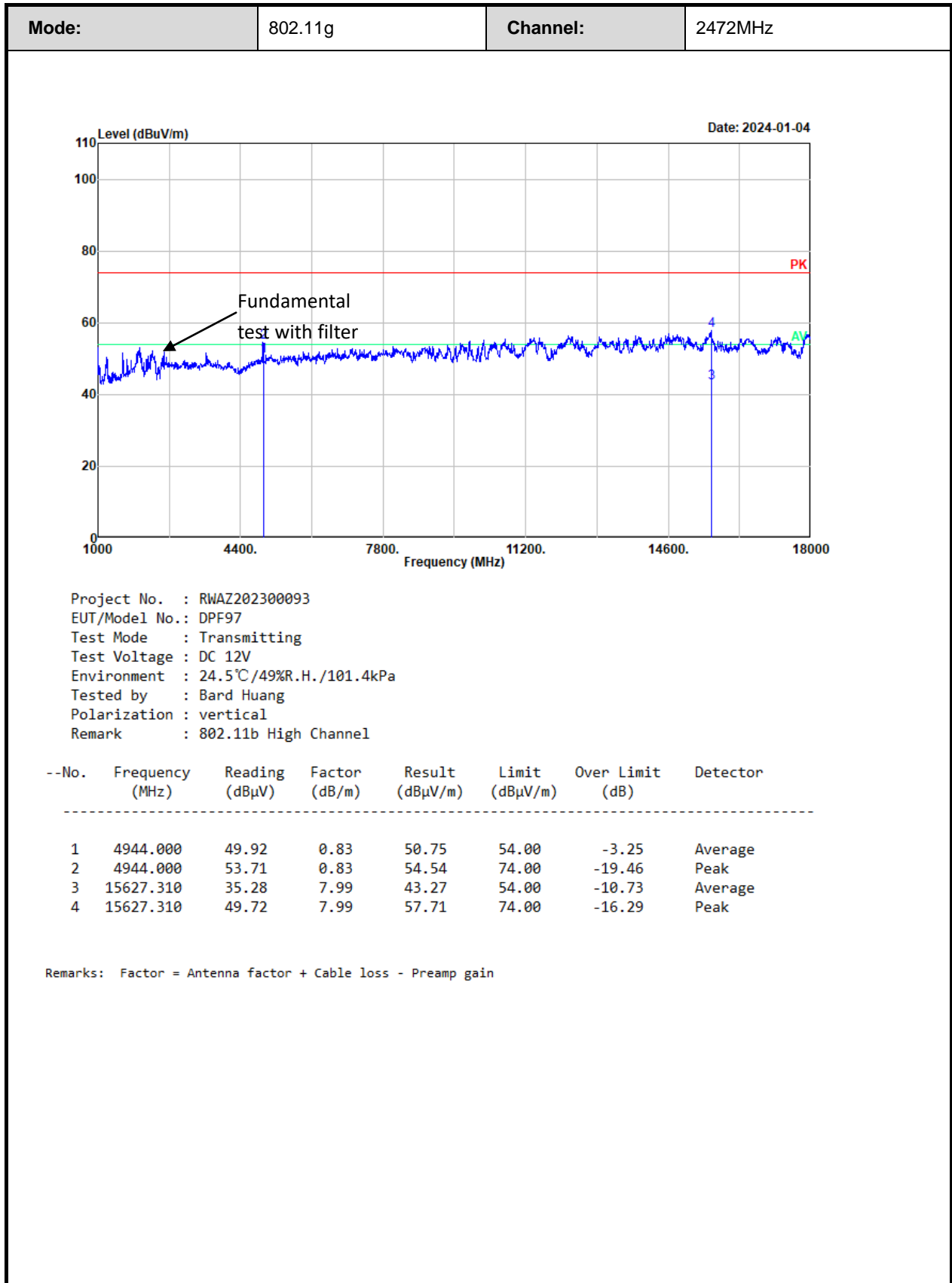

### 3.5 RF Conducted Test Data

<b>Test Date:</b>	2024-01-05	<b>Test By:</b>	Ryan Zhang
<b>Environment condition:</b>	Temperature: 21.5°C; Relative Humidity: 43.2%; ATM Pressure: 101.2kPa		

#### 3.5.1 6 dB Emission Bandwidth and 99% Occupied Bandwidth

Test Mode	Antenna	Channel	6dB BW [MHz]	99% OBW[MHz]	6dB BW Limit[MHz]	Verdict
11B	Ant1	2412	9.038	13.397	0.5	pass
		2442	9.103	13.397	0.5	pass
		2472	9.103	13.462	0.5	pass
11G	Ant1	2412	16.487	16.667	0.5	pass
		2442	16.462	16.731	0.5	pass
		2472	16.449	16.795	0.5	pass
11N20SISO	Ant1	2412	17.628	17.821	0.5	pass
		2442	17.372	17.756	0.5	pass
		2472	17.346	17.756	0.5	pass
11N40SISO	Ant1	2422	35.590	36.667	0.5	pass
		2442	36.410	36.538	0.5	pass
		2462	36.282	36.538	0.5	pass

#### 3.5.2 Maximum Conducted Peak Output Power

Test Mode	Antenna	Channel [MHz]	Result [dBm]	Limit [dBm]	Verdict
11B SISO	Ant1	2412	8.21	30	Pass
		2442	8.75	30	Pass
		2472	8.88	30	Pass
11G SISO	Ant1	2412	4.57	30	Pass
		2442	5.10	30	Pass
		2472	5.11	30	Pass
11N20 SISO	Ant1	2412	3.46	30	Pass
		2442	3.98	30	Pass
		2472	4.02	30	Pass
11N40 SISO	Ant1	2422	1.40	30	Pass
		2442	1.78	30	Pass
		2462	1.81	30	Pass



### 3.5.3 Power Spectral Density

Test Mode	Antenna	Channel [MHz]	Result [dBm/3kHz]	Limit [dBm/3kHz]	Verdict
11B SISO	Ant1	2412	-19.28	8	Pass
		2442	-18.15	8	Pass
		2472	-17.11	8	Pass
11G SISO	Ant1	2412	-27.02	8	Pass
		2442	-26.54	8	Pass
		2472	-26.50	8	Pass
11N20 SISO	Ant1	2412	-27.04	8	Pass
		2442	-26.33	8	Pass
		2472	-26.37	8	Pass
11N40 SISO	Ant1	2422	-26.73	8	Pass
		2442	-26.50	8	Pass
		2462	-26.37	8	Pass

### 3.5.4 100 kHz Bandwidth of Frequency Band Edge

Test Mode	Antenna	Channel	Result	Limit	Verdict
11B SISO	Ant1	2412	Refer test plot	Refer test plot	Pass
		2472	Refer test plot	Refer test plot	Pass
11G SISO	Ant1	2412	Refer test plot	Refer test plot	Pass
		2472	Refer test plot	Refer test plot	Pass
11N20 SISO	Ant1	2412	Refer test plot	Refer test plot	Pass
		2472	Refer test plot	Refer test plot	Pass
11N40 SISO	Ant1	2422	Refer test plot	Refer test plot	Pass
		2462	Refer test plot	Refer test plot	Pass

### 3.5.5 Duty Cycle

Test Mode	Antenna	Channel	Ton (ms)	Ton+off (ms)	Duty Cycle [%]	1/T [kHz]	VBW setting* [Hz]
11B	Ant1	2442	12.451	12.596	98.85	/	10
11G	Ant1	2442	2.074	2.210	93.85	0.482	500
11N20	Ant1	2442	1.918	2.045	93.79	0.521	1000
11N40	Ant1	2442	0.936	1.117	83.80	1.068	2000

Note\*: Radiated emission test with average value, the Spectrum analyzer VBW setting information.

# Test Plots:

## 6 dB Emission Bandwidth:

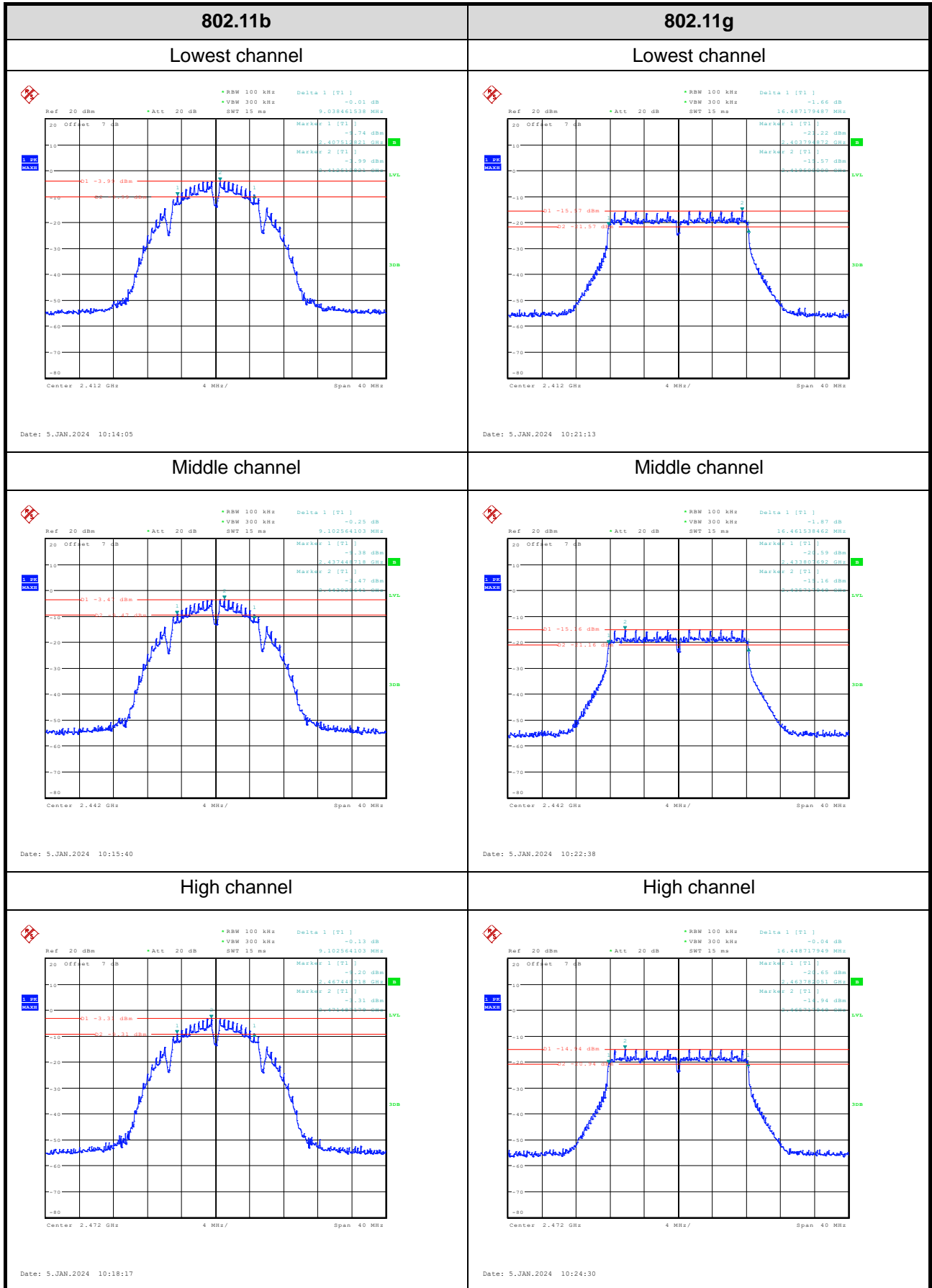

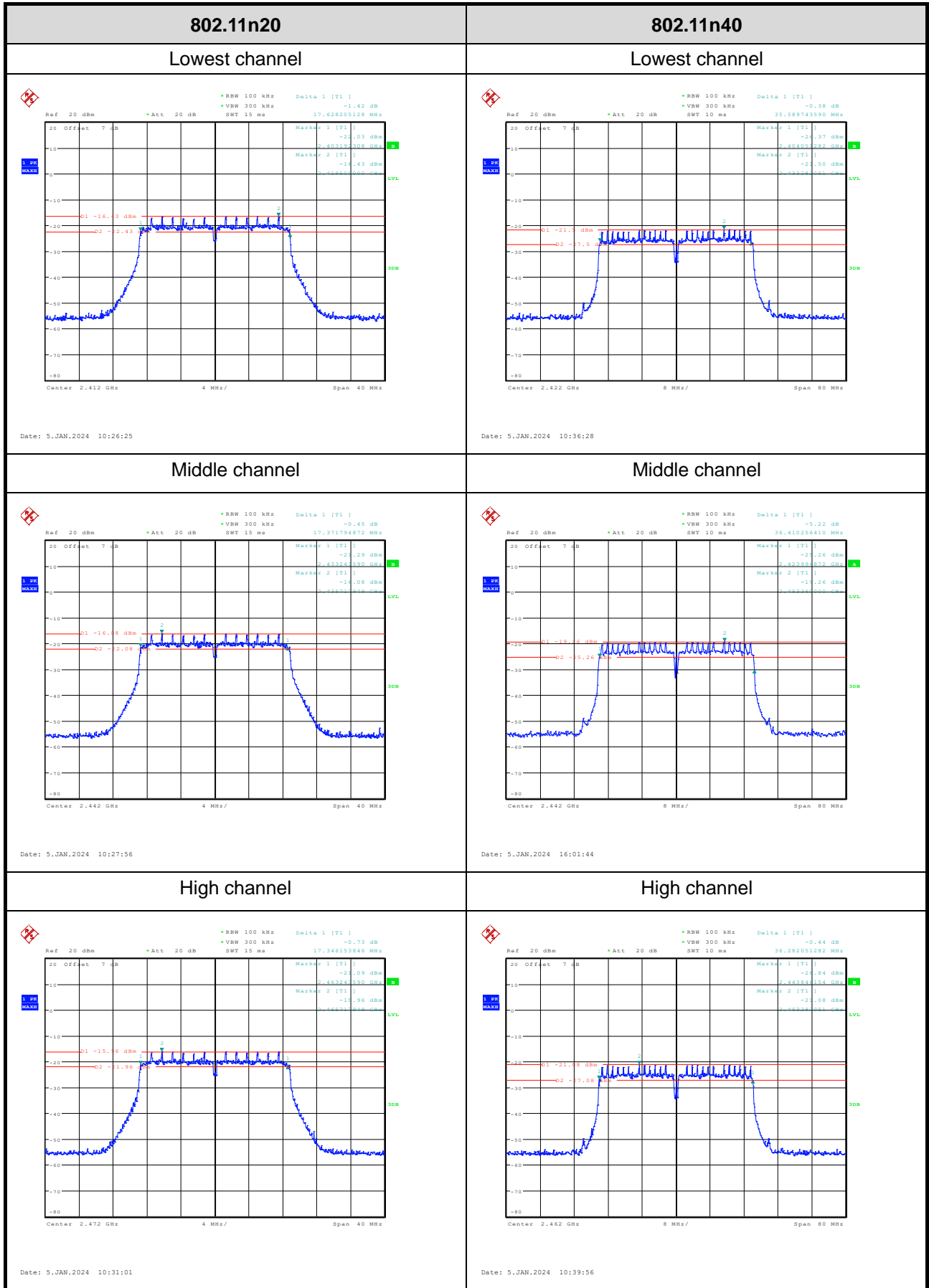

**99% Occupied Bandwidth:**

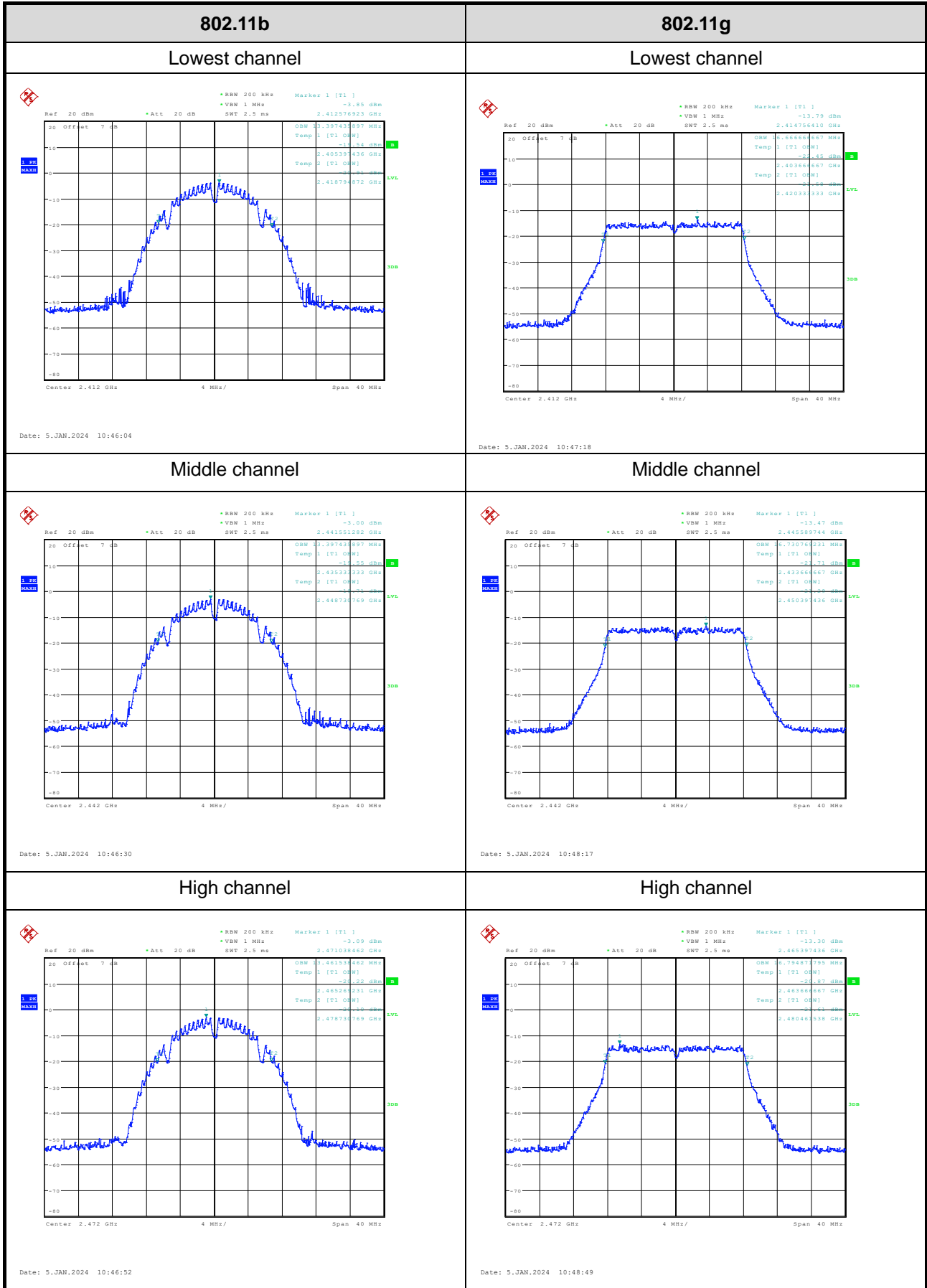

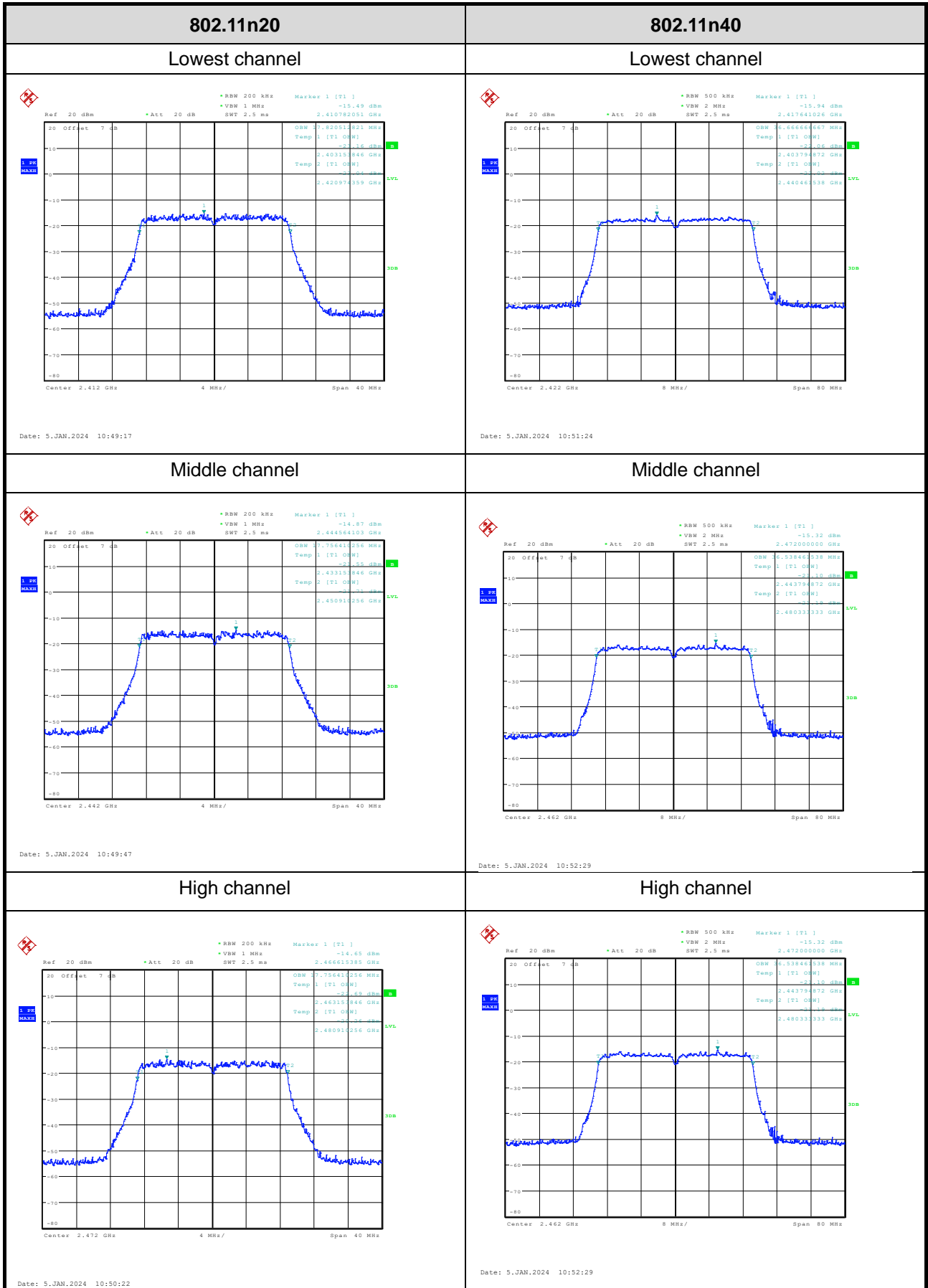

**Power Spectral Density:**

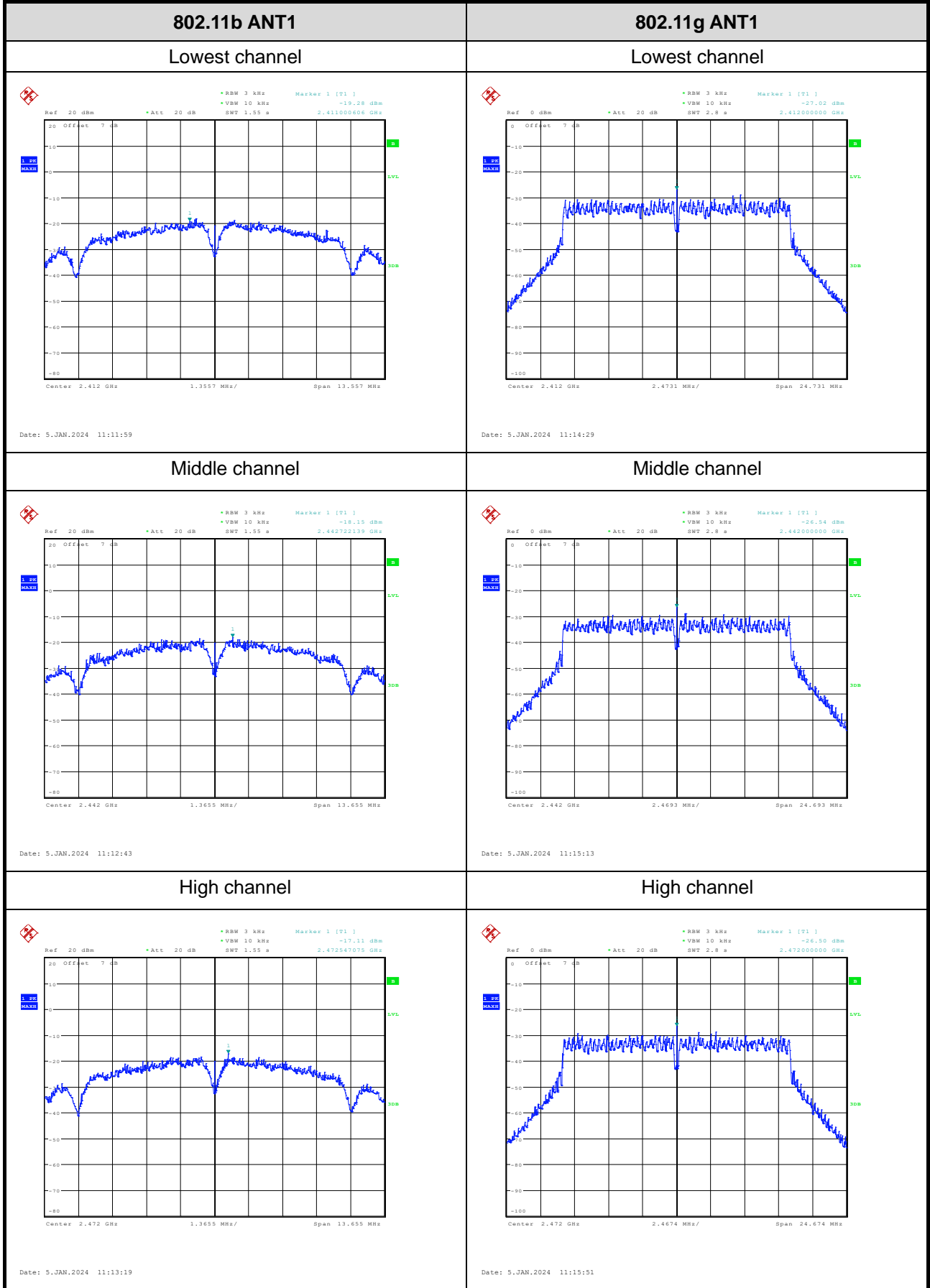

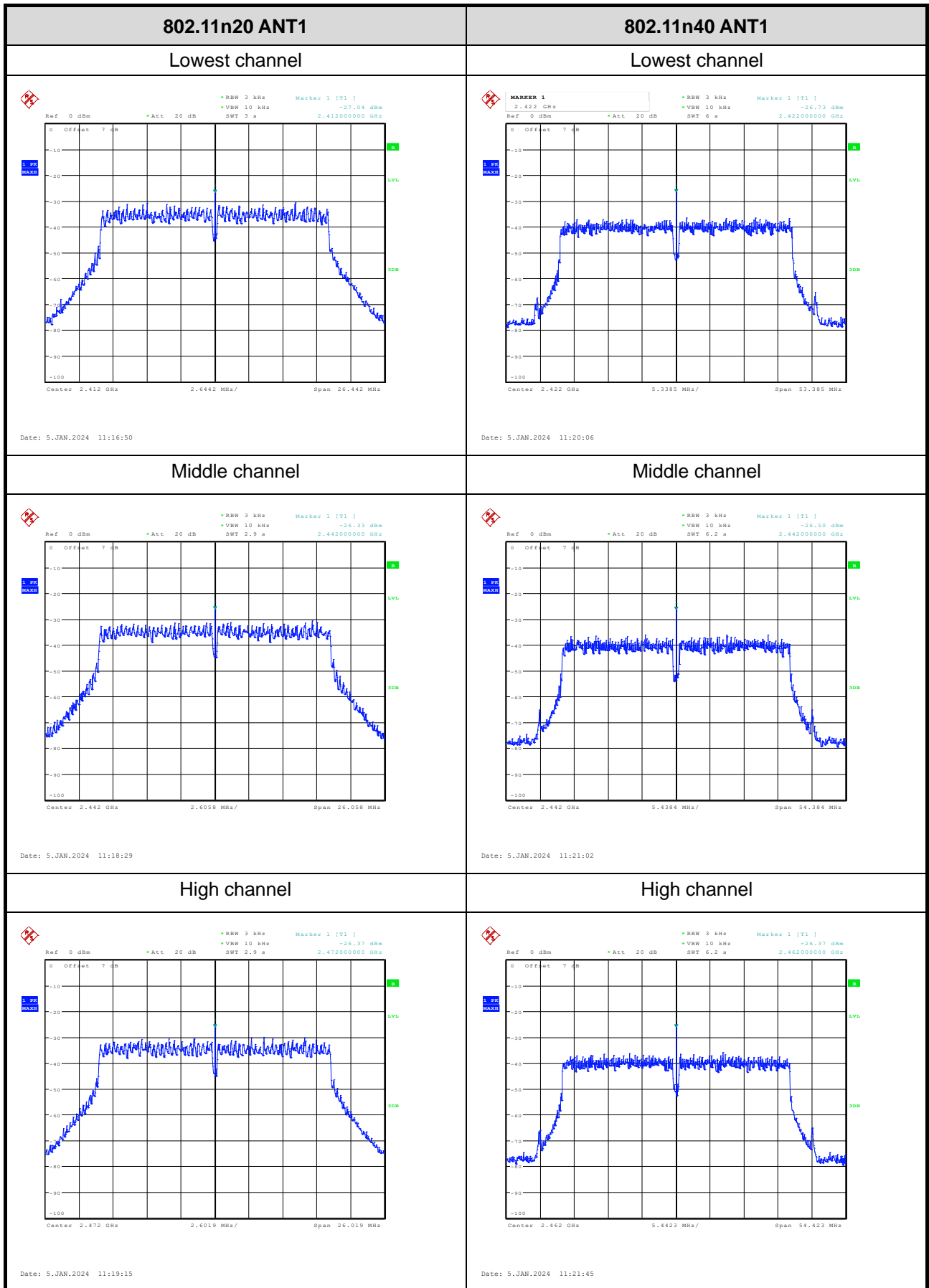

**100kHz Bandwidth of Frequency Band Edge:**

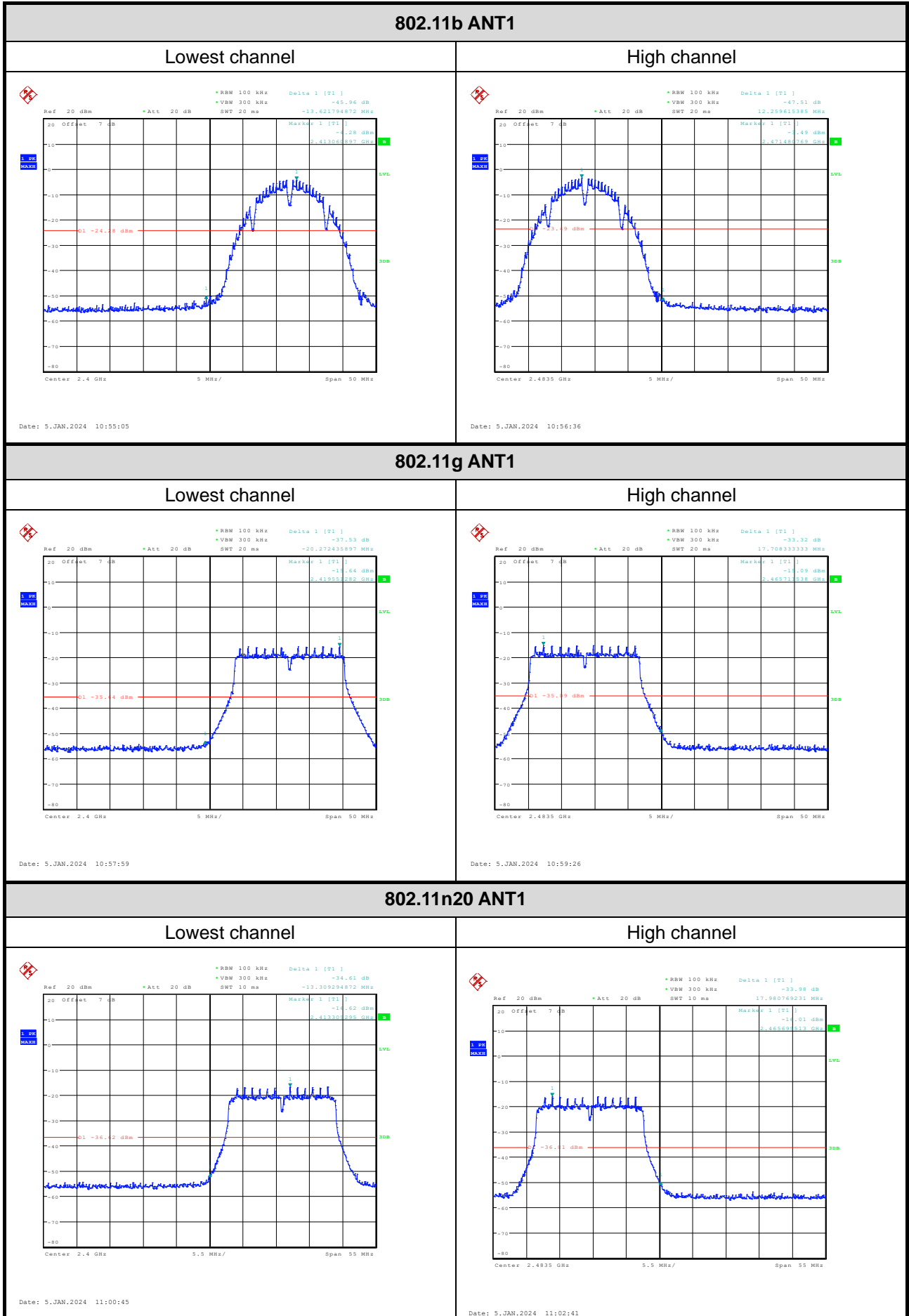



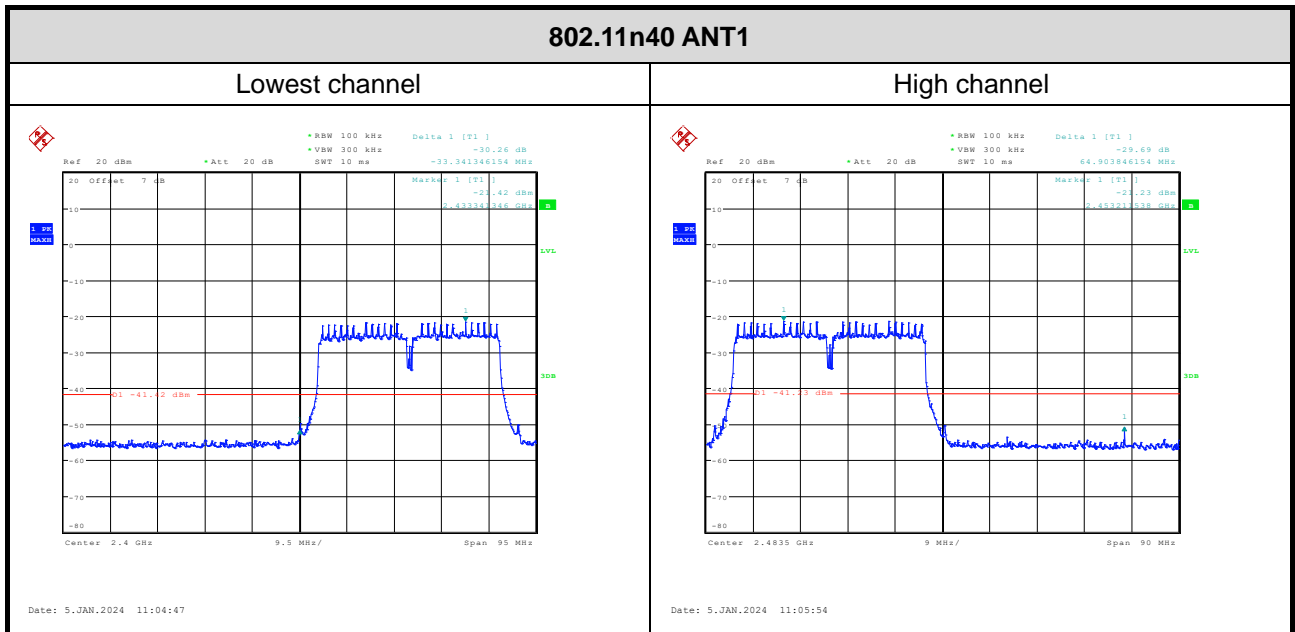

**Duty Cycle:**

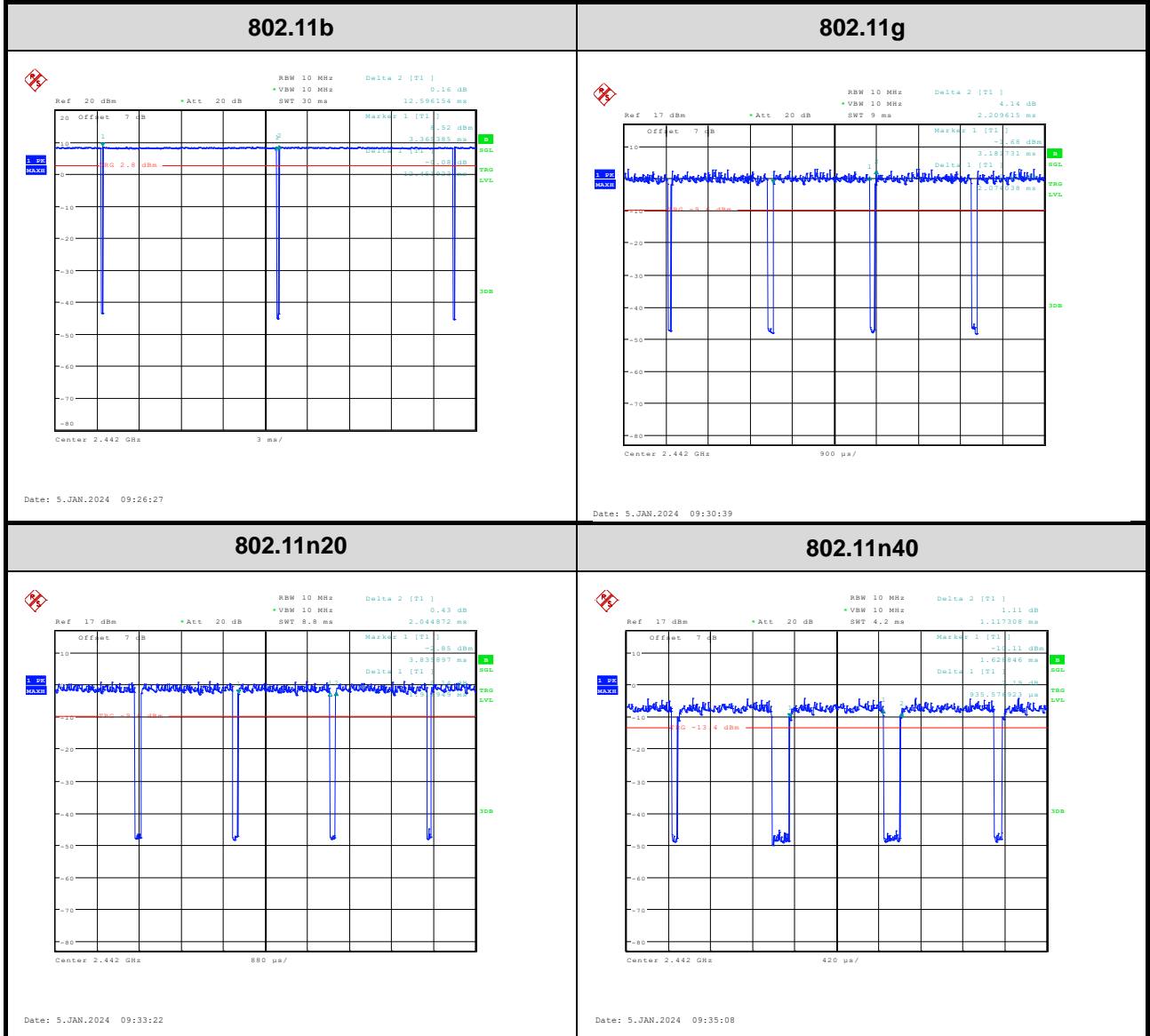

## 4 Test Setup Photo

Please refer to the attachment RWAZ202300093 Test Setup photo.

## 5 E.U.T Photo

Please refer to the attachment RWAZ202300093 External photo and RWAZ202300093 Internal photo.

**---End of Report---**