

Test Report of FCC CFR 47 Part 15 Subpart C

On Behalf of

Shenzhenshi Chuangzhicheng Technology Co.,Ltd.

FCC ID: 2ABBUB10T

Product Description: Tablet PC

Model No.: B10T

Supplementary Model: N/A

Brand Name: CZC

Prepared for: Shenzhenshi Chuangzhicheng Technology Co.,Ltd.

801,Tower C,Languang Technology Bldg,No.7 Xin' xi Rd,North
District,Sci-tech Park,Nanshan District,Shenzhen

Prepared by: Bontek Compliance Testing Laboratory Co., Ltd

1/F, Block East H-3, OCT Eastern Ind. Zone, Qiaocheng East
Road, Nanshan, Shenzhen, China

Tel: 86-755-86337020

Fax: 86-755-86337028

Report No.: BCT13JR337E-2

Issue Date: November 7, 2013

Test Date: October 9~November 6, 2013

Tested by:

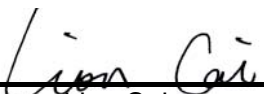
Lion Cai

Reviewed by:

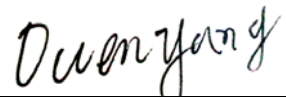
Owen Yang

Approved by:



Kendy Wang

TABLE OF CONTENTS

1. GENERAL INFORMATION..... 4
1.1 PRODUCT DESCRIPTION FOR EQUIPMENT UNDER TEST (EUT)..... 4
1.2 TEST STANDARDS 5
1.3 TEST FACILITY 5

2. SYSTEM TEST CONFIGURATION 6
2.1 EUT CONFIGURATION 6
2.2 SUPPORT EQUIPMENT 6
2.3 GENERAL TEST PROCEDURES 6
2.4 MEASUREMENT UNCERTAINTY 6
2.5 LIST OF MEASURING EQUIPMENTS USED 7

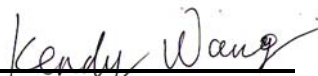
3. SUMMARY OF TEST RESULTS..... 9

4. TEST OF AC POWER LINE CONDUCTED EMISSION 10
4.1 APPLICABLE STANDARD..... 10
4.2 TEST SETUP DIAGRAM 10
4.3 TEST RESULT 10

5. TEST OF HOPPING CHANNEL BANDWIDTH..... 13
5.1 APPLICABLE STANDARD..... 13
5.2 EUT SETUP 13
5.3 TEST EQUIPMENT LIST AND DETAILS 13
5.4 TEST PROCEDURE 13
5.5 TEST RESULT 13

6. TEST OF HOPPING CHANNEL SEPARATION 19
6.1 APPLICABLE STANDARD..... 19
6.2 EUT SETUP 19
6.3 TEST EQUIPMENT LIST AND DETAILS 19
6.4 TEST PROCEDURE 19
6.5 TEST RESULT 19

7. TEST OF NUMBER OF HOPPING FREQUENCY 26
7.1 APPLICABLE STANDARD..... 26
7.2 EUT SETUP 26
7.3 TEST EQUIPMENT LIST AND DETAILS 26
7.4 TEST PROCEDURE 26
7.5 TEST RESULT 26

8. TEST OF DWELL TIME OF EACH FREQUENCY 29
8.1 APPLICABLE STANDARD..... 29
8.2 EUT SETUP 29
8.3 TEST EQUIPMENT LIST AND DETAILS 29
8.4 TEST PROCEDURE 29
8.5 TEST RESULT 29

9. TEST OF MAXIMUM PEAK OUTPUT POWER 46
9.1 APPLICABLE STANDARD..... 46
9.2 EUT SETUP 46
9.3 TEST EQUIPMENT LIST AND DETAILS 46
9.4 TEST PROCEDURE 46
9.5 TEST RESULT 47

10. TEST OF BAND EDGES EMISSION..... 53
10.1 APPLICABLE STANDARD..... 53
10.2 EUT SETUP 53
10.3 TEST EQUIPMENT LIST AND DETAILS 53
10.4 TEST PROCEDURE 53
10.5 TEST RESULT 54

11. TEST OF SPURIOUS RADIATED EMISSION	58
11.1 APPLICABLE STANDARD.....	58
11.2 EUT SETUP.....	58
11.3 TEST EQUIPMENT LIST AND DETAILS.....	59
11.4 TEST PROCEDURE	59
11.5 TEST RESULT	60
12. ANTENNA REQUIREMENT	70
12.1 STANDARD APPLICABLE.....	70
12.2 ANTENNA CONNECTED CONSTRUCTION	70

1. GENERAL INFORMATION

1.1 Product Description for Equipment Under Test (EUT)

Client Information

Applicant:	Shenzhenshi Chuangzhicheng Technology Co.,Ltd.
Address of Applicant:	801,Tower C,Languang Technology Bldg,No.7 Xin'xi Rd,North District,Sci-tech Park,Nanshan District,Shenzhen
Manufacturer:	Shenzhenshi Chuangzhicheng Technology Co.,Ltd.
Address of Manufacturer:	801,Tower C,Languang Technology Bldg,No.7 Xin'xi Rd,North District,Sci-tech Park,Nanshan District,Shenzhen

General Description of E.U.T

Items	Description
EUT Description:	Tablet PC
Model No.:	B10T
Supplementary Model:	N/A
Trade Name:	CZC
Frequency Band:	2402 MHz ~ 2480 MHz
Channel Spacing:	1 MHz
Number of Channels:	79
Type of Modulation:	GFSK, Pi/4 DQPSK, 8-DPSK
Antenna Type:	Built-in Antenna
Antenna Gain:	1.9dBi
Rated Voltage:	Input: 12VDC 2.0A from AC/DC adapter
Adapter description:	1#: Model No: FJ-SW1202000N; Manufacturer: SHENZHEN FU JIA APPLIANCE CO., LTD. Input: 100-240V 50/60Hz 0.6A Max ; Output:12.0V 2.0A 2#: Model No: DSA-24CA-12 120200 Manufacturer: DEE VAN ENTERPRISE CO., LTD. Input: 100-240V 50/60Hz 0.8A Max ; Output:12.0V 2.0A

Remark: * The test data gathered are from the production sample provided by the manufacturer.

1.2 Test Standards

The tests were performed based on the Electromagnetic Interference (EMI) tests performed on the EUT. Both conducted and radiated testing were performed according to the procedures in ANSI C63.4 - 2003 Radiated testing was performed at an antenna to EUT distance 3 meters.

The tests were performed in order to determine compliance with FCC Part 15, Subpart C, and section 15.203, 15.207, 15.209 and 15.247 rules. Test was carried out according to the above mentioned FCC rules and the FCC publication notice DA 00-705: Filing and Measurement Guidelines for Frequency Hopping Spread Spectrum Systems

1.3 Test Facility

All measurement required was performed at laboratory of Bontek Compliance Testing Laboratory Ltd at 1/F, Block East H-3, OCT Eastern Ind. Zone, Qiaocheng East Road, Nanshan, Shenzhen, China.

The test facility is recognized, certified, or accredited by the following organizations:

FCC – Registration No.: 338263

BONTEK COMPLIANCE TESTING LABORATORY LTD. EMC Laboratory has been registered and fully described in a report filed with the (FCC) Federal Communications Commission. The acceptance letter from the FCC is maintained in our files. Registration 338263, March 03, 2011.

IC Registration No.: 7631A

The 3m alternate test site of BONTEK COMPLIANCE TESTING LABORATORY LTD. EMC Laboratory has been registered by Certification and Engineer Bureau of Industry Canada for the performance of with Registration NO.: 7631A on January 25, 2011.

CNAS - Registration No.: L3923

BONTEK COMPLIANCE TESTING LABORATORY LTD. to ISO/IEC 17025:25 General Requirements for the Competence of Testing and Calibration Laboratories(CNAS-CL01 Accreditation Criteria for the Competence of Testing and Calibration Laboratories) for the competence in the field of testing. The acceptance letter from the CNAS is maintained in our files: Registration: L3923, March 22, 2012.

TUV - Registration No.: UA 50242657-0001

BONTEK COMPLIANCE TESTING LABORATORY LTD. An assessment of the laboratory was conducted according to the "Procedures and Conditions for EMC Test Laboratories" with reference to EN ISO/IEC 17025 by a TUV Rheinland auditor. Audit Report NO. 17010783-002.

2. SYSTEM TEST CONFIGURATION

2.1 EUT Configuration

The EUT configuration for testing is installed on RF field strength measurement to meet the Commissions requirement and operating in a manner that intends to maximize its emission characteristics in a continuous normal application.

2.2 Support Equipment

The calibrated antennas used to sample the radiated field strength are mounted on a non-conductive, motorized antenna mast 3 or 10 meters from the leading edge of the turntable.

Support equipments or special accessories in test configuration:

AUX Description:	Manufacturer	Model No.	Certificate	CABLE
Host Computer	Dell	78MD82X	CE, FCC	1.5m Unshielded Power Cord
Monitor	Dell	E178Pc	CE, FCC	1.5m Unshielded Power Cord 1.8m shielded data Cable with core
Keyboard	Dell	L100	CE, FCC	1.8m shielded data Cable with core
LCD Colour TV	SHARP	LCD-32Z330A	CE, FCC	1.2m Unshielded Power Cord 1.5m shielded data Cable with core

2.3 General Test Procedures

Conducted Emissions: The EUT is placed on the turntable, which is 0.8 m above ground plane. According to the requirements in Section 7.1 of ANSI C63.4-2003 Conducted emissions from the EUT measured in the frequency range between 0.15 MHz and 30MHz using CISPR Quasi-Peak detector mode.

Radiated Emissions: The EUT is placed on as turntable, which is 0.8 m above ground plane. The turntable shall rotate 360 degrees to determine the position of maximum emission level. EUT is set 3m away from the receiving antenna, which varied from 1m to 4m to find out the highest emission. And also, each emission was to be maximized by changing the polarization of receiving antenna both horizontal and vertical. In order to find out the maximum emissions, exploratory radiated emission measurements were made according to the requirements in Section 13.1.4.1 of ANSI C63.4-2009.

2.4 Measurement Uncertainty

Where relevant, the following measurement uncertainty levels have been estimated for tests performed on the apparatus:

Parameter	Uncertainty
Power Line Conducted Emission	+/- 2.3 dB
Radiated Emission	+/- 3.4 dB

Uncertainty figures are valid to a confidence level of 95%.

2.5 List of Measuring Equipments Used

Test equipments list of Shenzhen Bontek Compliance Testing Laboratory Co., Ltd.

No.	Instrument no.	Equipment	Manufacturer	Model No.	S/N	Last Calculator	Due Calculator
1	BCT-EMC001	EMI Test Receiver	R&S	ESCI	100687	2013-4-16	2014-4-17
2	BCT-EMC002	EMI Test Receiver	R&S	ESPI	100097	2013-11-1	2014-10-31
3	BCT-EMC003	Amplifier	HP	8447D	1937A02492	2013-4-19	2014-4-18
4	BCT-EMC004	Single Power Conductor Module	R&S	NNBM 8124	242	2013-4-19	2014-4-18
5	BCT-EMC005	Single Power Conductor Module	R&S	NNBM 8124	243	2013-4-19	2014-4-18
6	BCT-EMC006	Power Clamp	SCHWARZBECK	MDS-21	3812	2013-11-5	2014-11-4
7	BCT-EMC007	Positioning Controller	C&C	CC-C-1F	MF7802113	N/A	N/A
8	BCT-EMC008	Electrostatic Discharge Simulator	TESEQ	NSG437	125	2013-11-2	2014-11-1
9	BCT-EMC009	Fast Transient Burst Generator	SCHAFFNER	MODULA6150	34572	2013-4-16	2014-4-17
10	BCT-EMC010	Fast Transient Noise Simulator	Noiseken	FNS-105AX	10501	2013-6-26	2014-6-25
11	BCT-EMC011	Color TV Pattern Generator	PHILIPS	PM5418	TM209947	N/A	N/A
12	BCT-EMC012	Power Frequency Magnetic Field Generator	EVERFINE	EMS61000-8K	608002	2013-4-16	2014-4-17
14	BCT-EMC014	Capacitive Coupling Clamp	TESEQ	CDN8014	25096	2013-4-16	2014-4-17
15	BCT-EMC015	High Field Biconical Antenna	ELECTRO-METRICS	EM-6913	166	2012-11-28	2013-11-27
16	BCT-EMC016	Log Periodic Antenna	ELECTRO-METRICS	EM-6950	811	2012-11-28	2013-11-27
17	BCT-EMC017	Remote Active Vertical Antenna	ELECTRO-METRICS	EM-6892	304	2012-11-28	2013-11-27
18	BCT-EMC018	TRILOG Broadband Test-Antenna	SCHWARZBECK	VULB9163	9163-324	2012-5-19	2014-5-18
19	BCT-EMC019	Horn Antenna	SCHWARZBECK	BBHA9120A	0499	2012-11-28	2013-11-27
20	BCT-EMC020	Teo Line Single Phase Module	SCHWARZBECK	NSLK8128	8128247	2013-11-1	2014-10-31
21	BCT-EMC021	Triple-Loop Antenna	EVERFINE	LLA-2	711002	2013-11-15	2014-11-14
22	BCT-EMC022	Electric bridge	Jhai	JK2812C	803024	N/A	N/A
23	BCT-EMC026	RF POWER AMPLIFIER	FRANKONIA	FLL-75	1020A1109	2013-4-16	2014-4-17
24	BCT-EMC027	CDN	FRANKONIA	CDN M2+M3	A3027019	2013-4-16	2014-4-17

25	BCT-EMC029	6DB Attenuator	FRANKONIA	N/A	1001698	2013-4-16	2014-4-17
26	BCT-EMC030	EM Injection clamp	FCC	F-203I-23mm	091536	2013-4-16	2014-4-17
27	BCT-EMC031	9kHz-2.4GHz signal generator 2024	MARCONI	10S/6625-99-457-8730	112260/042	2013-4-16	2014-4-17
28	BCT-EMC032	10dB attenuator	ELECTRO-METRICS	EM-7600	836	2013-4-16	2014-4-17
29	BCT-EMC033	ISN	TESEQ	ISN-T800	30301	2013-11-15	2014-11-14
30	BCT-EMC034	10KV surge generator	SANKI	SKS-0510M	048110003E321	2013-11-01	2014-10-31
31	BCT-EMC035	HRMONICS&FLICKRE ANALYSER	VOLTECH	PM6000	200006700433	2012-11-20	2013-11-19
32	BCT-EMC036	Spectrum Analyzer	R&S	FSP	100397	2013-11-1	2014-10-31
33	BCT-EMC037	Broadband preamplifier	SCHWARZBECK	BBV9718	9718-182	2013-4-19	2014-4-18

3. SUMMARY OF TEST RESULTS

FCC Rules	Description of Test	Result
FCC §15.207	AC Power Line Conducted Emission	N/A
FCC §15.247(a)(1)	Hopping Channel Bandwidth	Pass
FCC §15.247(a)(1)	Hopping Channel Separation	Pass
FCC §15.247(a)(1)	Number of Hopping Frequency Used	Pass
FCC §15.247(a)(1)(iii)	Dwell Time of Each Frequency	Pass
FCC §15.247(b)(1)	Maximum Peak Output Power	Pass
FCC §15.247(d)	Band Edges Emission	Pass
FCC §15.247(d)	Spurious Radiated Emission	Pass
FCC §15.203/15.247(b)/(c)	Antenna Requirement	Pass

4. TEST OF AC POWER LINE CONDUCTED EMISSION

4.1 Applicable Standard

Refer to FCC §15.207.

For a Low-power Radio-frequency Device is designed to be connected to the AC power line, the radio frequency voltage that is conducted back onto the AC power line on any frequency or frequencies within the band 150 kHz to 30 MHz shall not exceed below limits table.

Frequency Range (MHz)	Limits (dBuV)	
	Quasi-Peak	Average
0.150~0.500	66~56	56~46
0.500~5.000	56	46
5.000~30.00	60	50

4.2 Test Setup Diagram

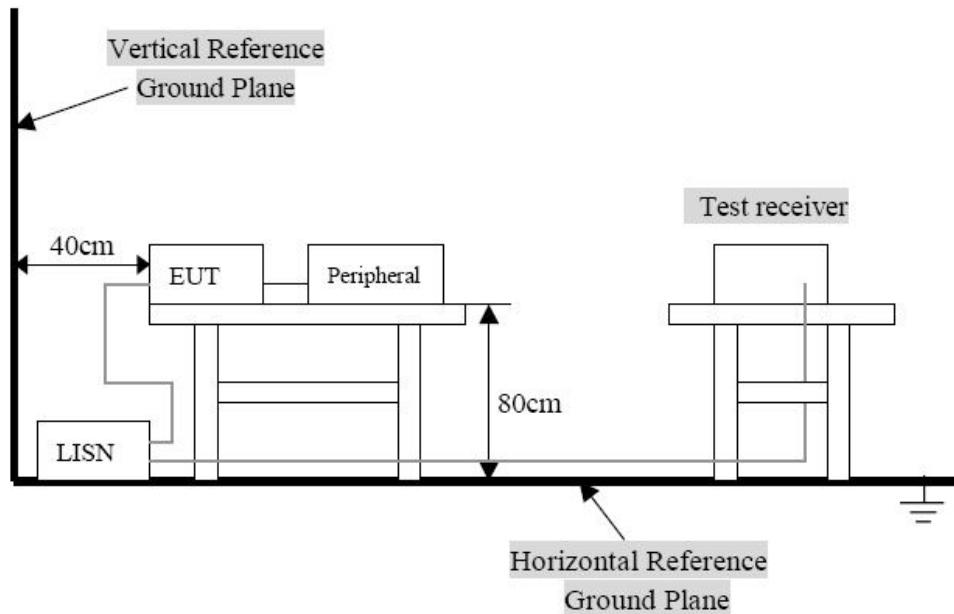

Remark: The EUT was connected to a 120 VAC/ 60Hz power source.

4.3 Test Result

Temperature (°C) : 23~25	EUT: Tablet PC
Humidity (%RH) : 45~58	M/N: B10T
Barometric Pressure (mbar) : 950~1000	Operation Condition: Charging Tx Mode

Conducted Emission:

EUT: Tablet PC
M/N: B10T
Operating Condition: Charging with Tx Mode
Test Site: Shielded Room
Operator: Yang
Test Specification: AC 120V/60Hz for adapter
Comment: L Line

SCAN TABLE: "Voltage (150K-30M) FIN"
Short Description: 150K-30M Voltage

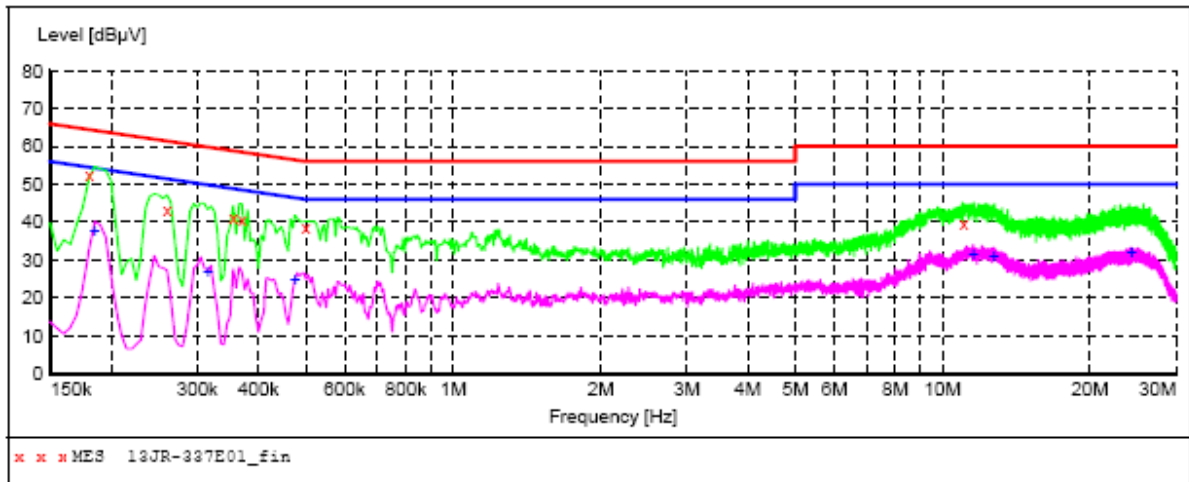

MEASUREMENT RESULT: "13JR-337E01_fin"

10/11/2013 00:38

Frequency MHz	Level dBµV	Transd dB	Limit dBµV	Margin dB	Detector	Line	PE
0.180000	52.60	12.1	65	11.9	QP	L1	GND
0.260000	43.40	11.1	61	18.0	QP	L1	GND
0.355000	41.40	10.8	59	17.4	QP	L1	GND
0.370000	41.00	10.8	59	17.5	QP	L1	GND
0.500000	38.80	10.5	56	17.2	QP	L1	GND
11.050000	39.80	10.6	60	20.2	QP	L1	GND

MEASUREMENT RESULT: "13JR-337E01_fin2"

10/11/2013 00:38

Frequency MHz	Level dBµV	Transd dB	Limit dBµV	Margin dB	Detector	Line	PE
0.185000	37.40	11.9	54	16.9	AV	L1	GND
0.315000	26.60	10.9	50	23.2	AV	L1	GND
0.475000	24.90	10.5	46	21.5	AV	L1	GND
11.565000	31.50	10.6	50	18.5	AV	L1	GND
12.730000	31.10	10.6	50	18.9	AV	L1	GND
24.370000	32.10	10.8	50	17.9	AV	L1	GND

Conducted Emission:

EUT: Tablet PC
M/N: B10T
Operating Condition: Charging with Tx Mode
Test Site: Shielded Room
Operator: Yang
Test Specification: AC 120V/60Hz for adapter
Comment: N Line

SCAN TABLE: "Voltage (150K-30M) FIN"
Short Description: 150K-30M Voltage

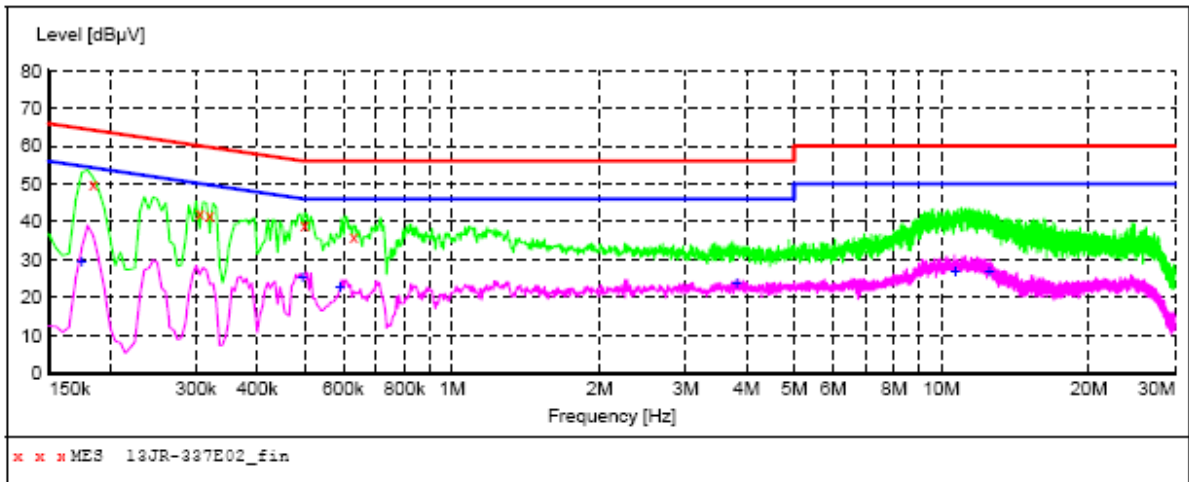

MEASUREMENT RESULT: "13JR-337E02_fin"

10/11/2013 00:41

Frequency MHz	Level dBµV	Transd dB	Limit dBµV	Margin dB	Detector	Line	PE
0.185000	49.70	11.9	64	14.6	QP	N	GND
0.305000	42.40	10.9	60	17.7	QP	N	GND
0.320000	41.60	10.9	60	17.9	QP	N	GND
0.500000	39.10	10.5	56	16.9	QP	N	GND
0.630000	36.20	10.4	56	19.8	QP	N	GND

MEASUREMENT RESULT: "13JR-337E02_fin2"

10/11/2013 00:41

Frequency MHz	Level dBµV	Transd dB	Limit dBµV	Margin dB	Detector	Line	PE
0.175000	29.40	12.3	55	25.3	AV	N	GND
0.495000	25.10	10.5	46	21.0	AV	N	GND
0.590000	22.70	10.4	46	23.3	AV	N	GND
3.810000	23.50	10.4	46	22.5	AV	N	GND
10.680000	26.60	10.6	50	23.2	AV	N	GND
12.525000	26.90	10.6	50	23.1	AV	N	GND

5. Test of Hopping Channel Bandwidth

5.1 Applicable Standard

Section 15.247(a)(1): Frequency hopping systems shall have hopping channel carrier frequencies separated by a minimum of 25 kHz or the 20 dB bandwidth of the hopping channel, whichever is greater.

5.2 EUT Setup

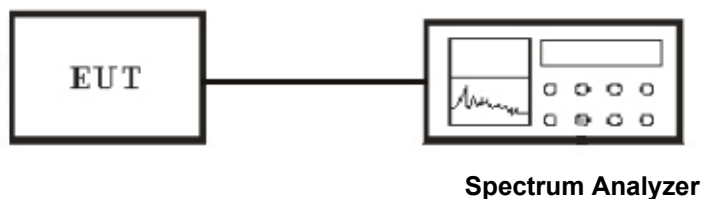

5.3 Test Equipment List and Details

See section 2.5.

5.4 Test Procedure

1. The transmitter output was connected to the spectrum analyzer through an attenuator.
2. Use the following spectrum analyzer settings:
 - Span = approximately 2 to 3 times the 20 dB bandwidth, centered on a hopping channel
 - RBW \geq 1% of the 20 dB bandwidth, VBW \geq RBW
 - Sweep = auto
 - Detector function = peak
 - Trace = max hold
3. The spectrum width with level higher than 20dB below the peak level.
4. Repeat above 1~3 points for the middle and highest channel of the EUT.

5.5 Test Result

Temperature (°C) : 22~23	EUT: Tablet PC
Humidity (%RH) : 50~54	M/N: B10T
Barometric Pressure (mbar) : 950~1000	Operation Condition: Tx Mode

BDR 1M

Modulation Type	Channel No.	Frequency (MHz)	20dB Bandwidth (kHz)	Min. Limit (kHz)
GFSK	Low	2402.00	640	>25
GFSK	Middle	2441.00	632	>25
GFSK	High	2480.00	640	>25

EDR 2M

Modulation Type	Channel No.	Frequency (MHz)	20dB Bandwidth (kHz)	Min. Limit (kHz)
Pi/4 DQPSK	Low	2402.00	1032	>25
Pi/4 DQPSK	Middle	2441.00	1024	>25
Pi/4 DQPSK	High	2480.00	1032	>25

EDR 3M

Modulation Type	Channel No.	Frequency (MHz)	20dB Bandwidth (kHz)	Min. Limit (kHz)
8-DPSK	Low	2402.00	1088	>25
8-DPSK	Middle	2441.00	1088	>25
8-DPSK	High	2480.00	1096	>25

**BDR 1M
Channel Low**

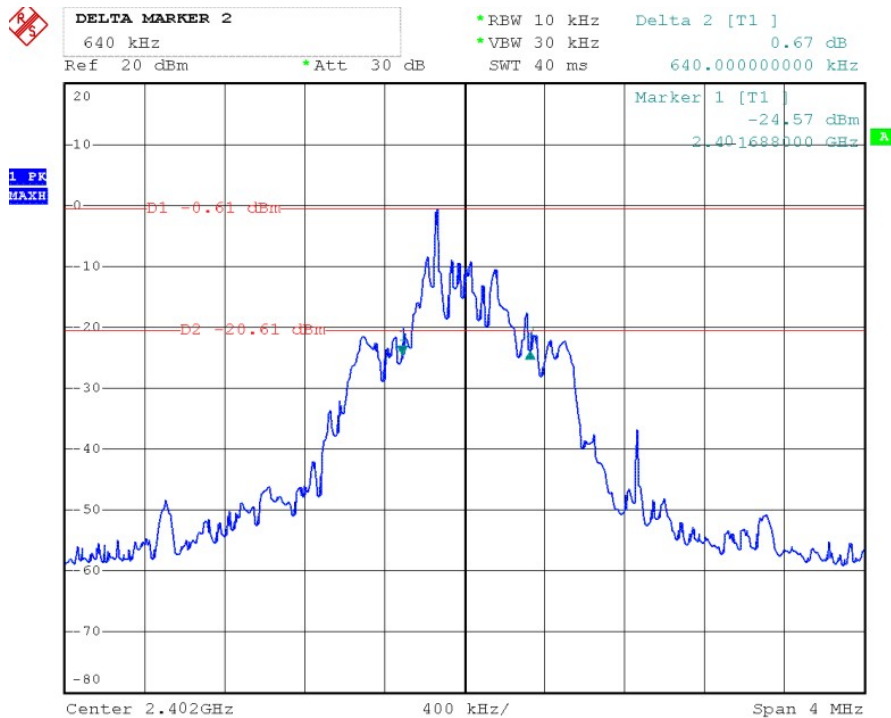

Channel Middle

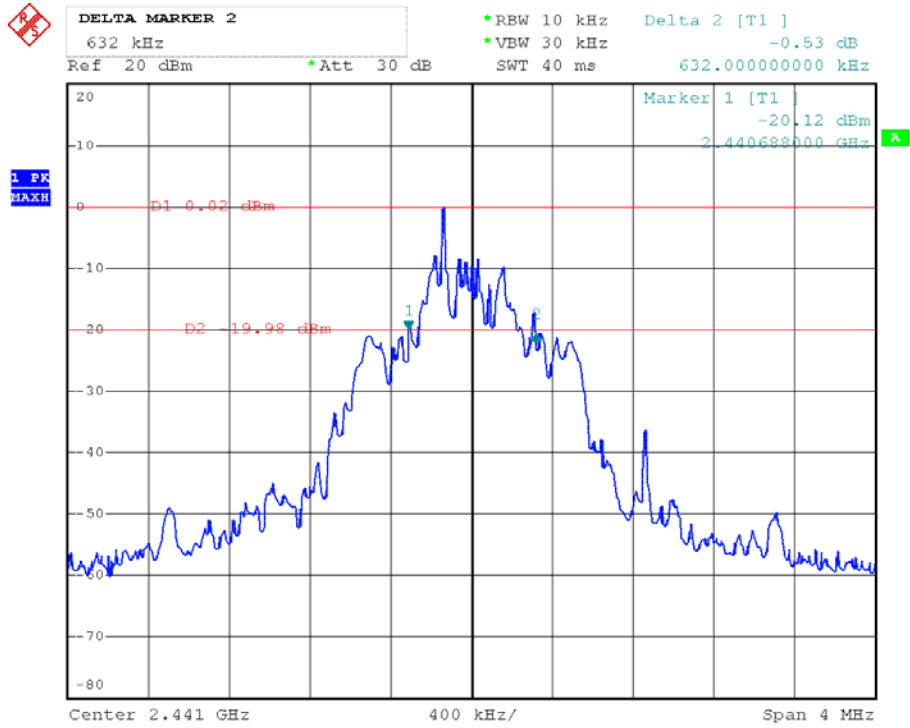

Channel High

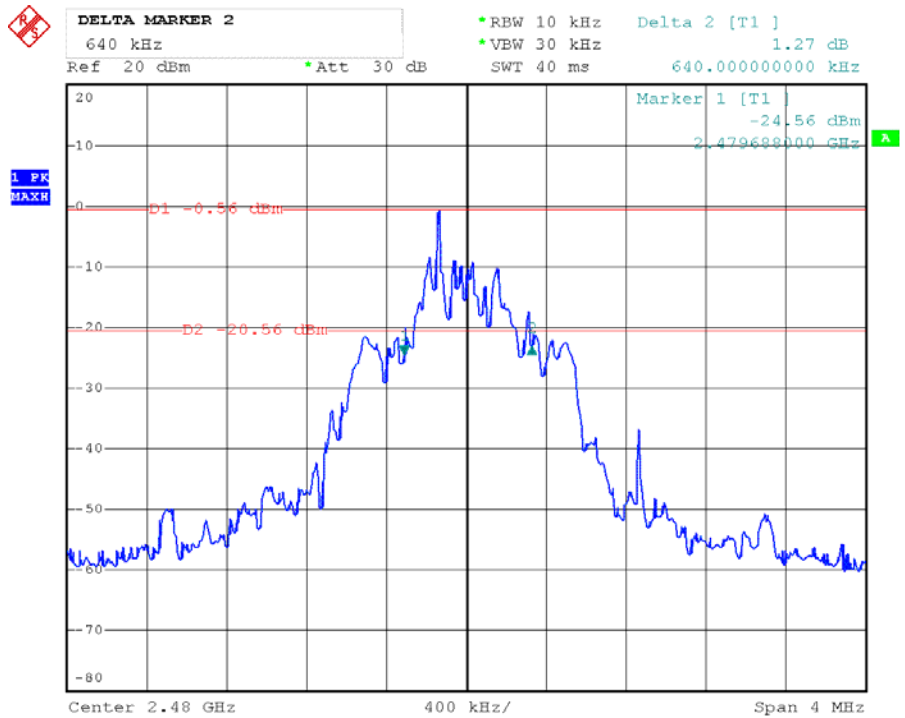

EDR 2M Channel Low

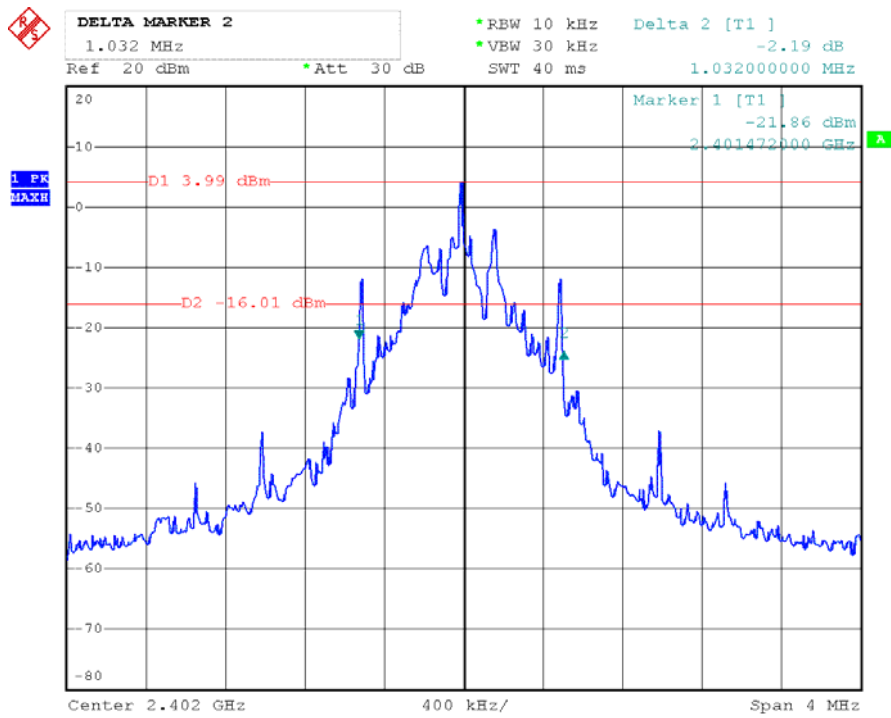

Channel Middle

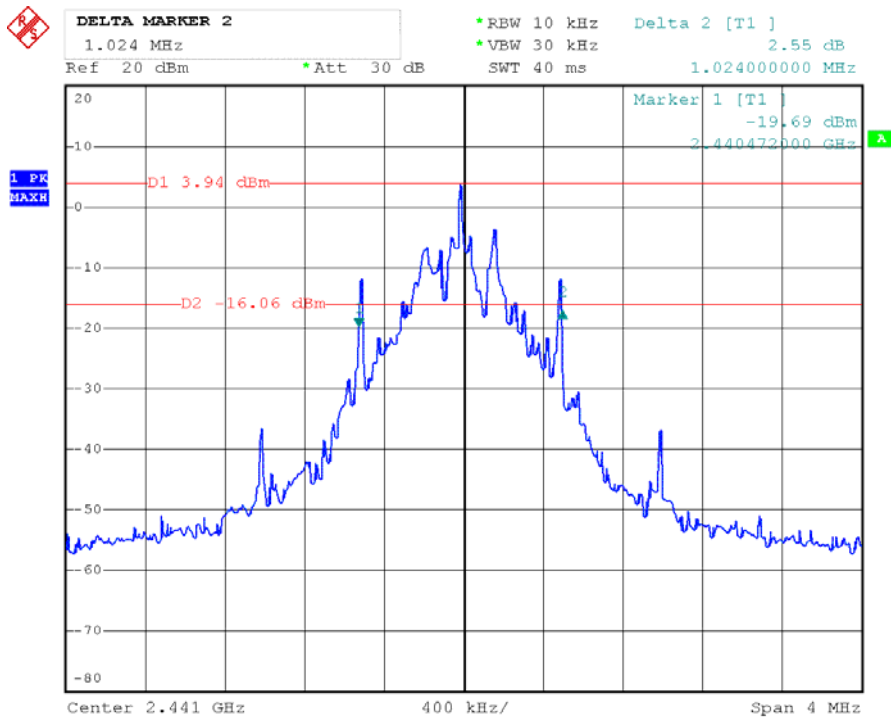

Channel High

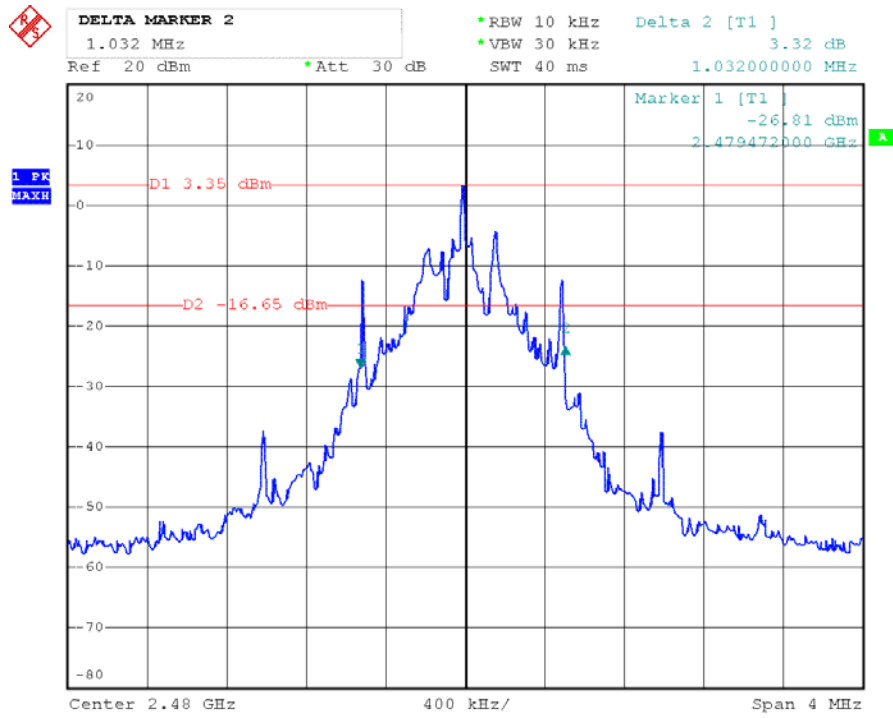

EDR 3M Channel Low



Channel Middle

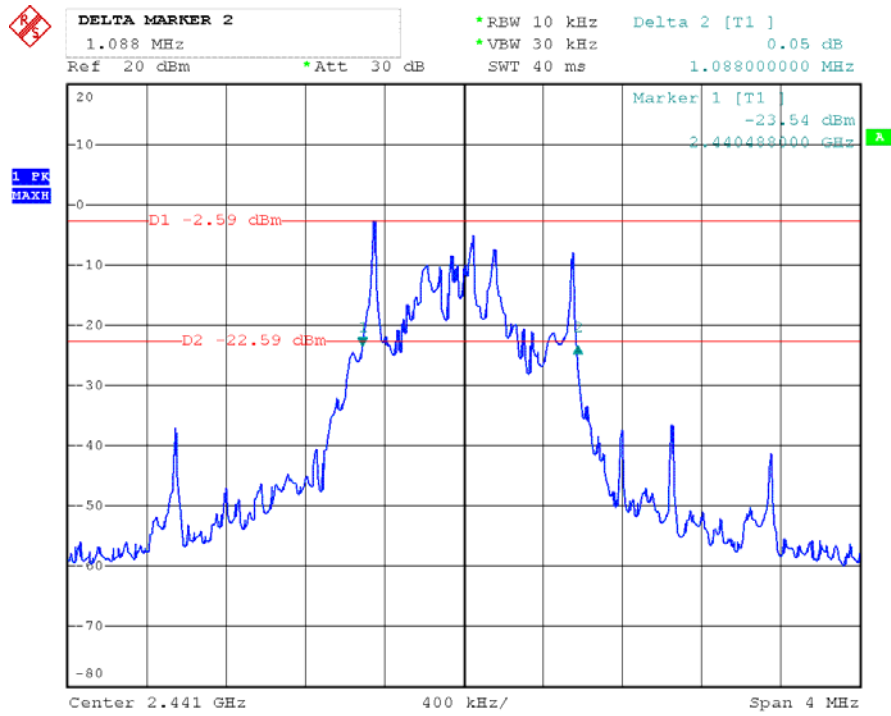

Channel High



6. Test of Hopping Channel Separation

6.1 Applicable Standard

Section 15.247(a)(1): Frequency hopping systems shall have hopping channel carrier frequencies separated by a minimum of 25 kHz or the 20 dB bandwidth of the hopping channel, whichever is greater.

6.2 EUT Setup

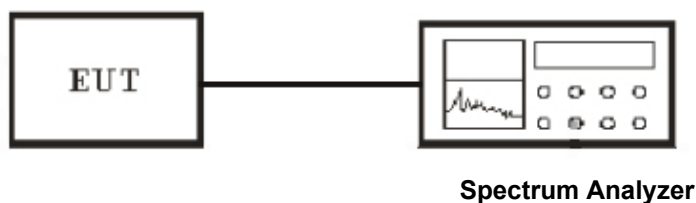

6.3 Test Equipment List and Details

See section 2.5.

6.4 Test Procedure

1. The transmitter output was connected to the spectrum analyzer through an attenuator.
2. Use the following spectrum analyzer settings:
 - Span = wide enough to capture the peaks of two adjacent channels
 - RBW \geq 1% of the span, VBW \geq RBW
 - Sweep = auto
 - Detector function = peak
 - Trace = max hold
3. The Hopping Channel Separation is defined as the separation between 2 neighboring hopping frequencies.
4. Repeat above 1~3 points for the middle and highest channel of the EUT.

6.5 Test Result

Temperature (°C) : 22~23	EUT: Tablet PC
Humidity (%RH) : 50~54	M/N: B10T
Barometric Pressure (mbar) : 950~1000	Operation Condition: Tx Mode

BDR 1M

Modulation Type	Frequency (MHz)	Channel Separation (MHz)	Min. Limit (kHz)
GFSK	2402~2403	1.148	>25
GFSK	2441~2442	1.120	>25
GFSK	2479~2480	1.036	>25

EDR 2M

Modulation Type	Frequency (MHz)	Channel Separation (MHz)	Min. Limit (kHz)
Pi/4 DQPSK	2402~2403	1.350	>25
Pi/4 DQPSK	2441~2442	1.120	>25
Pi/4 DQPSK	2479~2480	1.128	>25

EDR 3M

Modulation Type	Frequency (MHz)	Channel Separation (MHz)	Min. Limit (kHz)
8-DPSK	2402~2403	1.012	>25
8-DPSK	2441~2442	1.008	>25
8-DPSK	2479~2480	1.004	>25

**BDR 1M
Channel Low**

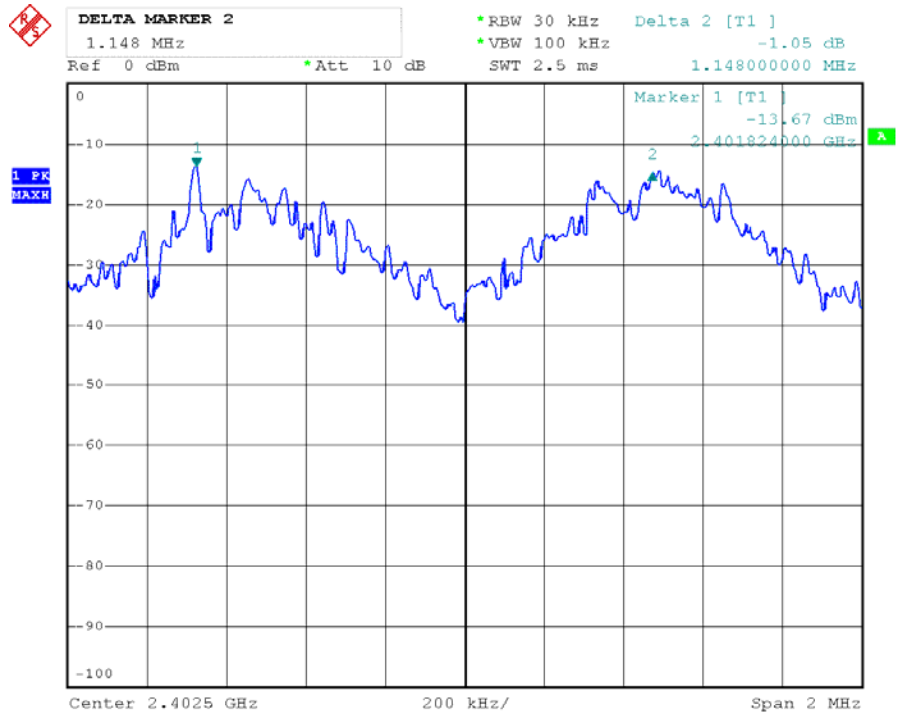

Channel Middle

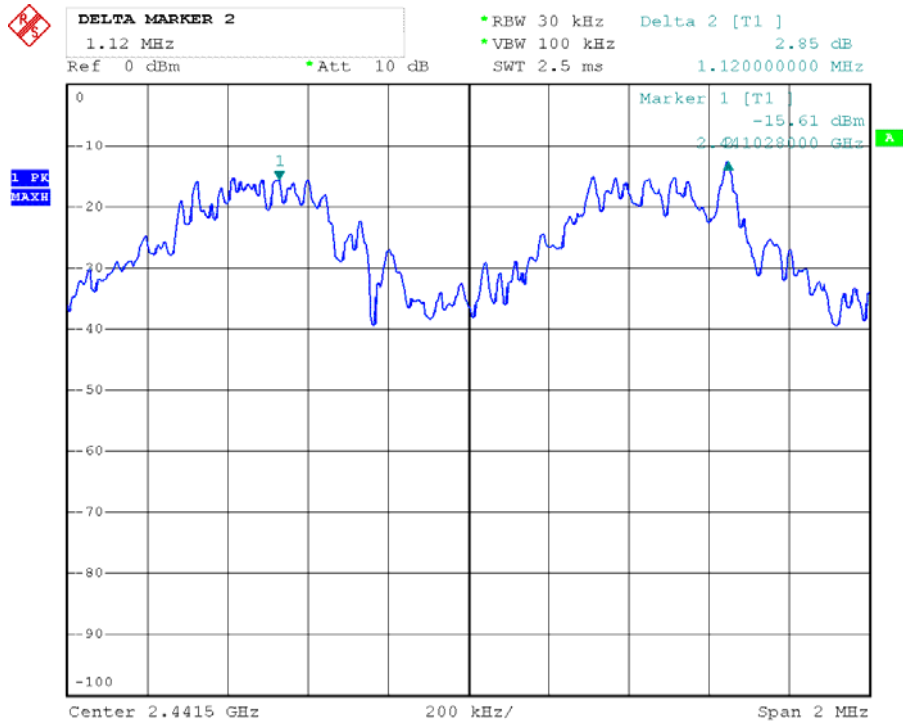

Channel High

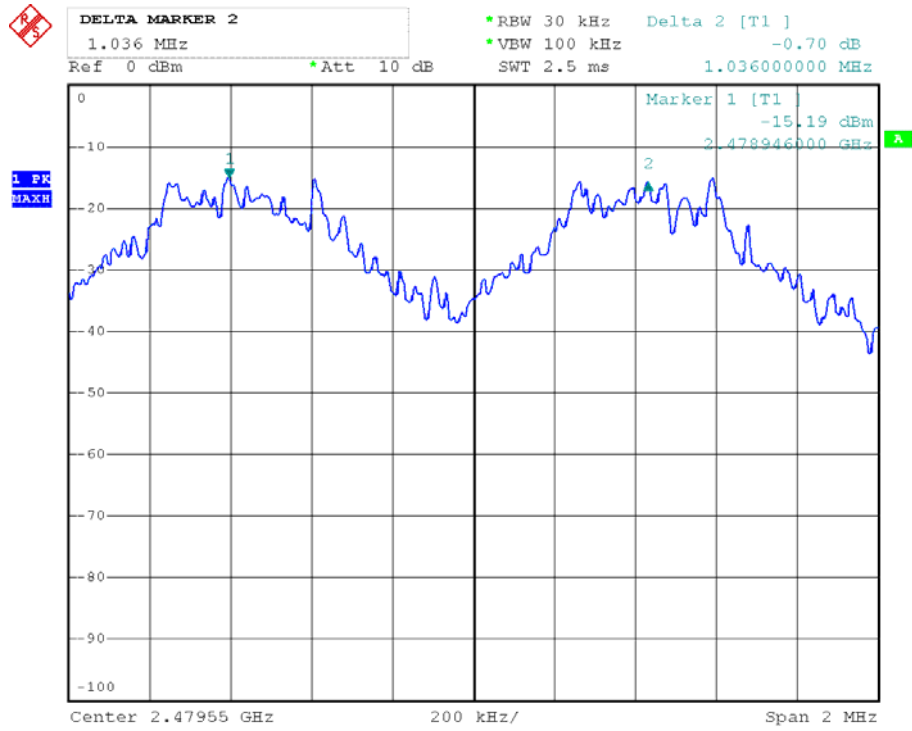

EDR 2M Channel Low

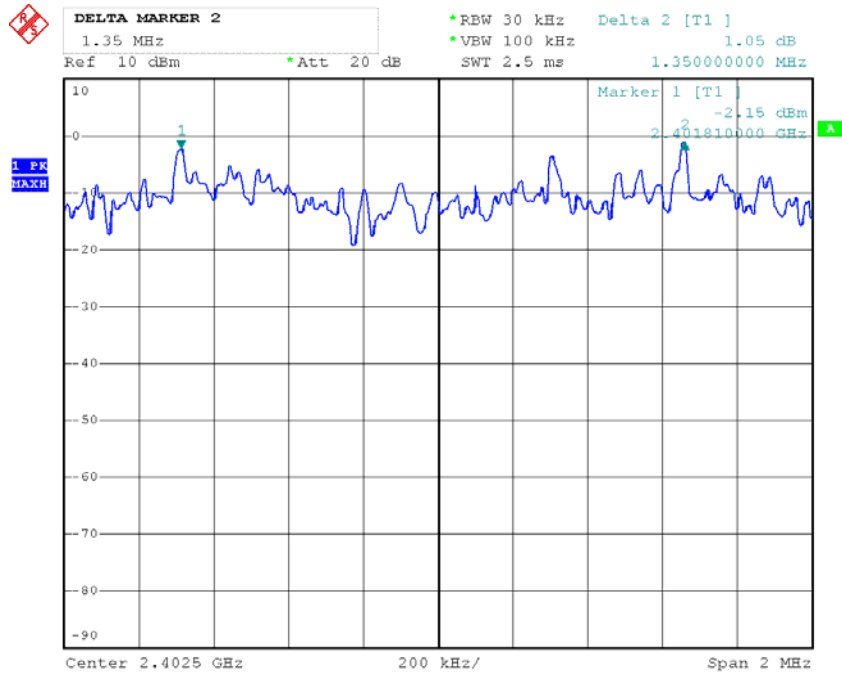

Channel Middle

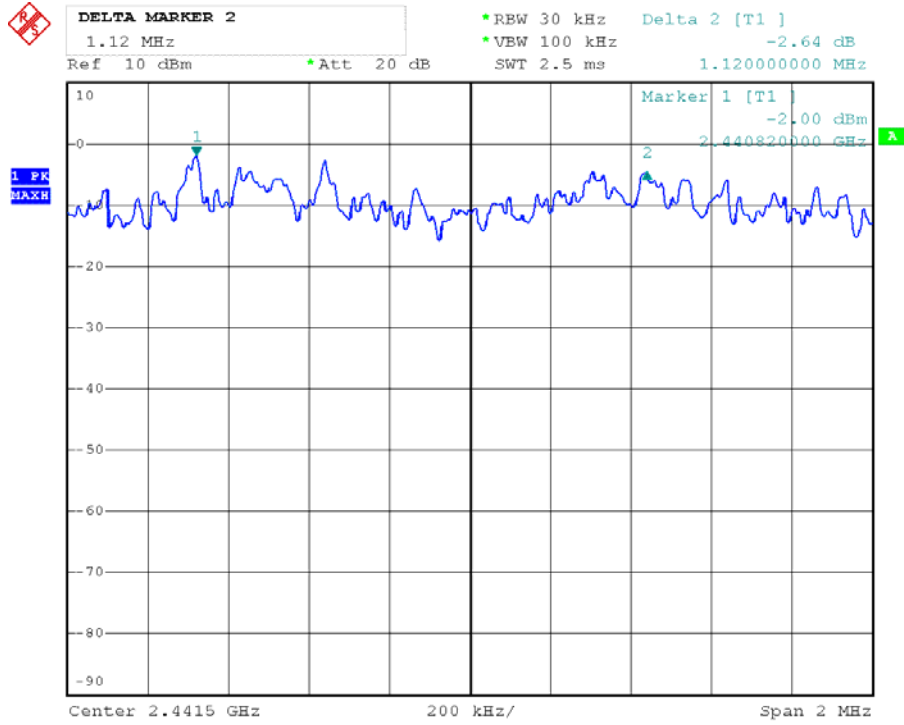

Channel High

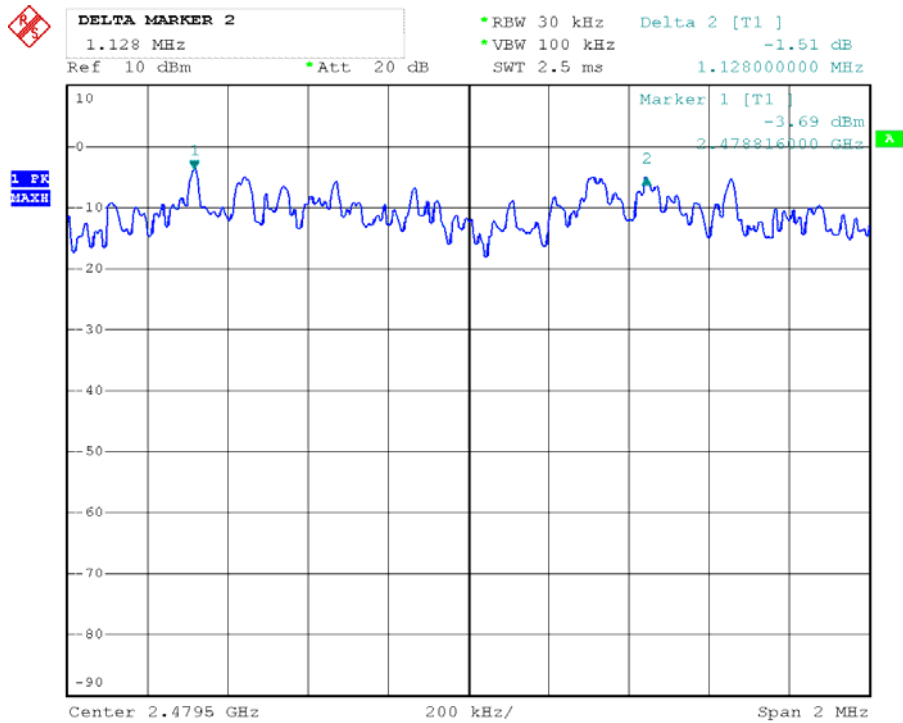

**EDR 3M
Channel Low**

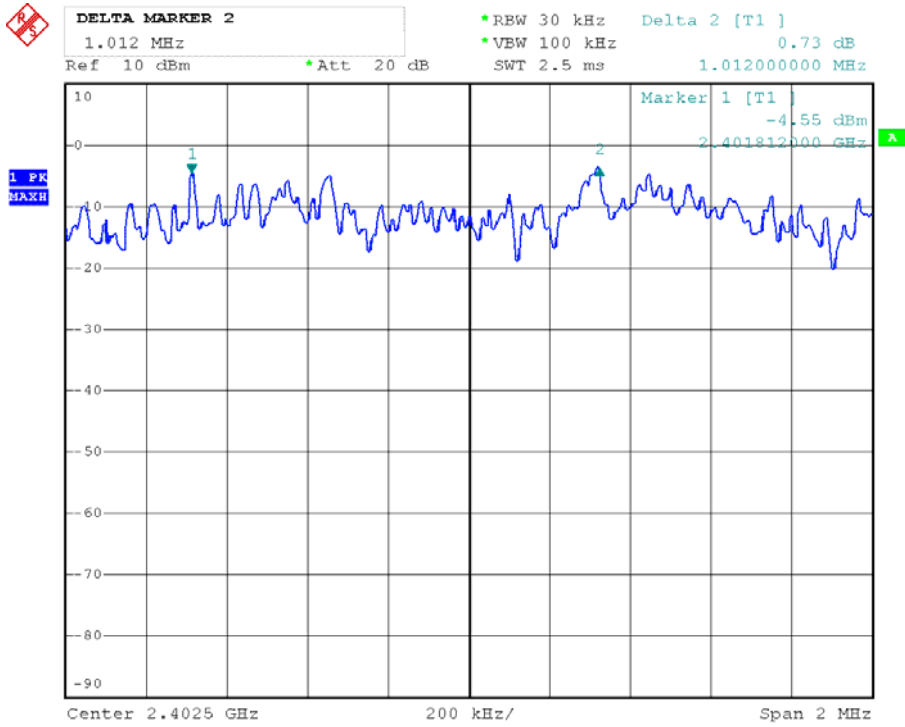

Channel Middle

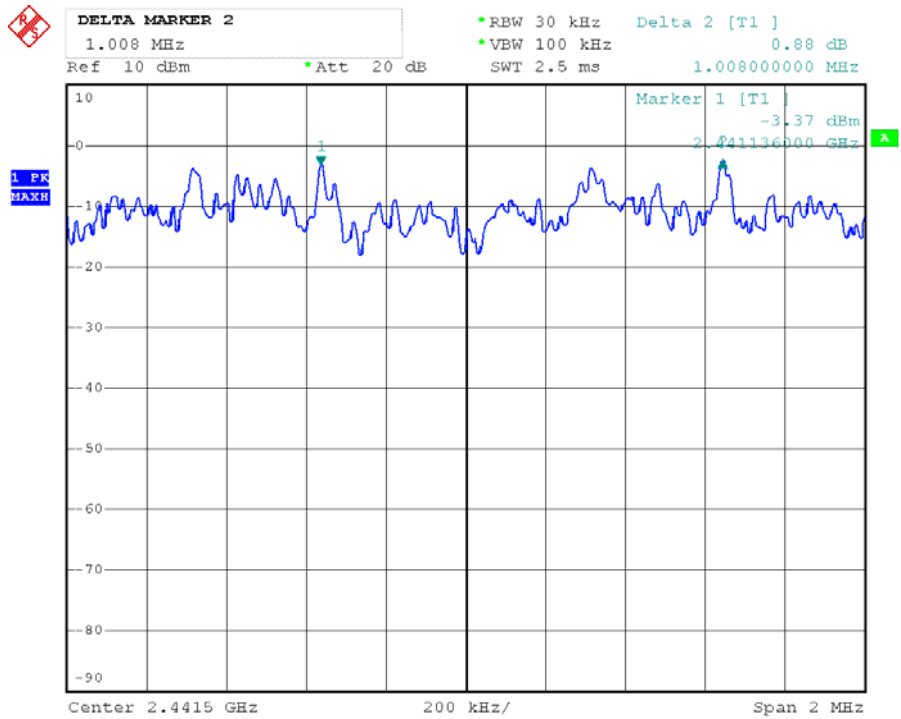

Channel High

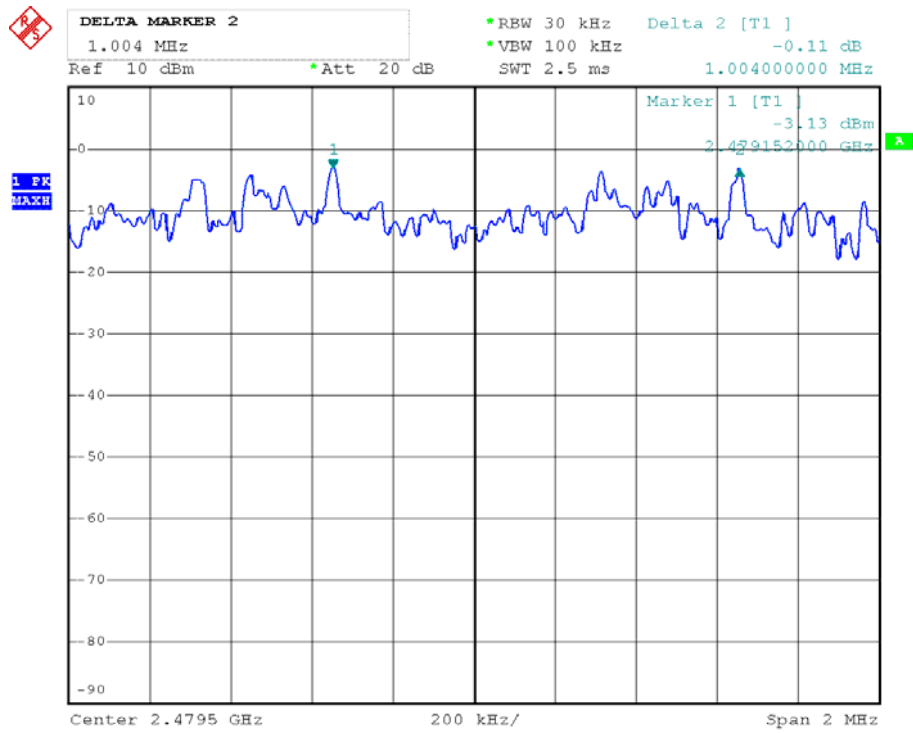

7. Test of Number of Hopping Frequency

7.1 Applicable Standard

Section 15.247(a)(1)(iii): For frequency hopping systems operating in the 2400-2483.5 MHz band employing at least 15 non-overlapping hopping channels. Frequency hopping system which use fewer than 75 hopping frequencies may employ intelligent hopping techniques to avoid interference to other transmissions. Frequency hopping system may avoid or suppress transmissions on a particular hopping frequency provided that a minimum of 15 non-overlapping channels are used.

7.2 EUT Setup

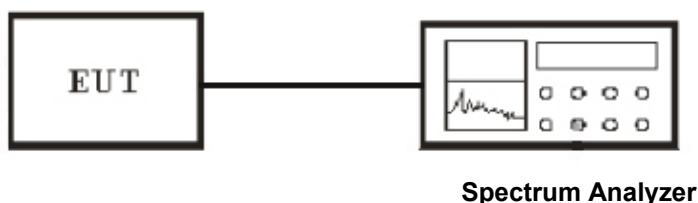

7.3 Test Equipment List and Details

See section 2.5.

7.4 Test Procedure

1. The transmitter output was connected to the spectrum analyzer through an attenuator.
2. Use the following spectrum analyzer settings:
 Span = the frequency band of operation
 RBW \geq 1% of the span, VBW \geq RBW
 Sweep = auto
 Detector function = peak
 Trace = max hold
3. Observe frequency hopping in 2400MHz~2483.5MHz, there are at least 32 non-overlapping channels.
4. Repeat above 1~3 points for the middle and highest channel of the EUT.

7.5 Test Result

Temperature (°C) : 22~23	EUT: Tablet PC
Humidity (%RH) : 50~54	M/N: B10T
Barometric Pressure (mbar) : 950~1000	Operation Condition: Tx Mode

Modulation Type	Frequency (MHz)	Number of Hopping Channels	Min. Limit (kHz)
GFSK	2402.0~2480.0	79	>15
Pi/4 DQPSK	2402.0~2480.0	79	>15
8-DPSK	2402.0~2480.0	79	>15

BDR 1M

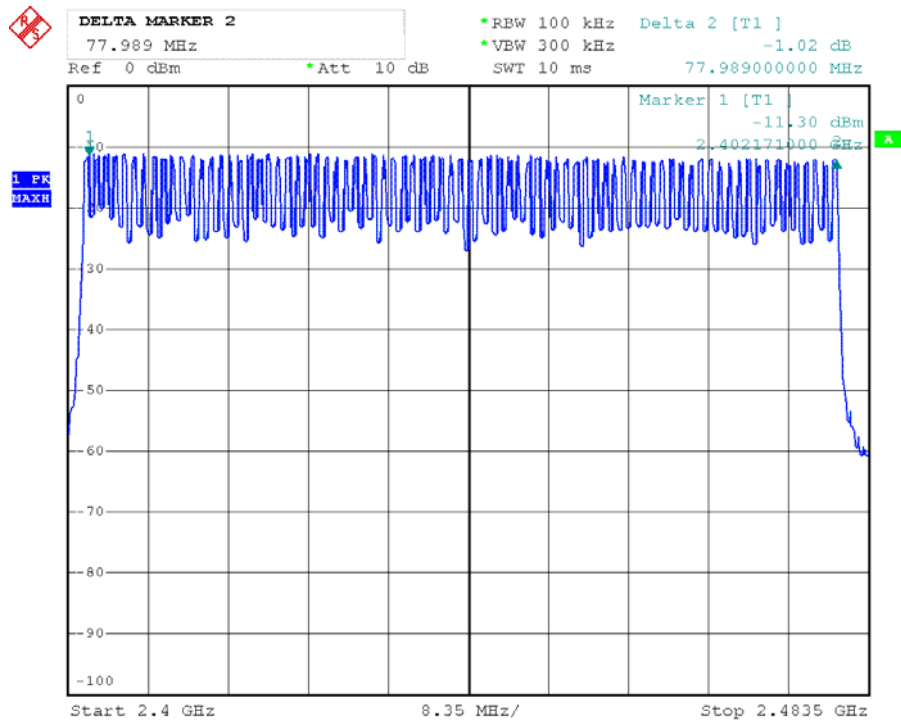

EDR 2M

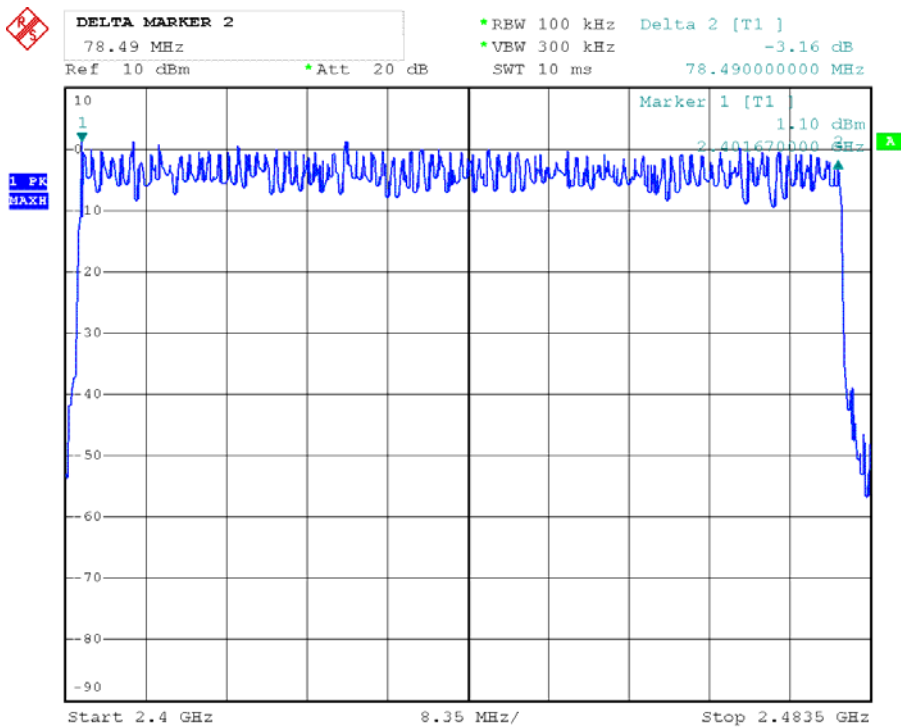

EDR 3M

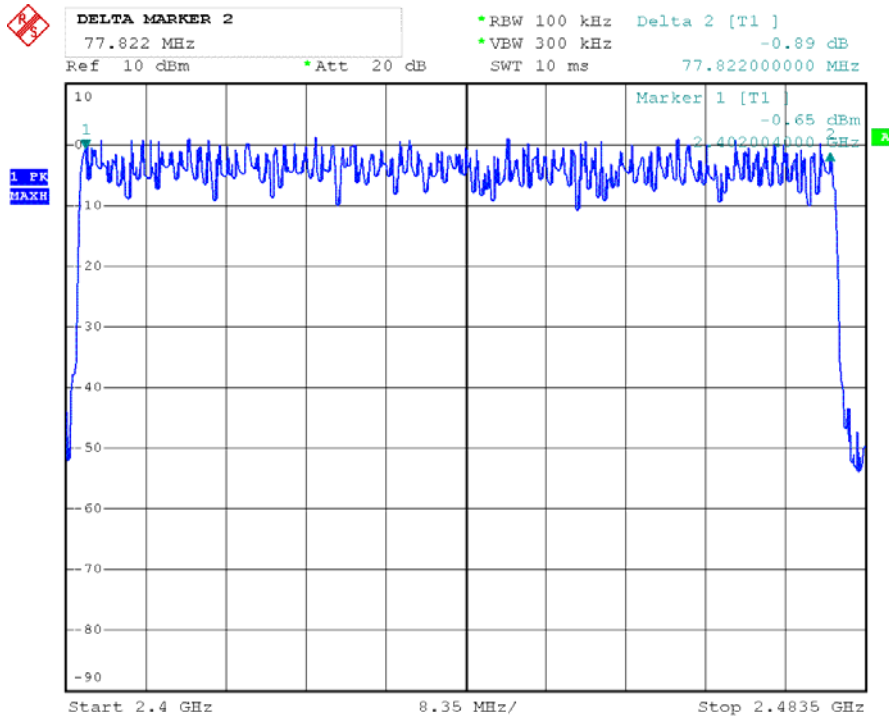

8. Test of Dwell Time of Each Frequency

8.1 Applicable Standard

Section 15.247(a)(1)(iii): For frequency hopping systems operating in the 2400-2483.5 MHz band The average time of occupancy on any channel shall not be greater than 0.4 seconds within a period of 0.4seconds multiplied by the number of hopping channels employed.

8.2 EUT Setup

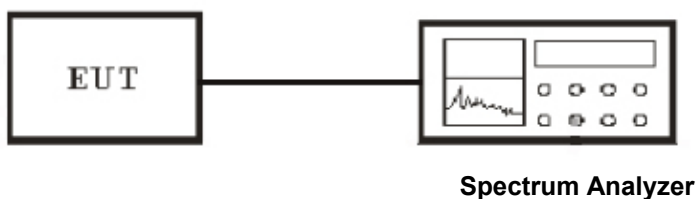

8.3 Test Equipment List and Details

See section 2.5.

8.4 Test Procedure

1. The transmitter output was connected to the spectrum analyzer through an attenuator.
2. Use the following spectrum analyzer settings:
 - Span = zero span, centered on a hopping channel
 - RBW = 1 MHz, VBW \geq RBW
 - Sweep = as necessary to capture the entire dwell time per hopping channel
 - Detector function = peak
 - Trace = max hold
3. Set the center frequency on any frequency would be measure and set the frequency span to zero span.
4. Measure the maximum time duration of one single pulse.

8.5 Test Result

Temperature (°C) : 22~23	EUT: Tablet PC
Humidity (%RH) : 50~54	M/N: B10T
Barometric Pressure (mbar) : 950~1000	Operation Condition: Tx Mode

DH1

Dwell time= $t*(1.6/2/79)*31.6$

DH3

Dwell time= $t*(1.6/4/79)*31.6$

DH5

Dwell time= $t*(1.6/6/79)*31.6$

**BDR 1M
Low Channel**

Modulation Type		Reading (ms)	Dwell Time (ms)	Limit (ms)
GFSK	DH1	0.376	120.03	400
GFSK	DH3	1.636	261.76	400
GFSK	DH5	2.884	307.63	400

Middle Channel

Modulation Type		Reading (ms)	Dwell Time (ms)	Limit (ms)
GFSK	DH1	0.376	120.03	400
GFSK	DH3	1.636	261.76	400
GFSK	DH5	2.884	307.63	400

High Channel

Modulation Type		Reading (ms)	Dwell Time (ms)	Limit (ms)
GFSK	DH1	0.376	120.03	400
GFSK	DH3	1.636	261.76	400
GFSK	DH5	2.884	307.63	400

**EDR 2M
Low Channel**

Modulation Type		Reading (ms)	Dwell Time (ms)	Limit (ms)
Pi/4 DQPSK	2DH1	0.396	126.72	400
Pi/4 DQPSK	2DH3	1.646	269.94	400
Pi/4 DQPSK	2DH5	2.896	309.00	400

Middle Channel

Modulation Type		Reading (ms)	Dwell Time (ms)	Limit (ms)
Pi/4 DQPSK	2DH1	0.396	126.72	400
Pi/4 DQPSK	2DH3	1.646	269.94	400
Pi/4 DQPSK	2DH5	2.896	309.00	400

High Channel

Modulation Type		Reading (ms)	Dwell Time (ms)	Limit (ms)
Pi/4 DQPSK	2DH1	0.396	126.72	400
Pi/4 DQPSK	2DH3	1.646	269.94	400
Pi/4 DQPSK	2DH5	2.896	309.00	400

**EDR 3M
Low Channel**

Modulation Type		Reading (ms)	Dwell Time (ms)	Limit (ms)
8-DPSK	3DH1	0.396	126.72	400
8-DPSK	3DH3	1.630	267.32	400
8-DPSK	3DH5	2.880	307.29	400

Middle Channel

Modulation Type		Reading (ms)	Dwell Time (ms)	Limit (ms)
8-DPSK	3DH1	0.396	126.72	400
8-DPSK	3DH3	1.630	267.32	400
8-DPSK	3DH5	2.880	307.29	400

High Channel

Modulation Type		Reading (ms)	Dwell Time (ms)	Limit (ms)
8-DPSK	3DH1	0.396	126.72	400
8-DPSK	3DH3	1.630	267.32	400
8-DPSK	3DH5	2.880	307.29	400

**BDR 1M DH1
Channel Low**

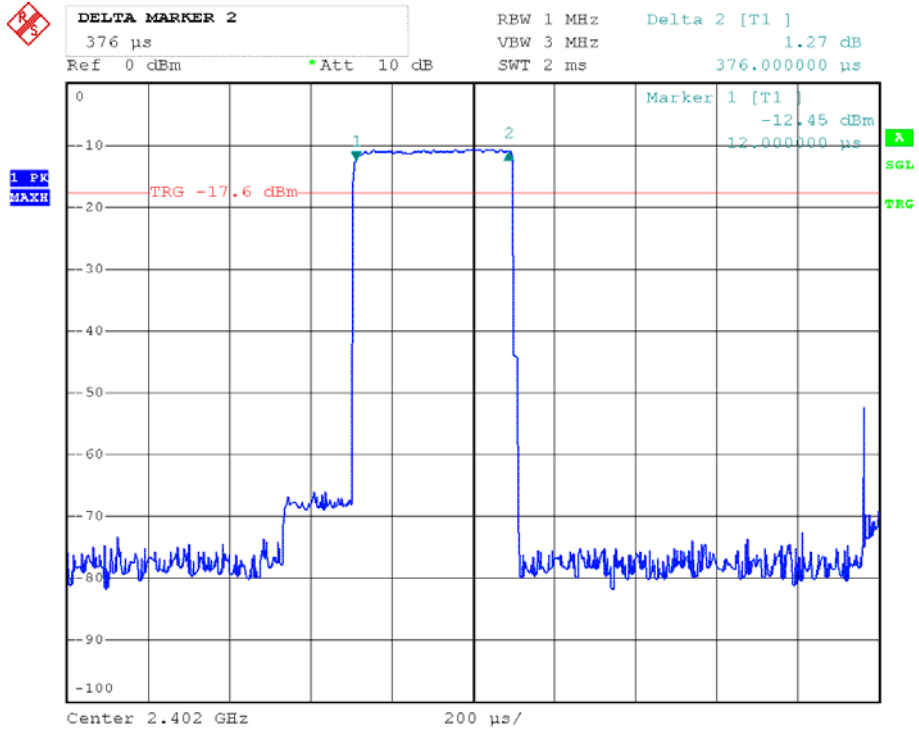

Channel Middle

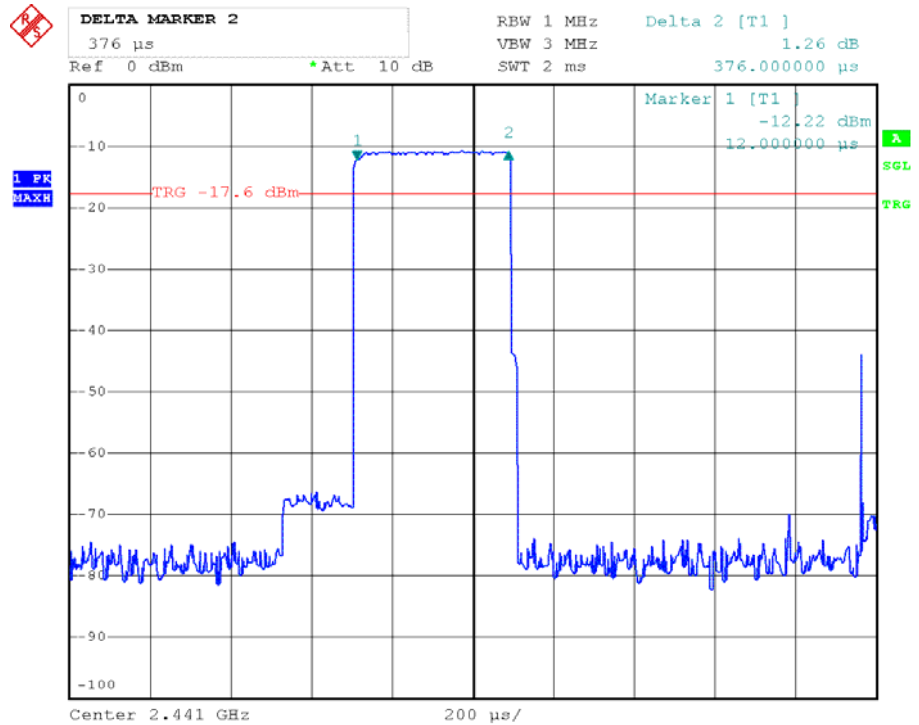

Channel High

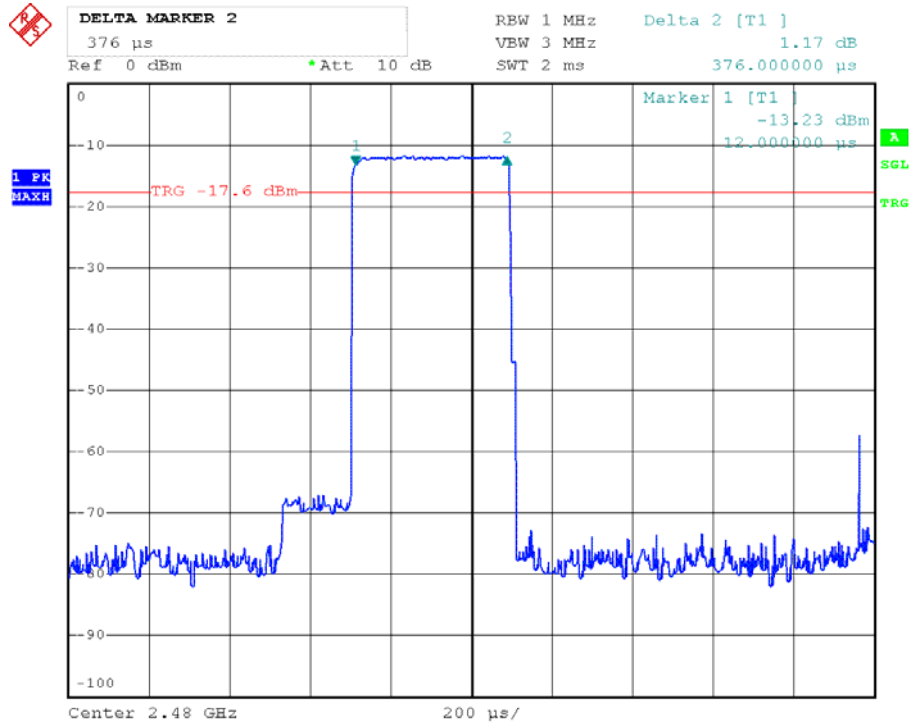

BDR 1M DH3 Channel Low

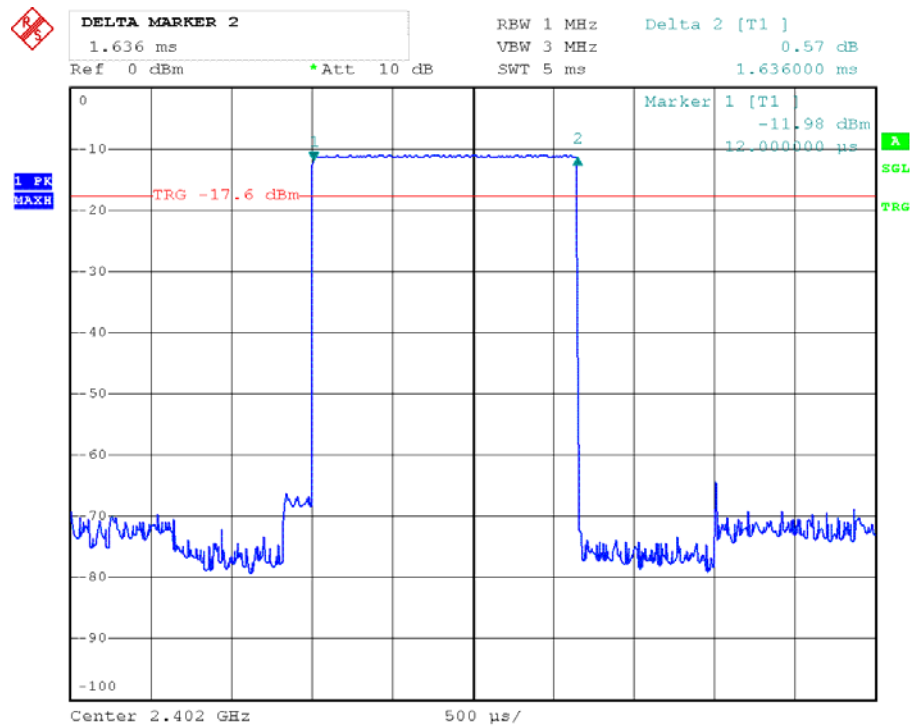

Channel Middle

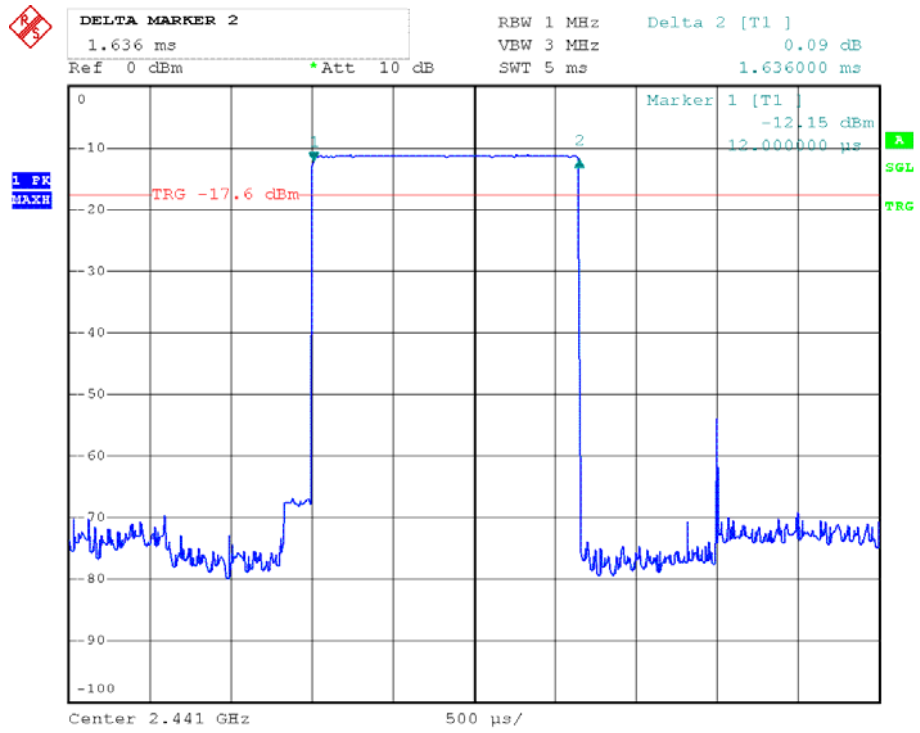

Channel High

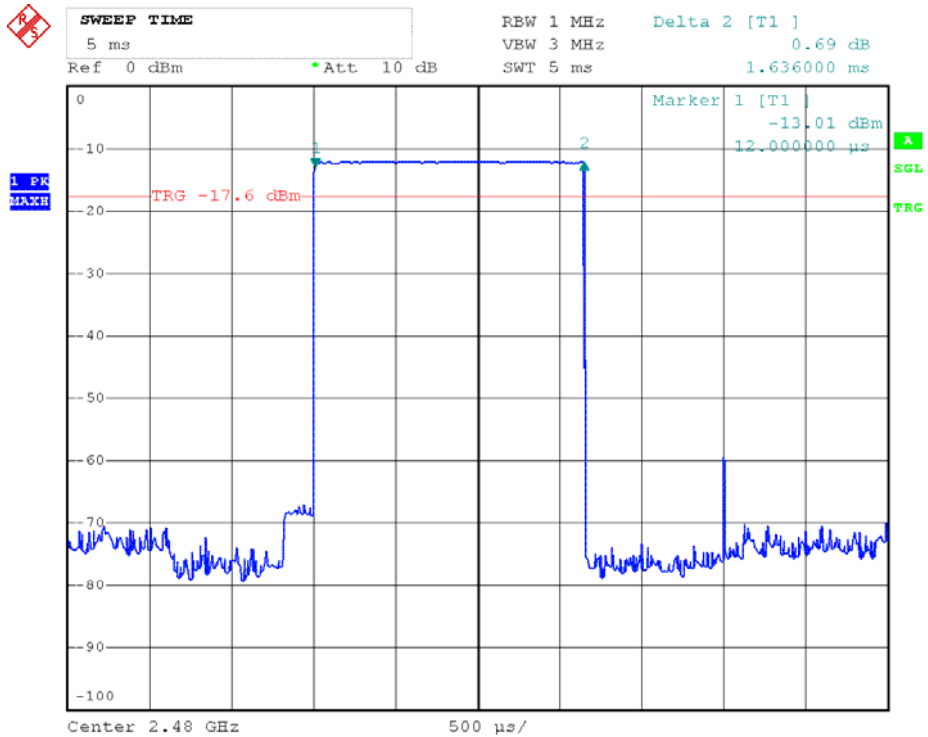

**BDR 1M DH5
Channel Low**

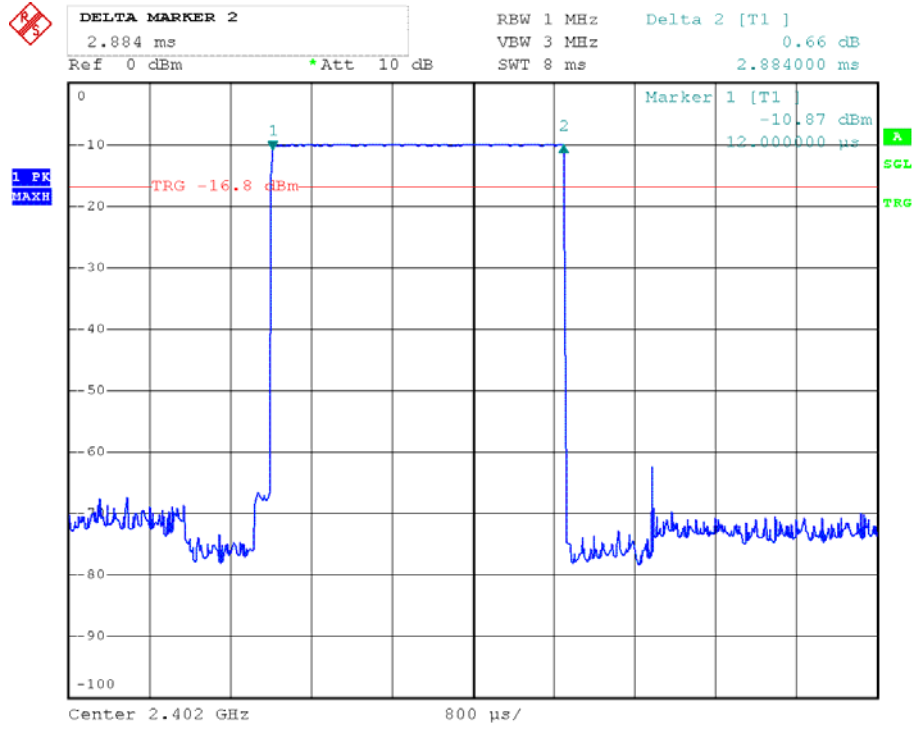

Channel Middle

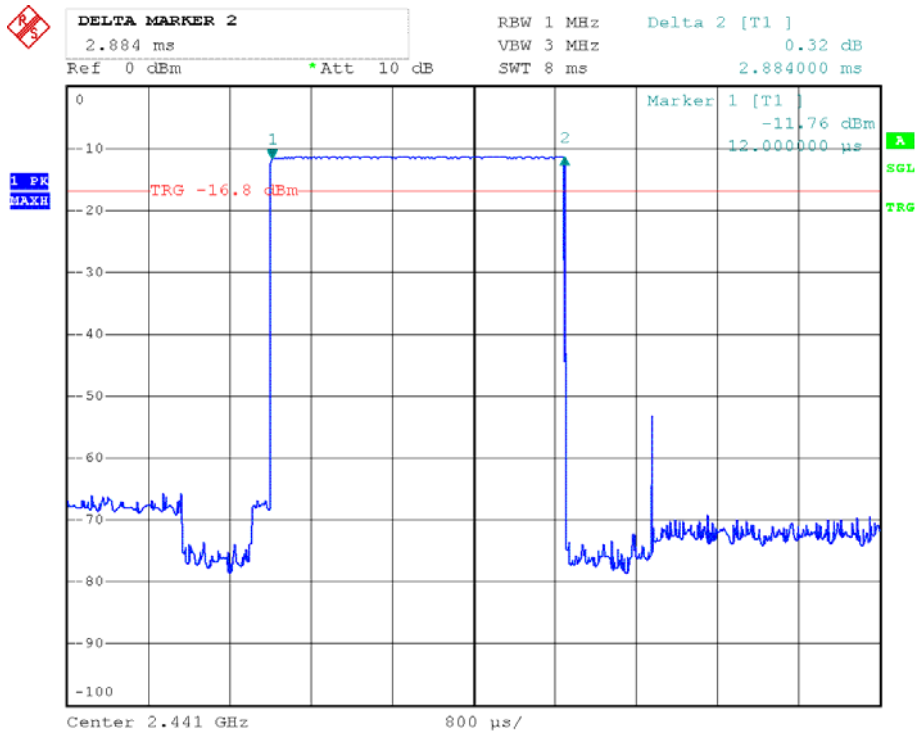

Channel High

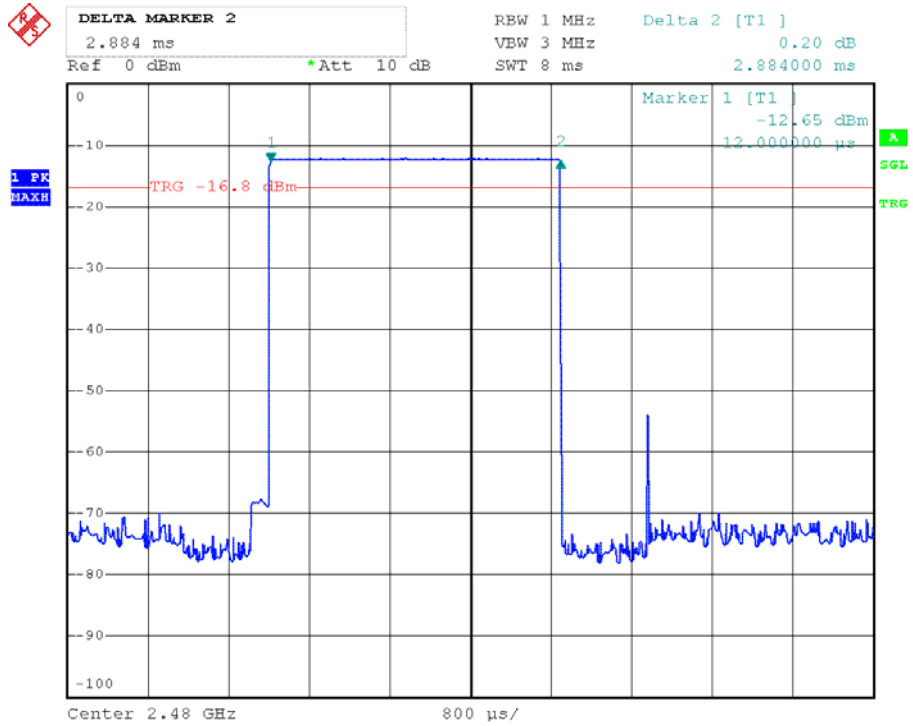

EDR 2M 2DH1 Channel Low

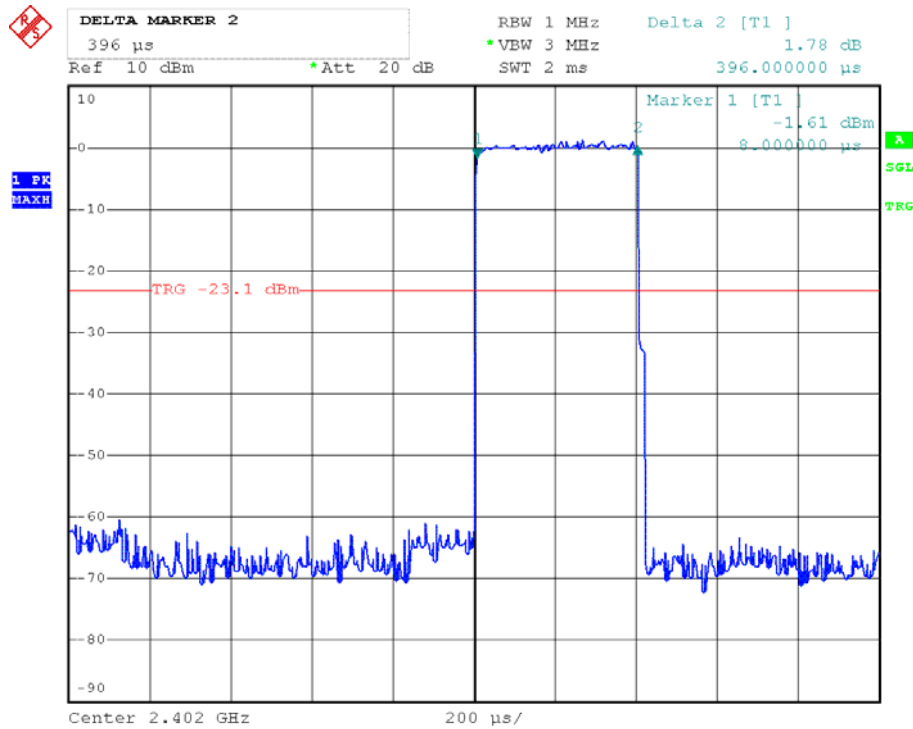

Channel Middle

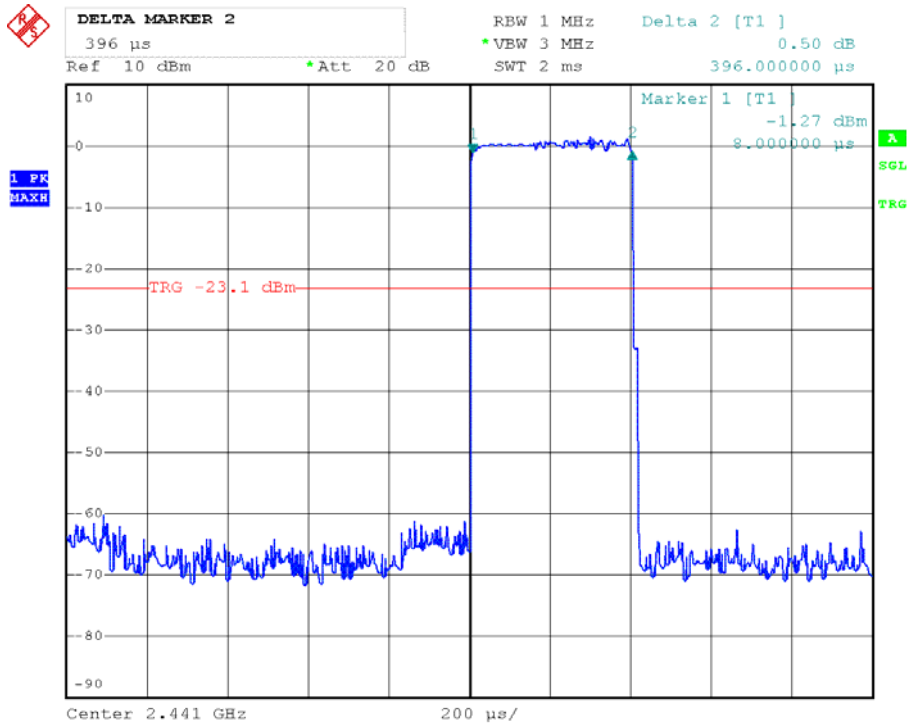

Channel High

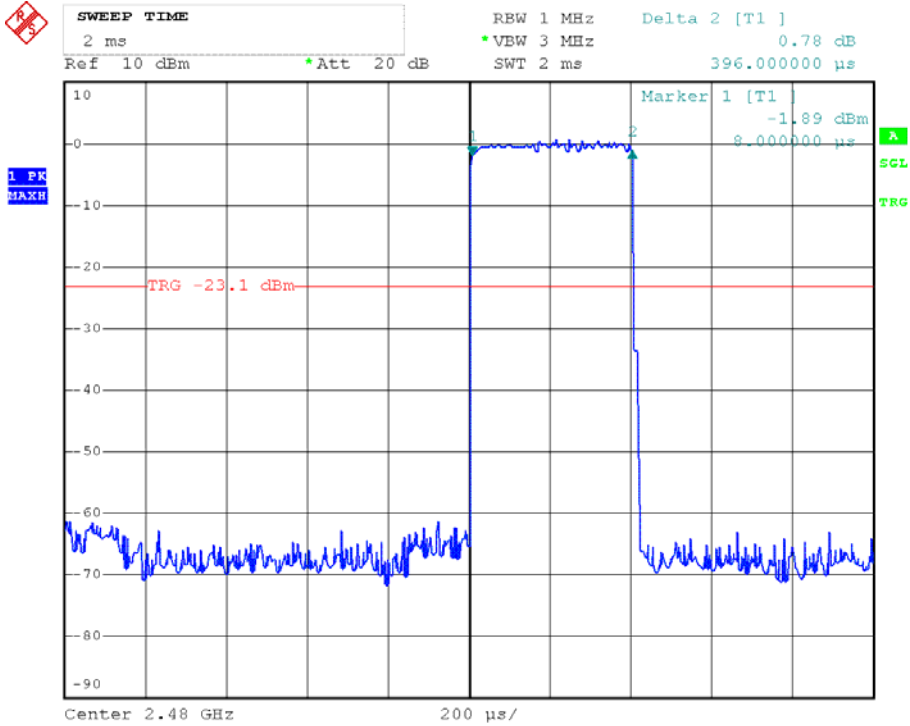

EDR 2M 2DH3 Channel Low

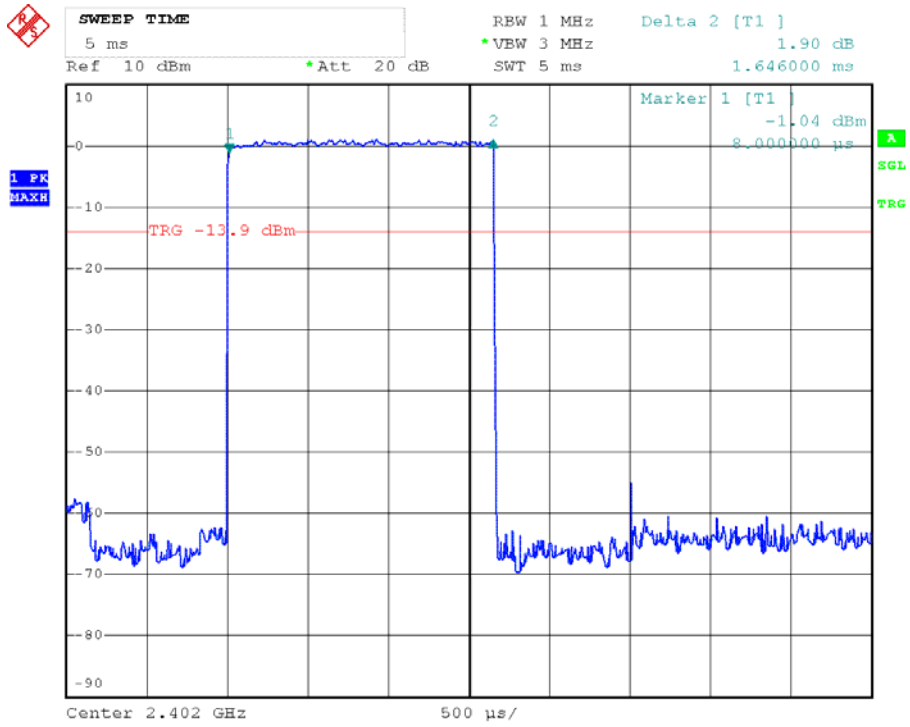

Channel Middle

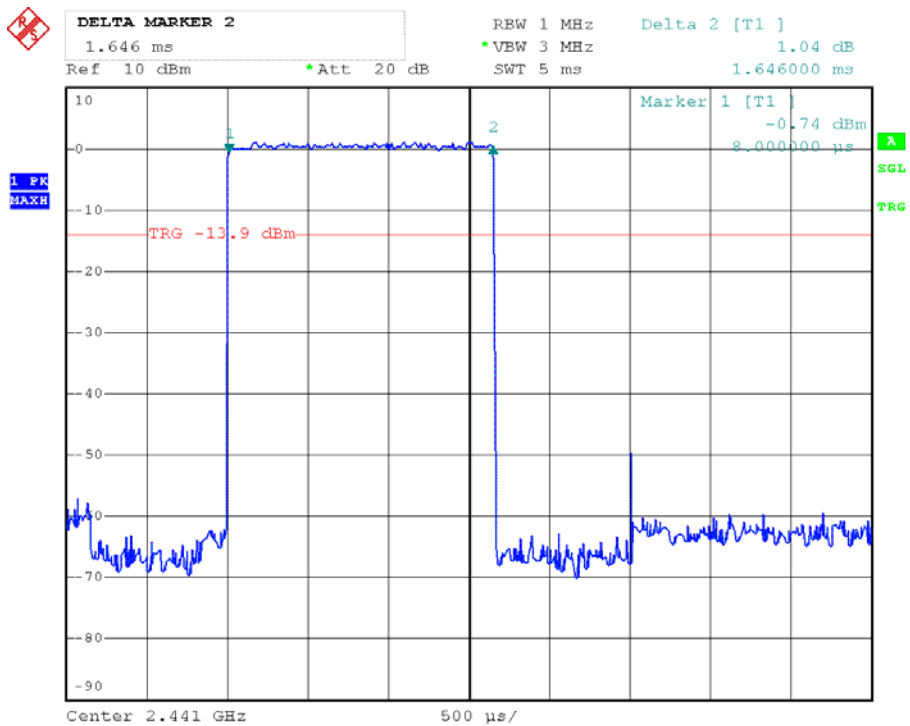

Channel High

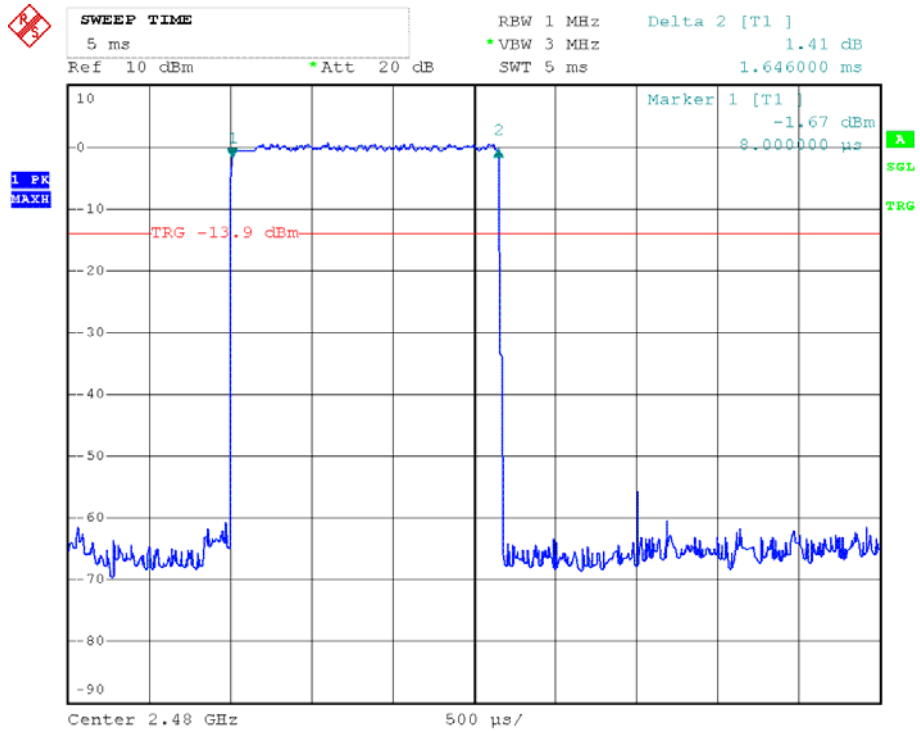

EDR 2M 2DH5 Channel Low

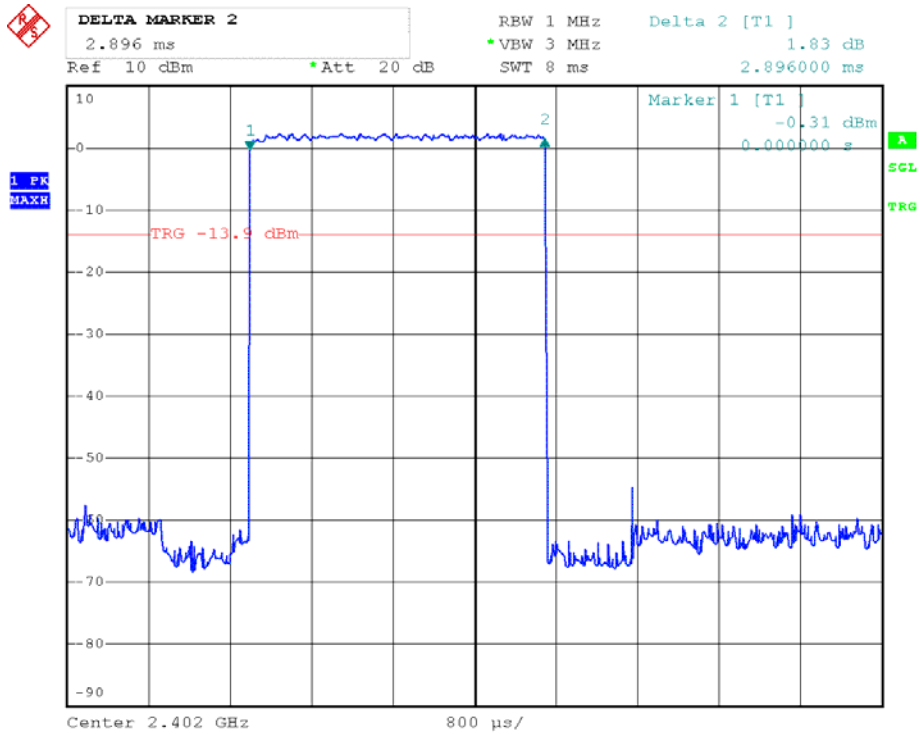

Channel Middle

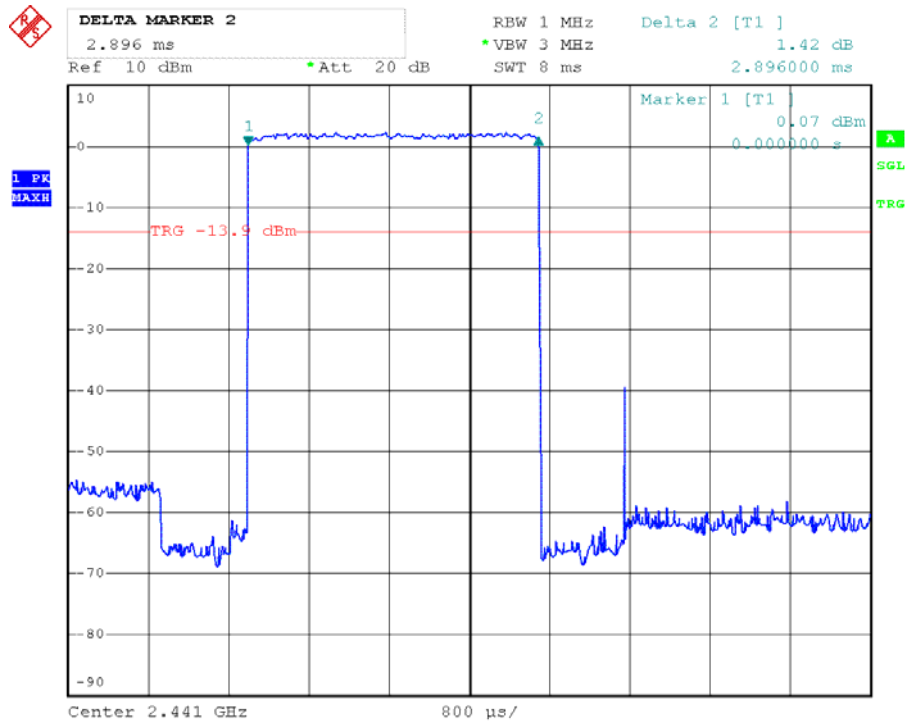

Channel High

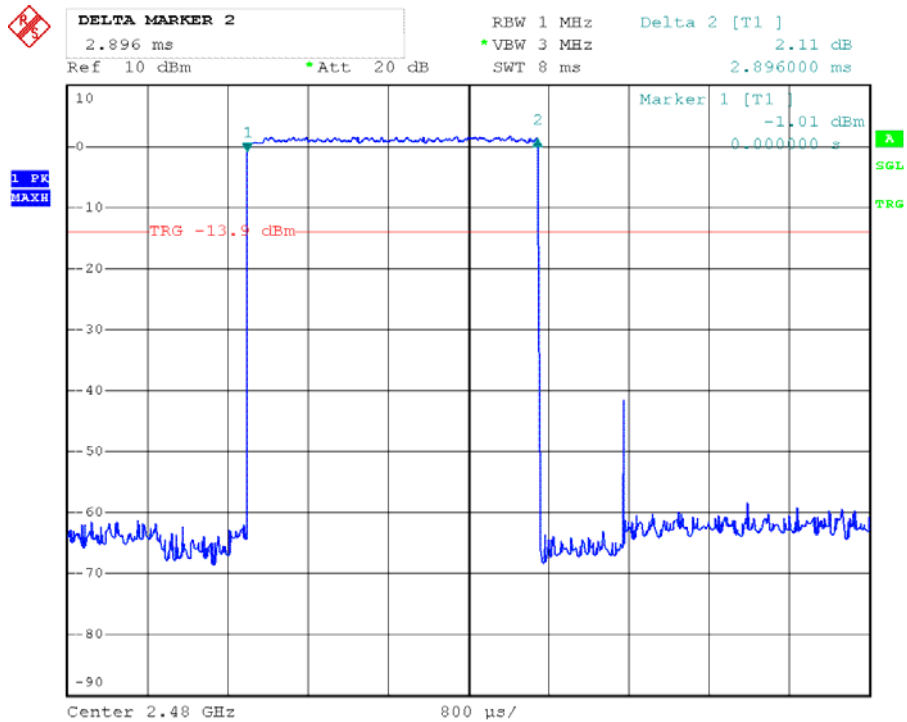

**EDR 3M 3DH1
Channel Low**

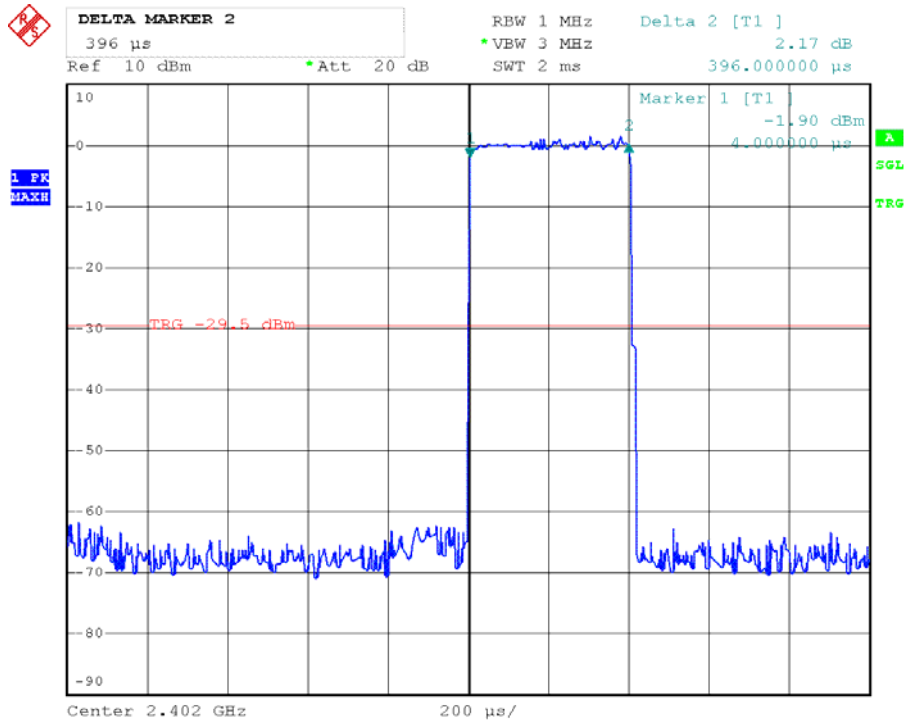

Channel Middle

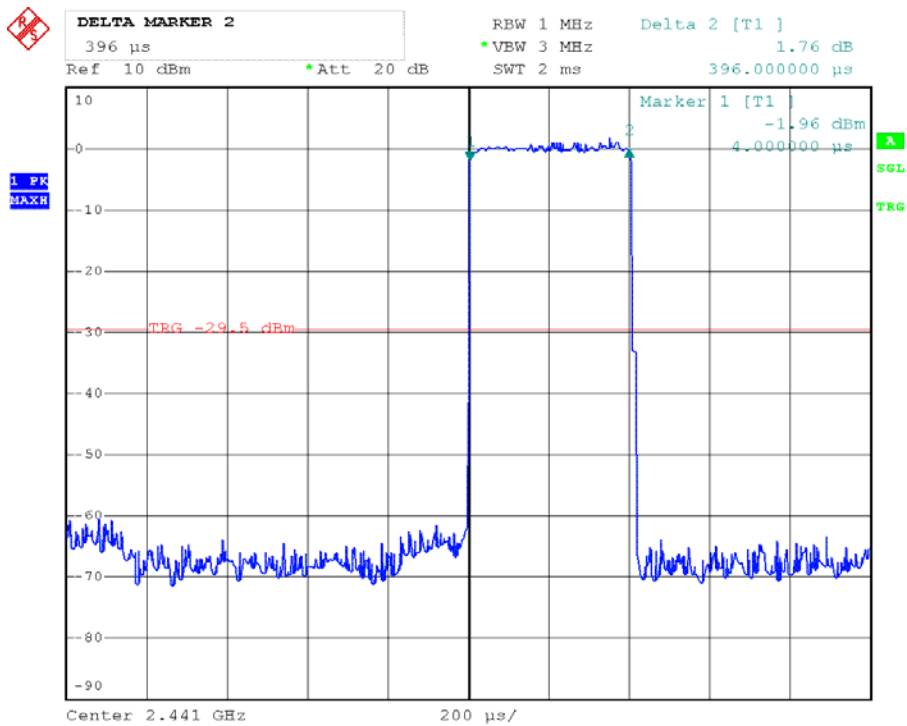

Channel High

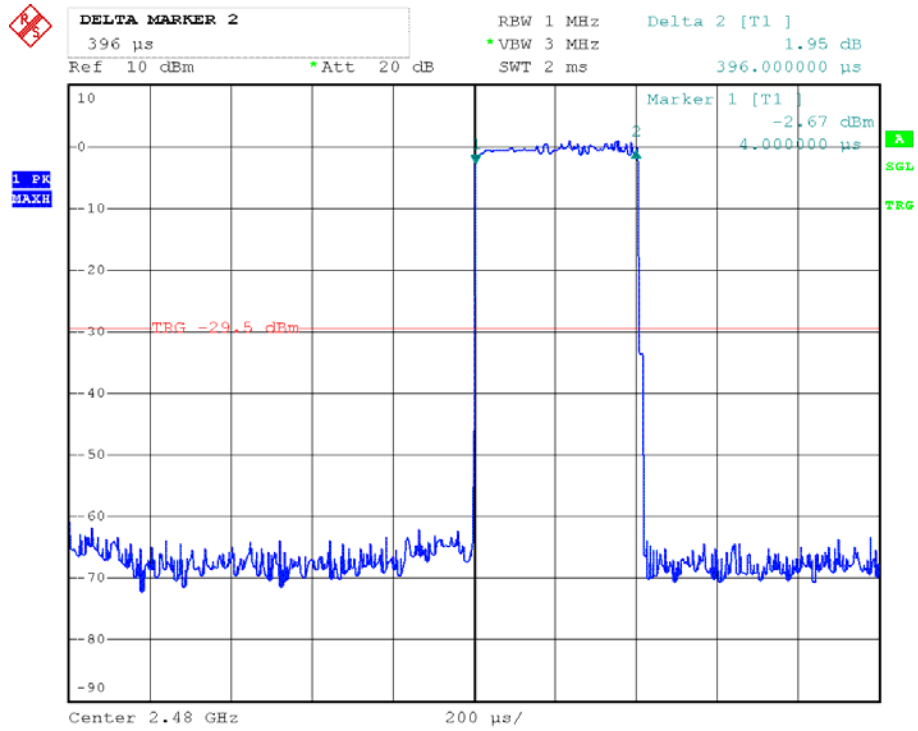

EDR 3M 3DH3 Channel Low

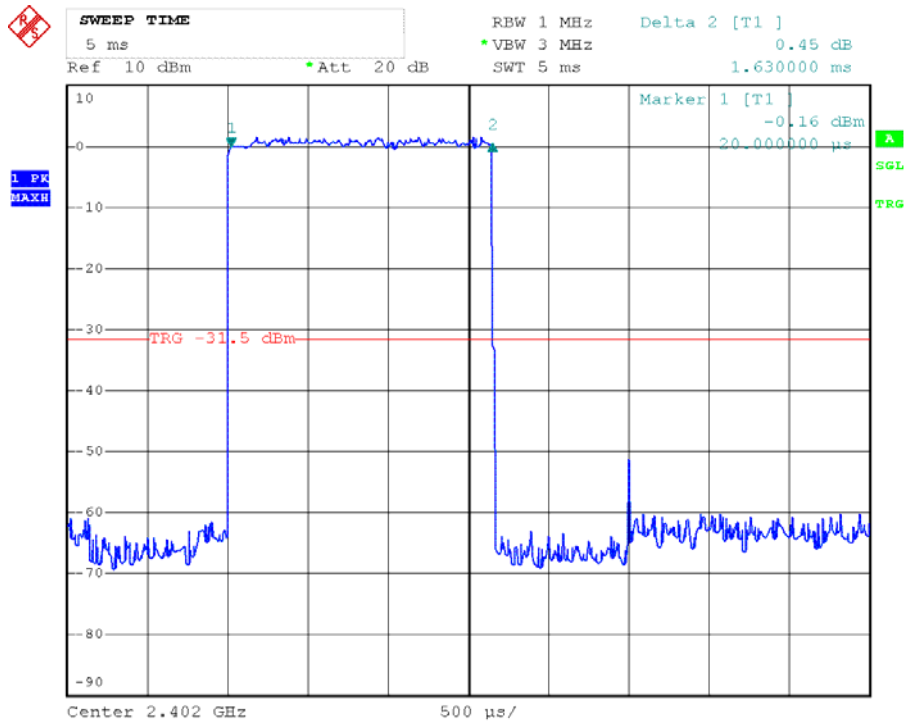

Channel Middle

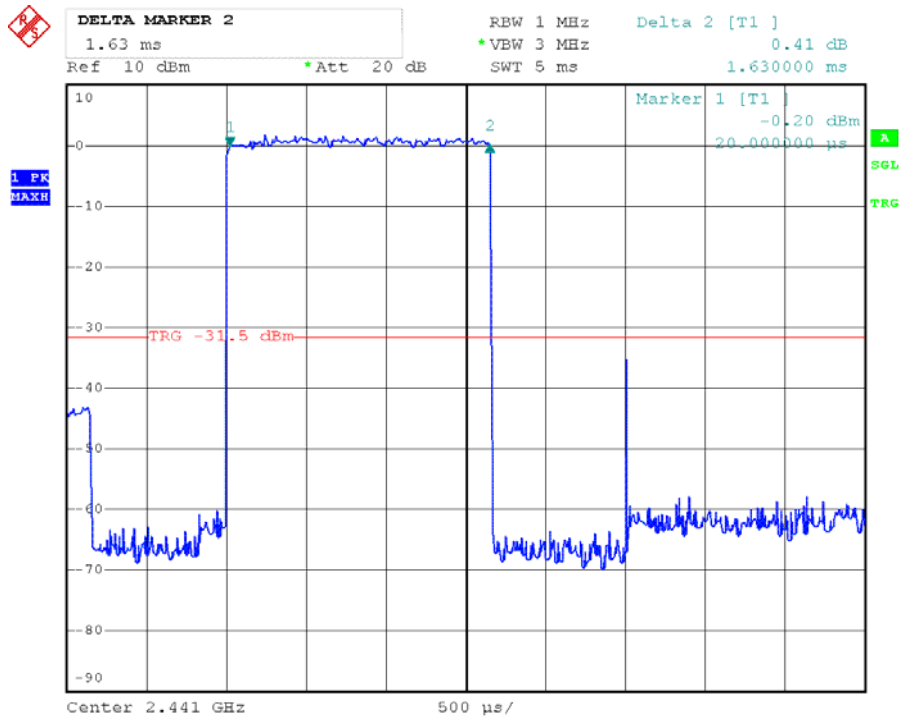

Channel High

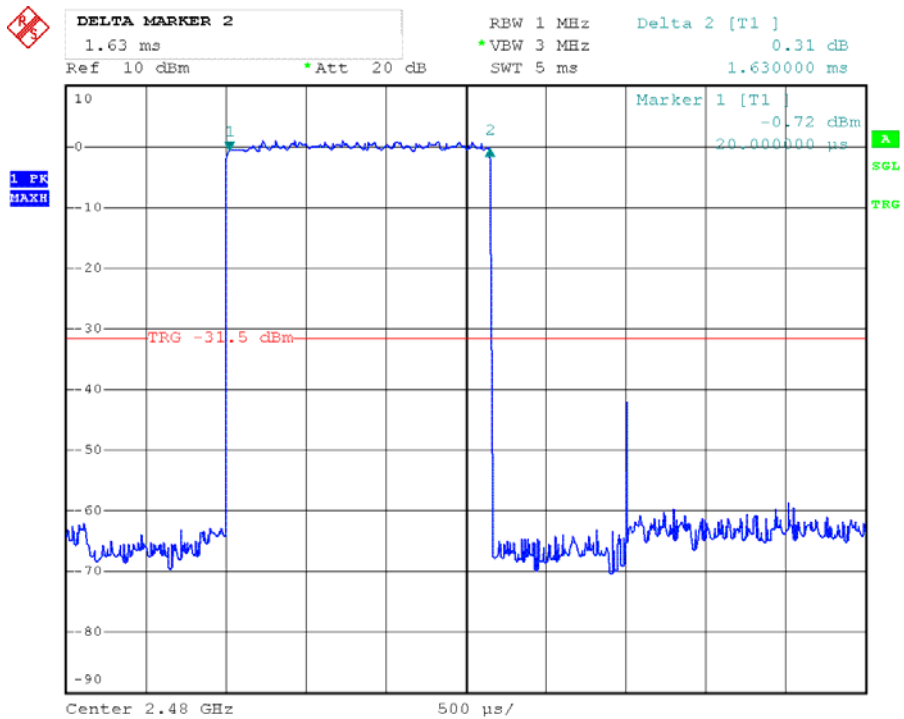

EDR 3M 3DH5 Channel Low

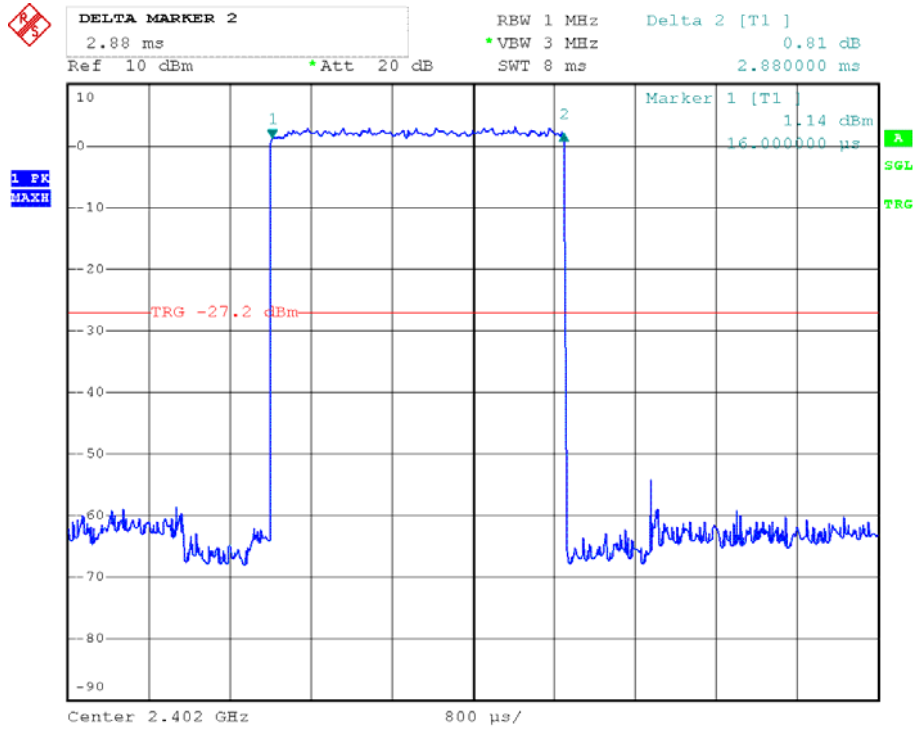

Channel Middle

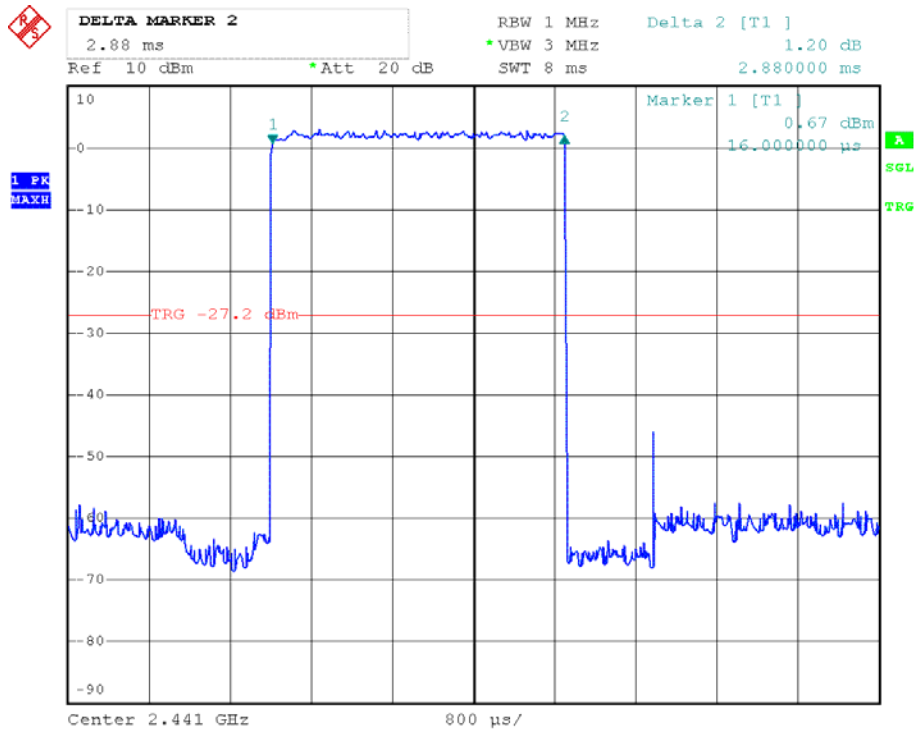

Channel High

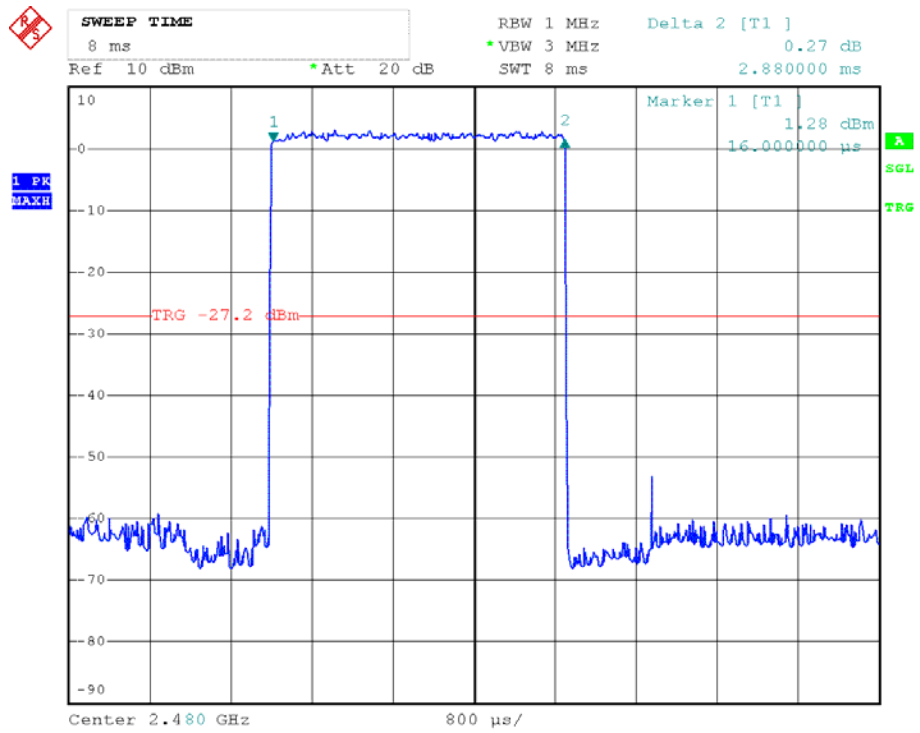

9. Test of Maximum Peak Output Power

9.1 Applicable Standard

Section 15.247(b)(1): For frequency hopping systems operating in the 2400-2483.5 MHz band employing at least 75 non-overlapping hopping channels and The maximum peak output power shall not exceed 1 watt. For all other frequency hopping systems in this frequency band, The maximum peak output power shall not exceed 0.125 watt.

9.2 EUT Setup

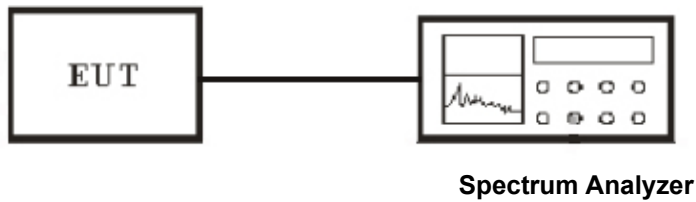

9.3 Test Equipment List and Details

See **section 2.5**.

9.4 Test Procedure

1. The transmitter output was connected to the peak power meter and recorded the peak value.
2. Peak power meter parameter set to auto attenuator and filter is the same as.
3. Repeated the 1 for the middle and highest channel of the EUT.

9.5 Test Result

Temperature (°C) : 22~23	EUT: Tablet PC
Humidity (%RH) : 50~54	M/N: B10T
Barometric Pressure (mbar) : 950~1000	Operation Condition: Tx Mode

BDR 1M

Modulation Type	Channel No.	Frequency (MHz)	Output Power (dBm)	Limits (dBm)	Margin (dB)
GFSK	Low	2402.00	0.98	21	-24.49
GFSK	Middle	2441.00	0.94	21	-24.89
GFSK	High	2480.00	1.25	21	-25.89

EDR 2M

Modulation Type	Channel No.	Frequency (MHz)	Output Power (dBm)	Limits (dBm)	Margin (dB)
Pi/4 DQPSK	Low	2402.00	-0.95	21	-25.41
Pi/4 DQPSK	Middle	2441.00	-0.76	21	-25.66
Pi/4 DQPSK	High	2480.00	-0.44	21	-26.63

EDR 3M

Modulation Type	Channel No.	Frequency (MHz)	Output Power (dBm)	Limits (dBm)	Margin (dB)
8-DPSK	Low	2402.00	-0.72	21	-24.46
8-DPSK	Middle	2441.00	-0.74	21	-24.90
8-DPSK	High	2480.00	-0.42	21	-25.92

BDR 1M Channel Low

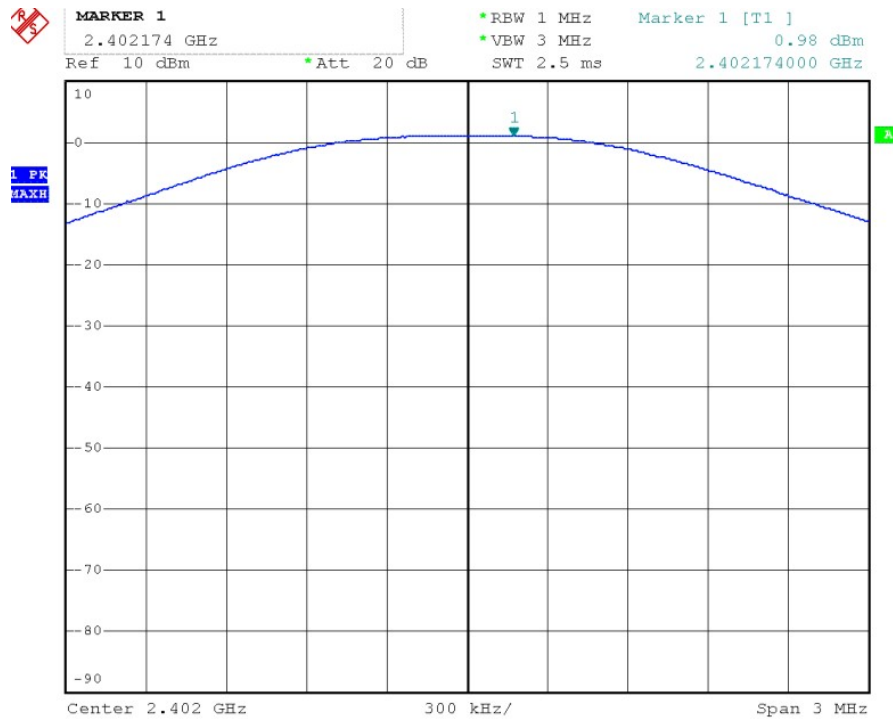

Channel Middle

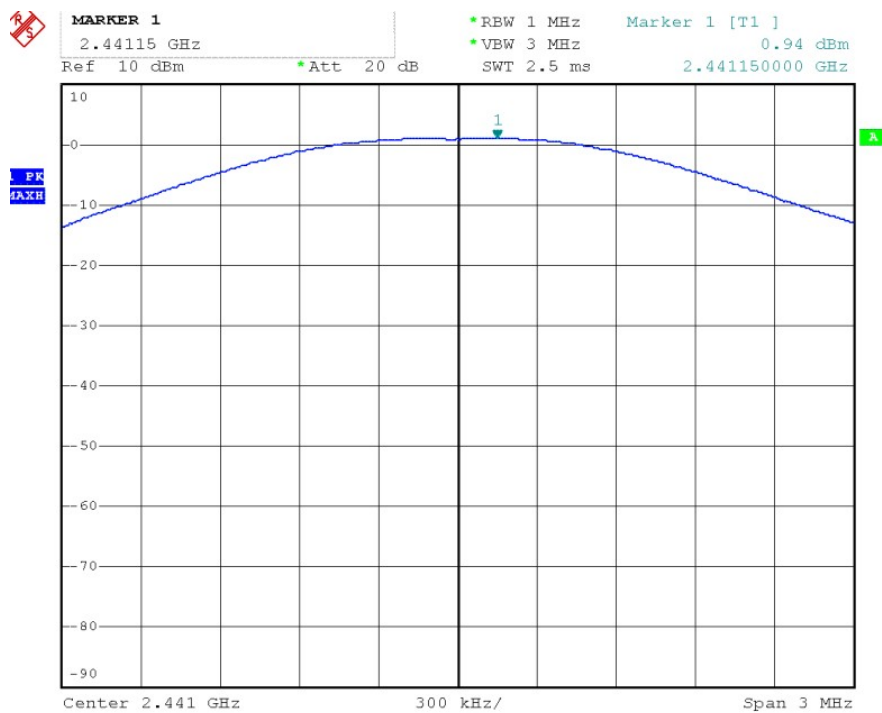

Channel High

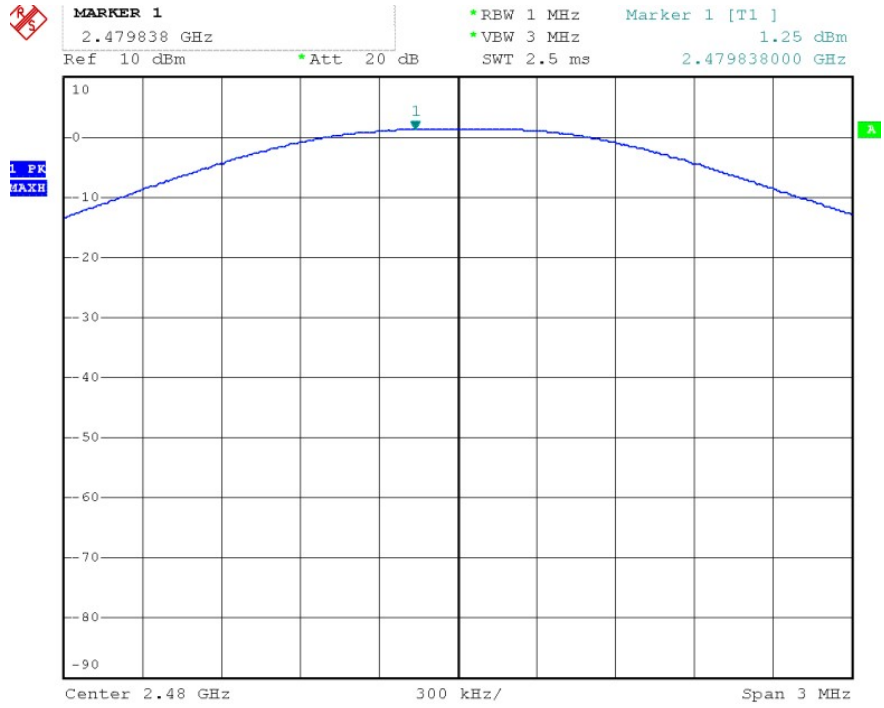

EDR 2M Channel Low

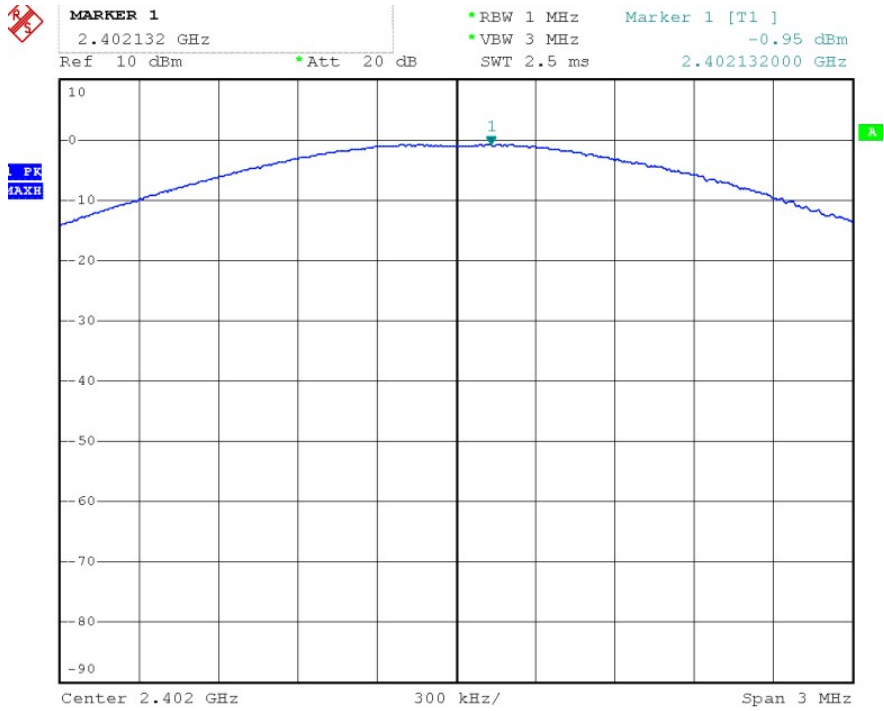

Channel Middle

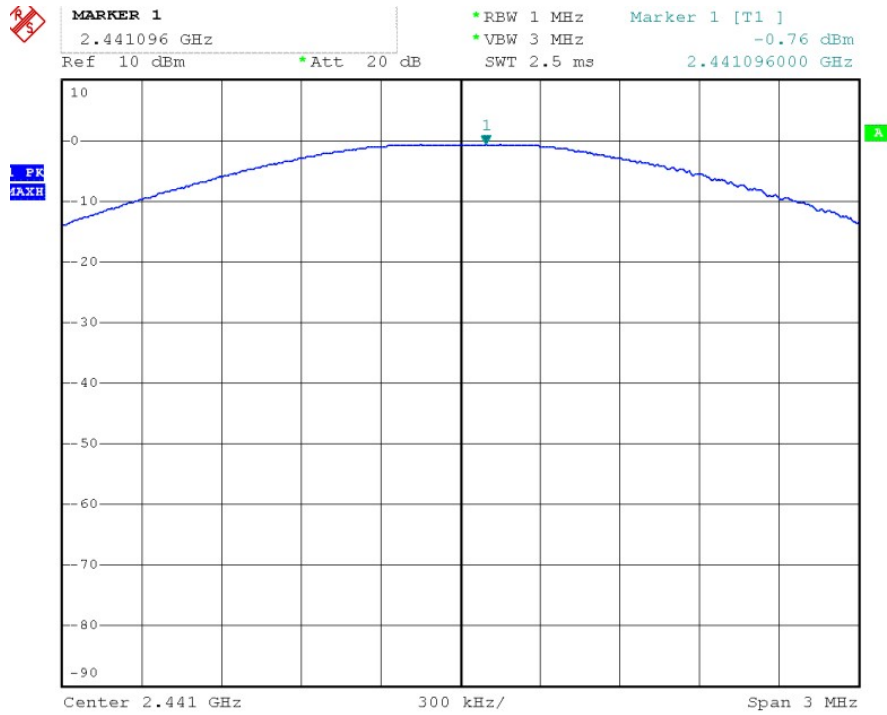

Channel High

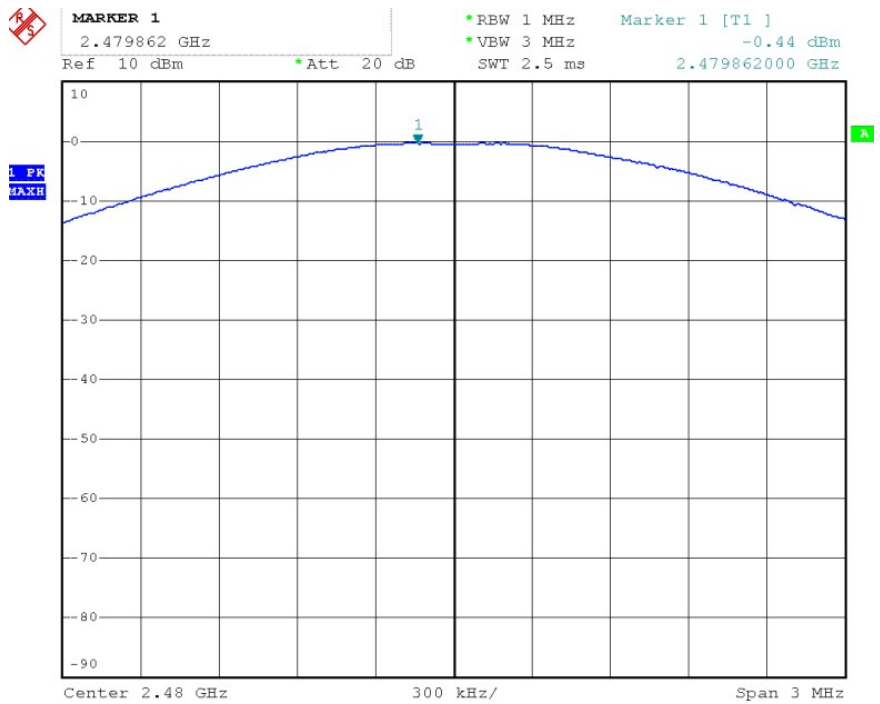

EDR 3M Channel Low

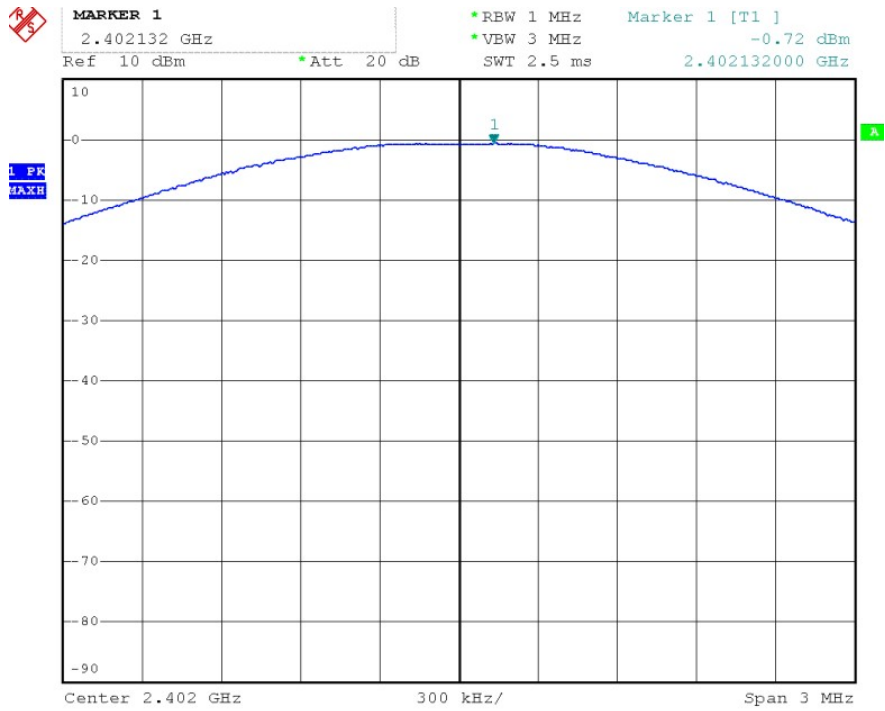

Channel Middle

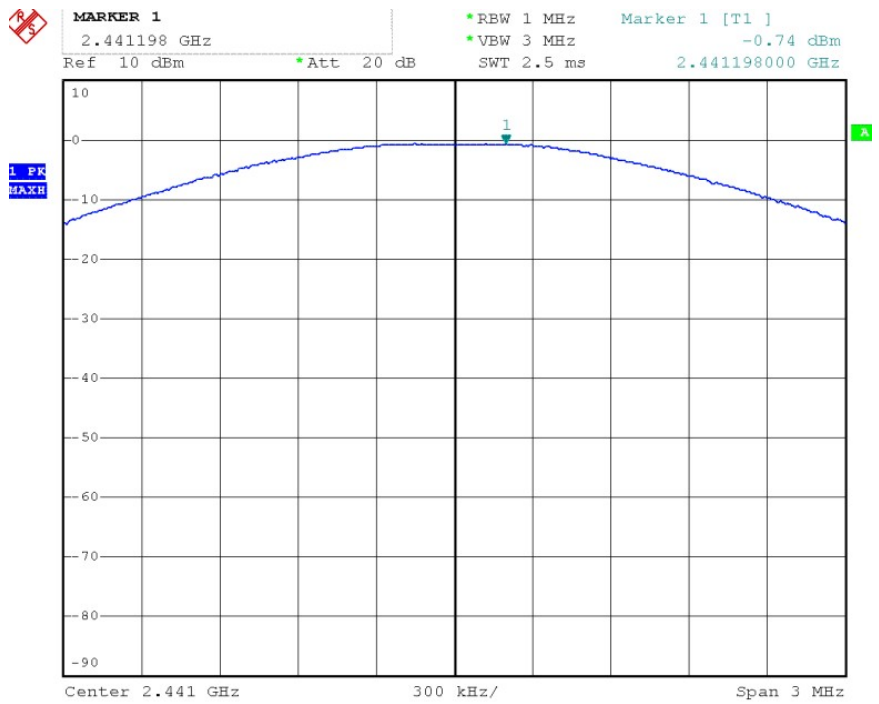

Channel High

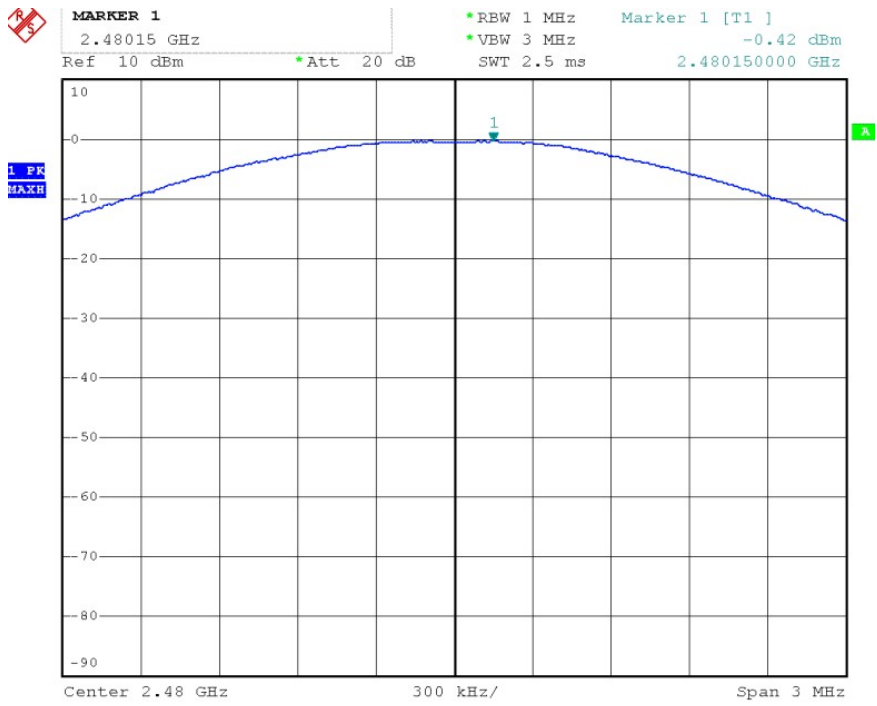

10. Test of Band Edges Emission

10.1 Applicable Standard

Section 15.247(d): In any 100 kHz bandwidth outside the frequency band in which the spread spectrum or digitally modulated intentional radiator is operating, the radio frequency power that is produced by the intentional radiator shall be at least 20 dB below that in the 100 kHz bandwidth within the band that contains the highest level of the desired power, based on either an RF conducted or a radiated measurement. In addition, radiated emissions that fall in the restricted bands, as defined in Section 15.205, must also comply with the radiated emission limits specified in Section 15.209.

10.2 EUT Setup

Radiated Measurement Setup

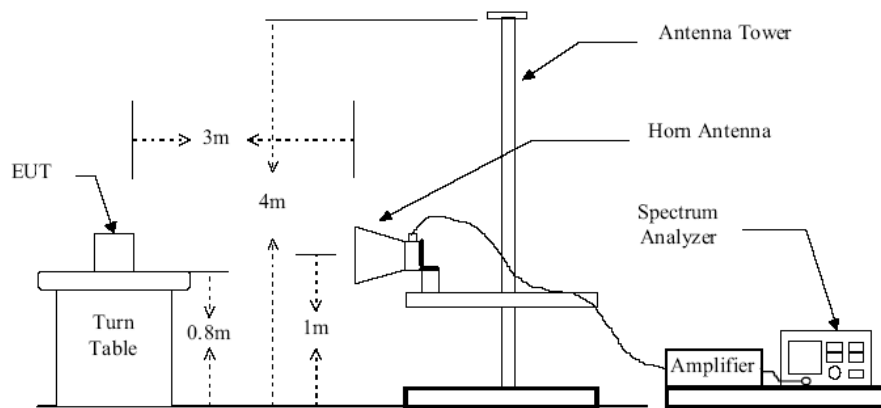
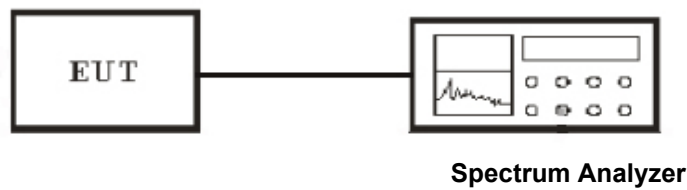

Figure 2 : Frequencies measured above 1 GHz configuration

Conducted Measurement Setup



10.3 Test Equipment List and Details

See section 2.5.

10.4 Test Procedure

Conducted Measurement

1. The transmitter is set to the lowest channel.
2. The transmitter output was connected to the spectrum analyzer.

3. Set both RBW and VBW of spectrum analyzer to 100KHz with convenient frequency span including 100MHz bandwidth from lower band edge. Then detector set to peak and max hold this trace.
4. The lowest band edges emission was measured and recorded.
5. The transmitter set to the highest channel and repeated 2~4.

Radiated Measurement

1. Configure the EUT according to ANSI C63.4-2003
2. The turntable was rotated by 360 degrees to determine the position of the highest radiation.
3. The height of the broadband receiving antenna was varied between one meter and four meters above ground to find the maximum emission field strength of both horizontal and vertical polarization.
4. For band edge emission, the antenna tower was scan (from 1 M to 4 M) and then the turn table was rotated (from 0 degree to 360 degrees) to find the maximum reading.
5. For band edge emission, use 1MHz VBW and 1MHz RBW for reading under AV and use 1MHz VBW and 1MHz RBW for reading under PK.

10.5 Test Result

Temperature (°C) : 22~23	EUT: Tablet PC
Humidity (%RH) : 50~54	M/N: B10T
Barometric Pressure (mbar) : 950~1000	Operation Condition: Tx Mode

Radiated Test Result

Worst Case BDR 1M

Frequency (MHz)	Antenna Polarization	Emission Read Value (dB μ V/m)	Limits (dB μ V/m)
2389.5	H	34.14	54
2483.6	H	33.84	54

Worst Case EDR 2M

Frequency (MHz)	Antenna Polarization	Emission Read Value (dB μ V/m)	Limits (dB μ V/m)
2389.4	H	33.45	54
2483.7	H	34.87	54

Worst Case EDR 3M

Frequency (MHz)	Antenna Polarization	Emission Read Value (dB μ V/m)	Limits (dB μ V/m)
2389.5	H	34.28	54
2483.6	H	34.84	54

**Conducted Test Result
BDR 1M
Low Channel**

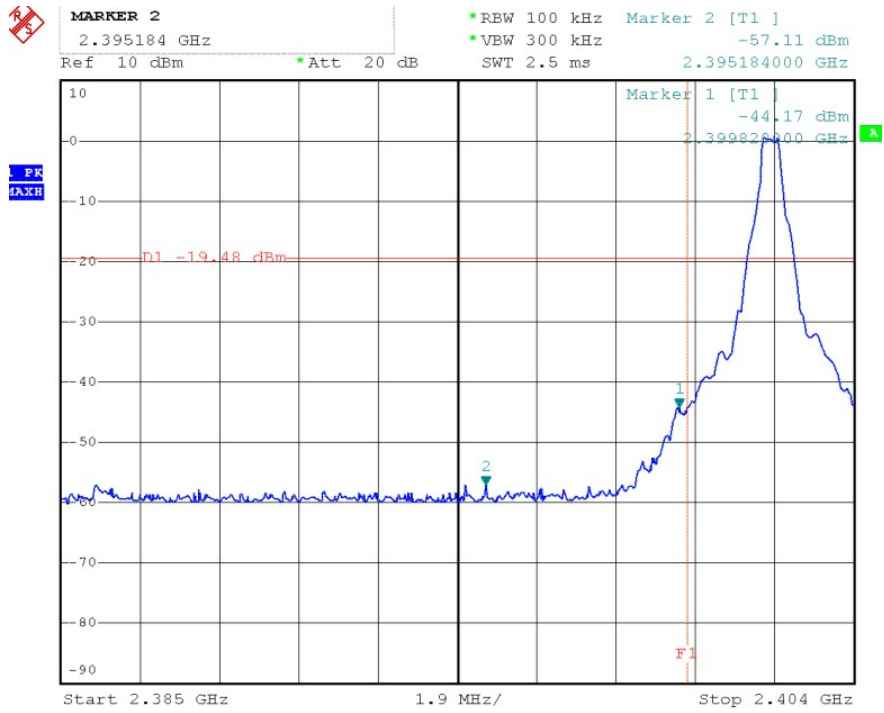

High Channel

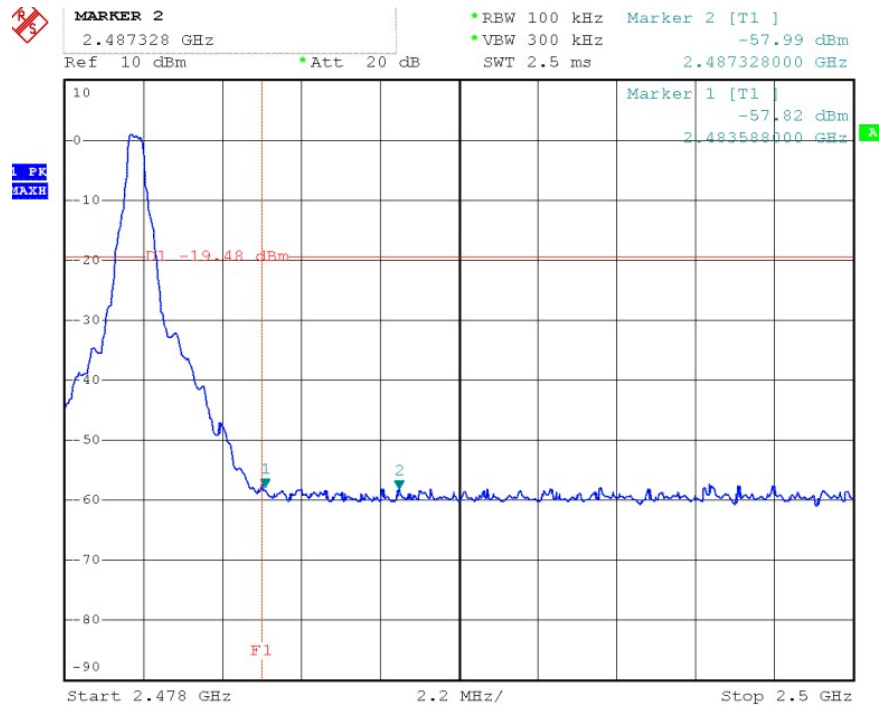

EDR 2M Low Channel

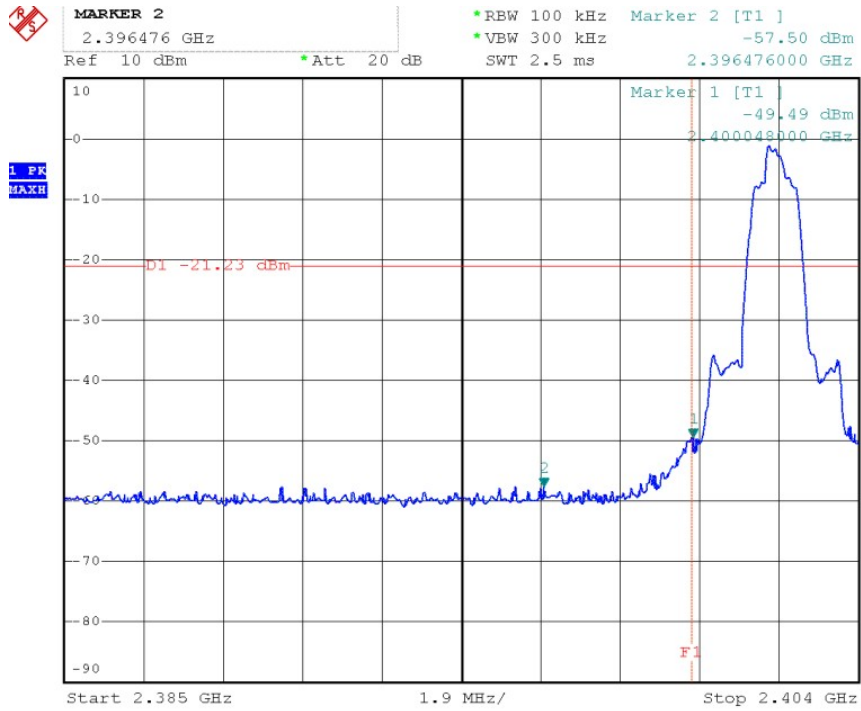

High Channel

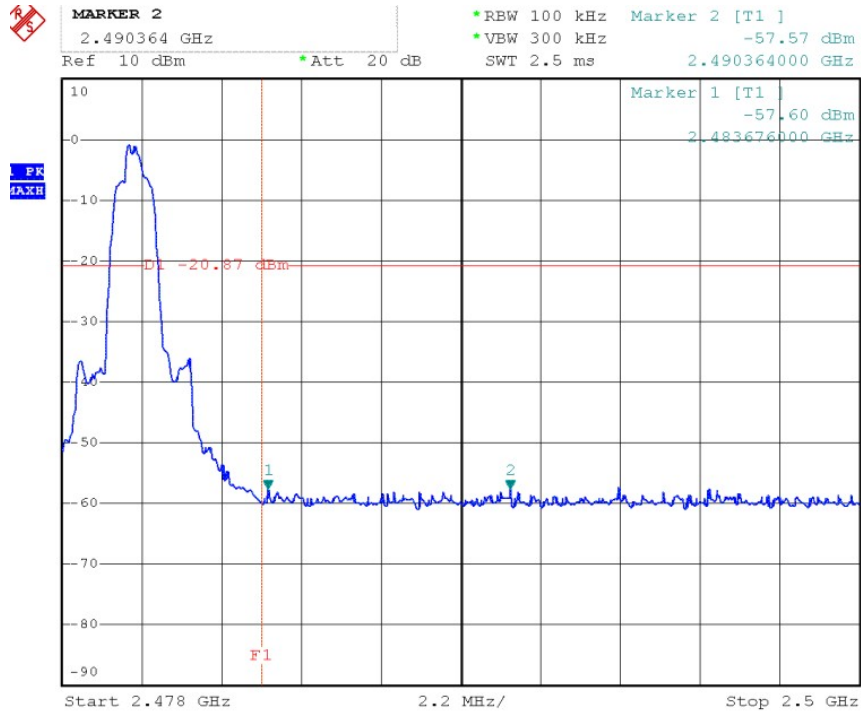

EDR 3M Low Channel

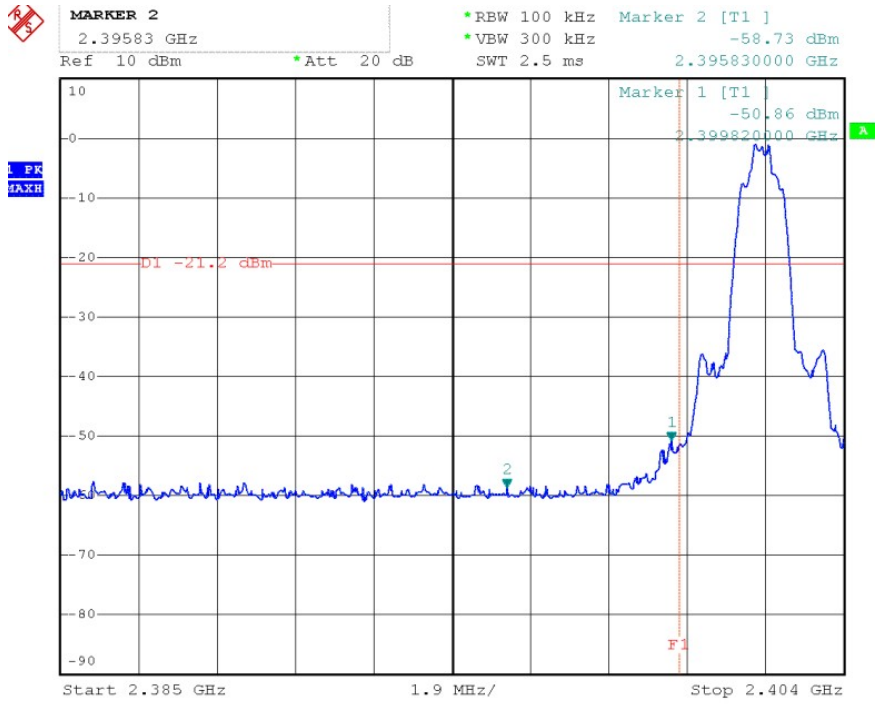

High Channel

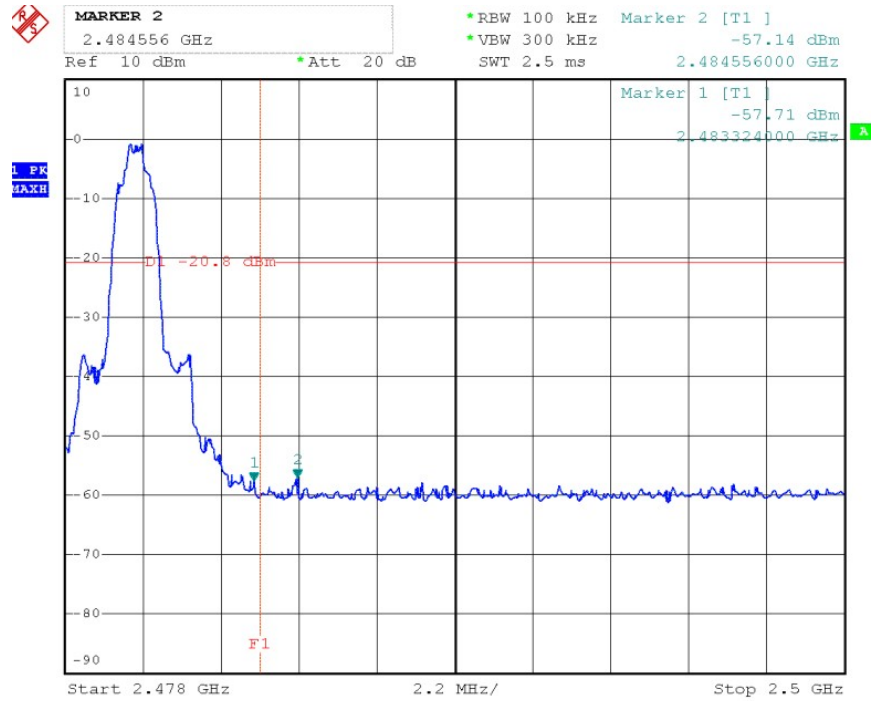

11. Test of Spurious Radiated Emission

11.1 Applicable Standard

Section 15.247(d): In any 100 kHz bandwidth outside the frequency band in which the spread spectrum or digitally modulated intentional radiator is operating, the radio frequency power that is produced by the intentional radiator shall be at least 20 dB below that in the 100 kHz bandwidth within the band that contains the highest level of the desired power, based on either an RF conducted or a radiated measurement. In addition, radiated emissions that fall in the restricted bands, as defined in Section 15.205, must also comply with the radiated emission limits specified in Section 15.209.

11.2 EUT Setup

Radiated Measurement Setup

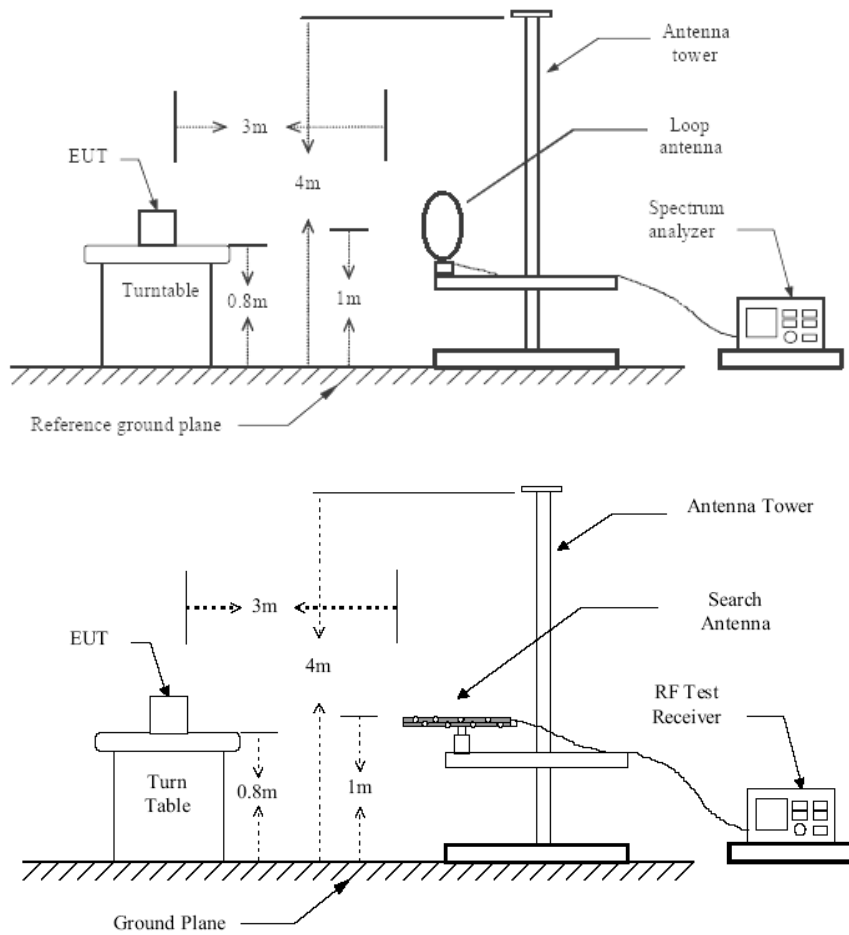

Figure 1 : Frequencies measured below 1 GHz configuration

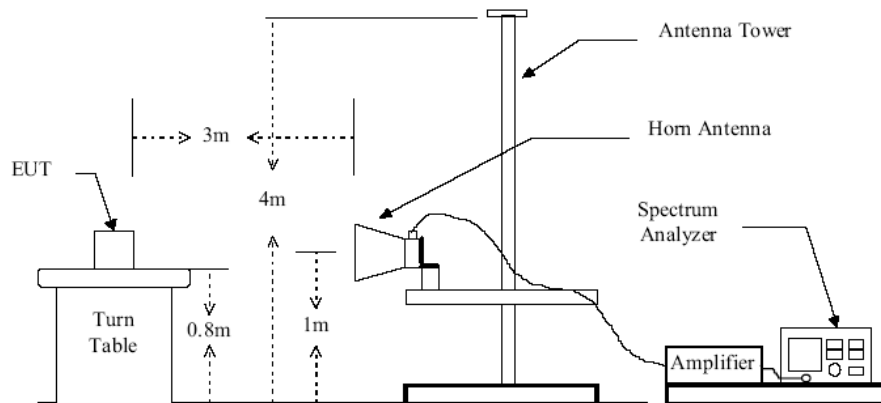
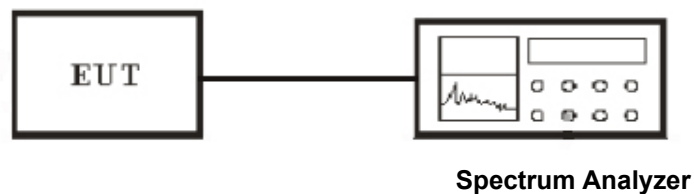

Figure 2 : Frequencies measured above 1 GHz configuration

Conducted Measurement Setup



11.3 Test Equipment List and Details

See section 2.5.

11.4 Test Procedure

Radiated Measurement

1. Configure the EUT according to ANSI C63.4-2009
2. The EUT was placed on the top of the turntable 0.8 meter above ground.
3. The phase center of the receiving antenna mounted on the top of a height-variable antenna tower was placed 3 meters far away from the turntable.
4. Power on the EUT and all the supporting units.
5. The turntable was rotated by 360 degrees to determine the position of the highest radiation.
6. The height of the broadband receiving antenna was varied between one meter and four meters above ground to find the maximum emission field strength of both horizontal and vertical polarization.
7. For each suspected emission, the antenna tower was scanned (from 1 M to 4 M) and then the turntable was rotated (from 0 degree to 360 degrees) to find the maximum reading.
8. According to the characteristic of the EUT crystals, the range of frequencies was investigated from 9KHz to 30MHz, 30MHz to 1GHz and 1GHz to 26GHz.

9. For emission below 1GHz, Set the test-receiver system to Peak or CISPR quasi-peak Detect Function with specified bandwidth under Maximum Hold Mode.

10. For emission above 1GHz, Set the RBW=1MHz,VBW=3MHz for Peak Detector while the RBW=1MHz, VBW=10Hz for Average Detector, Readings are both peak and average values.

11. The pre-test have done for the EUT in three axes and found the worst emission at position shown in test setup photos. The worst case data is recorded in the report. All emission not reported are much lower than the prescribed limits.

Conducted Measurement

1. For emission above 1GHz to 26G,conducted measurement method is used.
2. The transmitter is set to the lowest channel.
3. The transmitter output was connected to the spectrum analyzer via a cable and cable loss is used as the offset of the spectrum analyzer.
4. Set RBW to 1 MHz and VBW to 3 MHz, Then detector set to peak and max hold this trace.
5. The lowest band edges emission was measured and recorded.
6. The transmitter set to the highest channel and repeated 2~4.

11.5 Test Result

Temperature (°C) : 22~23	EUT: Tablet PC
Humidity (%RH) : 50~54	M/N: B10T
Barometric Pressure (mbar) : 950~1000	Operation Condition: Charging, playing

Note: In this testing, the EUT was respectively tested in three different orientations. That is:

1. EUT was lie vertically, and then its Antenna oriented upward
2. EUT was lie vertically, and then its Antenna oriented downward
3. EUT was lie flatwise, and then its Antenna oriented to the receiving antenna

The worst test data see following pages

When the EUT was lie flatwise, and its Antenna oriented to the receiving antenna, the worst test data was got as following table.

WORST-CASE RADIATED EMISSION BELOW 30 MHz

Continue Tx operating Mode:

Frequency	Meter Reading	Antenna Factor	Cable Loss	Emission Levels	Limits	Margin	Detector Mode
(MHz)	(dBµV)	(dB/M)	(dB)	(dBµV/M)	(dB µ V/M)	(dB)	PK/QP
0.41	24.63	7.81	1.03	31.41	67	-35.59	QP
15.36	22.75	8.21	1.19	29.77	49.5	-19.73	QP
16.54	22.18	8.63	1.08	29.73	49.5	-19.77	QP
21.25	22.39	7.71	1.66	28.44	49.5	-21.06	QP

WORST-CASE RADIATED EMISSION BELOW 1 GHz

Tx operating BDR Low Channel Mode:
Horizontal

Frequency	Meter Reading	Tansd	Limits	Margin	Detector Mode
(MHz)	(dBµV)	(dB)	(dB µ V/M)	(dB)	PK/QP
46.35	33.34	15.9	40	-6.66	QP
78.52	36.85	12	40	-3.15	QP
175.85	27.85	13.4	43.5	-15.65	QP
296.94	33.84	18.6	46	-12.16	QP
485.35	36.85	22.7	46	-9.15	QP
575.35	37.54	25.5	46	-8.46	QP
N/A	----	----	----	----	----

Vertical

Frequency	Meter Reading	Tansd	Limits	Margin	Detector Mode
(MHz)	(dBµV)	(dB)	(dB µ V/M)	(dB)	PK/QP
84.69	32.12	14.1	40	-7.88	QP
167.58	32.84	13	43.5	-10.66	QP
249.35	39.84	17.2	46	-6.16	QP
278.44	31.63	17.9	46	-14.37	QP
328.76	38.54	19.6	46	-7.46	QP
926.35	37.25	29.4	46	-8.75	QP
N/A	----	----	----	----	----

Note: 1. Transd.=Antenna Factor+Cable Loss-Pre-amplifier
Margin = Level-Limit

**Worst case BDR 1M
Spurious Emission test data above 1G**

Channel Low								
Maximum Frequency (MHz)	Polarity and Level					Limit (dBµV/m)	Margin (dBµV/m)	Mark (P/Q/A)
	Polarity	Height (m)	Reading dBµV	Transd	Result dBµV/m			
2402	H	1	76.85	-6.61	70.24	---	---	P
			67.36	-6.61	60.75	---	---	A
2402	V	1	78.94	-6.61	72.33	---	---	P
			67.46	-6.61	60.85	---	---	A
4804.03	H	1	48.38	-0.67	47.71	74	-26.29	P
			34.52	-0.67	33.85	54	-20.15	A
4804.03	V	1	49.36	-0.67	48.69	74	-25.31	P
			34.63	-0.67	33.96	54	-20.04	A
7206.05	H	1	43.06	1.35	44.41	74	-29.59	P
			32.38	1.35	33.73	54	-20.27	A
7206.05	V	1	45.35	1.35	46.7	74	-27.3	P
			32.85	1.35	34.2	54	-19.8	A
9608.06	H	1	42.58	2.73	45.31	74	-28.69	P
			32.6	2.73	35.33	54	-18.67	A
9608.06	V	1	43.74	2.73	46.47	74	-27.53	P
			32.05	2.73	34.78	54	-19.22	A
12010.07	---		---	---	---	---	---	
14412.08	---		---	---	---	---	---	
16814.09	---		---	---	---	---	---	
19216.11	---		---	---	---	---	---	
21618.12	---		---	---	---	---	---	
24020.13	---		---	---	---	---	---	

Remark: 1. Transd.=Antenna Factor+Cable Loss-Pre-amplifier
Margin = Level-Limit
Mark: P means Peak Value, Q means Quasi Peak Value, A means Average Value
2. Data of measurement within this frequency range shown “-” in the table above means the reading of emissions are attenuated more than 20dB below the permissible limits or the field strength is too small to be measured.
3. Spectrum analyzer setting P(Peak): RBW=1MHz, VBW=1MHz, A(Average): RBW=1MHz, VBW=10Hz.
4. The test limit distance is 3m limit

Channel Mid								
Maximum Frequency (MHz)	Polarity and Level					Limit (dBµV/m)	Margin (dBµV/m)	Mark (P/Q/A)
	Polarity	Height (m)	Reading dBµV	Transd	Result dBµV/m			
2441	H	1	77.35	-6.37	70.98	---	---	P
			68.54	-6.37	62.17	---	---	A
2441	V	1	78.36	-6.37	71.99	---	---	P
			67.59	-6.37	61.22	---	---	A
4882	H	1	48.36	-2.92	45.44	74	-28.56	P
			34.6	-2.92	31.68	54	-22.32	A
4882	V	1	49.38	-2.92	46.46	74	-27.54	P
			34.36	-2.92	31.44	54	-22.56	A
7323	H	1	43.52	0.52	44.04	74	-29.96	P
			32.36	0.52	32.88	54	-21.12	A
7323	V	1	44.38	0.52	44.9	74	-29.1	P
			33.18	0.52	33.7	54	-20.3	A
9764	H	1	42.35	1.48	43.83	74	-30.17	P
			32.38	1.48	33.86	54	-20.14	A
9764	V	1	43.38	1.48	44.86	74	-29.14	P
			32.36	1.48	33.84	54	-20.16	A
12205.11	---		---	---	---	---	---	
14646.13	---		---	---	---	---	---	
17087.14	---		---	---	---	---	---	
19528.16	---		---	---	---	---	---	
21969.2	---		---	---	---	---	---	
24410.21	---		---	---	---	---	---	

Remark: 1. Transd.=Antenna Factor+Cable Loss-Pre-amplifier
Margin = Level-Limit
Mark: P means Peak Value, Q means Quasi Peak Value, A means Average Value
2. Data of measurement within this frequency range shown “-” in the table above means the reading of emissions are attenuated more than 20dB below the permissible limits or the field strength is too small to be measured.
3. Spectrum analyzer setting P(Peak): RBW=1MHz, VBW=1MHz, A(Average): RBW=1MHz, VBW=10Hz.
4. The test limit distance is 3m limit

Channel High								
Maximum Frequency (MHz)	Polarity and Level					Limit (dBµV/m)	Margin (dBµV/m)	Mark (P/Q/A)
	Polarity	Height (m)	Reading dBµV	Transd	Result dBµV/m			
2480.01	H	1	76.35	-6.28	70.07	---	---	P
			67.84	-6.28	61.56	---	---	A
2480.01	V	1	77.85	-6.28	71.57	---	---	P
			68.06	-6.28	61.78	---	---	A
4960.02	H	1	47.36	1.17	48.53	74	-25.47	P
			34.58	1.17	35.75	54	-18.25	A
4960.02	V	1	49.35	1.17	50.52	74	-23.48	P
			35.36	1.17	36.53	54	-17.47	A
7440.03	H	1	42.38	2.25	44.63	74	-29.37	P
			32.35	2.25	34.6	54	-19.4	A
7440.03	V	1	43.85	2.25	46.1	74	-27.9	P
			33.64	2.25	35.89	54	-18.11	A
9920.04	H	1	42.38	4.53	46.91	74	-27.09	P
			32.65	4.53	37.18	54	-16.82	A
9920.04	V	1	43.36	4.53	47.89	74	-26.11	P
			33.65	4.53	38.18	54	-15.82	A
12400.05	---		---	---	---	---	---	
14880.06	---		---	---	---	---	---	
17360.07	---		---	---	---	---	---	
19840.08	---		---	---	---	---	---	
22320.09	---		---	---	---	---	---	
24800.1	---		---	---	---	---	---	

Remark: 1. Transd.=Antenna Factor+Cable Loss-Pre-amplifier
Margin = Level-Limit
Mark: P means Peak Value, Q means Quasi Peak Value, A means Average Value
2. Data of measurement within this frequency range shown “-” in the table above means the reading of emissions are attenuated more than 20dB below the permissible limits or the field strength is too small to be measured.
3. Spectrum analyzer setting P(Peak): RBW=1MHz, VBW=1MHz, A(Average): RBW=1MHz, VBW=10Hz.
4. The test limit distance is 3m limit

Conducted Spurious Emission BDR 1M Channel Low

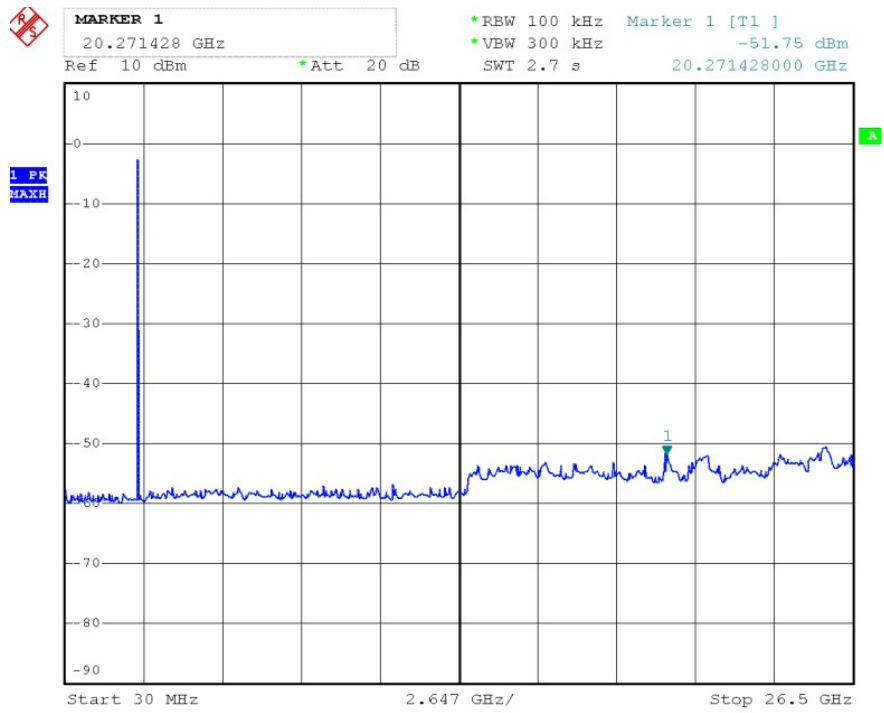

Channel Mid

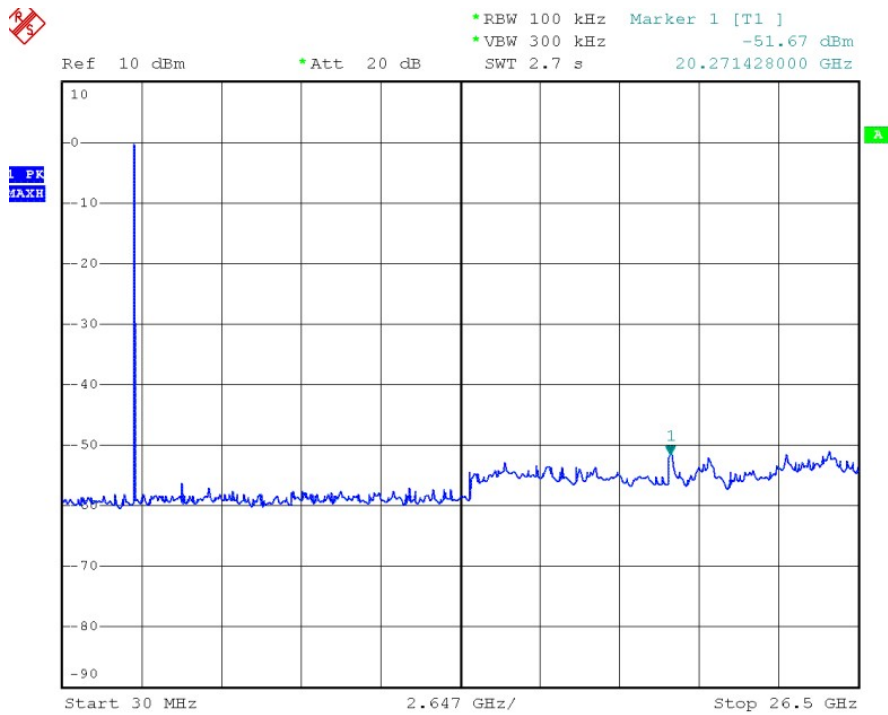

Channel High

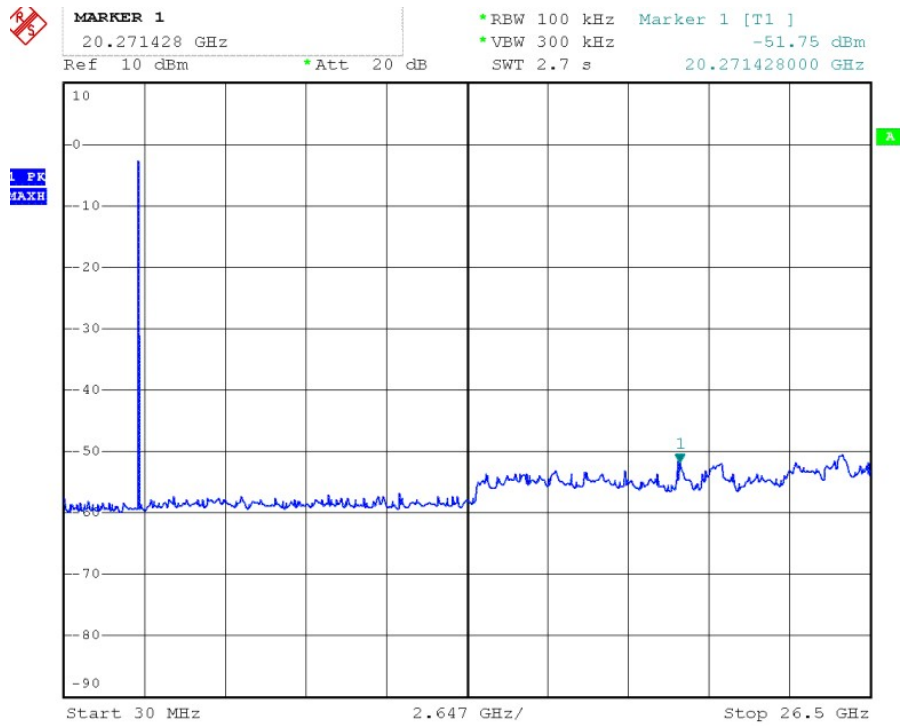

BDR 2M Channel Low

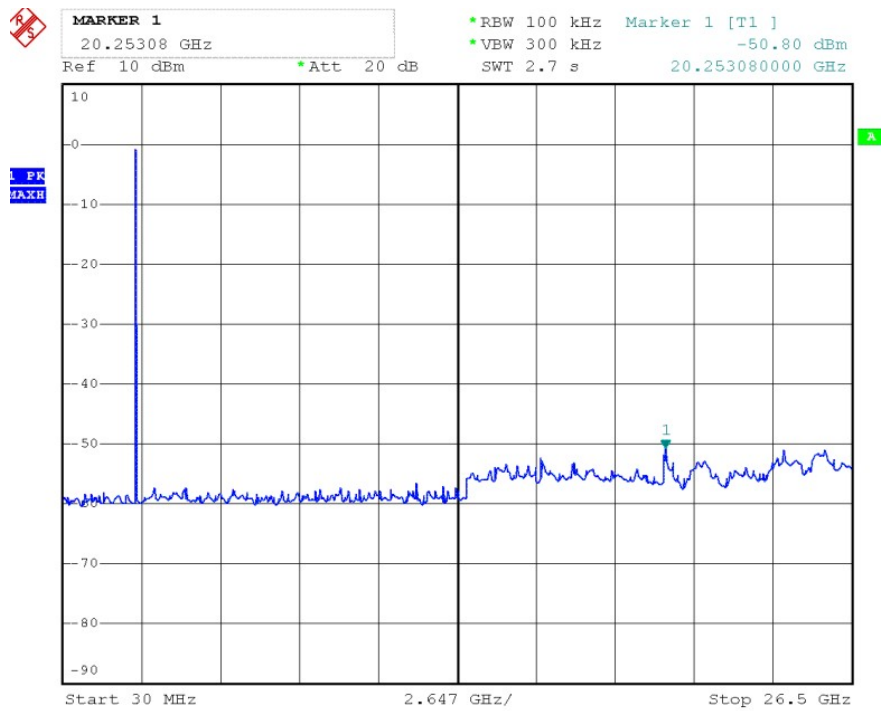

Channel Middle

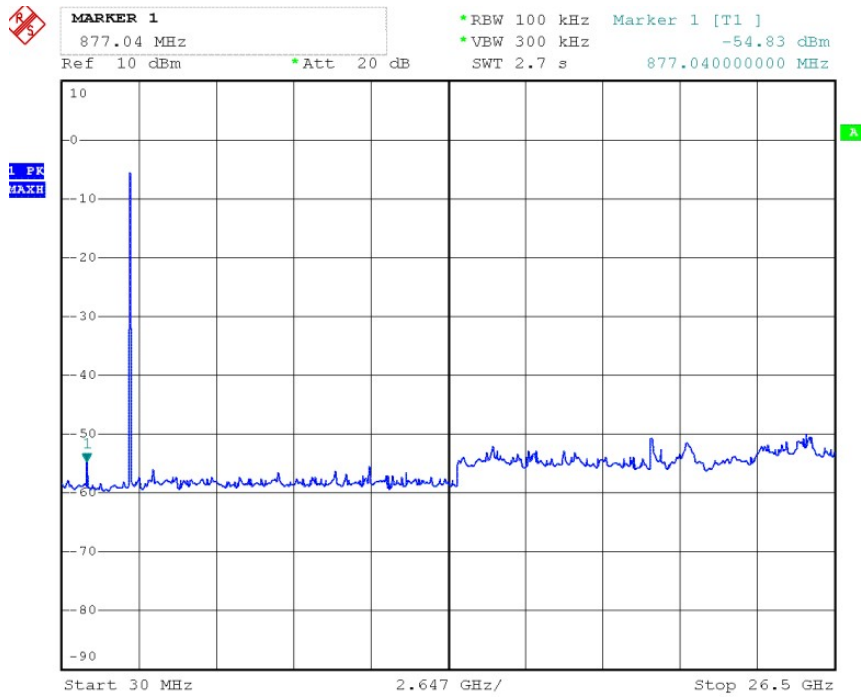

Channel High

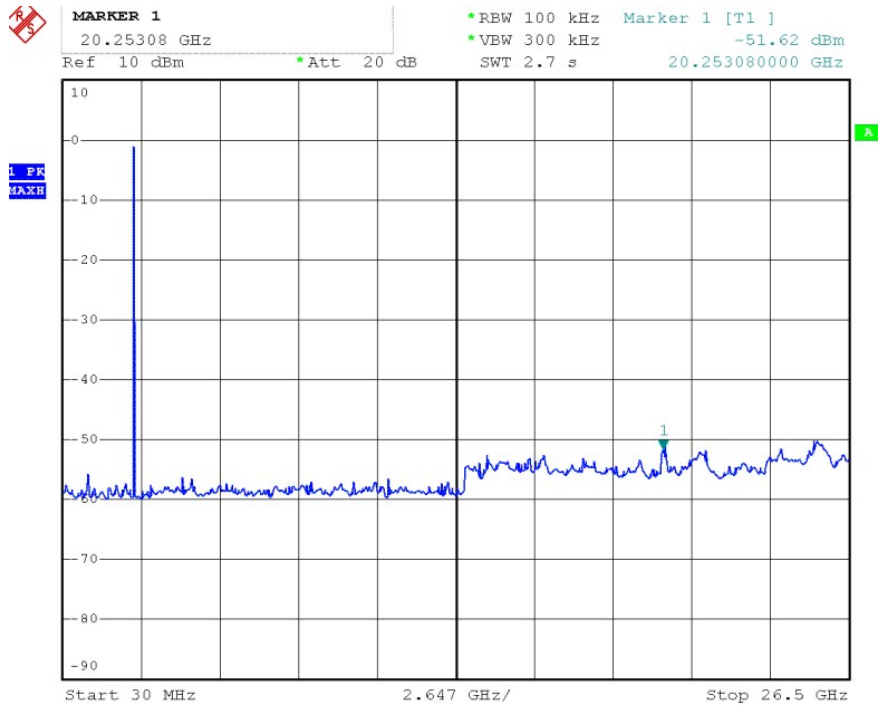

BDR 3M Channel Low

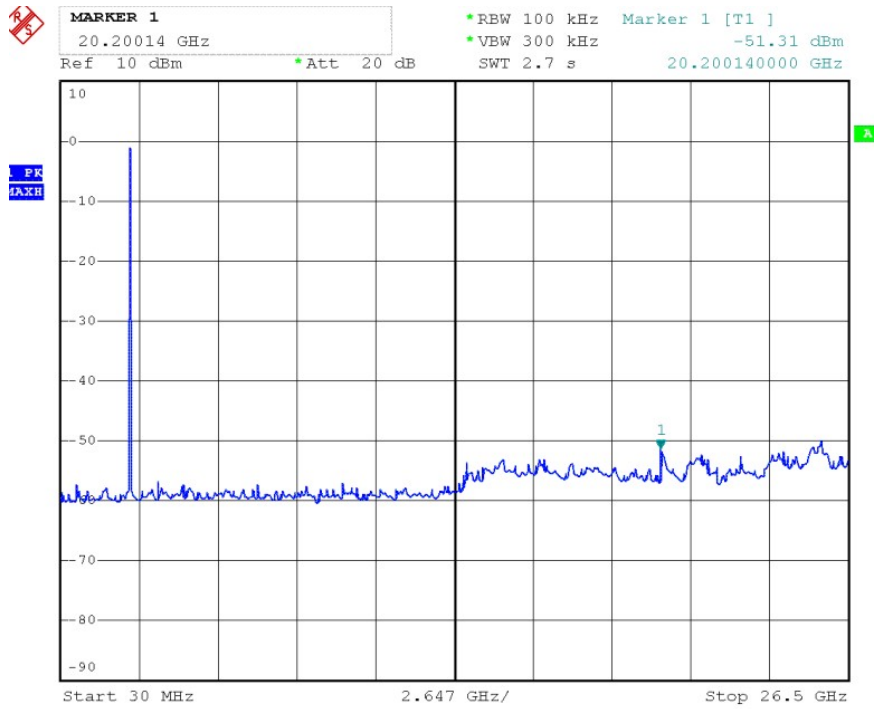

Channel Middle

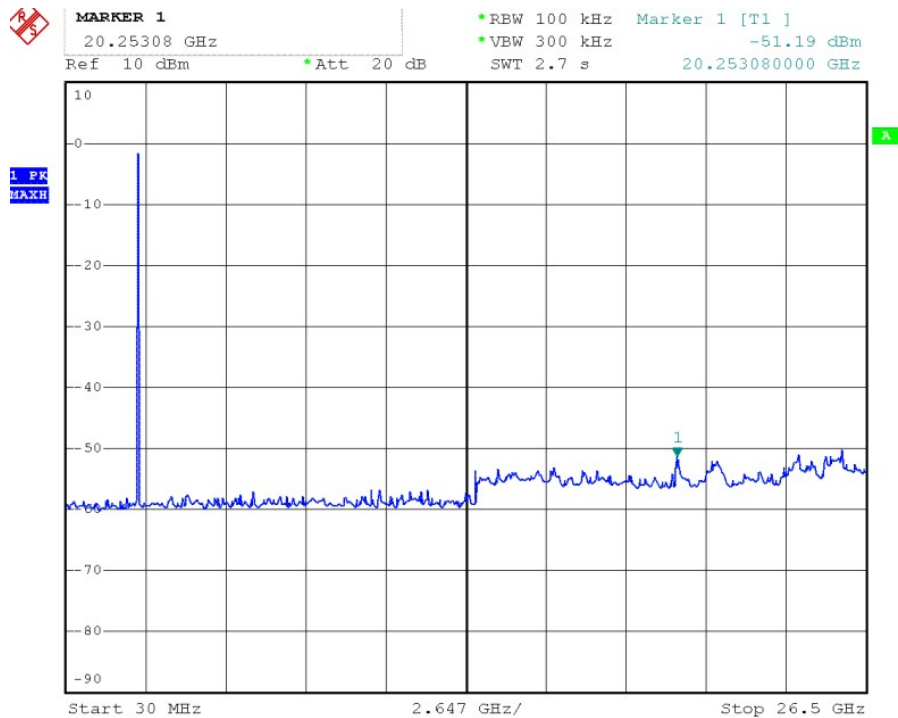

Channel High

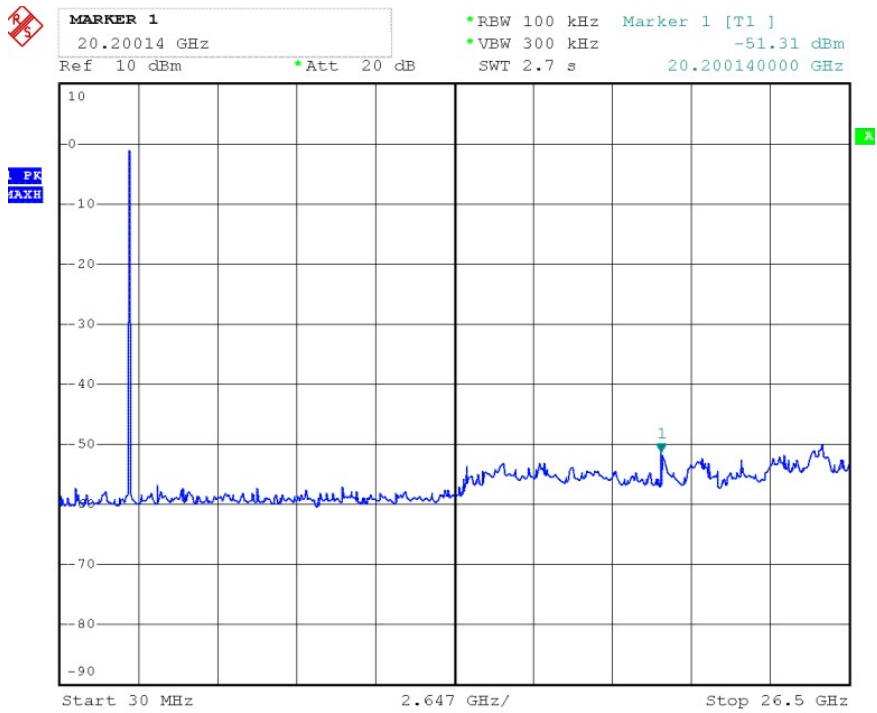

12. ANTENNA REQUIREMENT

12.1 Standard Applicable

Section 15.203:

An intentional radiator shall be designed to ensure that no antenna other than that furnished by the responsible party shall be used with the device. The use of a permanently attached antenna or of an antenna that uses a unique coupling to the intentional radiator shall be considered sufficient to comply with the provisions of this Section. The manufacturer may design the unit so that a broken antenna can be replaced by the user, but the use of a standard antenna jack or electrical connector is prohibited.

Section 15.247(b)/(c):

If transmitting antennas of directional gain greater than 6 dBi are used, the peak output power from the intentional radiator shall be reduced by the amount in dB that the directional gain of the antenna exceeds 6 dBi.

If the intentional radiator is used exclusively for fixed, point-to-point operations may employ transmitting antennas with directional gain greater than 6 dBi provided the maximum peak output power of the intentional radiator is reduced by 1 dB for every 3 dB that the directional gain of the antenna exceeds 6 dBi.

12.2 Antenna Connected Construction

The antenna is designed with permanent attachment and no consideration of replacement. The antenna used in this product is complied with Standard. The maximum Gain of the antenna lower than 6.0dBi and have the definite antenna Specification.