



## FCC - TEST REPORT

Report Number : **68.930.21.0028.01** Date of Issue: July 29, 2022

Model : **MD3610B, MD3600B**

Product Type : Digital Automatic Blood Pressure Monitor

Applicant : Grandway Technology (Shenzhen) Limited

Address : No. 5, the Second Industrial Zone, Zhukeng Community, Longtian  
Street, Pingshan District, 518118 Shenzhen, China

Production Facility : Grandway Technology (Shenzhen) Limited

Address : No. 5, the Second Industrial Zone, Zhukeng Community, Longtian  
Street, Pingshan District, 518118 Shenzhen, China

Test Result :  **Positive**       **Negative**

Total pages including Appendices : 36

*Any use for advertising purposes must be granted in writing. This technical report may only be quoted in full. This report is the result of a single examination of the object in question and is not generally applicable evaluation of the quality of other products in regular production. For further details, please see testing and certification regulation, chapter A-3.4.*



# 1 Table of Contents

1	Table of Contents .....	2
2	Details about the Test Laboratory.....	3
3	Description of the Equipment under Test .....	4
4	Summary of Test Standards.....	5
5	Summary of Test Results.....	6
6	General Remarks .....	7
7	Test Setups .....	9
8	Systems test configuration.....	10
9	Technical Requirement .....	11
9.1	Conducted Emission .....	11
9.2	Conducted Peak output power .....	14
9.3	6 dB Bandwidth.....	16
9.4	Power spectral density.....	18
9.5	Spurious RF conducted emissions .....	20
9.6	Band edge .....	24
9.7	Spurious radiated emissions for transmitter .....	26
10	Test Equipment List.....	34
11	System Measurement Uncertainty .....	36



## 2 Details about the Test Laboratory

### Details about the Test Laboratory

#### Test Site 1

Company name: TÜV SÜD Certification and Testing (China) Co., Ltd. Shenzhen Branch  
Building 12&13, Zhiheng Wisdomland Business Park,  
Nantou Checkpoint Road 2, Nanshan District,  
Shenzhen City, 518052,  
P. R. China

FCC Registration Number: 514049

FCC Designation Number: CA5009

Telephone: 86 755 8828 6998  
Fax: 86 755 8828 5299

### 3 Description of the Equipment under Test

Product:	Digital Automatic Blood Pressure Monitor
Model no.:	MD3610B
FCC ID:	2ABAFMD3610B
Ratings:	Input: 6VDC (4x1.5V AA batteries) or 6.0Vdc, 600mA (supplied by a separate approved AC/DC Adapter)
RF Transmission Frequency:	2402MHz-2480MHz
No. of Operated Channel:	40
Modulation:	GFSK
Antenna Type:	Inverted F Antenna
Antenna Gain:	-0.58dBi
Description of the EUT:	The Equipment Under Test (EUT) is a Digital Automatic Blood Pressure Monitor supports 2.4GHz Bluetooth functions.
Remark:	NIL

## 4 Summary of Test Standards

Test Standards	
FCC Part 15 Subpart C 10-1-2019 Edition	PART 15 - RADIO FREQUENCY DEVICES Subpart C - Intentional Radiators

All the test methods were according to KDB558074 D01 15.247 Meas Guidance v05r02 Measurement Guidance and ANSI C63.10 (2013).

## 5 Summary of Test Results

Test Condition		Test Site	Test Result		
			Pass	Fail	N/A
§15.207	Conducted emission AC power port	Site 1	<input checked="" type="checkbox"/>	<input type="checkbox"/>	<input type="checkbox"/>
§15.247 (b) (3)	Conducted peak output power	Site 1	<input checked="" type="checkbox"/>	<input type="checkbox"/>	<input type="checkbox"/>
§15.247(a)(2)	6dB bandwidth	Site 1	<input checked="" type="checkbox"/>	<input type="checkbox"/>	<input type="checkbox"/>
§15.247(a)(1)	Carrier frequency separation	---	<input type="checkbox"/>	<input type="checkbox"/>	<input checked="" type="checkbox"/>
§15.247(a)(1)(iii)	Number of hopping frequencies	---	<input type="checkbox"/>	<input type="checkbox"/>	<input checked="" type="checkbox"/>
§15.247(a)(1)(iii)	Dwell Time	---	<input type="checkbox"/>	<input type="checkbox"/>	<input checked="" type="checkbox"/>
§15.247(e)	Power spectral density	Site 1	<input checked="" type="checkbox"/>	<input type="checkbox"/>	<input type="checkbox"/>
§15.247(d)	Spurious RF conducted emissions	Site 1	<input checked="" type="checkbox"/>	<input type="checkbox"/>	<input type="checkbox"/>
§15.247(d)	Band edge	Site 1	<input checked="" type="checkbox"/>	<input type="checkbox"/>	<input type="checkbox"/>
§15.247(d) & §15.209 & §15.205	Spurious radiated emissions for transmitter	Site 1	<input checked="" type="checkbox"/>	<input type="checkbox"/>	<input type="checkbox"/>
§15.203	Antenna requirement	Note 2	<input checked="" type="checkbox"/>	<input type="checkbox"/>	<input type="checkbox"/>

Note 1: N/A=Not Applicable.

Note 2: The EUT uses Inverted F Antenna, which gain is -0.58dBi. According to §15.203, it is considered sufficiently to comply with the provisions of this section.

## 6 General Remarks

### Remarks

This submittal(s) (test report) is intended for FCC ID: 2ABAFMD3610B complies with Section 15.207, 15.205, 15.209, 15.247 of the FCC Part 15, Subpart C Rules.

The difference between the two models are listed below:

Model	MD3600B	MD3610B
Dimension (mm)	103*139*54	Same
Construction	Without AC-DC function	With AC-DC function
Power supply	4x1.5Vdc AA batteries	4x1.5Vdc AA batteries/ 6V DC, 600mA AC-DC adaptor

Modes MD3610B and MD3600B are identical except model name, DC input port and the color of appearance. DC input port is only reserved for model MD3610B, but model MD3600B without DC input port, and DC input port just plastic parts without any electronic circuit. So the RF full tests were applied on MD3610B, model MD3600B was deemed to fulfil the RF requirement without the further test.

### SUMMARY:

All tests according to the regulations cited on page 5 were

- Performed

- **Not** Performed

The Equipment under Test

- **Fulfills** the general approval requirements.

- **Does not** fulfill the general approval requirements.

Sample Received Date: July 23, 2021

Testing Start Date: July 23, 2021

Testing End Date: August 17, 2021



- TÜV SÜD Certification and Testing (China) Co., Ltd. Shenzhen Branch -

Reviewed by:

Prepared by:

Tested by:

Trevor You  Nick Huang Louise Liu

Trevor You  
EMC Project Manager

Nick Huang  
EMC Project Engineer

Louise Liu  
EMC Test Engineer



## 7 Test Setups

### 7.1 Radiated test setups

Below 1GHz

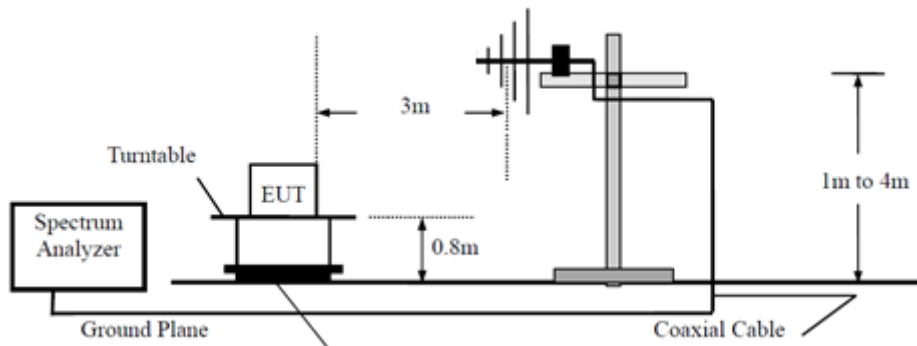

Above 1GHz

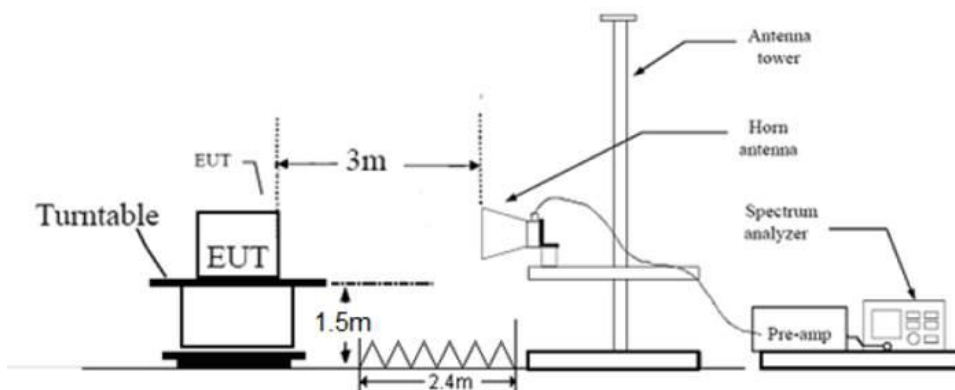

### 7.2 Conducted RF test setups

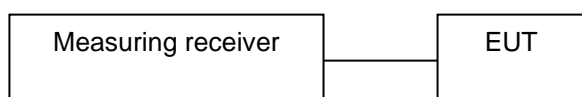

### 7.3 AC Power Line Conducted Emission test setups

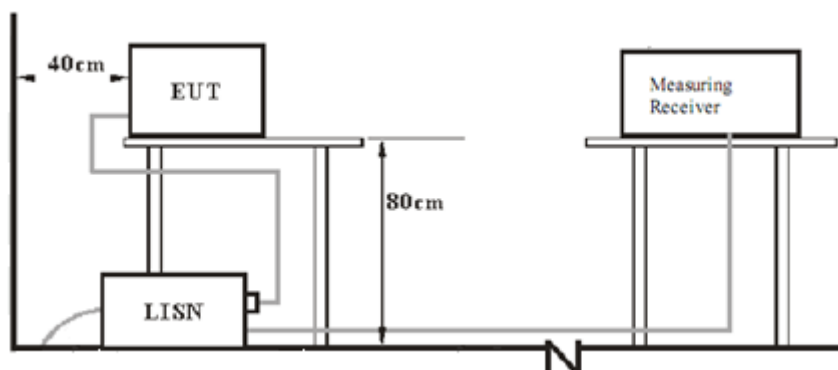

## 8 Systems test configuration

Auxiliary Equipment Used during Test:

DESCRIPTION	MANUFACTURER	MODEL NO.	S/N
---	---	---	---

Test software information:

Test Software Version	FCCassist V1.0.0.2	
Modulation	Setting TX Power	Packet Type
GFSK	Default	/

The system was configured to channel 0, 19, and 39 for the test.

## 9 Technical Requirement

### 9.1 Conducted Emission

#### Test Method

1. The EUT was placed on a table, which is 0.8m above ground plane
2. The power line of the EUT is connected to the AC mains through a Artificial Mains Network (A.M.N.).
3. Maximum procedure was performed to ensure EUT compliance
4. A EMI test receiver is used to test the emissions from both sides of AC line

#### Limit

Frequency MHz	QP Limit dB $\mu$ V	AV Limit dB $\mu$ V
0.150-0.500	66-56*	56-46*
0.500-5	56	46
5-30	60	50

\*Decreases with the logarithm of the frequency.

## Conducted Emission

Product Type : Digital Automatic Blood Pressure Monitor  
 M/N : MD3610B  
 Operating Condition : Normal Working with transmitting  
 Test Specification : Power Line, Live  
 Comment : AC 120V/60Hz (External adapter)

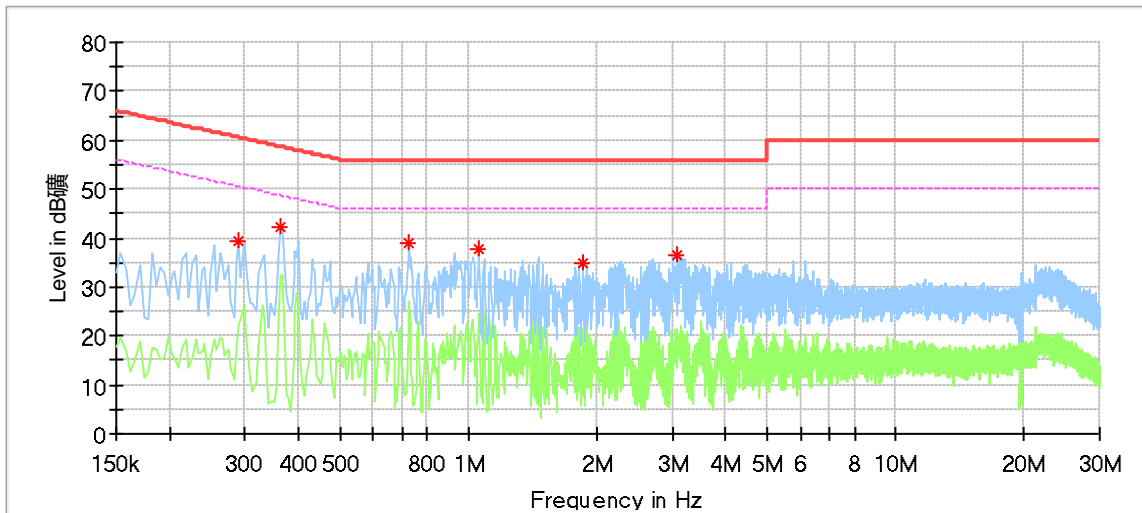

### Critical\_Freqs

Frequency (MHz)	MaxPeak * (dBµV)	Average * (dBµV)	Limit (dBµV)	Margin (dB)	Line	Corr.** (dB)
0.290000	39.41	---	60.52	21.12	L1	9.22
0.362000	42.34	---	58.68	16.35	L1	9.21
0.726000	38.83	---	56.00	17.17	L1	9.20
1.058000	37.83	---	56.00	18.17	L1	9.20
1.854000	34.78	---	56.00	21.22	L1	9.22
3.090000	36.40	---	56.00	19.60	L1	9.25

### Final Result

Frequency (MHz)	QuasiPeak * (dBµV)	Average * (dBµV)	Limit (dBµV)	Margin (dB)	Line	Corr.** (dB)
---	---	---	---	---		---

Remark:

\*Level=Reading Level + Correction Factor

\*\*Correction Factor=Cable Loss + LISN Factor

(The Reading Level is recorded by software which is not shown in the sheet)

## Conducted Emission

Product Type : Digital Automatic Blood Pressure Monitor  
 M/N : MD3610B  
 Operating Condition : Normal Working with transmitting  
 Test Specification : Power Line, Neutral  
 Comment : AC 120V/60Hz (External adapter)

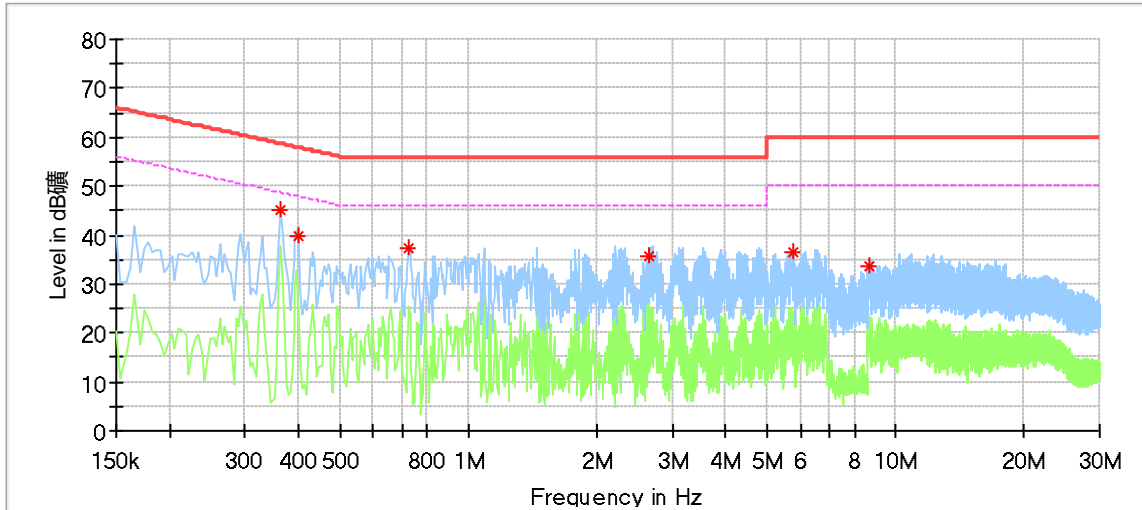

### Critical Freqs

Frequency (MHz)	MaxPeak * (dBµV)	Average * (dBµV)	Limit (dBµV)	Margin (dB)	Line	Corr.** (dB)
0.362000	45.24	---	58.68	13.44	N	9.39
0.402000	39.81	---	57.81	18.00	N	9.38
0.726000	37.38	---	56.00	18.62	N	9.39
2.650000	35.89	---	56.00	20.11	N	9.44
5.742000	36.59	---	60.00	23.41	N	9.52
8.666000	33.84	---	60.00	26.16	N	9.59

### Final Result

Frequency (MHz)	QuasiPeak * (dBµV)	Average * (dBµV)	Limit (dBµV)	Margin (dB)	Line	Corr.** (dB)
---	---	---	---	---		---

Remark:

\*Level=Reading Level + Correction Factor

\*\*Correction Factor=Cable Loss + LISN Factor

(The Reading Level is recorded by software which is not shown in the sheet)

## 9.2 Conducted Peak output power

### Test Method

1. Connect the power meter to the EUT
  - a) The EUT is configured to transmit continuously, or to transmit with a constant duty factor.
  - b) At all times the EUT is transmitting at its maximum power control level.
  - c) The integration period of the power meter exceeds the repetition period of the transmitted signal by at least a factor of five.
2. Measure the average power of the transmitter. This measurement is an average over both the on and off periods of the transmitter.
3. Adjust the measurement in dBm by adding  $10\log(1/x)$ , where x is the duty cycle to the measurement result.

### Limits

According to §15.247 (b) (1), conducted peak output power limit as below:

Frequency Range MHz	Limit W	Limit dBm
2400-2483.5	≤1	≤30

Test result as below table

Frequency MHz	Conducted Peak Output Power dBm	Result
Bottom channel 2402MHz	-0.73	Pass
Middle channel 2440MHz	-1.01	Pass
Top channel 2480MHz	-1.81	Pass

### Test Graphs

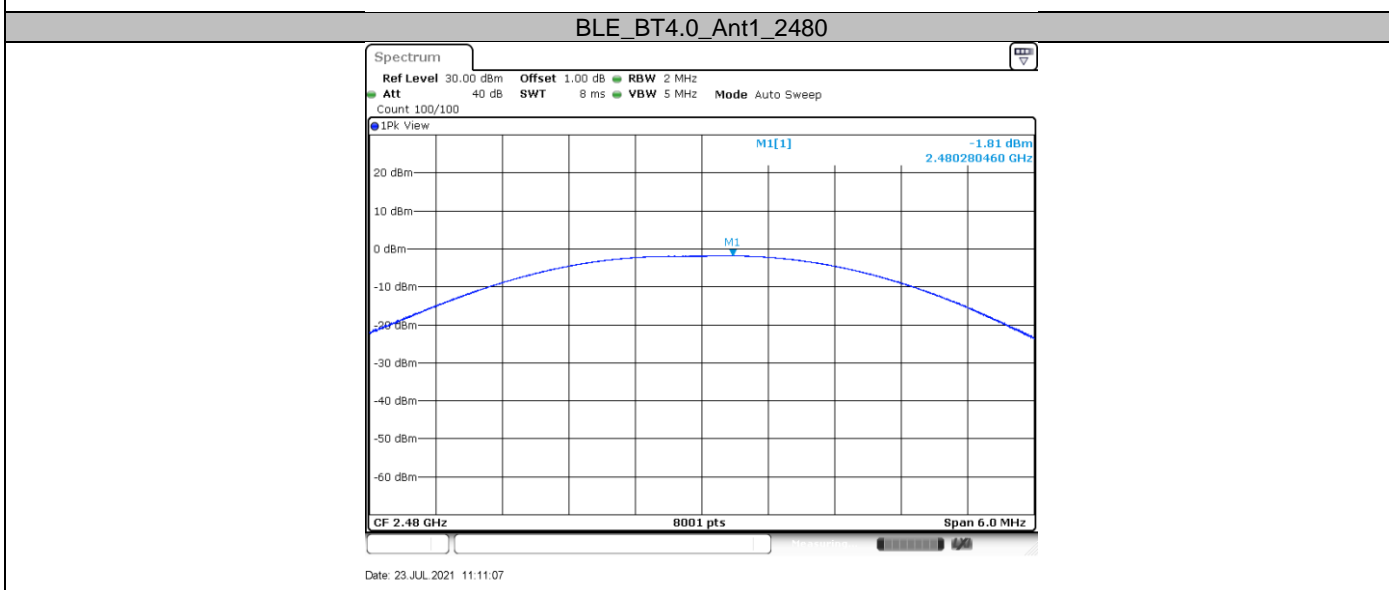
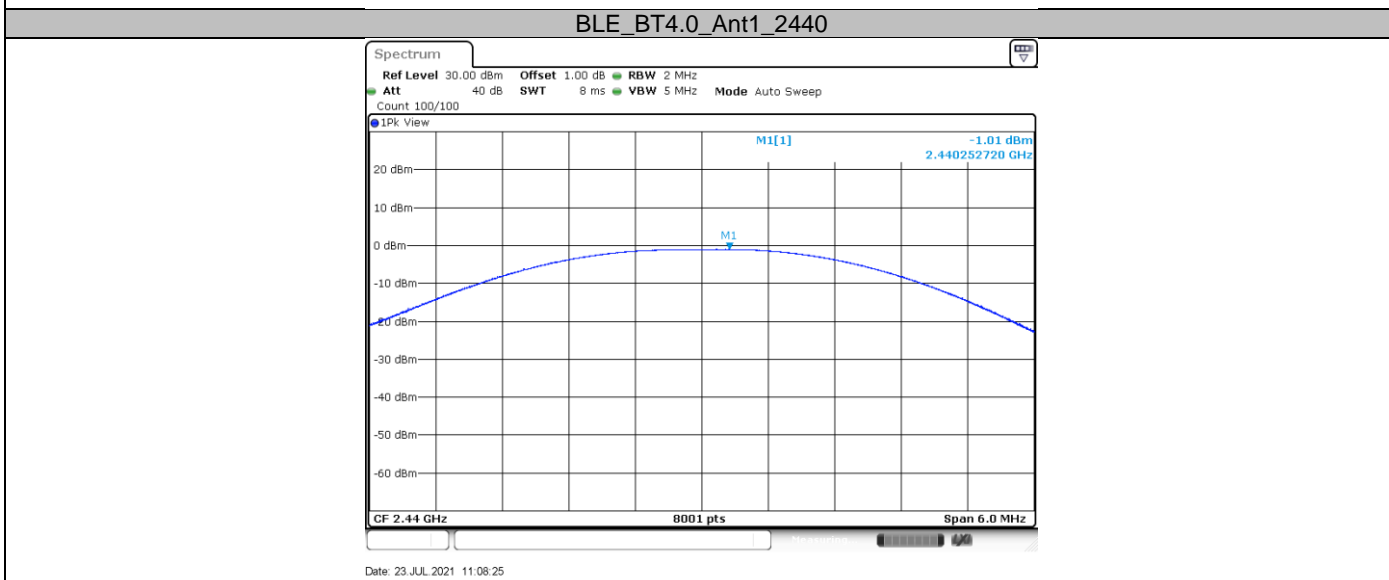
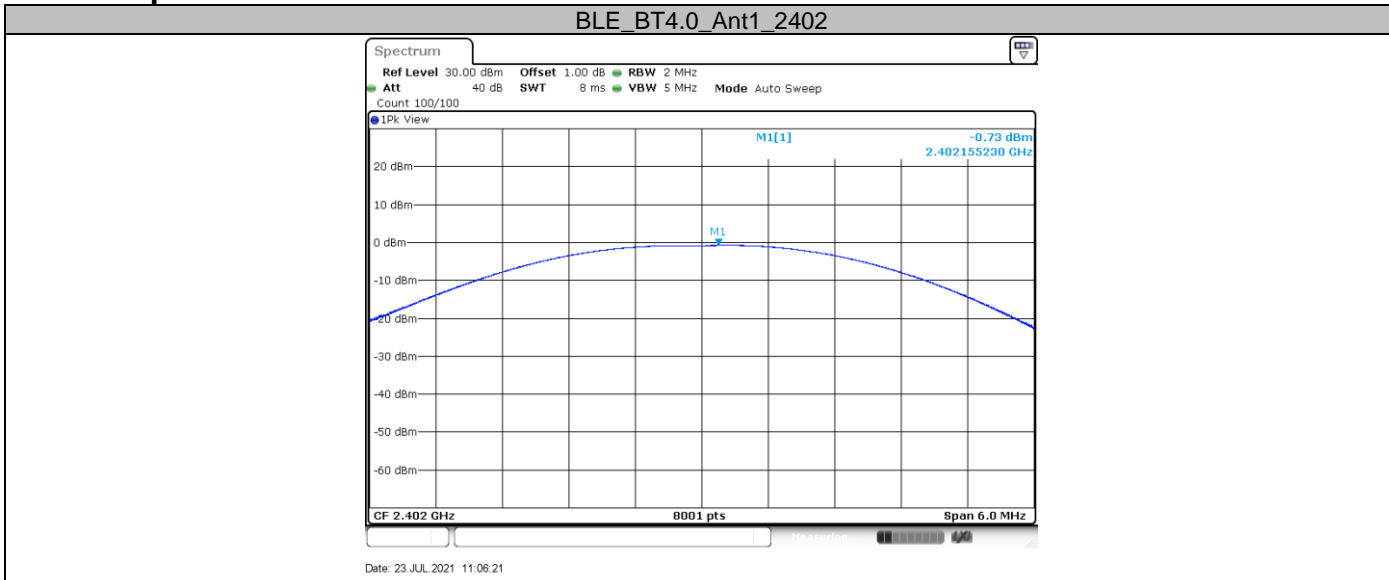

### 9.3 6 dB Bandwidth

#### Test Method

1. Use the following spectrum analyzer settings:  
RBW=100K, VBW≥3RBW, Sweep = auto, Detector function = peak, Trace = max hold
2. Use the automatic bandwidth measurement capability of an instrument, may be employed using the X dB bandwidth mode with X set to 6 dB, care shall be taken so that the bandwidth measurement is not influenced by any intermediate power nulls in the fundamental emission that might be ≥ 6 dB.
3. Allow the trace to stabilize, record the X dB Bandwidth value.

#### Limit

Limit [kHz]

---

≥500

#### Test result

Frequency MHz	6dB bandwidth MHz	Result
Bottom channel 2402MHz	0.680	Pass
Middle channel 2440MHz	0.692	Pass
Top channel 2480MHz	0.684	Pass



### Test Graphs

BLE\_BT4.0\_Ant1\_2402

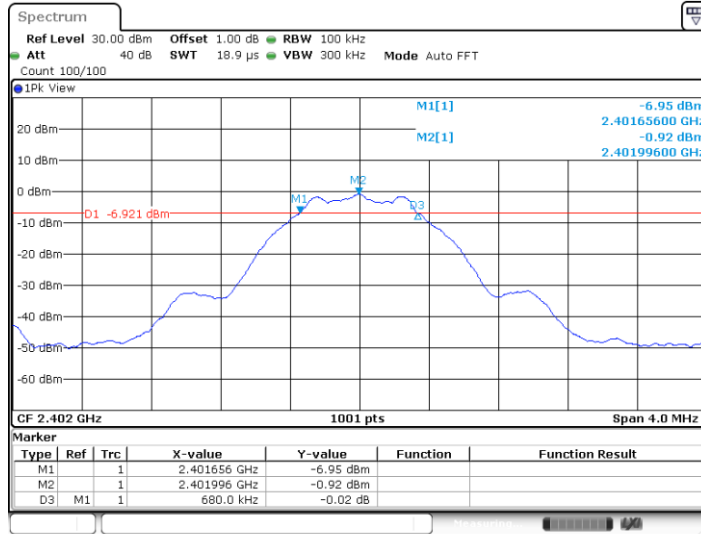

Date: 23.JUL.2021 11:06:04

BLE\_BT4.0\_Ant1\_2440

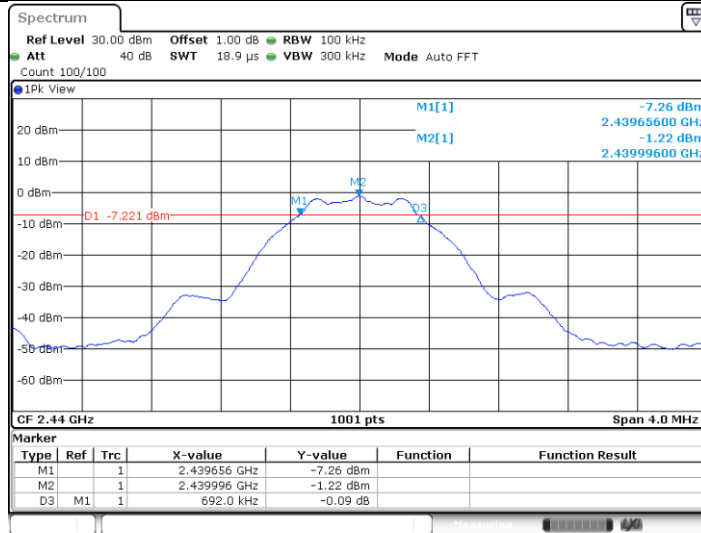

Date: 23.JUL.2021 11:08:08

BLE\_BT4.0\_Ant1\_2480

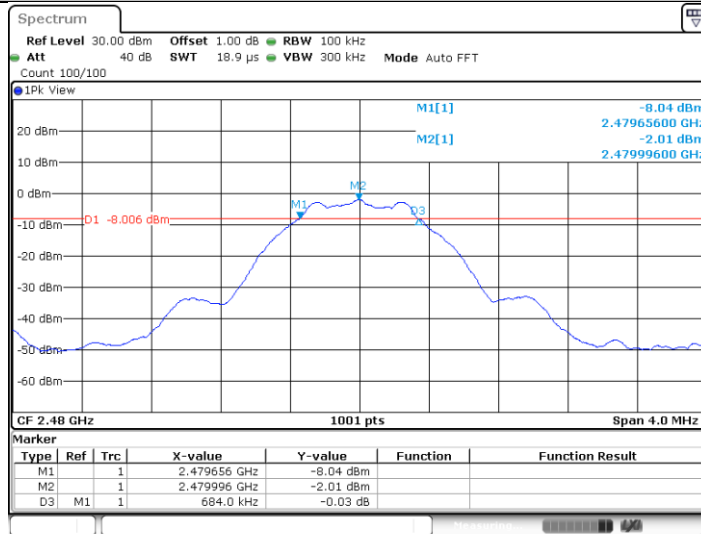

Date: 23.JUL.2021 11:10:50

## 9.4 Power spectral density

### Test Method

This procedure shall be used if maximum peak conducted output power was used to demonstrate compliance:

1. Set analyzer center frequency to DTS channel center frequency. RBW=3kHz, VBW≥3RBW, Span=1.5 times DTS bandwidth, Detector=Peak, Sweep=auto, Trace= max hold.
2. Allow trace to fully stabilize, use the peak marker function to determine the maximum amplitude level within the RBW.
3. Repeat above procedures until other frequencies measured were completed.

### Limit

Limit [dBm/3KHz]

≤8

### Test result

Frequency MHz	Power spectral density dBm/3KHz	Result
Top channel 2402MHz	-13.39	Pass
Middle channel 2440MHz	-13.78	Pass
Bottom channel 2480MHz	-14.36	Pass

### Test Graphs

BLE\_BT4.0\_Ant1\_2402

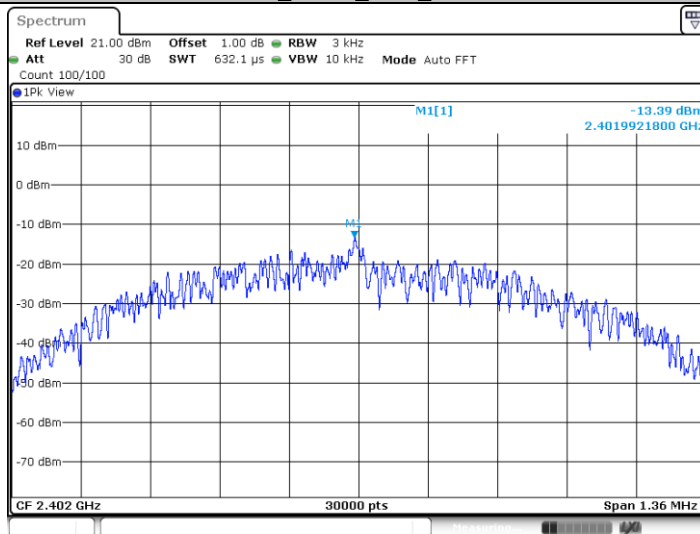

Date: 23.JUL.2021 11:06:27

BLE\_BT4.0\_Ant1\_2440

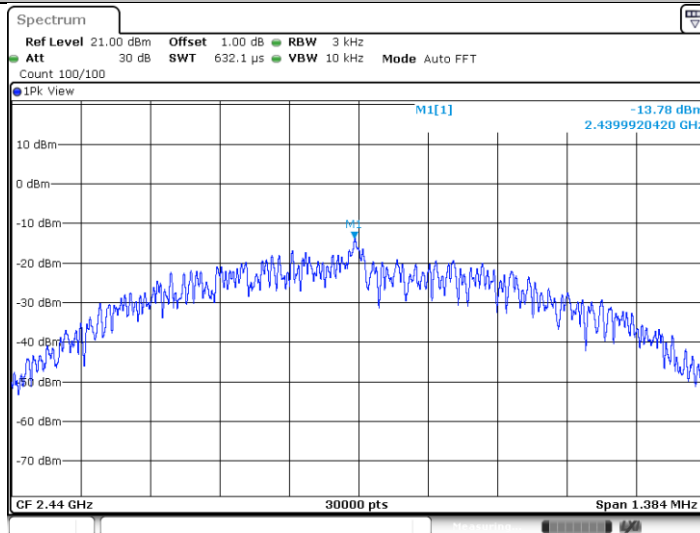

Date: 23.JUL.2021 11:08:31

BLE\_BT4.0\_Ant1\_2480

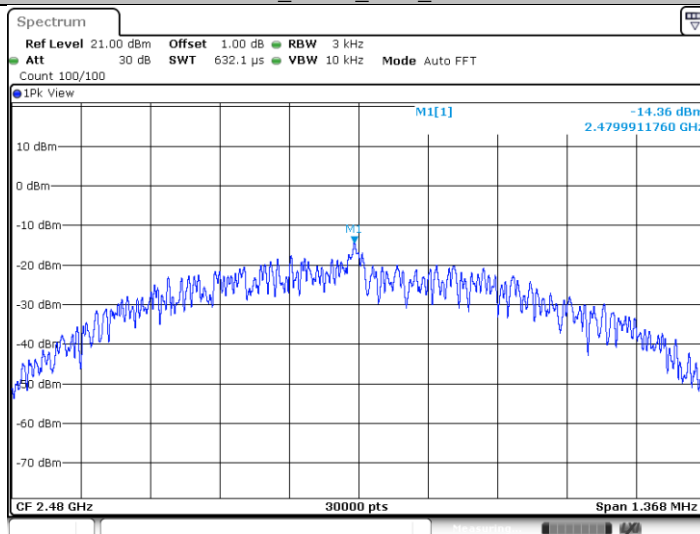

Date: 23.JUL.2021 11:11:13

## 9.5 Spurious RF conducted emissions

### Test Method

1. Establish a reference level by using the following procedure:
  - a. Set RBW=100 kHz. VBW≥3RBW. Detector =peak, Sweep time = auto couple, Trace mode = max hold.
  - b. Allow trace to fully stabilize, use the peak marker function to determine the maximum PSD level.
2. Use the maximum PSD level to establish the reference level.
  - a. Set the center frequency and span to encompass frequency range to be measured.
  - b. Use the peak marker function to determine the maximum amplitude level. Ensure that the amplitude of all unwanted emissions outside of the authorized frequency band (excluding restricted frequency bands) are attenuated by at least the minimum requirements, report the three highest emissions relative to the limit.
3. Repeat above procedures until other frequencies measured were completed.

### Limit

Frequency Range MHz	Limit (dBc)
30-25000	-20

### Test Result:

Test Mode	Antenna	Channel (MHz)	Freq Range (MHz)	Ref Level (dBm)	Result (dBm)	Limit (dBm)	Verdict
BLE	ANT1	2402	30~1000	-0.88	-59.31	-20.88	PASS
BLE	ANT1	2402	1000~26500	-0.88	-31.15	-20.88	PASS
BLE	ANT1	2440	30~1000	-1.28	-62.54	-21.28	PASS
BLE	ANT1	2440	1000~26500	-1.28	-40.13	-21.28	PASS
BLE	ANT1	2480	30~1000	-1.96	-60.95	-21.96	PASS
BLE	ANT1	2480	1000~26500	-1.96	-37.80	-21.96	PASS

### Test Graphs

BLE\_BT4.0\_Ant1\_2402\_0-Reference



Date: 23.JUL.2021 11:06:43

BLE\_BT4.0\_Ant1\_2402\_30~1000

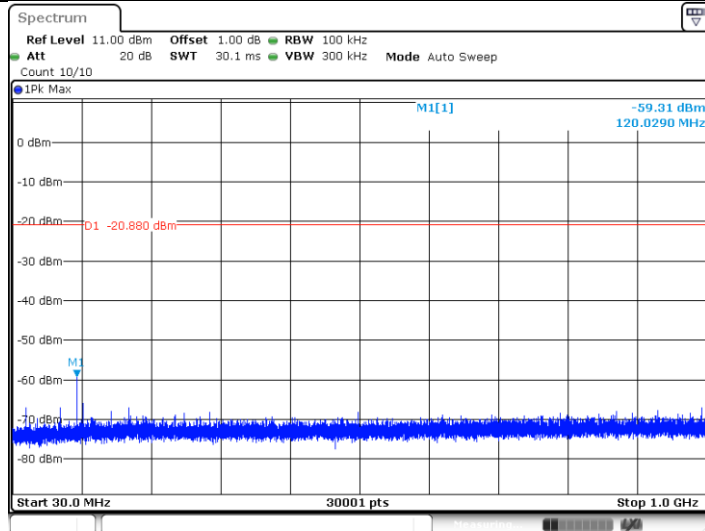

Date: 23.JUL.2021 11:06:49

BLE\_BT4.0\_Ant1\_2402\_1000~26500

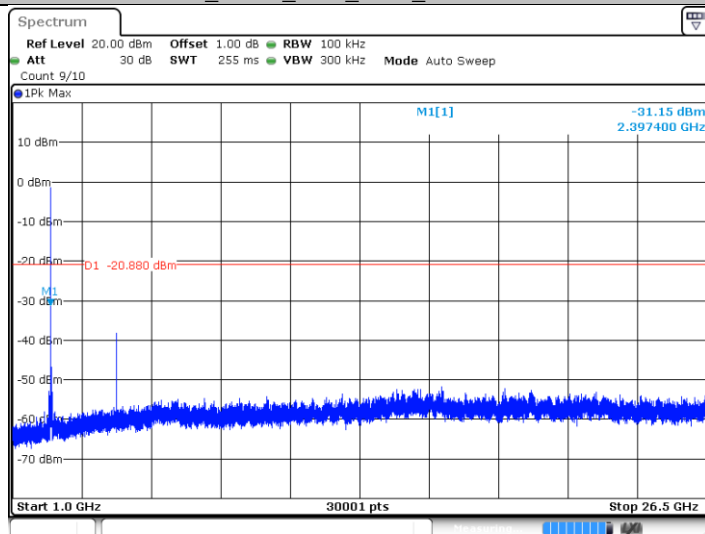

Date: 23.JUL.2021 11:06:57

BLE\_BT4.0\_Ant1\_2440\_0~Reference

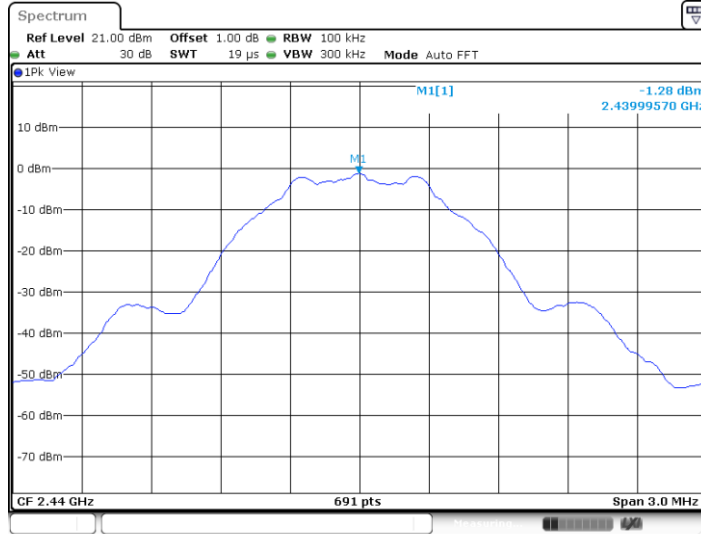

Date: 23 JUL 2021 11:08:36

BLE\_BT4.0\_Ant1\_2440\_30~1000

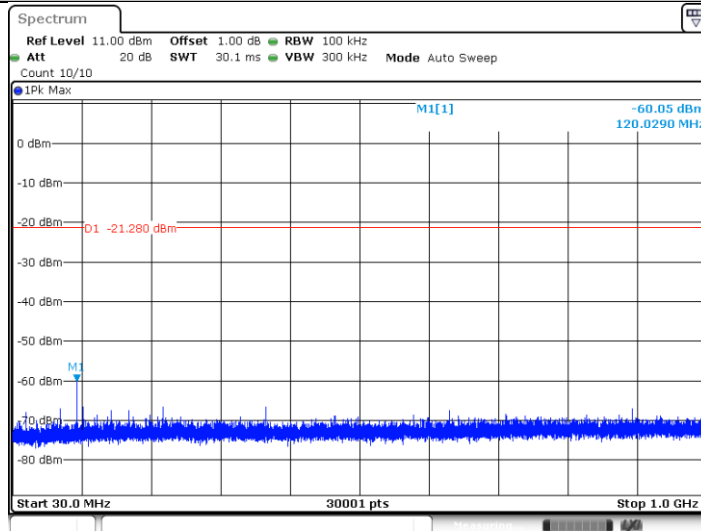

Date: 23 JUL 2021 11:08:43

BLE\_BT4.0\_Ant1\_2440\_1000~26500

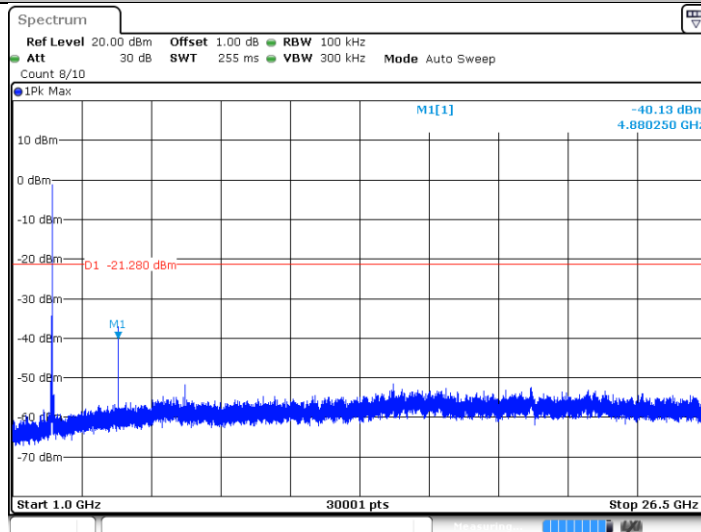

Date: 23 JUL 2021 11:08:50

BLE\_BT4.0\_Ant1\_2480\_0~Reference

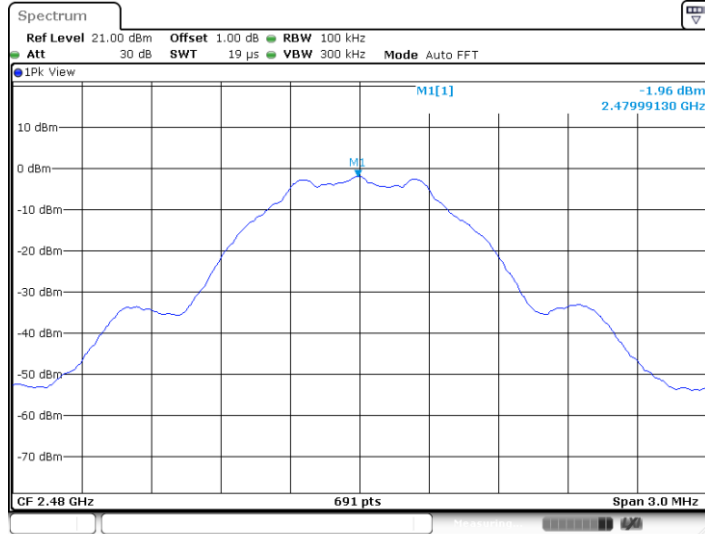

Date: 23 JUL 2021 11:11:28

BLE\_BT4.0\_Ant1\_2480\_30~1000

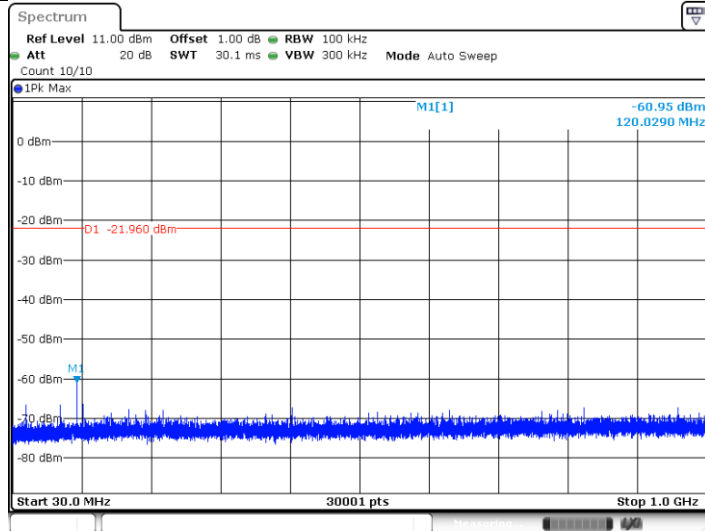

Date: 23 JUL 2021 11:11:34

BLE\_BT4.0\_Ant1\_2480\_1000~26500

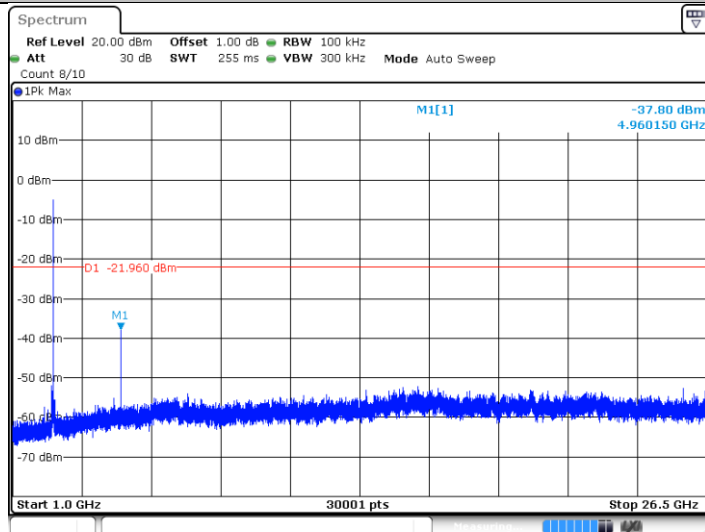

Date: 23 JUL 2021 11:11:42

## 9.6 Band edge

### Test Method

- 1 Use the following spectrum analyzer settings:  
Span = wide enough to capture the peak level of the in-band emission and all spurious  
RBW = 100 kHz, VBW  $\geq$  RBW, Sweep = auto, Detector function = peak, Trace = max hold.
- 2 Allow the trace to stabilize, use the peak and delta measurement to record the result.
- 3 The level displayed must comply with the limit specified in this Section.

### Limit

Frequency Range MHz	Limit (dBc)
30-25000	-20

### Test result

Test Mode	Channel (MHz)	Reference Level(dBm)	Result (dBm)	Limit (dBm)	Verdict
BLE	2402	-0.86	-30.85	-20.86	PASS
BLE	2480	-1.99	-45.83	-21.99	PASS



### Test Graphs

BLE\_BT4.0\_Ant1\_Low\_2402

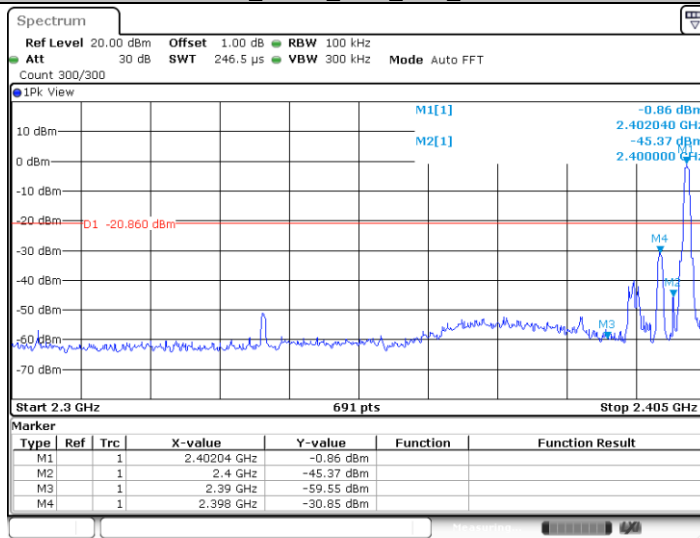

Date: 23.JUL.2021 11:06:36

BLE\_BT4.0\_Ant1\_High\_2480

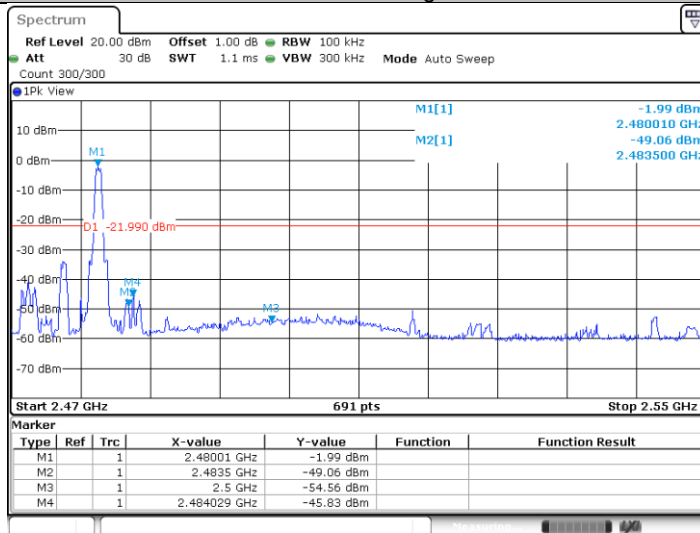

Date: 23.JUL.2021 11:11:22

## 9.7 Spurious radiated emissions for transmitter

### Test Method

- 1: The EUT was placed on a turn table which is 1.5m above ground plane for above 1GHz and 0.8m above ground for below 1GHz at 3 meter chamber room for test. The table was rotated 360 degrees to determine the position of the highest radiation.
- 2: The EUT was set 3 meters away from the interference – receiving antenna, which was mounted on the top of a variable – height antenna tower.
- 3: The height of antenna is varied from one meter to four meters above the ground to determine the maximum value of the field strength. Both horizontal and vertical polarizations of the antenna are set to make the measurement.
- 4: For each suspected emission, the EUT was arranged to its worst case and then the antenna was tuned to heights from 1 meter to 4 meters and the rotatable table was turned from 0 degrees to 360 degrees to find the maximum reading.
- 5: Use the following spectrum analyzer settings According to C63.10:

For Below 1GHz

Use the following spectrum analyzer settings:

Span = wide enough to capture the peak level of the in-band emission and all spurious  
 RBW = 100 KHz to 120KHz, VBW ≥ RBW for peak measurement, Sweep = auto, Detector function = peak, Trace = max hold.

For Peak unwanted emissions Above 1GHz:

Span = wide enough to capture the peak level of the in-band emission and all spurious  
 RBW = 1MHz, VBW ≥ RBW for peak measurement, Sweep = auto, Detector function = peak, Trace = max hold.

Procedures for average unwanted emissions measurements above 1000 MHz

a) RBW = 1MHz.

b) VBW \ [3 × RBW].

c) Detector = RMS (power averaging), if [span / (# of points in sweep)] \ RBW / 2.

Satisfying this condition can require increasing the number of points in the sweep or reducing the span. If the condition is not satisfied, then the detector mode shall be set to peak.

d) Averaging type = power (i.e., rms) (As an alternative, the detector and averaging type may be set for linear voltage averaging. Some instruments require linear display mode to use linear voltage averaging. Log or dB averaging shall not be used.)

e) Sweep time = auto.

f) Perform a trace average of at least 100 traces if the transmission is continuous. If the transmission is not continuous, then the number of traces shall be increased by a factor of 1 / D, where D is the duty cycle. For example, with 50% duty cycle, at least 200 traces shall be averaged. (If a specific emission is demonstrated to be continuous—i.e., 100% duty cycle—then rather than turning ON and OFF with the transmit cycle, at least 100 traces shall be averaged.)

g) If tests are performed with the EUT transmitting at a duty cycle less than 98%, then a correction factor shall be added to the measurement results prior to comparing with the emission limit, to compute the emission level that would have been measured had the test been performed at 100% duty cycle. The correction factor is computed as follows:

1) If power averaging (rms) mode was used in the preceding step e), then the correction factor is  $[10 \log (1 / D)]$ , where D is the duty cycle. For example, if the transmit duty cycle was 50%, then 3 dB shall be added to the measured emission levels.

- 2) If linear voltage averaging mode was used in the preceding step e), then the correction factor is  $[20 \log (1 / D)]$ , where D is the duty cycle. For example, if the transmit duty cycle was 50%, then 6 dB shall be added to the measured emission levels.
- 3) If a specific emission is demonstrated to be continuous (100% duty cycle) rather than turning ON and OFF with the transmit cycle, then no duty cycle correction is required for that emission.

## Limit

The radio emission outside the operating frequency band shall be at least 20 dB below that in the 100 kHz bandwidth within the band that contains the highest level of the desired power. Radiated emissions which fall in the restricted bands, as defined in section 15.205, must comply with the radiated emission limits specified in section 15.209.

Frequency MHz	Field Strength uV/m	Field Strength dBµV/m	Detector
30-88	100	40	QP
88-216	150	43.5	QP
216-960	200	46	QP
960-1000	500	54	QP
Above 1000	500	54	AV
Above 1000	5000	74	PK

According to C63.10, if the peak (or quasi-peak) measured value complies with the average limit, it is unnecessary to perform an average measurement, so AV emission value did not show in below table if the peak value complies with average limit.

**Spurious radiated emissions for transmitter**

**Transmitting spurious emission test result as below:**

Below 1G:

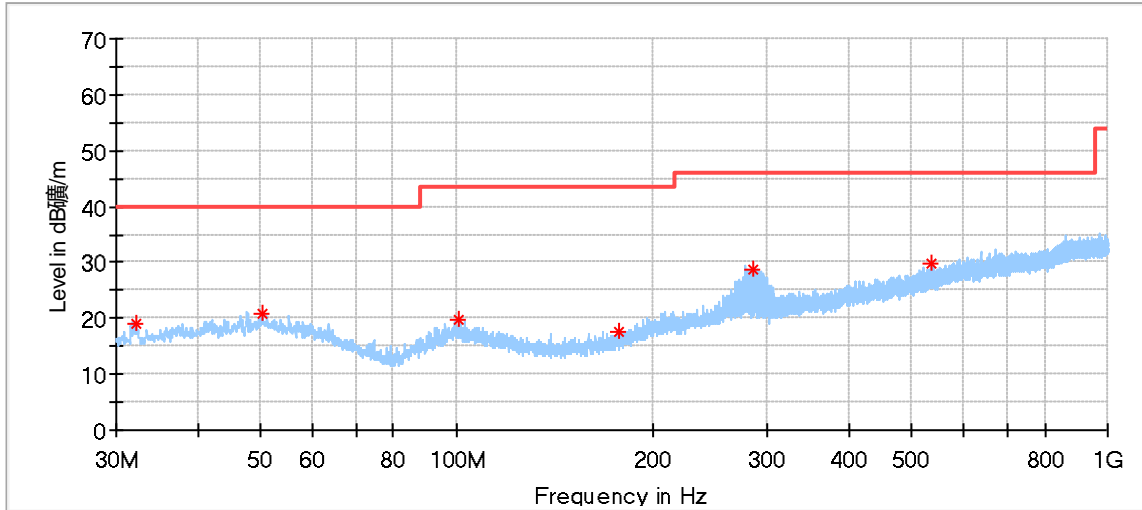

**Critical Freqs**

Frequency (MHz)	MaxPeak (dBµV/m)	Limit (dBµV/m)	Margin (dB)	Height (cm)	Pol	Azimuth (deg)	Corr. (dB/m)
32.209444	19.15	40.00	20.85	100.0	H	280.0	11.71
50.316111	20.93	40.00	19.07	200.0	H	331.0	14.78
100.702222	19.83	43.50	23.67	100.0	H	0.0	12.94
176.955000	17.73	43.50	25.77	200.0	H	129.0	10.74
285.433333	28.88	46.00	17.12	200.0	H	156.0	14.89
535.208333	29.75	46.00	16.25	100.0	H	163.0	20.54

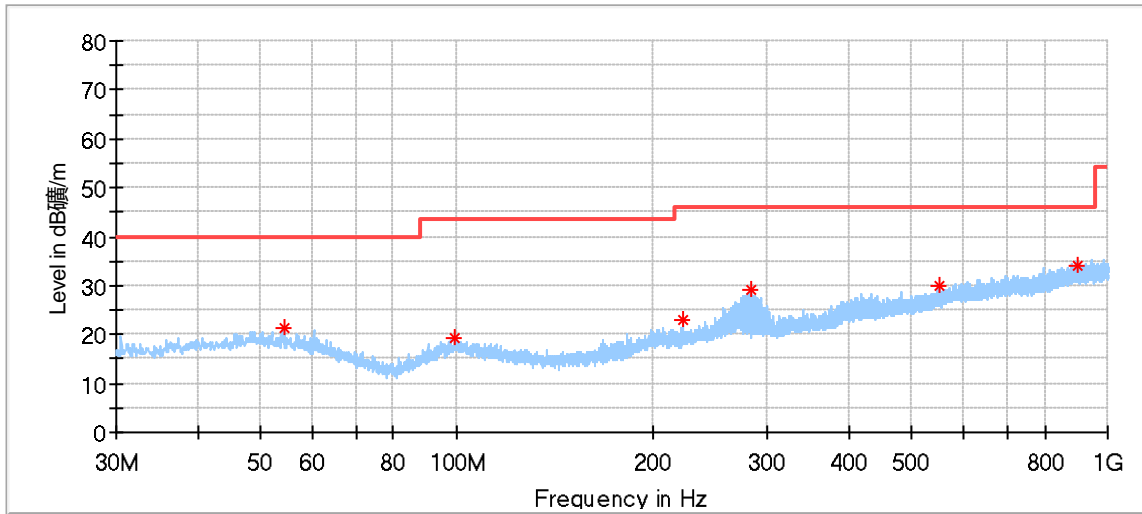

### Critical\_Freqs

Frequency (MHz)	MaxPeak (dBµV/m)	Limit (dBµV/m)	Margin (dB)	Height (cm)	Pol	Azimuth (deg)	Corr. (dB/m)
54.303889	21.34	40.00	18.66	200.0	V	241.0	14.25
99.624444	19.32	43.50	24.18	200.0	V	25.0	12.95
222.329444	22.88	46.00	23.12	100.0	V	222.0	13.07
284.193889	29.13	46.00	16.87	100.0	V	61.0	14.86
552.776111	30.13	46.00	15.87	100.0	V	122.0	20.93
901.455000	34.25	46.00	11.75	100.0	V	359.0	25.83

Low channel 2402MHz Test Result

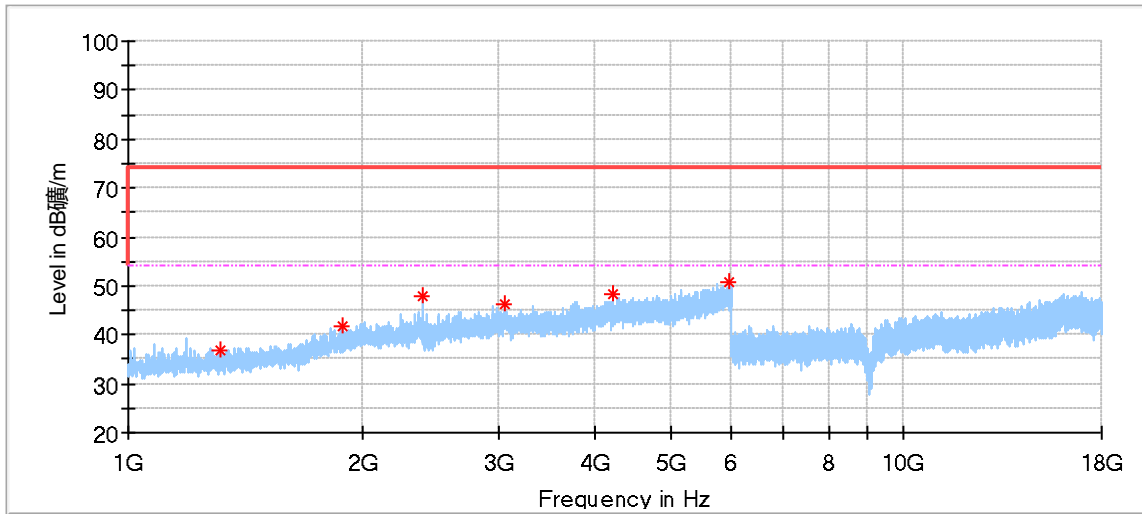

Critical\_Freqs

Frequency (MHz)	MaxPeak (dBµV/m)	Limit (dBµV/m)	Margin (dB)	Height (cm)	Pol	Azimuth (deg)	Corr. (dB/m)
1312.500000	36.91	74.00	37.09	150.0	H	237.0	-8.53
1886.500000	41.77	74.00	32.23	150.0	H	67.0	-4.28
2394.000000	47.98	74.00	26.02	150.0	H	67.0	-2.05
3066.000000	46.42	74.00	27.58	150.0	H	237.0	0.16
4228.500000	48.13	74.00	25.87	150.0	H	273.0	2.88
5947.000000	50.58	74.00	23.42	150.0	H	148.0	6.69

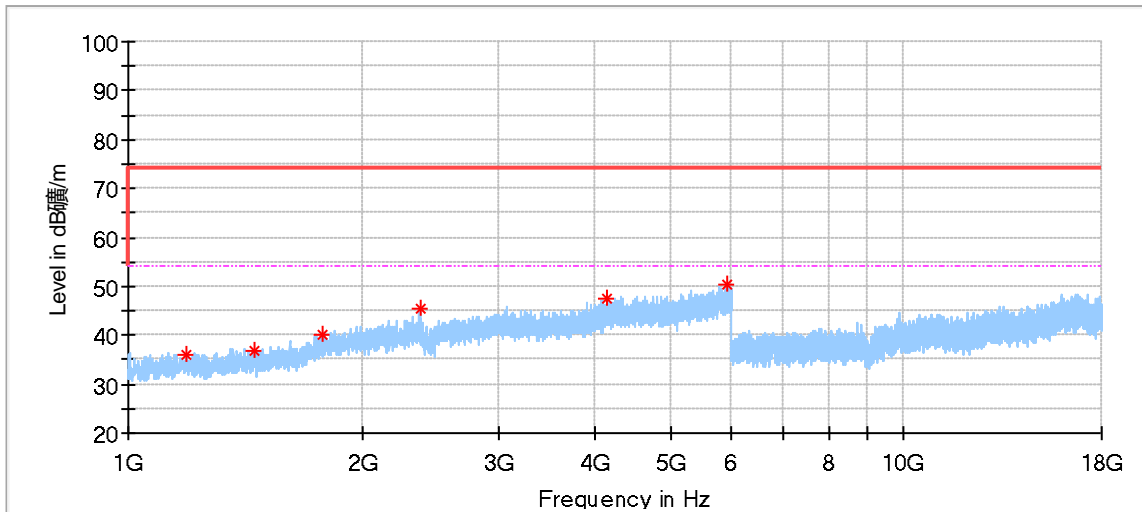

Critical\_Freqs

Frequency (MHz)	MaxPeak (dBµV/m)	Limit (dBµV/m)	Margin (dB)	Height (cm)	Pol	Azimuth (deg)	Corr. (dB/m)
1190.500000	35.99	74.00	38.01	150.0	V	54.0	-9.15
1452.500000	36.70	74.00	37.30	150.0	V	9.0	-7.92
1784.000000	40.22	74.00	33.78	150.0	V	201.0	-5.08
2376.000000	45.51	74.00	28.49	150.0	V	185.0	-2.12
4145.500000	47.56	74.00	26.44	150.0	V	9.0	2.75
5915.000000	50.28	74.00	23.72	150.0	V	9.0	6.73

Middle channel 2440MHz Test Result

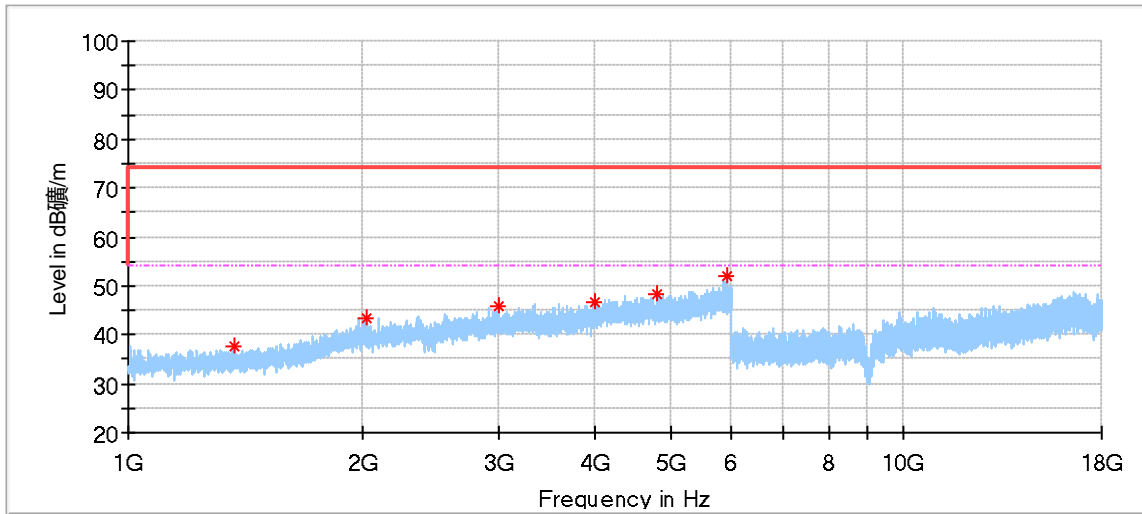

Critical\_Freqs

Frequency (MHz)	MaxPeak (dBµV/m)	Limit (dBµV/m)	Margin (dB)	Height (cm)	Pol	Azimuth (deg)	Corr. (dB/m)
1367.000000	37.74	74.00	36.26	150.0	H	358.0	-8.32
2035.000000	43.42	74.00	30.58	150.0	H	94.0	-3.20
3009.000000	45.85	74.00	28.15	150.0	H	23.0	0.07
3988.000000	46.76	74.00	27.24	150.0	H	335.0	2.02
4807.000000	48.31	74.00	25.69	150.0	H	326.0	3.79
5926.000000	52.15	74.00	21.85	150.0	H	175.0	6.70

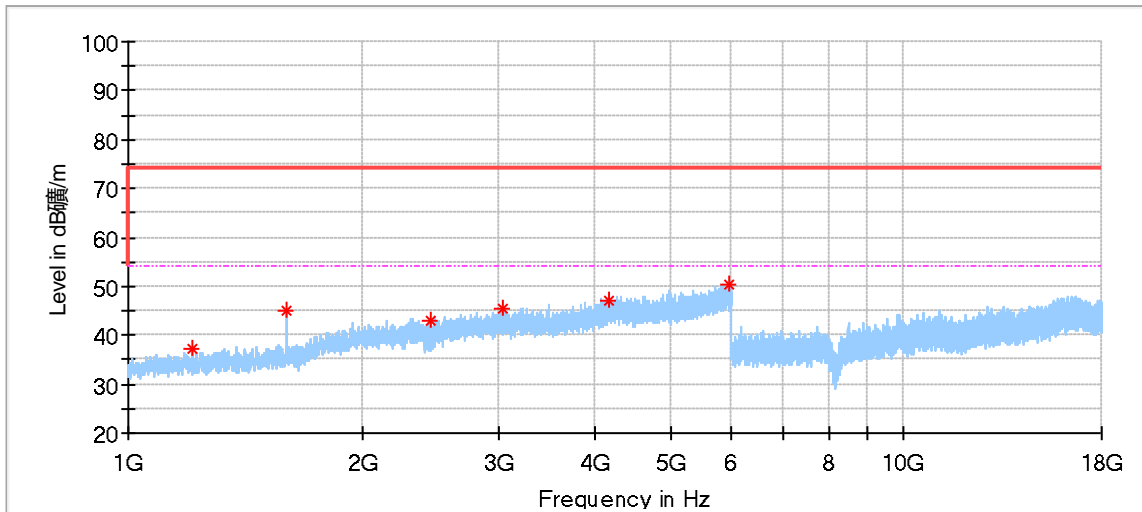

Critical\_Freqs

Frequency (MHz)	MaxPeak (dBµV/m)	Limit (dBµV/m)	Margin (dB)	Height (cm)	Pol	Azimuth (deg)	Corr. (dB/m)
1208.000000	37.22	74.00	36.78	150.0	V	210.0	-9.12
1597.000000	45.04	74.00	28.96	150.0	V	15.0	-6.67
2461.500000	42.80	74.00	31.20	150.0	V	179.0	-1.81
3035.500000	45.29	74.00	28.71	150.0	V	77.0	0.14
4159.500000	46.94	74.00	27.06	150.0	V	171.0	2.79
5966.500000	50.33	74.00	23.67	150.0	V	4.0	6.74

### High channel 2480MHz Test Result

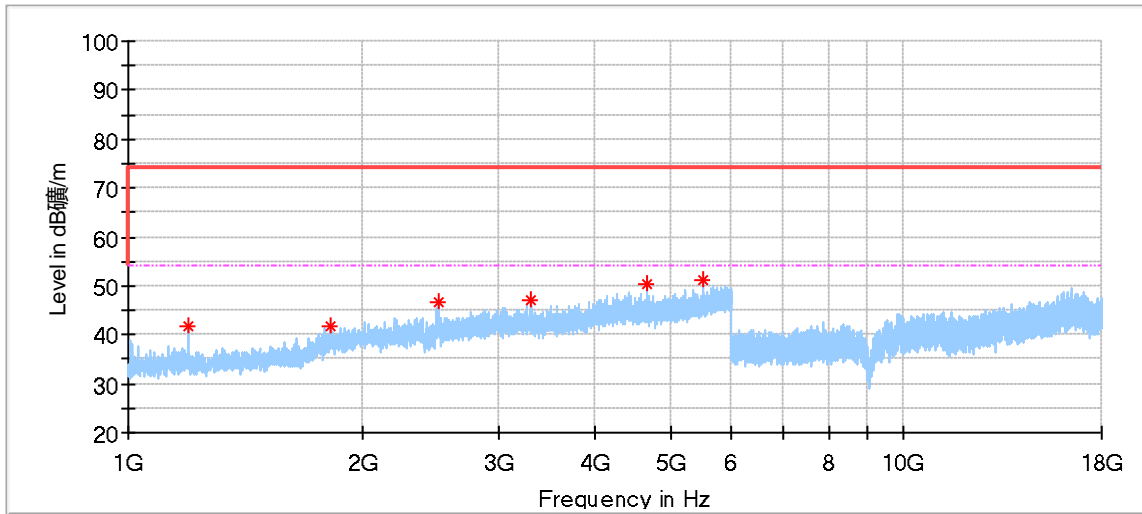

#### Critical\_Freqs

Frequency (MHz)	MaxPeak (dBµV/m)	Limit (dBµV/m)	Margin (dB)	Height (cm)	Pol	Azimuth (deg)	Corr. (dB/m)
1192.500000	41.61	74.00	32.39	150.0	H	9.0	-9.18
1826.500000	41.94	74.00	32.06	150.0	H	291.0	-4.65
2512.500000	46.51	74.00	27.49	150.0	H	291.0	-1.73
3314.500000	47.26	74.00	26.74	150.0	H	291.0	0.41
4673.500000	50.47	74.00	23.53	150.0	H	308.0	3.71
5498.500000	51.28	74.00	22.72	150.0	H	175.0	5.68



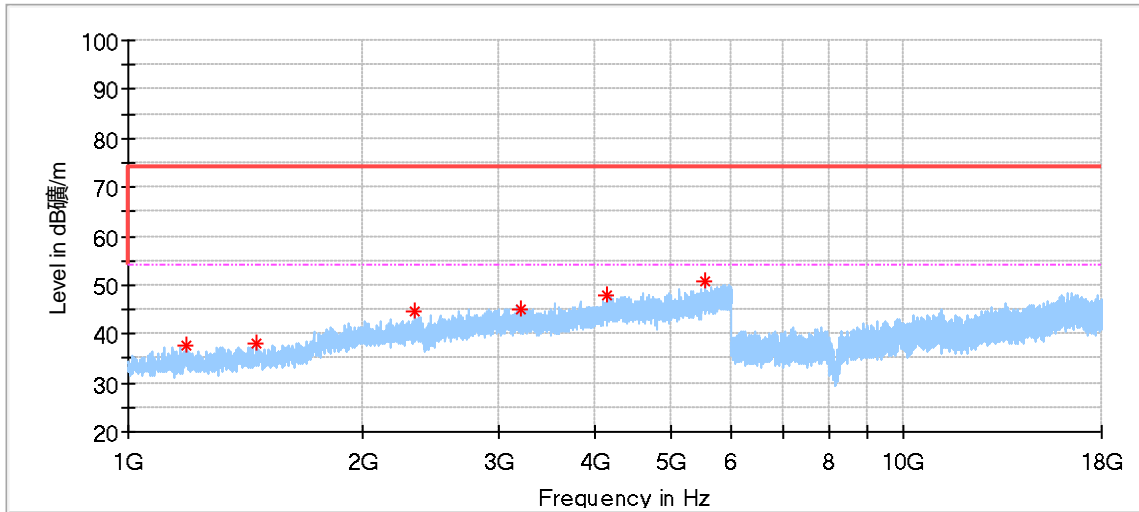

### Critical\_Freqs

Frequency (MHz)	MaxPeak (dBµV/m)	Limit (dBµV/m)	Margin (dB)	Height (cm)	Pol	Azimuth (deg)	Corr. (dB/m)
1186.500000	37.54	74.00	36.46	150.0	V	359.0	-9.10
1459.500000	38.22	74.00	35.78	150.0	V	226.0	-7.91
2345.500000	44.59	74.00	29.41	150.0	V	38.0	-2.16
3199.500000	45.09	74.00	28.91	150.0	V	0.0	0.15
4144.000000	48.06	74.00	25.94	150.0	V	306.0	2.75
5538.000000	50.64	74.00	23.36	150.0	V	0.0	5.62

Remark:

- (1) Data of measurement within frequency range 18-26GHz are the noise floor or attenuated more than 20dB below the permissible limits or the field strength is too small to be measured, so test data does not present in this report;
- (2) Level=Reading Level + Correction Factor  
 Above 1GHz: Corrector factor = Antenna Factor + Cable Loss- Amplifier Gain  
 Below 1GHz: Corrector factor = Antenna Factor + Cable Loss  
 (The Reading Level is recorded by software which is not shown in the sheet)

## 10 Test Equipment List

### Radiated Emission 1# Test (For 30-1000MHz)

DESCRIPTION	MANUFACTURER	MODEL NO.	EQUIPMENT ID	SERIAL NO.	CAL INTERVAL (YEAR)	CAL. DUE DATE
EMI Test Receiver	Rohde & Schwarz	ESR 7	68-4-74-19-001	102176	1	2022-6-4
Trilog Super Broadband Test Antenna	Schwarzbeck	VULB 9163	68-4-80-14-002	707	1	2022-7-23
Horn Antenna	Rohde & Schwarz	HF907	68-4-80-14-005	102294	1	2022-6-23
Loop Antenna	Rohde & Schwarz	HFH2-Z2	68-4-80-14-006	100398	1	2022-8-25
Pre-amplifier	Rohde & Schwarz	SCU 18	68-4-29-14-001	102230	1	2022-6-6
Attenuator	Agilent	8491A	68-4-81-16-001	MY39264334	1	2022-8-23
3m Semi-anechoic chamber	TDK	SAC-3 #1	68-4-90-14-001	----	2	2023-5-28
Test software	Rohde & Schwarz	EMC32	68-4-90-14-001-A10	Version10.35.0 2	N/A	N/A

### Radiated Emission 2# Test (For 1000-25000MHz)

DESCRIPTION	MANUFACTURER	MODEL NO.	EQUIPMENT ID	SERIAL NO.	CAL INTERVAL (YEAR)	CAL. DUE DATE
EMI Test Receiver	Rohde & Schwarz	ESR 26	68-4-74-14-002	101269	1	2022-6-4
Trilog Super Broadband Test Antenna	Schwarzbeck	VULB 9162	68-4-80-19-003	284	1	2022-2-2
Wave Guide Antenna	ETS	3117	68-4-80-19-001	00218954	1	2022-5-24
Pre-amplifier	Rohde & Schwarz	SCU 18F	68-4-29-19-001	100745	1	2022-10-10
Pre-amplifier	Rohde & Schwarz	SCU 08F2	68-4-29-19-004	08400018	1	2022-10-10
Sideband Horn Antenna	Q-PAR	QWH-SL-18-40-K-SG	68-4-80-14-008	12827	1	2022-7-21
Pre-amplifier	Rohde & Schwarz	SCU 40A	68-4-29-14-002	100432	1	2022-7-27
3m Semi-anechoic chamber	TDK	SAC-3 #2	68-4-90-19-006	----	2	2022-8-23
Test software	Rohde & Schwarz	EMC32	68-4-90-19-006-A01	Version10.35. 02	N/A	2023-5-28

### RF Conducted Test

DESCRIPTION	MANUFACTURER	MODEL NO.	EQUIPMENT ID	SERIAL NO.	CAL INTERVAL (YEAR)	CAL. DUE DATE
Signal Analyzer	Rohde & Schwarz	FSV40	68-4-74-14-004	101030	1	2022-6-3
Test software	Tonscend	System for BT/WIFI	68-4-74-14-006-A13	Version 2.5.77.0418	N/A	N/A

**Conducted Emission 2# Test**

DESCRIPTION	MANUFACTURER	MODEL NO.	EQUIPMENT ID	SERIAL NO.	CAL INTERVAL (YEAR)	CAL. DUE DATE
EMI Test Receiver	Rohde & Schwarz	ESR 3	68-4-74-19-002	102590	1	2022-6-4
LISN	Rohde & Schwarz	ENV216	68-4-87-19-001	102472	1	2022-6-5
ISN	Rohde & Schwarz	ENY81	68-4-87-14-003	100177	1	2022-6-5
ISN	Rohde & Schwarz	ENY81-CA6	68-4-87-14-004	101664	1	2022-6-5
High Voltage Probe	Schwarzbeck	TK9420(VT9420)	68-4-27-14-001	9420-584	1	2022-6-5
RF Current Probe	Rohde & Schwarz	EZ-17	68-4-27-14-002	100816	1	2022-6-5
Attenuator	Shanghai Huaxiang	TS2-26-3	68-4-81-16-003	080928189	1	2022-6-3
Test software	Rohde & Schwarz	EMC32	68-4-90-19-005-A01	Version10.35.02	N/A	N/A
Shielding Room	TDK	CSR #2	68-4-90-19-005	----	3	2022-11-07

## 11 System Measurement Uncertainty

For a 95% confidence level, the measurement expanded uncertainties for defined systems, in accordance with the recommendations of ISO 17025 were:

System Measurement Uncertainty	
Test Items	Extended Uncertainty
Uncertainty for Conducted Emission in new shielding room 150kHz-30MHz (for test using AMN ENV216)	3.31dB
Uncertainty for Radiated Spurious Emission 25MHz-3000MHz	Horizontal: 4.28dB; Vertical: 4.36dB;
Uncertainty for Radiated Spurious Emission 3000MHz-18000MHz	Horizontal: 4.26dB; Vertical: 4.25dB;
Uncertainty for Radiated Spurious Emission 18000MHz-40000MHz	Horizontal: 4.51dB; Vertical: 4.50dB;
Uncertainty for Conducted RF test with TS 8997	RF Power Conducted: 1.27dB Frequency test involved: 0.6×10 <sup>-7</sup> or 1%
Uncertainty Evaluation for Power Spectral Density Conducted measurement	1.17dB
Uncertainty Evaluation for Spurious emissions Conducted measurement	1.43dB
Uncertainty Evaluation for Humidity	0.934%
Uncertainty Evaluation for Temperature	0.195 °C

### Measurement Uncertainty Decision Rule

Determination of conformity with the specification limits is based on the decision rule according to IEC Guide 115: 2021, clause 4.4.3 and 4.5.1.

THE END