



User Manual

Applies to XIRIUM PRO CANADA, AUSTRALIA, and
NEW ZEALAND devices

XIRIUM

PRO

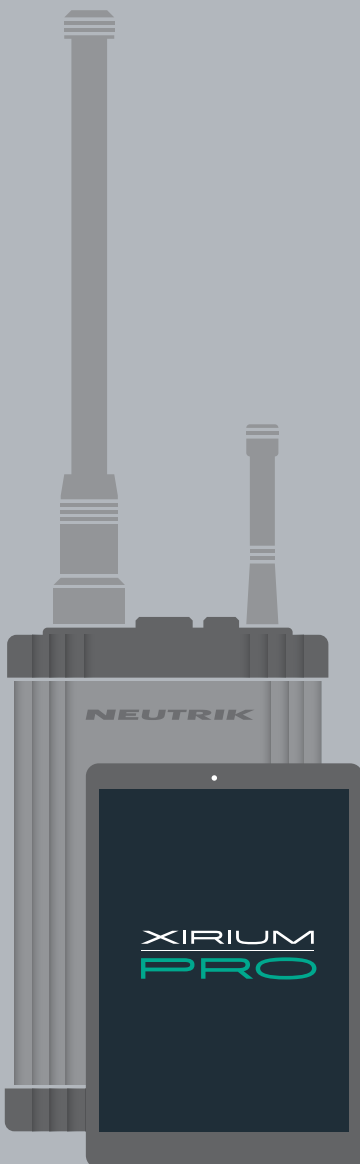

NEUTRIK®

Imprint

Subject to change due to technical advances! This user manual corresponds to the level of technology at the time the product was delivered and not the current stage of development at Neutrik.

If any pages or sections of this user manual are missing, please contact the manufacturer at the address listed below.

Copyright

This user manual is protected by copyright. The user manual must not be duplicated, reproduced, microfilmed or translated, or converted to be saved and processed in EDP systems, neither as excerpts nor in full, without the express written authorization of Neutrik.

Copyright by: © Neutrik® AG

Document identification

Document No: BDA 470

Version: 2017/03

 ► **This user manual applies to firmware 3.0 and app version 3.0!**

Language: English

Original language: German

Each user manual in a different language is a translation of the operating manual in German.

Manufacturer

Neutrik® AG

Im alten Riet 143

9494 Schaan

Liechtenstein

T: +423 2372424

F: +423 2325393

E: neutrik@neutrik.com

www.neutrik.com



Table of contents

1 About this document	4	5 Operation	32
1.1 Significance of the user manual	4	5.1 Setting devices into operation	32
1.2 Designation	4	5.2 Setting up the transmission path	33
1.3 Explanation of symbols	5	5.3 Installing and starting the app	34
1.3.1 Symbols in illustrations	5	5.4 Connecting devices with the app	34
1.4 Target group	5	5.4.1 Connecting devices in stand-alone mode	34
2 Safety	6	5.4.2 Connecting devices in network mode	35
2.1 Warning information and signal words	6	5.5 Arranging the radio transmission path	38
2.2 Warning symbols	6	5.6 Configuring the device parameters	39
2.3 Important regulatory notes	7	5.7 Editing system settings	43
2.3.1 Radio frequency radiation exposure informa- tion	8	5.7.1 System reset	43
2.4 Important safety instructions	8	5.7.2 Advanced Mode	43
2.5 Proper use	10	5.8 Setting up and mounting the XIRIUM PRO system ..	44
2.6 Foreseeable improper use	10	5.8.1 Positioning the devices	44
3 Components and accessories	11	5.8.2 Positioning the repeater	45
3.1 XIRIUM PRO components	11	5.8.3 Systems with several transmitters	45
4 Description of product	13	5.8.4 Fastening and securing XIRIUM PRO devices ..	46
4.1 XIRIUM PRO base station	13	5.9 Upgrading firmware	47
4.2 Modules	14	5.9.1 Installing the XIRIUM PRO Firmware Upgrade Manager	47
4.2.1 TX modules	14	5.9.2 Executing a firmware upgrading	48
4.2.2 RX modules	14	5.9.3 Uninstalling the XIRIUM PRO Firmware Upgrade Manager	50
4.3 XIRIUM PRO app	15	6 Troubleshooting	51
4.3.1 Overview of operation elements	15	7 After operation	52
4.3.2 Links/Overview page	17	7.1 Dismounting devices	52
4.3.3 Edit page	18	7.2 Transporting	52
4.3.4 Settings page	21	7.3 Storage	52
4.3.5 Help page	22	7.4 Cleaning and care	52
4.4 Getting started	23	7.5 Maintenance and repair	52
4.4.1 App	24	7.6 Disposal	53
4.4.2 Repeater	24	8 Appendix	54
4.4.3 Signal quality bar	24	8.1 Integrating DANTE	54
4.4.4 Transmission power	25	8.1.1 Introduction to DANTE™	54
4.4.5 XROC mode	26	8.1.2 Enabling a DANTE™ link	54
4.4.6 Antennas	26	8.2 Access point settings	55
4.4.7 Line-of-sight and redundant RF path	28	8.2.1 Recommended settings	55
4.4.8 Antenna height + distance	28	8.2.2 XIRIUM PRO basic kit with access point	55
4.4.9 Line-of-sight and redundant RF path	30	8.3 Technical specifications	56
4.5 Selecting transmission channels	31		
4.5.1 Automatic selection of transmission channels ...	31		
4.5.2 Manual selection of transmission channels	31		



1 About this document

This user manual provides an overview of the necessary operation steps and settings of the product.

1.1 Significance of the user manual

i This user manual is an integral component of the product and part of the product's safety concept.

- ▶ Make sure that all persons who work with the product have fully read and also understood this user manual.
- ▶ Observe all instructions exactly, especially the safety instructions.

i This user manual contains important information for operating and maintaining the product and troubleshooting minor problems safely and properly on your own.

- ▶ Keep this user manual in the immediate vicinity of the product so personnel have access to it at all times.

- ▶ Pass this user manual on to every user, e.g., by lending it, or to the future owner of the product.
- ▶ If this user manual is lost or damaged, a copy of the operating manual can be downloaded from the Neutrik's home page (www.neutrik.com).

1.2 Designation

Designation	Explanation
XIRIUM PRO System	All components: XIRIUM PRO base stations, XIRIUM PRO modules, cables, plugs, antennas
XIRIUM PRO base station	XIRIUM PRO TX (transmitter) without module, short TX XIRIUM PRO RX (receiver) without module, short RX
XIRIUM PRO module	Exchangeable module for the XIRIUM PRO base station
XIRIUM PRO device	XIRIUM PRO base station with module plugged-in
XROC mode	Extreme Ruggedized One Channel mode for a secure connection in extreme situations.
Peripheral devices	All devices which can be connected with each other via the XIRIUM PRO devices: audio sources (transmitters) and audio sinks (receivers)
Audio source	All devices which emit a signal
Audio sink	All devices which receive the audio signals, e.g., loudspeakers, audio systems (amplifiers, mixing consoles, etc.)
Transmission path	Wireless connection between the XIRIUM PRO devices. A transmission path consists of 1 TX, 1 repeater (optional) and at least 1 RX.
Network	All devices used which are connected to the app via an access point.

1.3 Explanation of symbols





In order to make this user manual easier to understand, uniform safety instructions, symbols, terms and abbreviations were used. The following symbols designate instructions which are not relevant to safety, yet make it easier to understand the operating manual.

- ✔ The preconditions for an action are depicted with this symbol. Complete the specified items before carrying out the action steps which follow.
 - ▶ Action steps are designated by this symbol. Carry out the action steps in the order they are presented.
 - ✔ The result of the action or the reaction of the product to the action are depicted with this symbol.
 - Lists without a mandatory sequence are presented as a list with this bullet.
1. Numbered listings are displayed in this manner.
(1) Refers to a position in an illustration.

Texts in this color designate elements on the app surface.

 Wherever you see this symbol, you will find useful information for safe, trouble-free operation of the product.

1.3.1 Symbols in illustrations

Symbol	Explanation
	Image position
	Action steps numbered in an illustration. Carry out the action steps in the order they are presented.
	Only carry out these tasks when using an Apple iPad.
	Only carry out these tasks when using an Android tablet.

1.4 Target group

This user manual is directed to sound engineers and professional personnel who have detailed experience in the sound and event technology.

Personnel who are in training must only work with this device under the supervision of experienced persons.

2 Safety

2.1 Warning information and signal words

Special warning information regarding potential dangers inherent in a particular action are presented before instructions for an action. The warnings are ranked as follows:

⚠ DANGER

Immediate threat of danger!

This type of warning points out a situation which would result in death or severe injuries.

- ▶ If this warning is not heeded, the threat of death or serious injuries is imminent.

⚠ WARNING

Possible threat of danger!

This type of warning points out a situation which could result in death or severe injuries.

- ▶ If this warning is not heeded, the threat of death or serious injuries might be imminent.

⚠ CAUTION

Possible threat of danger!

This type of warning points out a situation which could result in minor or moderate injuries.

- ▶ If this warning is not heeded, minor injuries may result.

⚠ NOTICE

Possible threat of property damage!

This type of warning points out a situation which could result in damage to the device and its components.

- ▶ If this warning is not heeded, property damage may result.

2.2 Warning symbols

Symbol	Warning
	General warning
	Warning of hearing impairment
	Danger of electric shock

2.3 Important regulatory notes

This equipment has been tested and found to comply with the limits for a Class B digital device, pursuant to Part 15 of the FCC Rules. These limits are designed to provide reasonable protection against harmful interference in a residential installation. This equipment generates, uses and can radiate radio frequency energy and, if not installed and used in accordance with the instructions, may cause harmful interference to radio communications. However, there is no guarantee that interference will not occur in a particular installation. If this equipment does cause harmful interference to radio or television reception, which can be determined by turning the equipment off and on, the user is encouraged to try to correct the interference by one or more of the following measures:

- Reorient or relocate the receiving antenna.
- Increase the separation between the equipment and receiver.
- Connect the equipment into an outlet on a circuit different from that to which the receiver is connected.
- Consult the dealer or an experienced radio/TV technician for help.

NOTICE

This device complies with Part 15 of the FCC Rules and with Industry Canada licence-exempt RSS standards.

Operation is subject to the following two conditions:

1. this device may not cause harmful interference, and
2. this device must accept any interference received, including interference that may cause undesired operation.

REMARQUE

Le présent appareil est conforme aux CNR d'Industrie Canada applicables aux appareils radio exempts de licence. L'exploitation est autorisée aux deux conditions suivantes:

1. l'appareil ne doit pas produire de brouillage, et
2. l'utilisateur de l'appareil doit accepter tout brouillage radioélectrique subi, même si le brouillage est susceptible d'en compromettre le fonctionnement.

NOTICE

Changes or modifications made to this equipment not expressly approved by Neutrik may void the FCC and IC authorization to operate this equipment.

NOTICE

This device must be professionally installed.

NOTICE

This radio transmitter (IC: 11536A-XPT / IC: 11536A-XPR) has been approved by Industry Canada to operate with the antenna types listed below with the maximum permissible gain indicated. Antenna types not included in this list, having a gain greater than the maximum gain indicated for that type, are strictly prohibited for use with this device.

Provided antennas:

- NXPA-2-360 (SOA-2456/360/1/0/V; 2 dBi gain)
- NXPA-6-360-25 (ECO6-5500-BLK-RN; 6 dBi gain)
- NXPA-9-360-12.5 (ECO9-5500-BLK-RN; 9 dBi gain)

2.3.1 Radio frequency radiation exposure information

This equipment complies with FCC radiation exposure limits set forth for an uncontrolled environment. This equipment should be installed and operated with minimum distance of 0,65 ft (20 cm) between the radiator and your body.

This transmitter must not be co-located or operating in conjunction with any other antenna or transmitter.

2.4 Important safety instructions

⚠ WARNING

Risk of fire or electric shock!

- ▶ To reduce the risk of fire or electric shock, do not expose this device to rain or moisture and do not set any objects containing liquids on this apparatus.

⚠ WARNING

Danger of fire and explosion due to overheated battery!

- ▶ Do not expose batteries or battery pack to excessive heat such as fire or other heat sources.
- To completely disconnect this apparatus from AC mains, disconnect the power supply cord plug from the AC socket.
- Keep the mains plug of the power supply cord readily accessible.

Avoid property damage to the XIRIUM PRO devices due to unsuitable operating and environmental conditions:

- Never immerse in water.
- Protect from strong sunlight.
- Never install the device near heat sources such as radiators, heating units, ovens or stoves.
- Never cover the device, to avoid overheating.
- Protect the device from impact and above all, from falling from poles, stages, tables or furniture.
- Always set up and fasten the device as shown in Section "5.8.4 Fastening and securing XIRIUM PRO devices" on page 46.

Repair

⚠ DANGER

Danger of injury or electric shock and property damage due to improper repair!

The XIRIUM PRO devices do not contain any parts which you can repair yourself. Opening or repairing the devices on your own can lead to severe damage to the devices and electrical shock or injuries to the operator.

- ▶ Do not open the housing of XIRIUM PRO devices under any circumstances.
- ▶ Do not exchange any parts yourself.
- ▶ Only have XIRIUM PRO devices repaired by a authorized specialist dealer.

Electrical connection

⚠ DANGER

Danger of electric shock when connecting to or disconnecting from a power grid!

- ▶ Only connect the devices to mains sockets installed by authorized electricians.
- ▶ Do not handle the devices with moist or wet hands under any circumstances.
- ▶ Make sure the specified mains voltage and mains frequency agree with the values of the power grid.
- ▶ Only use the delivered power supply cable for connecting to the socket.
- ▶ During storms or whenever there is a danger of power fluctuations, switch off the device and separate from the power grid.
- ▶ Ensure that the power supply cable is not kinked, hung over sharp edges or allowed to contact hot surfaces during operation.
- ▶ Do not use the devices if there is interference or damage to the devices, displays or accessories.

Information for operation

- ▶ Ensure that the ambient conditions specified for XIRIUM PRO are observed during operation.
- ▶ Do not use the XIRIUM PRO devices if they are not functioning properly, have fallen or been damaged, have become wet or if parts of the devices have been immersed in water.
- ▶ If disruptions occur during operation:
Immediately switch off the XIRIUM PRO devices and disconnect them from the power grid.
- ▶ Do not operate the XIRIUM PRO devices in environments where flammable or explosive materials, gases or vapors are present or could occur.

⚠ AVERTISSEMENT

Risque d'électrocution!

- ▶ Pour réduire les risques d'incendie ou d'électrocution, ne pas exposer l'appareil à la pluie ni à l'humidité et ne pas déposer d'objet contenant du liquide sur cet appareil.

⚠ AVERTISSEMENT

Risque d'incendie et d'explosion en cas de surchauffe de la pile!

- ▶ Les batteries ou bloc de batteries ne doivent pas être exposées à une chaleur excessive telle que celle du soleil, feu ou autre source de chaleur similaire.

- Pour déconnecter complètement l'appareil du réseau d'alimentation, déconnecter le cordon d'alimentation de la prise murale.
- La prise du réseau d'alimentation doit demeurer aisément accessible.

Pour éviter les dommages matériels aux appareils XIRIUM PRO causés par des conditions climatiques ou de fonctionnement inadéquates :

- Ne jamais l'immerger dans l'eau.
- Protéger l'appareil des forts rayons du soleil.
- Ne jamais installer l'appareil près de sources de chaleur comme un radiateur, un appareil de chauffage, un four ou un poêle.
- Afin d'éviter une surchauffe, ne jamais couvrir l'appareil.
- Il faut protéger l'appareil des impacts et surtout l'empêcher de tomber d'une perche, d'une estrade, d'une table ou d'un meuble.
- Toujours installer et fixer l'appareil comme illustré dans la section «5.8.4 Fastening and securing XIRIUM PRO devices» on page 42.

Réparation

⚠ DANGER

Risque de blessures, d'électrocution et de dommages matériels en cas de réparations inappropriées!

Les appareils XIRIUM PRO ne contiennent aucune pièce pouvant être réparée par l'utilisateur. L'ouverture ou la réparation des appareils par l'utilisateur peuvent entraîner des dommages graves aux appareils, des blessures ou une électrocution de l'opérateur.

- ▶ Ne pas ouvrir le boîtier des appareils XIRIUM PRO en aucun cas.
- ▶ L'utilisateur ne doit pas changer de pièces lui-même.
- ▶ Faire réparer tout appareil XIRIUM PRO uniquement par un détaillant spécialisé autorisé.

Branchement électrique

⚠ DANGER

Risque d'électrocution lors du branchement ou du débranchement au réseau électrique!

- ▶ Brancher seulement l'appareil à des prises de courant installées par des électriciens qualifiés.
- ▶ Ne pas manipuler les appareils avec les mains humides ou mouillées en aucun cas.
- ▶ S'assurer que la fréquence et la tension du réseau correspondent aux spécifications.
- ▶ Utiliser seulement le cordon d'alimentation électrique fourni pour brancher l'appareil à la prise de courant.
- ▶ Pendant les tempêtes où lorsqu'il y a des risques de fluctuation de tension, fermer l'appareil et le débrancher du réseau électrique.
- ▶ S'assurer que le cordon d'alimentation n'est pas plié, suspendu sur une arête tranchante ou en contact avec des surfaces chaudes pendant le fonctionnement.
- ▶ Ne pas utiliser les appareils s'il y a des interférences ou si l'appareil, l'écran ou les accessoires sont endommagés.

Informations relatives au fonctionnement

- ▶ S'assurer que les conditions ambiantes prévues sont respectées pendant le fonctionnement du XIRIUM PRO.
- ▶ Ne pas utiliser les appareils XIRIUM PRO s'ils ne fonctionnent pas adéquatement, s'ils sont tombés ou s'ils sont endommagés ou si des pièces de l'appareil ont été immergées dans l'eau.
- ▶ Si des perturbations se produisent pendant le fonctionnement :
Éteindre immédiatement l'appareil XIRIUM PRO et le débrancher du réseau électrique.
- ▶ Ne faites pas fonctionner l'appareil XIRIUM PRO dans des environnements où des matériaux, des gaz ou des vapeurs inflammables ou explosifs peuvent être présents ou peuvent se produire.

2.5 Proper use

The XIRIUM PRO devices are intended for signal transmission between an audio source and an audio sink in accordance with the technical specifications.

2.6 Foreseeable improper use

The XIRIUM PRO devices are not suitable for use in potentially explosive atmospheres.

3 Components and accessories

3.1 XIRIUM PRO components

The components and accessories are ordered individually.



Pos.	Description	Article no.
1	TX base station* (TX base station, XIRIUM PRO USB data cable, Manfrotto™ universal mounting clamp, 5 GHz antenna, 2.4 GHz antenna)	NXP2TX-C
2	RX base station* (RX base station, XIRIUM PRO USB data cable, Manfrotto™ universal mounting clamp, 2.4 GHz antenna)	NXP2RX-C
3	TX modules <ul style="list-style-type: none"> • TX module analog* • TX module AES* • TX module DANTE* 	NXP-TM-ANA NXP-TM-AES NXP-TM-DANTE
4	RX modules <ul style="list-style-type: none"> • RX module analog* • RX module AES* • RX module DANTE* • Repeater module* 	NXP-RM-ANA NXP-RM-AES NXP-RM-DANTE NXP-RM-RP
5	5 GHz antenna 9 dBi 360°H 12.5°V	NXPA-9-360-12.5
6	5 GHz antenna 6 dBi 360°H 25°V	NXPA-6-360-25
7	5 GHz directional antenna 14 dBi 40°H 35°V, including adapter to mount the antenna directly on a receiver if no repeater module is inserted!	NXPA-14-40-35
8	2.4 GHz omnidirectional antenna for connecting app	NXPA-WIFI
9	5 GHz directional antenna (for remote setup) 18 dBi 18°H 18°V, for receiver if no repeater module is inserted! (cable not included!)	NXPA-18-18-18
10	5 GHz omnidirectional antenna 2 dBi 360°H 360°V, for repeater setups with different antenna heights (see page 26)	NXPA-2-360
11	Antenna cable S04162B, N type connectors, 5 m, 4 dB attenuation	NKXPA-5
12	N Adapter female female, for remote TX antenna (cable not included!)	NXPA-N-FF
13	Manfrotto™ universal mounting clamp	NXUC-M-15
14	Mounting arm for XIRIUM PRO antennas (NXPA-14-14-35, NXPA-18-18-18, NX-6-360-25), compatible with Manfrotto™ clamp	NXPMA
15	Power cable XIRIUM PRO, 3 m	NKXPF-5-15-3
16	XIRIUM PRO data cable	NKXP-DATA
17	Flight case with foam cut-outs to hold 2x base stations (not included)	CAS-NXP
18	Hard case (trolley) with foam cut-outs to hold 3 devices (not included)	CAS-NXP-T



* Power cables have to be ordered separately!

* Quick Start Guide included in scope of delivery.

4 Description of product

4.1 XIRIUM PRO base station

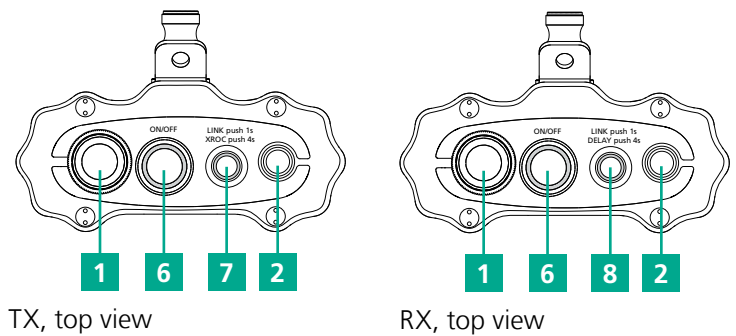
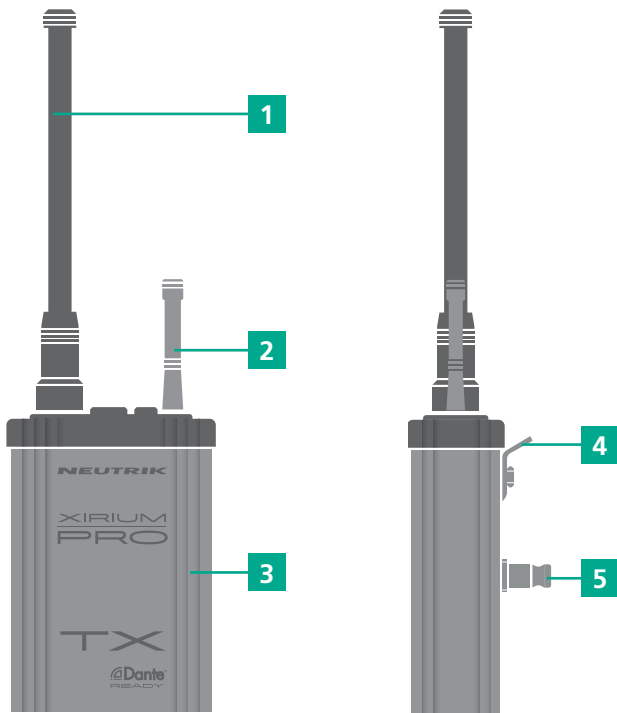

TX, top view

RX, top view

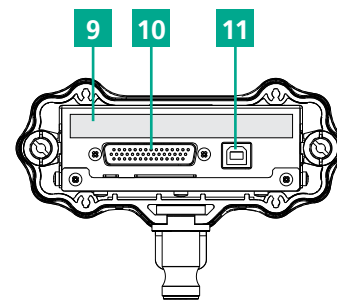

Bottom view

Pos.	Designation
1	5 GHz antenna connector with 5 GHz antenna The antenna transmits the signals between the XIRIUM PRO devices.
2	2.4 GHz antenna connector (reverse SMA) with 2.4 GHz antenna Transmits control data via WIFI
3	Housing Extruded aluminum housing
4	Lug Safety lug for additional fall arresting
5	Bolt Adapter for mounting with a Manfrotto™ clamp
6	On/off switch Powering the device ON/OFF, LED indication LED display: <ul style="list-style-type: none"> • LED off: Device off or powering up. • LED solid green: Device powered-on and battery level is between 20 % and 100 %. • LED slow-flash green: Device powered-on and battery is charging. • LED solid red: Firmware update active. • LED slow-flash red: Device identification activated from app by pressing the Identify Device button. • LED quick-flash red: Battery below 20 %.

Pos.	Designation
7	TX link button Linking devices, switching XROC mode ON/OFF, resetting transmission power <ul style="list-style-type: none"> • Push and release: Start/stop LINK process • Hold 4 sec: Toggle XROC mode ON/OFF • Hold 8 sec: Reset transmission power LED display: <ul style="list-style-type: none"> • LED off: TX not transmitting audio signal. • LED solid blue: TX transmitting audio signal. • LED quick-flash blue: Device is activated for linking process. • LED slow-flash blue: XROC mode set to ON.
8	RX link button Linking devices; switching delay ON/OFF <ul style="list-style-type: none"> • Push and release: Start/stop LINK process • Hold 4 sec: Toggle delay ON/OFF • Hold 8 sec: Reset repeater transmission power LED display: <ul style="list-style-type: none"> • LED off: RX not receiving audio signal. • LED solid blue: RX receiving audio signal. • LED quick-flash blue: Device is activated for linking process. • LED slow-flash blue: Delay set to ON.
9	Type plate With serial number, SSID and WLAN password
10	D-Sub connector Interface between base station and module.
11	USB port USB connection for firmware update

4.2 Modules

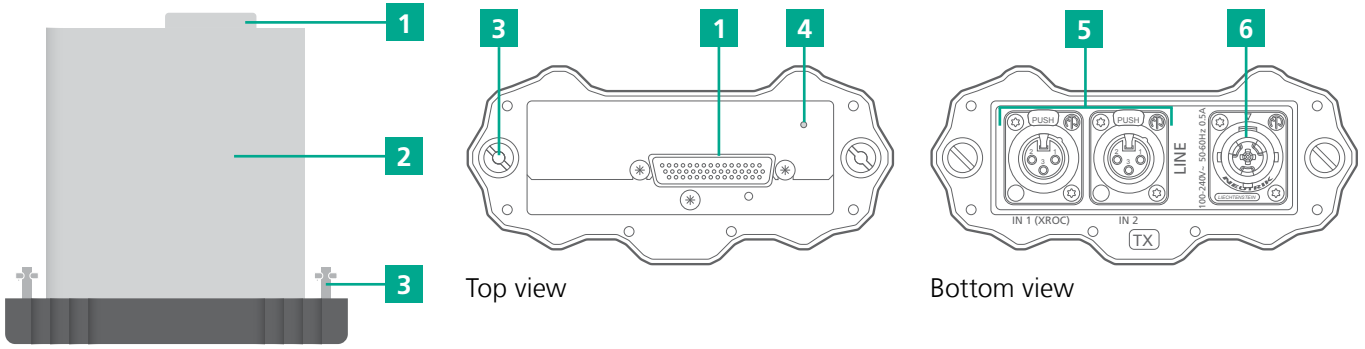

Pos.	Description
1	D-Sub connector interface between base station and module
2	Module with integrated battery
3	Locking bolt
4	LED charging indicator <ul style="list-style-type: none"> Flashes green: Battery charging. Lit green: Battery fully charged.

Pos.	Description
5	Audio IN (TX), audio OUT (RX) (different connections depending on module)
6	powerCON TRUE1 chassis for XIRIUM PRO power cable

4.2.1 TX modules

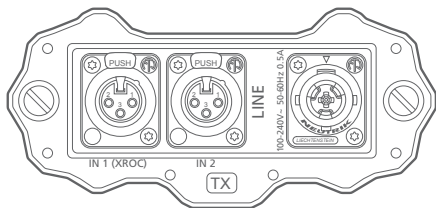

TX analog module

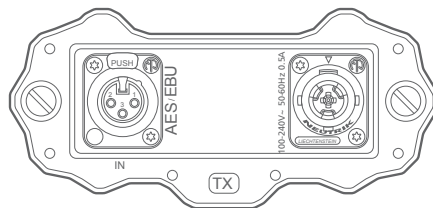

TX AES module

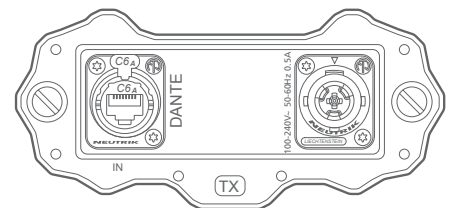

TX DANTE module

4.2.2 RX modules

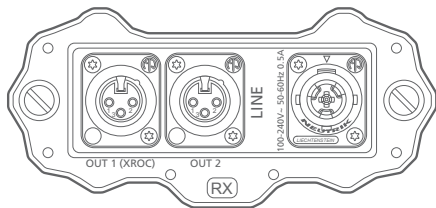

RX analog module

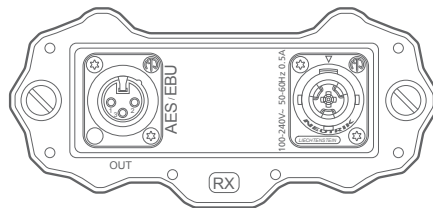

RX AES module

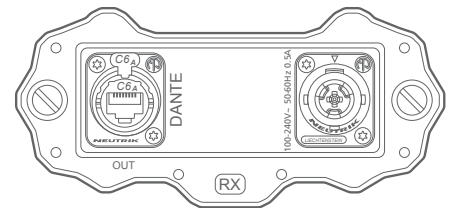

RX DANTE module

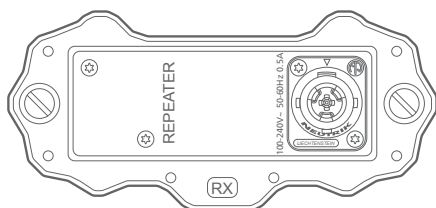

Repeater module