

FCC Radio Test Report

FCC ID: 2AB9W-PP150XP

Report No. : BTL-FCCP-2-1908T080
Equipment : 3D Printer
Model Name : PartPro150 xP
Brand Name : XYZprinting
Applicant : XYZprinting, Inc.
Address : 10F., No.99, Sec. 5, Nanjing E. Rd., Songshan Dist., Taipei City 10571, Taiwan (R.O.C.)
Manufacturer : Cal-Comp Electronics (Thailand) Public Company Limited
Address : 138, Moo 4, Phechkasem Road, Sapang, Koawoyoi, Petchaburi 76140, Thailand.
Factory : Cal-Comp Electronics (Thailand) Public Company Limited
Address : 138, Moo 4, Phechkasem Road, Sapang, Koawoyoi, Petchaburi 76140, Thailand.
Radio Function : NFC (13.56 MHz)
FCC Rule Part(s) : FCC Part 15, Subpart C (15.225)
Measurement Procedure(s) : ANSI C63.4-2014
Date of Receipt : 2019/9/20
Date of Test : 2019/9/20 ~ 2019/11/14
Issued Date : 2019/12/19

The above equipment has been tested and found in compliance with the requirement of the above standards by BTL Inc.

Prepared by :

Peter Chen, Engineer

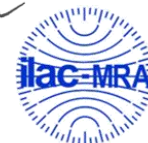

Approved by :

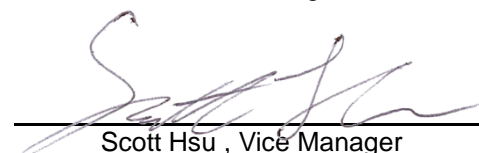
Scott Hsu, Vice Manager

BTL Inc.

No.18, Ln. 171, Sec. 2, Jiuzong Rd., Neihu Dist., Taipei City 114, Taiwan

Tel: +886-2-2657-3299

Fax: +886-2-2657-3331

Web: www.newbtl.com

Declaration

BTL represents to the client that testing is done in accordance with standard procedures as applicable and that test instruments used has been calibrated with standards traceable to international standard(s) and/or national standard(s).

BTL's reports apply only to the specific samples tested under conditions. It is manufacture's responsibility to ensure that additional production units of this model are manufactured with the identical electrical and mechanical components. **BTL** shall have no liability for any declarations, inferences or generalizations drawn by the client or others from **BTL** issued reports.

The report must not be used by the client to claim product certification, approval, or endorsement by NIST, A2LA, or any agency of the U.S. Government.

This report is the confidential property of the client. As a mutual protection to the clients, the public and ourselves, the test report shall not be reproduced, except in full, without our written approval.

BTL's laboratory quality assurance procedures are in compliance with the **ISO/IEC 17025** requirements, and accredited by the conformity assessment authorities listed in this test report.

BTL is not responsible for the sampling stage, so the results only apply to the sample as received.

The information, data and test plan are provided by manufacturer which may affect the validity of results, so it is manufacturer's responsibility to ensure that the apparatus meets the essential requirements of applied standards and in all the possible configurations as representative of its intended use.

Limitation

For the use of the authority's logo is limited unless the Test Standard(s)/Scope(s)/Item(s) mentioned in this test report is (are) included in the conformity assessment authorities acceptance respective.

Please note that the measurement uncertainty is provided for informational purpose only and are not use in determining the Pass/Fail results.

CONTENTS

REPORT ISSUED HISTORY	4
1 SUMMARY OF TEST RESULTS	5
1.1 TEST FACILITY	6
1.2 MEASUREMENT UNCERTAINTY	6
1.3 TEST ENVIRONMENT CONDITIONS	7
2 GENERAL INFORMATION	8
2.1 DESCRIPTION OF EUT	8
2.2 TEST MODES	8
2.3 BLOCK DIAGRAM SHOWING THE CONFIGURATION OF SYSTEM TESTED	9
2.4 SUPPORT UNITS	9
3 AC POWER LINE CONDUCTED EMISSIONS TEST	10
3.1 LIMIT	10
3.2 TEST PROCEDURE	10
3.3 DEVIATION FROM TEST STANDARD	10
3.4 TEST SETUP	11
3.5 TEST RESULT	11
4 RADIATED EMISSIONS TEST	12
4.1 LIMIT	12
4.2 TEST PROCEDURE	13
4.3 DEVIATION FROM TEST STANDARD	13
4.4 TEST SETUP	13
4.5 EUT OPERATING CONDITIONS	14
4.6 TEST RESULT – 9 KHZ TO 30 MHZ– FCC PART 15.209	15
4.7 TEST RESULT – 30 MHZ TO 1 GHZ – FCC PART 15.209	15
4.8 TEST RESULT – FCC PART 15.225	15
5 FREQUENCY STABILITY	16
5.1 LIMIT	16
5.2 TEST PROCEDURE	16
5.3 DEVIATION FROM TEST STANDARD	16
5.4 EUT OPERATING CONDITIONS	16
5.5 TEST RESULT	16
6 20 DB BANDWIDTH	17
6.1 LIMIT	17
6.2 TEST PROCEDURE	17
6.3 DEVIATION FROM TEST STANDARD	17
6.4 TEST SETUP	17
6.5 EUT OPERATING CONDITIONS	17
6.6 TEST RESULT	17
7 LIST OF MEASURING EQUIPMENTS	18
8 EUT TEST PHOTO	19
9 EUT PHOTOS	19
APPENDIX A AC POWER LINE CONDUCTED EMISSIONS	20
APPENDIX B RADIATED EMISSIONS - 9 KHZ TO 30 MHZ	23
APPENDIX C RADIATED EMISSIONS - 30 MHZ TO 1 GHZ	28
APPENDIX D RADIATED EMISSIONS - FCC PART 15.225	31
APPENDIX E FREQUENCY STABILITY MEASUREMENT	34
APPENDIX F 20 DB BANDWIDTH	36

REPORT ISSUED HISTORY

Report Version	Description	Issued Date
R00	Original Issue.	2019/11/22
R01	Revised report to address TCB's comments.	2019/12/19

1 SUMMARY OF TEST RESULTS

Test procedures according to the technical standards.

FCC Part 15, Subpart C (15.225)				
Standard(s) Section	Description	Test Result	Judgement	Remark
15.207	AC Power Line Conducted Emissions	APPENDIX A	Pass	-----
15.35 15.205 15.209 15.225	Radiated Emissions	APPENDIX B APPENDIX C APPENDIX D	Pass	-----
15.225(e)	Frequency Stability	APPENDIX E	Pass	-----
15.203	Antenna Requirement	-----	Pass	-----
15.215(c)	20 dB Bandwidth	APPENDIX F	Pass	-----

NOTE:

(1) "N/A" denotes test is not applicable in this Test Report.

1.1 TEST FACILITY

The test facilities used to collect the test data in this report:

No. 68-1, Ln. 169, Sec. 2, Datong Rd., Xizhi Dist., New Taipei City 221, Taiwan

The test sites and facilities are covered under FCC RN: 355421 and DN: TW1099.

- C05 CB08 CB11 CB15 CB16
 CB18 SR06

1.2 MEASUREMENT UNCERTAINTY

The reported uncertainty of measurement $y \pm U$, where expanded uncertainty U is based on a standard uncertainty multiplied by a coverage factor of $k = 2$, providing a level of confidence of approximately **95 %**. The measurement instrumentation uncertainty considerations contained in CISPR 16-4-2. The BTL measurement uncertainty is less than the CISPR 16-4-2 U_{cispr} requirement.

A. AC power line conducted emissions test:

Test Site	Method	Measurement Frequency Range	U (dB)
C05	CISPR	150 kHz ~ 30MHz	3.44

B. Radiated emissions below 1 GHz test :

Test Site	Method	Measurement Frequency Range	Ant. H / V	U,(dB)
CB18 (3m)	CISPR	30MHz ~ 200MHz	V	4.20
		30MHz ~ 200MHz	H	3.64
		200MHz ~ 1,000MHz	V	4.56
		200MHz ~ 1,000MHz	H	3.90

C. Conducted test :

Test Item	U,(dB)
Bandwidth	1.13
Output power	1.06
Power Spectral Density	1.20
Conducted Spurious emissions	1.14
Conducted Band edges	1.13

NOTE:

Unless specifically mentioned, the uncertainty of measurement has not been taken into account to declare the compliance or non-compliance to the specification.

1.3 TEST ENVIRONMENT CONDITIONS

Test Item	Environment Condition	Tested by
AC Power Line Conducted Emissions	25 °C, 45 %	Eric Lee
Radiated emissions (9KHz-30MHz)	23 °C, 59 %	Hunter Chiang
Radiated emissions (30MHz TO 1000MHz)	23 °C, 59 %	John Chuang
Frequency Stability	23.5 °C, 49 %	William Wei
20 dB Bandwidth	23.5 °C, 49 %	William Wei

2 GENERAL INFORMATION

2.1 DESCRIPTION OF EUT

Equipment	3D Printer
Model Name	PartPro150 xP
Brand Name	XYZprinting
Model Difference	N/A
Power Source	DC voltage supplied from AC/DC Adapter. (1) FSP / FSP060-DAAN3 (2) EDAC / EA10681P-240
Power Rating	(1) I/P: 100-240V~, 1.8A 50-60Hz / O/P: 24.0V---2.5A (60E MAX.) (2) I/P: 100-240V~2.0A, 50-60Hz / O/P: 24V---2.5A
Products Covered	1 * USB cable 1 * Power cable 2 * Adapter: (1) FSP / FSP060-DAAN3 (2) EDAC / EA10681P-240
Frequency Range	13.56 MHz
Antenna Designation	LOOP Antenna
Max H-field strength	46.86 dBuV/m
Test Model	PartPro150 xP
Sample Status	Engineering Sample
EUT Modification(s)	N/A

NOTE:

(1) For a more detailed features description, please refer to the manufacturer's specifications or the user's manual.

(2) Channel List:

Channel	Frequency (MHz)
01	13.56

(3) Table for Filed Antenna:

Ant.	Brand	Model Name	Antenna Type	Connector	Gain (dBi)
1	N/A	N/A	Coil	N/A	N/A

2.2 TEST MODES

Test Items	Test mode	Channel	Note
AC power line conducted emissions	NFC_Normal	-	-
Radiated emissions (9KHz-30MHz)	Transmit	01	-
Radiated emissions (30MHz TO 1000MHz)	Transmit	01	-
Frequency Stability	Transmit	01	-
20 dB Bandwidth	Transmit	01	-

NOTE:

(1) The Radiated emissions test was verified based on the worst conducted power and Bandwidth test results reported in the original report.

(2) The Adapter EDAC / EA10681P-240 was found to be the worst case and used for final test.

2.3 BLOCK DIAGRAM SHOWING THE CONFIGURATION OF SYSTEM TESTED

Equipment letters and Cable numbers refer to item numbers described in the tables of clause 2.4.

For 9 kHz to 30 MHz

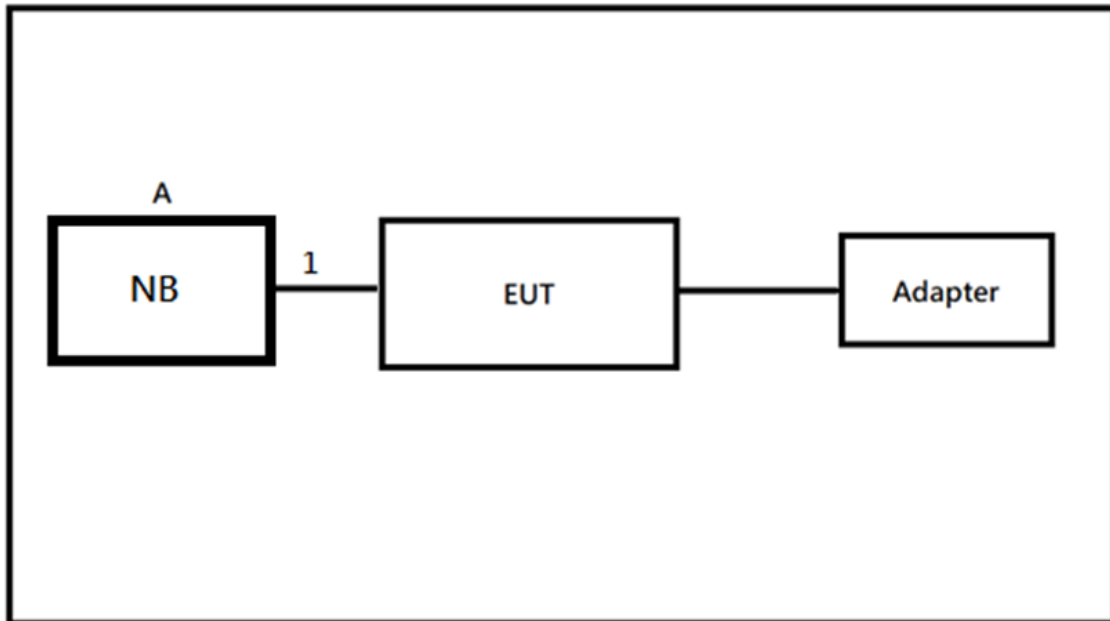

For 30 MHz to 1 GHz

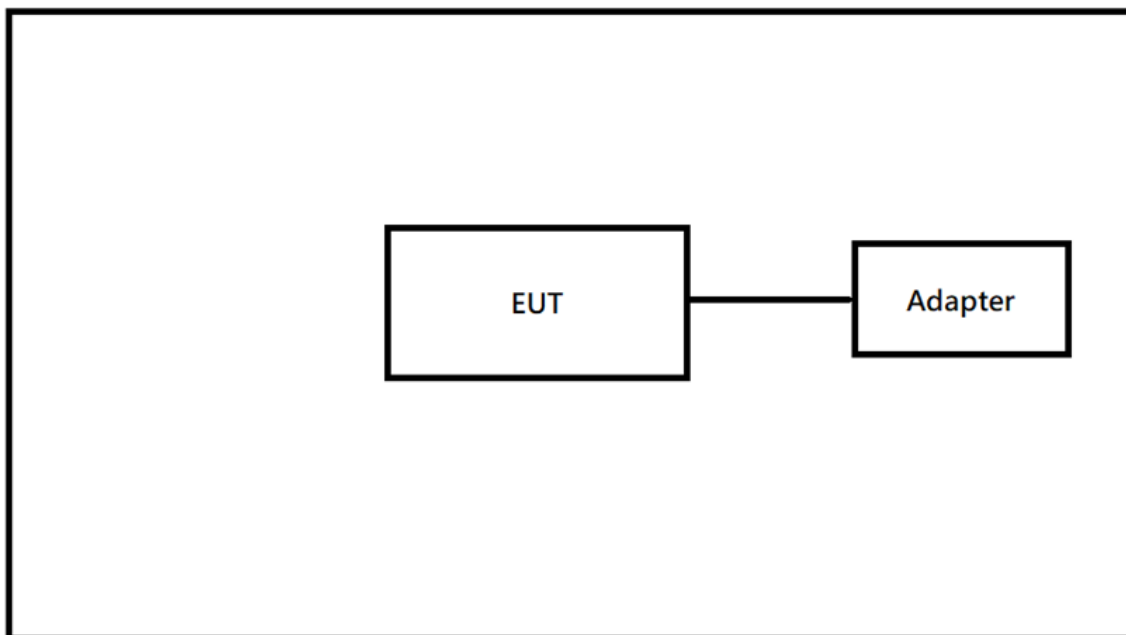

2.4 SUPPORT UNITS

Item	Equipment	Brand	Model No.	Series No.	Remarks
A	NB	HP	TPN-I119	N/A	5cg71818hd

Item	Shielded	Ferrite Core	Length	Cable Type	Remarks
1	N/A	N/A	2m	Console to USB	-

3 AC POWER LINE CONDUCTED EMISSIONS TEST

3.1 LIMIT

Frequency (MHz)	Limit (dB μ V)	
	Quasi-peak	Average
0.15 - 0.5	66 - 56 *	56 - 46 *
0.50 - 5.0	56	46
5.0 - 30.0	60	50

NOTE:

- (1) The tighter limit applies at the band edges.
- (2) The limit of " * " marked band means the limitation decreases linearly with the logarithm of the frequency in the range.
- (3) The test result calculated as following:
 Measurement Value = Reading Level + Correct Factor
 Correct Factor = Insertion Loss + Cable Loss + Attenuator Factor (if use)
 Margin Level = Measurement Value – Limit Value
 Calculation example:

Reading Level		Correct Factor		Measurement Value
38.22	+	3.45	=	41.67

Measurement Value		Limit Value		Margin Level
41.67	-	60	=	-18.33

The following table is the setting of the receiver.

Receiver Parameter	Setting
Attenuation	10 dB
Start Frequency	0.15 MHz
Stop Frequency	30 MHz
IF Bandwidth	9 KHz

3.2 TEST PROCEDURE

- a. The EUT was placed 0.8 m above the horizontal ground plane with the EUT being connected to the power mains through a line impedance stabilization network (LISN).
 All other support equipment were powered from an additional LISN(s).
 The LISN provides 50 Ohm/50uH of impedance for the measuring instrument.
- b. Interconnecting cables that hang closer than 40 cm to the ground plane shall be folded back and forth in the center forming a bundle to keep the cable above 40 cm.
- c. Excess I/O cables that are not connected to a peripheral shall be bundled in the center.
 The end of the cable will be terminated, using the correct terminating impedance.
 The overall length shall not exceed 1 m.
- d. The LISN is spaced at least 80 cm from the nearest part of the EUT chassis.
- e. For the actual test configuration, please refer to the related Item - EUT TEST PHOTO.

NOTE:

- (1) In the results, each reading is marked as Peak, QP or AVG per the detector used.
 BW=9 kHz (6 dB Bandwidth)
- (2) All readings are Peak unless otherwise stated QP or AVG in column of Note. Both the QP and the AVG readings must be less than the limit for compliance.

3.3 DEVIATION FROM TEST STANDARD

No deviation.

3.4 TEST SETUP

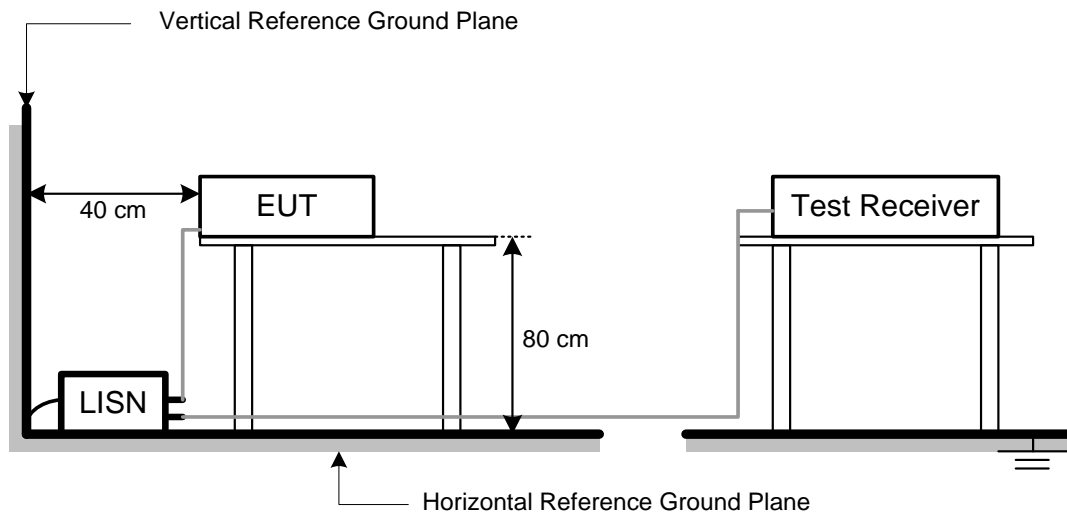

3.5 TEST RESULT

Please refer to the APPENDIX A.

4 RADIATED EMISSIONS TEST

4.1 LIMIT

FCC Part 15.209				
Frequency (MHz)	Field Strength Limitation		Field Strength Limitation at 3m Measurement Dist	
	(uV/m)	Dist	(uV/m)	(dBuV/m)
0.009 – 0.490	2400 / F(KHz)	300m	10000 * 2400/F(KHz)	20log 2400/F(KHz) + 80
0.490 – 1.705	24000 / F(KHz)	30m	100 * 24000/F(KHz)	20log 24000/F(KHz) + 40
1.705 – 30.00	30	30m	100* 30	20log 30 + 40
30.0 – 88.0	100	3m	100	20log 100
88.0 – 216.0	150	3m	150	20log 150
216.0 – 960.0	200	3m	200	20log 200
Above 960.0	500	3m	500	20log 500
FCC Part 15.225(a)/(b)/(c)				
Frequency (MHz)	Field Strength Limitation		Field Strength Limitation at 3m Measurement Dist	
	(uV/m)	Dist	(uV/m)	(dBuV/m)
13.553 – 13.567	15,848	30 m	15,848*100	124
13.567 – 13.710	334	30 m	334*100	90.5
13.110 – 13.410 13.710 – 14.010	106	30 m	106*100	80.5

NOTE:

- (1) The tighter limit shall apply at the boundary between two frequency range.
- (2) Limitation expressed in dBuV/m is calculated by 20log Emission Level (uV/m).
- (3) If measurement is made at 3m distance, then F.S Limitation at 3m distance is adjusted by using the formula of $L_{d1} = L_{d2} * (d_2/d_1)^2$.

Example:

F.S Limit at 30m distance is 30uV/m , then F.S Limitation at 3m distance is adjusted as $L_{d1} = L_1 = 30uV/m * (10)^2 = 100 * 30 uV/m$

- (4) The test result calculated as following:
 Measurement Value = Reading Level + Correct Factor
 Correct Factor = Insertion Loss + Cable Loss + Attenuator Factor(if use)
 Margin Level = Measurement Value – Limit Value

4.2 TEST PROCEDURE

- The measuring distance of 3 m shall be used for measurements. The EUT was placed on the top of a rotating table 0.8 meter above the ground at a 3 meter semi-anechoic chamber. The table was rotated 360 degrees to determine the position of the highest radiation.(below 1GHz).
- The height of the equipment or of the substitution antenna shall be 0.8 m or 1.5m, the height of the test antenna shall vary between 1 m to 4 m. Both horizontal and vertical polarizations of the antenna are set to make the measurement.
- The initial step in collecting radiated emission data is a receiver peak detector mode pre-scanning the measurement frequency range. Significant peaks are then marked and then Quasi Peak detector mode re-measured.
- All readings are Peak unless otherwise stated QP in column of Note. Peak denotes that the Peak reading compliance with the QP Limits and then QP Mode measurement didn't perform.
- For the actual test configuration, please refer to the related Item –EUT Test Photos.

NOTE: (FCC PART 15.209)

- Reading in which marked as QP or Peak means measurements by using are Quasi-Peak Mode with Detector BW=120 kHz.
- All readings are Peak unless otherwise stated QP in column of Note. Peak denotes that the Peak reading compliance with the QP Limits and then QP Mode measurement didn't perform.

NOTE: (FCC PART 15.225)

- Spectrum Setting:
 9 KHz – 150 KHz, RBW= 200Hz, VBW=200Hz, Sweep time = 200 ms.
 150 K Hz – 30 MHz, RBW= 10 KHz, VBW=10 KHz, Sweep time = 200 ms.
 30 MHz – 1000 MHz, RBW= 100KHz, VBW=100KHz, Sweep time = 200 ms.
- All readings are Peak unless otherwise stated QP in column of Note. Peak denotes that the Peak reading compliance with the QP Limits and then QP Mode measurement didn't perform.
- The Log-Bicon Antenna will use to test frequency range from 30MHz to 1000MHz and the Loop Antenna will use to test frequency below 30MHz.

4.3 DEVIATION FROM TEST STANDARD

No deviation.

4.4 TEST SETUP

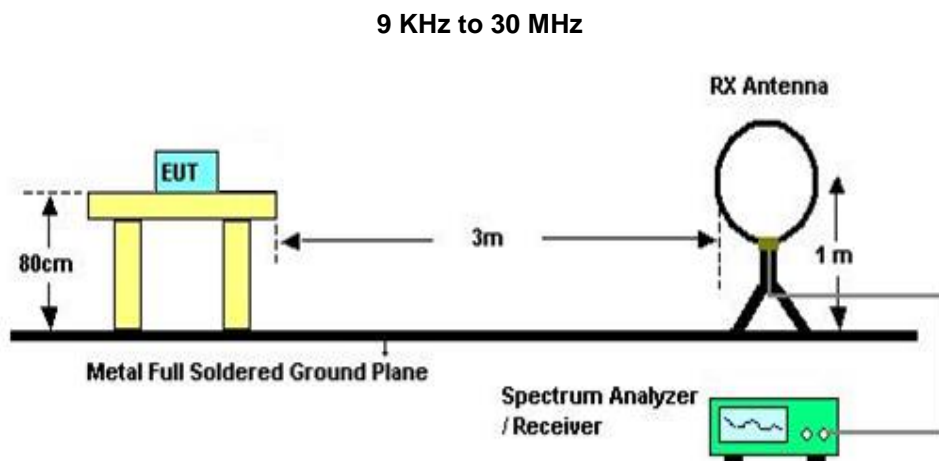

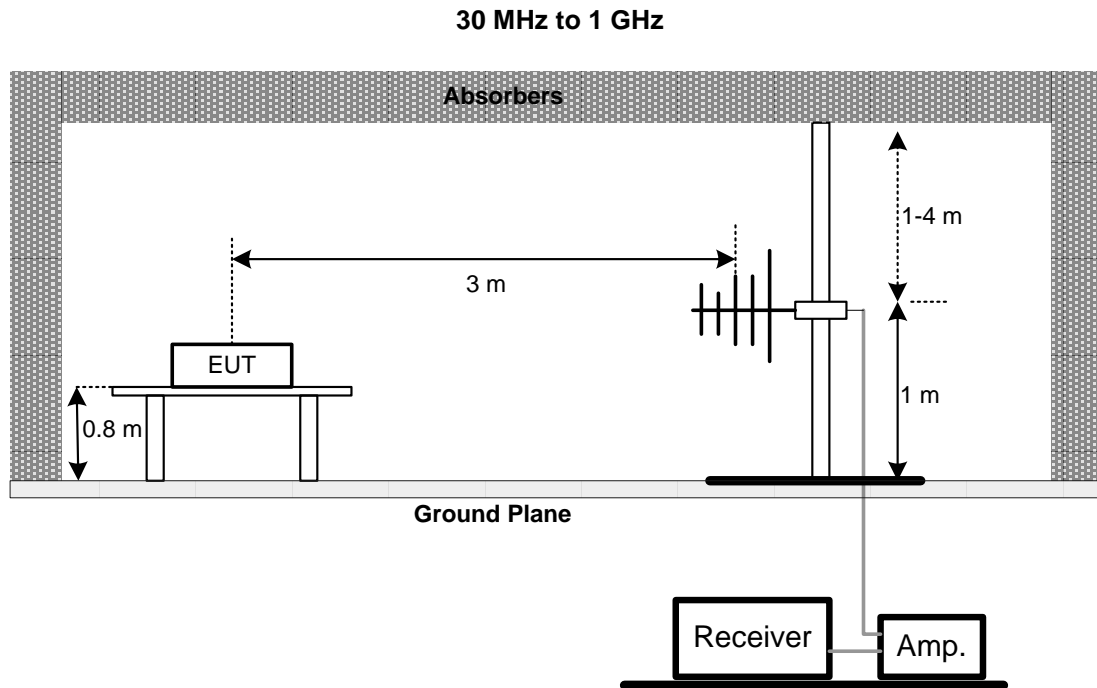

4.5 EUT OPERATING CONDITIONS

The EUT was programmed to be in continuously transmitting mode.

4.6 TEST RESULT – 9 KHZ TO 30 MHZ– FCC PART 15.209

Please refer to the APPENDIX B

4.7 TEST RESULT – 30 MHZ TO 1 GHZ – FCC PART 15.209

Please refer to the APPENDIX C.

4.8 TEST RESULT – FCC PART 15.225

Please refer to the APPENDIX D.

NOTE:

- (1) No limit: This is fundamental signal, the judgment is not applicable.
For fundamental signal judgment was referred to Peak output test.

5 FREQUENCY STABILITY

5.1 LIMIT

FCC Part 15.225(e)

The frequency tolerance of the carrier signal shall be maintained within +/-0.01% of the operating frequency over a temperature variation of - 20 degrees to + 50 degrees C at normal supply voltage, and for a variation in the primary supply voltage from 85% to 115% of the rated supply voltage at a temperature of 20 degrees C.

For battery operated equipment, the equipment tests shall be performed using a new battery.

5.2 TEST PROCEDURE

- a. The equipment under test was connected to an external AC power supply and the RF output was connected to a frequency counter via feed through attenuators. The EUT was placed inside the temperature chamber.
- b. At room temperature ($25\pm 5^{\circ}\text{C}$), an external variable AC power supply was connected to the EUT. The frequency of the transmitter was measured for 115%, 100% and 85% of the nominal operating input voltage.

5.3 DEVIATION FROM TEST STANDARD

No deviation.

5.4 EUT OPERATING CONDITIONS

The EUT was programmed to be in continuously transmitting mode.

5.5 TEST RESULT

Please refer to the APPENDIX E.

6 20 DB BANDWIDTH

6.1 LIMIT

FCC Part 15.215(c)

Intentional radiators operating under the alternative provisions to the general emission limits, as contained in §15.217 through §15.257 and in subpart E of this part, must be designed to ensure that the 20 dB bandwidth of the emission, or whatever bandwidth may otherwise be specified in the specific rule section under which the equipment operates, is contained within the frequency band designated in the rule section under which the equipment is operated.

6.2 TEST PROCEDURE

- a. The EUT was directly connected to the spectrum analyzer and antenna output port as show in the block diagram below,
- b. Spectrum Setting : RBW= 1 kHz, VBW=1 kHz, Sweep time = 20 ms.

6.3 DEVIATION FROM TEST STANDARD

No deviation.

6.4 TEST SETUP

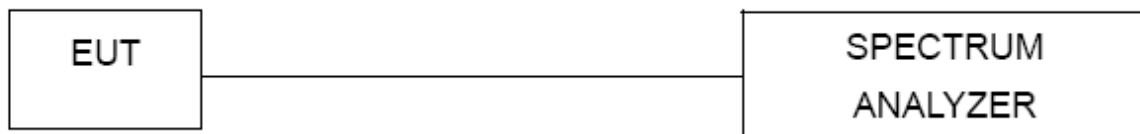

6.5 EUT OPERATING CONDITIONS

The EUT was programmed to be in continuously transmitting mode.

6.6 TEST RESULT

Please refer to the APPENDIX F.

7 LIST OF MEASURING EQUIPMENTS

AC Power Line Conducted Emissions						
Item	Kind of Equipment	Manufacturer	Type No.	Serial No.	Calibrated Date	Calibrated Until
1	TWO-LINE V-NETWORK	R&S	ENV216	101050	2019/3/18	2020/3/17
2	Test Cable	EMCI	EMCCFD300-BM-BMR-6000	170715	2019/8/7	2020/8/6
3	EMI Test Receiver	R&S	ESR7	101433	2018/12/5	2019/12/4
4	Measurement Software	EZ	EZ EMC (Version NB-03A)	N/A	N/A	N/A

Radiated Emissions						
Item	Kind of Equipment	Manufacturer	Type No.	Serial No.	Calibrated Date	Calibrated Until
1	Preamplifier	EMCI	EMC001340	980555	2019/4/12	2020/4/11
2	Preamplifier	EMCI	EMC02325B	980217	2019/4/12	2020/4/11
3	Test Cable	EMCI	EMC104-SM-SM-800	150207	2019/4/12	2020/4/11
4	Test Cable	EMCI	EMC104-SM-SM-3000	151205	2019/4/12	2020/4/11
5	Test Cable	EMCI	EMC-SM-SM-7000	180408	2019/4/12	2020/4/11
6	MXE EMI Receiver	Agilent	N9038A	MY55420127	2019/3/26	2020/3/25
7	Loop Ant	EMCO	EMCI-LPA600	274	2019/5/31	2020/5/30
8	Trilog-Broadband Antenna	Schwarzbeck	VULB 9168	000992	2019/5/29	2020/5/28
9	5dB Attenuator	EMCI	EMCI-N-6-05	AT-N0508	2019/5/29	2020/5/28

Frequency Stability Measurement						
Item	Kind of Equipment	Manufacturer	Type No.	Serial No.	Calibrated Date	Calibrated Until
1	Spectrum Analyzer	R&S	FSP40	100129	2019/5/23	2020/5/22
2	Thermal Chamber	HOLINK	H-TH-2SP-B	H1/EK04101902	2019/7/26	2020/7/25

20 dB Bandwidth Measurement						
Item	Kind of Equipment	Manufacturer	Type No.	Serial No.	Calibrated Date	Calibrated Until
1	Spectrum Analyzer	R&S	FSP40	100129	2019/5/23	2020/5/22

Remark: "N/A" denotes no model name, no serial no. or no calibration specified.
All calibration period of equipment list is one year.

8 EUT TEST PHOTO

Please refer to document Appendix No.: TP-1908T080-FCCP-2 (APPENDIX-TEST PHOTOS).

9 EUT PHOTOS

Please refer to document Appendix No.: EP-1908T080-1 (APPENDIX-EUT PHOTOS).

APPENDIX A AC POWER LINE CONDUCTED EMISSIONS

Test Mode	NFC_Normal	Tested Date	2019/11/8
Test Voltage	AC 120V/60Hz	Phase	Line

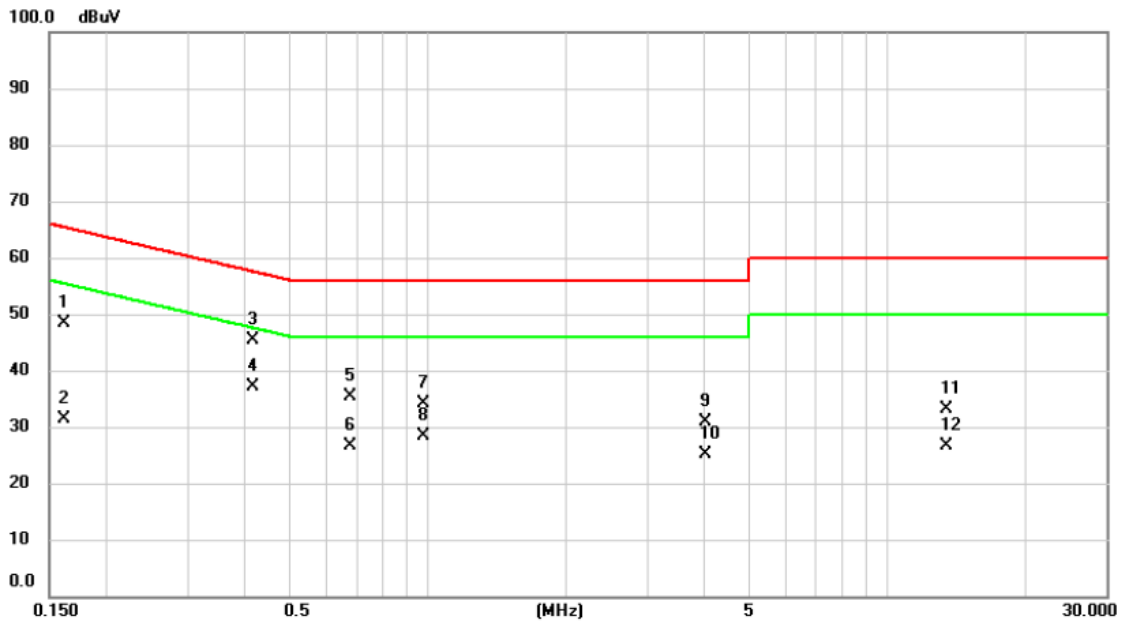

No.	Mk.	Freq. MHz	Reading Level dBuV	Correct Factor dB	Measure- ment dBuV	Limit dBuV	Over dB	Detector	Comment
1		0.1613	38.72	9.57	48.29	65.40	-17.11	QP	
2		0.1613	21.82	9.57	31.39	55.40	-24.01	AVG	
3		0.4177	35.84	9.62	45.46	57.49	-12.03	QP	
4	*	0.4177	27.59	9.62	37.21	47.49	-10.28	AVG	
5		0.6765	25.85	9.64	35.49	56.00	-20.51	QP	
6		0.6765	16.89	9.64	26.53	46.00	-19.47	AVG	
7		0.9780	24.39	9.64	34.03	56.00	-21.97	QP	
8		0.9780	18.84	9.64	28.48	46.00	-17.52	AVG	
9		4.0110	21.16	9.73	30.89	56.00	-25.11	QP	
10		4.0110	15.50	9.73	25.23	46.00	-20.77	AVG	
11		13.4700	23.21	9.90	33.11	60.00	-26.89	QP	
12		13.4700	16.79	9.90	26.69	50.00	-23.31	AVG	

REMARKS:

- (1) Measurement Value = Reading Level + Correct Factor.
- (2) Margin Level = Measurement Value - Limit Value.

Test Mode	NFC_Normal	Tested Date	2019/11/8
Test Voltage	AC 120V/60Hz	Phase	Neutral

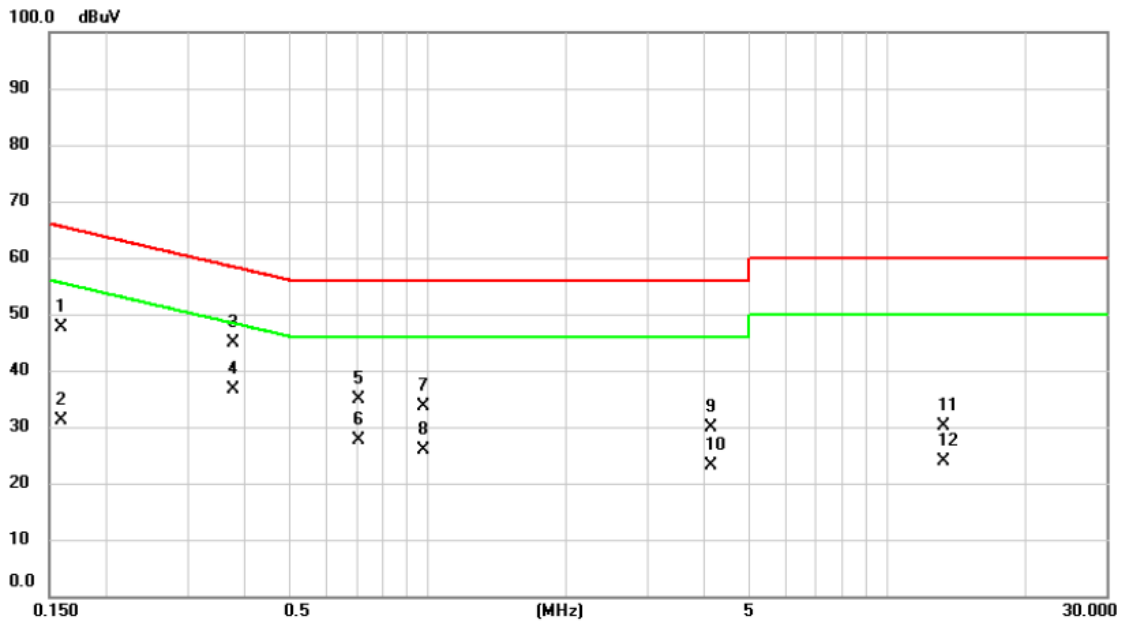

No.	Mk.	Freq. MHz	Reading Level dBuV	Correct Factor dB	Measure- ment dBuV	Limit dBuV	Over dB	Detector	Comment
1		0.1590	38.06	9.57	47.63	65.52	-17.89	QP	
2		0.1590	21.52	9.57	31.09	55.52	-24.43	AVG	
3		0.3772	35.19	9.62	44.81	58.34	-13.53	QP	
4	*	0.3772	26.90	9.62	36.52	48.34	-11.82	AVG	
5		0.7080	25.24	9.65	34.89	56.00	-21.11	QP	
6		0.7080	17.92	9.65	27.57	46.00	-18.43	AVG	
7		0.9757	24.05	9.64	33.69	56.00	-22.31	QP	
8		0.9757	16.36	9.64	26.00	46.00	-20.00	AVG	
9		4.1438	20.18	9.73	29.91	56.00	-26.09	QP	
10		4.1438	13.51	9.73	23.24	46.00	-22.76	AVG	
11		13.2878	20.13	9.89	30.02	60.00	-29.98	QP	
12		13.2878	13.87	9.89	23.76	50.00	-26.24	AVG	

REMARKS:

- (1) Measurement Value = Reading Level + Correct Factor.
- (2) Margin Level = Measurement Value - Limit Value.

APPENDIX B RADIATED EMISSIONS - 9 KHZ TO 30 MHZ

Test Mode	Transmit 13.56MHz	Tested Date	2019/11/12
Test Voltage	AC 120V/60Hz	Azimuth Angle	90°

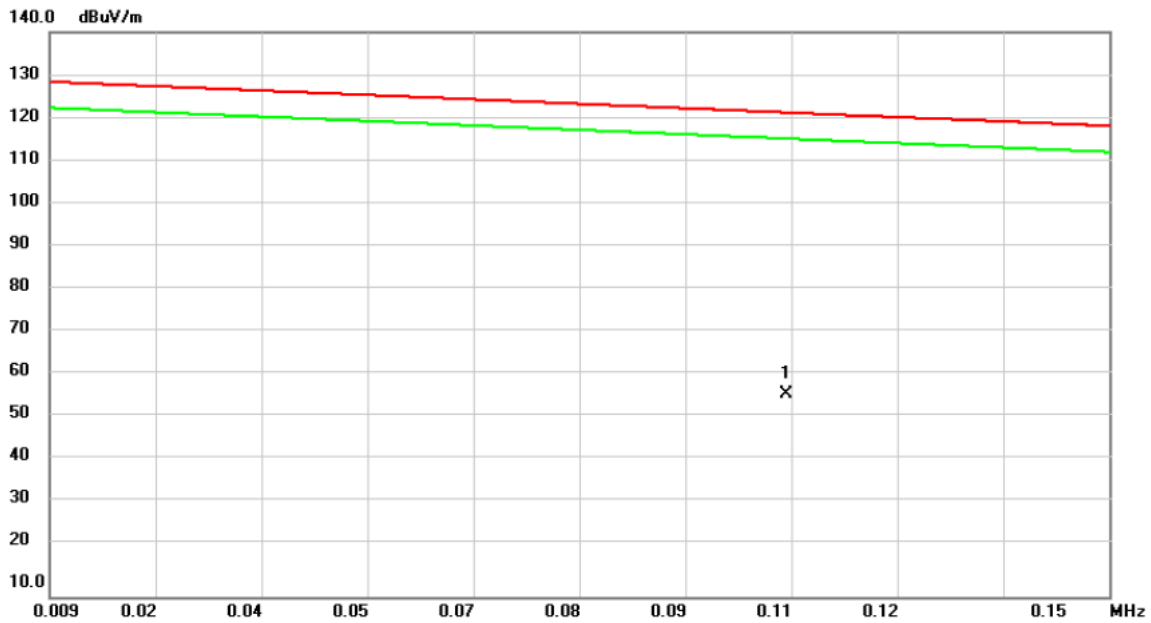

No. Mk.	Freq. (MHz)	Reading Level (dBuV)	Correct Factor (dB)	Measurement (dBuV/m)	Limit (dBuV/m)	Margin (dB)	Detector	Comment
1 *	0.1071	40.43	16.20	56.63	121.43	-64.80	AVG	

REMARKS:

- (1) Measurement Value = Reading Level + Correct Factor.
- (2) Margin Level = Measurement Value - Limit Value.

Test Mode	Transmit 13.56MHz	Tested Date	2019/11/12
Test Voltage	AC 120V/60Hz	Azimuth Angle	90°

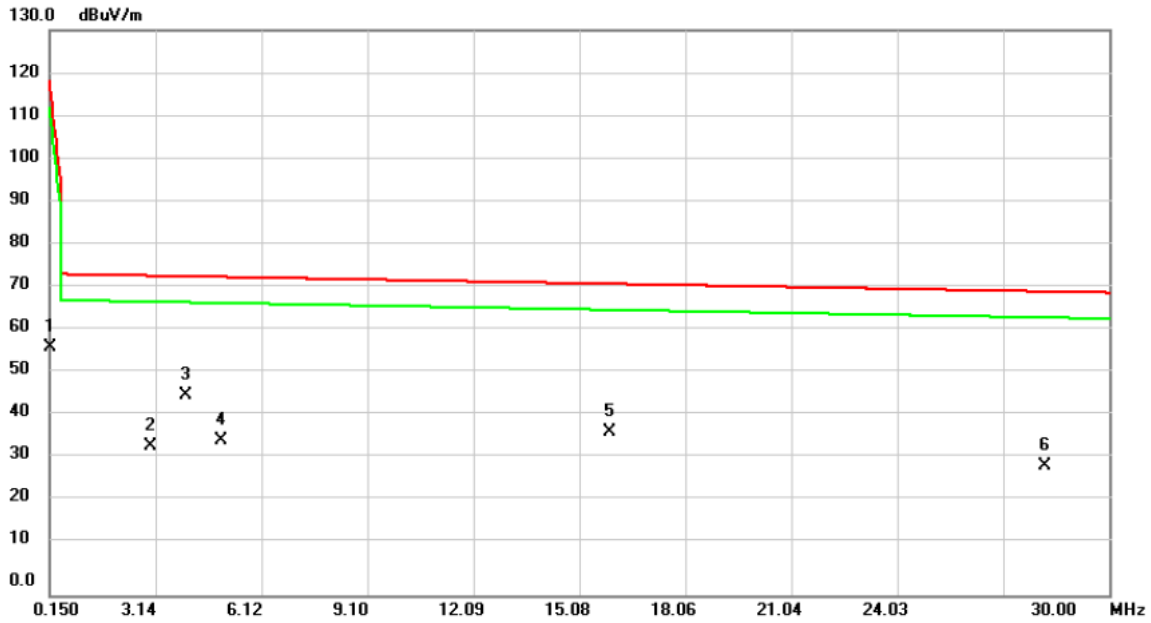

No. Mk.	Freq. MHz	Reading Level dBuV	Correct Factor dB	Measurement dBuV/m	Limit dBuV/m	Margin dB	Detector	Comment
1	0.1500	43.24	13.75	56.99	118.34	-61.35	QP	
2	2.9857	37.24	-3.11	34.13	73.44	-39.31	QP	
3 *	4.0007	49.29	-3.34	45.95	73.29	-27.34	QP	
4	4.9856	39.15	-3.55	35.60	73.15	-37.55	QP	
5	15.9108	41.74	-4.26	37.48	71.57	-34.09	QP	
6	28.1791	35.52	-5.73	29.79	69.80	-40.01	QP	

REMARKS:

- (1) Measurement Value = Reading Level + Correct Factor.
- (2) Margin Level = Measurement Value - Limit Value.

Test Mode	Transmit 13.56MHz	Tested Date	2019/11/12
Test Voltage	AC 120V/60Hz	Azimuth Angle	0°

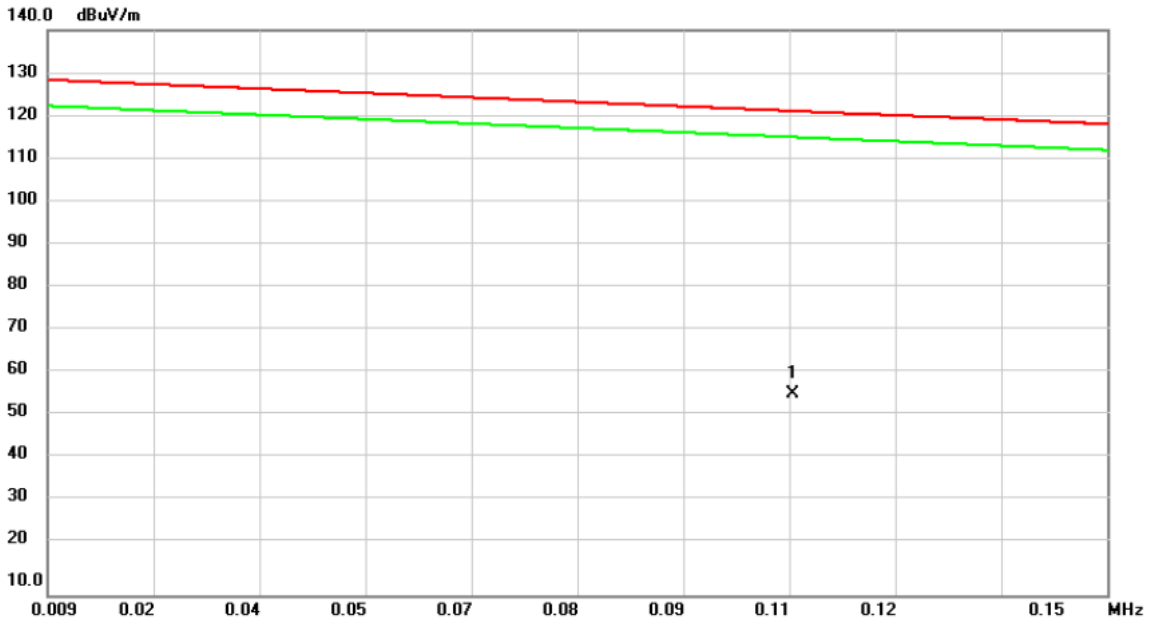

No.	Mk.	Freq.	Reading Level	Correct Factor	Measurement	Limit	Margin	Detector	Comment
		MHz	dBuV	dB	dBuV/m	dBuV/m	dB		
1	*	0.1082	40.31	16.13	56.44	121.35	-64.91	AVG	

REMARKS:

- (1) Measurement Value = Reading Level + Correct Factor.
- (2) Margin Level = Measurement Value - Limit Value.

Test Mode	Transmit 13.56MHz	Tested Date	2019/11/12
Test Voltage	AC 120V/60Hz	Azimuth Angle	0°

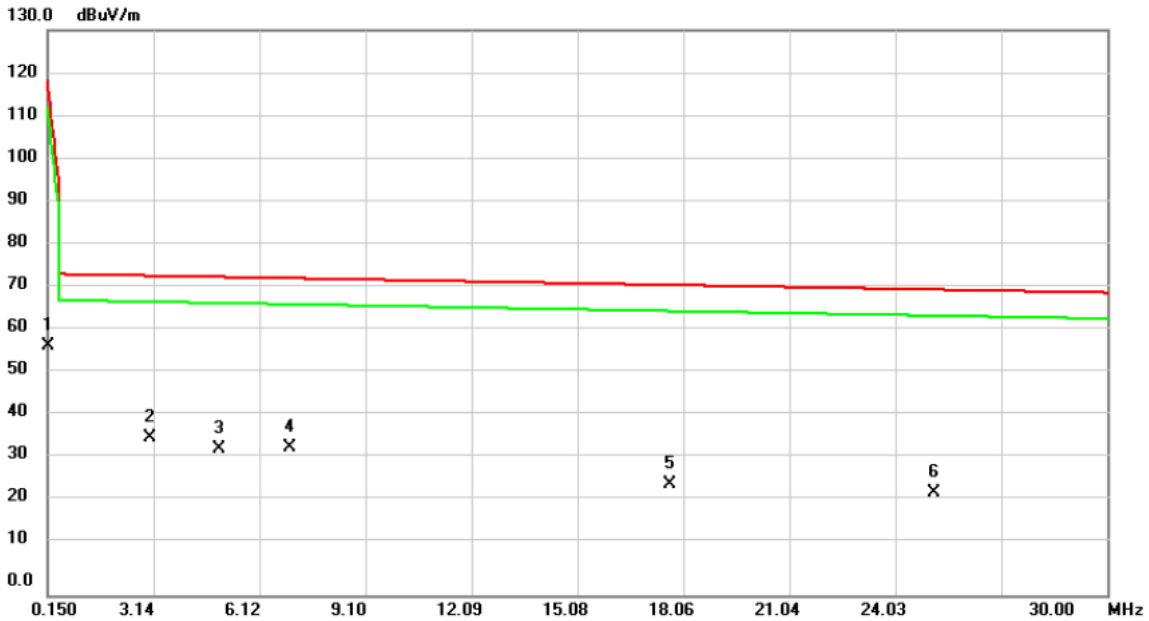

No.	Mk.	Freq. MHz	Reading Level dBuV	Correct Factor dB	Measure- ment dBuV/m	Limit dBuV/m	Margin dB	Detector	Comment
1		0.1500	43.76	13.75	57.51	118.34	-60.83	QP	
2	*	3.0156	39.48	-3.12	36.36	73.44	-37.08	QP	
3		4.9856	37.06	-3.55	33.51	73.15	-39.64	QP	
4		6.9856	37.65	-3.64	34.01	72.86	-38.85	QP	
5		17.7018	30.30	-4.95	25.35	71.32	-45.97	QP	
6		25.1345	31.17	-7.51	23.66	70.24	-46.58	QP	

REMARKS:

- (1) Measurement Value = Reading Level + Correct Factor.
- (2) Margin Level = Measurement Value - Limit Value.

APPENDIX C RADIATED EMISSIONS - 30 MHZ TO 1 GHZ

Test Mode	Transmit 13.56MHz	Tested Date	2019/11/12
Test Voltage	AC 120V/60Hz	Polarization	Vertical

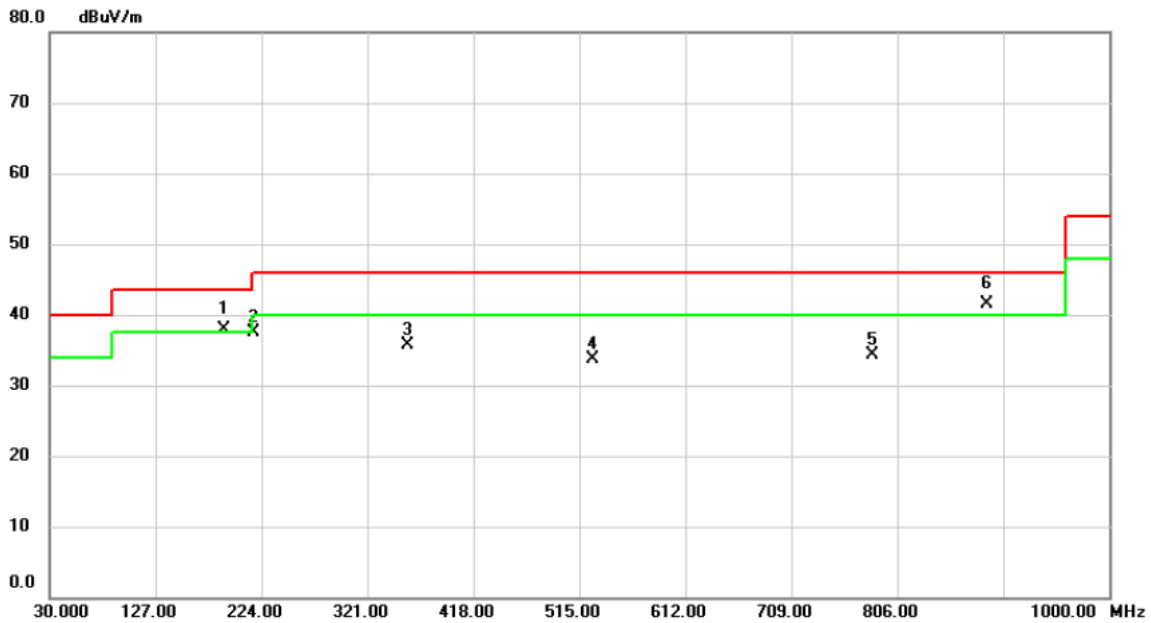

No.	Mk.	Freq. MHz	Reading Level dBuV	Correct Factor dB	Measure- ment dBuV/m	Limit dBuV/m	Margin dB	Detector	Comment
1	!	189.0800	51.57	-13.65	37.92	43.50	-5.58	QP	
2		216.2400	52.25	-14.80	37.45	46.00	-8.55	peak	
3		357.8600	45.20	-9.57	35.63	46.00	-10.37	peak	
4		526.6400	39.35	-5.68	33.67	46.00	-12.33	peak	
5		782.7200	35.27	-1.01	34.26	46.00	-11.74	peak	
6	*	888.4500	41.32	0.16	41.48	46.00	-4.52	QP	

REMARKS:

- (1) Measurement Value = Reading Level + Correct Factor.
- (2) Margin Level = Measurement Value - Limit Value.

Test Mode	Transmit 13.56MHz	Tested Date	2019/11/12
Test Voltage	AC 120V/60Hz	Polarization	Horizontal

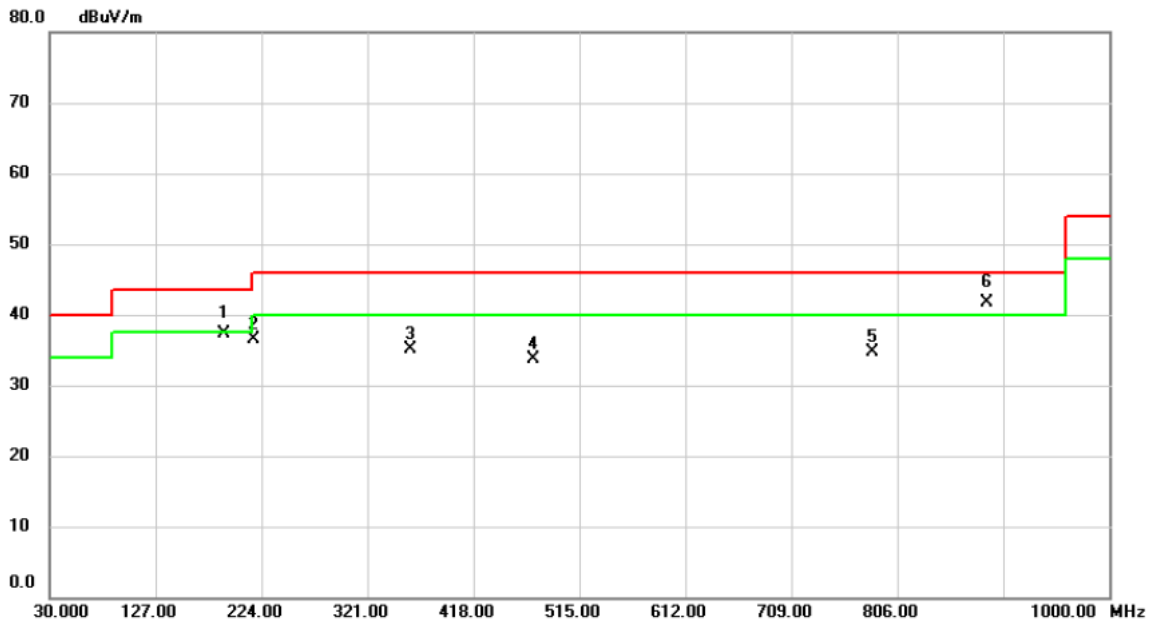

No. Mk.	Freq. MHz	Reading Level dBuV	Correct Factor dB	Measurement dBuV/m	Limit dBuV/m	Margin dB	Detector	Comment
1	189.0800	50.86	-13.65	37.21	43.50	-6.29	QP	
2	216.2400	51.21	-14.80	36.41	46.00	-9.59	peak	
3	360.7700	44.56	-9.48	35.08	46.00	-10.92	peak	
4	472.3200	40.46	-6.66	33.80	46.00	-12.20	peak	
5	782.7200	35.77	-1.01	34.76	46.00	-11.24	peak	
6 *	888.4500	41.61	0.16	41.77	46.00	-4.23	QP	

REMARKS:

- (1) Measurement Value = Reading Level + Correct Factor.
- (2) Margin Level = Measurement Value - Limit Value.

APPENDIX D RADIATED EMISSIONS - FCC PART 15.225

Test Mode	Transmit 13.56MHz	Tested Date	2019/11/12
Test Voltage	AC 120V/60Hz	Polarization	Vertical

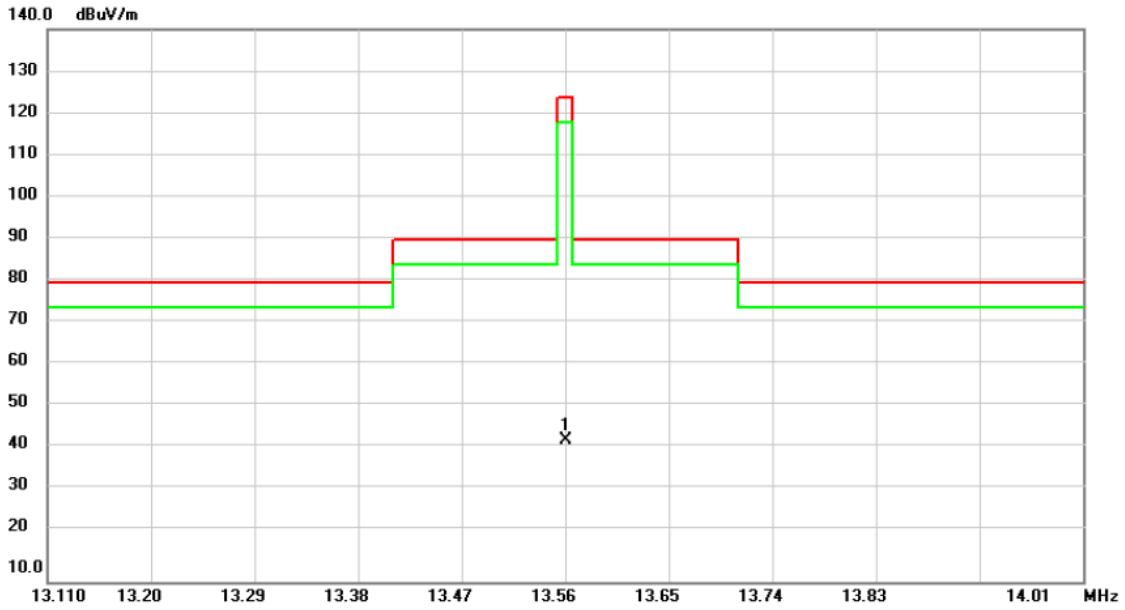

No.	Mk.	Freq.	Reading Level	Correct Factor	Measurement	Limit	Margin	Detector	Comment
		MHz	dBuV	dB	dBuV/m	dBuV/m	dB		
1	*	13.5600	47.18	-3.94	43.24	123.99	-80.75	peak	

REMARKS:

- (1) Measurement Value = Reading Level + Correct Factor.
- (2) Margin Level = Measurement Value - Limit Value.

Test Mode	Transmit 13.56MHz	Tested Date	2019/11/12
Test Voltage	AC 120V/60Hz	Polarization	Horizontal

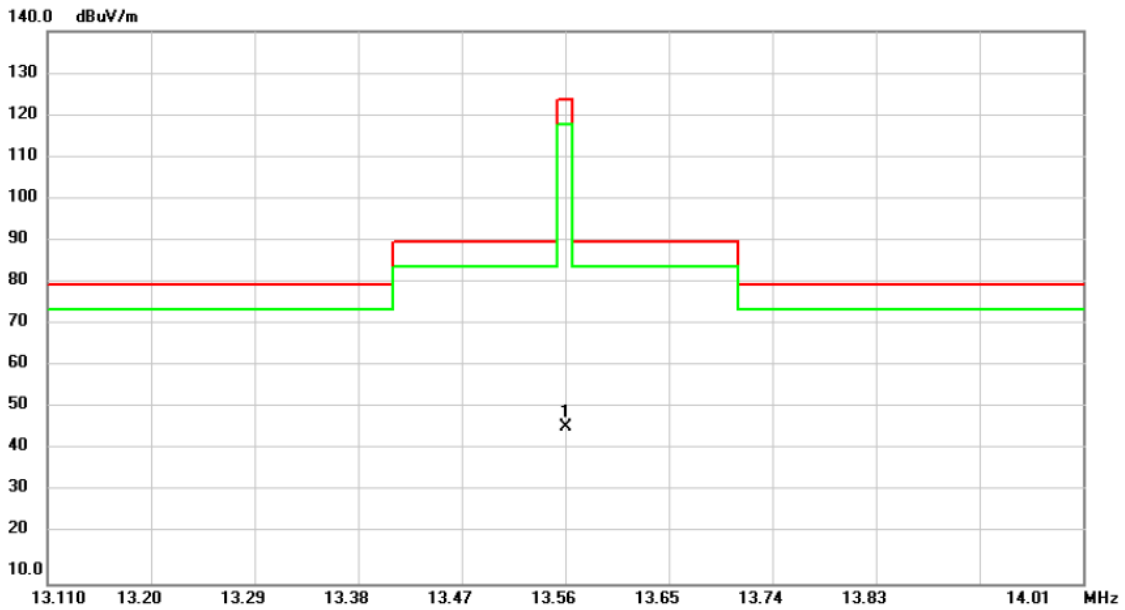

No.	Mk.	Freq.	Reading Level	Correct Factor	Measurement	Limit	Margin	Detector	Comment
		MHz	dBuV	dB	dBuV/m	dBuV/m	dB		
1	*	13.5600	50.80	-3.94	46.86	123.99	-77.13	peak	

REMARKS:

- (1) Measurement Value = Reading Level + Correct Factor.
- (2) Margin Level = Measurement Value - Limit Value.

APPENDIX E FREQUENCY STABILITY MEASUREMENT

Test Mode	Transmit 13.56MHz	Tested Date	2019/11/12
Test Voltage	AC 120V/60Hz		

Condition			Frequency Error (ppm)								Limit (ppm)	Result
Temperature	Modulation Mode	Test Freq.	0 min	2 min	5 min	10 min	0 min	2 min	5 min	10 min		
Normal												
T _{20°C} Vmax	CW	13.56	13.559600	13.559600	13.559600	13.559600	-29.50	-29.50	-29.50	-29.50	100	Pass
T _{20°C} Vmin	CW	13.56	13.559600	13.559600	13.559600	13.559600	-29.50	-29.50	-29.50	-29.50		Pass
Extreme												
T _{85°C} Vnom	CW	13.56	13.559560	13.559560	13.559560	13.559560	-32.45	-32.45	-32.45	-32.45	100	Pass
T _{80°C} Vnom	CW	13.56	13.559520	13.559520	13.559520	13.559520	-35.40	-35.40	-35.40	-35.40		Pass
T _{70°C} Vnom	CW	13.56	13.559520	13.559520	13.559520	13.559520	-35.40	-35.40	-35.40	-35.40		Pass
T _{60°C} Vnom	CW	13.56	13.559560	13.559560	13.559560	13.559560	-32.45	-32.45	-32.45	-32.45		Pass
T _{50°C} Vnom	CW	13.56	13.559600	13.559600	13.559600	13.559600	-29.50	-29.50	-29.50	-29.50		Pass
T _{40°C} Vnom	CW	13.56	13.559560	13.559560	13.559560	13.559560	-32.45	-32.45	-32.45	-32.45		Pass
T _{30°C} Vnom	CW	13.56	13.559520	13.559520	13.559520	13.559520	-35.40	-35.40	-35.40	-35.40		Pass
T _{20°C} Vnom	CW	13.56	13.559520	13.559520	13.559520	13.559520	-35.40	-35.40	-35.40	-35.40		Pass
T _{10°C} Vnom	CW	13.56	13.559560	13.559560	13.559560	13.559560	-32.45	-32.45	-32.45	-32.45		Pass
T _{0°C} Vnom	CW	13.56	13.559600	13.559600	13.559600	13.559600	-29.50	-29.50	-29.50	-29.50		Pass

NOTE: 0.01 % = 100 ppm.

APPENDIX F 20 DB BANDWIDTH

Test Mode	Transmit 13.56MHz	Tested Date	2019/11/12
Test Voltage	AC 120V/60Hz		

Frequency (MHz)	20 dB Bandwidth (kHz)	Operated Frequency Range (MHz)	Designated Frequency Band (MHz)	Result
13.56	2.64	0.002	0.014	Complied

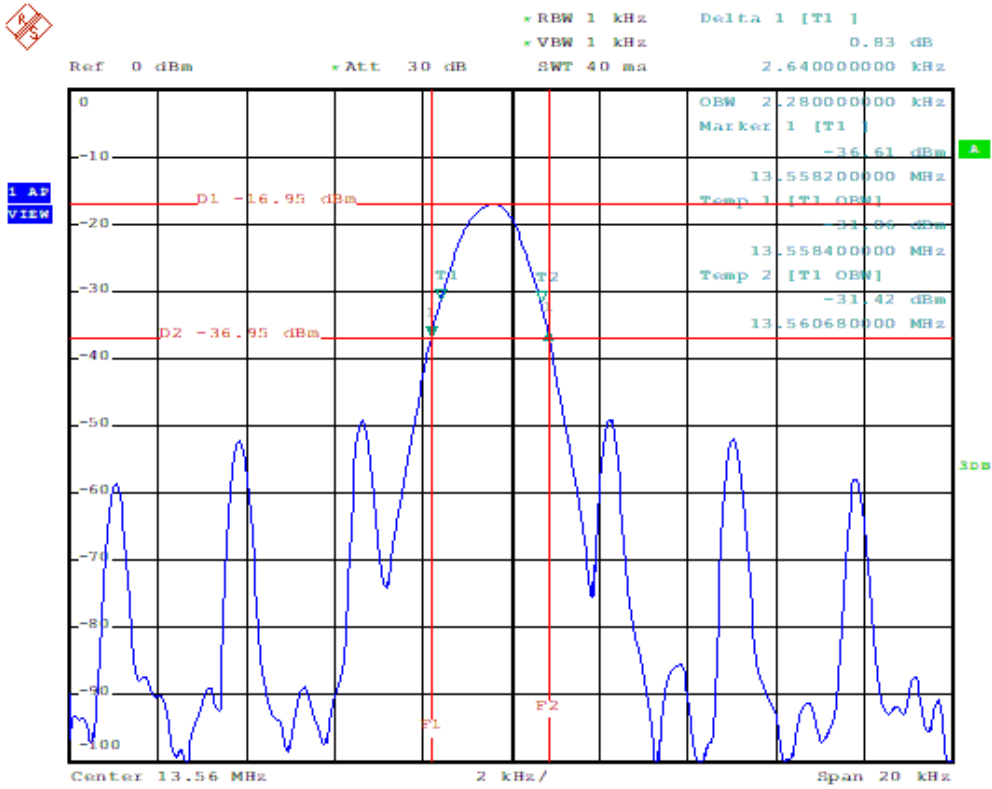

End of Test Report