

FCC RADIO TEST REPORT

FCC ID: 2AB9SM77

Product : Bluetooth Speaker

Trade Name : Jonter , SoundPal, MUSIC BOX,MERKURY,JONTER

Model Name : M77, SoundPal , M405, MI-SPB62,M58

Prepared for

Shenzhen Jonter Digital Co.,Ltd

3F/4B, Hezhou Jinfo Industrial Park, Hezhou, Xixiang Street, Baoan District, Shenzhen, Guangdong,
China

Prepared by

DongGuan Precise Testing Service Co.,Ltd.

Building D, Baoding Technology Park, Guangming Road 2, Guangming Community, Dongcheng
District, Dongguan, Guangdong, China

TEST RESULT CERTIFICATION

Applicant's name Shenzhen Jonter Digital Co.,Ltd
Address 3F/4B, Hezhou Jinfo Industrial Park, Hezhou, Xixiang Street, Baoan District, Shenzhen, Guangdong, China

Manufacture's Name... Shenzhen Jonter Digital Co.,Ltd
Address 3F/4B, Hezhou Jinfo Industrial Park, Hezhou, Xixiang Street, Baoan District, Shenzhen, Guangdong, China

Product description

Product name Bluetooth Speaker
Model and/or type
reference M77, SoundPal , M405, MI-SPB62,M58

Standards FCC Part15.247

Test procedure ANSI C63.10-2013

This device described above has been tested by PTS, and the test results show that the equipment under test (EUT) is in compliance with the FCC requirements. And it is applicable only to the tested sample identified in the report.

This report shall not be reproduced except in full, without the written approval of PTS, this document may be altered or revised by PTS, personal only, and shall be noted in the revision of the document.

Date of Test

Date (s) of performance of tests Jul. 14, 2015 ~ Jul. 22, 2015

Date of Issue..... Jul. 22, 2015

Test Result..... **Pass**

Prepared by :



Juan Zeng /Tester

Reviewer :



Tom Zhang/Supervisor

Approved & Authorized Signer :

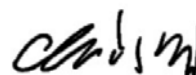

Chris Du/Manager

| Table of Contents | | Page |
|---|--|-------------|
| 1 . SUMMARY OF TEST RESULTS | | 5 |
| 1.1 TEST FACILITY | | 6 |
| 1.2 MEASUREMENT UNCERTAINTY | | 6 |
| 2 . GENERAL INFORMATION | | 7 |
| 2.1 GENERAL DESCRIPTION OF EUT | | 7 |
| 2.2 DESCRIPTION OF TEST MODES | | 9 |
| 2.3 TABLE OF PARAMETERS OF TEXT SOFTWARE SETTING | | 9 |
| 2.4 BLOCK DIGRAM SHOWING THE CONFIGURATION OF SYSTEM TESTED | | 10 |
| 2.5 DESCRIPTION OF SUPPORT UNITS(CONDUCTED MODE) | | 11 |
| 2.6 EQUIPMENTS LIST FOR ALL TEST ITEMS | | 12 |
| 3 . EMC EMISSION TEST | | 13 |
| 3.1 CONDUCTED EMISSION MEASUREMENT | | 13 |
| 3.1.1 POWER LINE CONDUCTED EMISSION LIMITS | | 13 |
| 3.1.2 TEST PROCEDURE | | 14 |
| 3.1.3 DEVIATION FROM TEST STANDARD | | 14 |
| 3.1.4 TEST SETUP | | 14 |
| 3.1.5 EUT OPERATING CONDITIONS | | 14 |
| 3.1.6 TEST RESULTS | | 15 |
| 3.2 RADIATED EMISSION MEASUREMENT | | 17 |
| 3.2.1 RADIATED EMISSION LIMITS | | 17 |
| 3.2.2 TEST PROCEDURE | | 18 |
| 3.2.3 DEVIATION FROM TEST STANDARD | | 18 |
| 3.2.4 TEST SETUP | | 19 |
| 3.2.5 EUT OPERATING CONDITIONS | | 20 |
| 3.2.6 TEST RESULTS | | 21 |
| 4 . NUMBER OF HOPPING CHANNEL | | 27 |
| 4.1 APPLIED PROCEDURES / LIMIT | | 27 |
| 4.1.1 TEST PROCEDURE | | 27 |
| 4.1.2 DEVIATION FROM STANDARD | | 27 |
| 4.1.3 TEST SETUP | | 27 |
| 4.1.4 EUT OPERATION CONDITIONS | | 27 |
| 4.1.5 TEST RESULTS | | 28 |
| 5 . AVERAGE TIME OF OCCUPANCY | | 29 |
| 5.1 APPLIED PROCEDURES / LIMIT | | 29 |
| 5.1.1 TEST PROCEDURE | | 29 |
| 5.1.2 DEVIATION FROM STANDARD | | 29 |

| Table of Contents | | Page |
|---|--|-------------|
| 5.1.3 TEST SETUP | | 30 |
| 5.1.4 EUT OPERATION CONDITIONS | | 30 |
| 5.1.5 TEST RESULTS | | 31 |
| 6 . HOPPING CHANNEL SEPARATION MEASUREMENT | | 37 |
| 6.1 APPLIED PROCEDURES / LIMIT | | 37 |
| 6.1.1 TEST PROCEDURE | | 37 |
| 6.1.2 DEVIATION FROM STANDARD | | 37 |
| 6.1.3 TEST SETUP | | 37 |
| 6.1.4 EUT OPERATION CONDITIONS | | 37 |
| 6.1.5 TEST RESULTS | | 38 |
| 7 . BANDWIDTH TEST | | 44 |
| 7.1 APPLIED PROCEDURES / LIMIT | | 44 |
| 7.1.1 TEST PROCEDURE | | 44 |
| 7.1.2 DEVIATION FROM STANDARD | | 44 |
| 7.1.3 TEST SETUP | | 44 |
| 7.1.4 EUT OPERATION CONDITIONS | | 44 |
| 7.1.5 TEST RESULTS | | 45 |
| 8 . PEAK OUTPUT POWER TEST | | 51 |
| 8.1 APPLIED PROCEDURES / LIMIT | | 51 |
| 8.1.1 TEST PROCEDURE | | 51 |
| 8.1.2 DEVIATION FROM STANDARD | | 51 |
| 8.1.3 TEST SETUP | | 51 |
| 8.1.4 EUT OPERATION CONDITIONS | | 51 |
| 8.1.5 TEST RESULTS | | 52 |
| 9 . 100 KHZ BANDWIDTH OF FREQUENCY BAND EDGE | | 57 |
| 9.1 DEVIATION FROM STANDARD | | 57 |
| 9.2 TEST SETUP | | 57 |
| 9.3 EUT OPERATION CONDITIONS | | 57 |
| 9.4 TEST RESULTS | | 58 |
| 10 . ANTENNA REQUIREMENT | | 62 |
| 10.1 STANDARD REQUIREMENT | | 62 |
| 10.2 EUT ANTENNA | | 62 |
| 11 . EUT TEST PHOTO | | 63 |

1. SUMMARY OF TEST RESULTS

Test procedures according to the technical standards:

| FCC Part15 (15.247) , Subpart C | | | |
|--|-----------------------------|----------|--------|
| Standard Section | Test Item | Judgment | Remark |
| 15.207 | Conducted Emission | PASS | |
| 15.247(a)(1) | Hopping Channel Separation | PASS | |
| 15.247(b)(1) | Peak Output Power | PASS | |
| 15.247(c) | Radiated Spurious Emission | PASS | |
| 15.247(a)(iii) | Number of Hopping Frequency | PASS | |
| 15.247(a)(iii) | Dwell Time | PASS | |
| 15.247(a)(1) | Bandwidth | PASS | |
| 15.205 | Band Edge Emission | PASS | |
| 15.203 | Antenna Requirement | PASS | |

NOTE:

(1) "N/A" denotes test is not applicable in this Test Report

1.1 TEST FACILITY

Dongguan Precise Testing Service Co., Ltd.

Add. : Building D, Baoding Technology Park, Guangming Road2, Dongcheng District, Dongguan, Guangdong, China

FCC Registration No.: 371540

1.2 MEASUREMENT UNCERTAINTY

The reported uncertainty of measurement $y \pm U$, where expanded uncertainty U is based on a standard uncertainty multiplied by a coverage factor of $k=2$, providing a level of confidence of approximately **95** %.

| No. | Item | Uncertainty |
|-----|-------------------------------|-------------------------|
| 1 | Conducted Emission Test | $\pm 1.38\text{dB}$ |
| 2 | RF power, conducted | $\pm 0.16\text{dB}$ |
| 3 | Spurious emissions, conducted | $\pm 0.21\text{dB}$ |
| 4 | All emissions, radiated (<1G) | $\pm 4.68\text{dB}$ |
| 5 | All emissions, radiated (>1G) | $\pm 4.89\text{dB}$ |
| 6 | Temperature | $\pm 0.5^\circ\text{C}$ |
| 7 | Humidity | $\pm 2\%$ |

2. GENERAL INFORMATION

2.1 GENERAL DESCRIPTION OF EUT

| | | |
|------------------------|--|--|
| Equipment | Bluetooth Speaker | |
| Trade Name | Jonter | |
| Model Name | M77 | |
| Serial Model | SoundPal, M405, MI-SPB62,M58 | |
| Model Difference | All the same,Only model name is different | |
| Product Description | The EUT is a Bluetooth Speaker | |
| | Operation Frequency: | 2402~2480 MHz |
| | Modulation Type: | BT(1Mbps): GFSK BT EDR(2Mbps): $\pi/4$ -DQPSK BT EDR(3Mbps): 8-DPSK |
| | Bit Rate of Transmitter | 1Mbps/2Mbps/3Mbps |
| | Number Of Channel | 79 CH |
| | Antenna Designation: | Please see Note 3. |
| | Output Power(Conducted): | BT(1Mbps): 1.317dBm BT EDR(2Mbps):-1.757dBm BT EDR(3Mbps):-4.339 dBm |
| | Based on the application, features, or specification exhibited in User's Manual, the EUT is considered as an ITE/Computing Device. More details of EUT technical specification, please refer to the User's Manual. | |
| Channel List | Please refer to the Note 2. | |
| Adapter | N/A | |
| Battery | Rated Voltage:3.7V | |
| Connecting I/O Port(s) | Please refer to the User's Manual | |

Note:

1. For a more detailed features description, please refer to the manufacturer's specifications or the User's Manual.

2.

| Channel List | | | | | |
|--------------|-----------------|---------|-----------------|---------|-----------------|
| Channel | Frequency (MHz) | Channel | Frequency (MHz) | Channel | Frequency (MHz) |
| 00 | 2402 | 27 | 2429 | 54 | 2456 |
| 01 | 2403 | 28 | 2430 | 55 | 2457 |
| 02 | 2404 | 29 | 2431 | 56 | 2458 |
| 03 | 2405 | 30 | 2432 | 57 | 2459 |
| 04 | 2406 | 31 | 2433 | 58 | 2460 |
| 05 | 2407 | 32 | 2434 | 59 | 2461 |
| 06 | 2408 | 33 | 2435 | 60 | 2462 |
| 07 | 2409 | 34 | 2436 | 61 | 2463 |
| 08 | 2410 | 35 | 2437 | 62 | 2464 |
| 09 | 2411 | 36 | 2438 | 63 | 2465 |
| 10 | 2412 | 37 | 2439 | 64 | 2466 |
| 11 | 2413 | 38 | 2440 | 65 | 2467 |
| 12 | 2414 | 39 | 2441 | 66 | 2468 |
| 13 | 2415 | 40 | 2442 | 67 | 2469 |
| 14 | 2416 | 41 | 2443 | 68 | 2470 |
| 15 | 2417 | 42 | 2444 | 69 | 2471 |
| 16 | 2418 | 43 | 2445 | 70 | 2472 |
| 17 | 2419 | 44 | 2446 | 71 | 2473 |
| 18 | 2420 | 45 | 2447 | 72 | 2474 |
| 19 | 2421 | 46 | 2448 | 73 | 2475 |
| 20 | 2422 | 47 | 2449 | 74 | 2476 |
| 21 | 2423 | 48 | 2450 | 75 | 2477 |
| 22 | 2424 | 49 | 2451 | 76 | 2478 |
| 23 | 2425 | 50 | 2452 | 77 | 2479 |
| 24 | 2426 | 51 | 2453 | 78 | 2480 |
| 25 | 2427 | 52 | 2454 | | |
| 26 | 2428 | 53 | 2455 | | |

3.

Table for Filed Antenna

| Ant | Brand | Model Name | Antenna Type | Connector | Gain (dBi) | NOTE |
|-----|-------|------------|--------------|-----------|------------|------------|
| 1 | N/A | N/A | PCB Antenna | N/A | 1.4 | BT Antenna |

2.2 DESCRIPTION OF TEST MODES

To investigate the maximum EMI emission characteristics generates from EUT, the test system was pre-scanning tested base on the consideration of following EUT operation mode or test configuration mode which possible have effect on EMI emission level. Each of these EUT operation mode(s) or test configuration mode(s) mentioned above was evaluated respectively.

| Pretest Mode | Description |
|--------------|-------------|
| Mode 1 | CH00 |
| Mode 2 | CH39 |
| Mode 3 | CH78 |
| Mode 4 | Normal Link |

| For Conducted Emission | |
|------------------------|-------------|
| Final Test Mode | Description |
| Mode 4 | Normal Link |

| For Radiated Emission | |
|-----------------------|-------------|
| Final Test Mode | Description |
| Mode 1 | CH00 |
| Mode 2 | CH39 |
| Mode 3 | CH78 |

Note:

- (1) The measurements are performed at the highest, middle, lowest available channels.
- (2) The EUT use new battery.
- (3)The data rate was set in 1Mbps for radiated emission due to the highest RF output power.

2.3 TABLE OF PARAMETERS OF TEXT SOFTWARE SETTING

During testing channel & power controlling software provided by the customer was used to control the operating channel as well as the output power level. The RF output power selection is for the setting of RF output power expected by the customer and is going to be fixed on the firmware of the final end product power parameters of FHSS

| Test software Version | Test program: Broadcom | | |
|-----------------------|------------------------|----------|----------|
| Frequency | 2402 MHz | 2441 MHz | 2480 MHz |
| Parameters(1/2/3Mbps) | DEF | DEF | DEF |

2.4 BLOCK DIGRAM SHOWING THE CONFIGURATION OF SYSTEM TESTED

Conducted Emission:

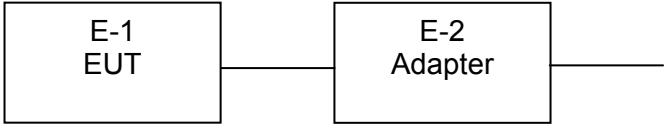

Radiated Spurious Emission:

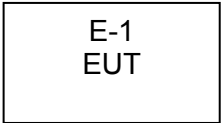

2.5 DESCRIPTION OF SUPPORT UNITS(CONDUCTED MODE)

The EUT has been tested as an independent unit together with other necessary accessories or support units. The following support units or accessories were used to form a representative test configuration during the tests.

| Item | Equipment | Mfr/Brand | Model/Type No. | Series No. | Note |
|------|-------------------|-----------|----------------|------------|------|
| E-1 | Bluetooth Speaker | Jonter | M77 | N/A | EUT |
| E-2 | Adapter | N/A | N/A | N/A | |
| | | | | | |

| Item | Shielded Type | Ferrite Core | Length | Note |
|------|---------------|--------------|--------|------|
| | | | | |
| | | | | |
| | | | | |
| | | | | |

Note:

- (1) The support equipment was authorized by Declaration of Confirmation.
- (2) For detachable type I/O cable should be specified the length in cm in 『Length』 column.
- (3) “YES” is means “shielded” “with core”; “NO” is means “unshielded” “without core”.

2.6 EQUIPMENTS LIST FOR ALL TEST ITEMS

Radiation Test equipment

| Item | Kind of Equipment | Manufacturer | Type No. | Serial No. | Last calibration | Calibrated until | Calibration period |
|------|--------------------|--------------|-------------|--------------|------------------|------------------|--------------------|
| 1 | Spectrum Analyzer | Agilent | E4407B | MY45108040 | 2014.07.06 | 2015.07.05 | 1 year |
| 2 | Test Receiver | R&S | ESPI | 101318 | 2015.06.07 | 2016.06.06 | 1 year |
| 3 | Bilog Antenna | TESEQ | CBL6111D | 31216 | 2015.07.06 | 2016.07.05 | 1 year |
| 4 | 50Ω Coaxial Switch | Anritsu | MP59B | 6200264416 | 2015.06.07 | 2016.06.06 | 1 year |
| 5 | Spectrum Analyzer | ADVANTEST | R3132 | 150900201 | 2015.06.07 | 2016.06.06 | 1 year |
| 6 | Horn Antenna | EM | EM-AH-10180 | 2011071402 | 2015.07.06 | 2016.07.05 | 1 year |
| 7 | Horn Ant | Schwarzbeck | BBHA 9170 | 9170-181 | 2015.07.06 | 2016.07.05 | 1 year |
| 8 | Amplifier | EM | EM-30180 | 060538 | 2014.12.22 | 2015.12.21 | 1 year |
| 9 | Loop Antenna | ARA | PLA-1030/B | 1029 | 2015.06.08 | 2016.06.07 | 1 year |
| 10 | Power Meter | R&S | NRVS | 100696 | 2015.07.06 | 2016.07.05 | 1 year |
| 11 | Power Sensor | R&S | URV5-Z4 | 0395.1619.05 | 2015.07.06 | 2016.07.05 | 1 year |

Conduction Test equipment

| Item | Kind of Equipment | Manufacturer | Type No. | Serial No. | Last calibration | Calibrated until | Calibration period |
|------|-----------------------|--------------|----------|------------|------------------|------------------|--------------------|
| 1 | Test Receiver | R&S | ESCI | 101160 | 2015.06.06 | 2016.06.05 | 1 year |
| 2 | LISN | R&S | ENV216 | 101313 | 2014.08.24 | 2015.08.23 | 1 year |
| 3 | LISN | EMCO | 3816/2 | 00042990 | 2014.08.24 | 2015.08.23 | 1 year |
| 4 | 50Ω Coaxial Switch | Anritsu | MP59B | 6200264417 | 2015.06.07 | 2016.06.06 | 1 year |
| 5 | Passive Voltage Probe | R&S | ESH2-Z3 | 100196 | 2015.06.07 | 2016.06.06 | 1 year |
| 6 | Absorbing clamp | R&S | MOS-21 | 100423 | 2015.06.08 | 2016.06.07 | 1 year |

3. EMC EMISSION TEST

3.1 CONDUCTED EMISSION MEASUREMENT

3.1.1 POWER LINE CONDUCTED EMISSION Limits (Frequency Range 150KHz-30MHz)

| FREQUENCY (MHz) | Class A (dBuV) | | Class B (dBuV) | | Standard |
|-----------------|----------------|---------|----------------|-----------|----------|
| | Quasi-peak | Average | Quasi-peak | Average | |
| 0.15 -0.5 | 79.00 | 66.00 | 66 - 56 * | 56 - 46 * | CISPR |
| 0.50 -5.0 | 73.00 | 60.00 | 56.00 | 46.00 | CISPR |
| 5.0 -30.0 | 73.00 | 60.00 | 60.00 | 50.00 | CISPR |

| | | | | | |
|-----------|-------|-------|-----------|-----------|-----|
| 0.15 -0.5 | 79.00 | 66.00 | 66 - 56 * | 56 - 46 * | FCC |
| 0.50 -5.0 | 73.00 | 60.00 | 56.00 | 46.00 | FCC |
| 5.0 -30.0 | 73.00 | 60.00 | 60.00 | 50.00 | FCC |

Note:

- (1) The tighter limit applies at the band edges.
- (2) The limit of " * " marked band means the limitation decreases linearly with the logarithm of the frequency in the range.

The following table is the setting of the receiver

| Receiver Parameters | Setting |
|---------------------|----------|
| Attenuation | 10 dB |
| Start Frequency | 0.15 MHz |
| Stop Frequency | 30 MHz |
| IF Bandwidth | 9 kHz |

3.1.2 TEST PROCEDURE

- The EUT was placed 0.8 meters from the horizontal ground plane with EUT being connected to the power mains through a line impedance stabilization network (LISN). All other support equipments powered from additional LISN(s). The LISN provide 50 Ohm/ 50uH of coupling impedance for the measuring instrument.
- Interconnecting cables that hang closer than 40 cm to the ground plane shall be folded back and forth in the center forming a bundle 30 to 40 cm long.
- I/O cables that are not connected to a peripheral shall be bundled in the center. The end of the cable may be terminated, if required, using the correct terminating impedance. The overall length shall not exceed 1 m.
- LISN at least 80 cm from nearest part of EUT chassis.
- For the actual test configuration, please refer to the related Item –EUT Test Photos.

3.1.3 DEVIATION FROM TEST STANDARD

No deviation

3.1.4 TEST SETUP

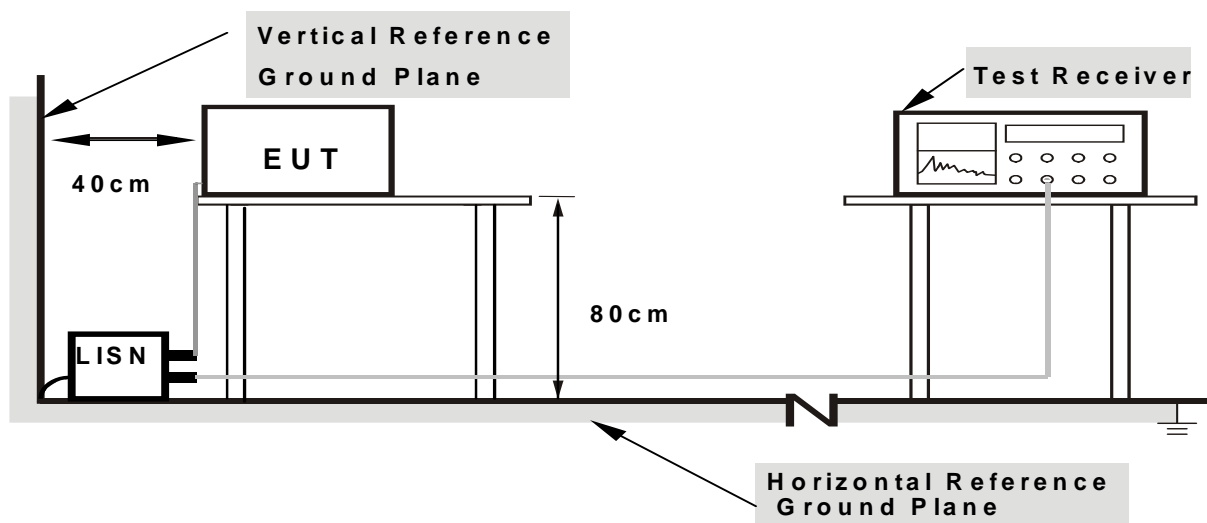

Note: 1. Support units were connected to second LISN.

2. Both of LISNs (AMN) are 80 cm from EUT and at least 80 cm from other units and other metal planes

3.1.5 EUT OPERATING CONDITIONS

The EUT was configured for testing in a typical fashion (as a customer would normally use it). The EUT has been programmed to continuously transmit during test. This operating condition was tested and used to collect the included data.

3.1.6 TEST RESULTS

| | | | |
|----------------|-------------------|---------------------|--------|
| EUT : | Bluetooth Speaker | Model Name : | M77 |
| Temperature : | 26 °C | Relative Humidity : | 54% |
| Pressure : | 1010hPa | Phase : | L |
| Test Voltage : | AC120V | Test Mode : | Mode 4 |

| Frequency (MHz) | Reading Level (dBμV) | Correct Factor (dB) | Measure-ment (dBμV) | Limits (dBμV) | Margin (dB) | Detector Type |
|-----------------|----------------------|---------------------|---------------------|---------------|-------------|---------------|
| 0.1780 | 48.19 | 9.79 | 57.98 | 64.57 | -6.59 | QP |
| 0.1780 | 40.28 | 9.79 | 50.07 | 54.57 | -4.50 | AVG |
| 3.9700 | 36.19 | 10.33 | 46.52 | 56.00 | -9.48 | QP |
| 4.0300 | 31.47 | 10.33 | 41.80 | 46.00 | -4.20 | AVG |

Remark:

1. All readings are Quasi-Peak and Average values.
2. Factor = Insertion Loss + Cable Loss.

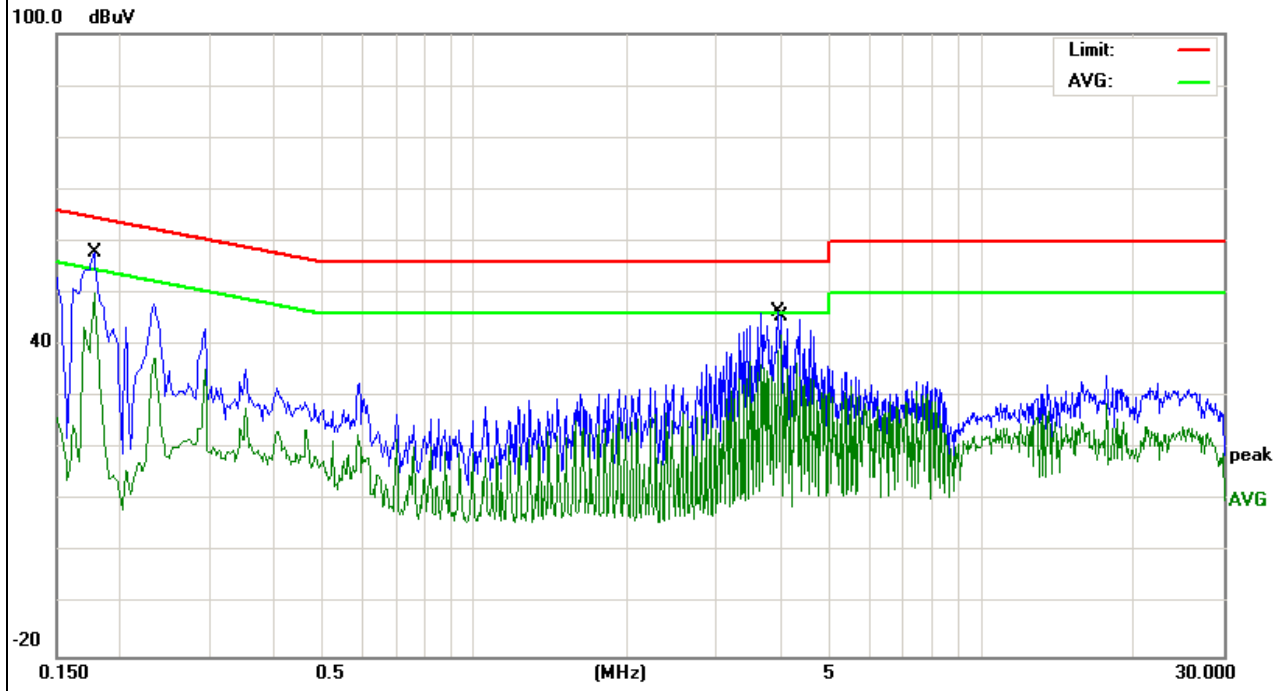

| | | | |
|----------------|-------------------|---------------------|--------|
| EUT : | Bluetooth Speaker | Model Name : | M77 |
| Temperature : | 26 °C | Relative Humidity : | 54% |
| Pressure : | 1010hPa | Phase : | N |
| Test Voltage : | AC120V | Test Mode : | Mode 4 |

| Frequency (MHz) | Reading Level (dBμV) | Correct Factor (dB) | Measure-ment (dBμV) | Limits (dBμV) | Margin (dB) | Detector Type |
|-----------------|----------------------|---------------------|---------------------|---------------|-------------|---------------|
| 0.1739 | 44.34 | 9.80 | 54.14 | 64.77 | -10.63 | QP |
| 0.1739 | 33.90 | 9.80 | 43.70 | 54.77 | -11.07 | AVG |
| 4.2579 | 32.24 | 10.35 | 42.59 | 56.00 | -13.41 | QP |
| 4.4939 | 25.71 | 10.36 | 36.07 | 46.00 | -9.93 | AVG |

Remark:

1. All readings are Quasi-Peak and Average values.
2. Factor = Insertion Loss + Cable Loss.

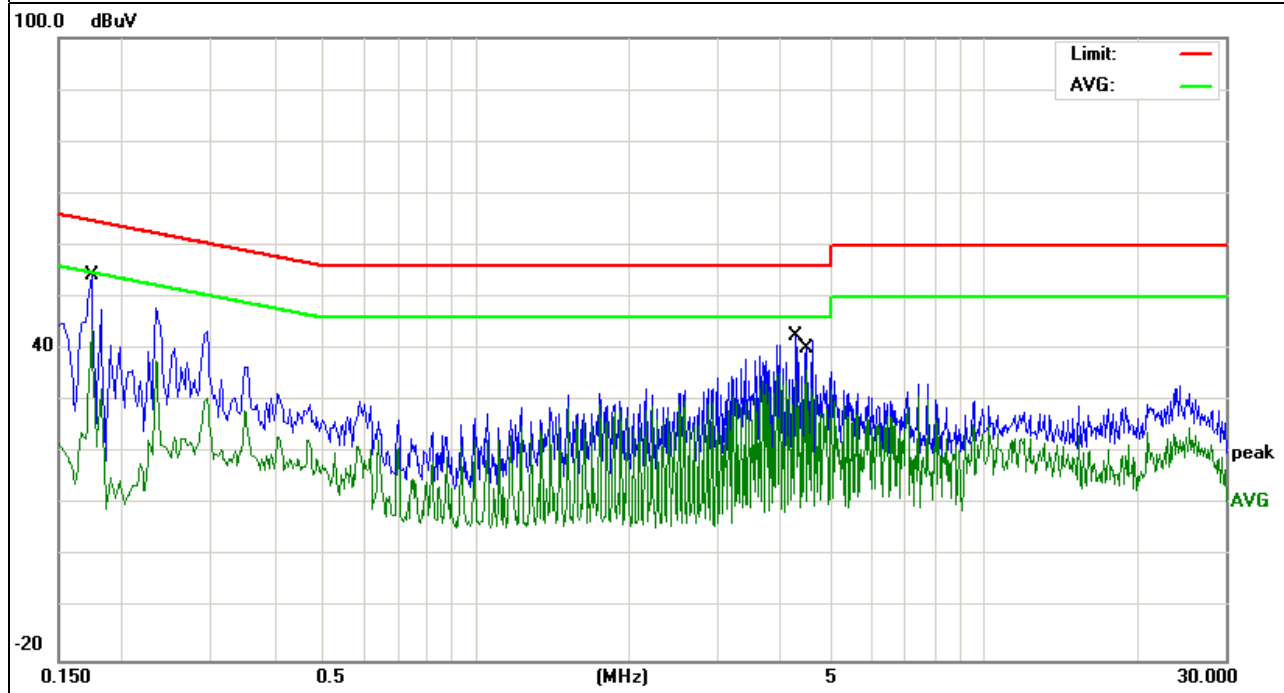

3.2 RADIATED EMISSION MEASUREMENT

3.2.1 RADIATED EMISSION LIMITS (Frequency Range 9kHz-1000MHz)

20dBc in any 100 kHz bandwidth outside the operating frequency band. In case the emission fall within the restricted band specified on 15.205(a), then the 15.209(a) limit in the table below has to be followed.

| Frequencies (MHz) | Field Strength (micorvolts/meter) | Measurement Distance (meters) |
|-------------------|-----------------------------------|-------------------------------|
| 0.009~0.490 | 2400/F(KHz) | 300 |
| 0.490~1.705 | 24000/F(KHz) | 30 |
| 1.705~30.0 | 30 | 30 |
| 30~88 | 100 | 3 |
| 88~216 | 150 | 3 |
| 216~960 | 200 | 3 |
| Above 960 | 500 | 3 |

LIMITS OF RADIATED EMISSION MEASUREMENT (Above 1000MHz)

| FREQUENCY (MHz) | Class A (dBuV/m) (at 3M) | | Class B (dBuV/m) (at 3M) | |
|-----------------|--------------------------|---------|--------------------------|---------|
| | PEAK | AVERAGE | PEAK | AVERAGE |
| Above 1000 | 80 | 60 | 74 | 54 |

Notes:

- (1) The limit for radiated test was performed according to FCC PART 15C.
- (2) The tighter limit applies at the band edges.
- (3) Emission level (dBuV/m)=20log Emission level (uV/m).

FREQUENCY RANGE OF RADIATED MEASUREMENT (For unintentional radiators)

| Highest frequency generated or Upper frequency of measurement used in the device or on which the device operates or tunes (MHz) | Range (MHz) |
|---|---|
| Below 1.705 | 30 |
| 1.705 – 108 | 1000 |
| 108 – 500 | 2000 |
| 500 – 1000 | 5000 |
| Above 1000 | 5 th harmonic of the highest frequency or 40 GHz, whichever is lower |

| Spectrum Parameter | Setting |
|---------------------------------------|--|
| Attenuation | Auto |
| Start Frequency | 1000 MHz |
| Stop Frequency | 10th carrier harmonic |
| RB / VB (emission in restricted band) | 1 MHz / 1 MHz for Peak, 1 MHz / 10Hz for Average |

| Receiver Parameter | Setting |
|------------------------|----------------------------------|
| Attenuation | Auto |
| Start ~ Stop Frequency | 9kHz~150kHz / RB 200Hz for QP |
| Start ~ Stop Frequency | 150kHz~30MHz / RB 9kHz for QP |
| Start ~ Stop Frequency | 30MHz~1000MHz / RB 120kHz for QP |

3.2.2 TEST PROCEDURE

- The measuring distance of at 3 m shall be used for measurements at frequency up to 1GHz. For frequencies above 1GHz, any suitable measuring distance may be used.
- The EUT was placed on the top of a rotating table 0.8 meters above the ground at a 3 meter open area test site. The table was rotated 360 degrees to determine the position of the highest radiation.
- The height of the equipment or of the substitution antenna shall be 0.8 m; the height of the test antenna shall vary between 1 m to 4 m. Both horizontal and vertical polarizations of the antenna are set to make the measurement.
- The initial step in collecting conducted emission data is a spectrum analyzer peak detector mode pre-scanning the measurement frequency range. Significant peaks are then marked and then Quasi Peak detector mode re-measured.
- If the Peak Mode measured value compliance with and lower than Quasi Peak Mode Limit, the EUT shall be deemed to meet QP Limits and then no additional QP Mode measurement performed.
- For the actual test configuration, please refer to the related Item –EUT Test Photos.

Note:

Both horizontal and vertical antenna polarities were tested and performed pretest to three orthogonal axis. The worst case emissions were reported

3.2.3 DEVIATION FROM TEST STANDARD

No deviation

3.2.4 TEST SETUP

(A) Radiated Emission Test-Up Frequency Below 30MHz

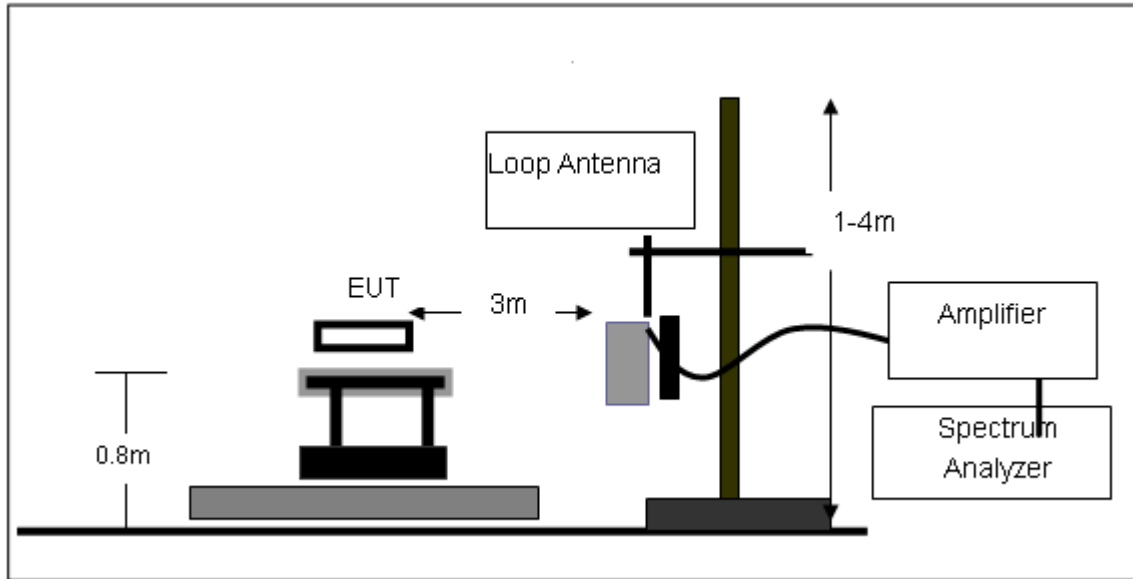

(B) Radiated Emission Test-Up Frequency 30MHz~1GHz

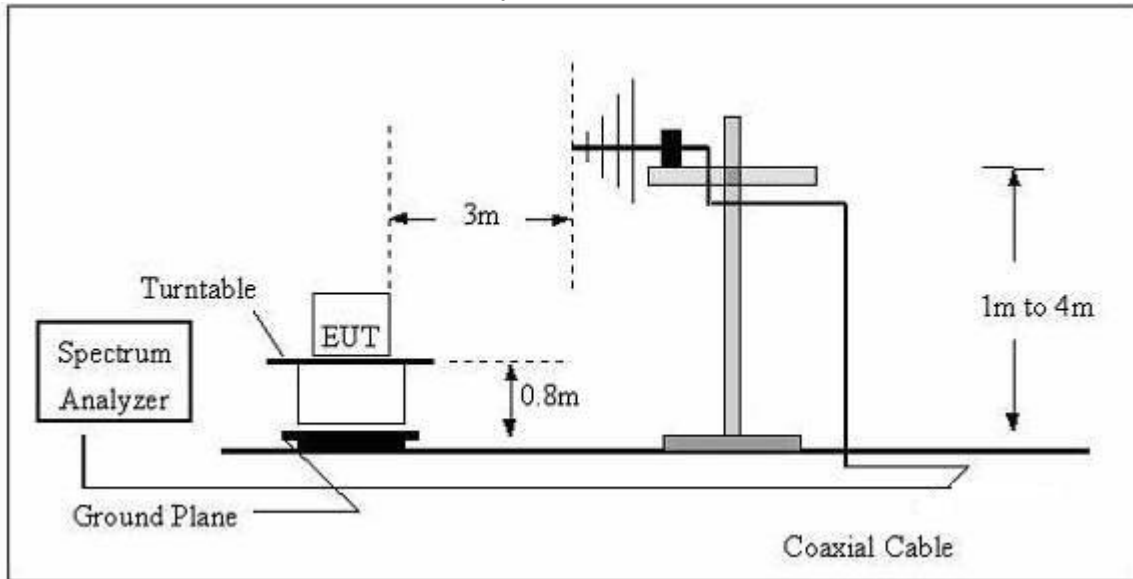

(C) Radiated Emission Test-Up Frequency Above 1GHz

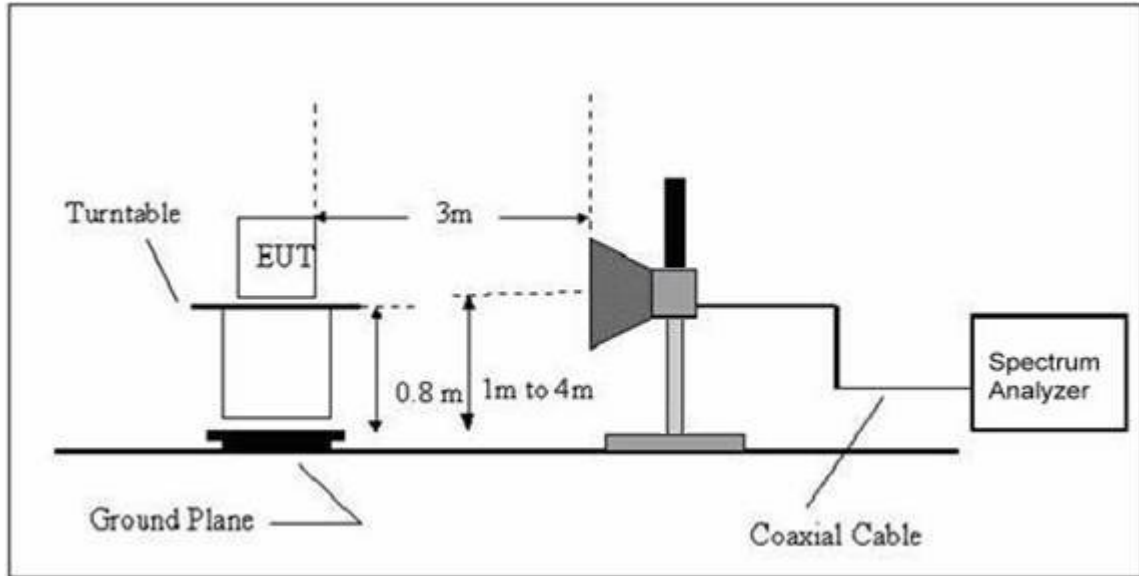

3.2.5 EUT OPERATING CONDITIONS

The EUT tested system was configured as the statements of 2.4 Unless otherwise a special operating condition is specified in the follows during the testing.

3.2.6 TEST RESULTS

Conducted Spurious Emissions at Antenna Port:

Low Channel -BDR

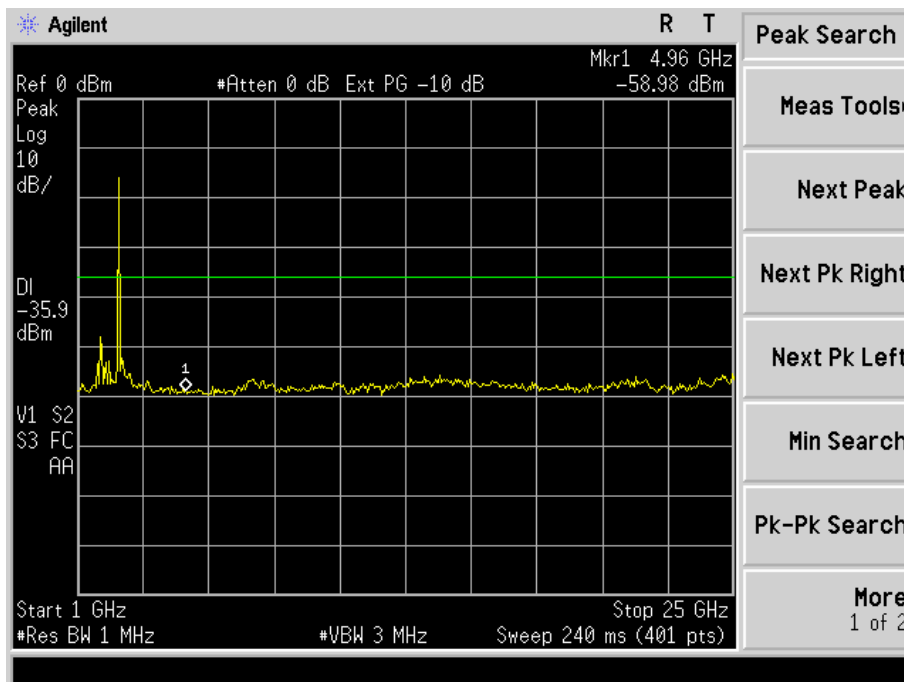
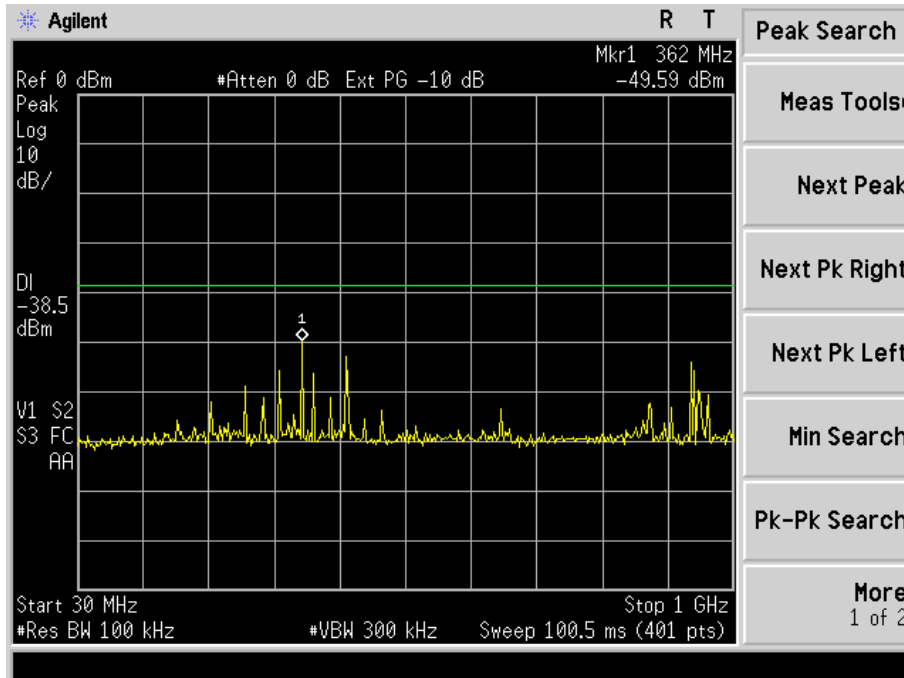

Middle Channel -BDR

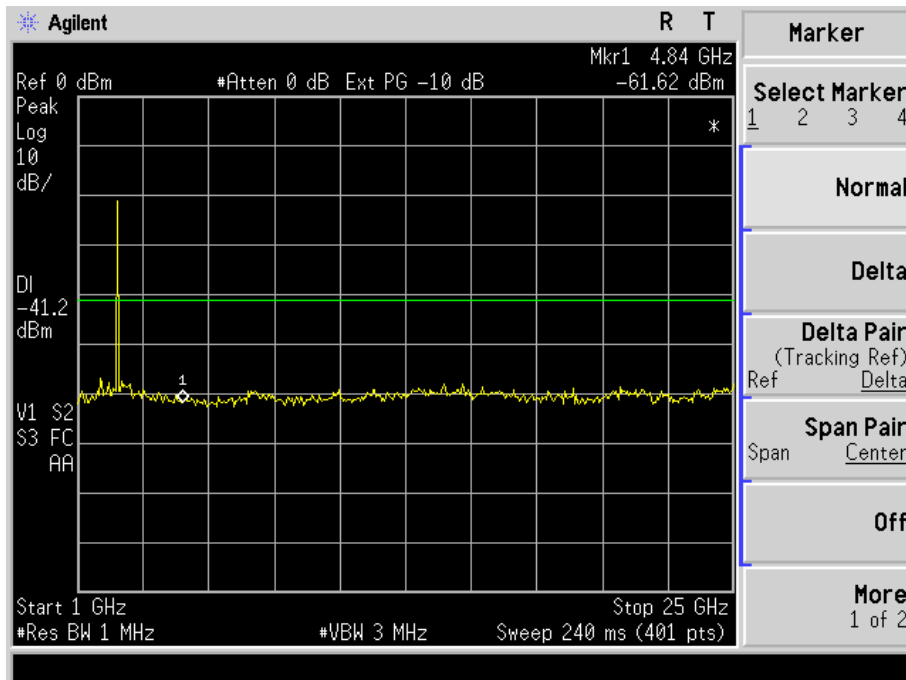
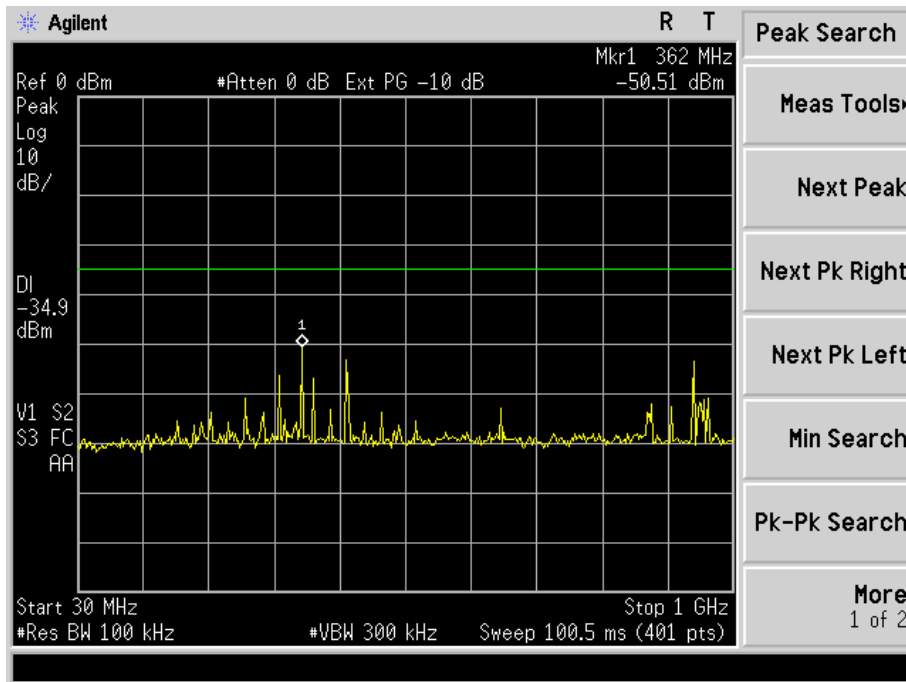

High Channel -BDR

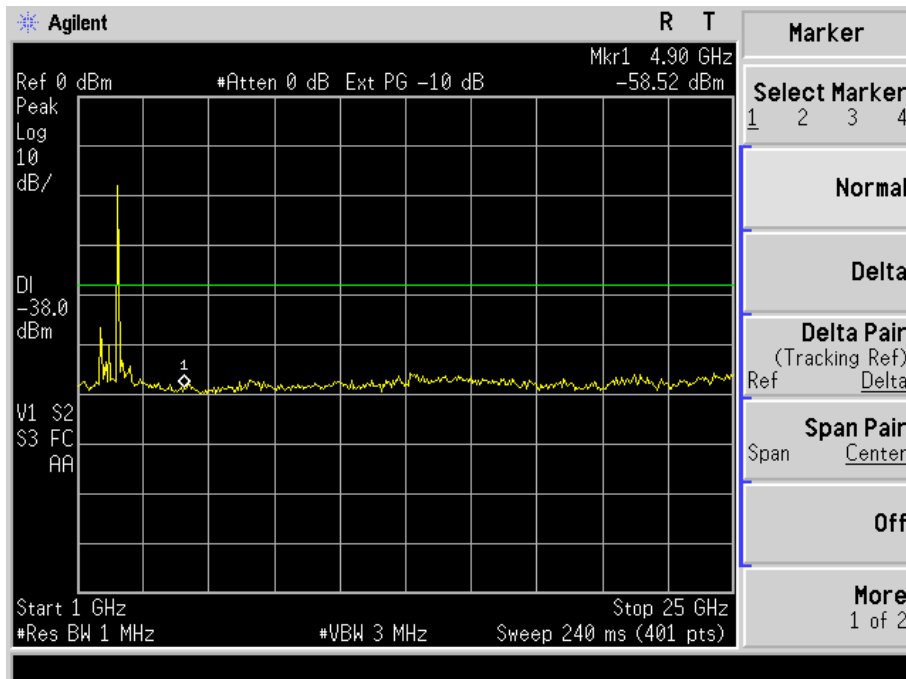
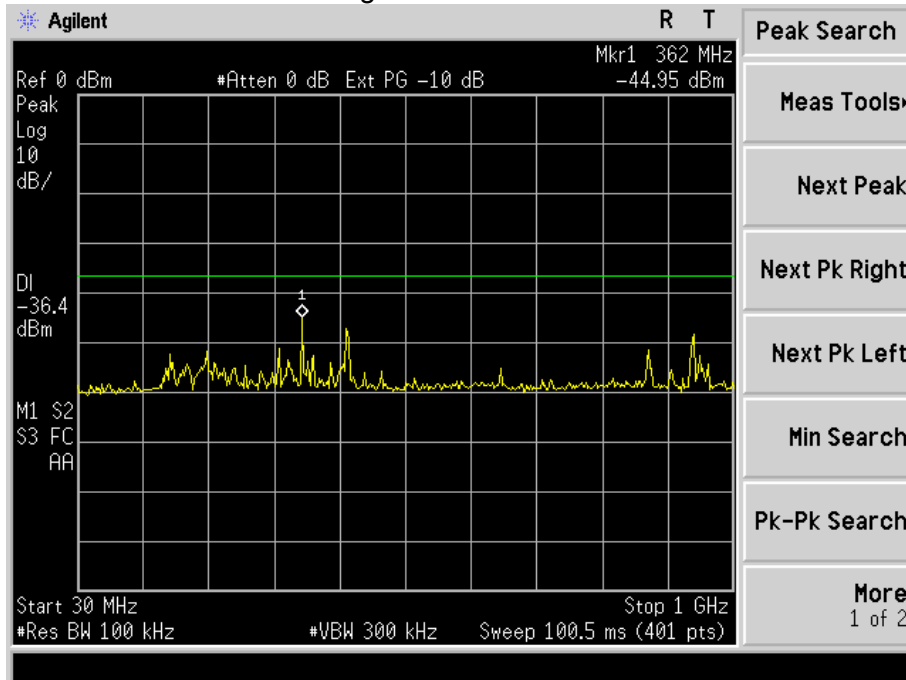

Radiated Spurious Emission (Between 30MHz – 1GHz)

| | | | |
|---------------|-------------------|---------------------|---------|
| EUT : | Bluetooth Speaker | Model Name : | M77 |
| Temperature : | 26 °C | Relative Humidity : | 54% |
| Pressure: | 1010hPa | Test Voltage : | DC 3.7V |
| Test Mode : | Mode 4 | | |

| Polar (H/V) | Frequency | Meter Reading | Factor | Emission Level | Limits | Margin | Detector Type |
|----------------|-----------|------------------|--------|-------------------|----------|--------|------------------|
| | (MHz) | (dBuV) | (dB) | (dBuV/m) | (dBuV/m) | (dB) | |
| V | 46.9947 | 17.31 | 9.62 | 26.93 | 40.00 | -13.07 | QP |
| V | 126.3285 | 18.31 | 12.21 | 30.52 | 43.50 | -12.98 | QP |
| V | 177.5089 | 21.22 | 10.07 | 31.29 | 43.50 | -12.21 | QP |
| V | 190.4050 | 21.14 | 9.01 | 30.15 | 43.50 | -13.35 | QP |
| V | 396.2412 | 15.84 | 18.05 | 33.89 | 46.00 | -12.11 | QP |
| V | 670.4891 | 9.54 | 23.85 | 33.39 | 46.00 | -12.61 | QP |
| H | 141.3298 | 10.30 | 12.13 | 22.43 | 43.50 | -21.07 | QP |
| H | 193.0945 | 15.98 | 8.98 | 24.96 | 43.50 | -18.54 | QP |
| H | 265.6757 | 17.90 | 14.46 | 32.36 | 46.00 | -13.64 | QP |
| H | 341.9786 | 16.91 | 16.19 | 33.10 | 46.00 | -12.90 | QP |
| H | 423.5403 | 13.11 | 18.94 | 32.05 | 46.00 | -13.95 | QP |
| H | 890.7278 | 13.97 | 27.46 | 41.43 | 46.00 | -4.57 | QP |

Remark:

Absolute Level= ReadingLevel+ Factor, Margin= Absolute Level - Limit

(Scan with GFSK, $\pi/4$ -DQPSK,8DPSK,the worst case is BDR Mode (GFSK))

| Frequency (MHz) | Meter Reading (dB μ V) | Factor (dB) | Emission Level (dB μ V/m) | Limits (dB μ V/m) | Margin (dB) | Detector Type | Comment |
|-------------------------|-------------------------------|----------------|----------------------------------|--------------------------|----------------|------------------|------------|
| Low Channel (2402 MHz) | | | | | | | |
| 1127.500 | 68.40 | -19.14 | 49.26 | 74.00 | -24.74 | peak | Vertical |
| 1595.000 | 61.49 | -16.43 | 45.06 | 74.00 | -28.94 | peak | Vertical |
| 3040.000 | 61.23 | -11.63 | 49.60 | 74.00 | -24.40 | peak | Vertical |
| 4804.000 | 53.64 | -3.64 | 50.00 | 74.00 | -24.00 | peak | Vertical |
| 1127.500 | 71.12 | -19.14 | 51.98 | 74.00 | -22.02 | peak | Horizontal |
| 1595.000 | 68.06 | -16.43 | 51.63 | 74.00 | -22.37 | peak | Horizontal |
| 3040.000 | 59.73 | -11.63 | 48.10 | 74.00 | -25.90 | peak | Horizontal |
| 4804.000 | 51.54 | -3.64 | 47.90 | 74.00 | -26.10 | peak | Horizontal |
| Mid Channel (2441 MHz) | | | | | | | |
| 1340.000 | 65.91 | -17.48 | 48.43 | 74.00 | -25.57 | peak | Vertical |
| 2020.000 | 59.36 | -12.92 | 46.44 | 74.00 | -27.56 | peak | Vertical |
| 2827.500 | 57.83 | -11.73 | 46.10 | 74.00 | -27.90 | peak | Vertical |
| 4882.000 | 53.38 | -3.68 | 49.70 | 74.00 | -24.30 | peak | Vertical |
| 1127.500 | 67.52 | -19.14 | 48.38 | 74.00 | -25.62 | peak | Horizontal |
| 1637.500 | 61.68 | -16.06 | 45.62 | 74.00 | -28.38 | peak | Horizontal |
| 2487.500 | 56.21 | -12.77 | 43.44 | 74.00 | -30.56 | peak | Horizontal |
| 4882.000 | 50.78 | -3.68 | 47.10 | 74.00 | -26.90 | peak | Horizontal |
| High Channel (2480 MHz) | | | | | | | |
| 1170.000 | 63.74 | -18.54 | 45.20 | 74.00 | -28.80 | peak | Vertical |
| 2275.000 | 63.37 | -12.87 | 50.50 | 74.00 | -23.50 | peak | Vertical |
| 3125.000 | 55.69 | -11.43 | 44.26 | 74.00 | -29.74 | peak | Vertical |
| 4960.000 | 51.99 | -3.59 | 48.40 | 74.00 | -25.60 | peak | Vertical |
| 1127.500 | 69.94 | -19.14 | 50.80 | 74.00 | -23.20 | peak | Horizontal |
| 1340.000 | 66.40 | -17.48 | 48.92 | 74.00 | -25.08 | peak | Horizontal |
| 1850.000 | 64.33 | -14.64 | 49.69 | 74.00 | -24.31 | peak | Horizontal |
| 4960.000 | 52.69 | -3.59 | 49.10 | 74.00 | -24.90 | peak | Horizontal |

Remark:

Factor = Antenna Factor + Cable Loss – Pre-amplifier.

Emission Level = Meter Reading + Factor

Margin = Emission Level - Limit

Radiated band edge:

| Frequency (MHz) | Meter Reading (dB μ V) | Factor (dB) | Emission Level (dB μ V/m) | Limits (dB μ V/m) | Margin (dB) | Detector Type | Comment |
|---------------------------------|-------------------------------|----------------|----------------------------------|--------------------------|----------------|------------------|------------|
| GFSK | | | | | | | |
| 2400 | 47.68 | -13.06 | 34.62 | 54 | -19.38 | peak | Vertical |
| 2400 | 49.84 | -13.06 | 36.78 | 54 | -17.22 | peak | Horizontal |
| 2483.5 | 47.92 | -12.78 | 35.14 | 54 | -18.86 | peak | Vertical |
| 2483.5 | 49.33 | -12.78 | 36.55 | 54 | -17.45 | peak | Horizontal |
| $\pi/4$-DQPSK | | | | | | | |
| 2400 | 48.25 | -13.06 | 35.19 | 54 | -18.81 | peak | Vertical |
| 2400 | 50.31 | -13.06 | 37.25 | 54 | -16.75 | peak | Horizontal |
| 2483.5 | 47.24 | -12.78 | 34.46 | 54 | -19.54 | peak | Vertical |
| 2483.5 | 49.39 | -12.78 | 36.61 | 54 | -17.39 | peak | Horizontal |
| 8DPSK | | | | | | | |
| 2400 | 48.47 | -13.06 | 34.87 | 54 | -19.13 | peak | Vertical |
| 2400 | 49.84 | -13.06 | 36.78 | 54 | -17.22 | peak | Horizontal |
| 2483.5 | 47.69 | -12.78 | 34.91 | 54 | -19.09 | peak | Vertical |
| 2483.5 | 49.32 | -12.78 | 36.54 | 54 | -17.46 | peak | Horizontal |

NOTE: The result(PK) less than AV limite,No need shown AV result.

4. NUMBER OF HOPPING CHANNEL

4.1 APPLIED PROCEDURES / LIMIT

| FCC Part15 (15.247) , Subpart C | | | | |
|---------------------------------|---------------------------|-------|-----------------------|--------|
| Section | Test Item | Limit | Frequency Range (MHz) | Result |
| 15.247 (a)(1)(iii) | Number of Hopping Channel | ≥15 | 2400-2483.5 | PASS |

| Spectrum Parameters | Setting |
|---------------------|-----------------------------------|
| Attenuation | Auto |
| Span Frequency | = the frequency band of operation |
| RB | RBW ≥ 1% of the span |
| VB | VBW ≥ RBW |
| Detector | Peak |
| Trace | Max Hold |
| Sweep Time | Auto |

4.1.1 TEST PROCEDURE

- a. The EUT was directly connected to the spectrum analyzer and antenna output port as show in the block diagram below,
- b. Spectrum Setting : RBW= 1MHz, VBW=3MHz, Sweep time = Auto.

4.1.2 DEVIATION FROM STANDARD

No deviation.

4.1.3 TEST SETUP

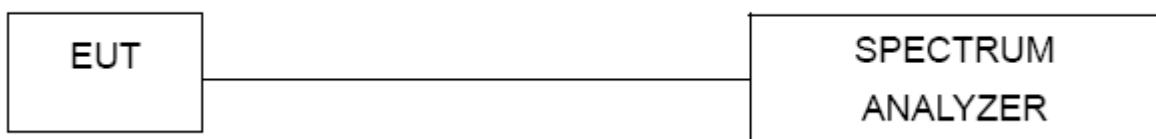

4.1.4 EUT OPERATION CONDITIONS

The EUT tested system was configured as the statements of 2.4 Unless otherwise a special operating condition is specified in the follows during the testing.

4.1.5 TEST RESULTS

| | | | |
|---------------|-------------------|---------------------|---------|
| EUT : | Bluetooth Speaker | Model Name : | M77 |
| Temperature : | 25 °C | Relative Humidity : | 60% |
| Pressure : | 1015 hPa | Test Voltage : | DC 3.7V |
| Test Mode : | Hopping Mode | | |

| | |
|---------------------------|----|
| Number of Hopping Channel | 79 |
|---------------------------|----|

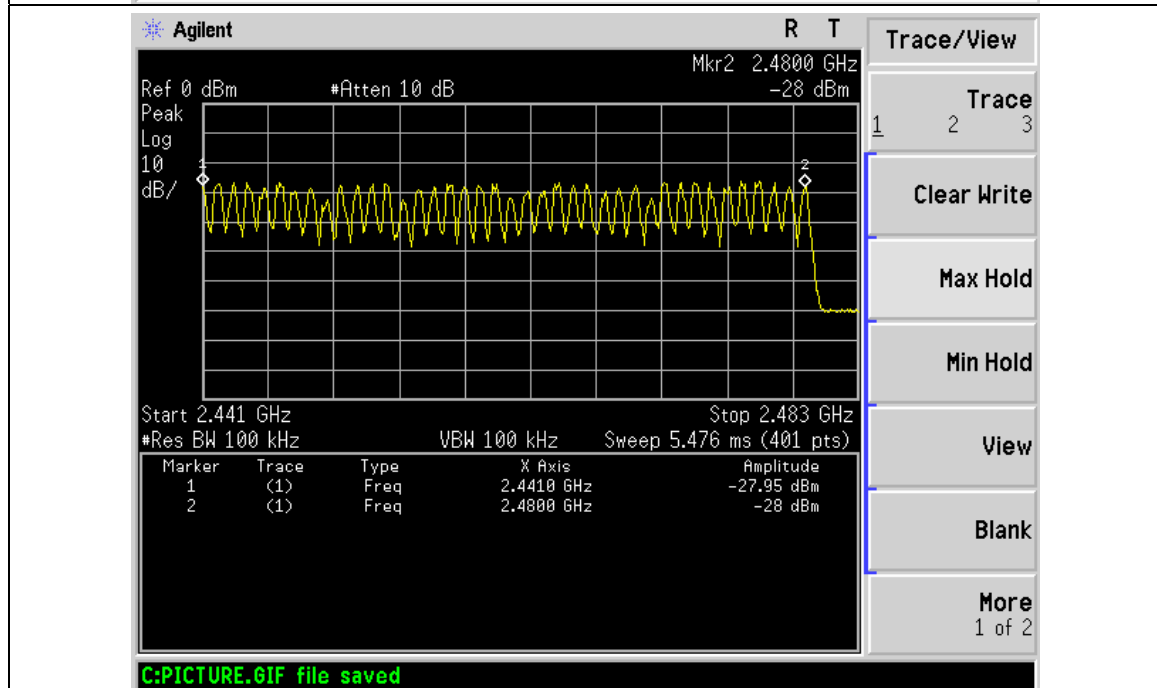
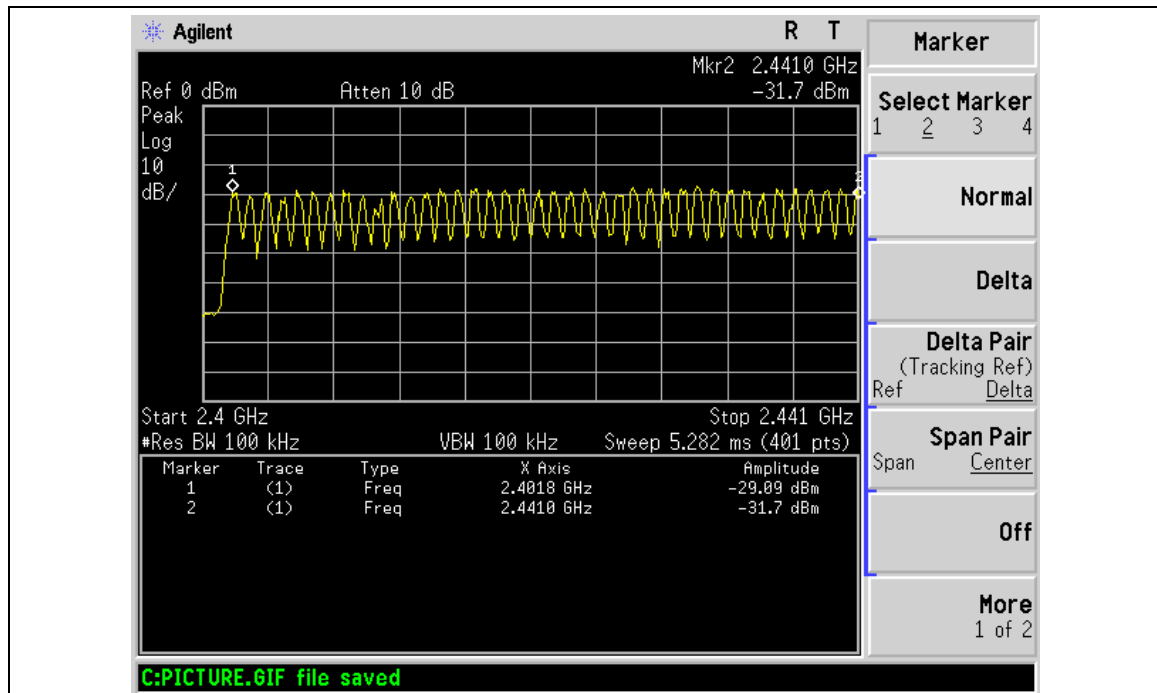

5. AVERAGE TIME OF OCCUPANCY

5.1 APPLIED PROCEDURES / LIMIT

| FCC Part15 (15.247) , Subpart C | | | | |
|---------------------------------|---------------------------|--------|-----------------------|--------|
| Section | Test Item | Limit | Frequency Range (MHz) | Result |
| 15.247 (a)(1)(iii) | Average Time of Occupancy | 0.4sec | 2400-2483.5 | PASS |

5.1.1 TEST PROCEDURE

- a. The transmitter output (antenna port) was connected to the spectrum analyzer
- b. Set RBW of spectrum analyzer to 1MHz and VBW to 1MHz.
- c. Use a video trigger with the trigger level set to enable triggering only on full pulses.
- d. Sweep Time is more than once pulse time.
- e. Set the center frequency on any frequency would be measure and set the frequency span to zero span.
- f. Measure the maximum time duration of one single pulse.
- g. Set the EUT for DH5, DH3 and DH1 packet transmitting.
- h. Measure the maximum time duration of one single pulse.
- i. A Period Time = (channel number)*0.4
 DH1 Time Slot: Reading * (1600/2)*31.6/(channel number)
 DH3 Time Slot: Reading * (1600/4)*31.6/(channel number)
 DH5 Time Slot: Reading * (1600/6)*31.6/(channel number)

5.1.2 DEVIATION FROM STANDARD

No deviation.

5.1.3 TEST SETUP



5.1.4 EUT OPERATION CONDITIONS

The EUT tested system was configured as the statements of 2.4 Unless otherwise a special operating condition is specified in the follows during the testing.

5.1.5 TEST RESULTS

| | | | |
|---------------|----------------------|---------------------|---------|
| EUT : | Bluetooth Speaker | Model Name : | M77 |
| Temperature : | 25 °C | Relative Humidity : | 60% |
| Pressure : | 1012 hPa | Test Voltage : | DC 3.7V |
| Test Mode : | CH39-DH5, 2DH5, 3DH5 | | |

| Data Packet | Frequency | Pulse Duration (ms) | Dwell Time (s) | Limits (s) |
|-------------|-----------|---------------------|----------------|------------|
| DH5 | 2441 MHz | 2.95 | 0.31 | 0.4 |
| 2DH5 | 2441 MHz | 2.95 | 0.31 | 0.4 |
| 3DH5 | 2441 MHz | 2.96 | 0.32 | 0.4 |

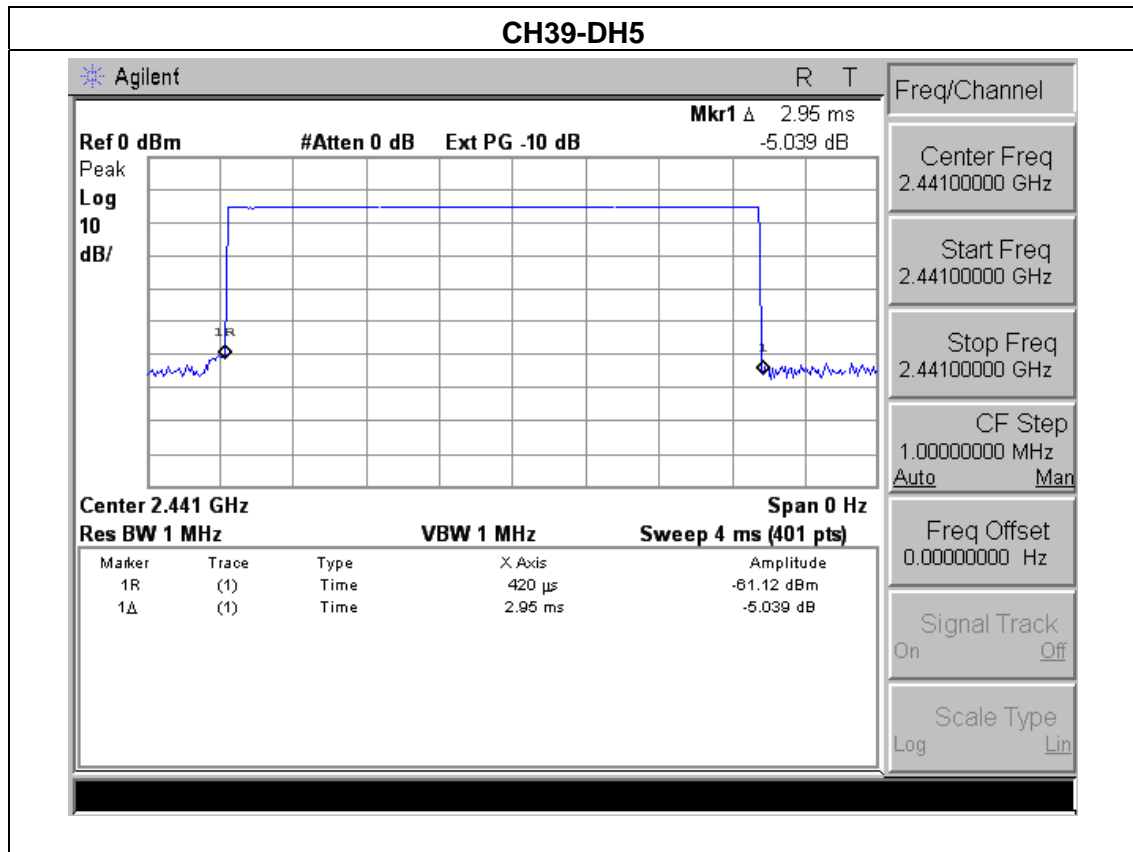

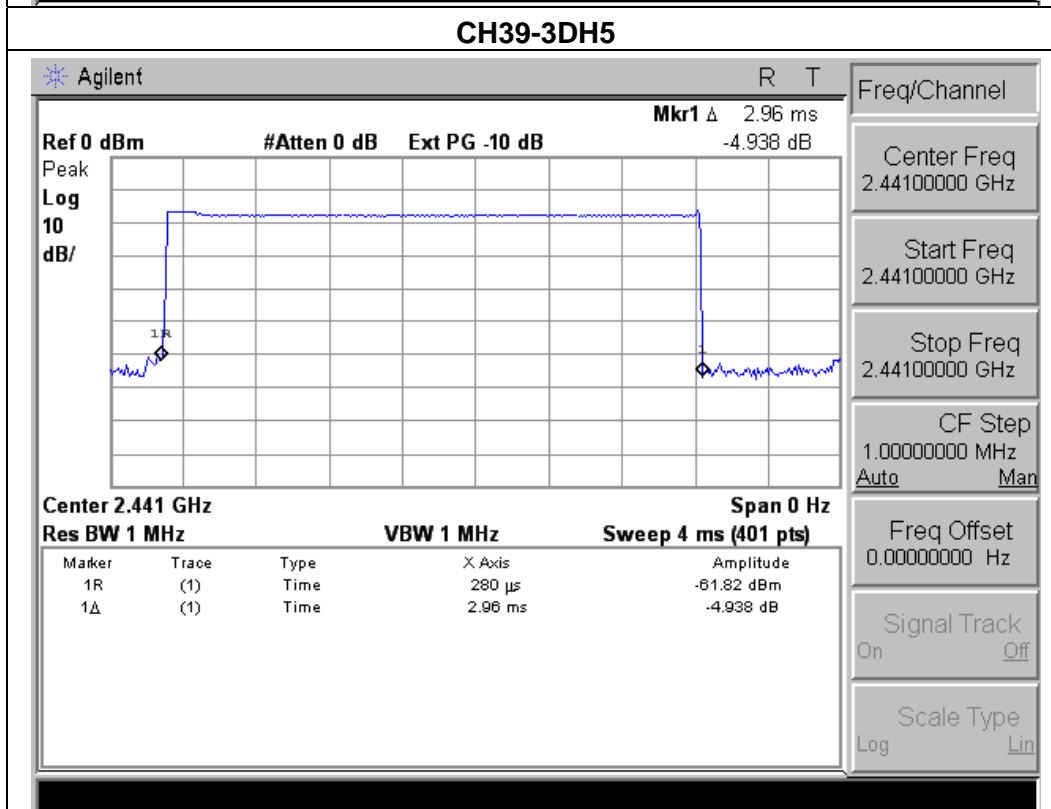
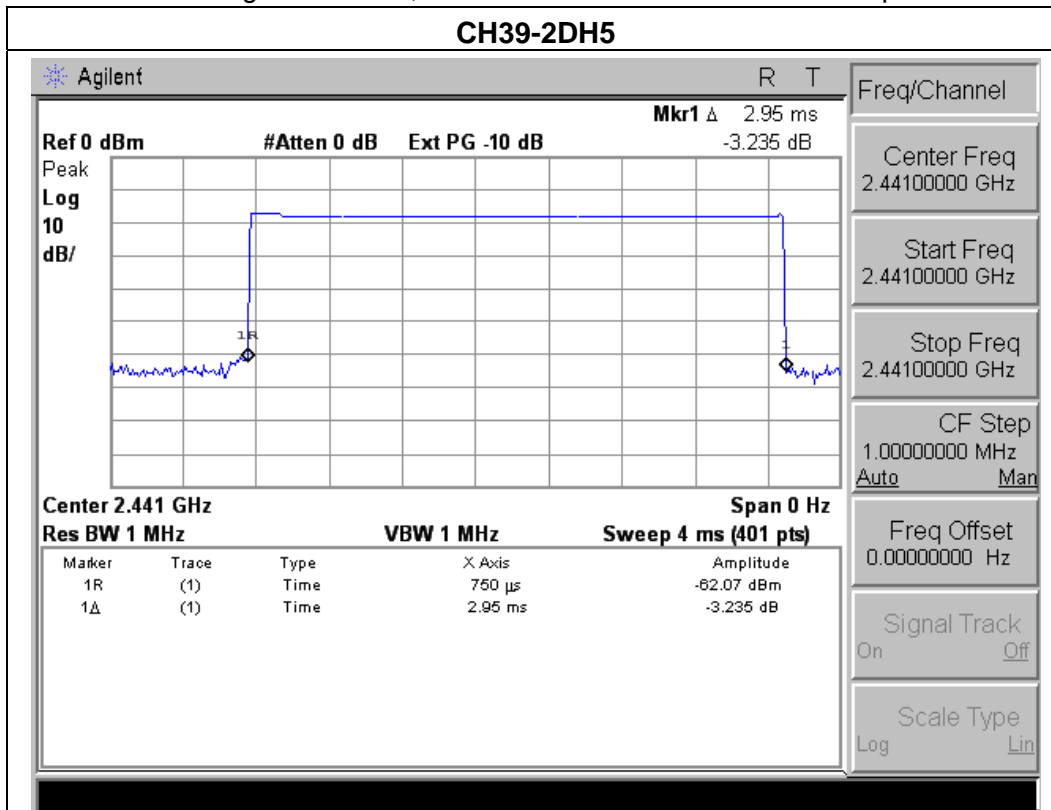

| | | | |
|---------------|----------------------|---------------------|---------|
| EUT : | Bluetooth Speaker | Model Name : | M77 |
| Temperature : | 25 °C | Relative Humidity : | 60% |
| Pressure : | 1012 hPa | Test Voltage : | DC 3.7V |
| Test Mode : | CH39-DH3, 2DH3, 3DH3 | | |

| Data Packet | Frequency | Pulse Duration (ms) | Dwell Time (s) | Limits (s) |
|-------------|-----------|---------------------|----------------|------------|
| DH3 | 2441 MHz | 1.71 | 0.18 | 0.4 |
| 2DH3 | 2441 MHz | 1.71 | 0.18 | 0.4 |
| 3DH3 | 2441 MHz | 1.74 | 0.19 | 0.4 |

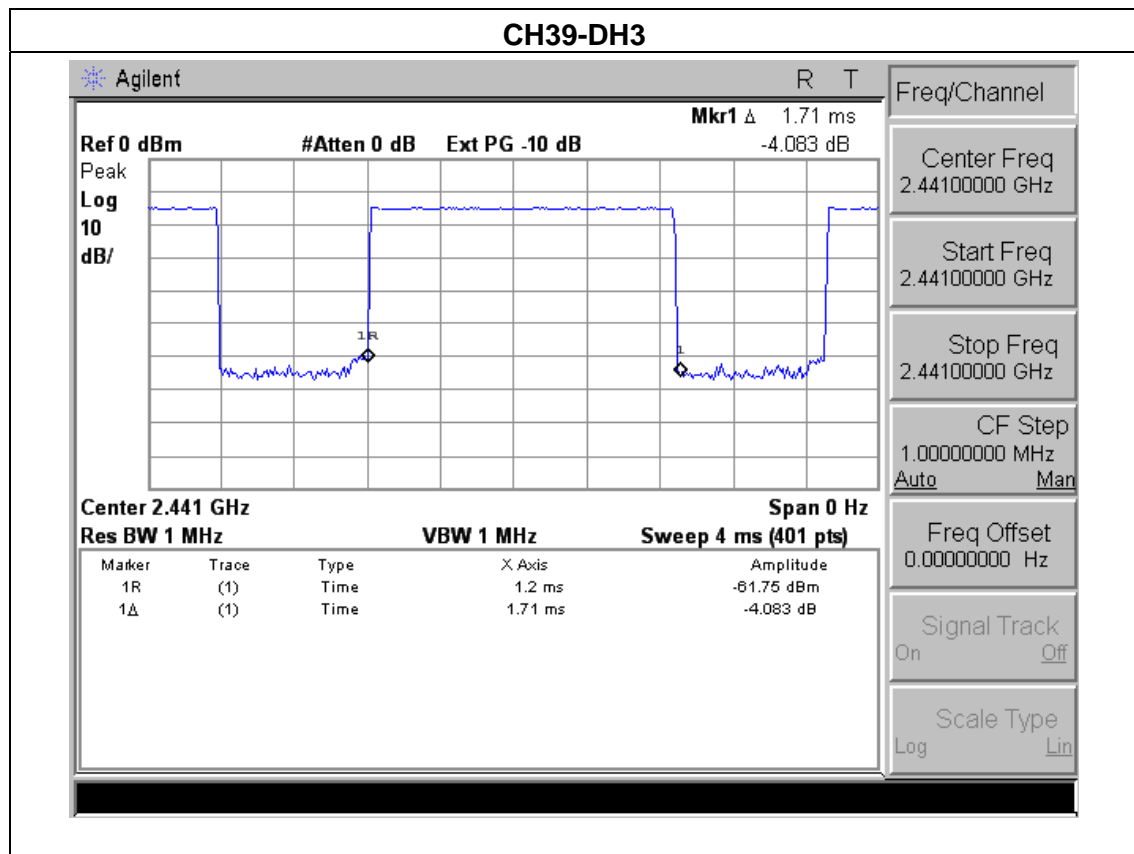

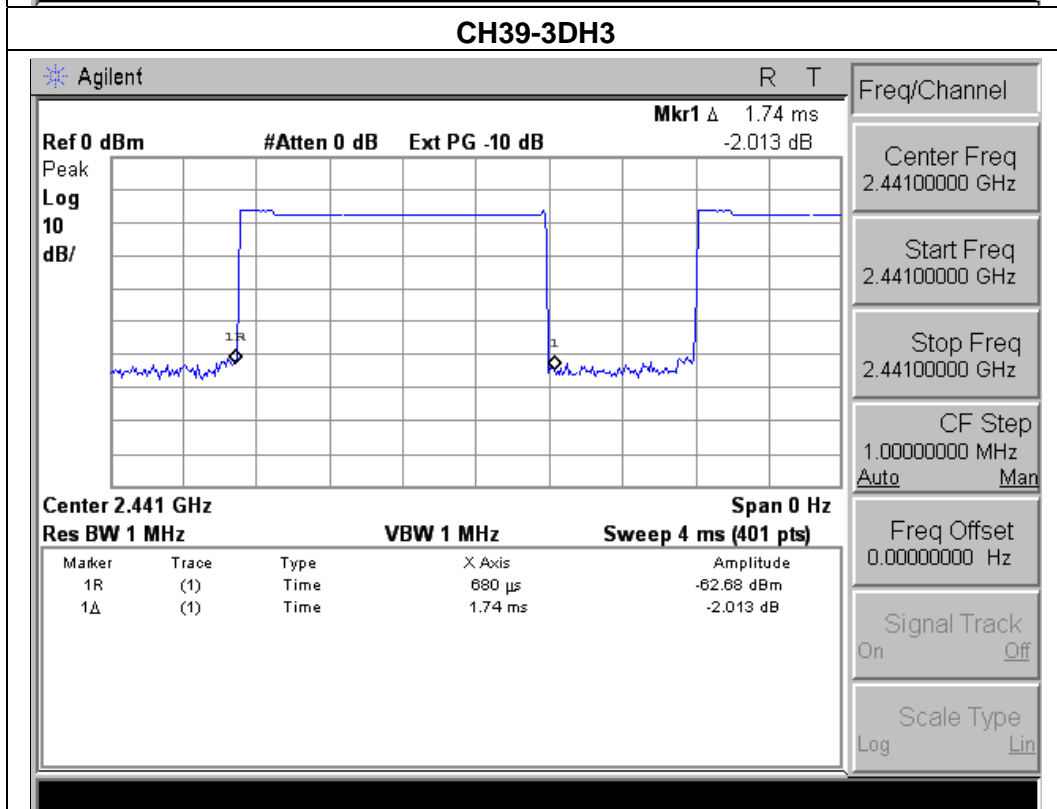
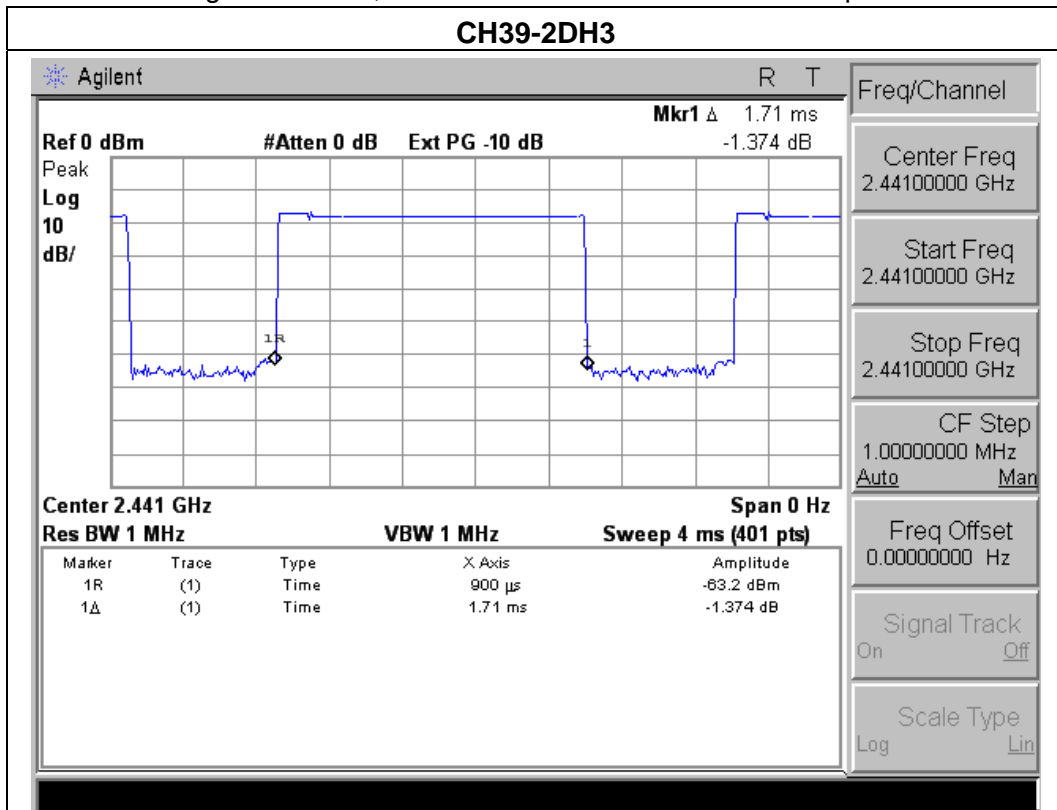

| | | | |
|---------------|----------------------|---------------------|---------|
| EUT : | Bluetooth Speaker | Model Name : | M77 |
| Temperature : | 25 °C | Relative Humidity : | 60% |
| Pressure : | 1012 hPa | Test Voltage : | DC 3.7V |
| Test Mode : | CH39-DH1, 2DH1, 3DH1 | | |

| Data Packet | Frequency | Pulse Duration (ms) | Dwell Time (s) | Limits (s) |
|-------------|-----------|---------------------|----------------|------------|
| DH1 | 2441 MHz | 0.43 | 0.05 | 0.4 |
| 2DH1 | 2441 MHz | 0.43 | 0.05 | 0.4 |
| 3DH1 | 2441 MHz | 0.46 | 0.05 | 0.4 |

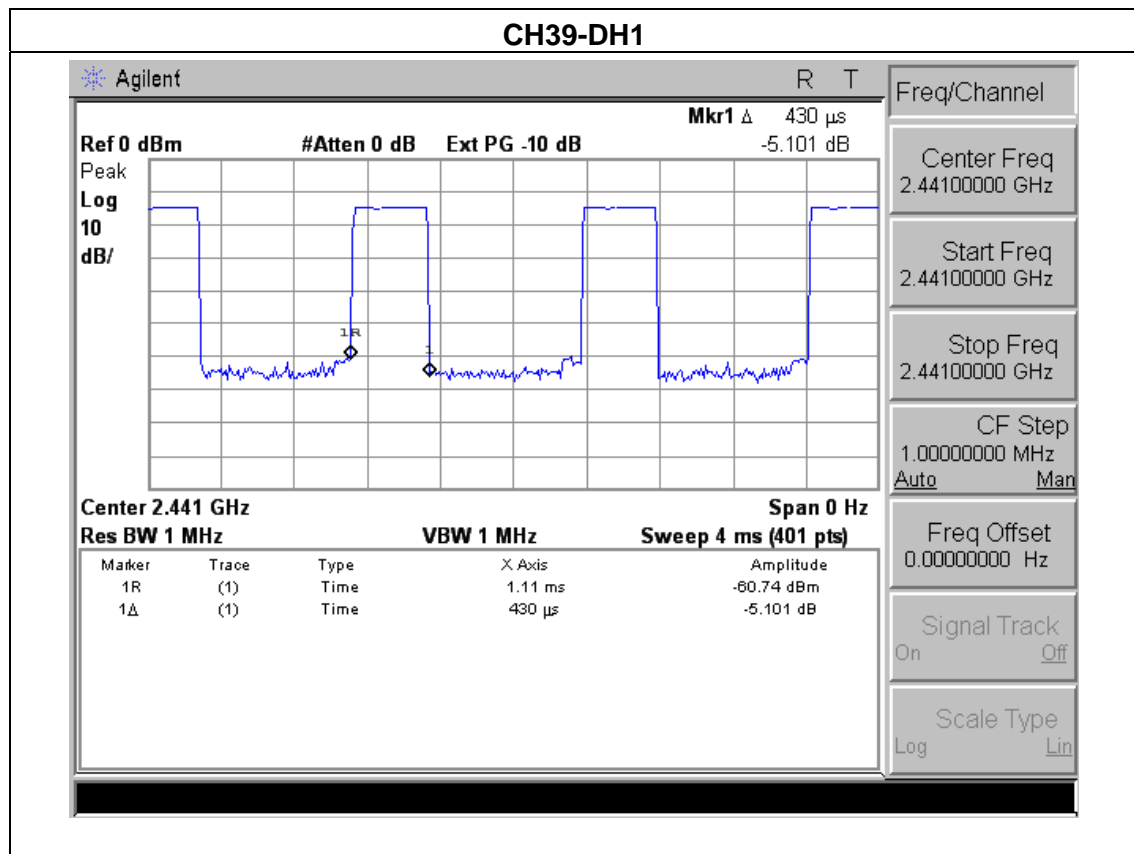

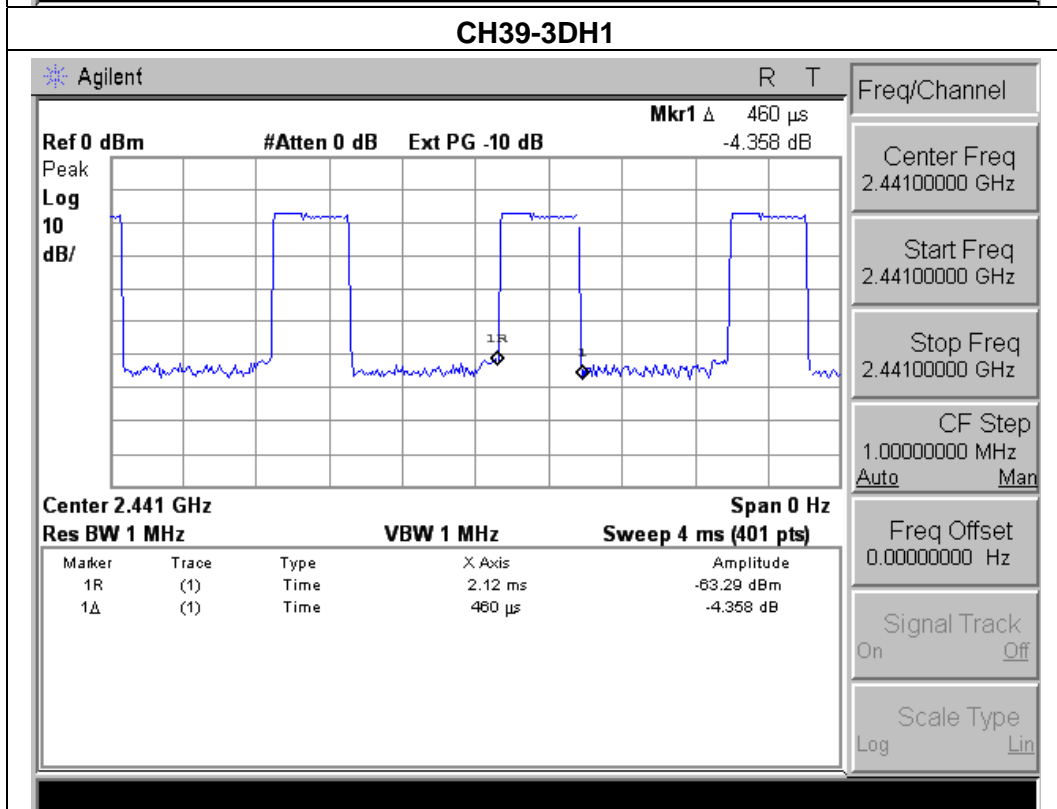
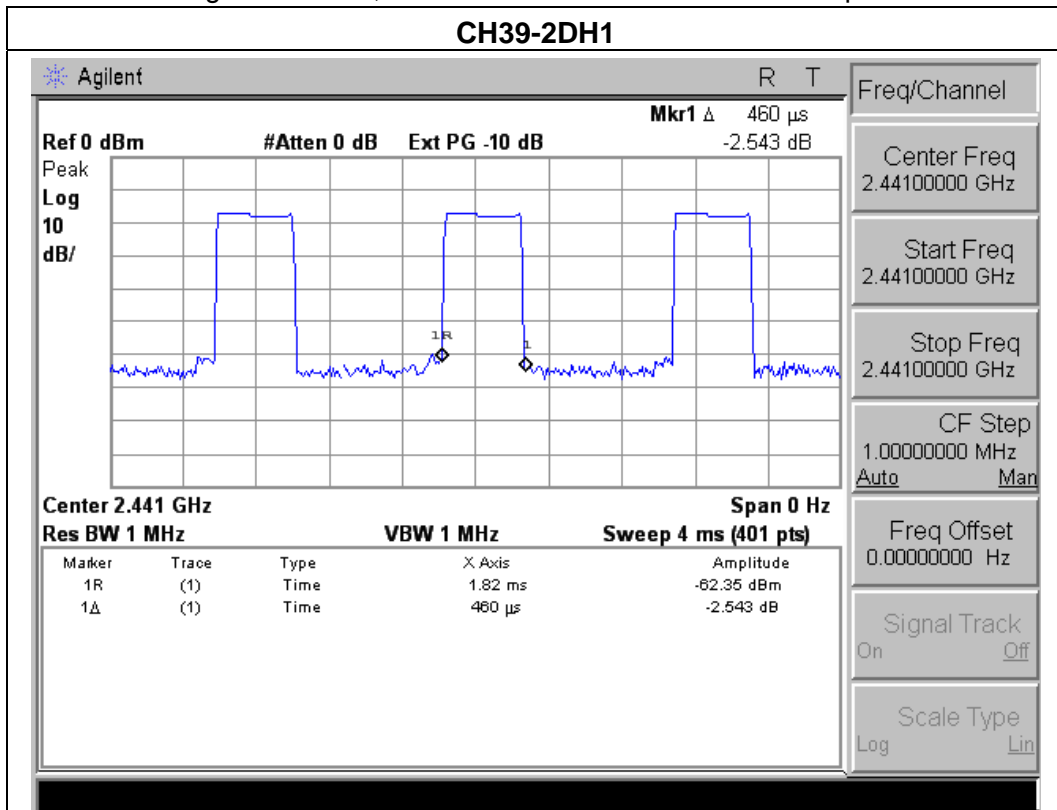

6. HOPPING CHANNEL SEPARATION MEASUREMENT

6.1 APPLIED PROCEDURES / LIMIT

Frequency hopping systems operating in the 2400-2483.5 MHz band may have hopping channel carrier frequencies that are separated by 25 kHz or two-thirds of the 20 dB bandwidth of the hopping channel, whichever is greater.

| Spectrum Parameter | Setting |
|--------------------|---|
| Attenuation | Auto |
| Span Frequency | > Measurement Bandwidth or Channel Separation |
| RB | 100 kHz (Channel Separation) |
| VB | 300 kHz (Channel Separation) |
| Detector | Peak |
| Trace | Max Hold |
| Sweep Time | Auto |

6.1.1 TEST PROCEDURE

- a. The transmitter output (antenna port) was connected to the spectrum analyser in peak hold mode.
- b. The resolution bandwidth of 100 kHz and the video bandwidth of 300 kHz were utilised for channel separation measurement.

6.1.2 DEVIATION FROM STANDARD

No deviation.

6.1.3 TEST SETUP

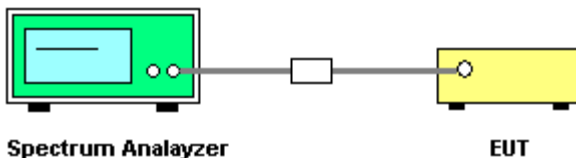

6.1.4 EUT OPERATION CONDITIONS

The EUT was programmed to be in continuously transmitting mode.

6.1.5 TEST RESULTS

| | | | |
|---------------|--------------------------------|---------------------|---------|
| EUT : | Bluetooth Speaker | Model Name : | M77 |
| Temperature : | 25 °C | Relative Humidity : | 60% |
| Pressure : | 1012 hPa | Test Voltage : | DC 3.7V |
| Test Mode : | CH00 / CH39 /CH78 (1Mbps Mode) | | |

| Frequency | Ch. Separation (MHz) | Result |
|-----------|----------------------|-----------------|
| 2402 MHz | 0.990 | Complies |
| 2441 MHz | 0.998 | Complies |
| 2480 MHz | 0.998 | Complies |

Ch. Separation Limits: >20dB bandwidth

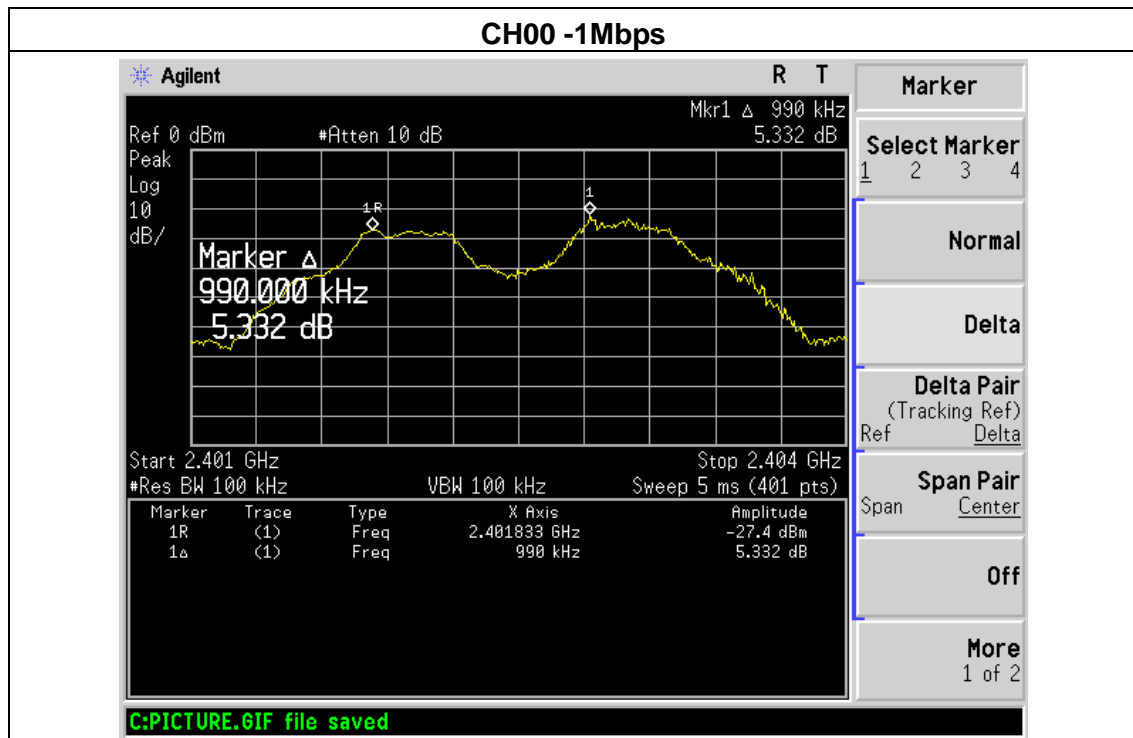

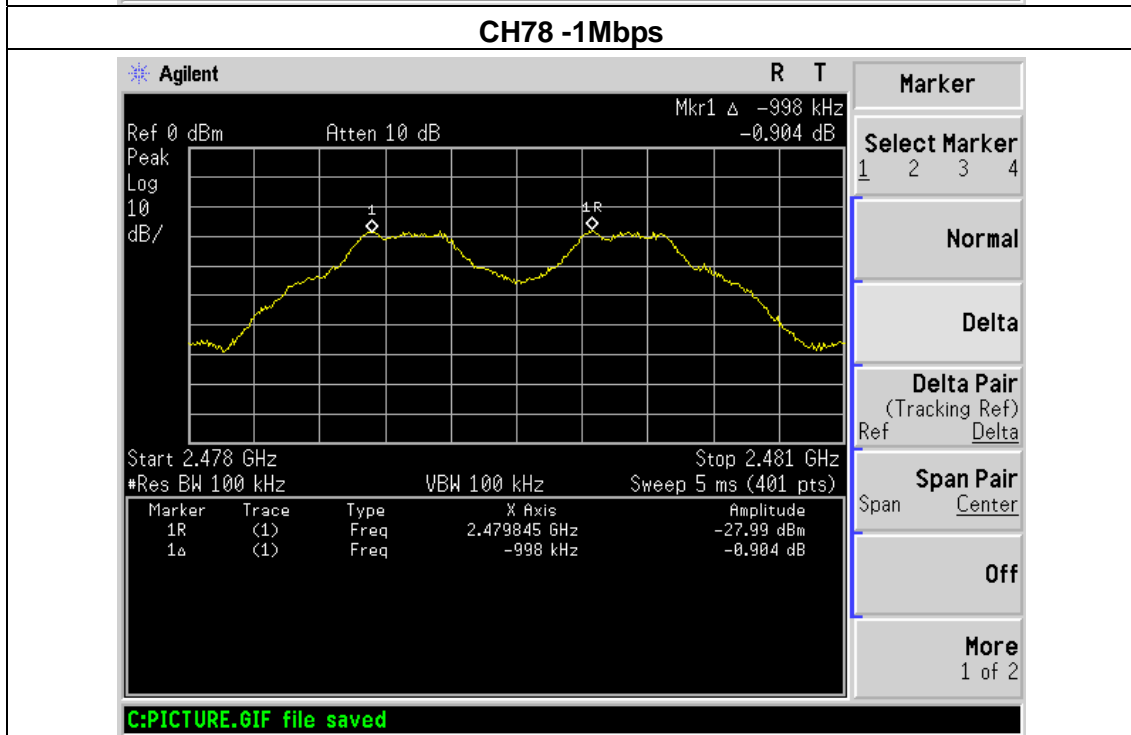
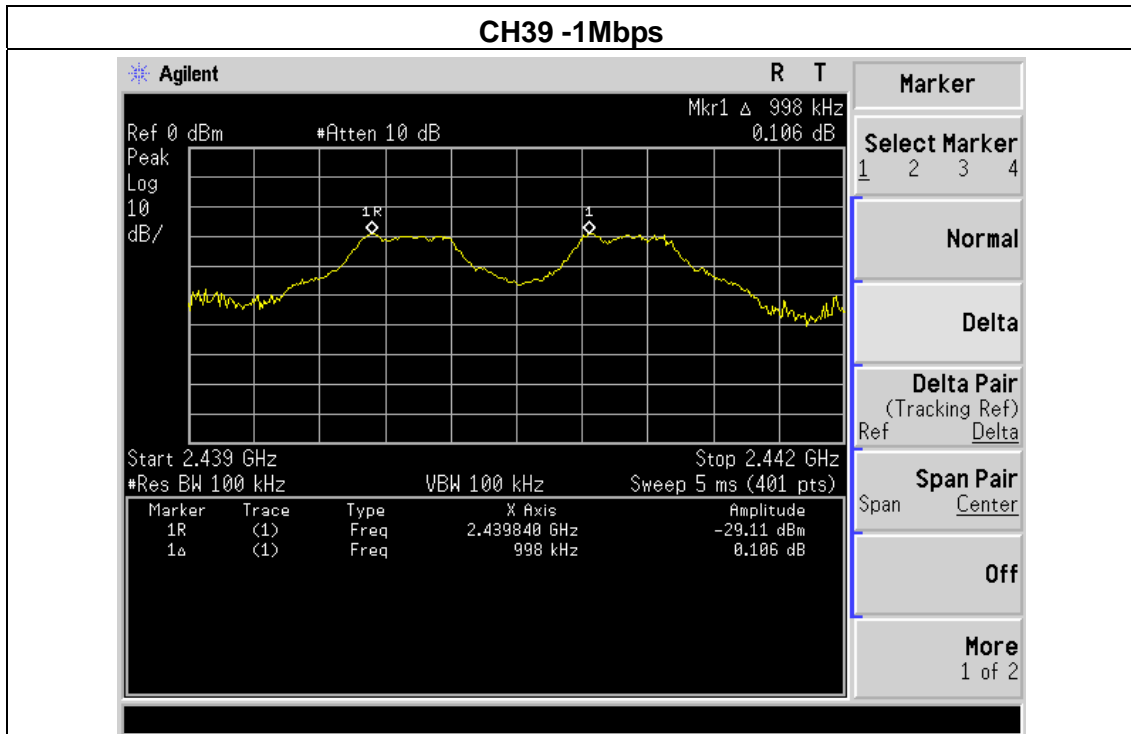

| | | | |
|---------------|--------------------------------|---------------------|---------|
| EUT : | Bluetooth Speaker | Model Name : | M77 |
| Temperature : | 25 °C | Relative Humidity : | 60% |
| Pressure : | 1012 hPa | Test Voltage : | DC 3.7V |
| Test Mode : | CH00 / CH39 /CH78 (2Mbps Mode) | | |

| Frequency | Ch. Separation (MHz) | Result |
|-----------|----------------------|----------|
| 2402 MHz | 0.990 | Complies |
| 2441 MHz | 0.998 | Complies |
| 2480 MHz | 1.020 | Complies |

Ch. Separation Limits: >2/3 of 20dB bandwidth

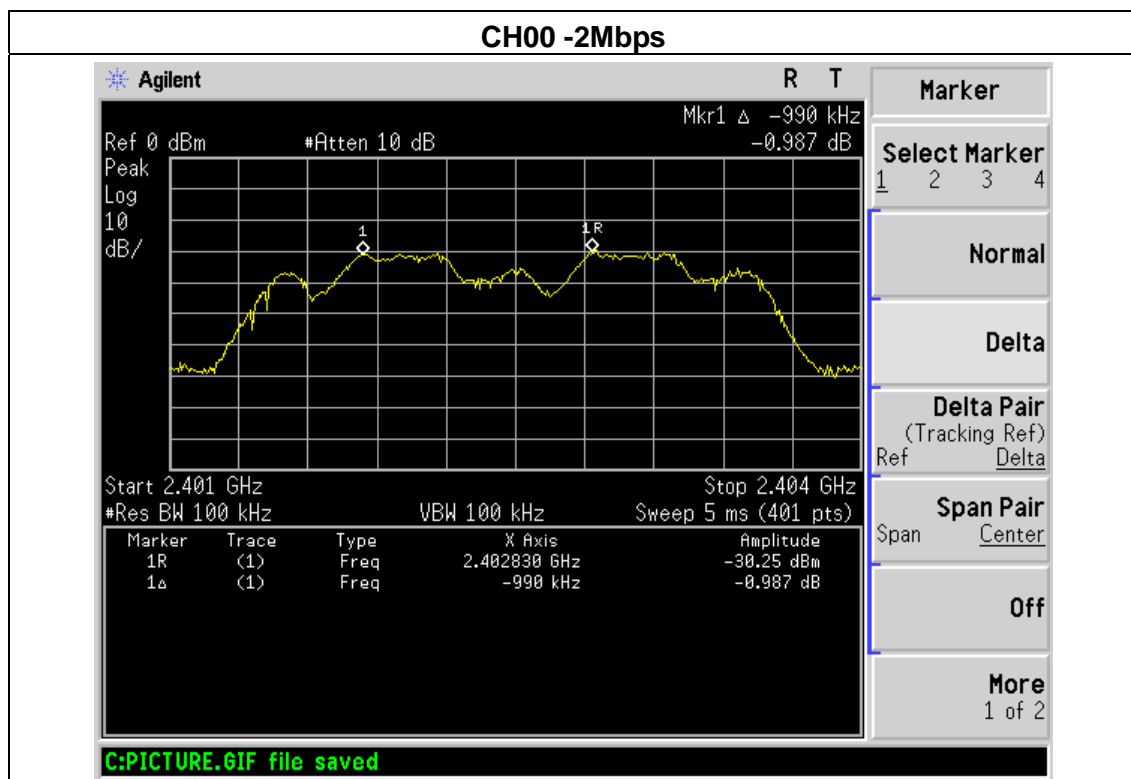

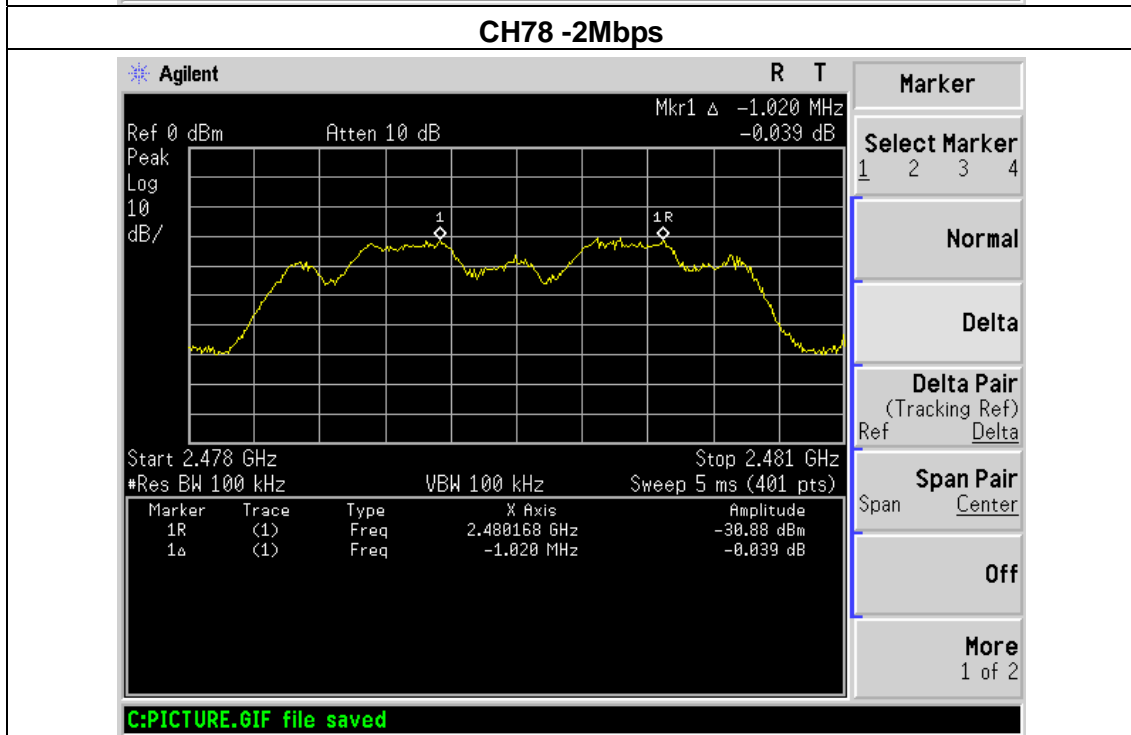
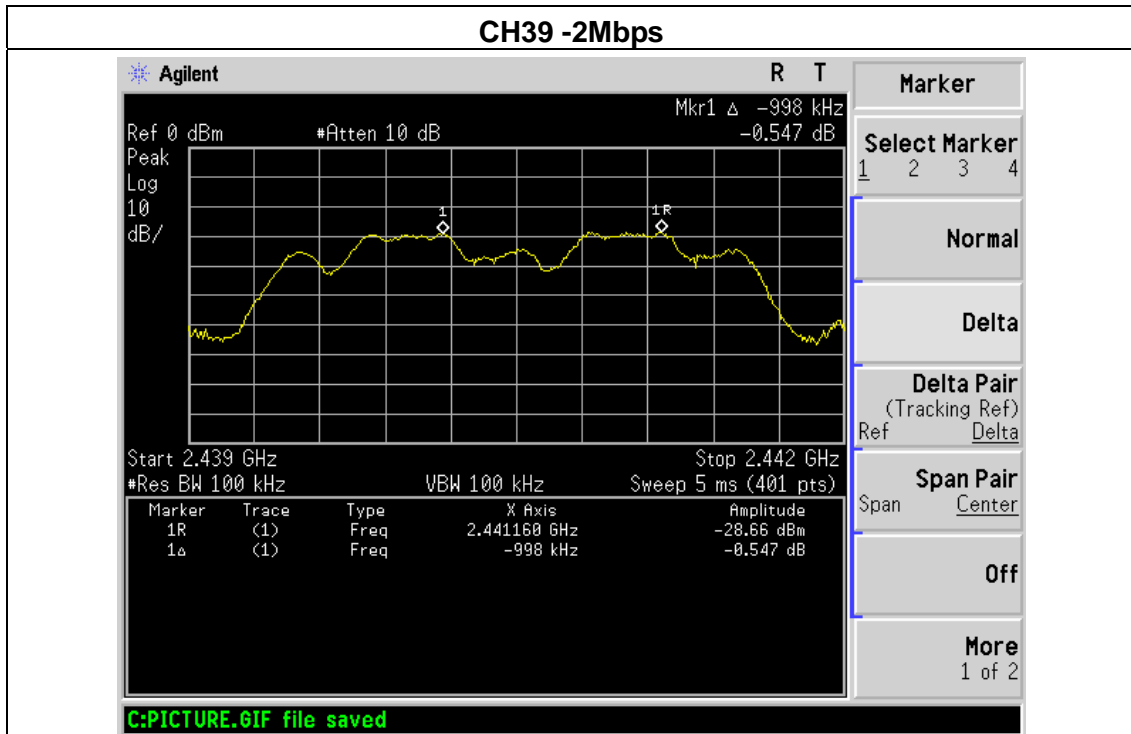

| | | | |
|---------------|--------------------------------|---------------------|---------|
| EUT : | Bluetooth Speaker | Model Name : | M77 |
| Temperature : | 25 °C | Relative Humidity : | 60% |
| Pressure : | 1012 hPa | Test Voltage : | DC 3.7V |
| Test Mode : | CH00 / CH39 /CH78 (3Mbps Mode) | | |

| Frequency | Ch. Separation (MHz) | Result |
|-----------|----------------------|----------|
| 2402 MHz | 0.983 | Complies |
| 2441 MHz | 0.998 | Complies |
| 2480 MHz | 1.005 | Complies |

Ch. Separation Limits: >2/3 of 20dB bandwidth

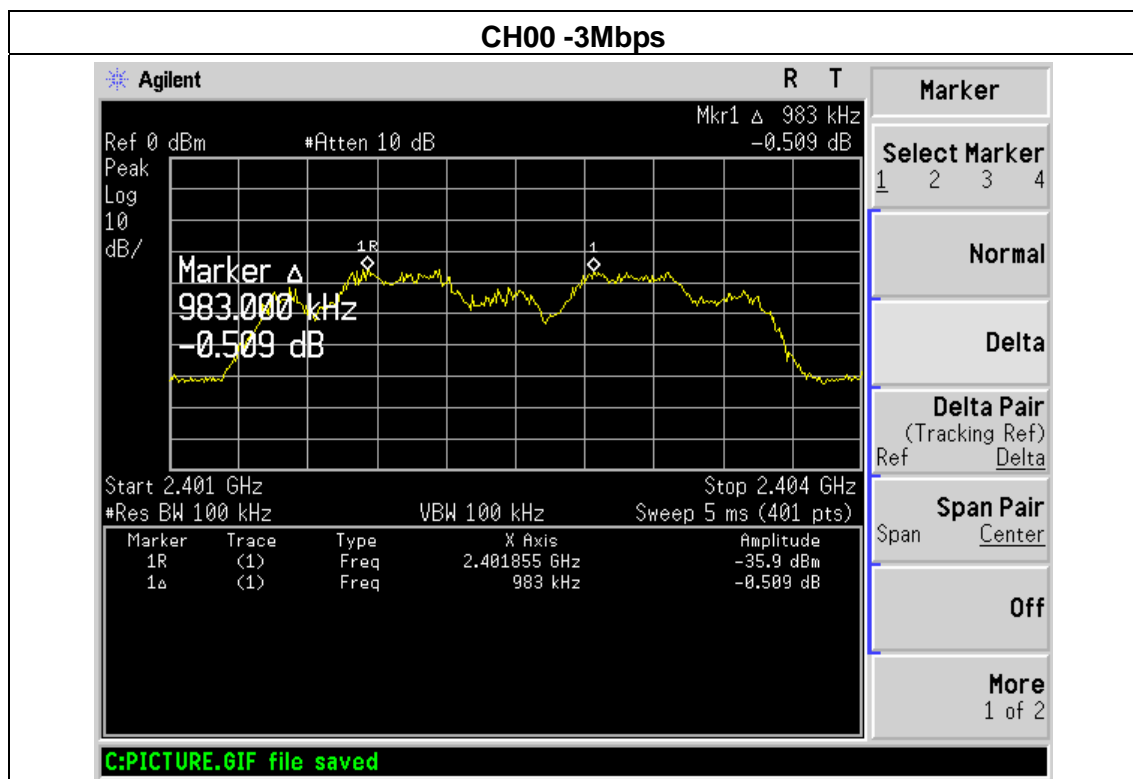

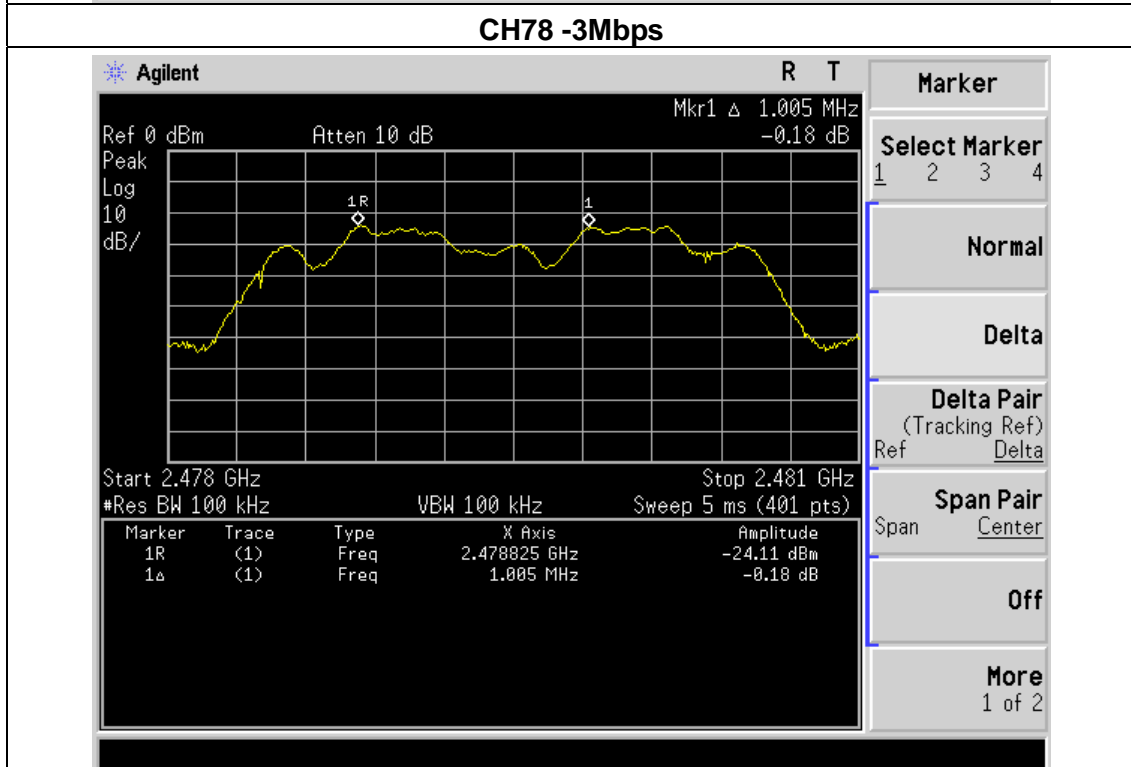
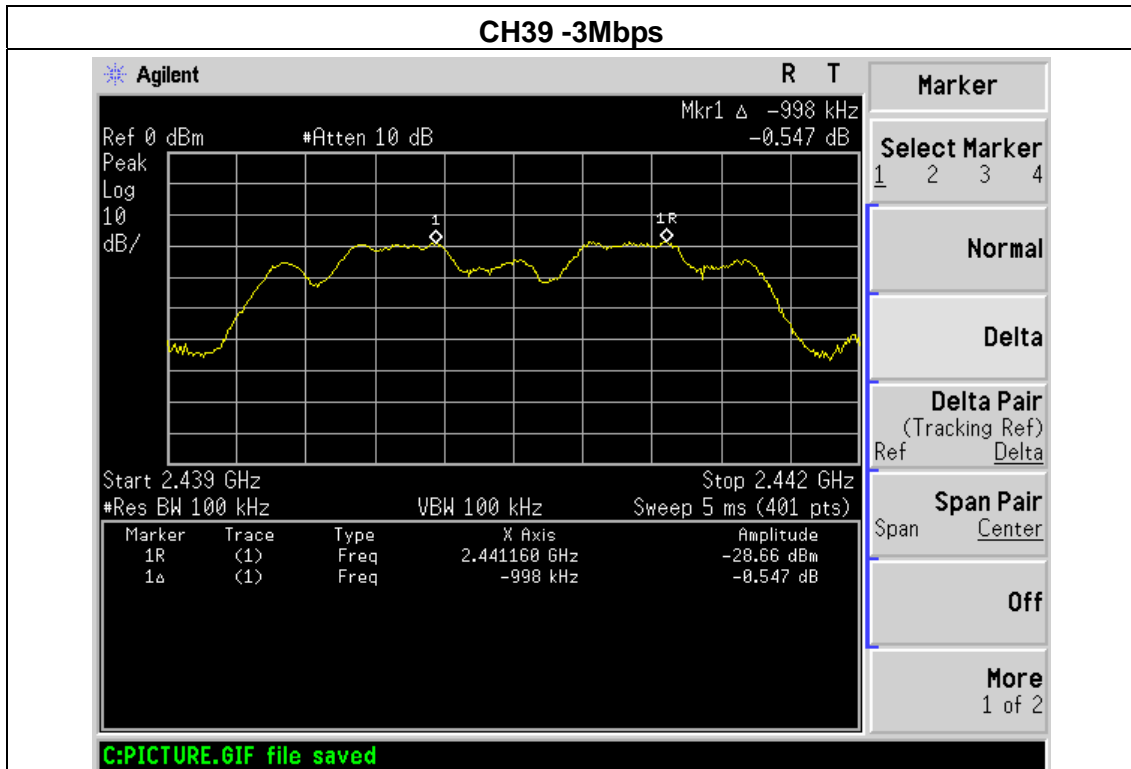

7. BANDWIDTH TEST

7.1 APPLIED PROCEDURES / LIMIT

| FCC Part15 (15.247) , Subpart C | | | | |
|---------------------------------|-----------|------------------|-----------------------|--------|
| Section | Test Item | Limit | Frequency Range (MHz) | Result |
| 15.247 (a)(1) | Bandwidth | (20dB bandwidth) | 2400-2483.5 | PASS |

| Spectrum Parameter | Setting |
|--------------------|---|
| Attenuation | Auto |
| Span Frequency | > Measurement Bandwidth or Channel Separation |
| RB | 1% of the 20 dB bandwidth |
| VB | \geq RBW |
| Detector | Peak |
| Trace | Max Hold |
| Sweep Time | Auto |

7.1.1 TEST PROCEDURE

- a. The EUT was directly connected to the spectrum analyzer and antenna output port as show in the block diagram below,
- b. Spectrum Setting : RBW= 1% of the 20 dB bandwidth, VBW \geq RBW, Sweep time = Auto.

7.1.2 DEVIATION FROM STANDARD

No deviation.

7.1.3 TEST SETUP



7.1.4 EUT OPERATION CONDITIONS

The EUT tested system was configured as the statements of 2.4 Unless otherwise a special operating condition is specified in the follows during the testing.

7.1.5 TEST RESULTS

| | | | |
|---------------|-------------------------|---------------------|---------|
| EUT : | Bluetooth Speaker | Model Name : | M77 |
| Temperature : | 25 °C | Relative Humidity : | 60% |
| Pressure : | 1012 hPa | Test Voltage : | DC 3.7V |
| Test Mode : | CH00 / CH39 /C78(1Mbps) | | |

| Frequency | 20dB Bandwidth (MHz) | Result |
|-----------|----------------------|-------------|
| 2402 MHz | 0.935 | PASS |
| 2441 MHz | 0.889 | PASS |
| 2480 MHz | 0.827 | PASS |

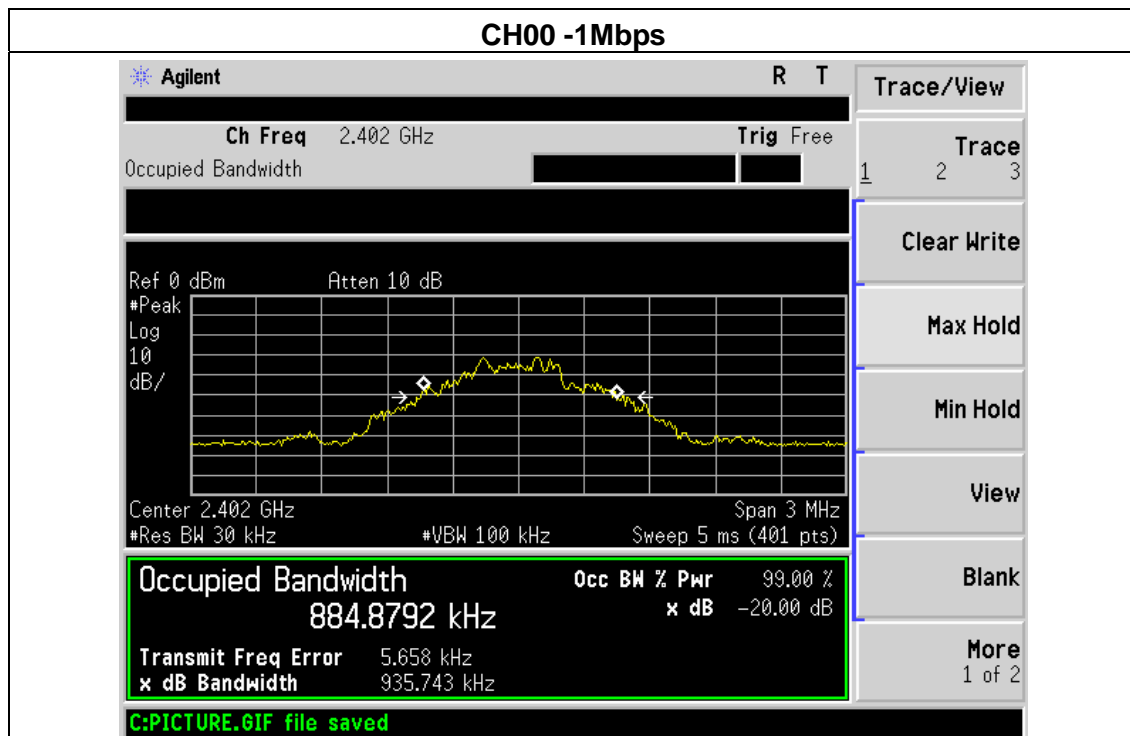

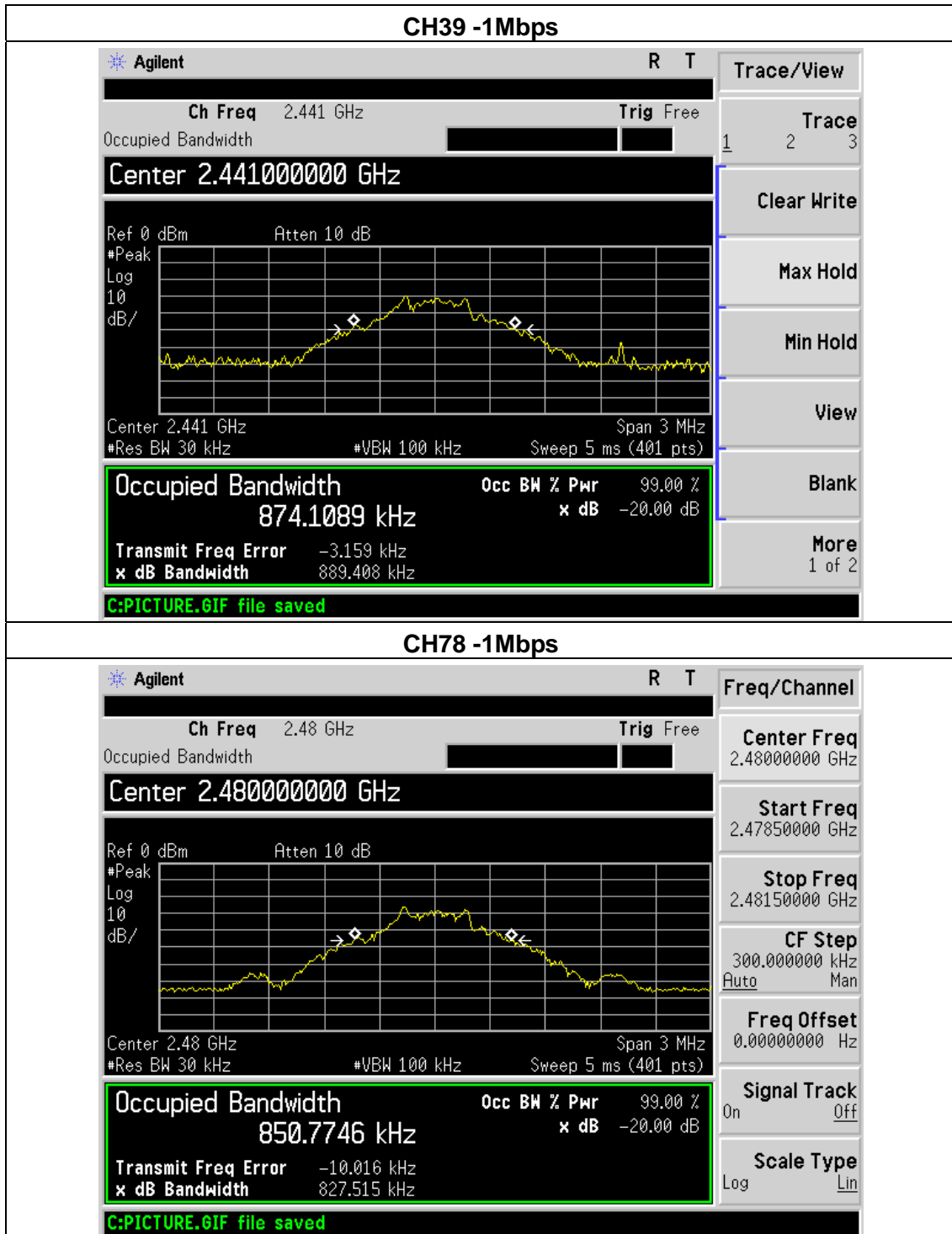

| | | | |
|---------------|-------------------------|---------------------|---------|
| EUT : | Bluetooth Speaker | Model Name : | M77 |
| Temperature : | 25 °C | Relative Humidity : | 60% |
| Pressure : | 1012 hPa | Test Voltage : | DC 3.7V |
| Test Mode : | CH00 / CH39 /C78(2Mbps) | | |

| Frequency | 20dB Bandwidth (MHz) | Result |
|-----------|----------------------|-------------|
| 2402 MHz | 1.151 | PASS |
| 2441 MHz | 1.161 | PASS |
| 2480 MHz | 1.148 | PASS |

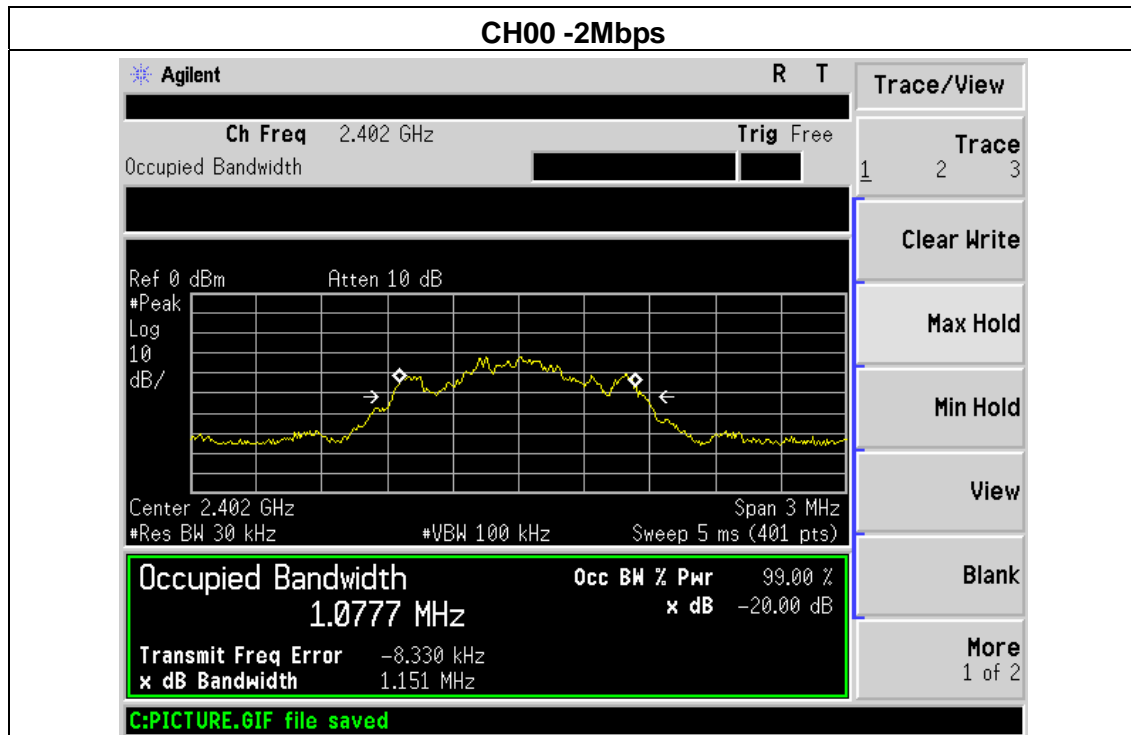

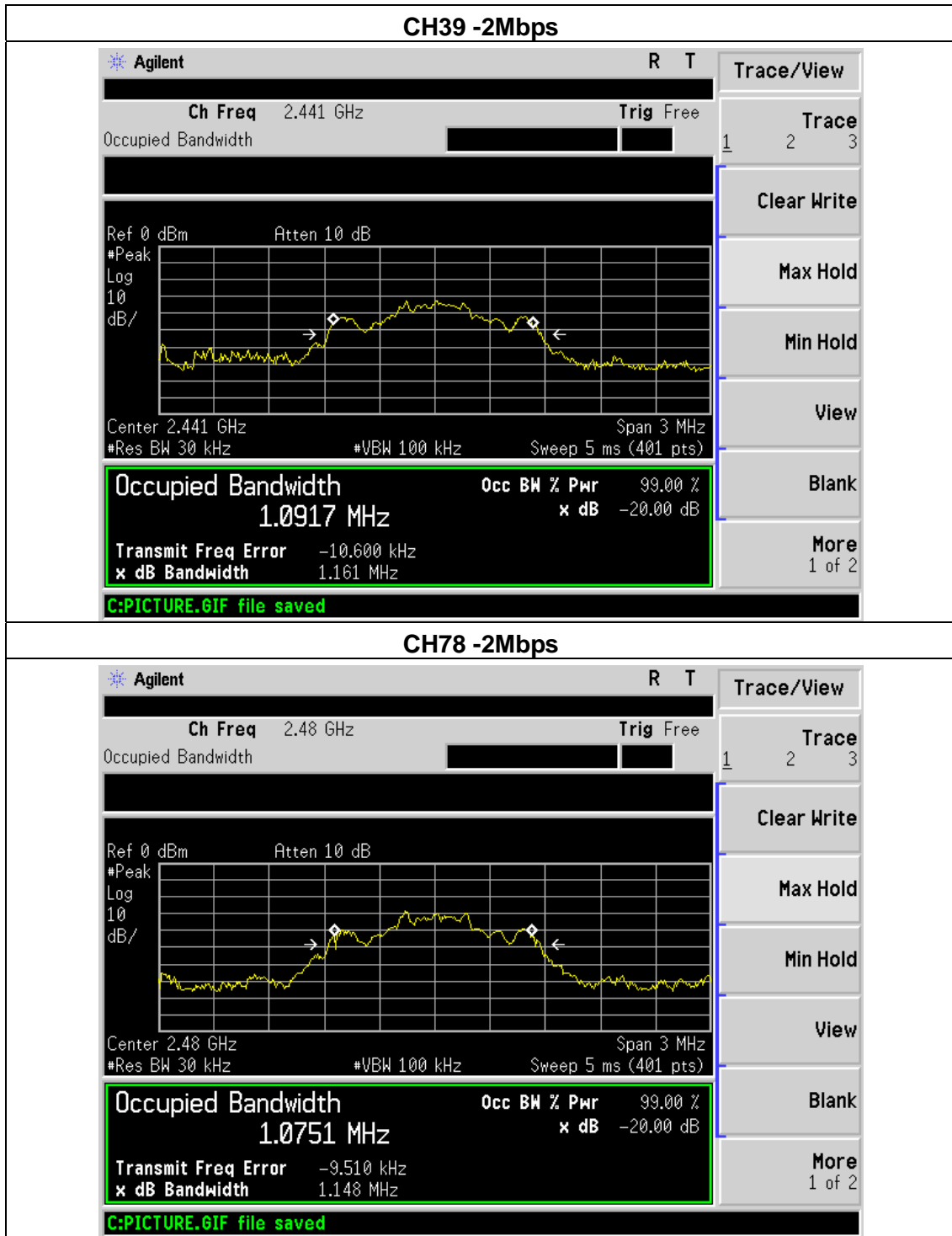

| | | | |
|---------------|-------------------------|---------------------|---------|
| EUT : | Bluetooth Speaker | Model Name : | M77 |
| Temperature : | 25 °C | Relative Humidity : | 60% |
| Pressure : | 1012 hPa | Test Voltage : | DC 3.7V |
| Test Mode : | CH00 / CH39 /C78(3Mbps) | | |

| Frequency | 20dB Bandwidth (MHz) | Result |
|-----------|----------------------|-------------|
| 2402 MHz | 1.142 | PASS |
| 2441 MHz | 1.130 | PASS |
| 2480 MHz | 1.142 | PASS |

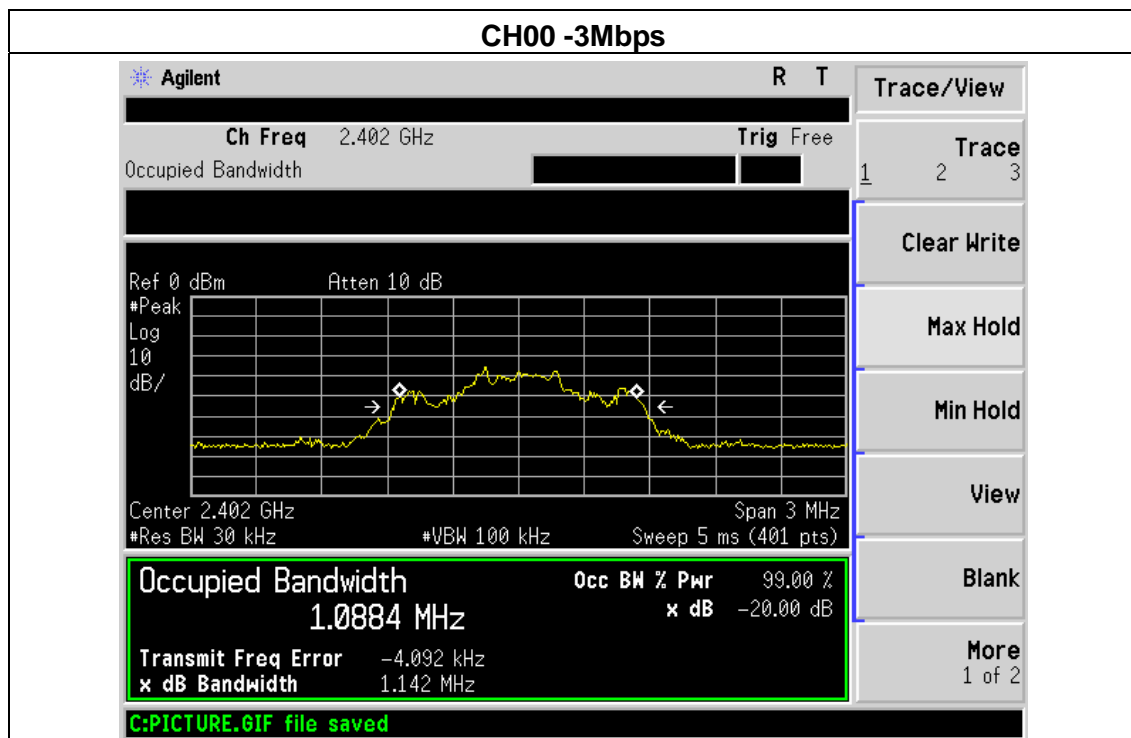

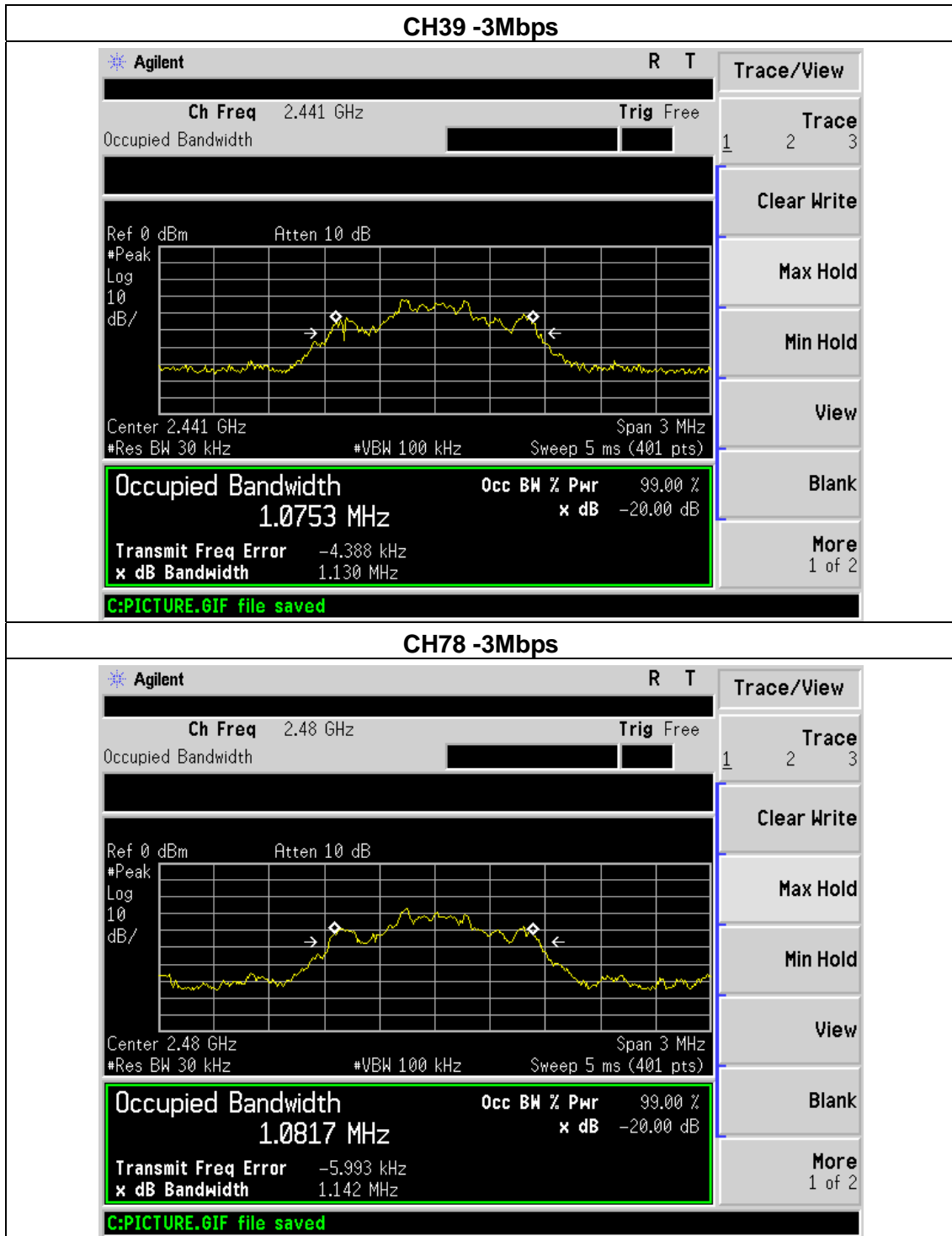

8. PEAK OUTPUT POWER TEST

8.1 APPLIED PROCEDURES / LIMIT

| FCC Part15 (15.247) , Subpart C | | | | |
|---------------------------------|-------------------|---------------------|-----------------------|--------|
| Section | Test Item | Limit | Frequency Range (MHz) | Result |
| 15.247 (b)(i) | Peak Output Power | 0.125 w or 20.96dBm | 2400-2483.5 | PASS |

8.1.1 TEST PROCEDURE

- a. The EUT was directly connected to the spectrum analyzer and antenna output port as show in the block diagram below,
- b. Spectrum Setting : RBW > the 20 dB bandwidth of the emission being measured
 - Span = approximately 5 times the 20 dB bandwidth, centered on a hopping channel
 - VBW ≥ RBW
 - Sweep = auto
 - Detector function = peak
 - Trace = max hold

8.1.2 DEVIATION FROM STANDARD

No deviation.

8.1.3 TEST SETUP

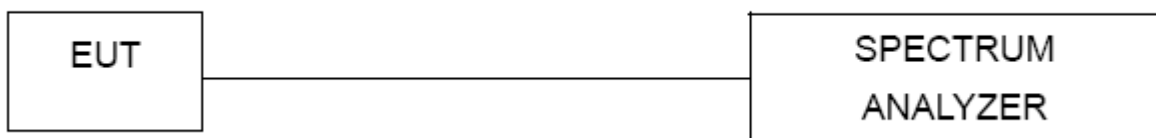

8.1.4 EUT OPERATION CONDITIONS

The EUT tested system was configured as the statements of 2.4 Unless otherwise a special operating condition is specified in the follows during the testing.

8.1.5 TEST RESULTS

| | | | |
|---------------|-------------------------------------|---------------------|---------|
| EUT : | Bluetooth Speaker | Model Name : | M77 |
| Temperature : | 25 °C | Relative Humidity : | 60% |
| Pressure : | 1012 hPa | Test Voltage : | DC 3.7V |
| Test Mode : | CH00/ CH39 /CH78 (1M/2M/3Mbps Mode) | | |

| 1Mbps | | | |
|--------------|-----------------|-------------------------|-------------|
| Test Channel | Frequency (MHz) | Peak Output Power (dBm) | LIMIT (dBm) |
| CH00 | 2402 | 1.214 | 30 |
| CH39 | 2441 | 0.458 | 30 |
| CH78 | 2480 | 1.317 | 30 |
| 2Mbps | | | |
| CH00 | 2402 | -1.757 | 20.96 |
| CH39 | 2441 | -2.120 | 20.96 |
| CH78 | 2480 | -1.897 | 20.96 |
| 3Mbps | | | |
| CH00 | 2402 | -4.393 | 20.96 |
| CH39 | 2441 | -4.729 | 20.96 |
| CH78 | 2480 | -4.339 | 20.96 |

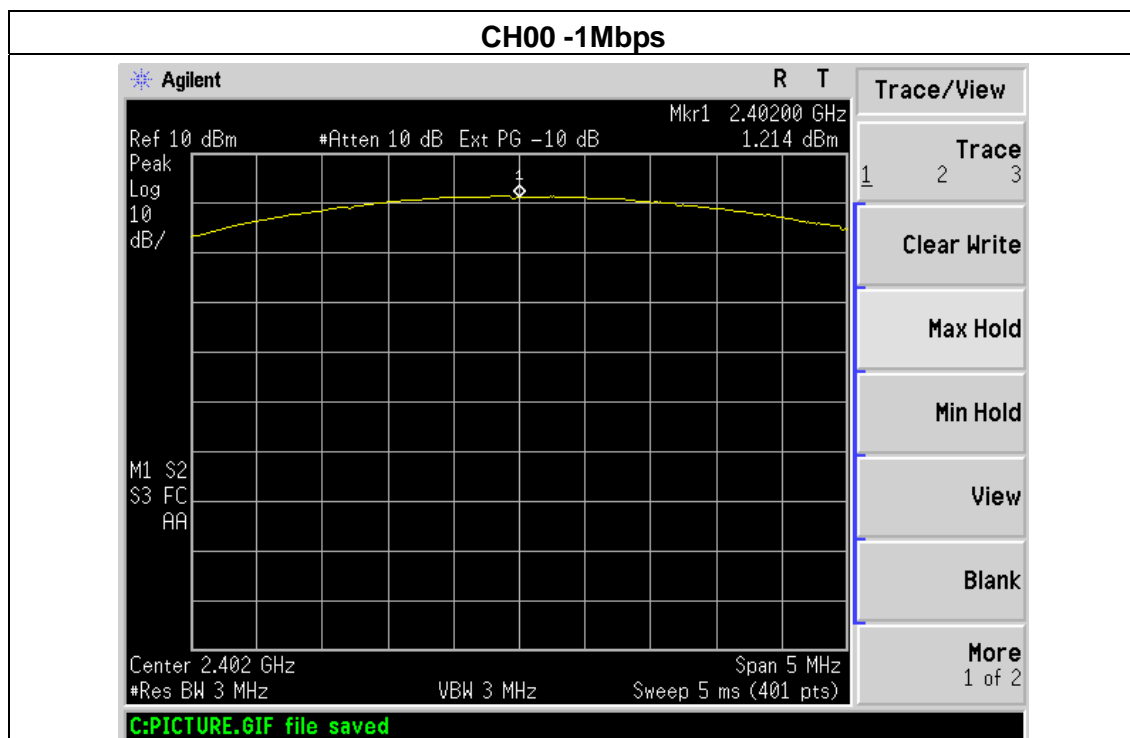

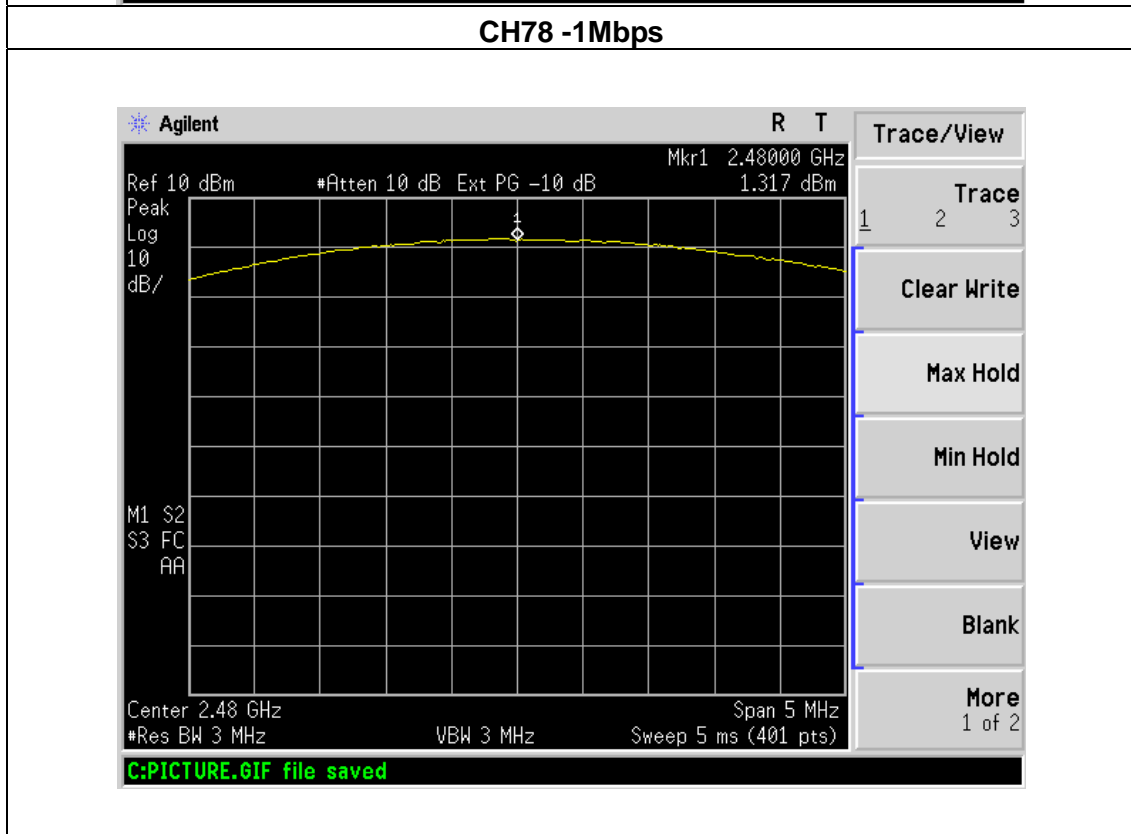
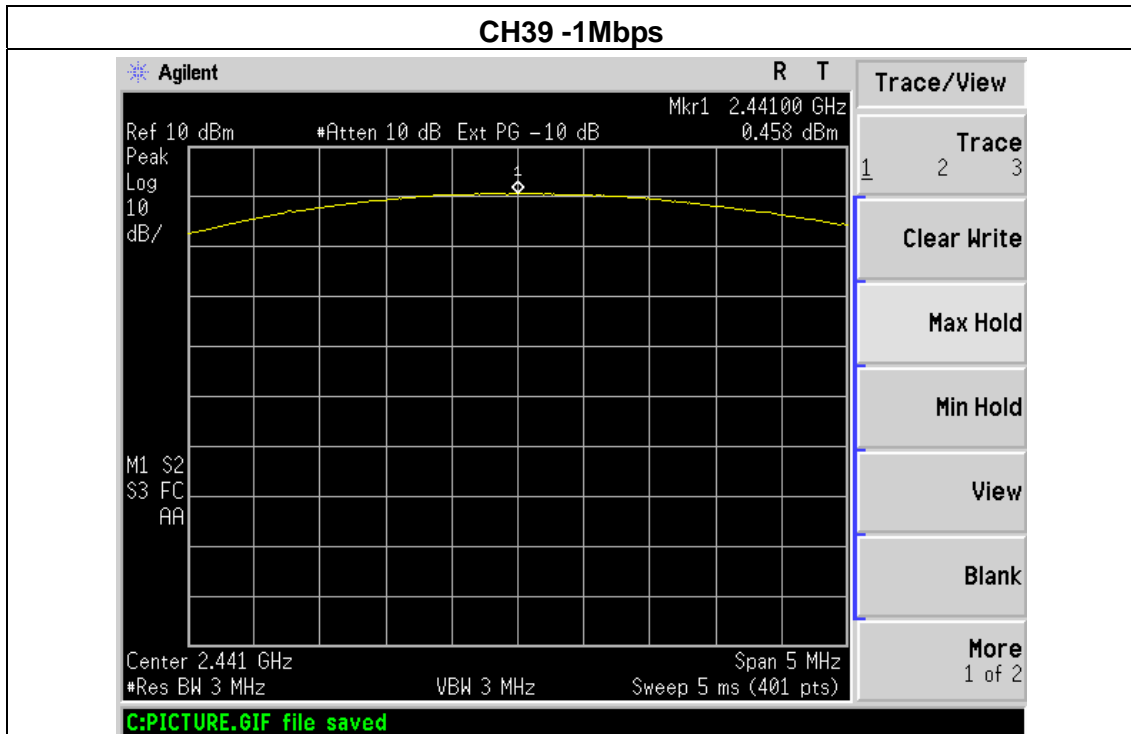

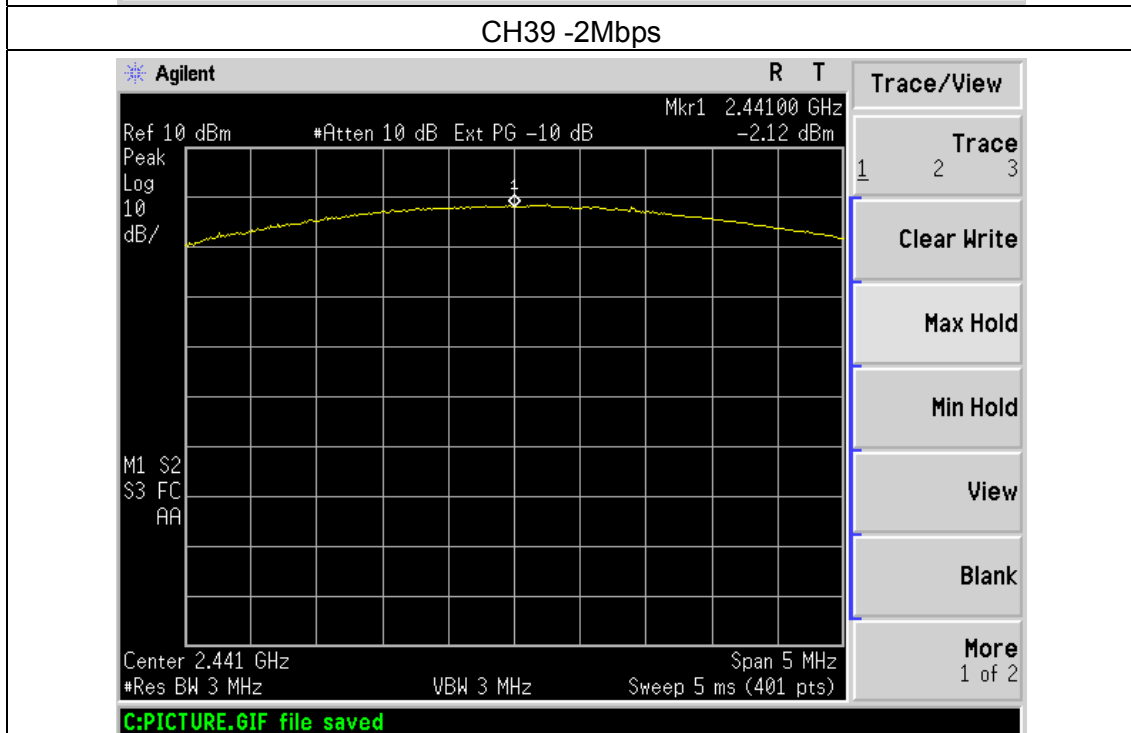
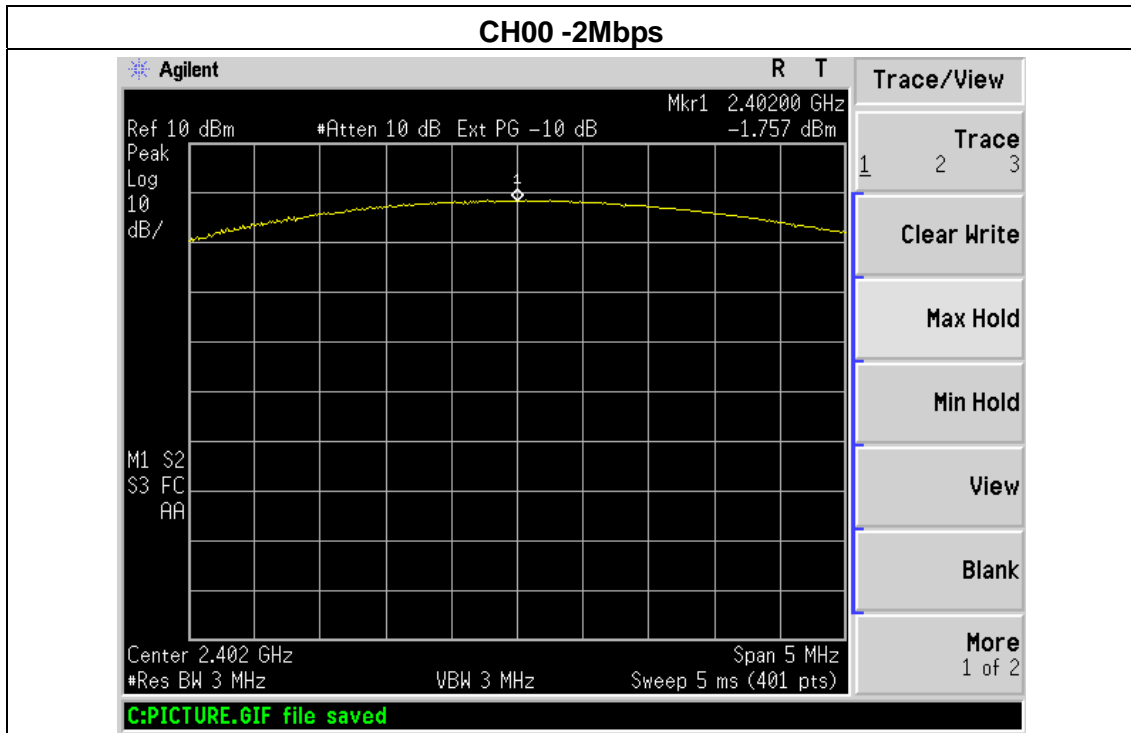

CH78 -2Mbps

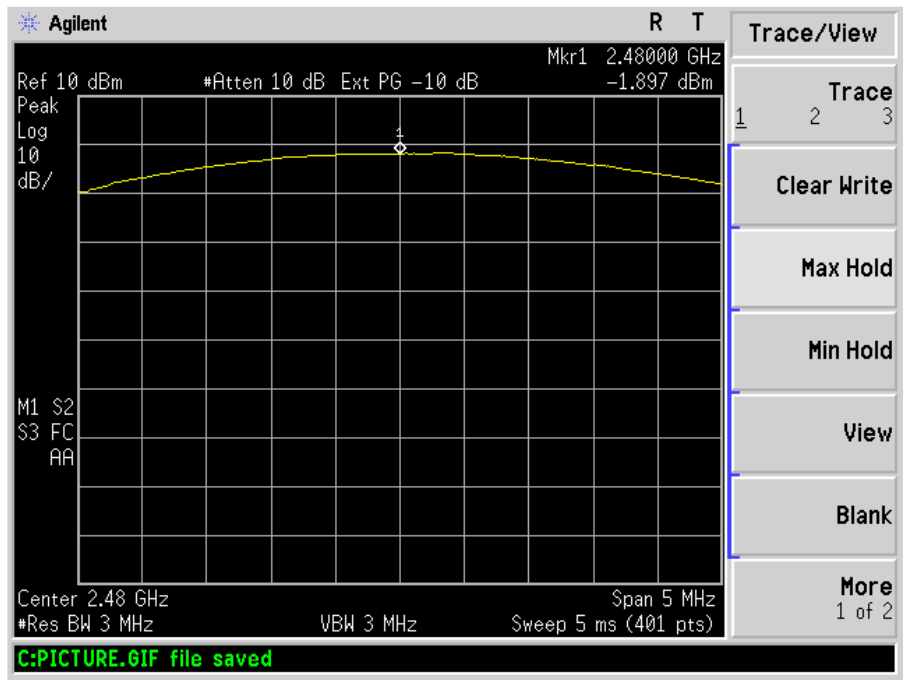

CH00 -3Mbps

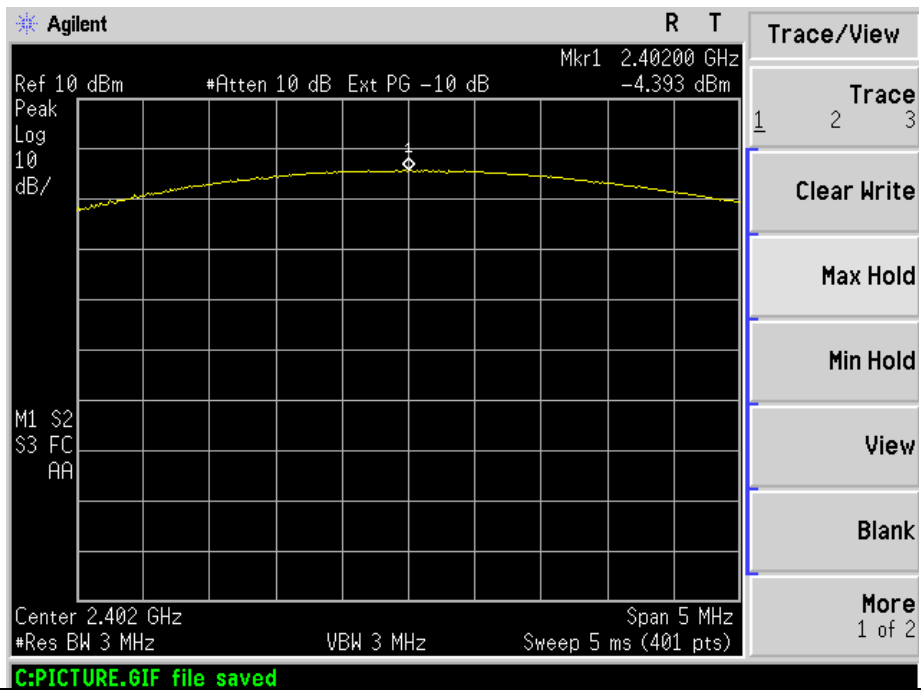

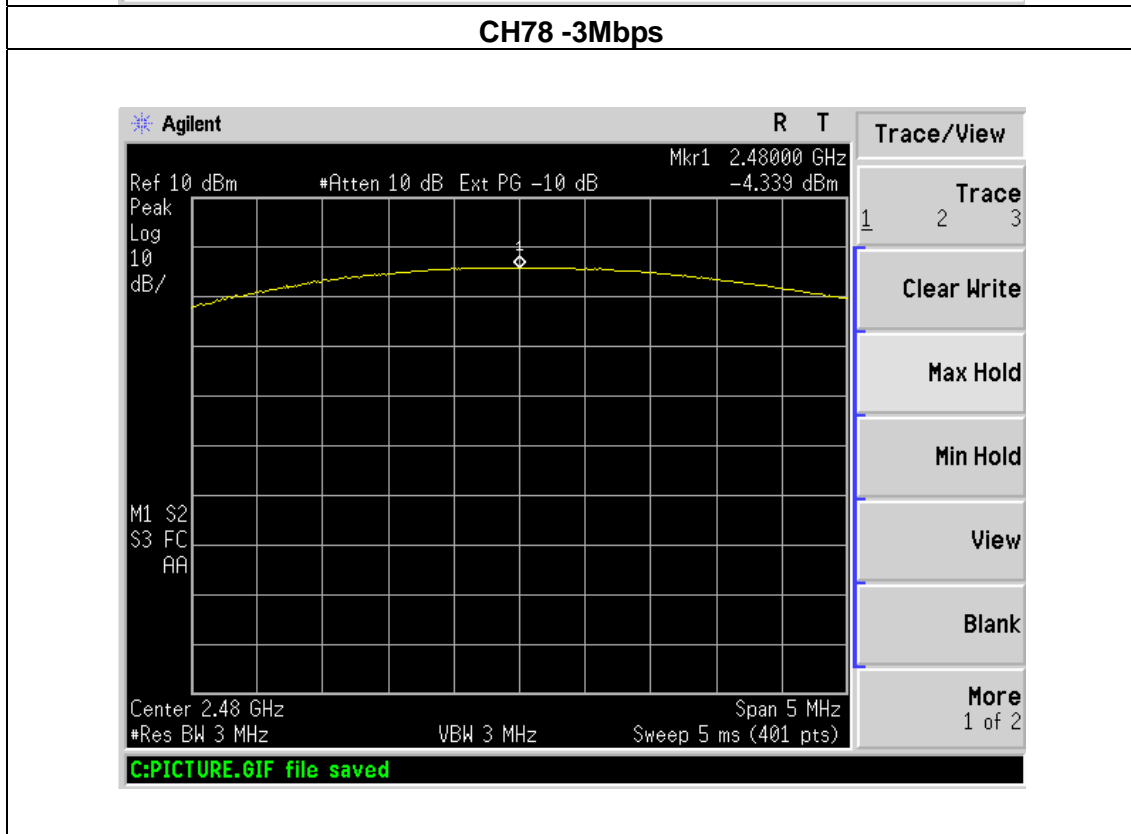
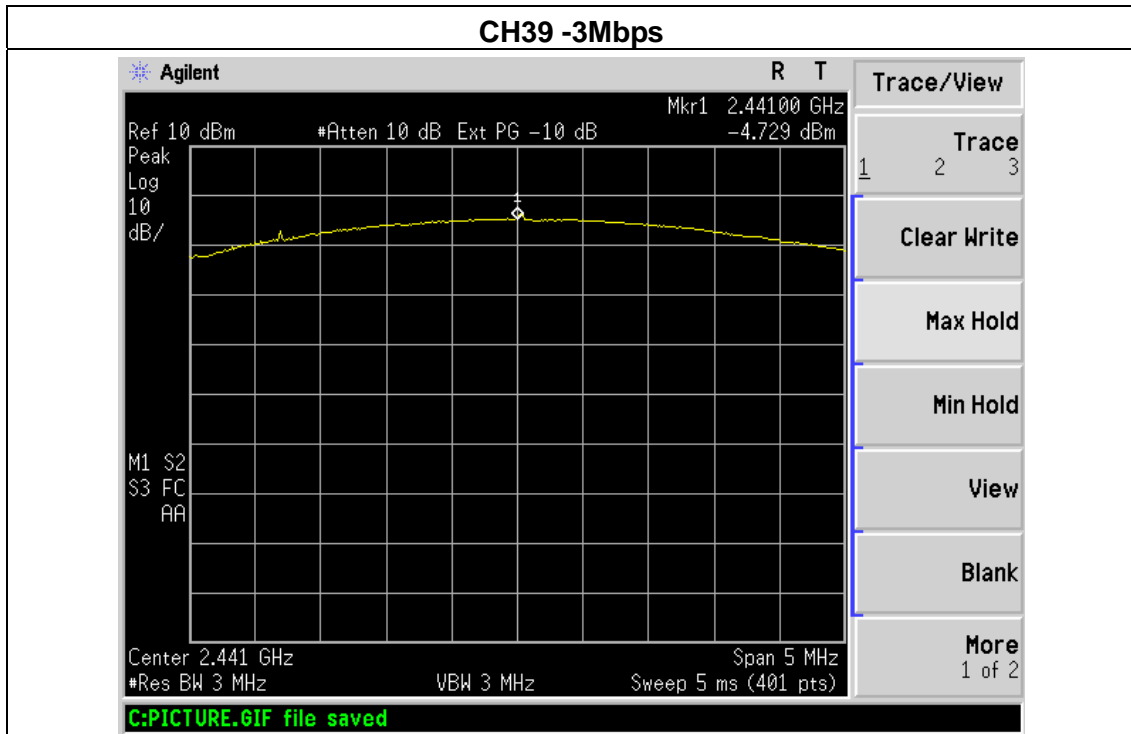

9. 100 KHZ BANDWIDTH OF FREQUENCY BAND EDGE

APPLICABLE STANDARD

In any 100 kHz bandwidth outside the frequency band in which the spread spectrum or digitally modulated intentional radiator is operating, the radio frequency power that is produced by the intentional radiator shall be at least 20 dB below that in the 100 kHz bandwidth within the band that contains the highest level of the desired power, based on either an RF conducted or a radiated measurement, provided the transmitter demonstrates compliance with the peak conducted power limits. If the transmitter complies with the conducted power limits based on the use of RMS averaging over a time interval, as permitted under paragraph (b)(3) of this section, the attenuation required under this paragraph shall be 30 dB instead of 20 dB. Attenuation below the general limits specified in §15.209(a) is not required. In addition, radiated emissions which fall in the restricted bands, as defined in §15.205(a), must also comply with the radiated emission limits specified in §15.209(a) (see §15.205(c)).

TEST PROCEDURE

- a) Check the calibration of the measuring instrument using either an internal calibrator or a known signal from an external generator.
- b) Position the EUT without connection to measurement instrument. Turn on the EUT and connect its antenna terminal to measurement instrument via a low loss cable. Then set it to any one measured frequency within its operating range, and make sure the instrument is operated in its linear range.
- c) Set RBW to 100 kHz and VBW of spectrum analyzer to 300 kHz with a convenient frequency span including 100 kHz bandwidth from band edge.
- d) Measure the highest amplitude appearing on spectral display and set it as a reference level. Plot the graph with marking the highest point and edge frequency.
- e) Repeat above procedures until all measured frequencies were complete.

9.1 DEVIATION FROM STANDARD

No deviation.

9.2 TEST SETUP

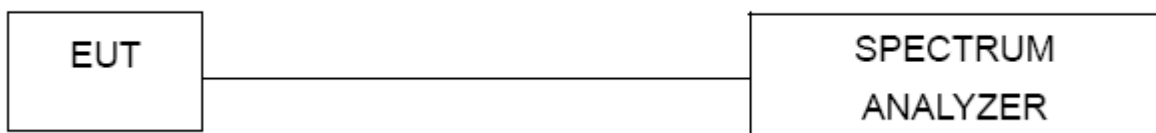

9.3 EUT OPERATION CONDITIONS

The EUT tested system was configured as the statements of 2.4 Unless otherwise a special operating condition is specified in the follows during the testing.

9.4 TEST RESULTS

| | | | |
|---------------|-------------------------------|---------------------|---------|
| EUT : | Bluetooth Speaker | Model Name : | M77 |
| Temperature : | 25 °C | Relative Humidity : | 60% |
| Pressure : | 1012 hPa | Test Voltage : | DC 3.7V |
| Test Mode : | CH00/ CH78 (1M/2M/3Mbps Mode) | | |

| Frequency Band | Delta Peak to band emission (dBc) | > Limit (dBc) | Result |
|----------------------------|-----------------------------------|---------------|--------|
| BDR mode (GFSK) | | | |
| Left-band | 42.06 | 20 | Pass |
| Right-band | 50.31 | 20 | Pass |
| EDR mode ($\pi/4$ -DQPSK) | | | |
| Left-band | 40.37 | 20 | Pass |
| Right-band | 44.95 | 20 | Pass |
| EDR mode(8DPSK) | | | |
| Left-band | 40.74 | 20 | Pass |
| Right-band | 56.22 | 20 | Pass |

BDR mode (GFSK): Band Edge-Left Side

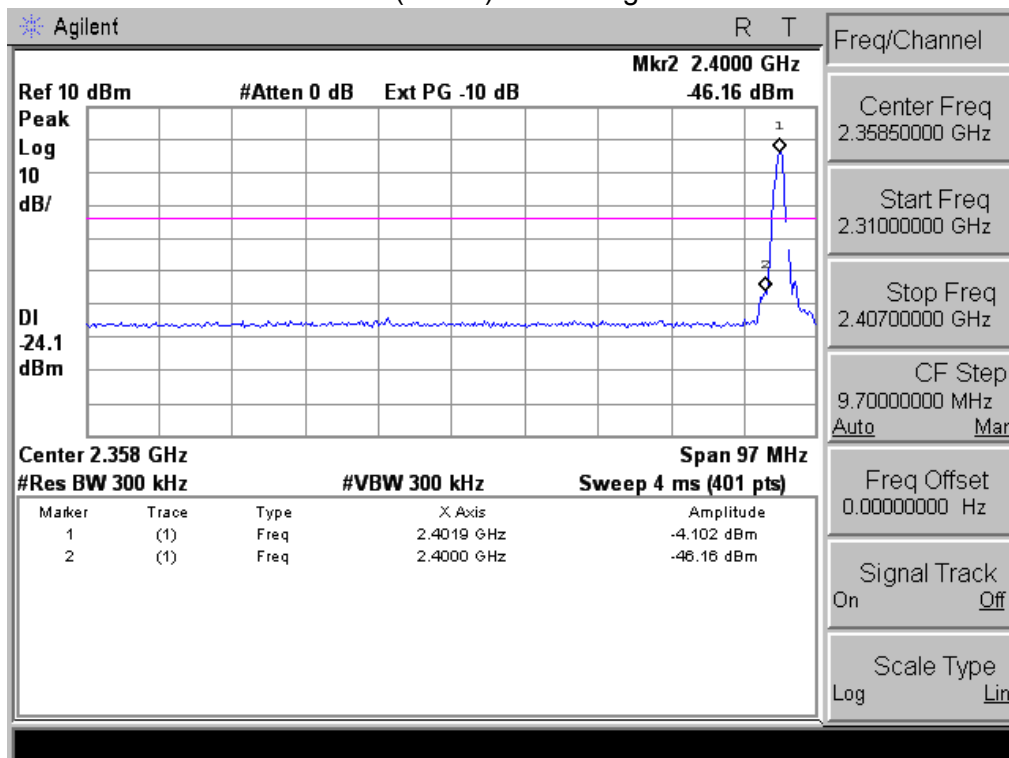

BDR mode (GFSK): Band Edge-Right Side

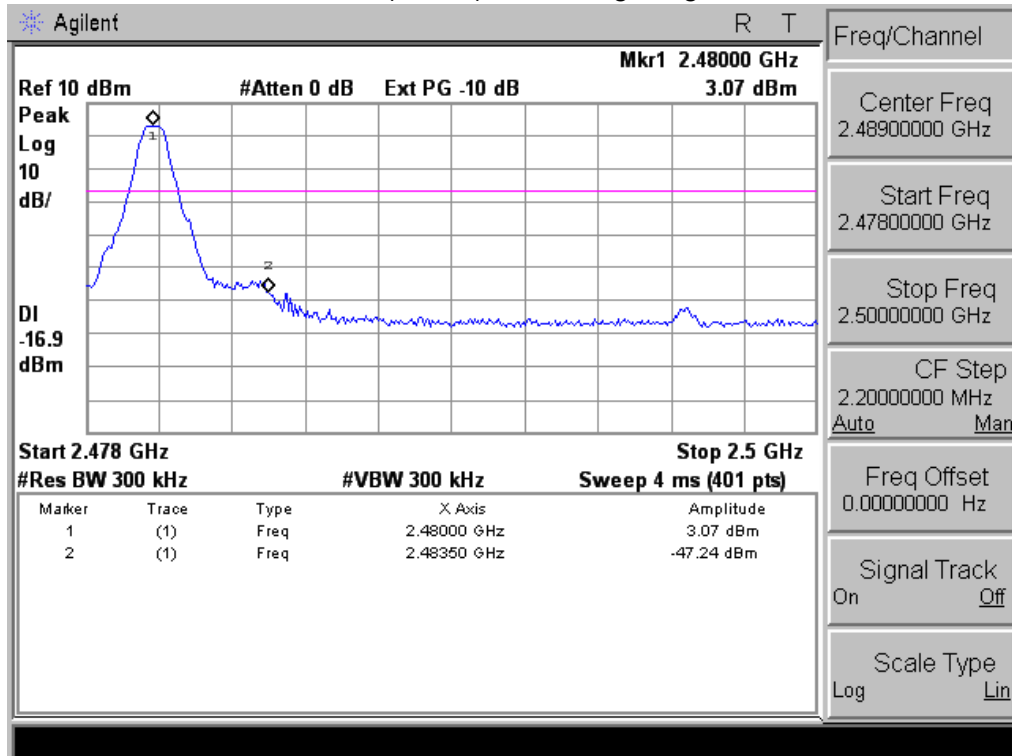

EDR mode ($\pi/4$ -DQPSK): Band Edge-Left Side

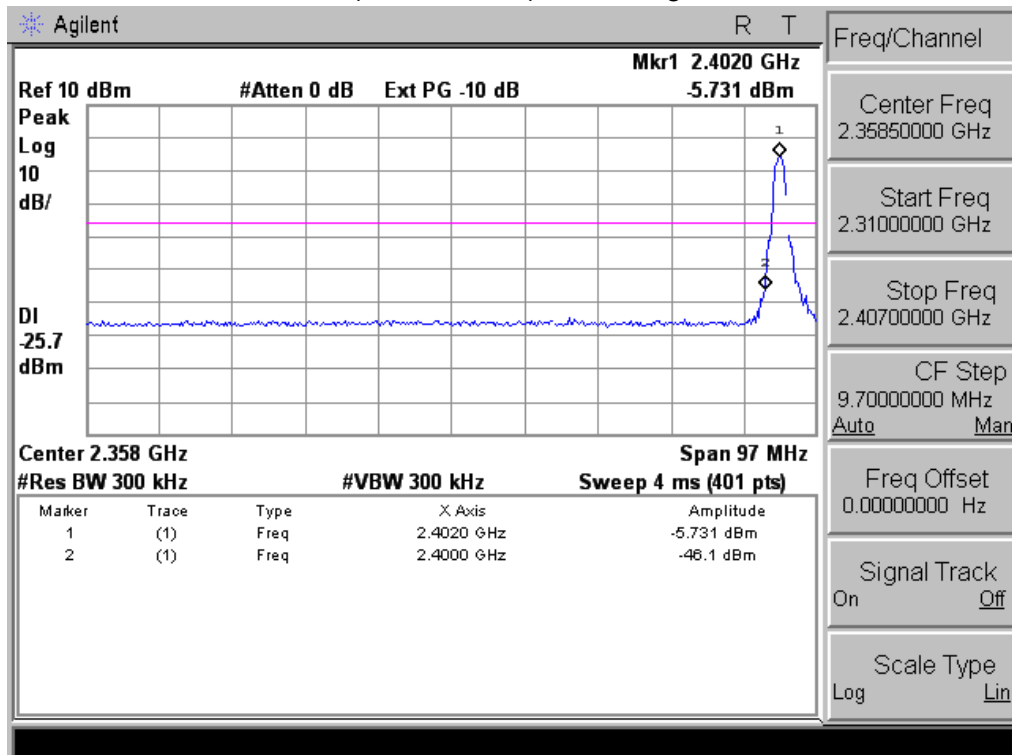

EDR mode ($\pi/4$ -DQPSK): Band Edge-Right Side

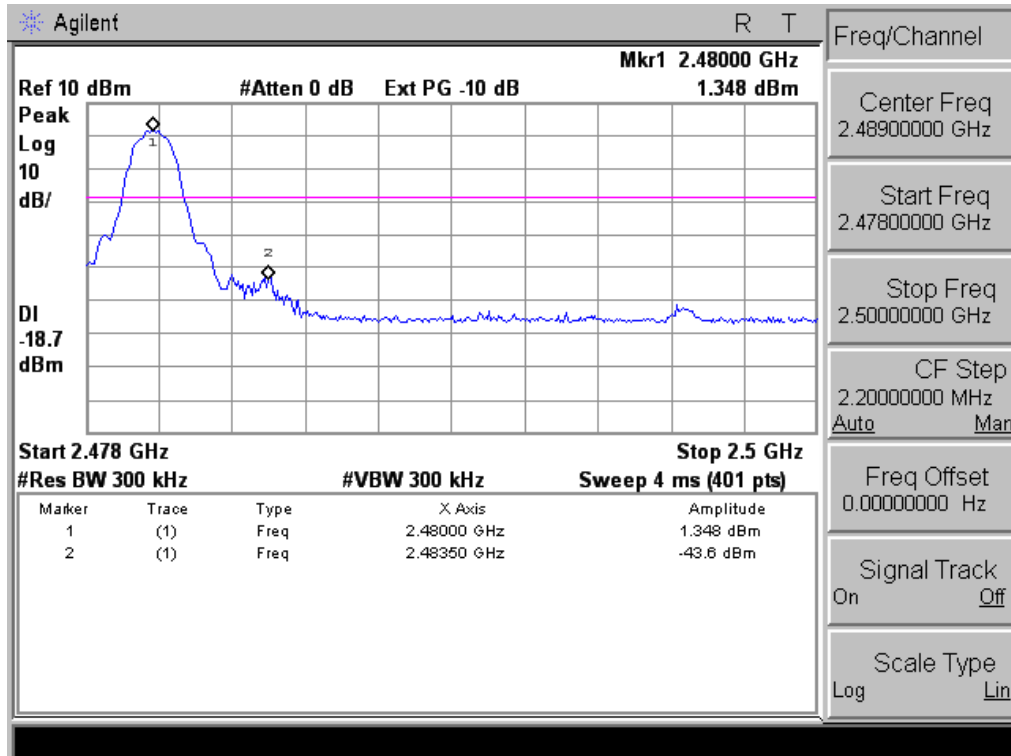

EDR mode(8DPSK): Band Edge-Left Side

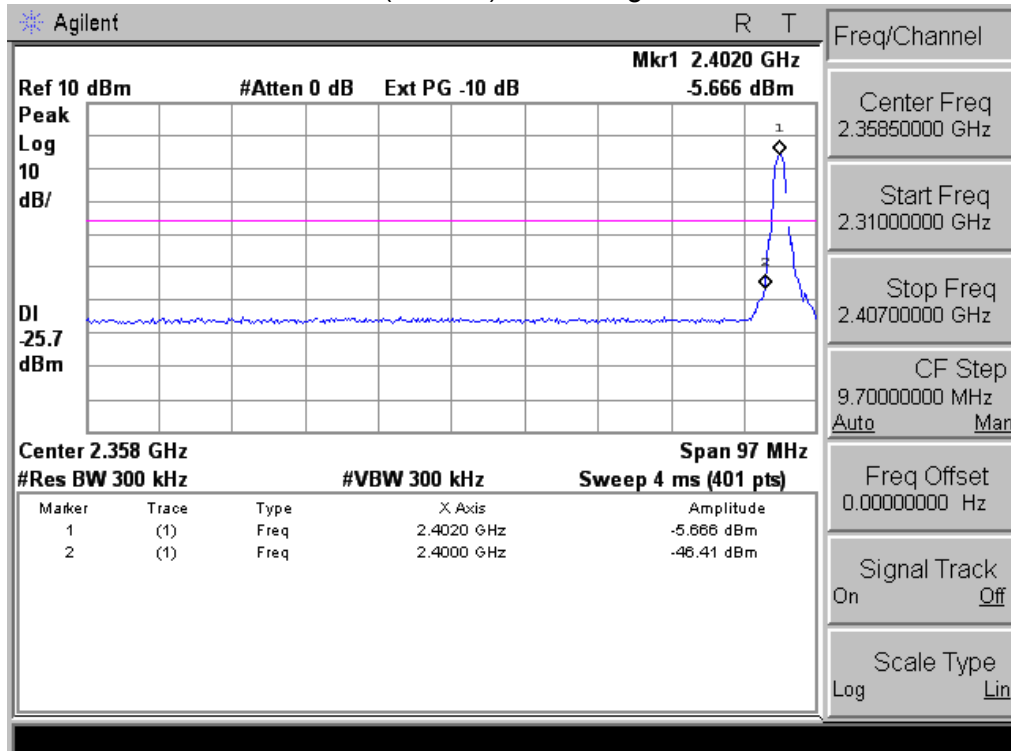

EDR mode(8DPSK): Band Edge-Right Side

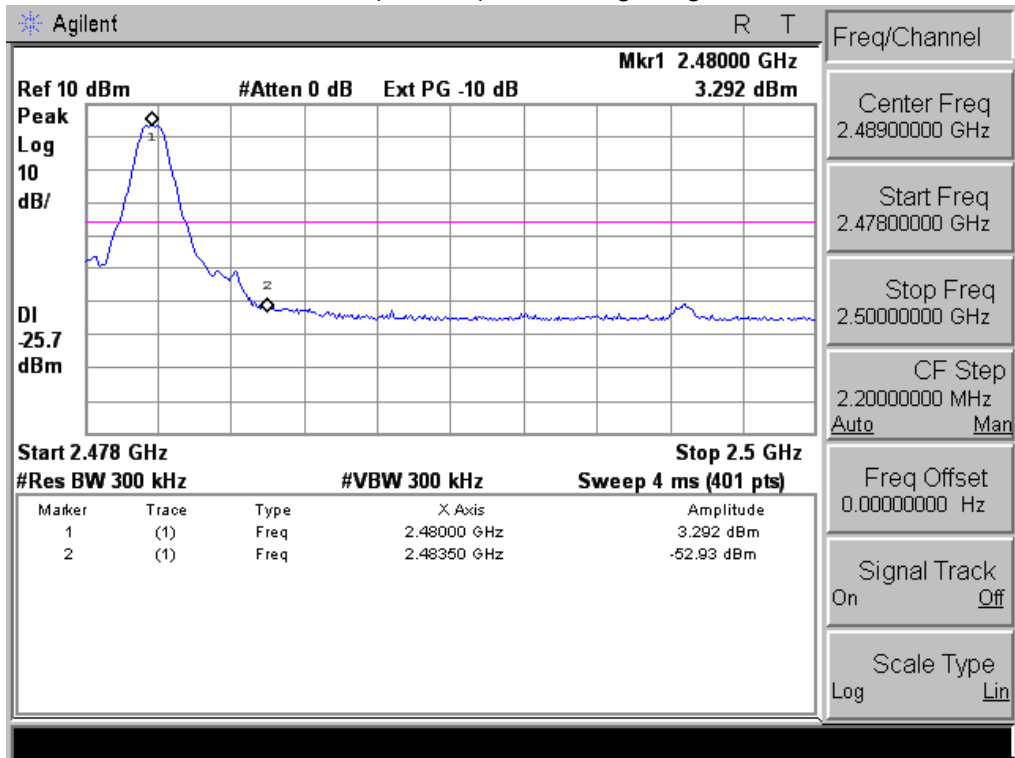

10. ANTENNA REQUIREMENT

10.1 STANDARD REQUIREMENT

15.203 requirement: For intentional device, according to 15.203: an intentional radiator shall be designed to ensure that no antenna other than that furnished by the responsible party shall be used with the device.

10.2 EUT ANTENNA

The EUT antenna is PCB antenna. It comply with the standard requirement.

11. EUT TEST PHOTO

Radiated Measurement Photos

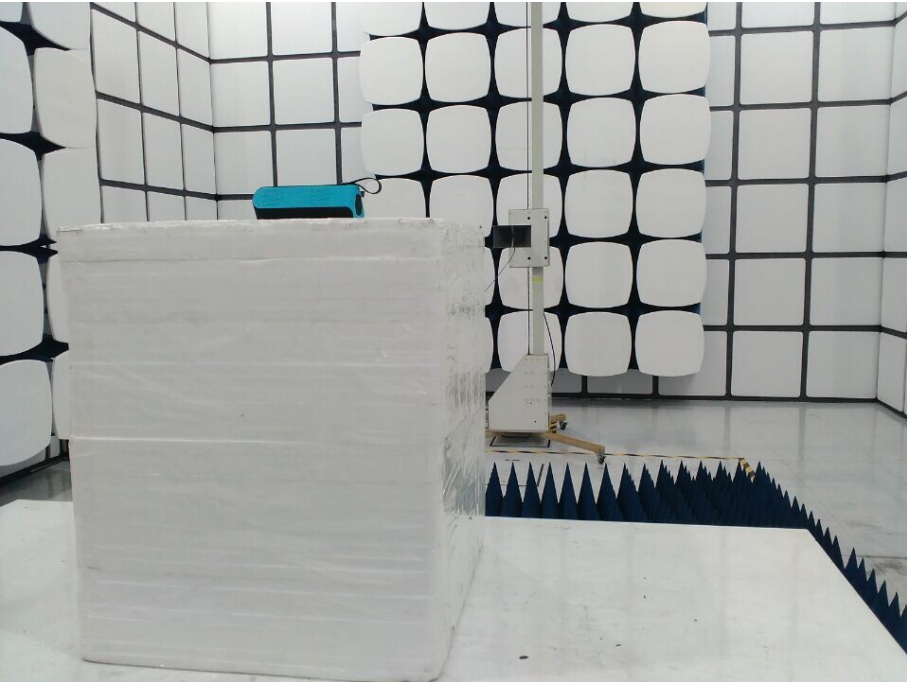
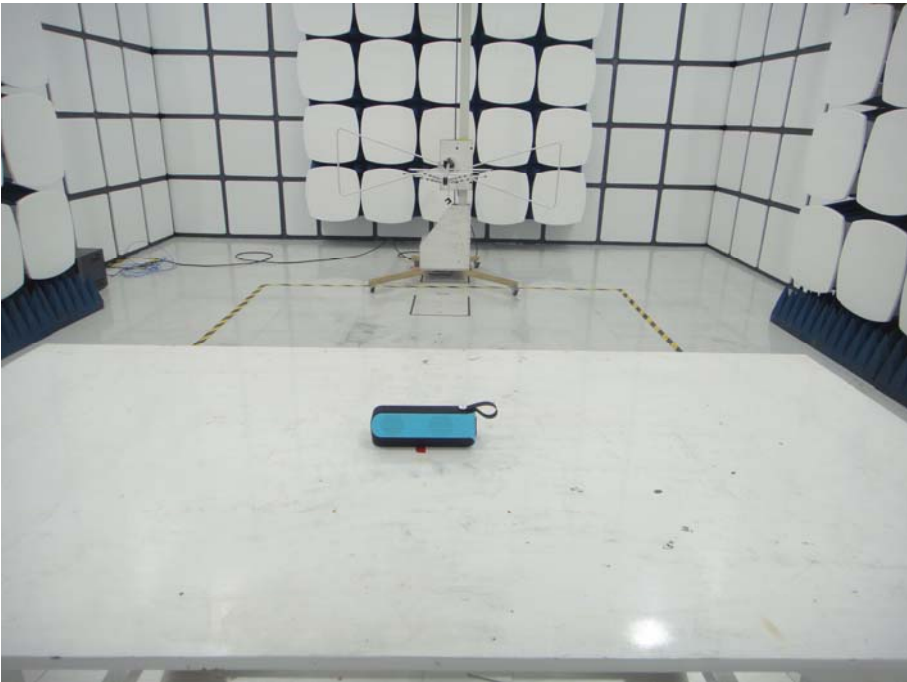

CONDUCTED EMISSION Photos

