

FCC RADIO TEST REPORT

FCC ID: 2AB9SM73

Product : Bluetooth Speaker

Trade Name : Jonter , ARGENTO SC, MUSIC BOX, JONTER

Model Name : M73, SP3036, M105, M20

Prepared for

Shenzhen Jonter Digital Co.,Ltd

3F/4B, Hezhou Jinfo Industrial Park, Hezhou, Xixiang Street, Baoan District, Shenzhen, Guangdong,
China

Prepared by

DongGuan Precise Testing Service Co.,Ltd.

Building D, Baoding Technology Park, Guangming Road 2, Guangming Community, Dongcheng
District, Dongguan, Guangdong, China



TEST RESULT CERTIFICATION

Applicant's name Shenzhen Jonter Digital Co.,Ltd
Address 3F/4B, Hezhou Jinfo Industrial Park, Hezhou, Xixiang Street, Baoan District, Shenzhen, Guangdong, China

Manufacture's Name... Shenzhen Jonter Digital Co.,Ltd
Address 3F/4B, Hezhou Jinfo Industrial Park, Hezhou, Xixiang Street, Baoan District, Shenzhen, Guangdong, China

Product description

Product name Bluetooth Speaker
Model and/or type
reference M73, SP3036, M105, M20

Standards FCC Part15.247

Test procedure C63.10:2013

This device described above has been tested by PTS, and the test results show that the equipment under test (EUT) is in compliance with the FCC requirements. And it is applicable only to the tested sample identified in the report.

This report shall not be reproduced except in full, without the written approval of PTS, this document may be altered or revised by PTS, personal only, and shall be noted in the revision of the document.

Date of Test

Date (s) of performance of tests Jul. 14, 2015 ~ Jul. 22, 2015

Date of Issue..... Jul. 22, 2015

Test Result..... **Pass**

Prepared by :

Juan Zeng /Tester

Reviewer :

Tom Zhang/Supervisor

Approved & Authorized Signer :

Chris Du/Manager

Table of Contents

	Page
1 . SUMMARY OF TEST RESULTS	3
1.1 TEST FACILITY	4
1.2 MEASUREMENT UNCERTAINTY	4
2 . GENERAL INFORMATION	5
2.1 GENERAL DESCRIPTION OF EUT	5
2.2 DESCRIPTION OF TEST MODES	7
2.3 TABLE OF PARAMETERS OF TEXT SOFTWARE SETTING	7
2.4 BLOCK DIGRAM SHOWING THE CONFIGURATION OF SYSTEM TESTED	8
2.5 DESCRIPTION OF SUPPORT UNITS(CONDUCTED MODE)	9
2.6 EQUIPMENTS LIST FOR ALL TEST ITEMS	10
3 . EMC EMISSION TEST	11
3.1 CONDUCTED EMISSION MEASUREMENT	11
3.1.1 POWER LINE CONDUCTED EMISSION LIMITS	11
3.1.2 TEST PROCEDURE	12
3.1.3 DEVIATION FROM TEST STANDARD	12
3.1.4 TEST SETUP	12
3.1.5 EUT OPERATING CONDITIONS	12
3.1.6 TEST RESULTS	13
3.2 RADIATED EMISSION MEASUREMENT	17
3.2.1 RADIATED EMISSIONLIMITS(FREQUENCY RANGE 9KHZ-1000MHZ)	17
3.2.2 TEST PROCEDURE	17
3.2.3 DEVIATION FROM TEST STANDARD	18
3.2.4 TEST SETUP	18
3.2.5 EUT OPERATING CONDITIONS	19
3.2.6 TEST RESULTS (BELOW 1G)	20
3.2.7 TEST RESULTS (ABOVE 1000 MHZ)	22
3.2.8 TEST RESULTS (RESTRICTED BANDS REQUIREMENTS)	40
4 . NUMBER OF HOPPING CHANNEL	52
4.1 APPLIED PROCEDURES / LIMIT	52
4.1.1 TEST PROCEDURE	52
4.1.2 DEVIATION FROM STANDARD	52
4.1.3 TEST SETUP	52
4.1.4 EUT OPERATION CONDITIONS	52
4.1.5 TEST RESULTS	53

Table of Contents		Page
5 . AVERAGE TIME OF OCCUPANCY		54
5.1 APPLIED PROCEDURES / LIMIT		54
5.1.1 TEST PROCEDURE		54
5.1.2 DEVIATION FROM STANDARD		54
5.1.3 TEST SETUP		55
5.1.4 EUT OPERATION CONDITIONS		55
5.1.5 TEST RESULTS		56
6 . HOPPING CHANNEL SEPARATION MEASUREMENT		62
6.1 APPLIED PROCEDURES / LIMIT		62
6.1.1 TEST PROCEDURE		62
6.1.2 DEVIATION FROM STANDARD		62
6.1.3 TEST SETUP		62
6.1.4 EUT OPERATION CONDITIONS		62
6.1.5 TEST RESULTS		63
7 . BANDWIDTH TEST		69
7.1 APPLIED PROCEDURES / LIMIT		69
7.1.1 TEST PROCEDURE		69
7.1.2 DEVIATION FROM STANDARD		69
7.1.3 TEST SETUP		69
7.1.4 EUT OPERATION CONDITIONS		69
7.1.5 TEST RESULTS		70
8 . PEAK OUTPUT POWER TEST		76
8.1 APPLIED PROCEDURES / LIMIT		76
8.1.1 TEST PROCEDURE		76
8.1.2 DEVIATION FROM STANDARD		76
8.1.3 TEST SETUP		76
8.1.4 EUT OPERATION CONDITIONS		76
8.1.5 TEST RESULTS		77
9 . ANTENNA REQUIREMENT		82
9.1 STANDARD REQUIREMENT		82
9.2 EUT ANTENNA		82
10 . EUT TEST PHOTO		83
APPENDIX-PHOTOGRAPHS OF EUT CONSTRUCTIONAL DETAILS		

1. SUMMARY OF TEST RESULTS

Test procedures according to the technical standards:

FCC Part15 (15.247) , Subpart C			
Standard Section	Test Item	Judgment	Remark
15.207	Conducted Emission	PASS	
15.247(a)(1)	Hopping Channel Separation	PASS	
15.247(b)(1)	Peak Output Power	PASS	
15.247(c)	Radiated Spurious Emission	PASS	
15.247(a)(iii)	Number of Hopping Frequency	PASS	
15.247(a)(iii)	Dwell Time	PASS	
15.247(a)(1)	Bandwidth	PASS	
15.205	Band Edge Emission	PASS	
15.203	Antenna Requirement	PASS	

1.1 TEST FACILITY

Dongguan Precise Testing Service Co., Ltd.
 Add. : Building D, Baoding Technology Park, Guangming Road2, Dongcheng District, Dongguan,
 Guangdong, China
 FCC Registration No.: 371540

1.2 MEASUREMENT UNCERTAINTY

The reported uncertainty of measurement $y \pm U$, where expanded uncertainty U is based on a standard uncertainty multiplied by a coverage factor of $k=2$, providing a level of confidence of approximately **95** %.

No.	Item	Uncertainty
1	Conducted Emission Test	$\pm 1.38\text{dB}$
2	RF power,conducted	$\pm 0.16\text{dB}$
3	Spurious emissions,conducted	$\pm 0.21\text{dB}$
4	All emissions,radiated(<1G)	$\pm 4.68\text{dB}$
5	All emissions,radiated(>1G)	$\pm 4.89\text{dB}$
6	Temperature	$\pm 0.5^{\circ}\text{C}$
7	Humidity	$\pm 2\%$

2. GENERAL INFORMATION

2.1 GENERAL DESCRIPTION OF EUT

Equipment	Bluetooth Speaker	
Trade Name	Jonter, ARGENTO SC, MUSIC BOX, JONTER	
Model Name	M73	
Serial Model	SP3036, M105, M20	
Model Difference	All the same, Only model name is different	
Product Description	The EUT is a Bluetooth Speaker	
	Operation Frequency:	2402~2480 MHz
	Modulation Type:	BT(1Mbps): GFSK BT EDR(2Mbps): II/4-DQPSK BT EDR(3Mbps): 8-DPSK
	Bit Rate of Transmitter	1Mbps/2Mbps/3Mbps
	Number Of Channel	79 CH
	Antenna Designation:	Please see Note 3.
	Output Power(Conducted):	BT(1Mbps): 3.259dBm BT EDR(2Mbps): 2.913dBm BT EDR(3Mbps): 2.190dBm
	Based on the application, features, or specification exhibited in User's Manual, the EUT is considered as an ITE/Computing Device. More details of EUT technical specification, please refer to the User's Manual.	
Channel List	Please refer to the Note 2.	
Battery	DC 3.7V	
Adapter	Model:MX510-0501000C AC Power Input: 100-240V~, 50-60Hz, 0.2A Output: 5.0V $\overline{\text{---}}$, 1000mA	
Connecting I/O Port(s)	Please refer to the User's Manual	

Note:

1. For a more detailed features description, please refer to the manufacturer's specifications or the User's Manual.

2.

Channel List					
Channel	Frequency (MHz)	Channel	Frequency (MHz)	Channel	Frequency (MHz)
00	2402	27	2429	54	2456
01	2403	28	2430	55	2457
02	2404	29	2431	56	2458
03	2405	30	2432	57	2459
04	2406	31	2433	58	2460
05	2407	32	2434	59	2461
06	2408	33	2435	60	2462
07	2409	34	2436	61	2463
08	2410	35	2437	62	2464
09	2411	36	2438	63	2465
10	2412	37	2439	64	2466
11	2413	38	2440	65	2467
12	2414	39	2441	66	2468
13	2415	40	2442	67	2469
14	2416	41	2443	68	2470
15	2417	42	2444	69	2471
16	2418	43	2445	70	2472
17	2419	44	2446	71	2473
18	2420	45	2447	72	2474
19	2421	46	2448	73	2475
20	2422	47	2449	74	2476
21	2423	48	2450	75	2477
22	2424	49	2451	76	2478
23	2425	50	2452	77	2479
24	2426	51	2453	78	2480
25	2427	52	2454		
26	2428	53	2455		

3.

Table for Filed Antenna

Ant	Brand	Model Name	Antenna Type	Connector	Gain (dBi)	NOTE
1	N/A	N/A	PCB Printed antenna	N/A	1.0	BT Antenna

2.2 DESCRIPTION OF TEST MODES

To investigate the maximum EMI emission characteristics generates from EUT, the test system was pre-scanning tested base on the consideration of following EUT operation mode or test configuration mode which possible have effect on EMI emission level. Each of these EUT operation mode(s) or test configuration mode(s) mentioned above was evaluated respectively.

Pretest Mode	Description
Mode 1	CH00
Mode 2	CH39
Mode 3	CH78
Mode 4	Link

For Conducted Emission	
Final Test Mode	Description
Mode 4	Link

For Radiated Emission	
Final Test Mode	Description
Mode 1	CH00
Mode 2	CH39
Mode 3	CH78

Note:

- (1) The measurements are performed at the highest, middle, lowest available channels.
- (2) The EUT use new battery.
- (3)The data rate was set in 1Mbps for radiated emission due to the highest RF output power.

2.3 TABLE OF PARAMETERS OF TEXT SOFTWARE SETTING

During testing channel & power controlling software provided by the customer was used to control the operating channel as well as the output power level. The RF output power selection is for the setting of RF output power expected by the customer and is going to be fixed on the firmware of the final end product power parameters of FHSS

Test software Version	Test program: BC57F687		
Frequency	2402 MHz	2441 MHz	2480 MHz
Parameters(1Mbps/2Mbps/3Mbps)	DEF	DEF	DEF

2.4 BLOCK DIGRAM SHOWING THE CONFIGURATION OF SYSTEM TESTED

Conducted Emission

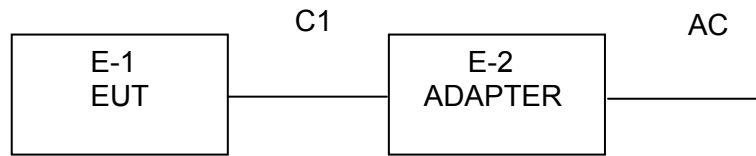

Radiated Emission

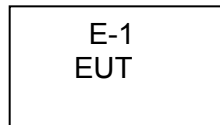

2.5 DESCRIPTION OF SUPPORT UNITS(CONDUCTED MODE)

The EUT has been tested as an independent unit together with other necessary accessories or support units. The following support units or accessories were used to form a representative test configuration during the tests.

Item	Equipment	Mfr/Brand	Model/Type No.	Series No.	Note
E-1	Bluetooth Speaker	Jonter	M73	N/A	EUT
E-2	Adapter	N/A	MX510-0501000C	N/A	

Item	Shielded Type	Ferrite Core	Length	Note
C-1	NO	NO	0.9M	

Note:

- (1) The support equipment was authorized by Declaration of Confirmation.
- (2) For detachable type I/O cable should be specified the length in cm in 『Length』 column.
- (3) “YES” is means “shielded” “with core”; “NO” is means “unshielded” “without core”.

2.6 EQUIPMENTS LIST FOR ALL TEST ITEMS

Radiation Test equipment

Item	Kind of Equipment	Manufacturer	Type No.	Serial No.	Last calibration	Calibrated until	Calibration period
1	Spectrum Analyzer	Agilent	E4407B	MY45108040	2015.07.06	2016.07.05	1 year
2	Test Receiver	R&S	ESPI	101318	2015.06.07	2016.06.06	1 year
3	Bilog Antenna	TESEQ	CBL6111D	31216	2015.07.06	2016.07.05	1 year
4	50Ω Coaxial Switch	Anritsu	MP59B	6200264416	2015.06.07	2016.06.06	1 year
5	Spectrum Analyzer	ADVANTEST	R3132	150900201	2015.06.07	2016.06.06	1 year
6	Horn Antenna	EM	EM-AH-10180	2011071402	2015.07.06	2016.07.05	1 year
7	Horn Ant	Schwarzbeck	BBHA 9170	9170-181	2015.07.06	2016.07.05	1 year
8	Amplifier	EM	EM-30180	060538	2014.12.22	2015.12.21	1 year
9	Loop Antenna	ARA	PLA-1030/B	1029	2015.06.08	2016.06.07	1 year
10	Power Meter	R&S	NRVS	100696	2015.07.06	2016.07.05	1 year
11	Power Sensor	R&S	URV5-Z4	0395.1619.05	2015.07.06	2016.07.05	1 year

Conduction Test equipment

Item	Kind of Equipment	Manufacturer	Type No.	Serial No.	Last calibration	Calibrated until	Calibration period
1	Test Receiver	R&S	ESCI	101160	2015.06.06	2016.06.05	1 year
2	LISN	R&S	ENV216	101313	2014.08.24	2015.08.23	1 year
3	LISN	EMCO	3816/2	00042990	2014.08.24	2015.08.23	1 year
4	50Ω Coaxial Switch	Anritsu	MP59B	6200264417	2015.06.07	2016.06.06	1 year
5	Passive Voltage Probe	R&S	ESH2-Z3	100196	2015.06.07	2016.06.06	1 year
6	Absorbing clamp	R&S	MOS-21	100423	2015.06.08	2016.06.07	1 year

3. EMC EMISSION TEST

3.1 CONDUCTED EMISSION MEASUREMENT

3.1.1 POWER LINE CONDUCTED EMISSION Limits (Frequency Range 150KHz-30MHz)

FREQUENCY (MHz)	Class A (dBuV)		Class B (dBuV)		Standard
	Quasi-peak	Average	Quasi-peak	Average	
0.15 -0.5	79.00	66.00	66 - 56 *	56 - 46 *	CISPR
0.50 -5.0	73.00	60.00	56.00	46.00	CISPR
5.0 -30.0	73.00	60.00	60.00	50.00	CISPR

0.15 -0.5	79.00	66.00	66 - 56 *	56 - 46 *	FCC
0.50 -5.0	73.00	60.00	56.00	46.00	FCC
5.0 -30.0	73.00	60.00	60.00	50.00	FCC

Note:

- (1) The tighter limit applies at the band edges.
- (2) The limit of " * " marked band means the limitation decreases linearly with the logarithm of the frequency in the range.

The following table is the setting of the receiver

Receiver Parameters	Setting
Attenuation	10 dB
Start Frequency	0.15 MHz
Stop Frequency	30 MHz
IF Bandwidth	9 kHz

3.1.2 TEST PROCEDURE

- The EUT was placed 0.4 meters from the horizontal ground plane with EUT being connected to the power mains through a line impedance stabilization network (LISN). All other support equipments powered from additional LISN(s). The LISN provide 50 Ohm/ 50uH of coupling impedance for the measuring instrument.
- Interconnecting cables that hang closer than 40 cm to the ground plane shall be folded back and forth in the center forming a bundle 30 to 40 cm long.
- I/O cables that are not connected to a peripheral shall be bundled in the center. The end of the cable may be terminated, if required, using the correct terminating impedance. The overall length shall not exceed 1 m.
- LISN at least 80 cm from nearest part of EUT chassis.
- For the actual test configuration, please refer to the related Item –EUT Test Photos.

3.1.3 DEVIATION FROM TEST STANDARD

No deviation

3.1.4 TEST SETUP

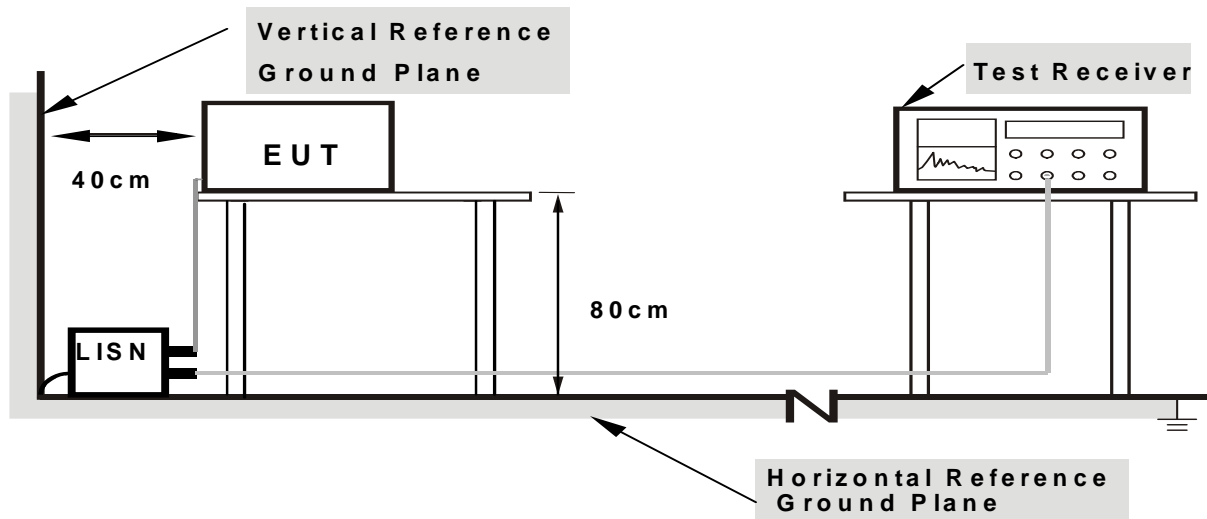

Note: 1. Support units were connected to second LISN.

2. Both of LISNs (AMN) are 80 cm from EUT and at least 80 cm from other units and other metal planes

3.1.5 EUT OPERATING CONDITIONS

The EUT was configured for testing in a typical fashion (as a customer would normally use it). The EUT has been programmed to continuously transmit during test. This operating condition was tested and used to collect the included data.

3.1.6 TEST RESULTS

EUT :	Bluetooth Speaker	Model Name :	M73
Temperature :	26 °C	Relative Humidity :	54%
Pressure :	1010hPa	Phase :	N
Test Voltage :	AC 120V/60H	Test Mode :	Mode 4

Frequency	Meter Reading	Factor	Emission Level	Limits	Margin	Detector Type
(MHz)	(dBμV)	(dB)	(dBμV)	(dBμV)	(dB)	
0.202	52.41	10.2	62.61	63.52	-0.91	QP
0.214	41.73	10.2	51.93	53.04	-1.11	AVG
1.686	20.55	10.22	30.77	56	-25.23	QP
2.122	11.9	10.25	22.15	46	-23.85	AVG

Remark:
 1. All readings are Quasi-Peak and Average values.
 2. Factor = Insertion Loss + Cable Loss.

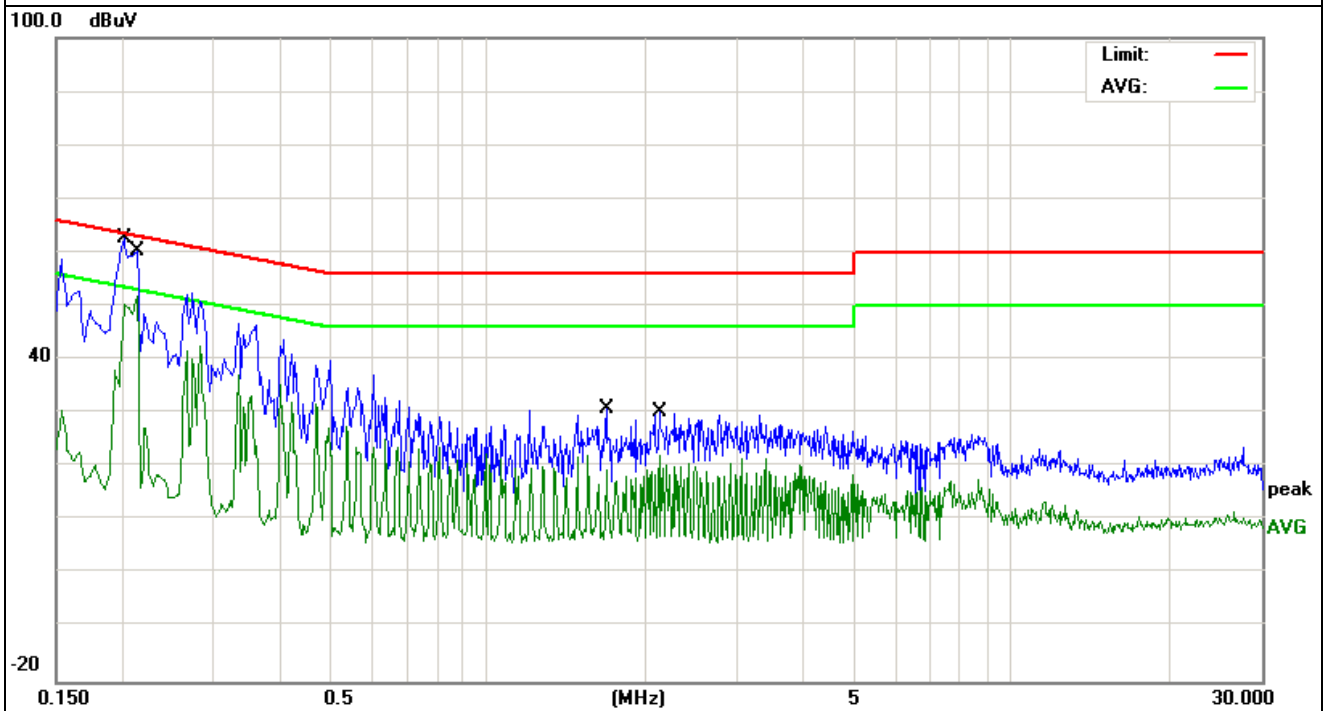

EUT :	Bluetooth Speaker	Model Name :	M73
Temperature :	26 °C	Relative Humidity :	54%
Pressure :	1010hPa	Phase :	N
Test Voltage :	120V/60Hz	Test Mode :	Mode 4

Frequency (MHz)	Meter Reading (dBμV)	Factor (dB)	Emission Level (dBμV)	Limits (dBμV)	Margin (dB)	Detector Type
0.15	54.22	9.82	64.04	65.99	-1.95	QP
0.218	39.53	10.2	49.73	52.89	-3.16	AVG

Remark:
 1. All readings are Quasi-Peak and Average values.
 2. Factor = Insertion Loss + Cable Loss.

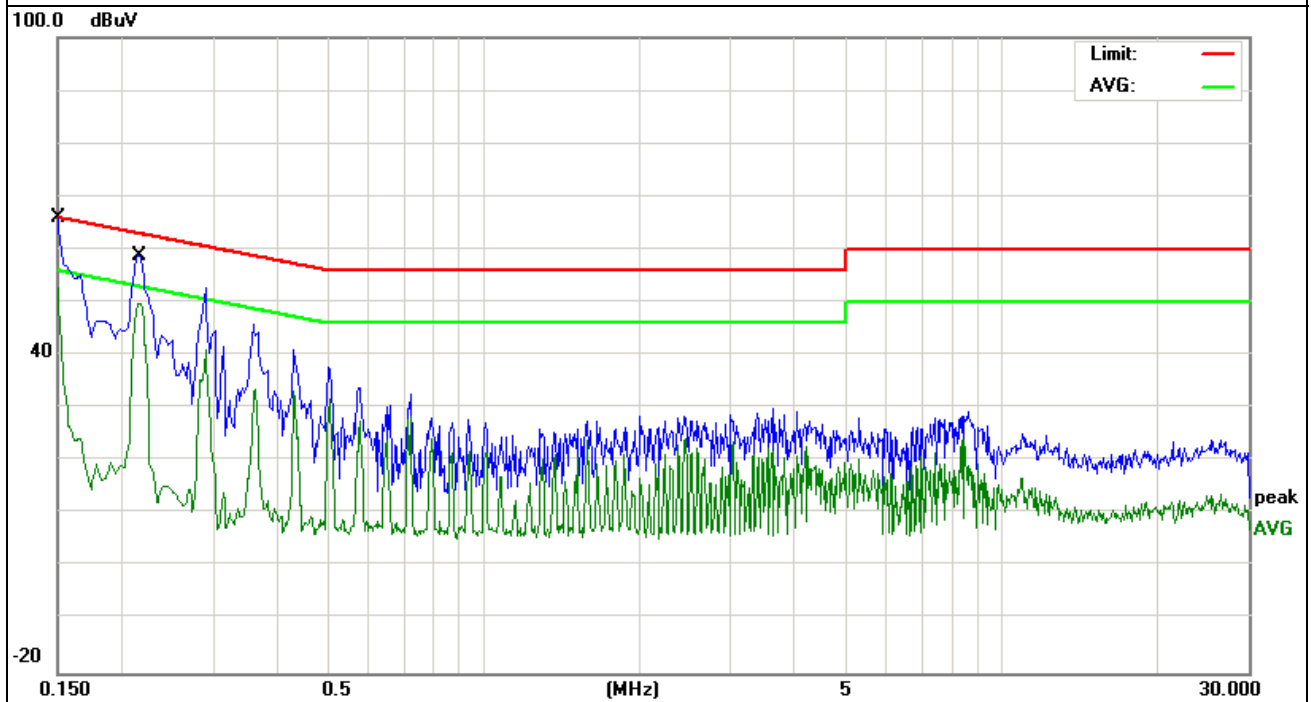

EUT :	Bluetooth Speaker	Model Name :	M73
Temperature :	26 °C	Relative Humidity :	54%
Pressure :	1010hPa	Phase :	L
Test Voltage :	AC 240V/60Hz	Test Mode :	Mode 4

Frequency (MHz)	Meter Reading (dBμV)	Factor (dB)	Emission Level (dBμV)	Limits (dBμV)	Margin (dB)	Detector Type
0.15	38.05	9.82	47.87	65.99	-18.12	QP
0.15	25.18	9.82	35	55.99	-20.99	AVG
8.3139	9.23	10.33	19.56	50	-30.44	AVG
9.4419	16.2	10.33	26.53	60	-33.47	QP

Remark:

1. All readings are Quasi-Peak and Average values.
2. Factor = Insertion Loss + Cable Loss.

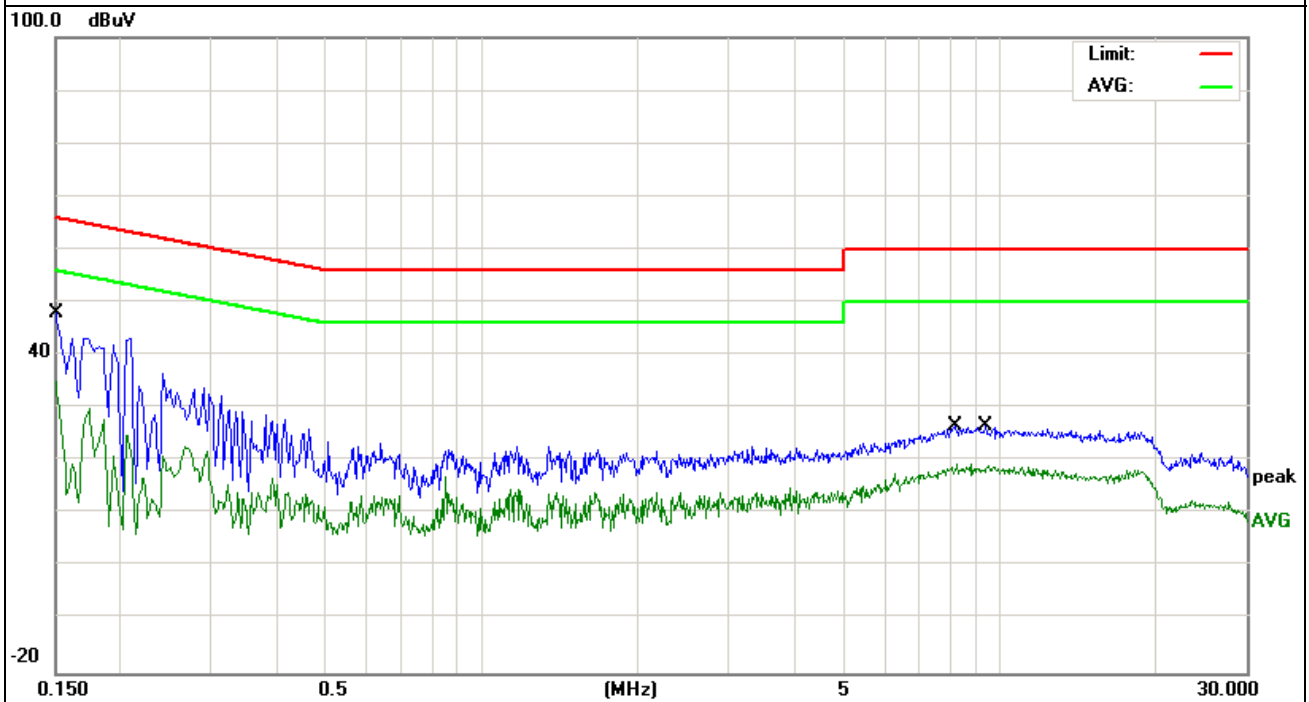

EUT :	Bluetooth Speaker	Model Name :	M73
Temperature :	26 °C	Relative Humidity :	54%
Pressure :	1010hPa	Phase :	N
Test Voltage :	AC 240V/60Hz	Test Mode :	Mode 4

Frequency (MHz)	Meter Reading (dBμV)	Factor (dB)	Emission Level (dBμV)	Limits (dBμV)	Margin (dB)	Detector Type
0.15	40.46	9.82	50.28	65.99	-15.71	QP
0.1779	22.38	10.04	32.42	54.58	-22.16	AVG
10.0978	8.36	10.34	18.7	50	-31.3	AVG
11.6659	16.11	10.47	26.58	60	-33.42	QP

Remark:
 1. All readings are Quasi-Peak and Average values.
 2. Factor = Insertion Loss + Cable Loss.

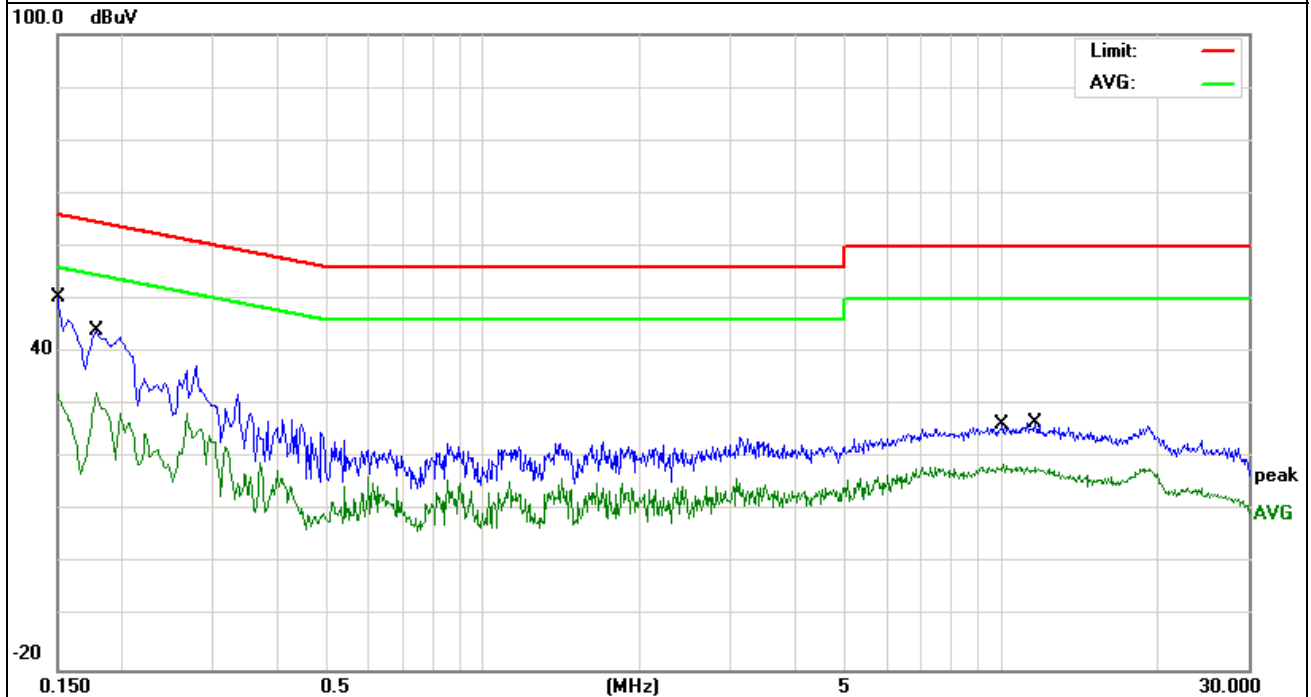

3.2 RADIATED EMISSION MEASUREMENT

3.2.1 RADIATED EMISSION LIMITS (FREQUENCY RANGE 9KHZ-1000MHZ)

20dBc in any 100 kHz bandwidth outside the operating frequency band. In case the emission fall within the restricted band specified on 15.205(a), then the 15.209(a) limit in the table below has to be followed.(unintentional radiator)

Frequencies (MHz)	Field Strength (micorvolts/meter)	Measurement Distance (meters)
0.009~0.490	2400/F(KHz)	300
0.490~1.705	24000/F(KHz)	30
1.705~30.0	30	30
30~88	100	3
88~216	150	3
216~960	200	3
Above 960	500	3

The following table is the setting of the receiver

Spectrum Parameter	Setting
Attenuation	Auto
Start Frequency	1000 MHz
Stop Frequency	10th carrier harmonic
RB / VB (emission in restricted band)	1 MHz / 1 MHz for Peak, 1 MHz / 10Hz for Average

Receiver Parameter	Setting
Attenuation	Auto
Start ~ Stop Frequency	9kHz~150kHz / RB 200Hz for QP
Start ~ Stop Frequency	150kHz~30MHz / RB 9kHz for QP
Start ~ Stop Frequency	30MHz~1000MHz / RB 120kHz for QP

3.2.2 TEST PROCEDURE

- a. The measuring distance of at 3 m shall be used for measurements at frequency up to 1GHz. For frequencies above 1GHz, any suitable measuring distance may be used.
- b. The EUT was placed on the top of a rotating table 0.8 meters above the ground at a 3m meter open area test site for below 1GHz. The table was rotated 360 degrees to determine the position of the highest radiation. The EUT was place on the top of a roatating table 1.5 meters for above 1GHz.
- c. The height of the equipment or of the substitution antenna shall be 0.8 m; the height of the test antenna shall vary between 1 m to 4 m. Both horizontal and vertical polarizations of the antenna are set to make the measurement.
- d. The initial step in collecting conducted emission data is a spectrum analyzer peak detector mode pre-scanning the measurement frequency range. Significant peaks are then marked and then Quasi Peak detector mode re-measured.
- e. If the Peak Mode measured value compliance with and lower than Quasi Peak Mode Limit, the EUT shall be deemed to meet QP Limits and then no additional QP Mode measurement performed.
- f. For the actual test configuration, please refer to the related Item –EUT Test Photos.

Note:

Both horizontal and vertical antenna polarities were tested and performed pretest to three orthogonal axis. The worst case emissions were reported

3.2.3 DEVIATION FROM TEST STANDARD

No deviation

3.2.4 TEST SETUP

(A) Radiated Emission Test-Up Frequency Below 30MHz

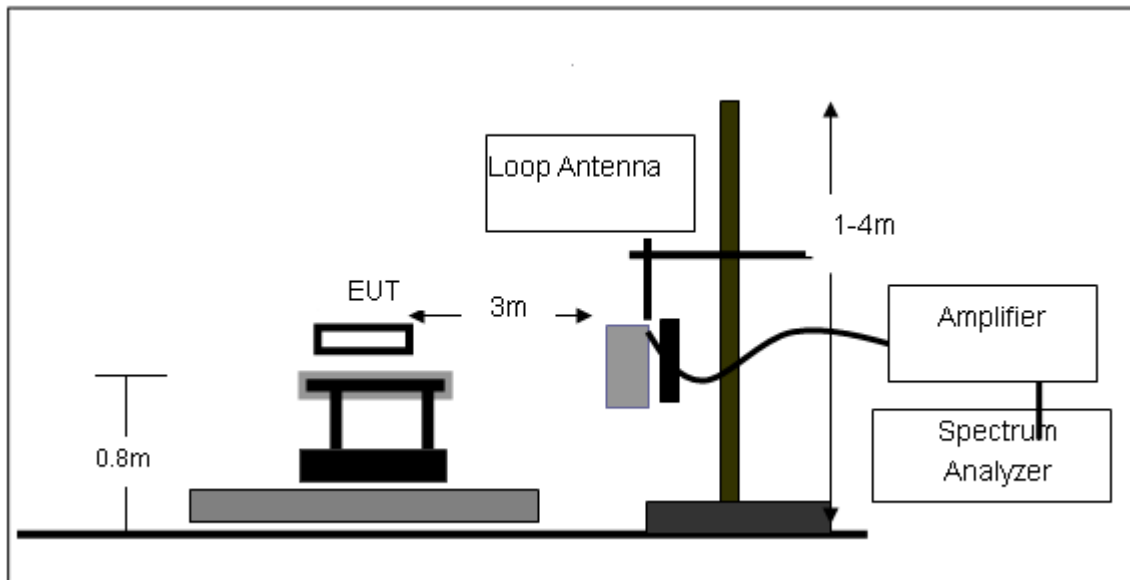

(B) Radiated Emission Test-Up Frequency 30MHz~1GHz

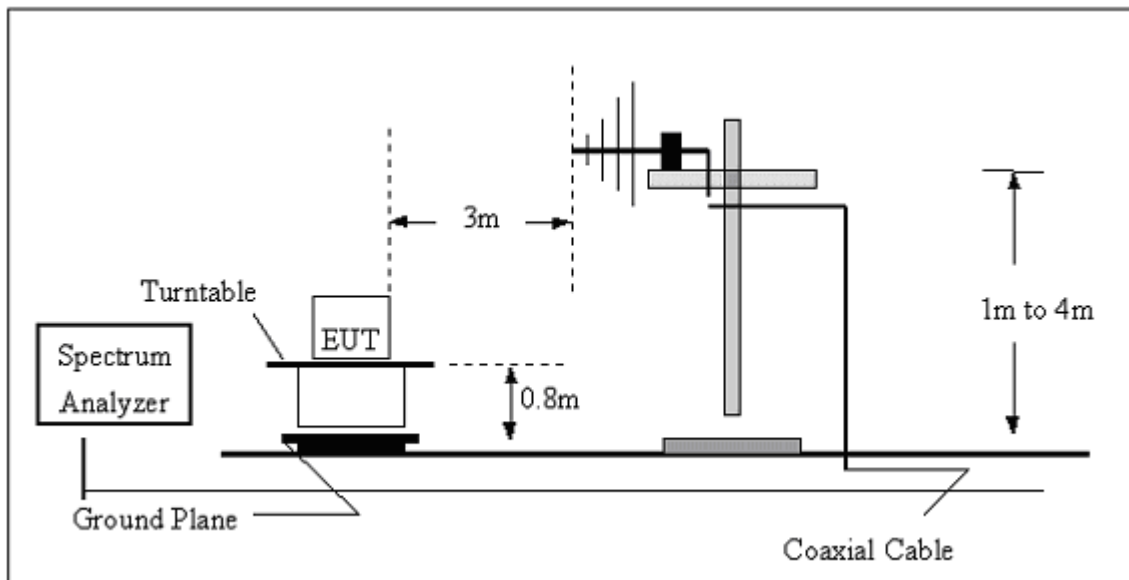

(C) Radiated Emission Test-Up Frequency Above 1GHz

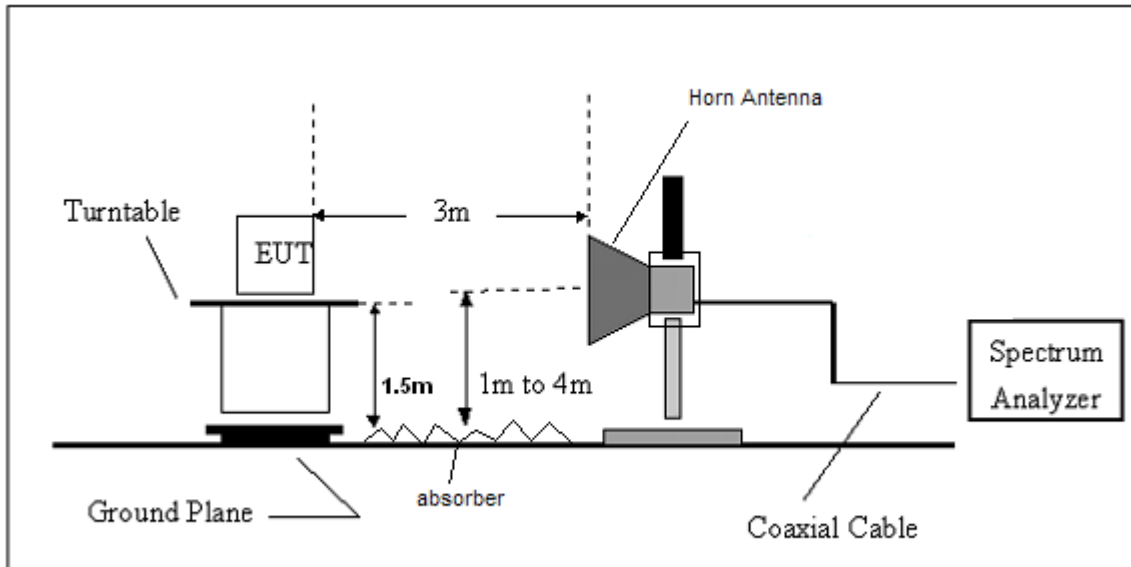

3.2.5 EUT OPERATING CONDITIONS

The EUT tested system was configured as the statements of 2.4 Unless otherwise a special operating condition is specified in the follows during the testing.

3.2.6 TEST RESULTS (Below 1G)

EUT :	Bluetooth Speaker	Model Name :	M73
Temperature :	20 °C	Relative Humidity :	48%
Pressure :	1010 hPa	Polarization :	Horizontal
Test Voltage :	DC 3.7V		
Test Mode :	TX		

Frequency (MHz)	Meter Reading (dBμV)	Factor (dB)	Emission Level (dBμV/m)	Limits (dBμV/m)	Margin (dB)	Detector Type
199.2855	26.88	8.71	35.59	43.5	-7.91	peak
331.3546	24.23	14.97	39.2	46	-6.8	peak
394.8543	23.77	17.03	40.8	46	-5.2	peak
531.9633	18.85	19.76	38.61	46	-7.39	peak
793.3958	16.51	23.91	40.42	46	-5.58	peak

Remark:
 Factor = Antenna Factor + Cable Loss – Pre-amplifier.
 Factor added by measurement software automatically.
 All interfaces was connected, and BT TX mode was link.

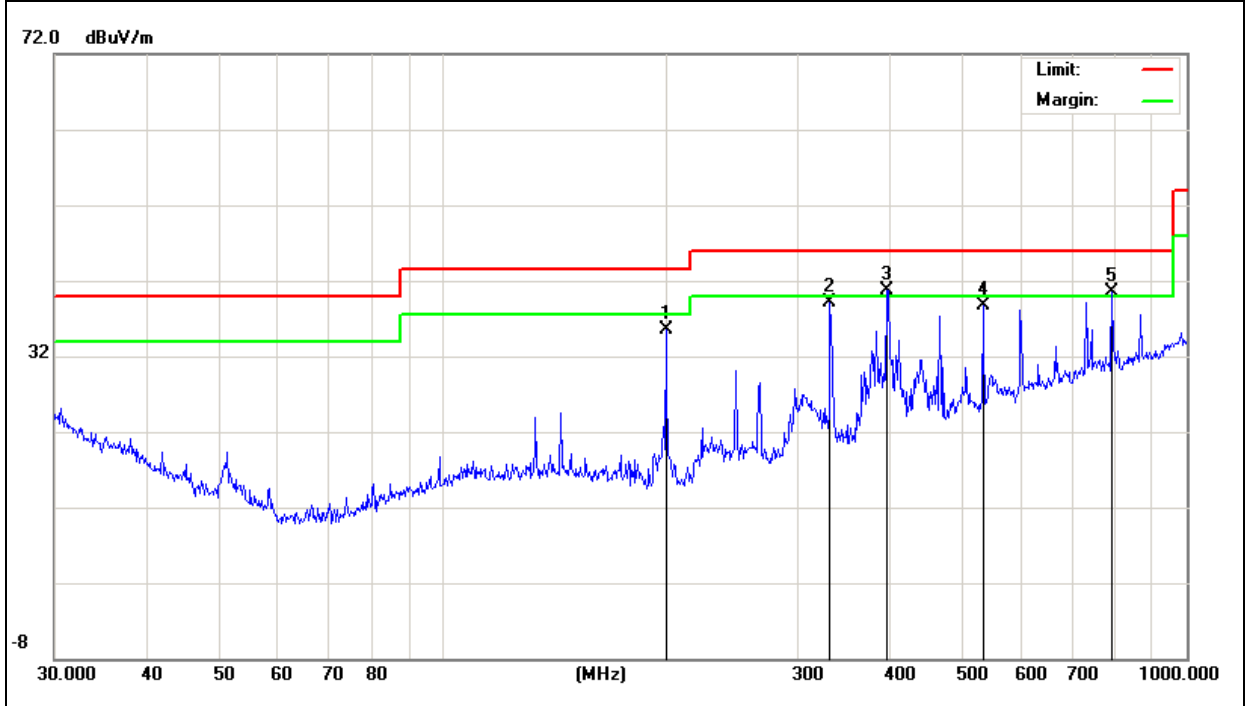

EUT :	Bluetooth Speaker	Model Name :	M73
Temperature :	20 °C	Relative Humidity :	48%
Pressure :	1010 hPa	Polarization :	Vertical
Test Voltage :	DC 3.7V		
Test Mode :	TX		

Frequency (MHz)	Meter Reading (dBμV)	Factor (dB)	Emission Level (dBμV/m)	Limits (dBμV/m)	Margin (dB)	Detector Type
199.2855	30.12	8.71	38.83	43.5	-4.67	peak
392.0951	25.41	16.93	42.34	46	-3.66	peak
531.9633	20.35	19.76	40.11	46	-5.89	peak
590.9737	14.71	20.79	35.5	46	-10.5	peak

Remark:
 Factor = Antenna Factor + Cable Loss – Pre-amplifier.
 Factor added by measurement software automatically.
 All interfaces was connected, and BT TX mode was link.

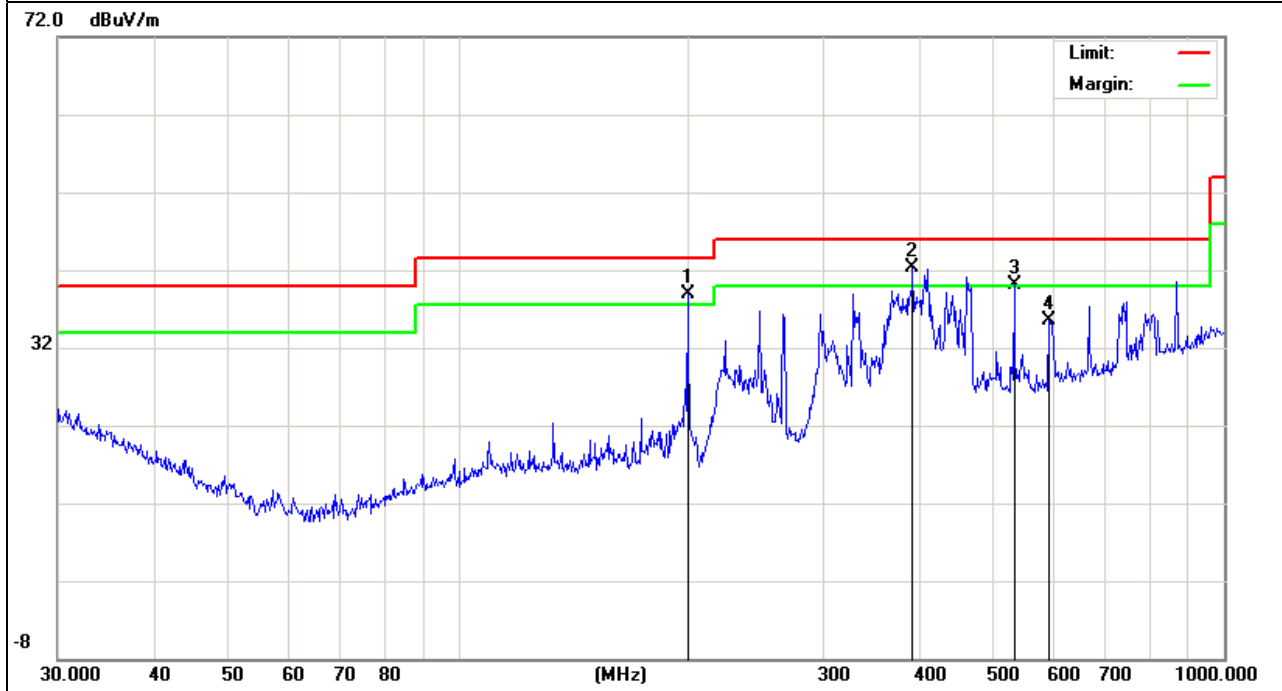

3.2.7 TEST RESULTS (Above 1000 MHZ)

EUT :	Bluetooth Speaker	Model Name :	M73
Temperature :	20 °C	Relative Humidity :	48%
Pressure :	1010 hPa	Test Voltage :	DC 3.7V
Test Mode :	TX 2402MHz – CH 00(1Mbps)	Polarization :	Horizontal

Frequency (MHz)	Meter Reading (dBµV)	Factor (dB)	Emission Level (dBµV/m)	Limits (dBµV/m)	Margin (dB)	Detector Type
4804.136	64.21	-3.64	60.57	74	-13.43	peak
4804.136	49.46	-3.64	45.82	54	-8.18	AVG
7206.125	56.54	-0.95	55.59	74	-18.41	peak
7206.125	44.38	-0.95	43.43	54	-10.57	AVG

Remark:
 Factor = Antenna Factor + Cable Loss – Pre-amplifier.
 Factor added by measurement software automatically.
 No emission detected in 18GHz-26GHz

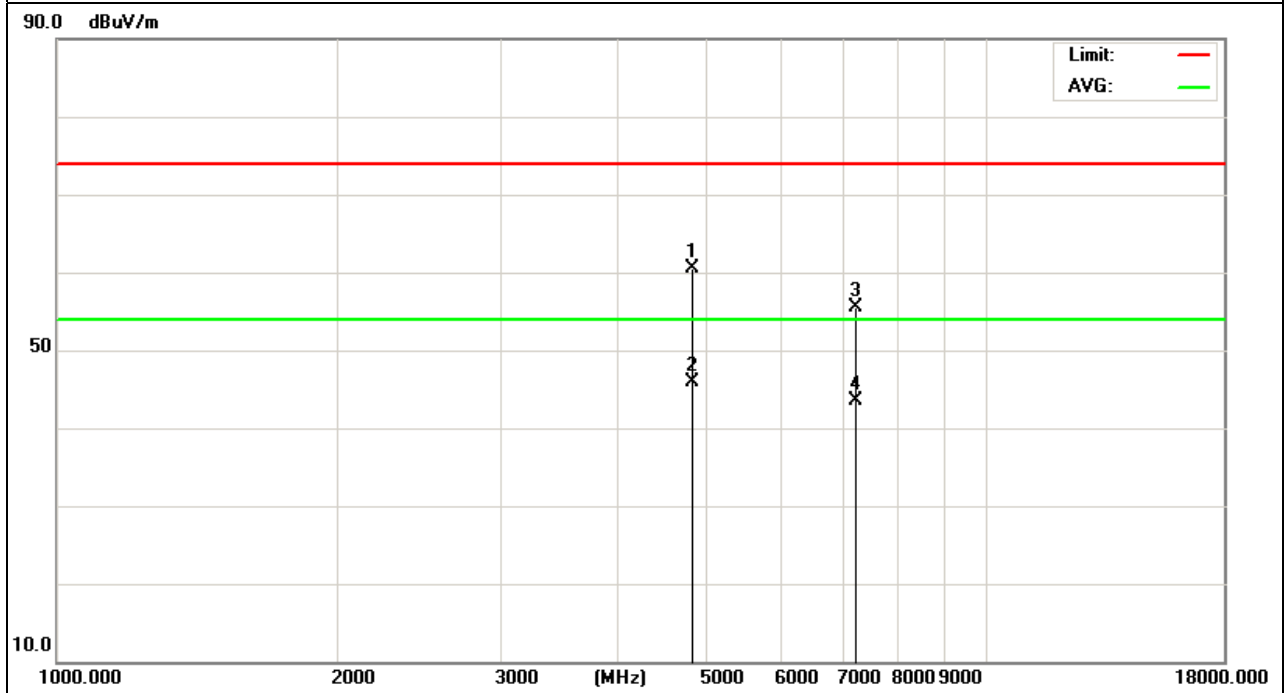

EUT :	Bluetooth Speaker	Model Name :	M73
Temperature :	20 °C	Relative Humidity :	48%
Pressure :	1010 hPa	Test Voltage :	DC 3.7V
Test Mode :	TX 2402MHz – CH 00(1Mbps)	Polarization :	Vertical

Frequency (MHz)	Meter Reading (dBμV)	Factor (dB)	Emission Level (dBμV/m)	Limits (dBμV/m)	Margin (dB)	Detector Type
4804.138	65.12	-3.64	61.48	74	-12.52	peak
4804.138	48.03	-3.64	44.39	54	-9.61	AVG
7206.119	56.4	-0.95	55.45	74	-18.55	peak
7206.119	43.29	-0.95	42.34	54	-11.66	AVG

Remark:
 Factor = Antenna Factor + Cable Loss – Pre-amplifier.
 Factor added by measurement software automatically.
 No emission detected in 18GHz-26GHz

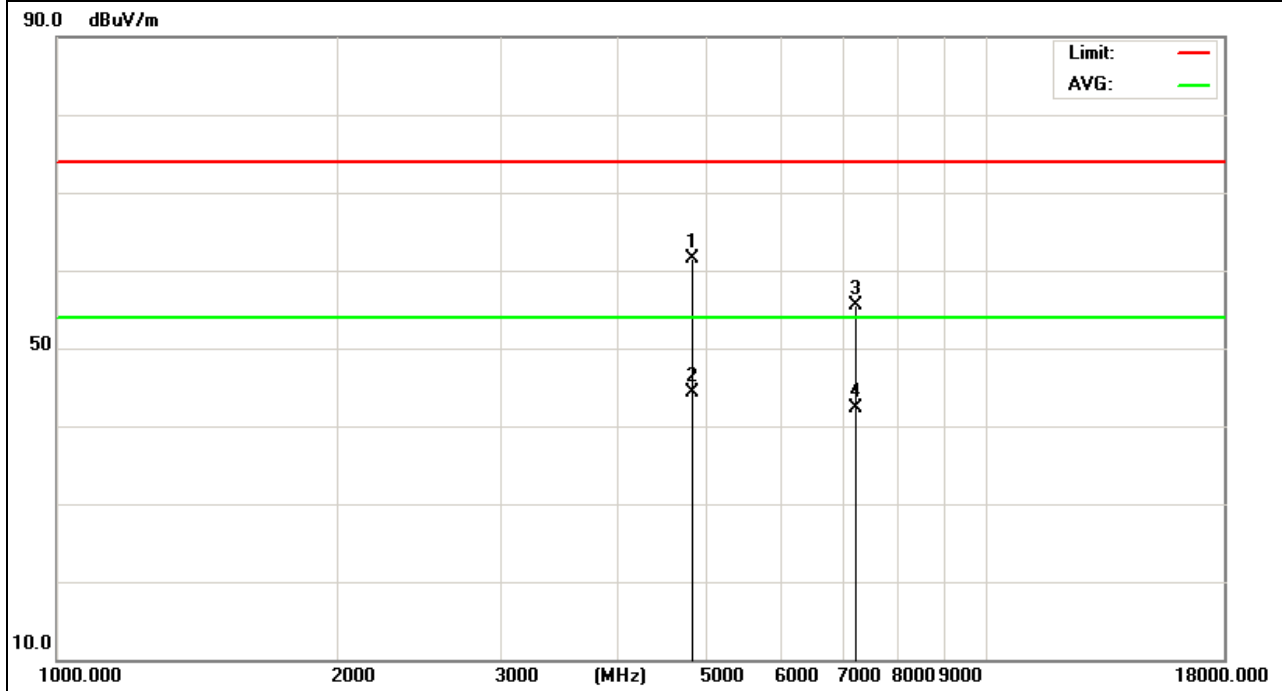

EUT :	Bluetooth Speaker	Model Name :	M73
Temperature :	20 °C	Relative Humidity :	48%
Pressure :	1010 hPa	Test Voltage :	DC 3.7V
Test Mode :	TX 2441MHz – CH 39(1Mbps)	Polarization :	Vertical

Frequency (MHz)	Meter Reading (dBµV)	Factor (dB)	Emission Level (dBµV/m)	Limits (dBµV/m)	Margin (dB)	Detector Type
4882.132	66	-3.68	62.32	74	-11.68	peak
4882.132	47.25	-3.68	43.57	54	-10.43	AVG
7323.118	57.65	-0.82	56.83	74	-17.17	peak
7323.118	41.28	-0.82	40.46	54	-13.54	AVG

Remark:
 Factor = Antenna Factor + Cable Loss – Pre-amplifier.
 Factor added by measurement software automatically.
 No emission detected in 18GHz-26GHz

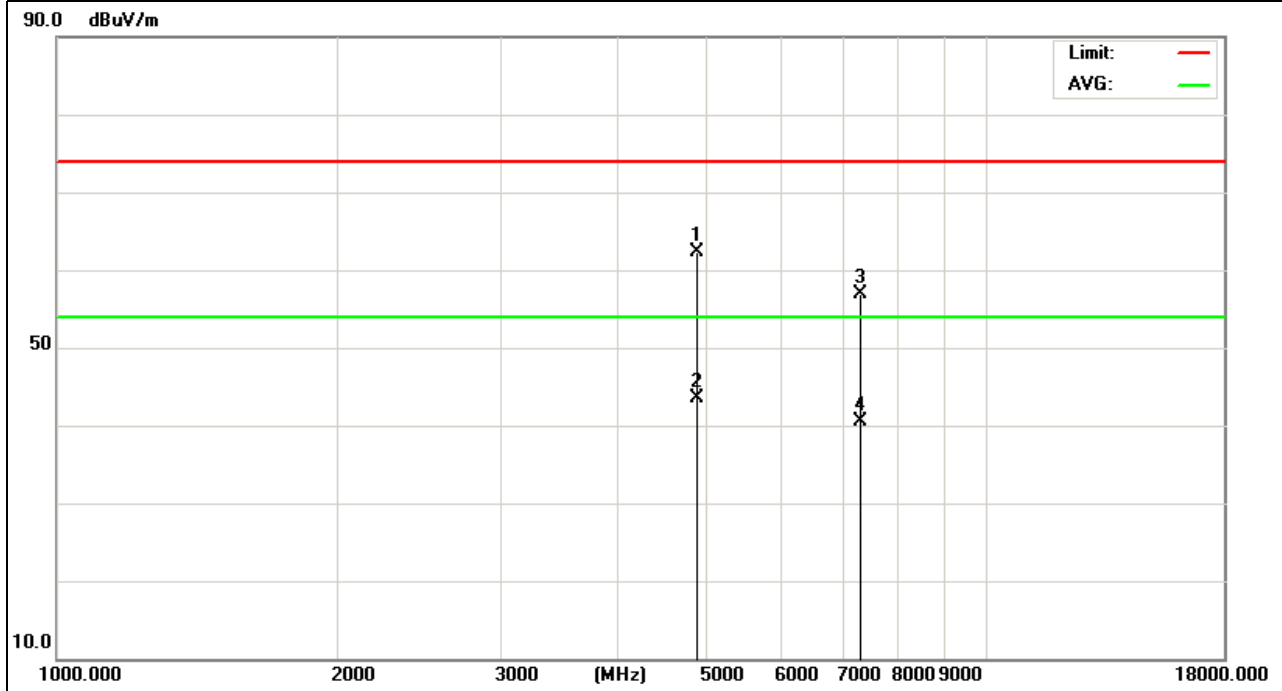

EUT :	Bluetooth Speaker	Model Name :	M73
Temperature :	20 °C	Relative Humidity :	48%
Pressure :	1010 hPa	Test Voltage :	DC 3.7V
Test Mode :	TX 2441MHz – CH 39(1Mbps)	Polarization :	Horizontal

Frequency (MHz)	Meter Reading (dBμV)	Factor (dB)	Emission Level (dBμV/m)	Limits (dBμV/m)	Margin (dB)	Detector Type
4882.177	64.24	-3.68	60.56	74	-13.44	peak
4882.177	46.15	-3.68	42.47	54	-11.53	AVG
7323.149	56.45	-0.82	55.63	74	-18.37	peak
7323.149	41.51	-0.82	40.69	54	-13.31	AVG

Remark:
 Factor = Antenna Factor + Cable Loss – Pre-amplifier.
 Factor added by measurement software automatically.
 No emission detected in 18GHz-26GHz

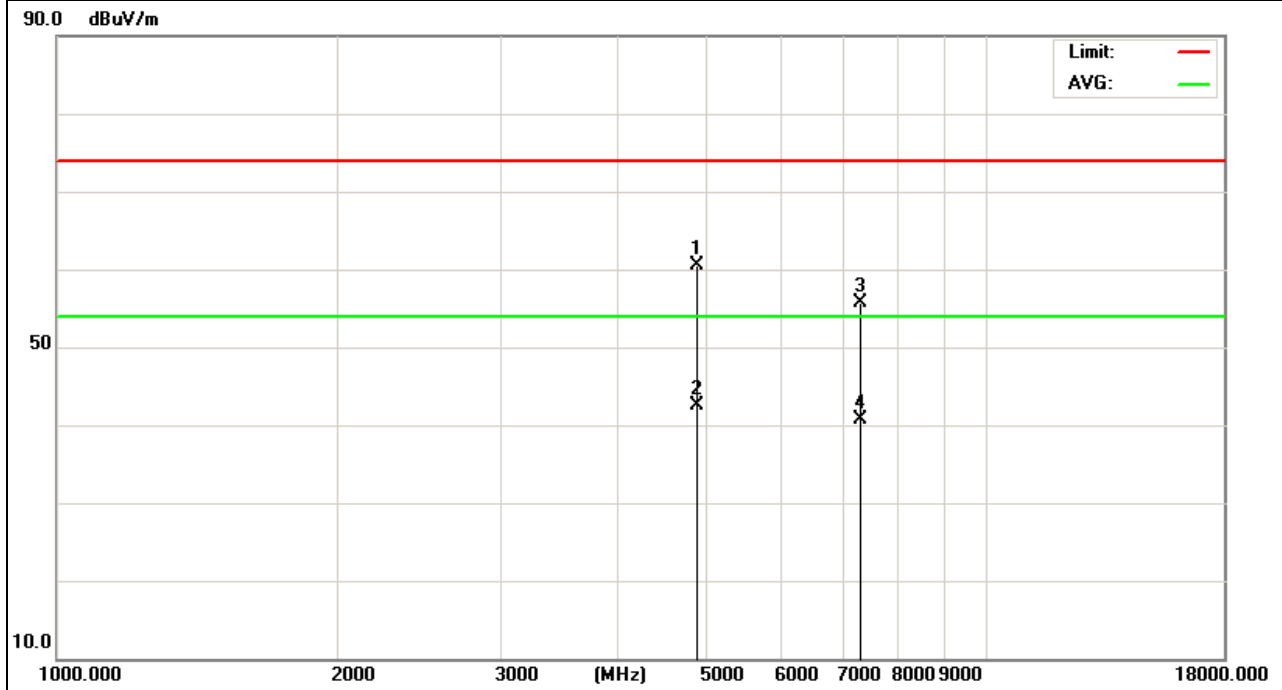

EUT :	Bluetooth Speaker	Model Name :	M73
Temperature :	20 °C	Relative Humidity :	48%
Pressure :	1010 hPa	Test Voltage :	DC 3.7V
Test Mode :	TX 2480MHz – CH 78(1Mbps)	Polarization :	Horizontal

Frequency (MHz)	Meter Reading (dBμV)	Factor (dB)	Emission Level (dBμV/m)	Limits (dBμV/m)	Margin (dB)	Detector Type
4960.145	61.94	-3.59	58.35	74	-15.65	peak
4960.145	47.87	-3.59	44.28	54	-9.72	AVG
7440.129	55.05	-0.68	54.37	74	-19.63	peak
7440.129	43.14	-0.68	42.46	54	-11.54	AVG

Remark:
 Factor = Antenna Factor + Cable Loss – Pre-amplifier.
 Factor added by measurement software automatically.
 No emission detected in 18GHz-26GHz

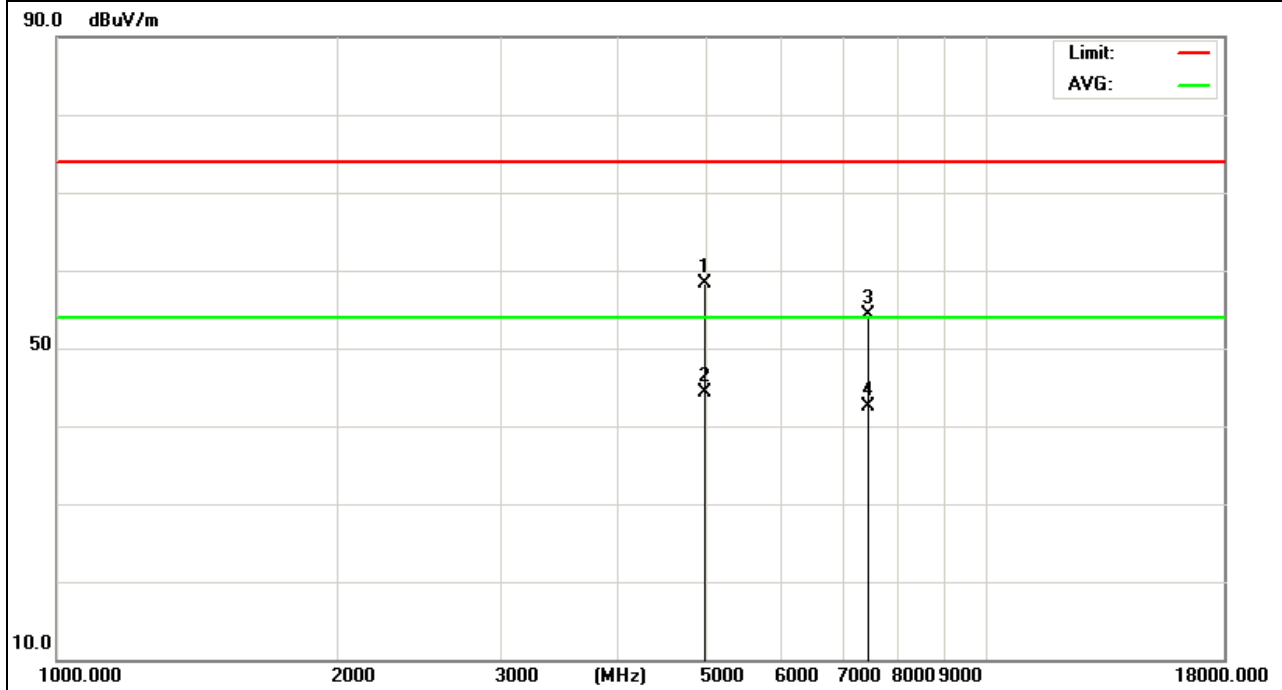

EUT :	Bluetooth Speaker	Model Name :	M73
Temperature :	20 °C	Relative Humidity :	48%
Pressure :	1010 hPa	Test Voltage :	DC 3.7V
Test Mode :	TX 2480MHz – CH 78(1Mbps)	Polarization :	Vertical

Frequency (MHz)	Meter Reading (dBμV)	Factor (dB)	Emission Level (dBμV/m)	Limits (dBμV/m)	Margin (dB)	Detector Type
4960.142	64.16	-3.59	60.57	74	-13.43	peak
4960.142	46.92	-3.59	43.33	54	-10.67	AVG
7440.11	55.93	-0.68	55.25	74	-18.75	peak
7440.11	41.04	-0.68	40.36	54	-13.64	AVG

Remark:
 Factor = Antenna Factor + Cable Loss – Pre-amplifier.
 Factor added by measurement software automatically.
 No emission detected in 18GHz-26GHz

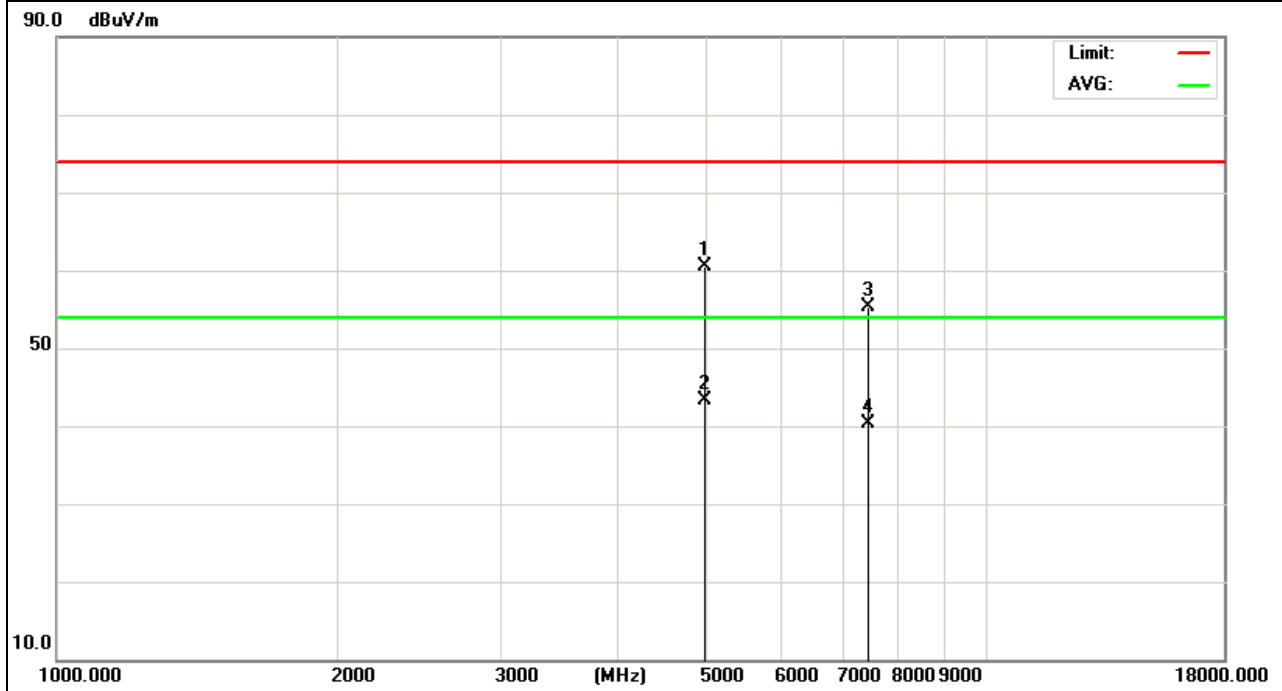

EUT :	Bluetooth Speaker	Model Name :	M73
Temperature :	20 °C	Relative Humidity :	48%
Pressure :	1010 hPa	Test Voltage :	DC 3.7V
Test Mode :	TX 2402MHz – CH 00(2Mbps)	Polarization :	Horizontal

Frequency (MHz)	Meter Reading (dBμV)	Factor (dB)	Emission Level (dBμV/m)	Limits (dBμV/m)	Margin (dB)	Detector Type
4804.177	62.89	-3.64	59.25	74	-14.75	peak
4804.177	48	-3.64	44.36	54	-9.64	AVG
7206.161	57.14	-0.95	56.19	74	-17.81	peak
7206.161	43.23	-0.95	42.28	54	-11.72	AVG

Remark:

Factor = Antenna Factor + Cable Loss – Pre-amplifier.
 Factor added by measurement software automatically.
 No emission detected in 18GHz-26GHz

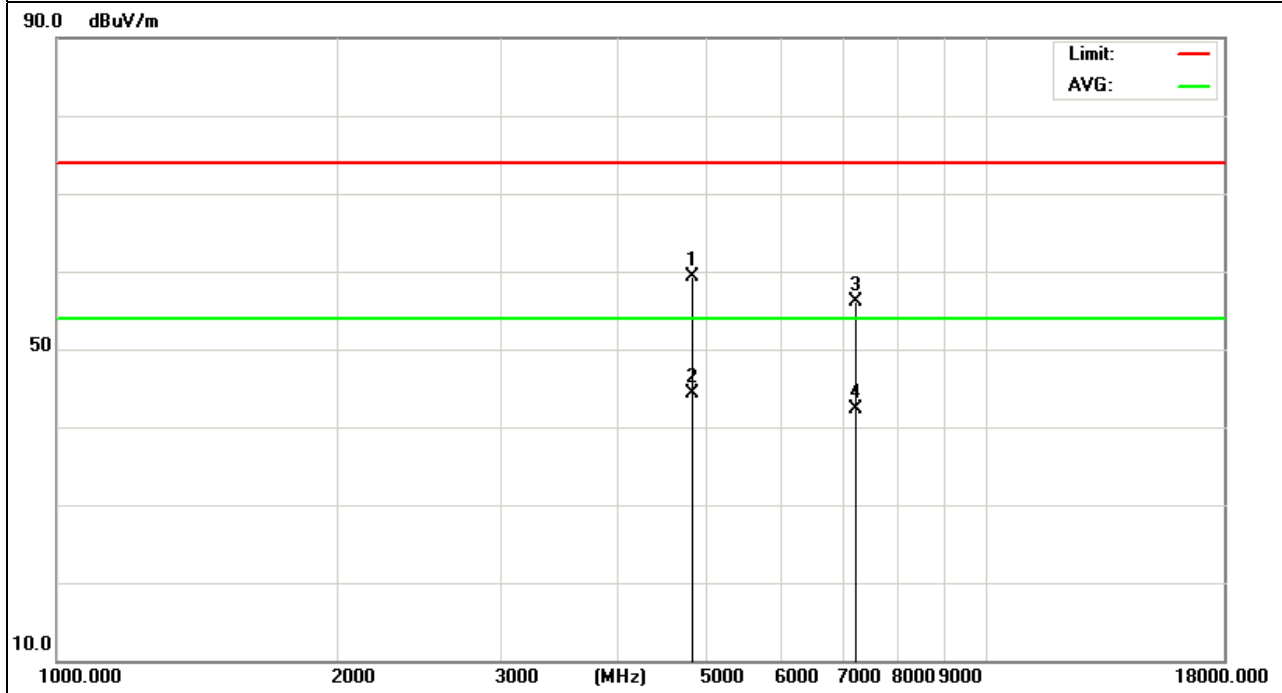

EUT :	Bluetooth Speaker	Model Name :	M73
Temperature :	20 °C	Relative Humidity :	48%
Pressure :	1010 hPa	Test Voltage :	DC 3.7V
Test Mode :	TX 2402MHz – CH 00(2Mbps)	Polarization :	Vertical

Frequency (MHz)	Meter Reading (dBμV)	Factor (dB)	Emission Level (dBμV/m)	Limits (dBμV/m)	Margin (dB)	Detector Type
4804.115	61.02	-3.64	57.38	74	-16.62	peak
4804.115	46.13	-3.64	42.49	54	-11.51	AVG
7206.127	55.51	-0.95	54.56	74	-19.44	peak
7206.127	41.52	-0.95	40.57	54	-13.43	AVG

Remark:

Factor = Antenna Factor + Cable Loss – Pre-amplifier.
 Factor added by measurement software automatically.
 No emission detected in 18GHz-26GHz

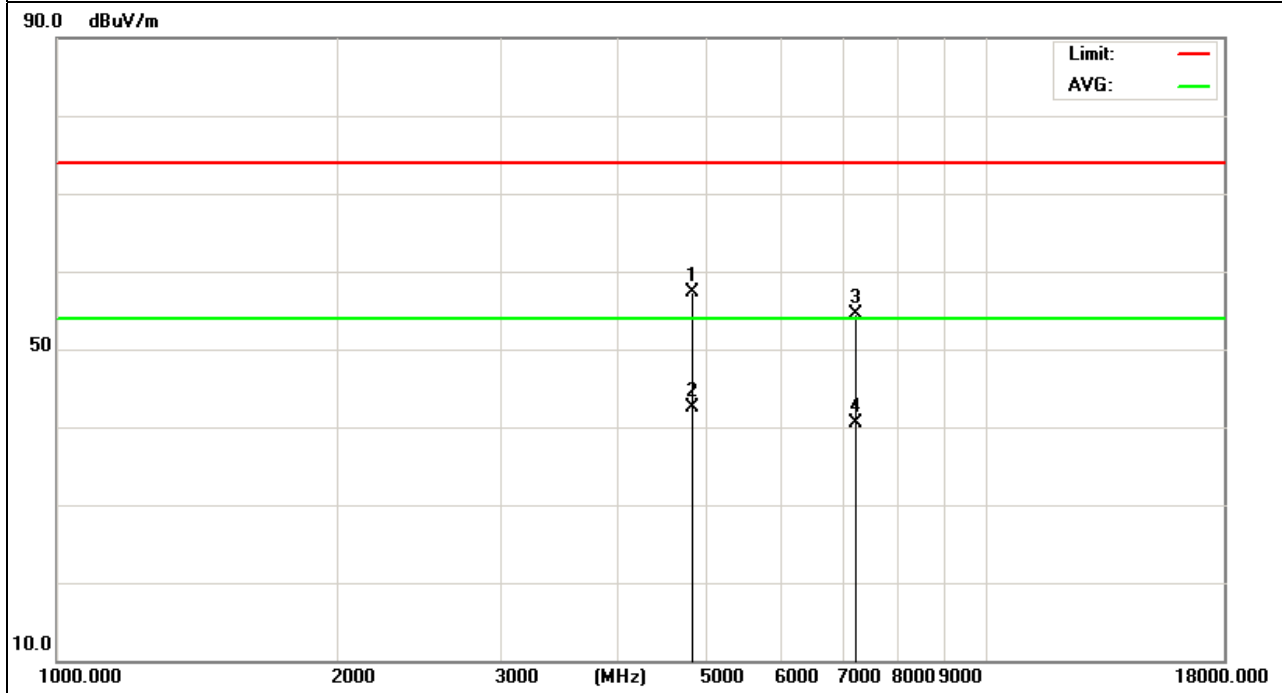

EUT :	Bluetooth Speaker	Model Name :	M73
Temperature :	20 °C	Relative Humidity :	48%
Pressure :	1010 hPa	Test Voltage :	DC 3.7V
Test Mode :	TX 2441MHz – CH 39(2Mbps)	Polarization :	Horizontal

Frequency (MHz)	Meter Reading (dBμV)	Factor (dB)	Emission Level (dBμV/m)	Limits (dBμV/m)	Margin (dB)	Detector Type
4882.132	62.89	-3.68	59.21	74	-14.79	peak
4882.132	47.02	-3.68	43.34	54	-10.66	AVG
7323.103	55.27	-0.82	54.45	74	-19.55	peak
7323.103	41.18	-0.82	40.36	54	-13.64	AVG

Remark:

Factor = Antenna Factor + Cable Loss – Pre-amplifier.
 Factor added by measurement software automatically.
 No emission detected in 18GHz-26GHz

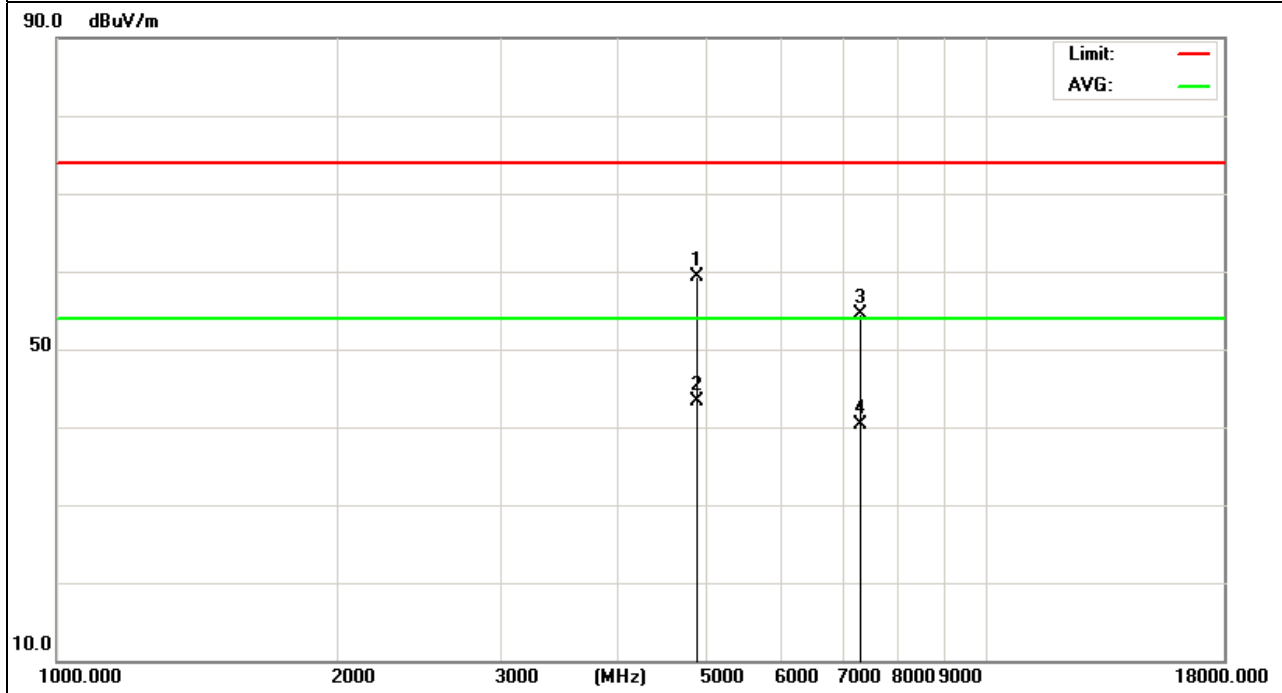

EUT :	Bluetooth Speaker	Model Name :	M73
Temperature :	20 °C	Relative Humidity :	48%
Pressure :	1010 hPa	Test Voltage :	DC 3.7V
Test Mode :	TX 2441MHz – CH 39(2Mbps)	Polarization :	Vertical

Frequency (MHz)	Meter Reading (dBμV)	Factor (dB)	Emission Level (dBμV/m)	Limits (dBμV/m)	Margin (dB)	Detector Type
4882.132	63.2	-3.68	59.52	74	-14.48	peak
4882.132	46.37	-3.68	42.69	54	-11.31	AVG
7323.175	55.57	-0.82	54.75	74	-19.25	peak
7323.175	41.16	-0.82	40.34	54	-13.66	AVG

Remark:

Factor = Antenna Factor + Cable Loss – Pre-amplifier.
 Factor added by measurement software automatically.
 No emission detected in 18GHz-26GHz

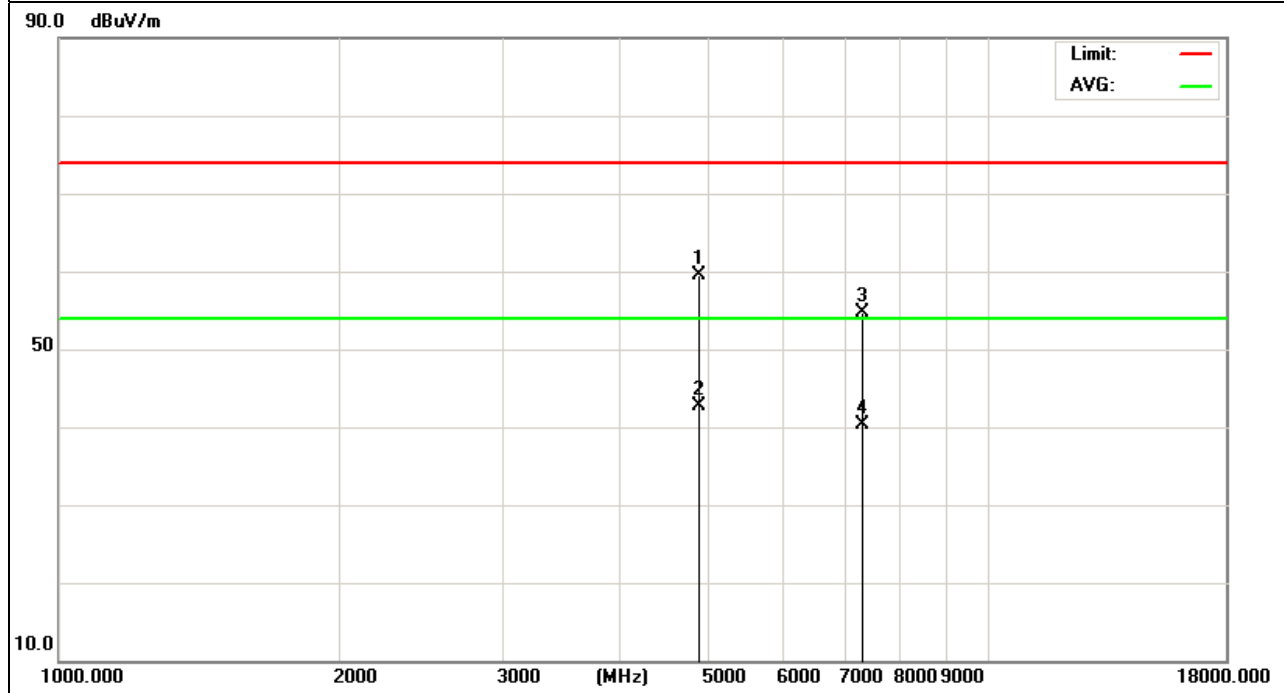

EUT :	Bluetooth Speaker	Model Name :	M73
Temperature :	20 °C	Relative Humidity :	48%
Pressure :	1010 hPa	Test Voltage :	DC 3.7V
Test Mode :	TX 2480MHz – CH 78(2Mbps)	Polarization :	Horizontal

Frequency (MHz)	Meter Reading (dBμV)	Factor (dB)	Emission Level (dBμV/m)	Limits (dBμV/m)	Margin (dB)	Detector Type
4960.111	63.16	-3.59	59.57	74	-14.43	peak
4960.111	45.24	-3.59	41.65	54	-12.35	AVG
7440.189	55.12	-0.68	54.44	74	-19.56	peak
7440.189	41.26	-0.68	40.58	54	-13.42	AVG

Remark:
 Factor = Antenna Factor + Cable Loss – Pre-amplifier.
 Factor added by measurement software automatically.
 No emission detected in 18GHz-26GHz

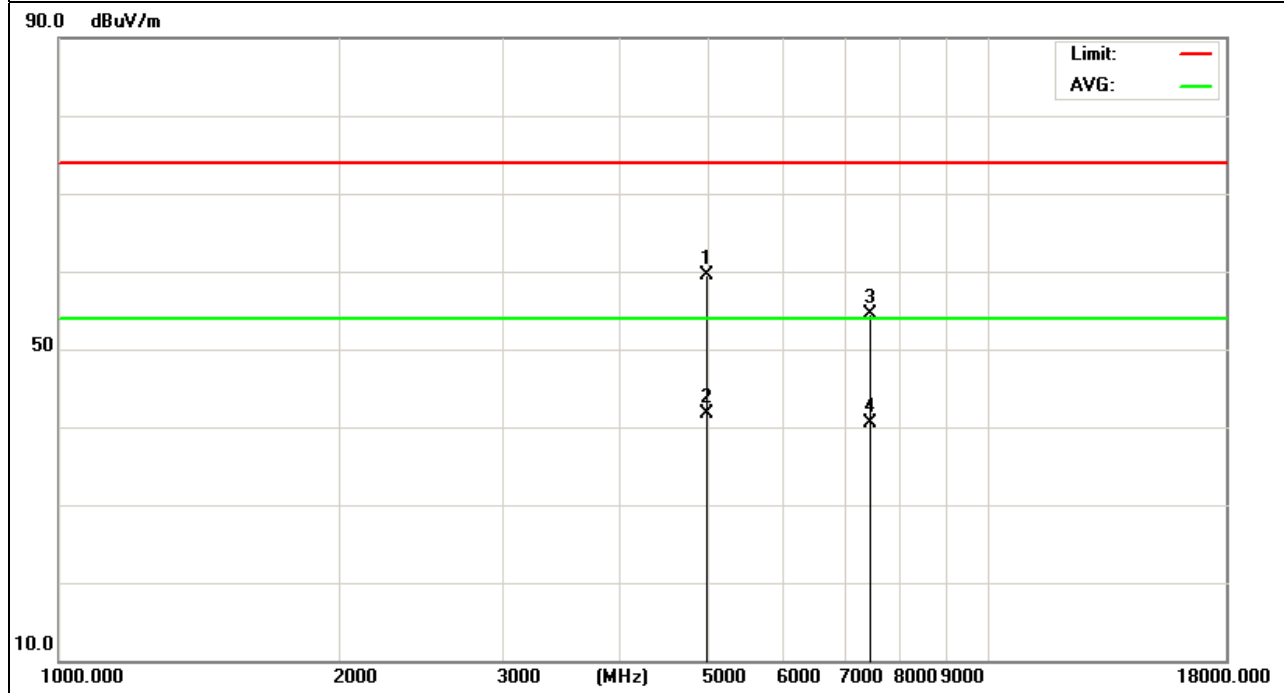

EUT :	Bluetooth Speaker	Model Name :	M73
Temperature :	20 °C	Relative Humidity :	48%
Pressure :	1010 hPa	Test Voltage :	DC 3.7V
Test Mode :	TX 2480MHz – CH 78(2Mbps)	Polarization :	Vertical

Frequency (MHz)	Meter Reading (dBμV)	Factor (dB)	Emission Level (dBμV/m)	Limits (dBμV/m)	Margin (dB)	Detector Type
4960.121	63.01	-3.59	59.42	74	-14.58	peak
4960.121	46.12	-3.59	42.53	54	-11.47	AVG
7440.128	55.25	-0.68	54.57	74	-19.43	peak
7440.128	41.27	-0.68	40.59	54	-13.41	AVG

Remark:

Factor = Antenna Factor + Cable Loss – Pre-amplifier.
 Factor added by measurement software automatically.
 No emission detected in 18GHz-26GHz

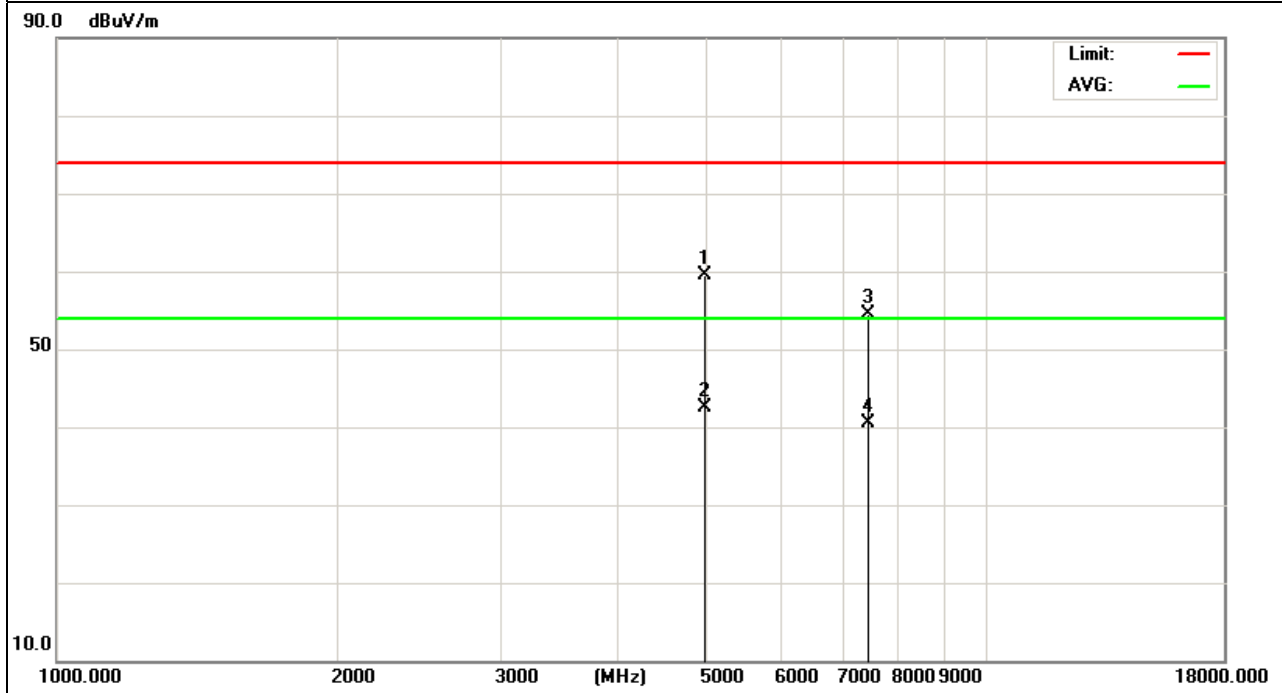

EUT :	Bluetooth Speaker	Model Name :	M73
Temperature :	20 °C	Relative Humidity :	48%
Pressure :	1010 hPa	Test Voltage :	DC 3.7V
Test Mode :	TX 2402MHz – CH00 (3Mbps)	Polarization :	Horizontal

Frequency (MHz)	Meter Reading (dBμV)	Factor (dB)	Emission Level (dBμV/m)	Limits (dBμV/m)	Margin (dB)	Detector Type
4804.108	62.92	-3.64	59.28	74	-14.72	peak
4804.108	46	-3.64	42.36	54	-11.64	AVG
7206.117	54.57	-0.95	53.62	74	-20.38	peak
7206.117	41.32	-0.95	40.37	54	-13.63	AVG

Remark:

Factor = Antenna Factor + Cable Loss – Pre-amplifier.
 Factor added by measurement software automatically.
 No emission detected in 18GHz-26GHz

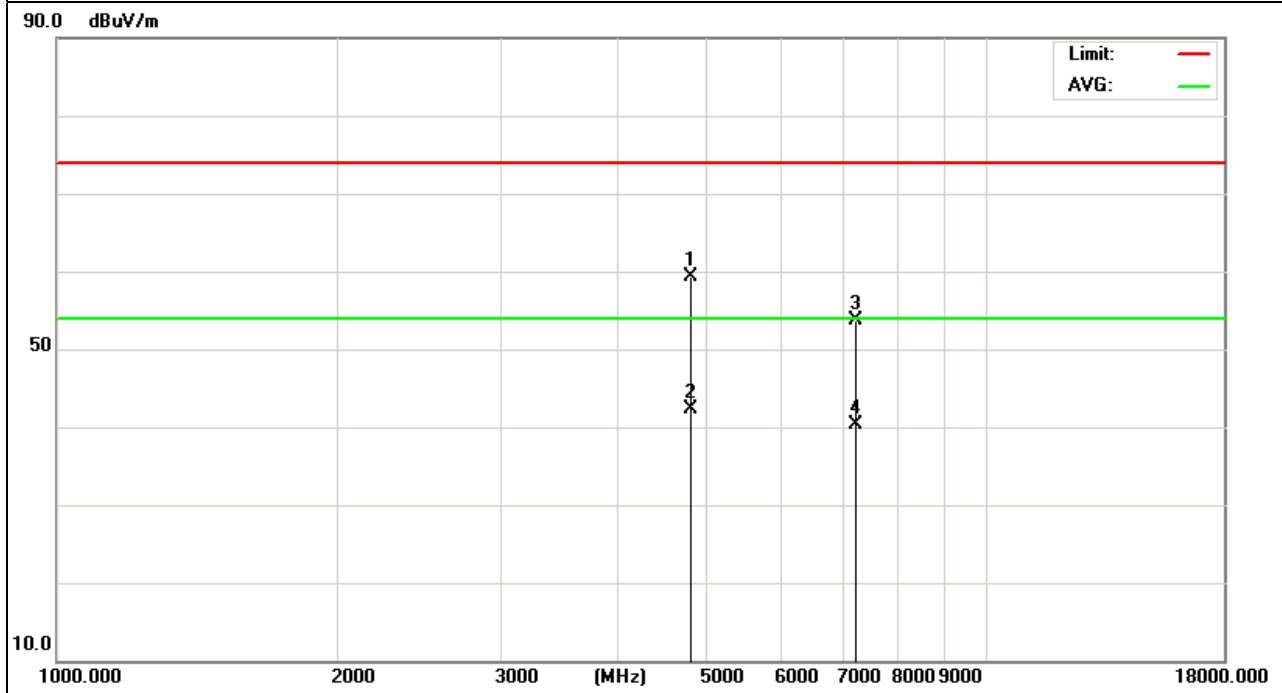

EUT :	Bluetooth Speaker	Model Name :	M73
Temperature :	20 °C	Relative Humidity :	48%
Pressure :	1010 hPa	Test Voltage :	DC 3.7V
Test Mode :	TX 2402MHz – CH00 (3Mbps)	Polarization :	Vertical

Frequency (MHz)	Meter Reading (dBµV)	Factor (dB)	Emission Level (dBµV/m)	Limits (dBµV/m)	Margin (dB)	Detector Type
4804.145	63.4	-3.64	59.76	74	-14.24	peak
4804.145	47.26	-3.64	43.62	54	-10.38	AVG
7206.131	54.63	-0.95	53.68	74	-20.32	peak
7206.131	43.42	-0.95	42.47	54	-11.53	AVG

Remark:

Factor = Antenna Factor + Cable Loss – Pre-amplifier.
 Factor added by measurement software automatically.
 No emission detected in 18GHz-26GHz

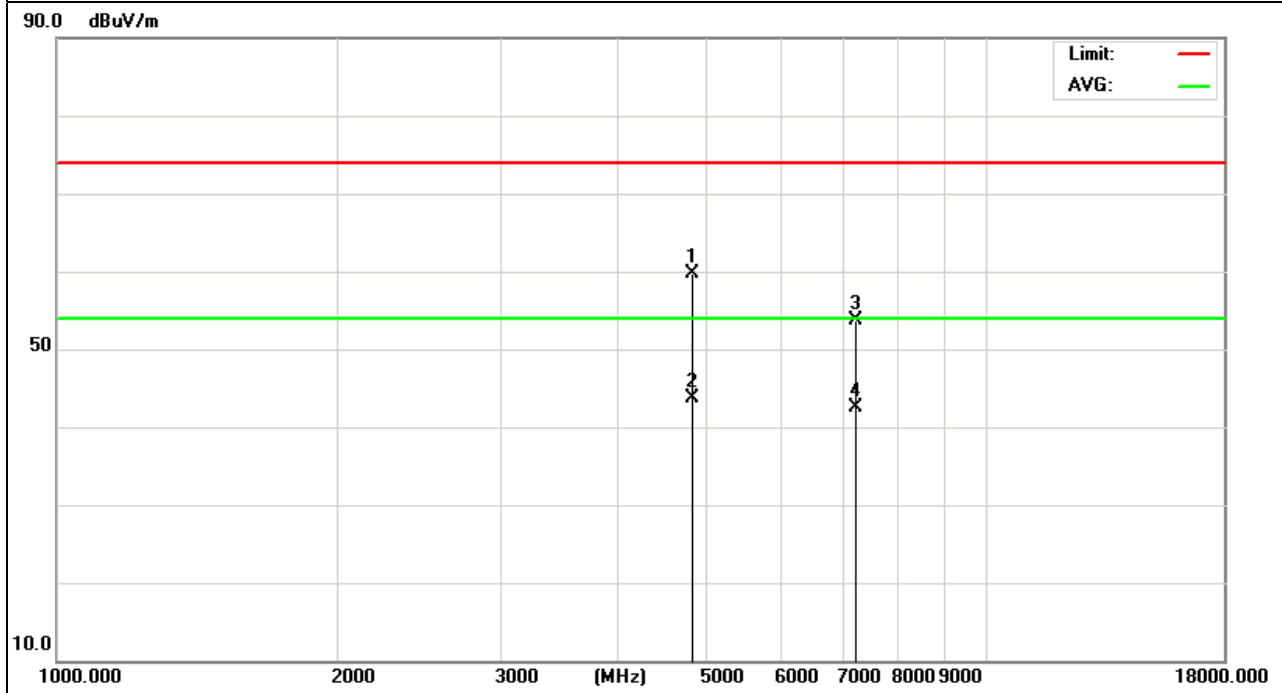

EUT :	Bluetooth Speaker	Model Name :	M73
Temperature :	20 °C	Relative Humidity :	48%
Pressure :	1010 hPa	Test Voltage :	DC 3.7V
Test Mode :	TX 2441MHz – CH39(3Mbps)	Polarization :	Horizontal

Frequency (MHz)	Meter Reading (dBµV)	Factor (dB)	Emission Level (dBµV/m)	Limits (dBµV/m)	Margin (dB)	Detector Type
4882.116	62.07	-3.68	58.39	74	-15.61	peak
4882.116	46.09	-3.68	42.41	54	-11.59	AVG
7323.147	55.44	-0.82	54.62	74	-19.38	peak
7323.147	41.17	-0.82	40.35	54	-13.65	AVG

Remark:

Factor = Antenna Factor + Cable Loss – Pre-amplifier.
 Factor added by measurement software automatically.
 No emission detected in 18GHz-26GHz

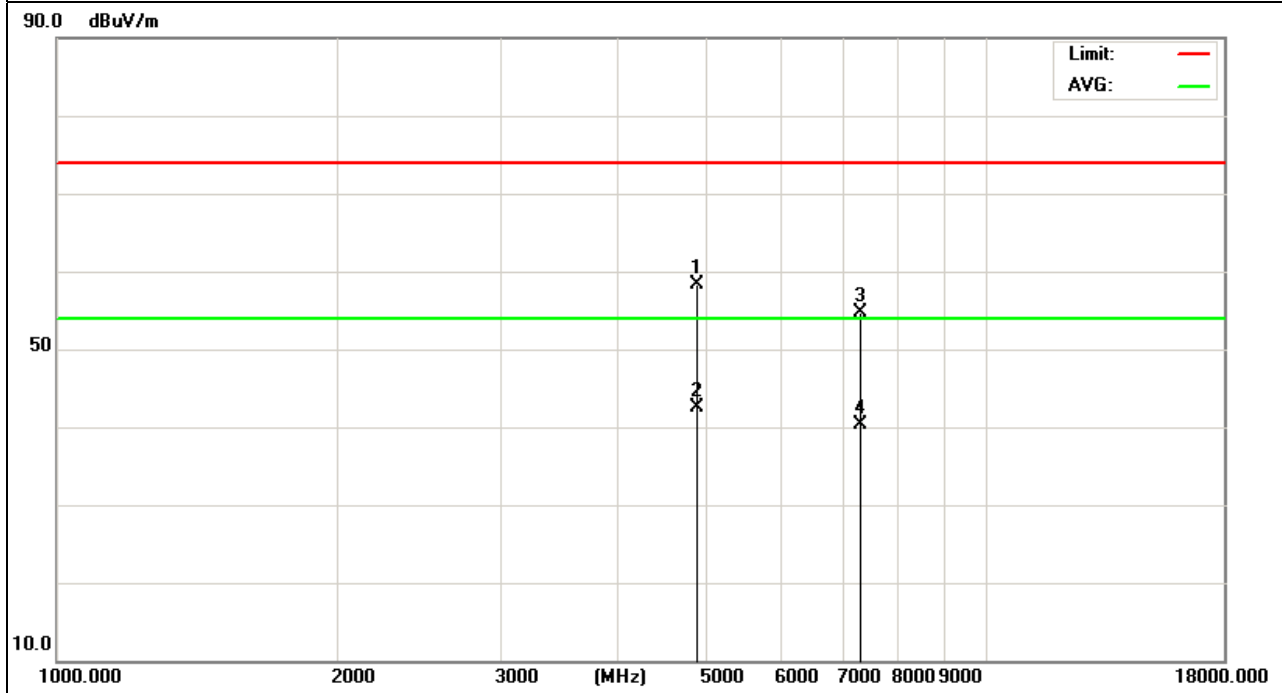

EUT :	Bluetooth Speaker	Model Name :	M73
Temperature :	20 °C	Relative Humidity :	48%
Pressure :	1010 hPa	Test Voltage :	DC 3.7V
Test Mode :	TX 2441MHz – CH39 (3Mbps)	Polarization :	Vertical

Frequency (MHz)	Meter Reading (dBμV)	Factor (dB)	Emission Level (dBμV/m)	Limits (dBμV/m)	Margin (dB)	Detector Type
4882.186	63.14	-3.68	59.46	74	-14.54	peak
4882.186	47.1	-3.68	43.42	54	-10.58	AVG
7323.162	56.53	-0.82	55.71	74	-18.29	peak
7323.162	41.07	-0.82	40.25	54	-13.75	AVG

Remark:

Factor = Antenna Factor + Cable Loss – Pre-amplifier.
 Factor added by measurement software automatically.
 No emission detected in 18GHz-26GHz

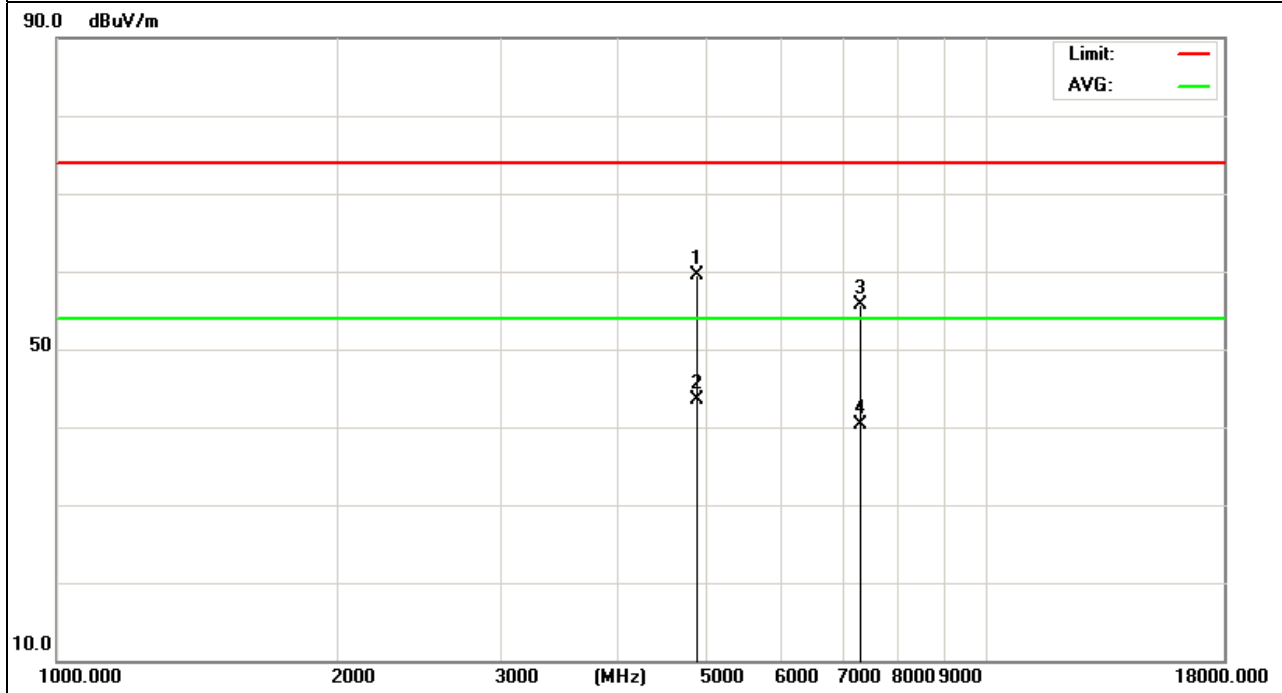

EUT :	Bluetooth Speaker	Model Name :	M73
Temperature :	20 °C	Relative Humidity :	48%
Pressure :	1010 hPa	Test Voltage :	DC 3.7V
Test Mode :	TX 2480MHz – CH78 (3Mbps)	Polarization :	Horizontal

Frequency (MHz)	Meter Reading (dBµV)	Factor (dB)	Emission Level (dBµV/m)	Limits (dBµV/m)	Margin (dB)	Detector Type
4960.166	62.09	-3.59	58.5	74	-15.5	peak
4960.166	46.98	-3.59	43.39	54	-10.61	AVG
7440.159	54.46	-0.68	53.78	74	-20.22	peak
7440.159	42.24	-0.68	41.56	54	-12.44	AVG

Remark:
 Factor = Antenna Factor + Cable Loss – Pre-amplifier.
 Factor added by measurement software automatically.
 No emission detected in 18GHz-26GHz

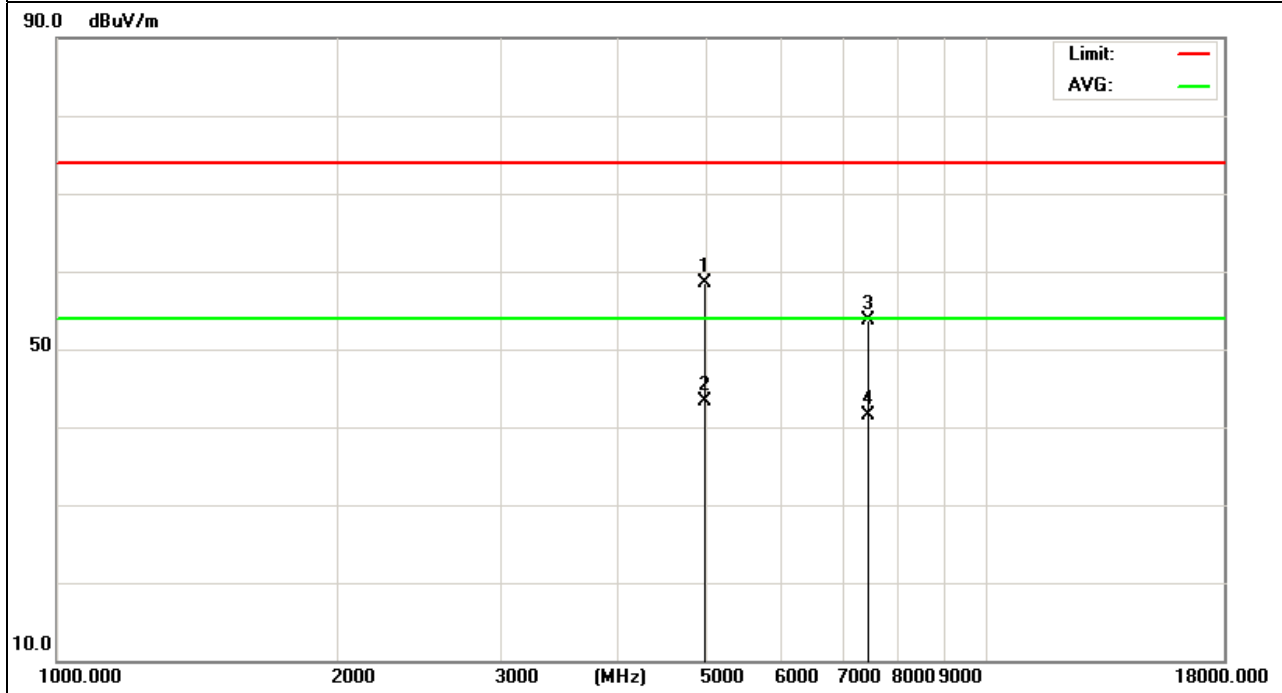

EUT :	Bluetooth Speaker	Model Name :	M73
Temperature :	20 °C	Relative Humidity :	48%
Pressure :	1010 hPa	Test Voltage :	DC 3.7V
Test Mode :	TX 2480MHz – CH78 (3Mbps)	Polarization :	Vertical

Frequency (MHz)	Meter Reading (dBμV)	Factor (dB)	Emission Level (dBμV/m)	Limits (dBμV/m)	Margin (dB)	Detector Type
4960.143	62.45	-3.59	58.86	74	-15.14	peak
4960.143	48.04	-3.59	44.45	54	-9.55	AVG
7440.185	56.05	-0.68	55.37	74	-18.63	peak
7440.185	43.26	-0.68	42.58	54	-11.42	AVG

Remark:

Factor = Antenna Factor + Cable Loss – Pre-amplifier.
 Factor added by measurement software automatically.
 No emission detected in 18GHz-26GHz

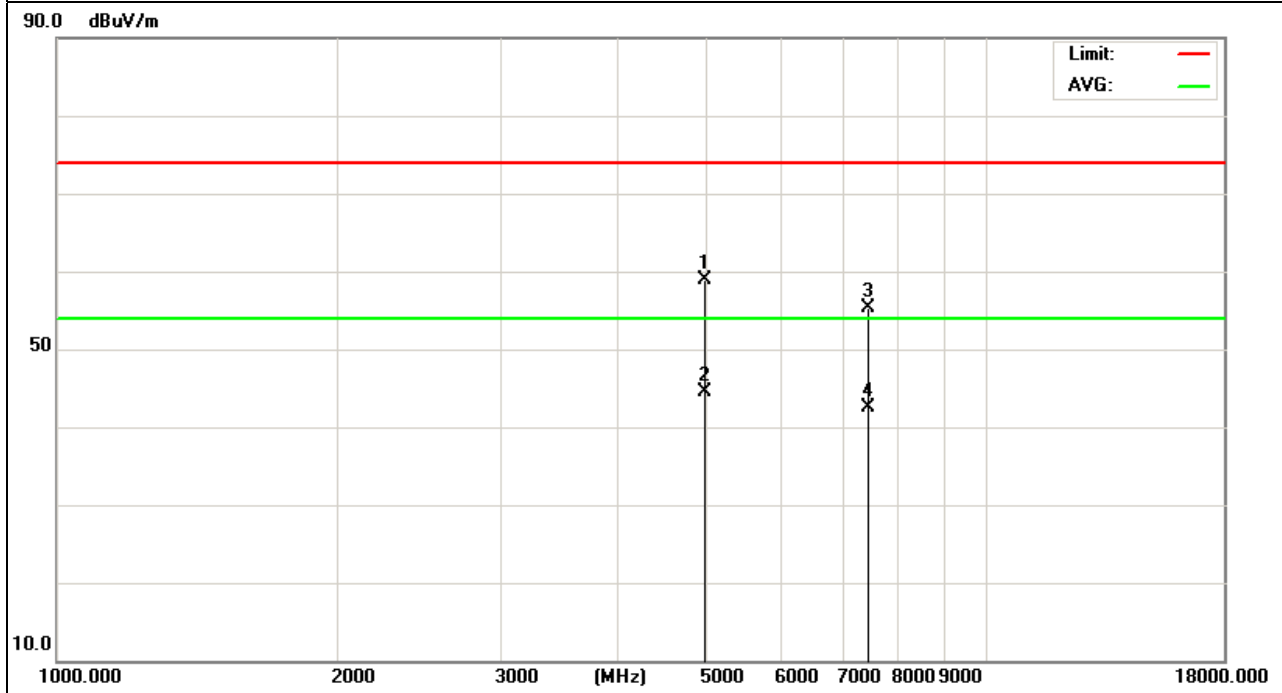

3.2.8 TEST RESULTS (RESTRICTED BANDS REQUIREMENTS)

EUT :	Bluetooth Speaker	Model Name :	M73
Temperature :	20 °C	Relative Humidity :	48%
Pressure :	1010 hPa	Test Voltage :	DC 3.7V
Test Mode :	TX /2402MHz-1Mbps	Polarization :	Vertical

Frequency	Meter Reading	Factor	Emission Level	Limits	Margin	Detector Type
(MHz)	(dBμV)	(dB)	(dBμV/m)	(dBμV/m)	(dB)	
2400	83.6	-40.5	43.1	74	-30.9	peak

Remark:
 Factor = Antenna Factor + Cable Loss – Pre-amplifier.
 Factor added by measurement software automatically.

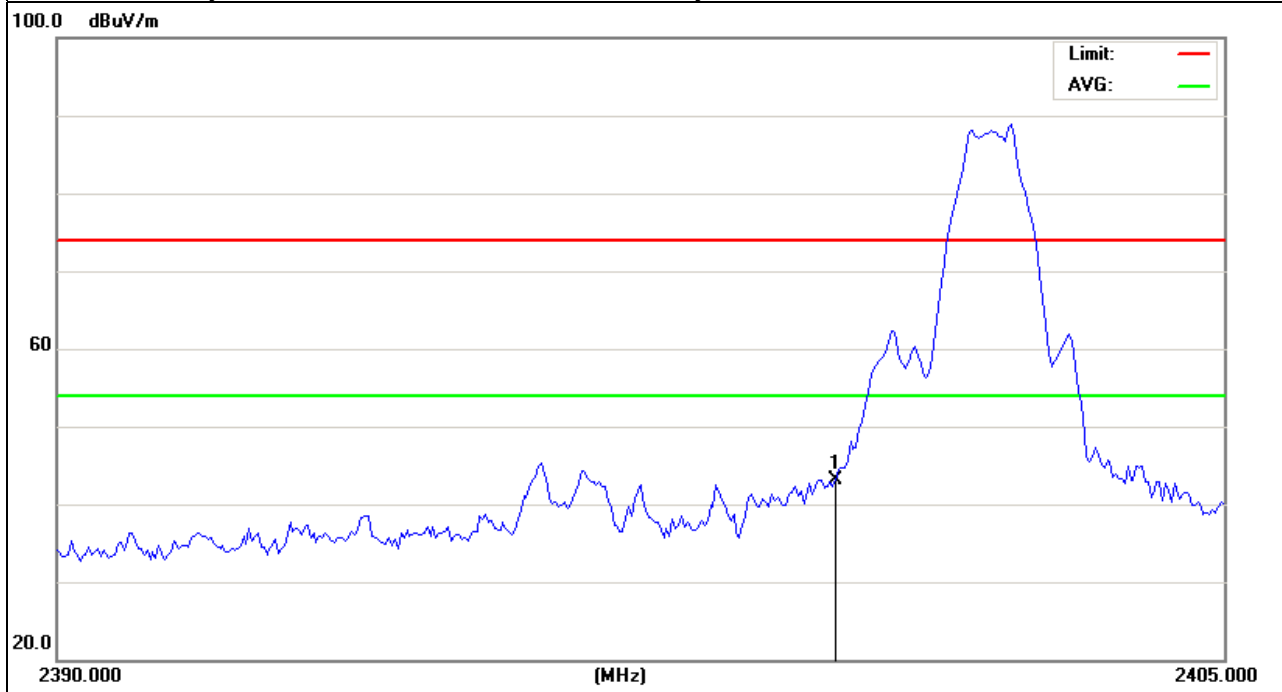

EUT :	Bluetooth Speaker	Model Name :	M73
Temperature :	20 °C	Relative Humidity :	48%
Pressure :	1010 hPa	Test Voltage :	DC 3.7V
Test Mode :	TX /2402MHz-1Mbps	Polarization :	Horizontal

Frequency (MHz)	Meter Reading (dBμV)	Factor (dB)	Emission Level (dBμV/m)	Limits (dBμV/m)	Margin (dB)	Detector Type
2400	84.5	-40.5	44	74	-30	peak

Remark:
 Factor = Antenna Factor + Cable Loss – Pre-amplifier.
 Factor added by measurement software automatically.

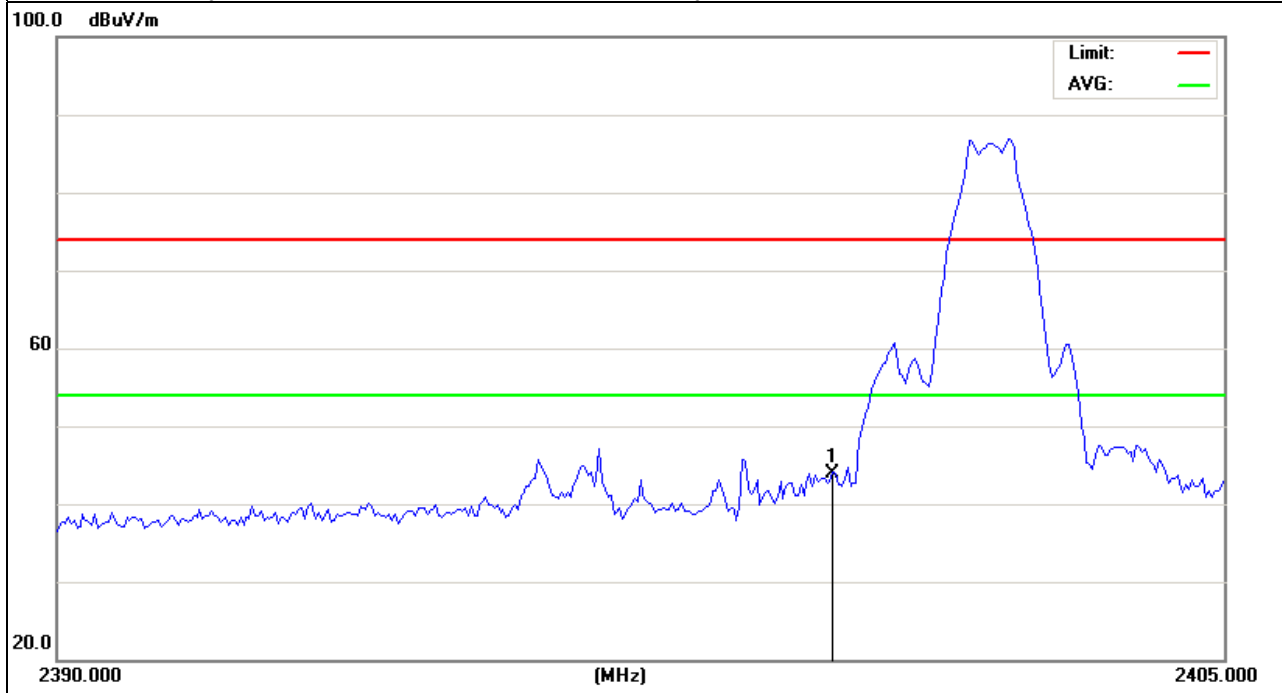

EUT :	Bluetooth Speaker	Model Name :	M73
Temperature :	20 °C	Relative Humidity :	48%
Pressure :	1010 hPa	Test Voltage :	DC 3.7V
Test Mode :	TX /2480MHz-1Mbps	Polarization :	Vertical

Frequency (MHz)	Meter Reading (dBμV)	Factor (dB)	Emission Level (dBμV/m)	Limits (dBμV/m)	Margin (dB)	Detector Type
2483.5	90.75	-40.43	50.32	74	-23.68	peak

Remark:
 Factor = Antenna Factor + Cable Loss – Pre-amplifier.
 Factor added by measurement software automatically.

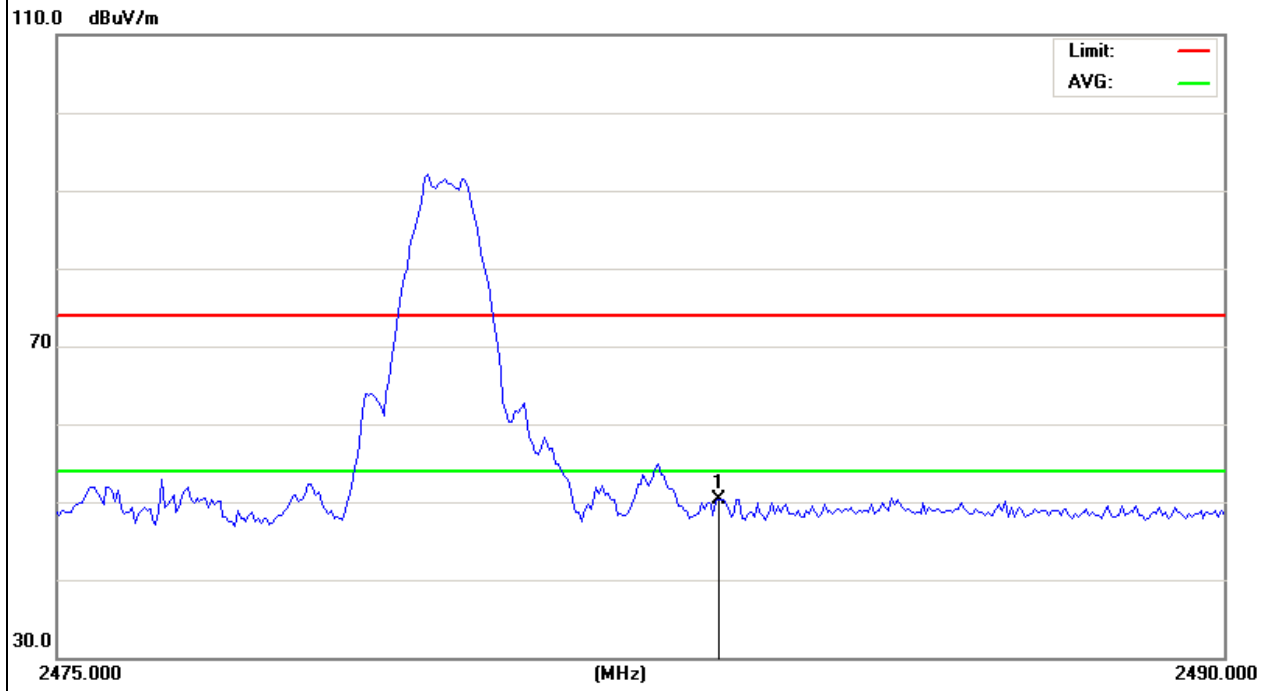

EUT :	Bluetooth Speaker	Model Name :	M73
Temperature :	20 °C	Relative Humidity :	48%
Pressure :	1010 hPa	Test Voltage :	DC 3.7V
Test Mode :	TX /2480MHz-1Mbps	Polarization :	Horizontal

Frequency (MHz)	Meter Reading (dBμV)	Factor (dB)	Emission Level (dBμV/m)	Limits (dBμV/m)	Margin (dB)	Detector Type
2483.5	81.63	-40.43	41.2	74	-32.8	peak

Remark:
 Factor = Antenna Factor + Cable Loss – Pre-amplifier.
 Factor added by measurement software automatically.

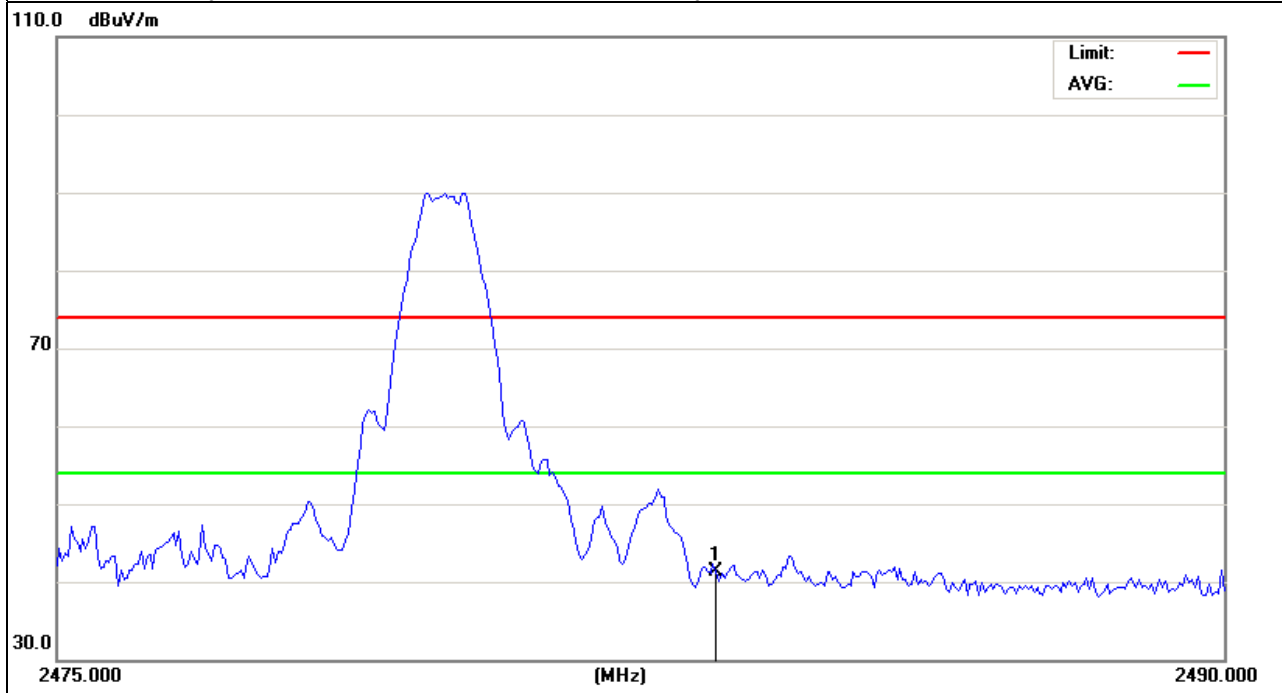

EUT :	Bluetooth Speaker	Model Name :	M73
Temperature :	20 °C	Relative Humidity :	48%
Pressure :	1010 hPa	Test Voltage :	DC 3.7V
Test Mode :	TX /2402MHz-2Mbps	Polarization :	Vertical

Frequency (MHz)	Meter Reading (dBμV)	Factor (dB)	Emission Level (dBμV/m)	Limits (dBμV/m)	Margin (dB)	Detector Type
2400	82.2	-40.5	41.7	74	-32.3	peak

Remark:
 Factor = Antenna Factor + Cable Loss – Pre-amplifier.
 Factor added by measurement software automatically.

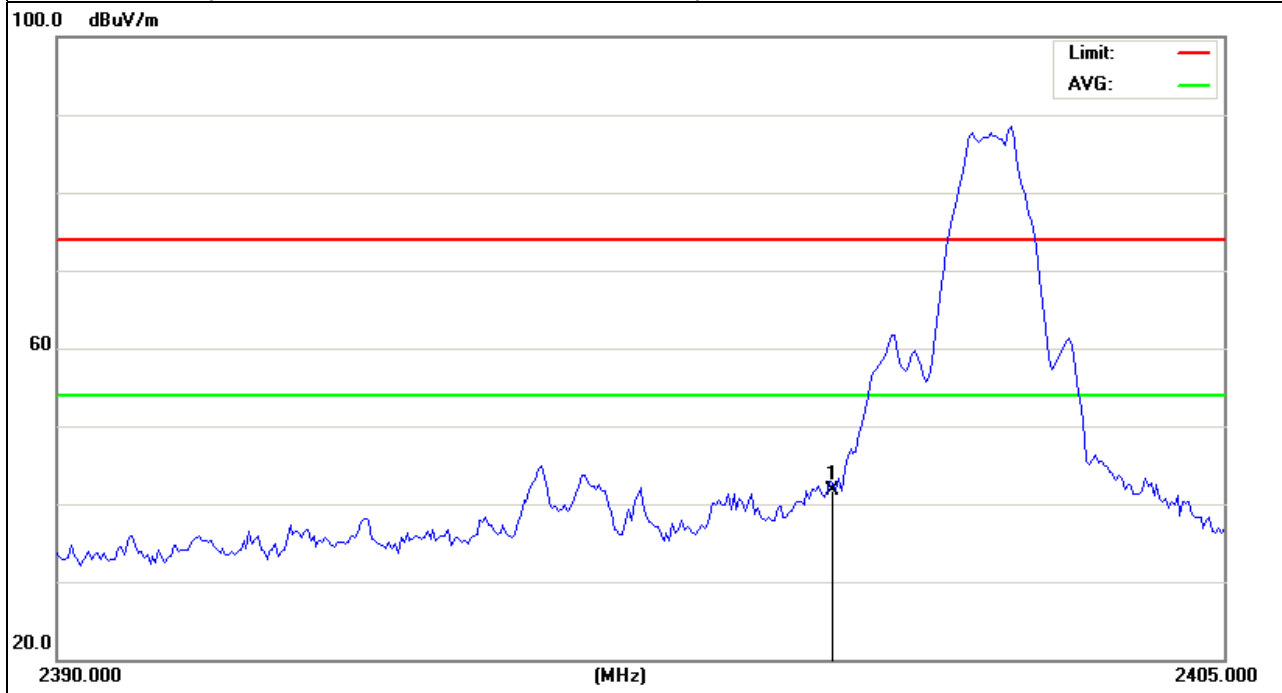

EUT :	Bluetooth Speaker	Model Name :	M73
Temperature :	20 °C	Relative Humidity :	48%
Pressure :	1010 hPa	Test Voltage :	DC 3.7V
Test Mode :	TX /2402MHz-2Mbps	Polarization :	Horizontal

Frequency (MHz)	Meter Reading (dBμV)	Factor (dB)	Emission Level (dBμV/m)	Limits (dBμV/m)	Margin (dB)	Detector Type
2400	82	-40.5	41.5	74	-32.5	peak

Remark:
 Factor = Antenna Factor + Cable Loss – Pre-amplifier.
 Factor added by measurement software automatically.

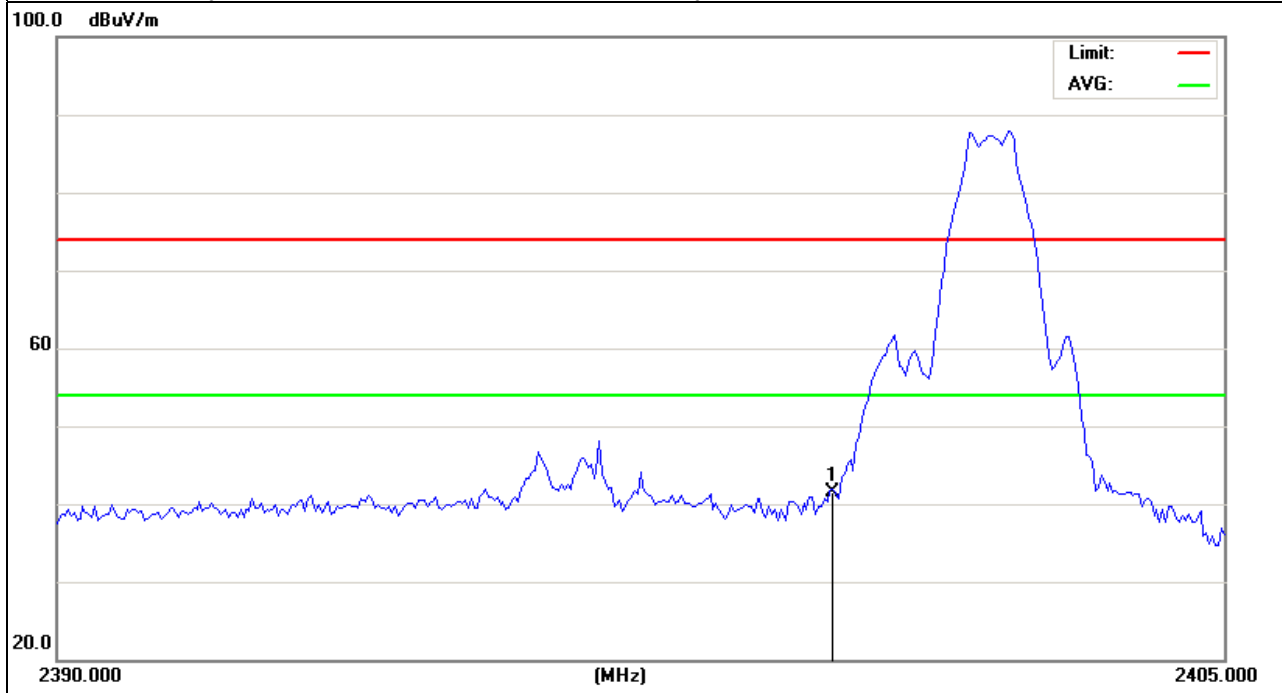

EUT :	Bluetooth Speaker	Model Name :	M73
Temperature :	20 °C	Relative Humidity :	48%
Pressure :	1010 hPa	Test Voltage :	DC 3.7V
Test Mode :	TX /2480MHz-2Mbps	Polarization :	Vertical

Frequency (MHz)	Meter Reading (dBμV)	Factor (dB)	Emission Level (dBμV/m)	Limits (dBμV/m)	Margin (dB)	Detector Type
2483.5	91.14	-40.43	50.71	74	-23.29	peak

Remark:
 Factor = Antenna Factor + Cable Loss – Pre-amplifier.
 Factor added by measurement software automatically.

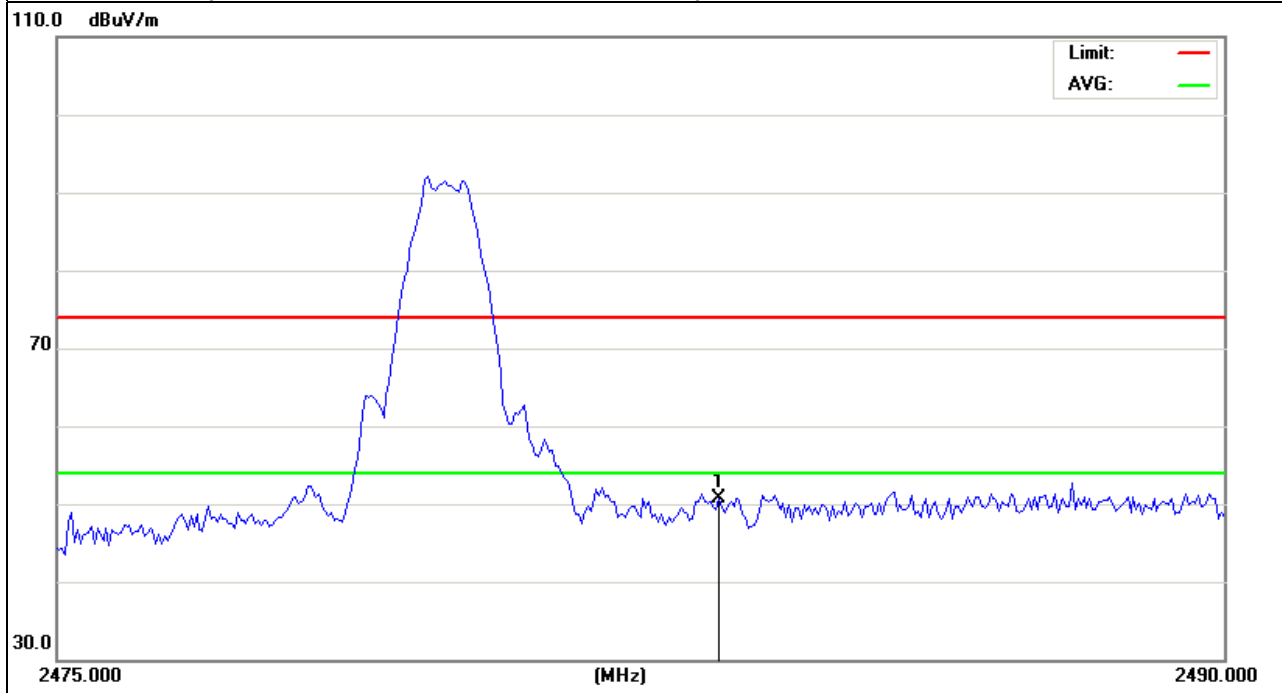

EUT :	Bluetooth Speaker	Model Name :	M73
Temperature :	20 °C	Relative Humidity :	48%
Pressure :	1010 hPa	Test Voltage :	DC 3.7V
Test Mode :	TX /2480MHz-2Mbps	Polarization :	Horizontal

Frequency (MHz)	Meter Reading (dBμV)	Factor (dB)	Emission Level (dBμV/m)	Limits (dBμV/m)	Margin (dB)	Detector Type
2483.5	85.24	-40.43	44.81	74	-29.19	peak

Remark:
 Factor = Antenna Factor + Cable Loss – Pre-amplifier.
 Factor added by measurement software automatically.

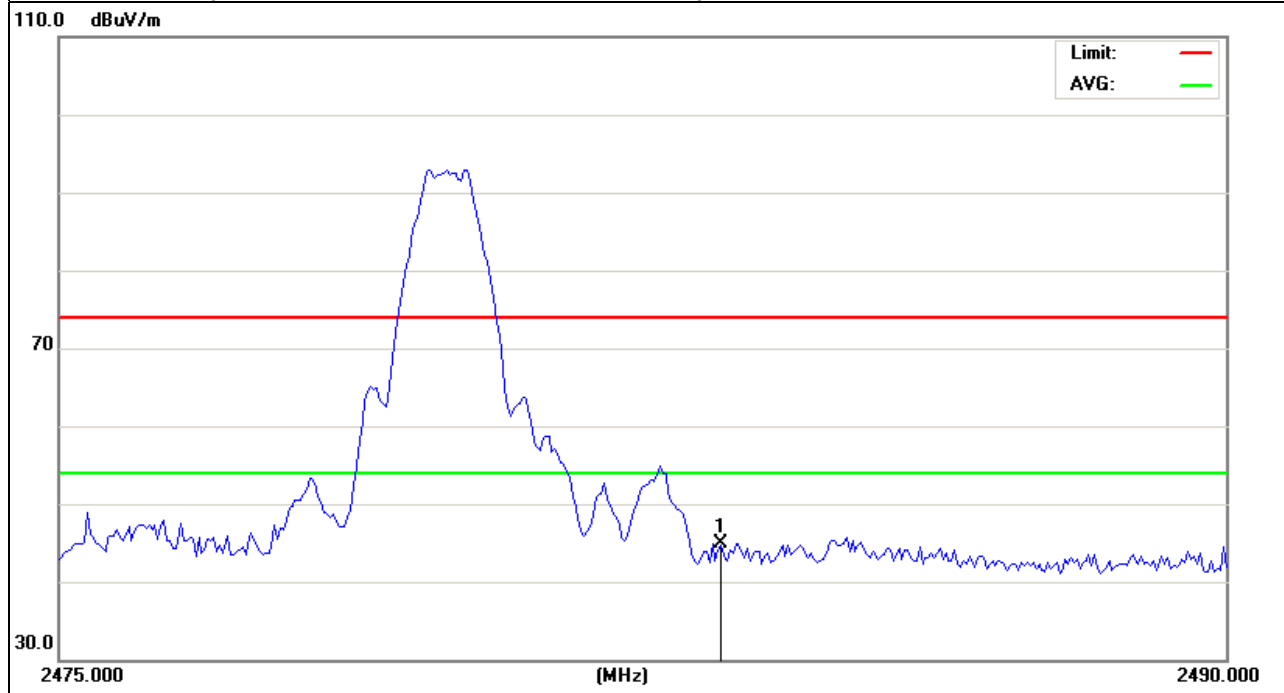

EUT :	Bluetooth Speaker	Model Name :	M73
Temperature :	20 °C	Relative Humidity :	48%
Pressure :	1010 hPa	Test Voltage :	DC 3.7V
Test Mode :	TX /2402MHz-3Mbps	Polarization :	Vertical

Frequency (MHz)	Meter Reading (dBμV)	Factor (dB)	Emission Level (dBμV/m)	Limits (dBμV/m)	Margin (dB)	Detector Type
2400	90.6	-40.5	50.1	74	-23.9	peak

Remark:
 Factor = Antenna Factor + Cable Loss – Pre-amplifier.
 Factor added by measurement software automatically.

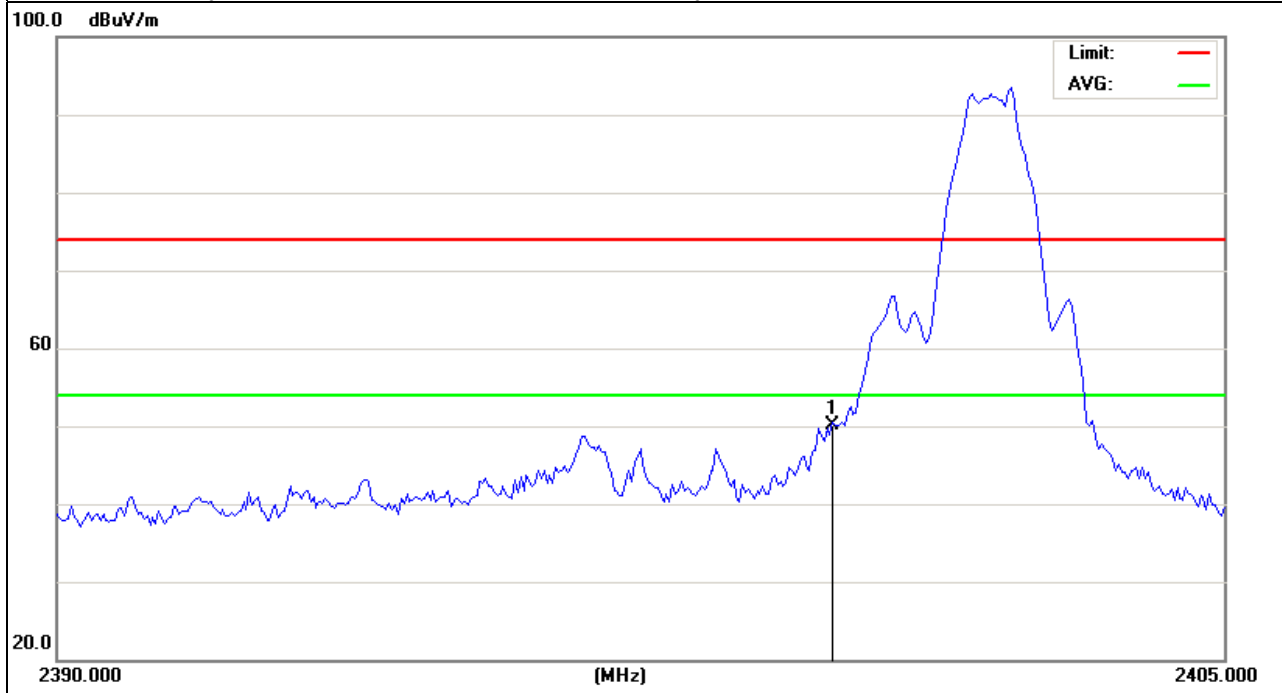

EUT :	Bluetooth Speaker	Model Name :	M73
Temperature :	20 °C	Relative Humidity :	48%
Pressure :	1010 hPa	Test Voltage :	DC 3.7V
Test Mode :	TX /2402MHz-3Mbps	Polarization :	Horizontal

Frequency (MHz)	Meter Reading (dBμV)	Factor (dB)	Emission Level (dBμV/m)	Limits (dBμV/m)	Margin (dB)	Detector Type
2400	81.6	-40.5	41.1	74	-32.9	peak

Remark:
 Factor = Antenna Factor + Cable Loss – Pre-amplifier.
 Factor added by measurement software automatically.

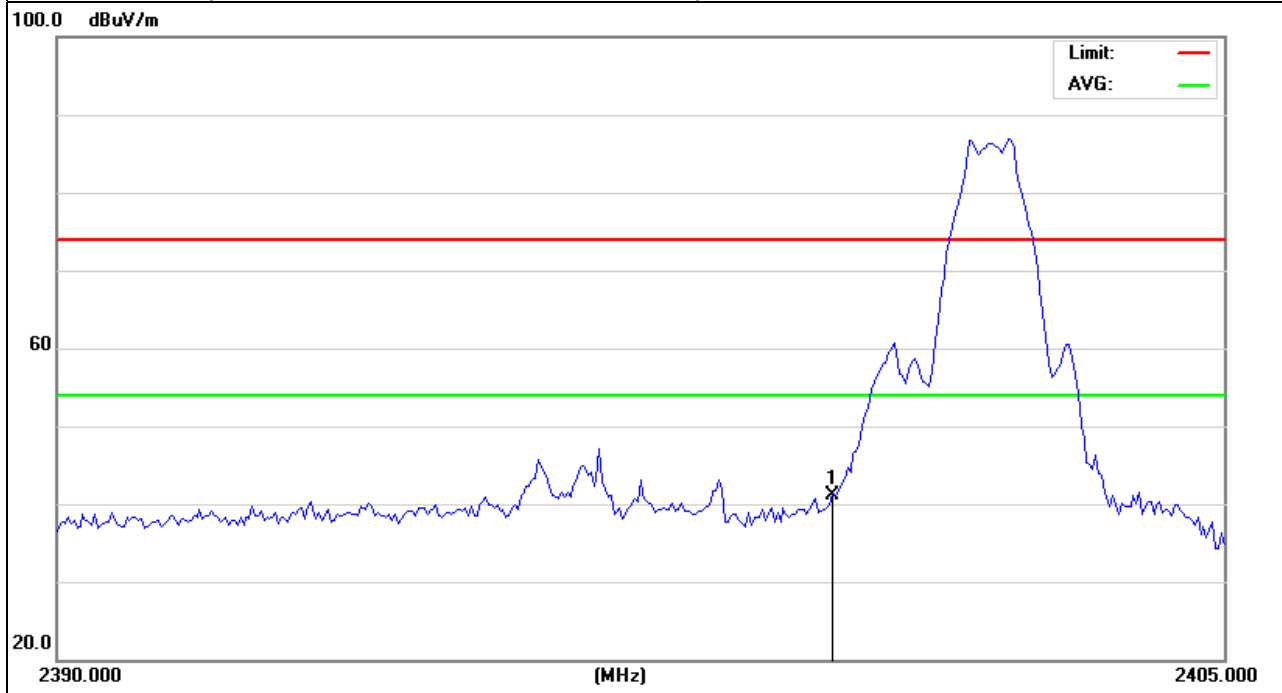

EUT :	Bluetooth Speaker	Model Name :	M73
Temperature :	20 °C	Relative Humidity :	48%
Pressure :	1010 hPa	Test Voltage :	DC 3.7V
Test Mode :	TX /2480MHz-3Mbps	Polarization :	Vertical

Frequency (MHz)	Meter Reading (dBμV)	Factor (dB)	Emission Level (dBμV/m)	Limits (dBμV/m)	Margin (dB)	Detector Type
2483.5	90.73	-40.43	50.3	74	-23.7	peak

Remark:
 Factor = Antenna Factor + Cable Loss – Pre-amplifier.
 Factor added by measurement software automatically.

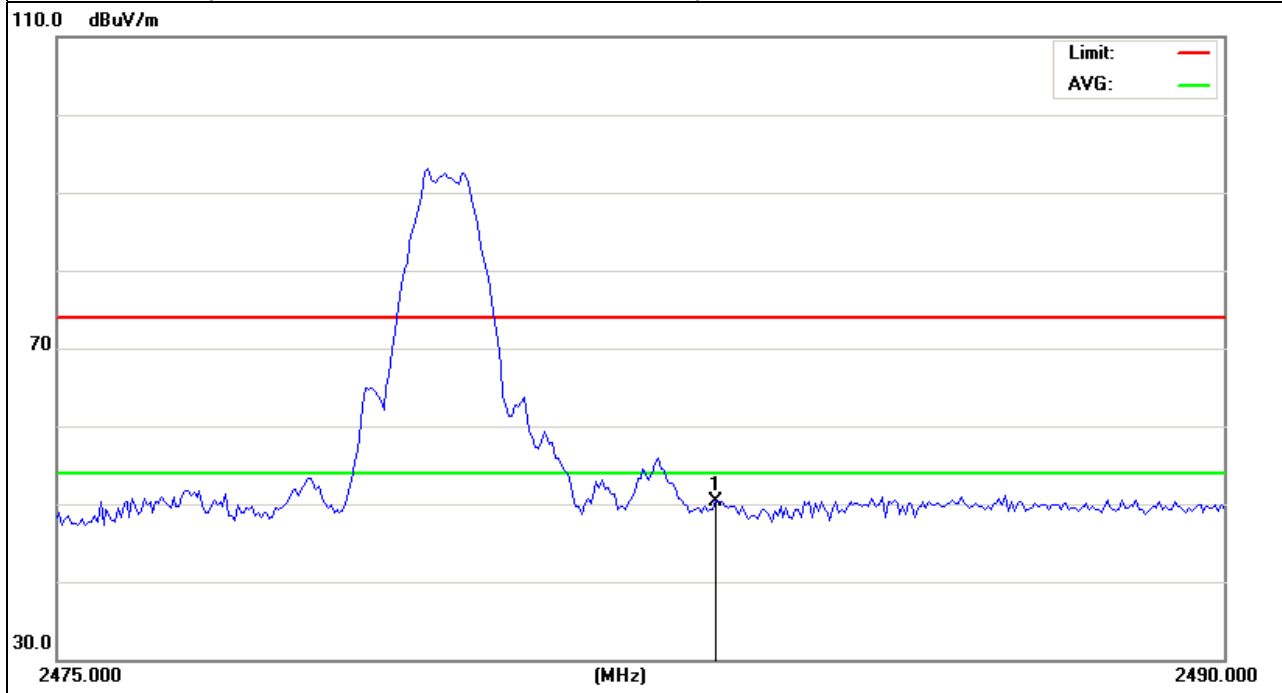

EUT :	Bluetooth Speaker	Model Name :	M73
Temperature :	20 °C	Relative Humidity :	48%
Pressure :	1010 hPa	Test Voltage :	DC 3.7V
Test Mode :	TX /2480MHz-3Mbps	Polarization :	Horizontal

Frequency (MHz)	Meter Reading (dBμV)	Factor (dB)	Emission Level (dBμV/m)	Limits (dBμV/m)	Margin (dB)	Detector Type
2483.5	83.53	-40.43	43.1	74	-30.9	peak

Remark:
 Factor = Antenna Factor + Cable Loss – Pre-amplifier.
 Factor added by measurement software automatically.

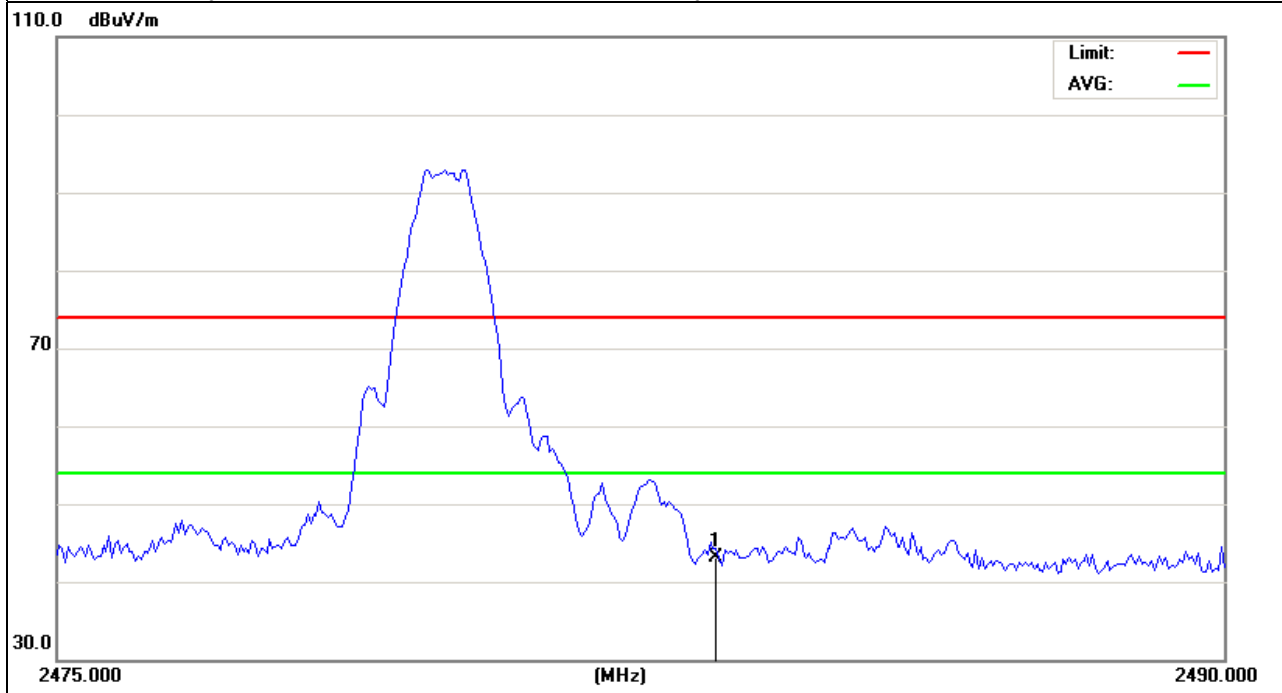

4. NUMBER OF HOPPING CHANNEL

4.1 APPLIED PROCEDURES / LIMIT

FCC Part15 (15.247) , Subpart C				
Section	Test Item	Limit	Frequency Range (MHz)	Result
15.247 (a)(1)(iii)	Number of Hopping Channel	≥15	2400-2483.5	PASS

Spectrum Parameters	Setting
Attenuation	Auto
Span Frequency	= the frequency band of operation
RB	RBW ≥ 1% of the span
VB	VBW ≥ RBW
Detector	Peak
Trace	Max Hold
Sweep Time	Auto

4.1.1 TEST PROCEDURE

- a. The EUT was directly connected to the spectrum analyzer and antenna output port as show in the block diagram below,
- b. Spectrum Setting : RBW= 1MHz, VBW=1MHz, Sweep time = Auto.

4.1.2 DEVIATION FROM STANDARD

No deviation.

4.1.3 TEST SETUP



4.1.4 EUT OPERATION CONDITIONS

The EUT tested system was configured as the statements of 2.4 Unless otherwise a special operating condition is specified in the follows during the testing.

4.1.5 TEST RESULTS

EUT :	Bluetooth Speaker	Model Name :	M73
Temperature :	25 °C	Relative Humidity :	60%
Pressure :	1015 hPa	Test Voltage :	DC 3.7V
Test Mode :	Hopping Mode		

Number of Hopping Channel	79
---------------------------	----

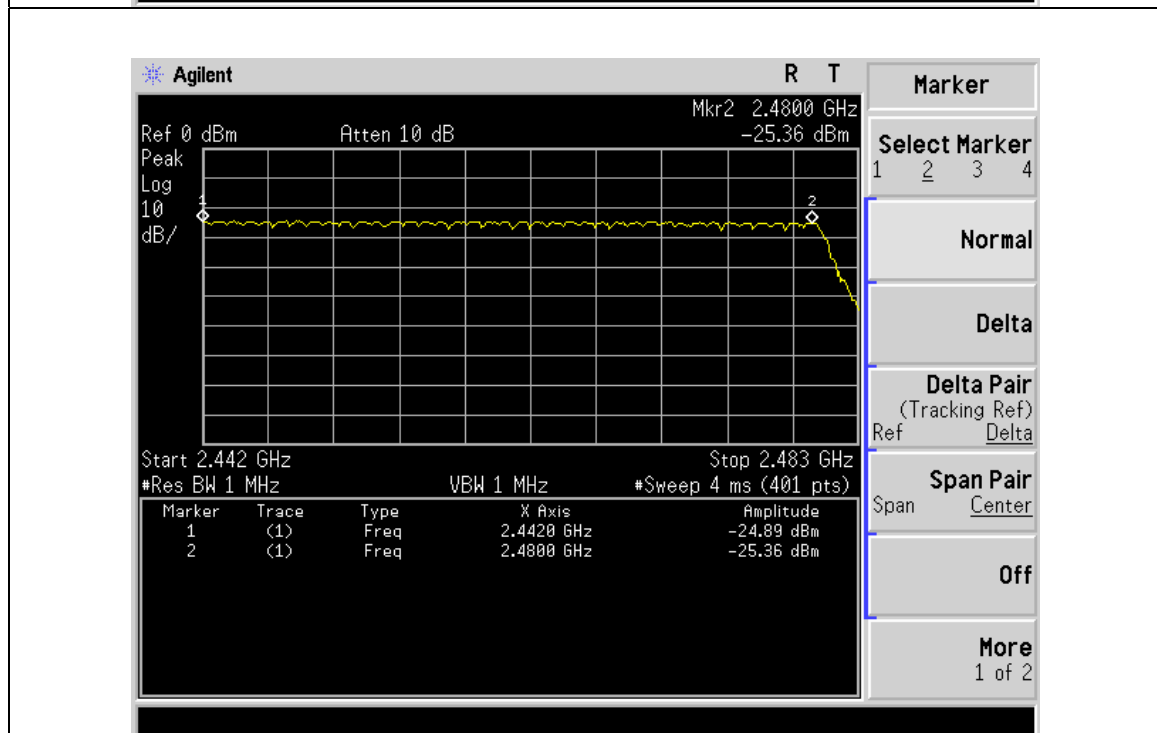
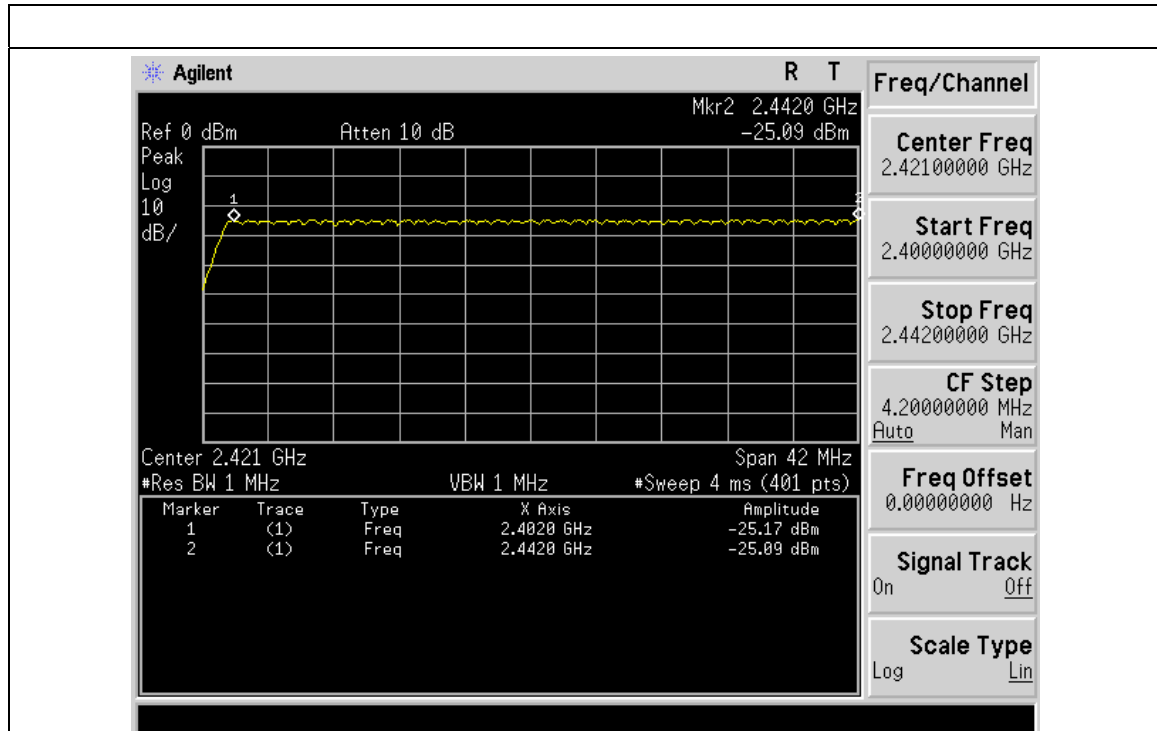

5. AVERAGE TIME OF OCCUPANCY

5.1 APPLIED PROCEDURES / LIMIT

FCC Part15 (15.247) , Subpart C				
Section	Test Item	Limit	Frequency Range (MHz)	Result
15.247 (a)(1)(iii)	Average Time of Occupancy	0.4sec	2400-2483.5	PASS

5.1.1 TEST PROCEDURE

- a. The transmitter output (antenna port) was connected to the spectrum analyzer
- b. Set RBW of spectrum analyzer to 1MHz and VBW to 1MHz.
- c. Use a video trigger with the trigger level set to enable triggering only on full pulses.
- d. Sweep Time is more than once pulse time.
- e. Set the center frequency on any frequency would be measure and set the frequency span to zero span.
- f. Measure the maximum time duration of one single pulse.
- g. Set the EUT for DH5, DH3 and DH1 packet transmitting.
- h. Measure the maximum time duration of one single pulse.
- i. A Period Time = (channel number)*0.4
 DH1 Time Slot: Reading * (1600/2)*31.6/(channel number)
 DH3 Time Slot: Reading * (1600/4)*31.6/(channel number)
 DH5 Time Slot: Reading * (1600/6)*31.6/(channel number)

5.1.2 DEVIATION FROM STANDARD

No deviation.

5.1.3 TEST SETUP

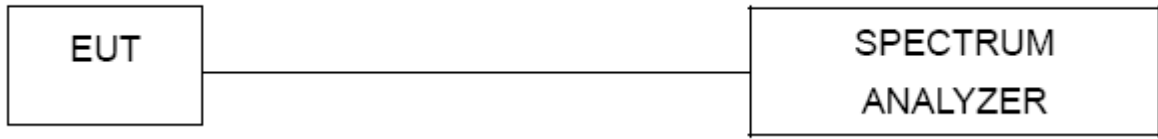

5.1.4 EUT OPERATION CONDITIONS

The EUT tested system was configured as the statements of 2.4 Unless otherwise a special operating condition is specified in the follows during the testing.

5.1.5 TEST RESULTS

EUT :	Bluetooth Speaker	Model Name :	M73
Temperature :	25 °C	Relative Humidity :	60%
Pressure :	1012 hPa	Test Voltage :	DC 3.7V
Test Mode :	CH39-DH5 ,2DH5,3DH5		

Data Packet	Frequency	Pulse Duration (ms)	Dwell Time (s)	Limits (s)
DH5	2441 MHz	3.00	0.32	0.4
2DH5	2441 MHz	3.05	0.33	0.4
3DH5	2441 MHz	3.00	0.32	0.4

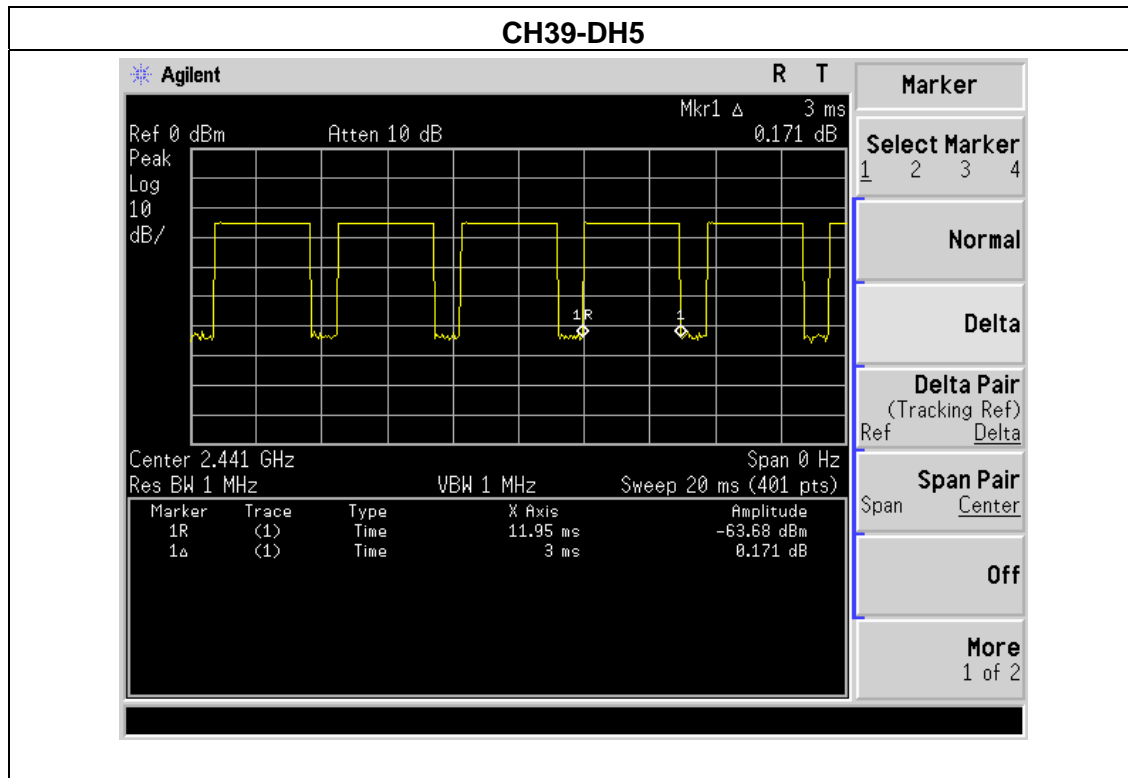

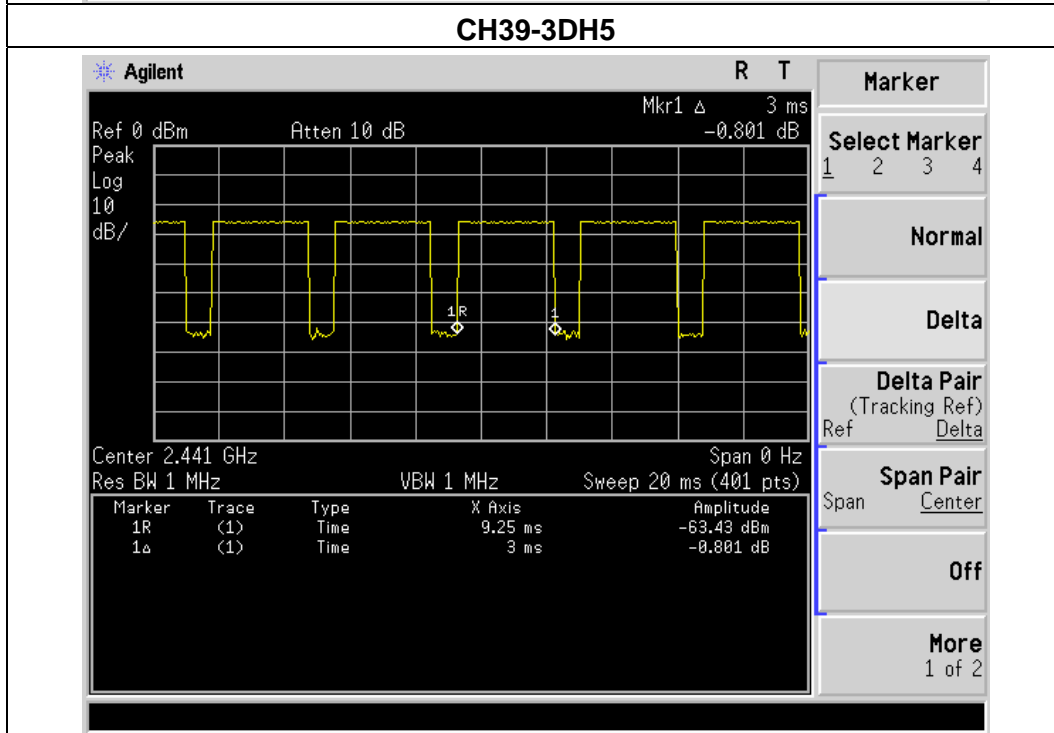
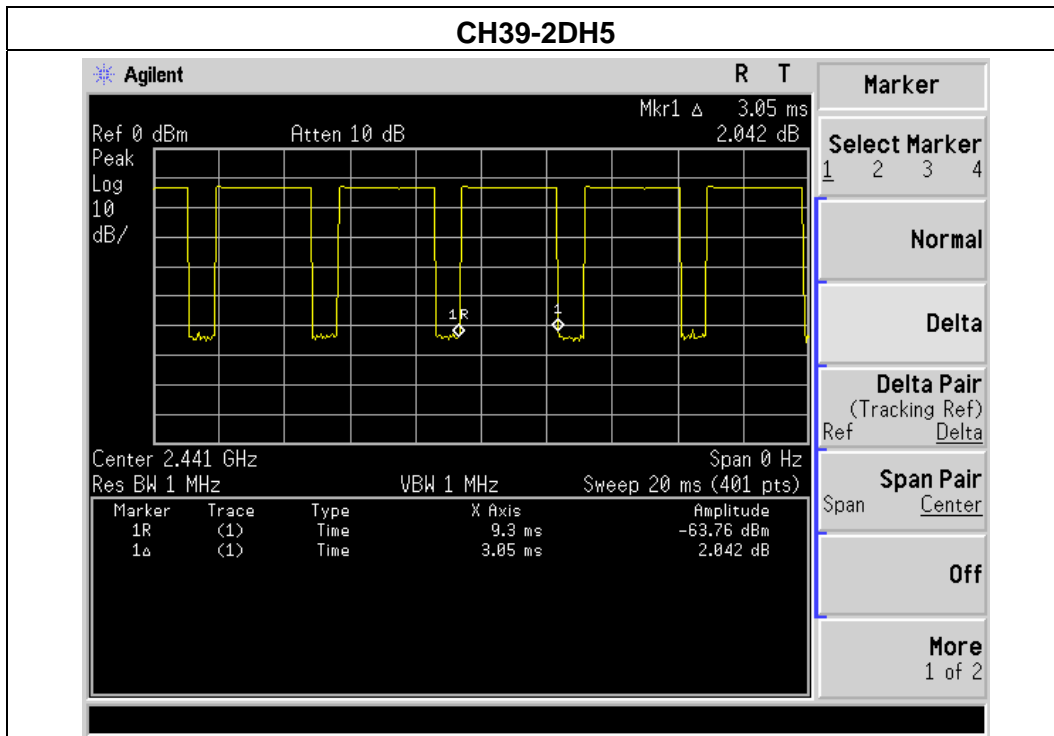

EUT :	Bluetooth Speaker	Model Name :	M73
Temperature :	25 °C	Relative Humidity :	60%
Pressure :	1012 hPa	Test Voltage :	DC 3.7V
Test Mode :	CH39-DH3,2DH3,3DH3		

Data Packet	Frequency	Pulse Duration (ms)	Dwell Time (s)	Limits (s)
DH3	2441 MHz	1.75	0.28	0.4
2DH3	2441 MHz	1.75	0.28	0.4
3DH3	2441 MHz	1.80	0.29	0.4

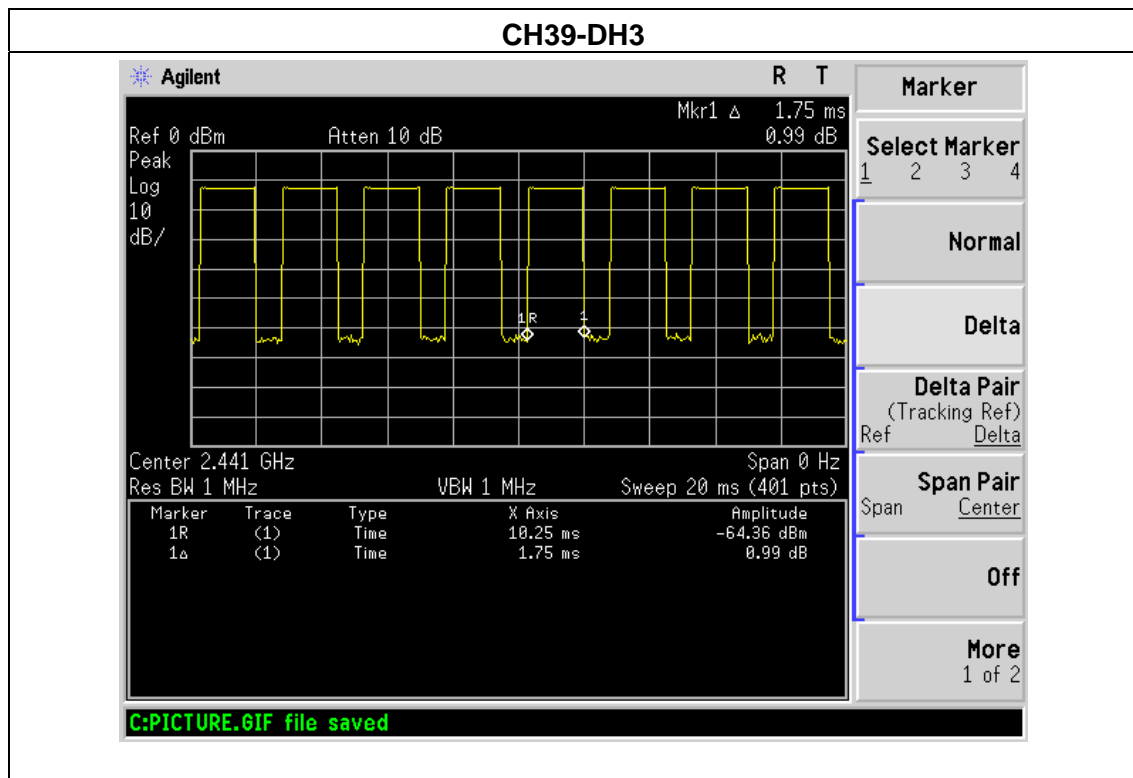

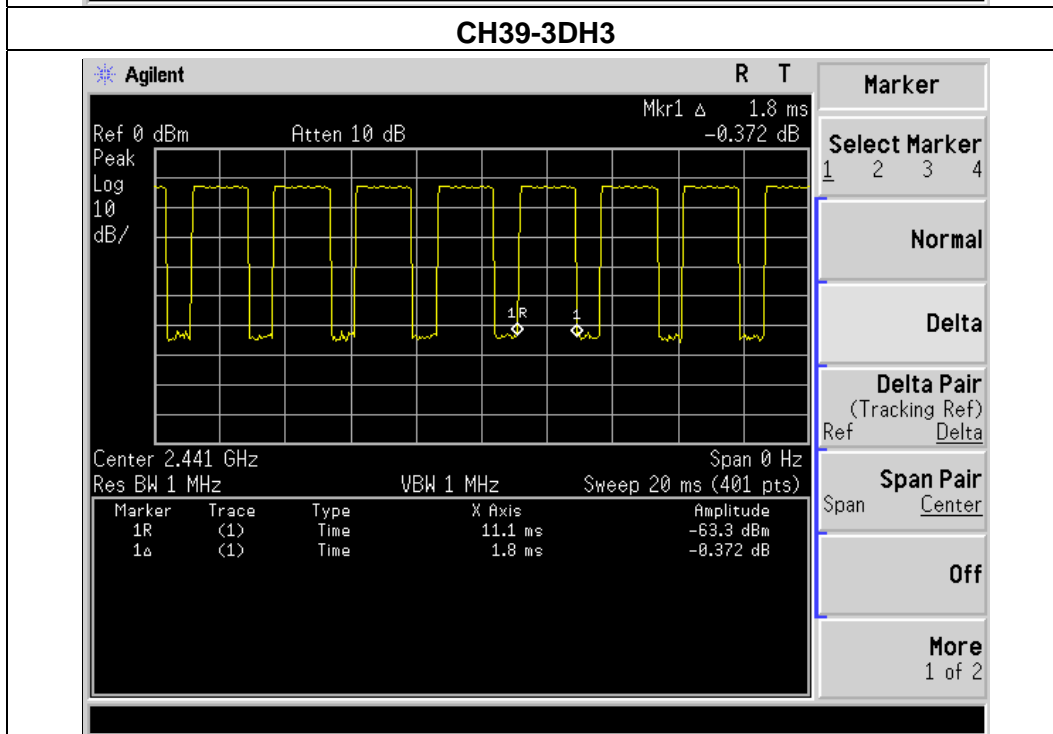
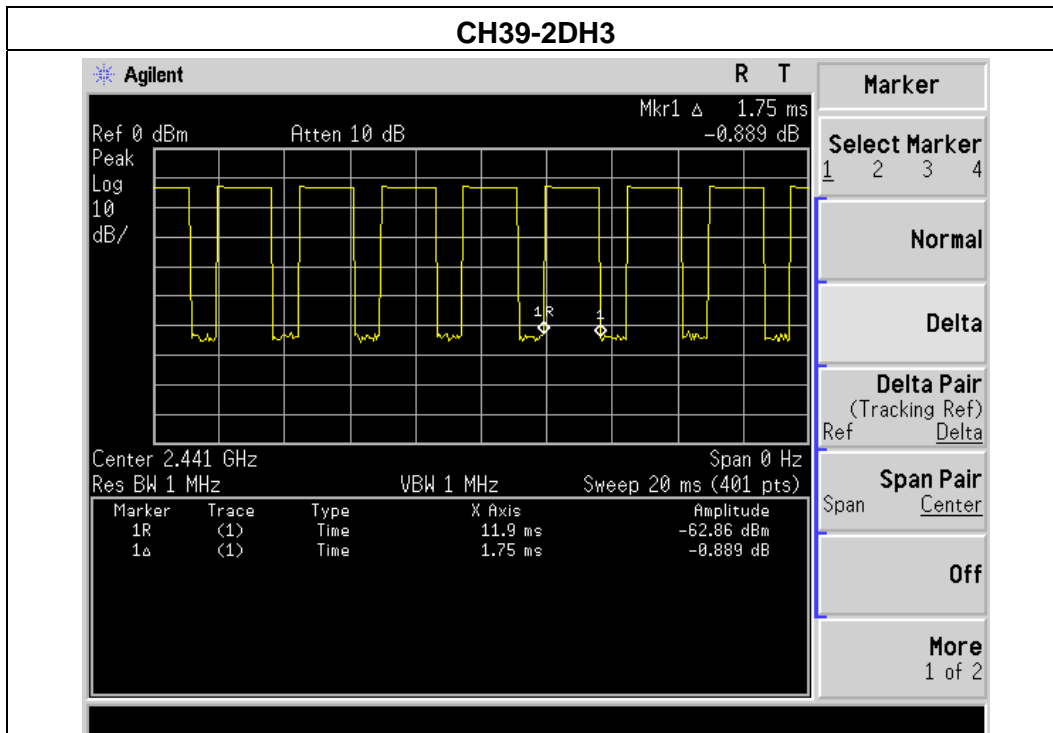

EUT :	Bluetooth Speaker	Model Name :	M73
Temperature :	25 °C	Relative Humidity :	60%
Pressure :	1012 hPa	Test Voltage :	DC 3.7V
Test Mode :	CH39-DH1,2DH1,3DH1		

Data Packet	Frequency	Pulse Duration (ms)	Dwell Time (s)	Limits (s)
DH1	2441 MHz	0.435	0.14	0.4
2DH1	2441 MHz	0.450	0.14	0.4
3DH1	2441 MHz	0.435	0.14	0.4

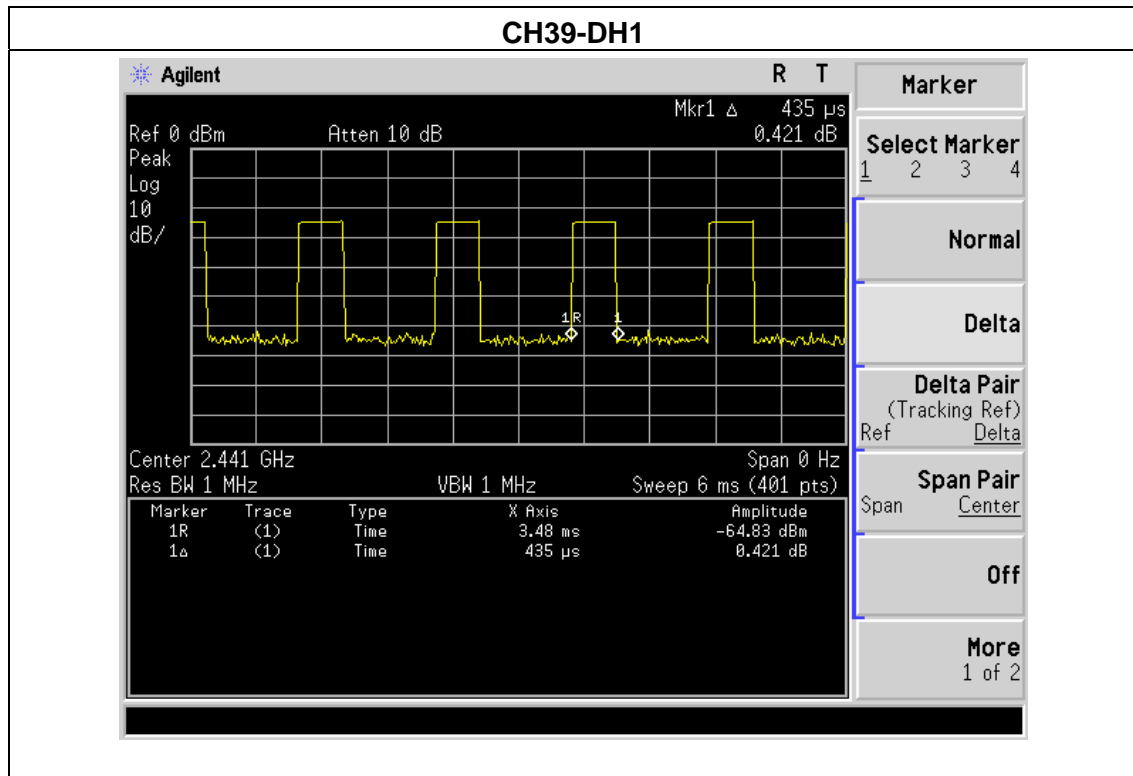

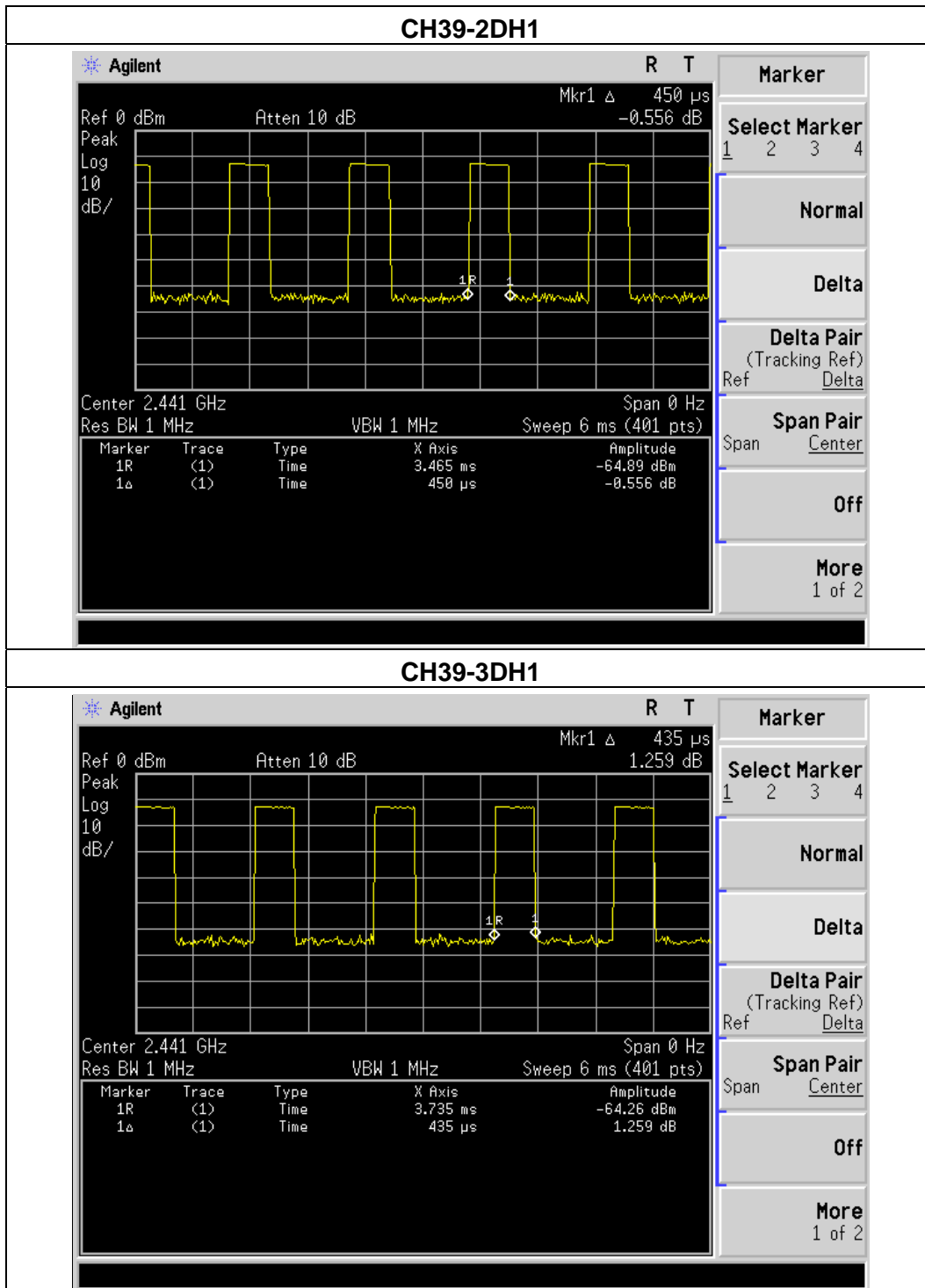

6. HOPPING CHANNEL SEPARATION MEASUREMENT

6.1 APPLIED PROCEDURES / LIMIT

Frequency hopping systems operating in the 2400-2483.5 MHz band may have hopping channel carrier frequencies that are separated by 25 kHz or two-thirds of the 20 dB bandwidth of the hopping channel, whichever is greater.

Spectrum Parameter	Setting
Attenuation	Auto
Span Frequency	> Measurement Bandwidth or Channel Separation
RB	100 kHz (Channel Separation)
VB	300 kHz (Channel Separation)
Detector	Peak
Trace	Max Hold
Sweep Time	Auto

6.1.1 TEST PROCEDURE

- a. The transmitter output (antenna port) was connected to the spectrum analyser in peak hold mode.
- b. The resolution bandwidth of 100 kHz and the video bandwidth of 300 kHz were utilised for channel separation measurement.

6.1.2 DEVIATION FROM STANDARD

No deviation.

6.1.3 TEST SETUP

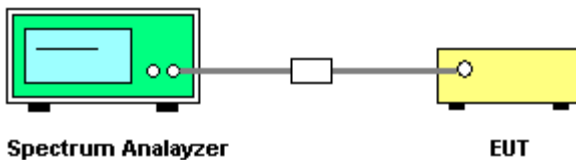

6.1.4 EUT OPERATION CONDITIONS

The EUT was programmed to be in continuously transmitting mode.

6.1.5 TEST RESULTS

EUT :	Bluetooth Speaker	Model Name :	M73
Temperature :	25 °C	Relative Humidity :	60%
Pressure :	1012 hPa	Test Voltage :	DC 3.7V
Test Mode :	CH00 / CH39 /CH78 (1Mbps Mode)		

Frequency	Ch. Separation (MHz)	Result
2402 MHz	1.000	Complies
2441 MHz	1.000	Complies
2480 MHz	1.000	Complies

Ch. Separation Limits: > 20dB bandwidth

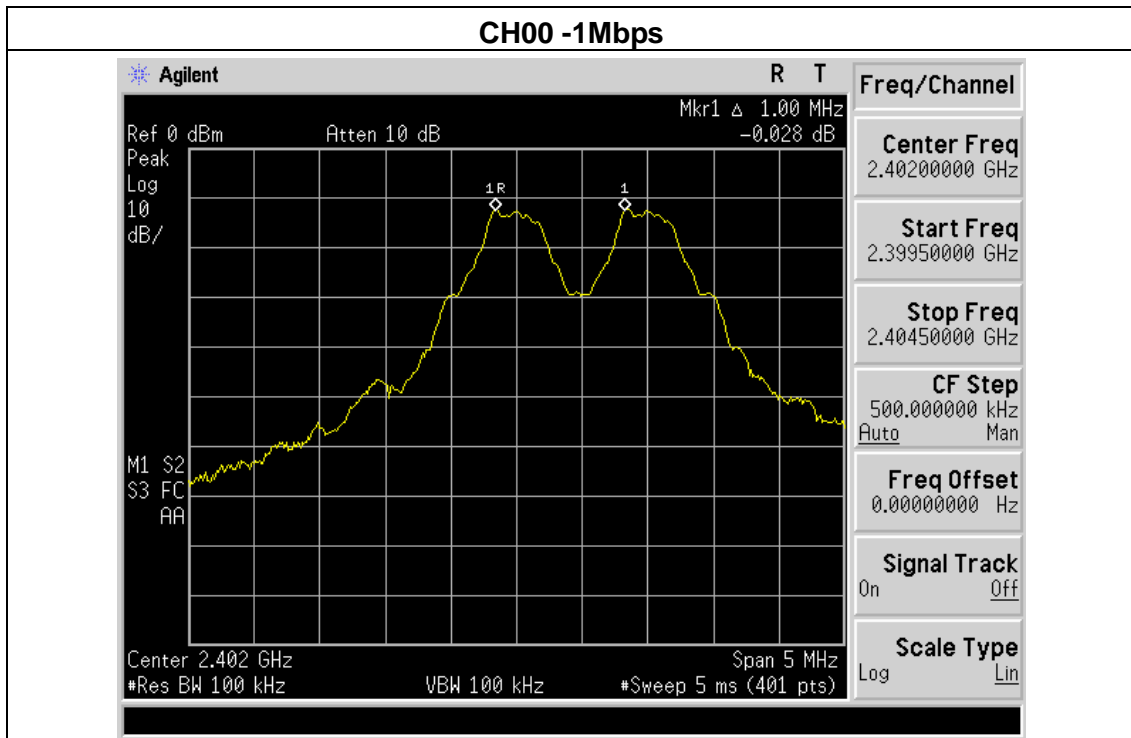

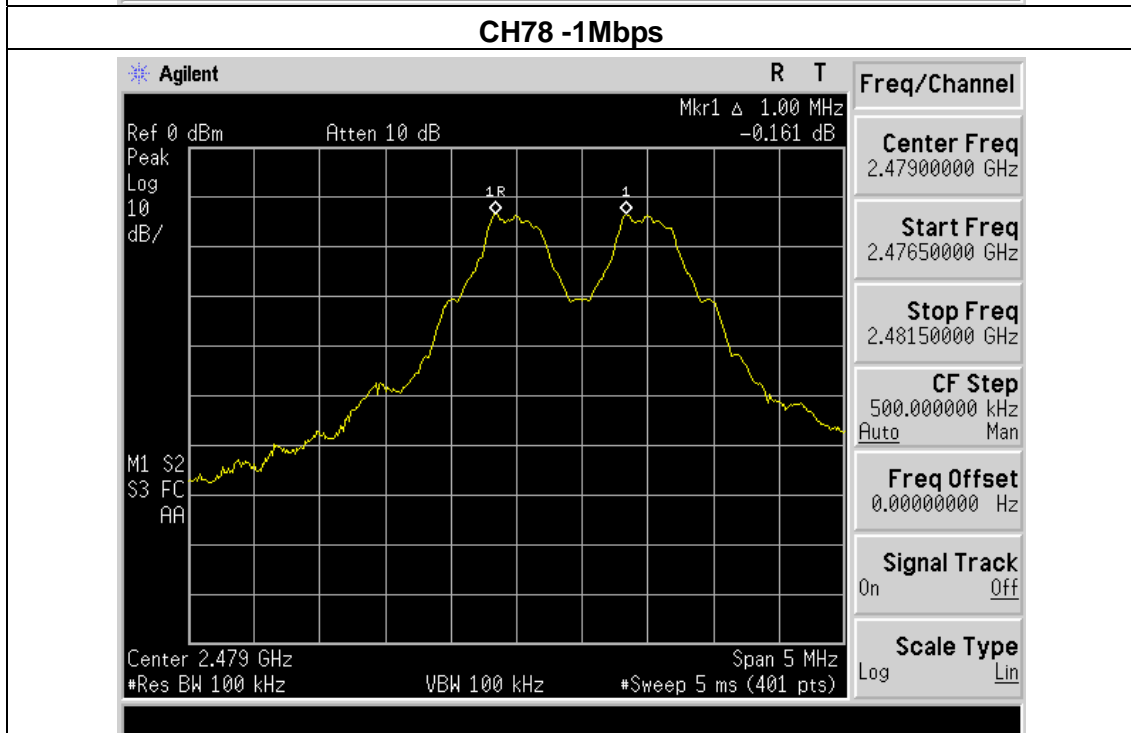
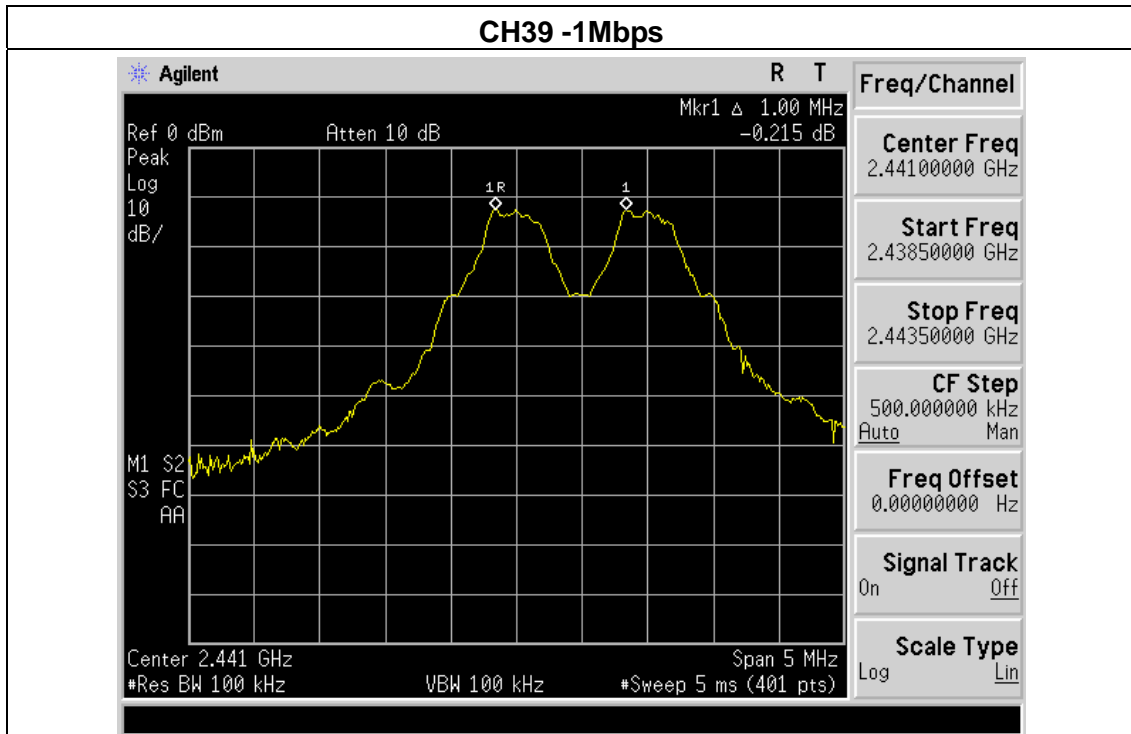

EUT :	Bluetooth Speaker	Model Name :	M73
Temperature :	25 °C	Relative Humidity :	60%
Pressure :	1012 hPa	Test Voltage :	DC 3.7V
Test Mode :	CH00 / CH39 /CH78 (2Mbps Mode)		

Frequency	Ch. Separation (MHz)	Result
2402 MHz	1.000	Complies
2441 MHz	1.000	Complies
2480 MHz	1.000	Complies

Ch. Separation Limits: >2/3 of 20dB bandwidth

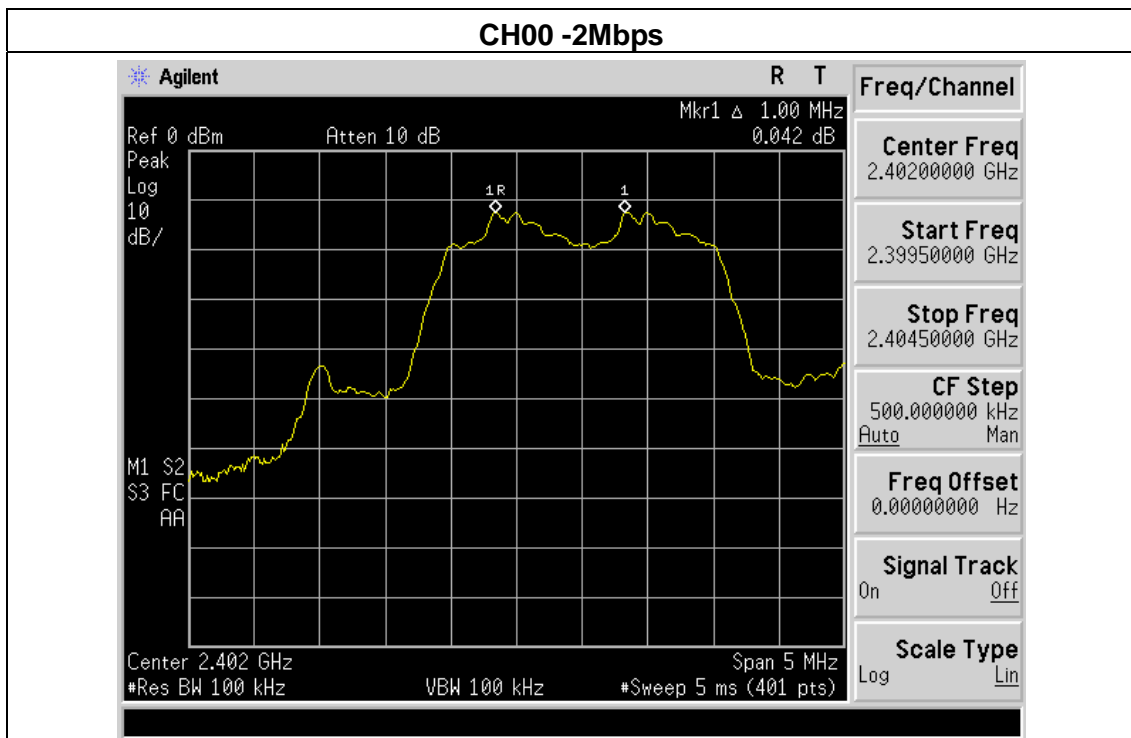

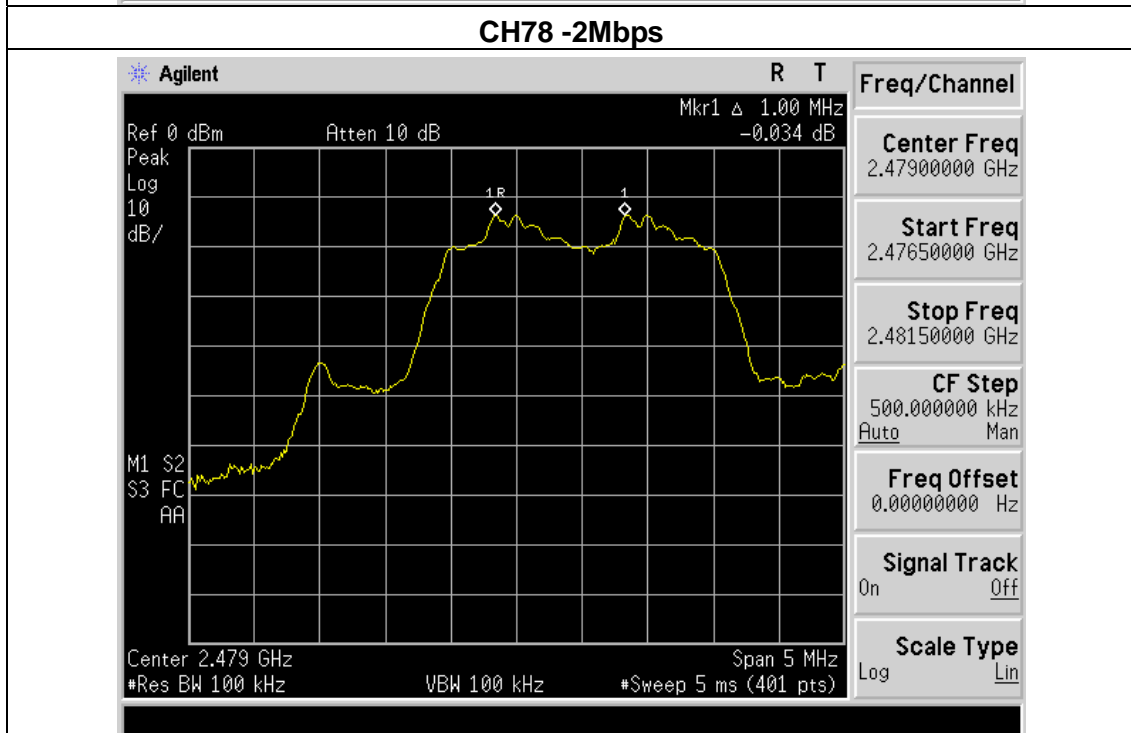
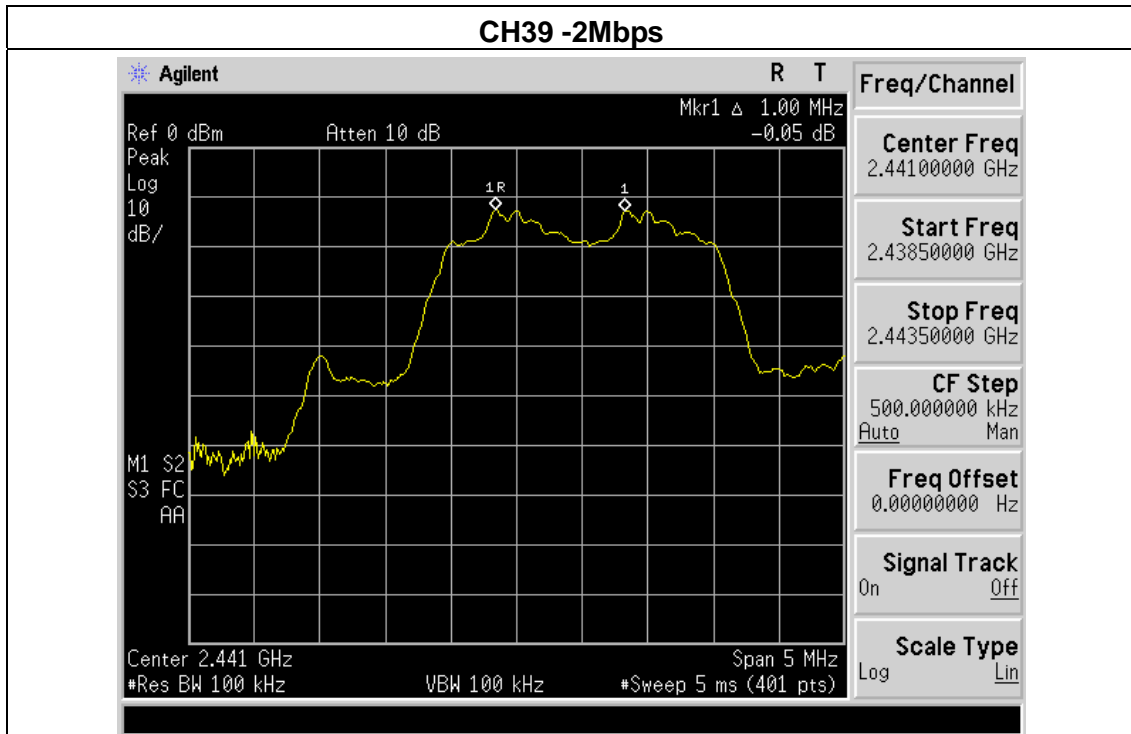

EUT :	Bluetooth Speaker	Model Name :	M73
Temperature :	25 °C	Relative Humidity :	60%
Pressure :	1012 hPa	Test Voltage :	DC 3.7V
Test Mode :	CH00 / CH39 /CH78 (3Mbps Mode)		

Frequency	Ch. Separation (MHz)	Result
2402 MHz	1.000	Complies
2441 MHz	1.000	Complies
2480 MHz	1.000	Complies

Ch. Separation Limits: >2/3 of 20dB bandwidth

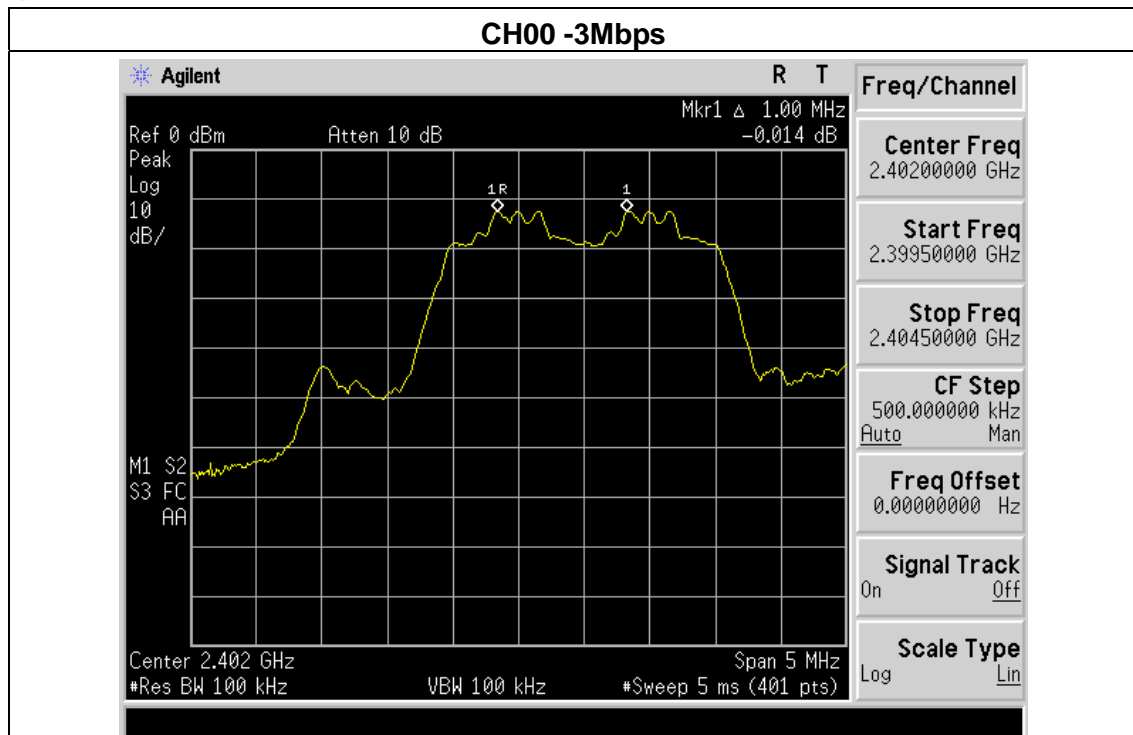

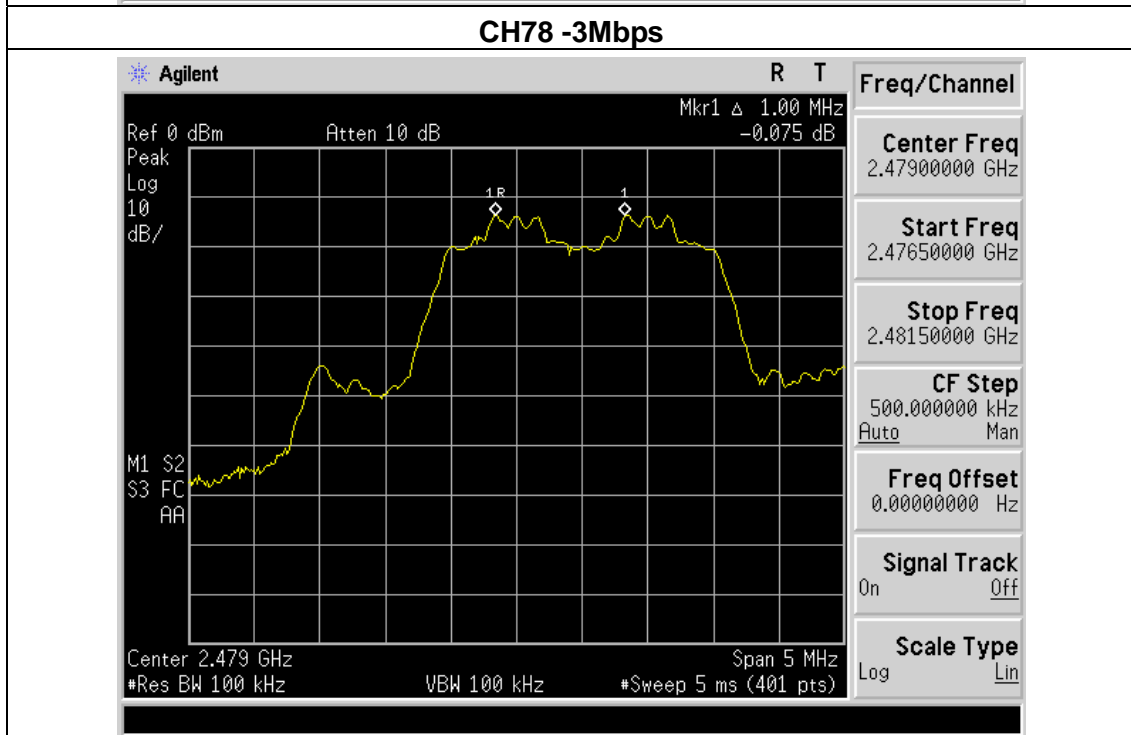
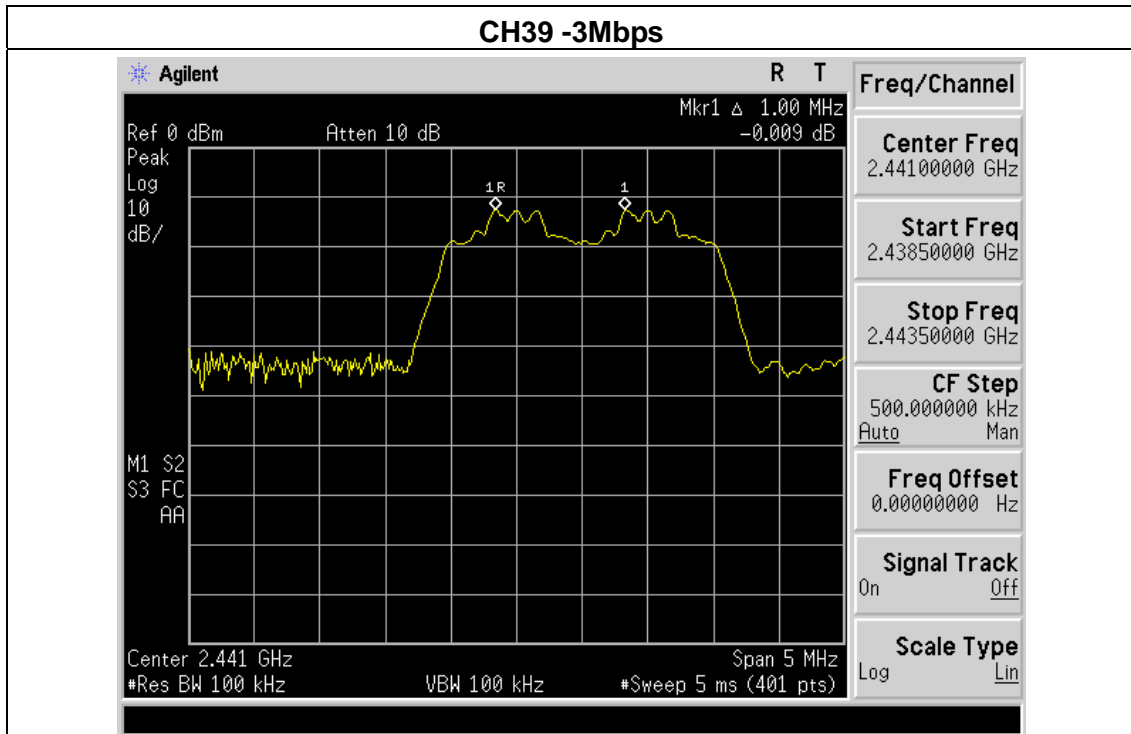

7. BANDWIDTHE TEST

7.1 APPLIED PROCEDURES / LIMIT

FCC Part15 (15.247) , Subpart C				
Section	Test Item	Limit	Frequency Range (MHz)	Result
15.247 (a)(1)	Bandwidth	(20dB bandwidth)	2400-2483.5	PASS

Spectrum Parameter	Setting
Attenuation	Auto
Span Frequency	> Measurement Bandwidth or Channel Separation
RB	30 kHz
VB	100 kHz
Detector	Peak
Trace	Max Hold
Sweep Time	Auto

7.1.1 TEST PROCEDURE

- a. The EUT was directly connected to the spectrum analyzer and antenna output port as show in the block diagram below,
- b. Spectrum Setting : RBW= 30KHz, VBW=100KHz, Sweep time = Auto.

7.1.2 DEVIATION FROM STANDARD

No deviation.

7.1.3 TEST SETUP

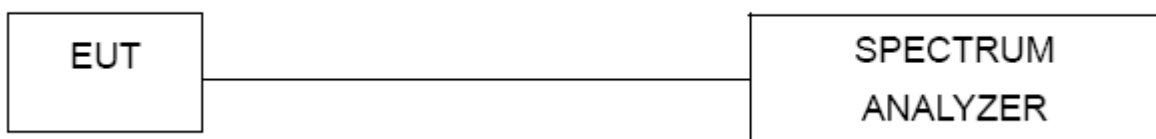

7.1.4 EUT OPERATION CONDITIONS

The EUT tested system was configured as the statements of 2.4 Unless otherwise a special operating condition is specified in the follows during the testing.

7.1.5 TEST RESULTS

EUT :	Bluetooth Speaker	Model Name :	M73
Temperature :	25 °C	Relative Humidity :	60%
Pressure :	1012 hPa	Test Voltage :	DC 3.7V
Test Mode :	CH00 / CH39 /C78(1Mbps)		

Frequency	20dB Bandwidth (KHz)	Result
2402 MHz	625.515	PASS
2441 MHz	647.702	PASS
2480 MHz	673.420	PASS

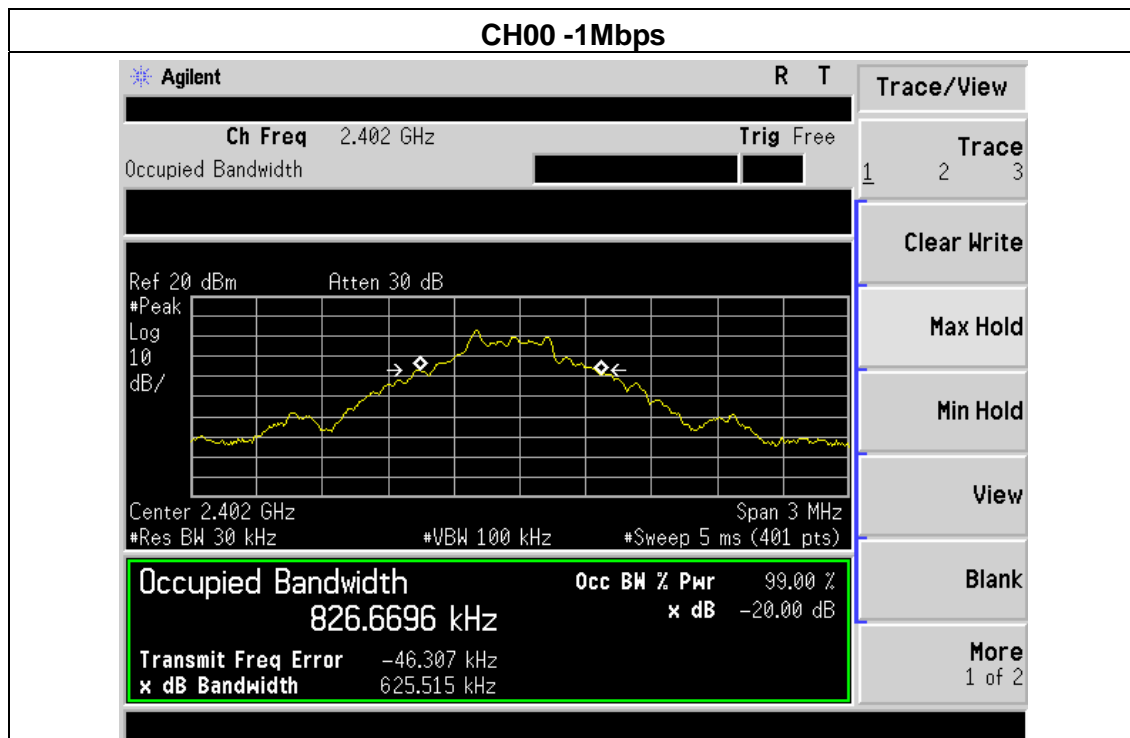

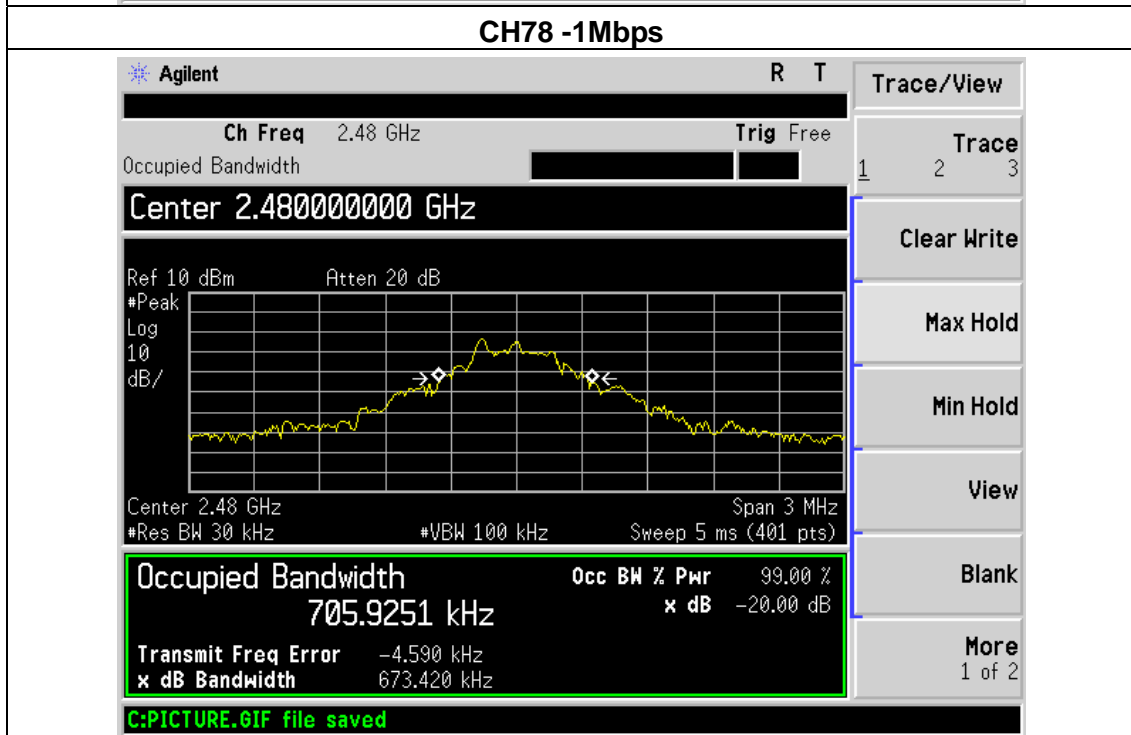
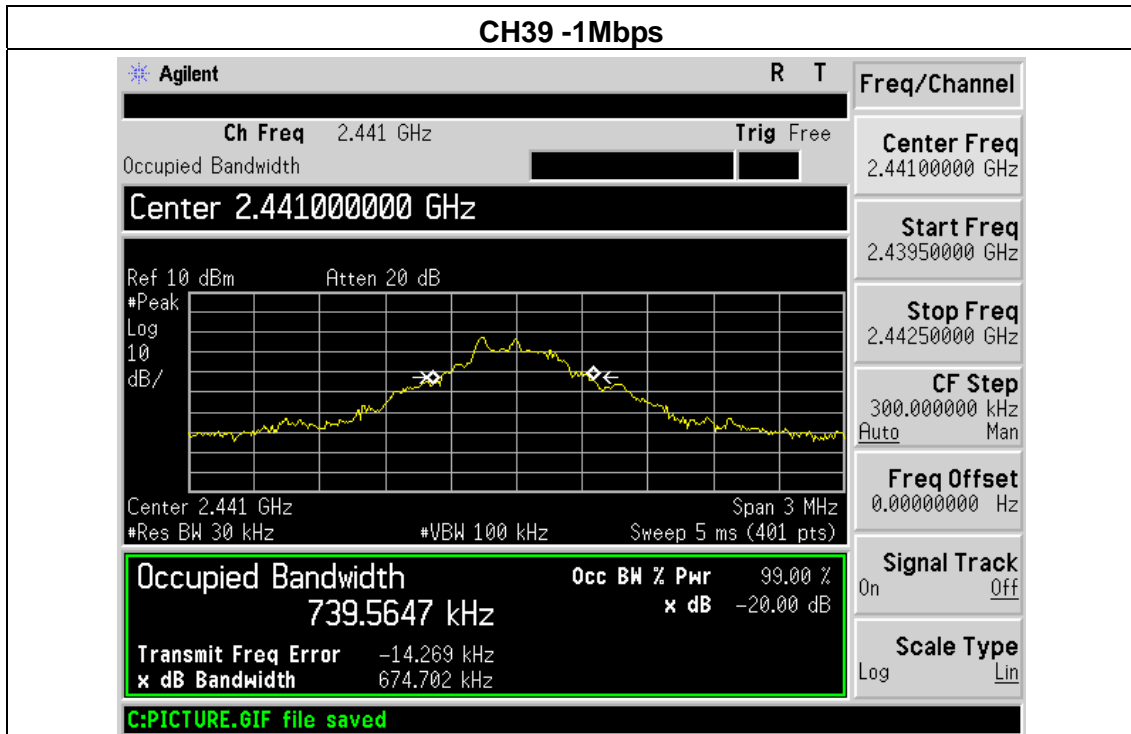

EUT :	Bluetooth Speaker	Model Name :	M73
Temperature :	25 °C	Relative Humidity :	60%
Pressure :	1012 hPa	Test Voltage :	DC 3.7V
Test Mode :	CH00 / CH39 /C78(2Mbps)		

Frequency	20dB Bandwidth (MHz)	Result
2402 MHz	1.235	PASS
2441 MHz	1.239	PASS
2480 MHz	1.217	PASS

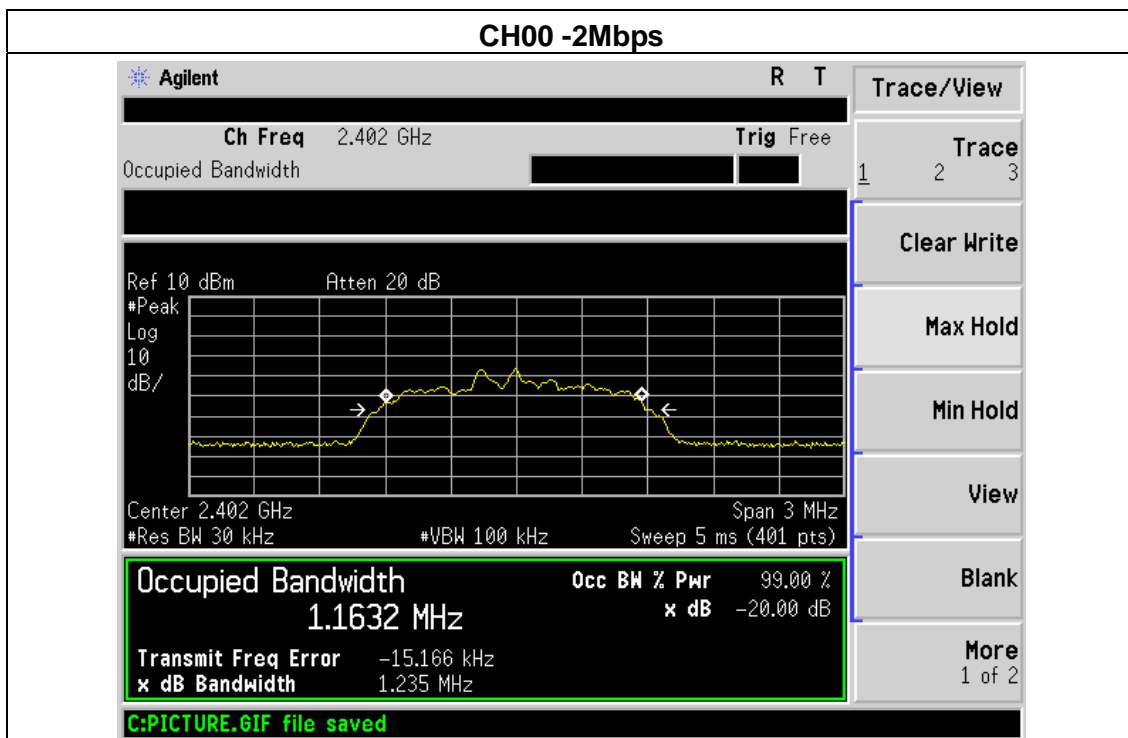

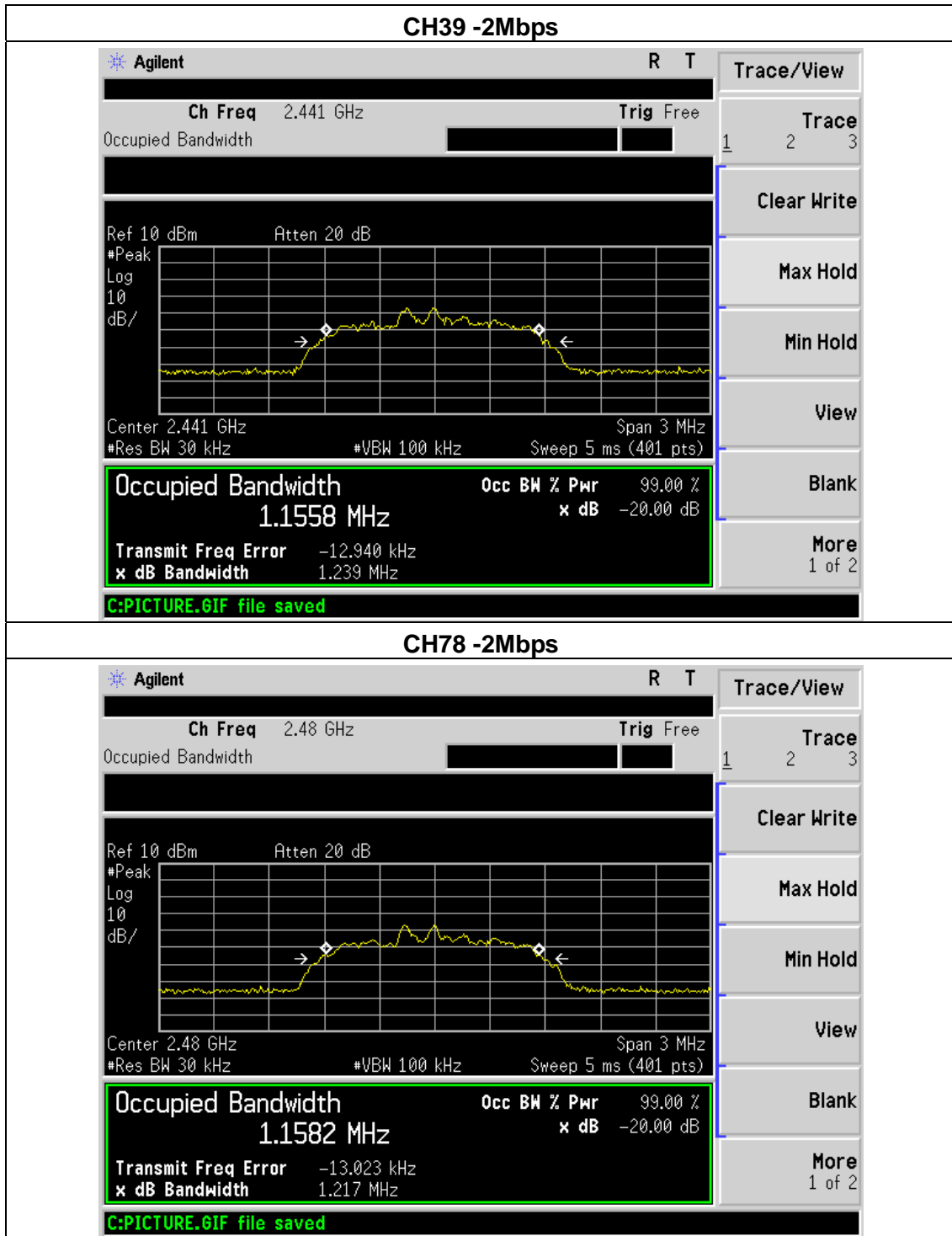

EUT :	Bluetooth Speaker	Model Name :	M73
Temperature :	25 °C	Relative Humidity :	60%
Pressure :	1012 hPa	Test Voltage :	DC 3.7V
Test Mode :	CH00 / CH39 /C78(3Mbps)		

Frequency	20dB Bandwidth (MHz)	Result
2402 MHz	1.219	PASS
2441 MHz	1.213	PASS
2480 MHz	1.204	PASS

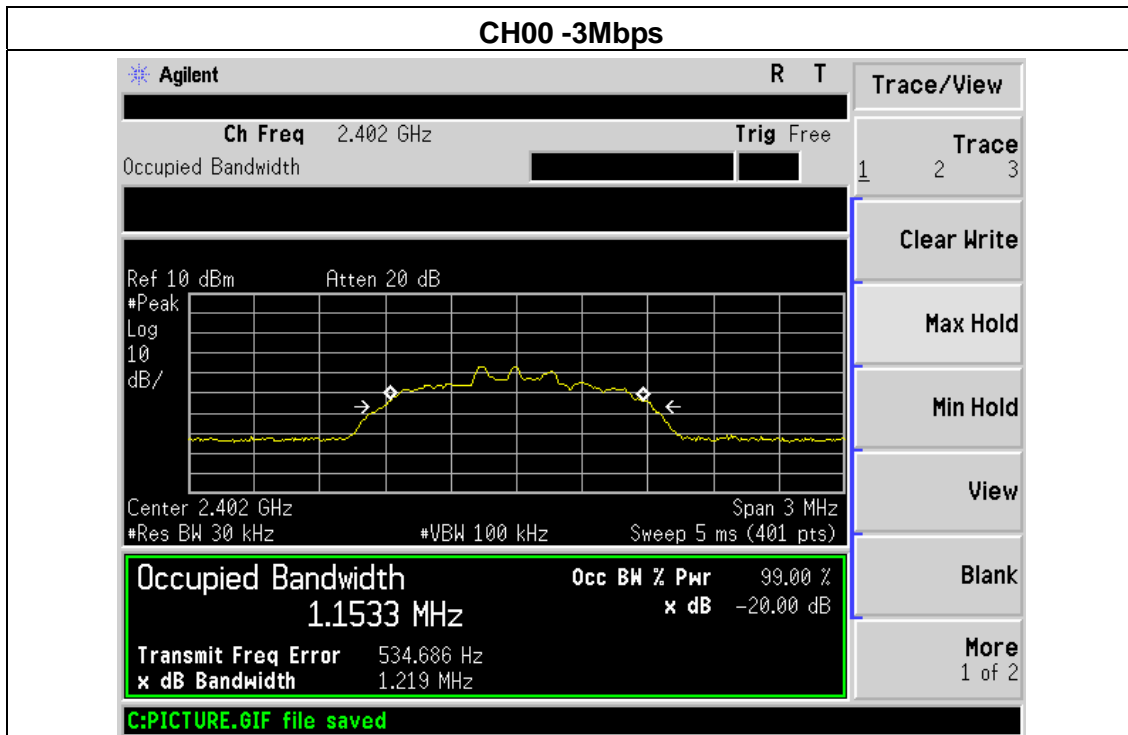

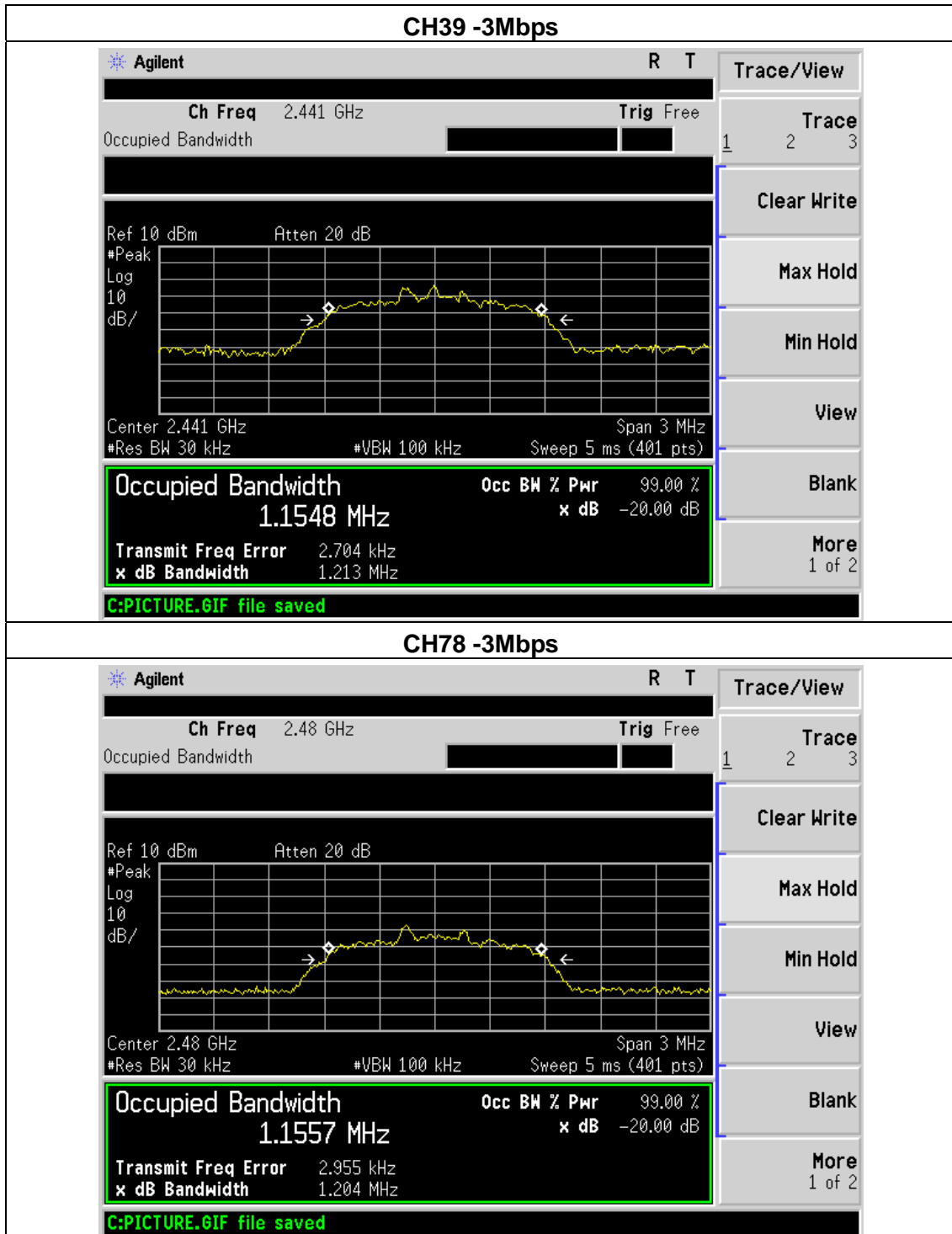

8. PEAK OUTPUT POWER TEST

8.1 APPLIED PROCEDURES / LIMIT

FCC Part15 (15.247) , Subpart C				
Section	Test Item	Limit	Frequency Range (MHz)	Result
15.247 (b)(i)	Peak Output Power	0.125 w or 20.96dBm	2400-2483.5	PASS

8.1.1 TEST PROCEDURE

- a. The EUT was directly connected to the spectrum analyzer and antenna output port as show in the block diagram below,
- b. Spectrum Setting : RBW > the 20 dB bandwidth of the emission being measured
 - Span = approximately 5 times the 20 dB bandwidth, centered on a hopping channel
 - VBW ≥ RBW
 - Sweep = auto
 - Detector function = peak
 - Trace = max hold

8.1.2 DEVIATION FROM STANDARD

No deviation.

8.1.3 TEST SETUP

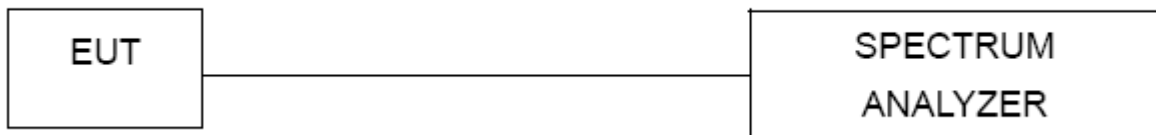

8.1.4 EUT OPERATION CONDITIONS

The EUT tested system was configured as the statements of 2.4 Unless otherwise a special operating condition is specified in the follows during the testing.

8.1.5 TEST RESULTS

EUT :	Bluetooth Speaker	Model Name :	M73
Temperature :	25 °C	Relative Humidity :	60%
Pressure :	1012 hPa	Test Voltage :	DC 3.7V
Test Mode :	CH00/ CH39 /CH78 (1M/2M/3Mbps Mode)		

1Mbps			
Test Channel	Frequency (MHz)	Peak Output Power (dBm)	LIMIT (dBm)
CH00	2402	3.259	30
CH39	2441	3.155	30
CH78	2480	3.119	30
2Mbps			
CH00	2402	2.913	20.96
CH39	2441	2.679	20.96
CH78	2480	2.190	20.96
3Mbps			
CH00	2402	2.031	20.96
CH39	2441	2.095	20.96
CH78	2480	2.190	20.96

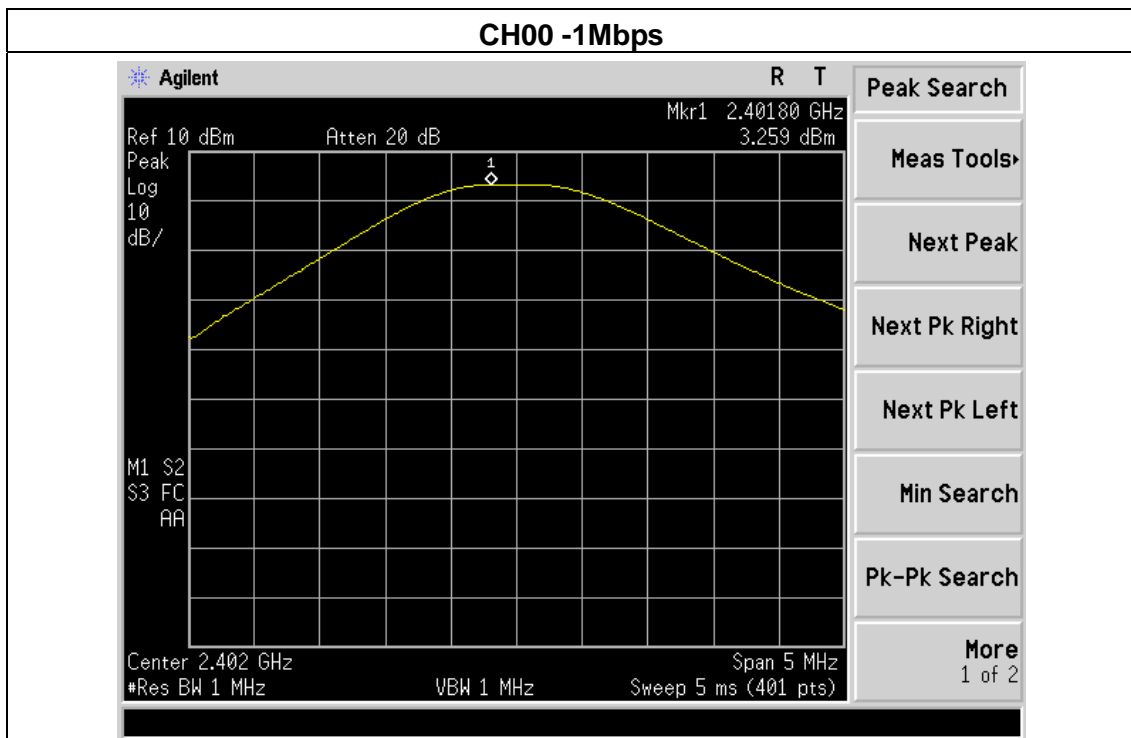

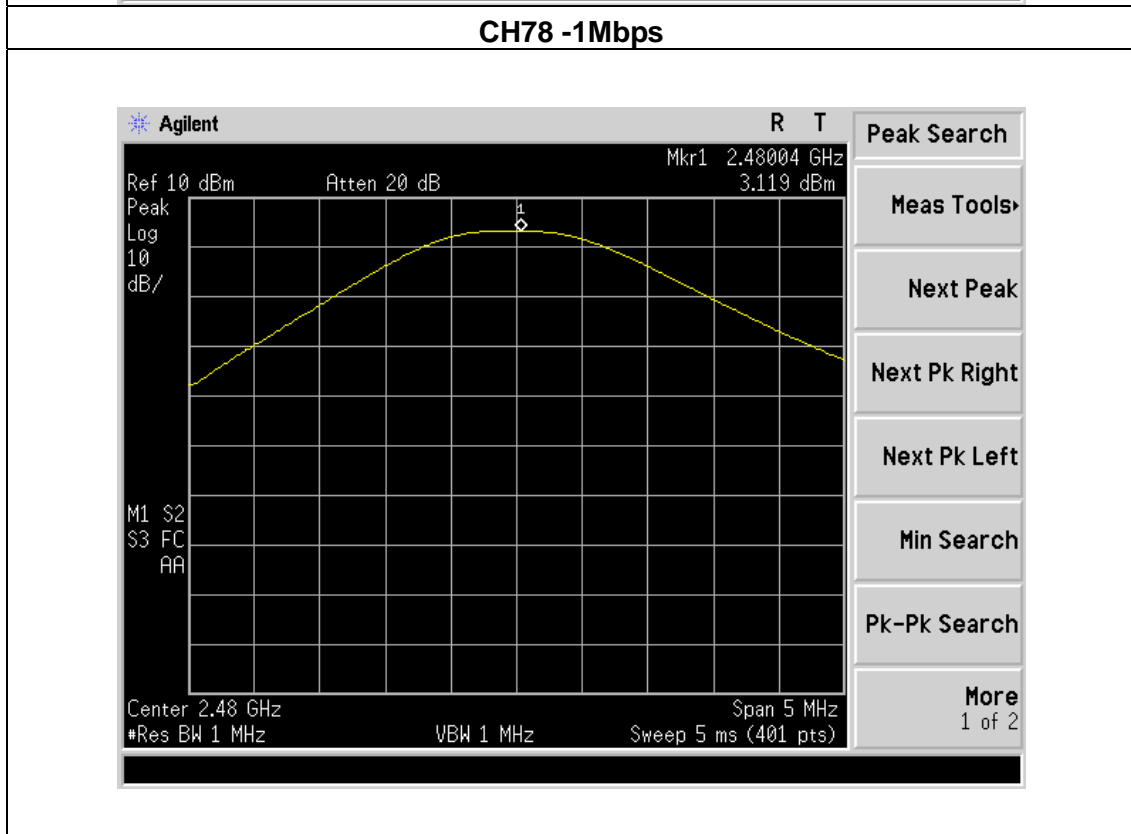
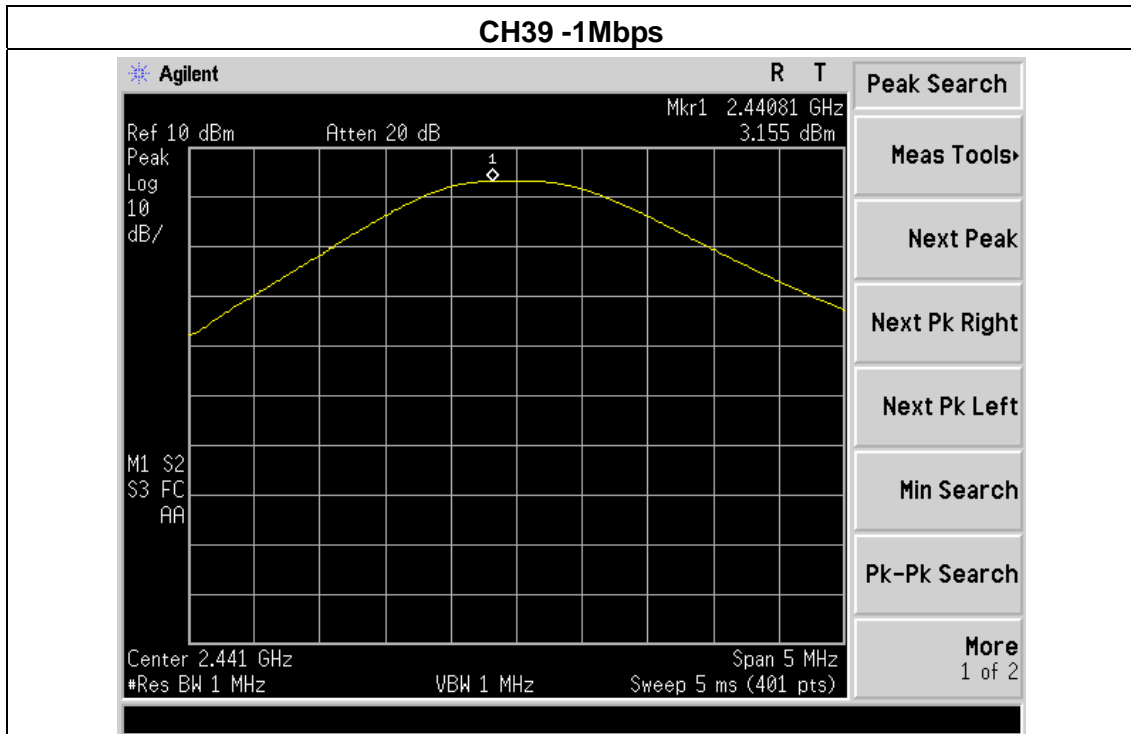

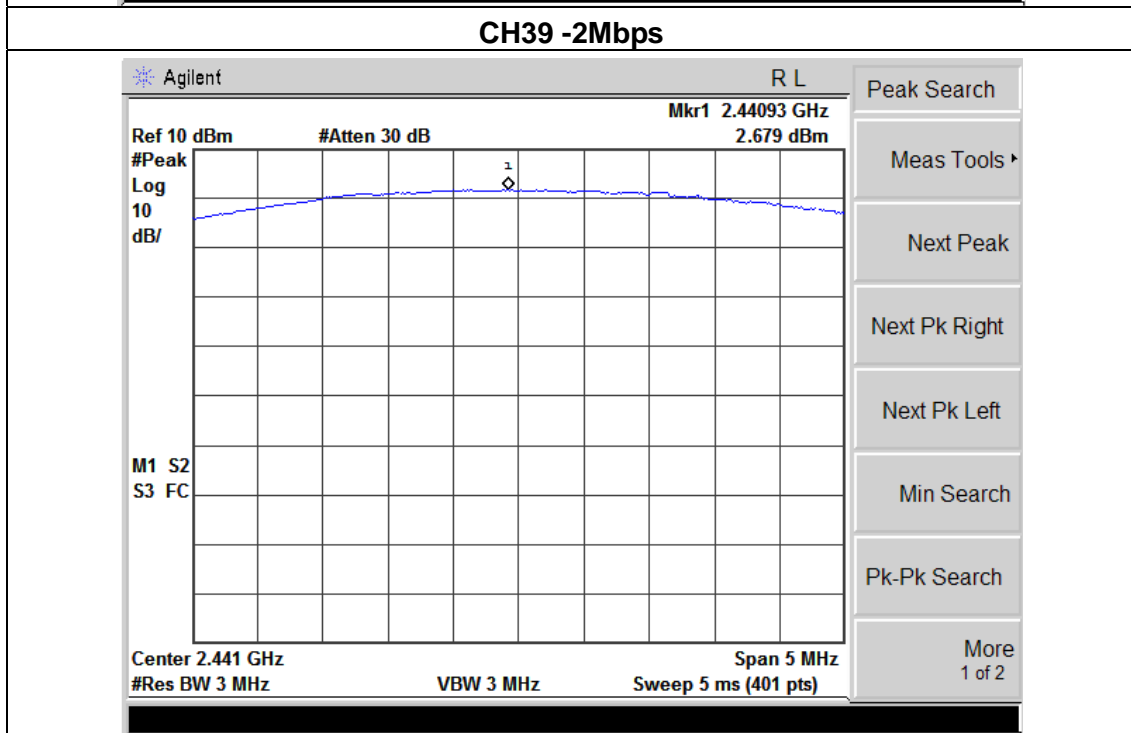
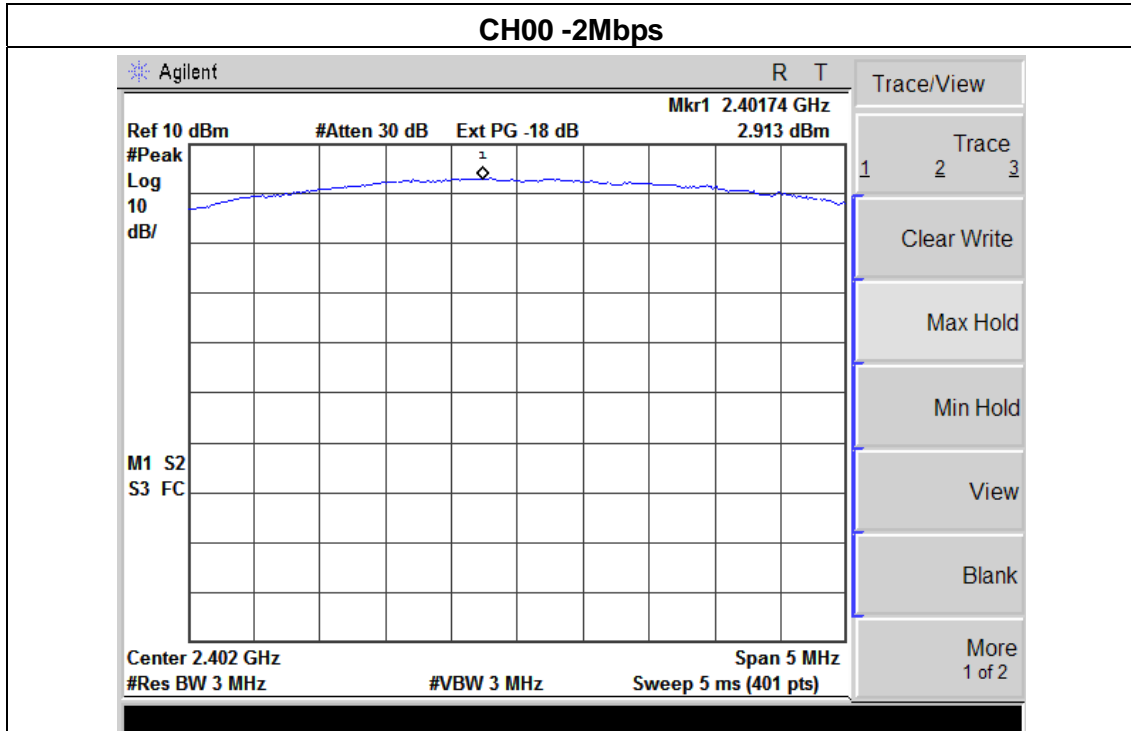

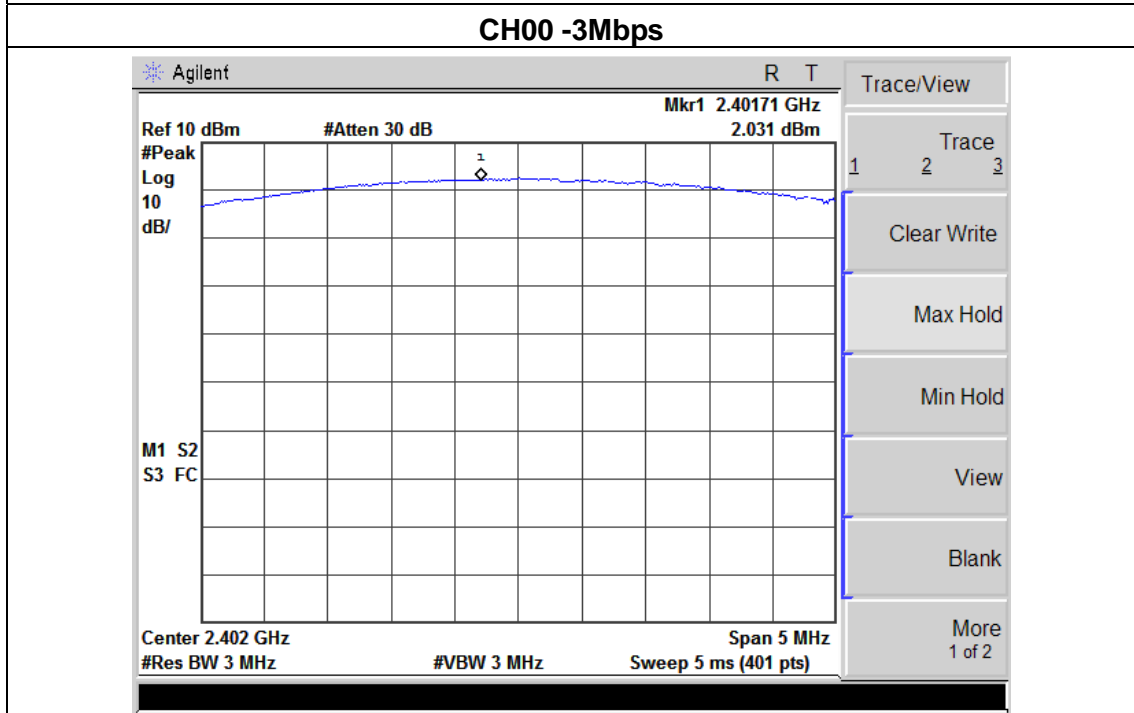
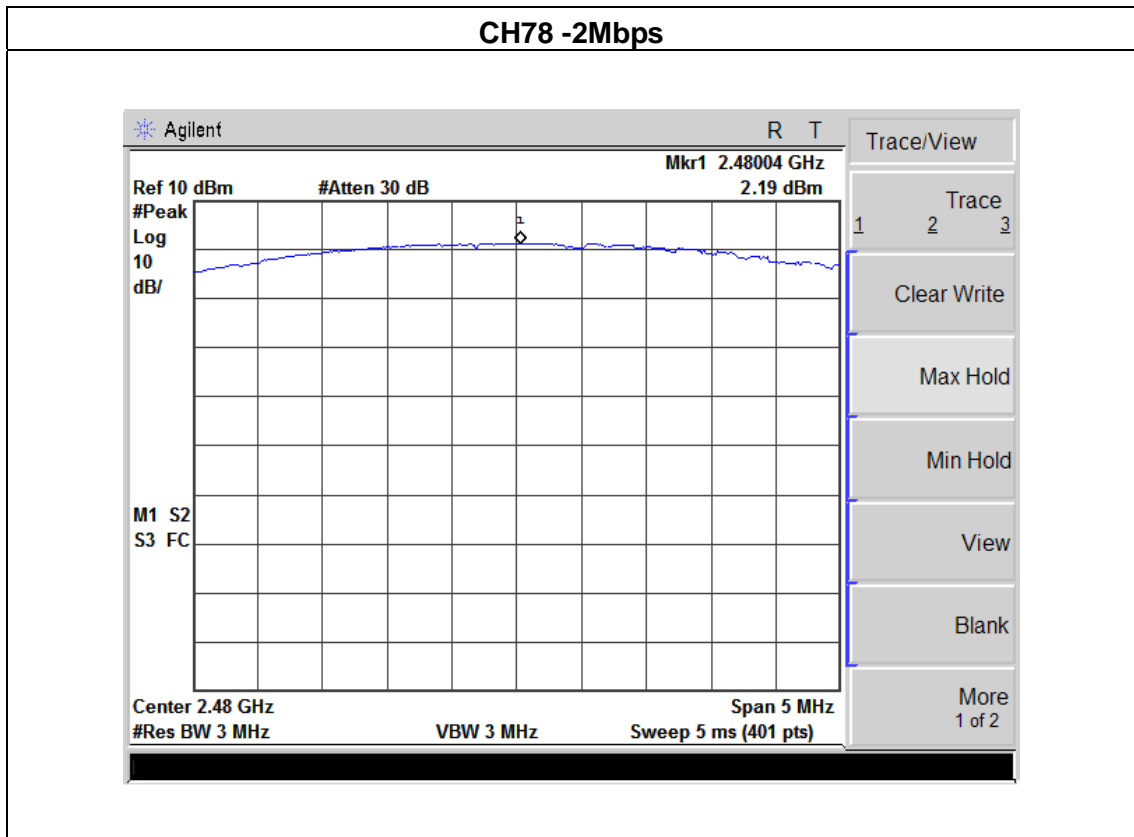

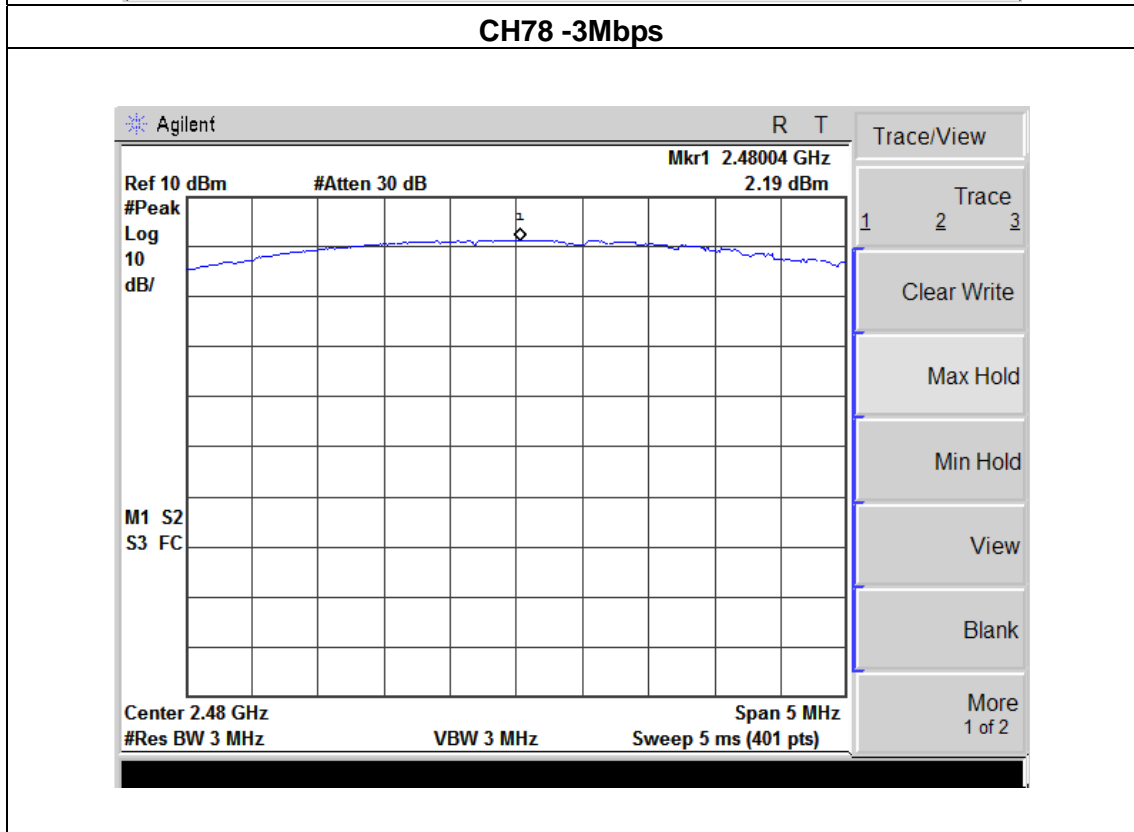
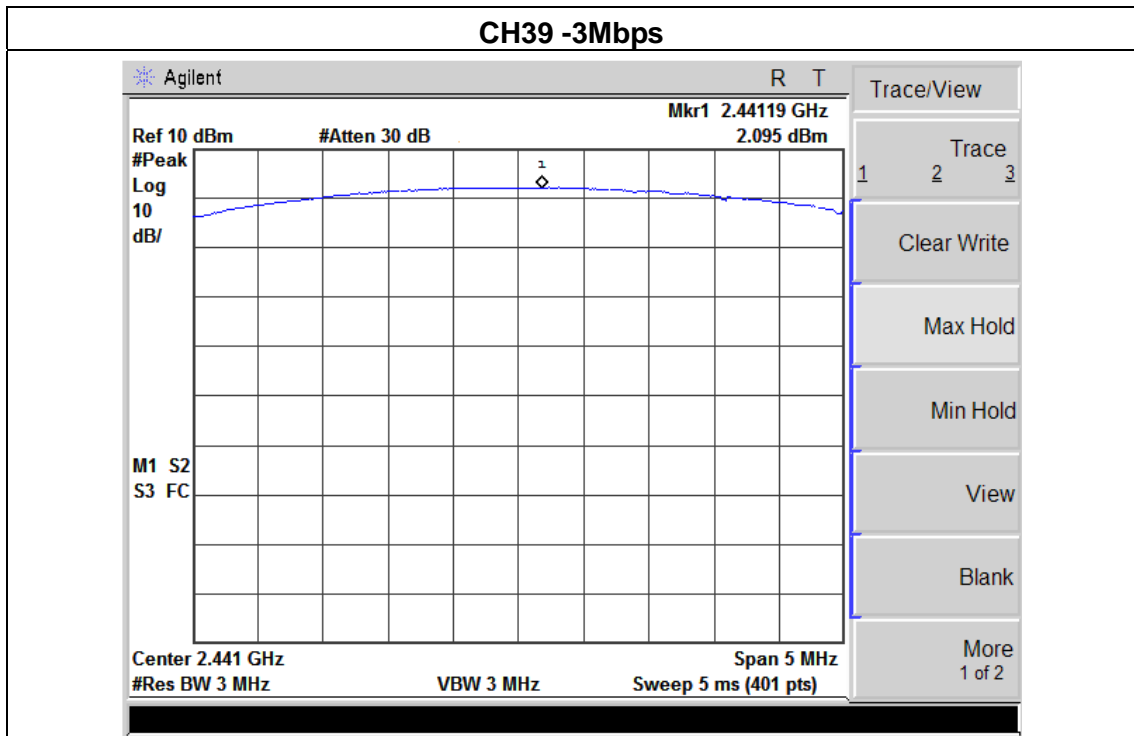

9. ANTENNA REQUIREMENT

9.1 STANDARD REQUIREMENT

15.203 requirement: For intentional device, according to 15.203: an intentional radiator shall be designed to ensure that no antenna other than that furnished by the responsible party shall be used with the device.

9.2 EUT ANTENNA

The EUT antenna is PCB Printed antenna. It comply with the standard requirement.

10. EUT TEST PHOTO

Radiated Measurement Photos

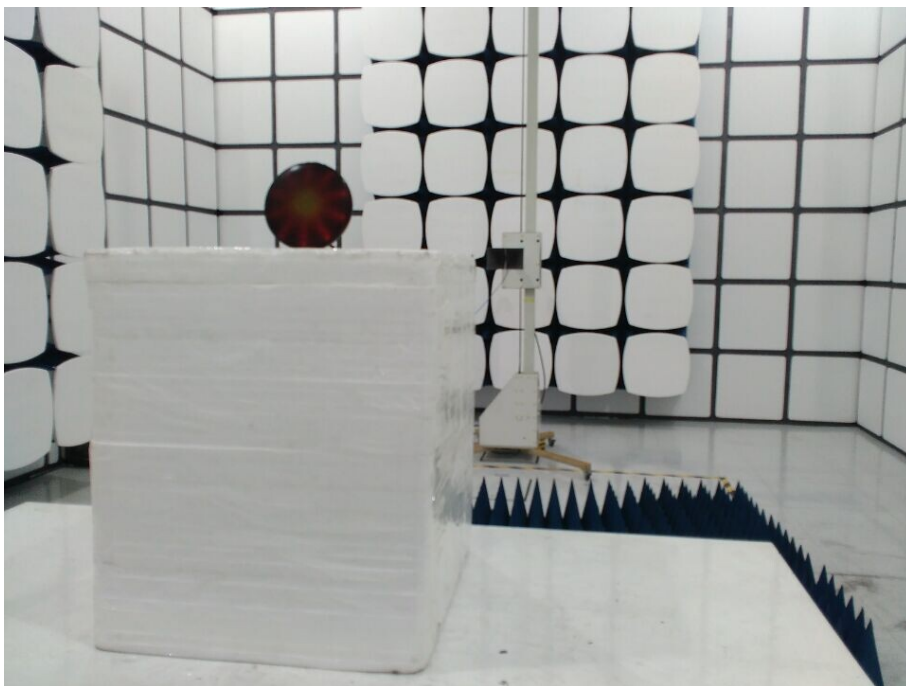
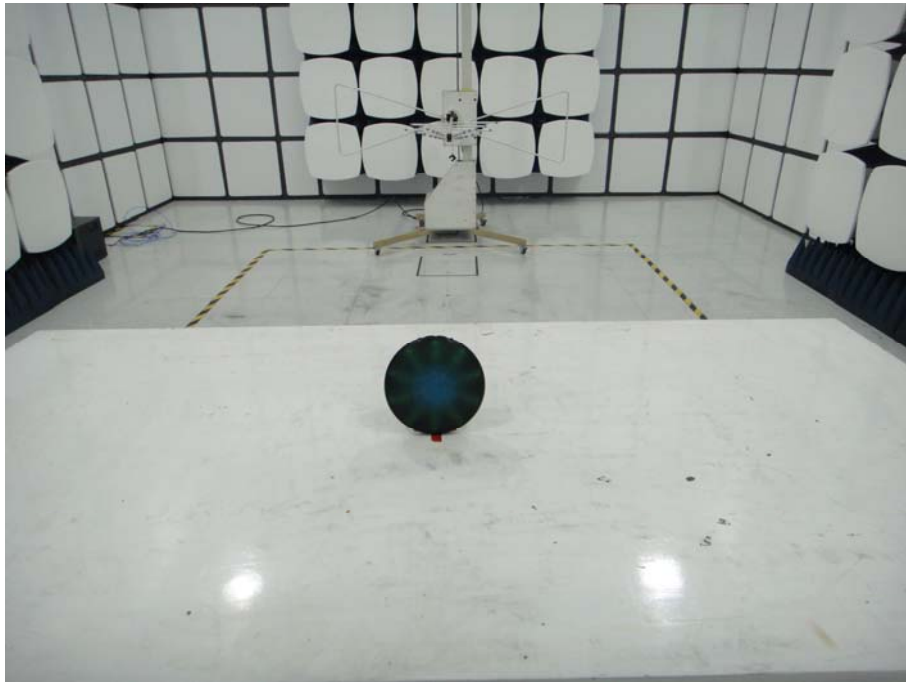

Conducted Measurement Photos

