

FCC RADIO TEST REPORT

Prepared For	Shenzhen Jonter Digital Co., Ltd.
Product Name:	Bluetooth Speaker
Trade Name:	Jonter ,Photive
Model Name :	M59, PH-BTM50
FCC ID:	2AB9SM59
Prepared By	DongGuan Precise Testing Service Co.,Ltd.
	F616A Room, 6th Floor, Meixin Business Center, Dongcheng Middle Road, Dongguan, Guangdong, China
Report No.	PTS201411125F
Test Date:	Nov. 20 ~ Nov. 30, 2014
Date of Report :	Nov.30, 2014

VERIFICATION OF COMPLIANCE

Applicant:	Shenzhen Jonter Digital Co., Ltd
Address	Flr 3, Building4, Jinfo Industrial Park, Hezhou Village, Xixiang Town, Baoan District, Shenzhen, China
Manufacturer Name:	Shenzhen Jonter Digital Co., Ltd
Address:	Flr 3, Building4, Jinfo Industrial Park, Hezhou Village, Xixiang Town, Baoan District, Shenzhen, China
Product Description:	Bluetooth Speaker
Brand Name:	Jonter ,Photive
Model Name:	M59, PH-BTM50
Model difference:	All the same,Only model name is different
Test procedure	ANSI C63.4:2003, DA 00-705
Standards	FCC Part15.247:2012

Prepared by :

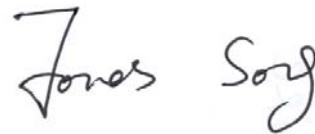

Assistant

Reviewer :



Supervisor

Approved & Authorized Signer :



Jacky Ou / Manager

Table of Contents

	Page
1 . SUMMARY OF TEST RESULTS	5
1.1 TEST FACILITY	6
1.2 MEASUREMENT UNCERTAINTY	6
2 . GENERAL INFORMATION	7
2.1 GENERAL DESCRIPTION OF EUT	7
2.2 DESCRIPTION OF TEST MODES	9
2.3 TABLE OF PARAMETERS OF TEXT SOFTWARE SETTING	9
2.4 BLOCK DIGRAM SHOWING THE CONFIGURATION OF SYSTEM TESTED	10
2.5 DESCRIPTION OF SUPPORT UNITS(CONDUCTED MODE)	11
2.6 EQUIPMENTS LIST FOR ALL TEST ITEMS	12
3 . EMC EMISSION TEST	13
3.1 CONDUCTED EMISSION MEASUREMENT	13
3.1.1 POWER LINE CONDUCTED EMISSION LIMITS	13
3.1.2 TEST PROCEDURE	14
3.1.3 DEVIATION FROM TEST STANDARD	14
3.1.4 TEST SETUP	14
3.1.5 EUT OPERATING CONDITIONS	14
3.1.6 TEST RESULTS	15
3.2 RADIATED EMISSION MEASUREMENT	17
3.2.1 RADIATED EMISSION LIMITS	17
3.2.2 TEST PROCEDURE	18
3.2.3 DEVIATION FROM TEST STANDARD	18
3.2.4 TEST SETUP	19
3.2.5 EUT OPERATING CONDITIONS	20
3.2.6 TEST RESULTS (BELOW 30 MHZ)	21
3.2.7 TEST RESULTS (BETWEEN 30M – 1000 MHZ)	22
3.2.8 TEST RESULTS (ABOVE 1000 MHZ)	24
3.2.9 TEST RESULTS (RESTRICTED BANDS REQUIREMENTS)	42
4 . NUMBER OF HOPPING CHANNEL	54
4.1 APPLIED PROCEDURES / LIMIT	54
4.1.1 TEST PROCEDURE	54
4.1.2 DEVIATION FROM STANDARD	54
4.1.3 TEST SETUP	54
4.1.4 EUT OPERATION CONDITIONS	54

Table of Contents

	Page
4.1.5 TEST RESULTS	55
5 . AVERAGE TIME OF OCCUPANCY	56
5.1 APPLIED PROCEDURES / LIMIT	56
5.1.1 TEST PROCEDURE	56
5.1.2 DEVIATION FROM STANDARD	56
5.1.3 TEST SETUP	57
5.1.4 EUT OPERATION CONDITIONS	57
5.1.5 TEST RESULTS	58
6 . HOPPING CHANNEL SEPARATION MEASUREMENT	64
6.1 APPLIED PROCEDURES / LIMIT	64
6.1.1 TEST PROCEDURE	64
6.1.2 DEVIATION FROM STANDARD	64
6.1.3 TEST SETUP	64
6.1.4 EUT OPERATION CONDITIONS	64
6.1.5 TEST RESULTS	65
7 . BANDWIDTH TEST	71
7.1 APPLIED PROCEDURES / LIMIT	71
7.1.1 TEST PROCEDURE	71
7.1.2 DEVIATION FROM STANDARD	71
7.1.3 TEST SETUP	71
7.1.4 EUT OPERATION CONDITIONS	71
7.1.5 TEST RESULTS	72
8 . PEAK OUTPUT POWER TEST	78
8.1 APPLIED PROCEDURES / LIMIT	78
8.1.1 TEST PROCEDURE	78
8.1.2 DEVIATION FROM STANDARD	78
8.1.3 TEST SETUP	78
8.1.4 EUT OPERATION CONDITIONS	78
8.1.5 TEST RESULTS	79
9 . ANTENNA REQUIREMENT	85
9.1 STANDARD REQUIREMENT	85
9.2 EUT ANTENNA	85
10 . EUT TEST PHOTO	86
APPENDIX-PHOTOGRAPHS OF EUT CONSTRUCTIONAL DETAILS	

1. SUMMARY OF TEST RESULTS

Test procedures according to the technical standards:

FCC Part15 (15.247) , Subpart C			
Standard Section	Test Item	Judgment	Remark
15.207	Conducted Emission	PASS	
15.247(a)(1)	Hopping Channel Separation	PASS	
15.247(b)(1)	Peak Output Power	PASS	
15.247(c)	Radiated Spurious Emission	PASS	
15.247(a)(iii)	Number of Hopping Frequency	PASS	
15.247(a)(iii)	Dwell Time	PASS	
15.247(a)(1)	Bandwidth	PASS	
15.205	Band Edge Emission	PASS	
15.203	Antenna Requirement	PASS	

1.1 TEST FACILITY

NTEK Testing Technology Co., Ltd

Add. : 1/F, Building E, Fenda Science Park, Sanwei Community, Xixiang Street, Bao'an District, Shenzhen P.R. China.

FCC Registration No.:238937; IC Registration No.:9270A-1

1.2 MEASUREMENT UNCERTAINTY

The reported uncertainty of measurement $y \pm U$, where expanded uncertainty U is based on a standard uncertainty multiplied by a coverage factor of $k=2$, providing a level of confidence of approximately **95 %**.

No.	Item	Uncertainty
1	Conducted Emission Test	$\pm 1.38\text{dB}$
2	RF power,conducted	$\pm 0.16\text{dB}$
3	Spurious emissions,conducted	$\pm 0.21\text{dB}$
4	All emissions,radiated(<1G)	$\pm 4.68\text{dB}$
5	All emissions,radiated(>1G)	$\pm 4.89\text{dB}$
6	Temperature	$\pm 0.5^{\circ}\text{C}$
7	Humidity	$\pm 2\%$

2. GENERAL INFORMATION

2.1 GENERAL DESCRIPTION OF EUT

Equipment	Bluetooth Speaker	
Trade Name	Jonter ,Photive	
Model and/or type reference	M59	
Serial Model	PH-BTM50	
Model Difference	All the same,Only model name is different	
Product Description	The EUT is a Bluetooth Speaker	
	Operation Frequency:	2402~2480 MHz
	Bluetooth version	V3.0
	Modulation Type:	BT(1Mbps): GFSK BT EDR(2Mbps): $\pi/4$ -DQPSK BT EDR(3Mbps): 8-DPSK
	Bit Rate of Transmitter	1Mbps/2Mbps/3Mbps
	Number Of Channel	79 CH
	Antenna Designation:	Please see Note 3.
	Output Power(Conducted):	BT(1Mbps): 3.628dBm BT EDR(2Mbps): 3.090dBm BT EDR(3Mbps): 3.191dBm
	Based on the application, features, or specification exhibited in User's Manual, the EUT is considered as an ITE/Computing Device. More details of EUT technical specification, please refer to the User's Manual.	
Channel List	Please refer to the Note 2.	
Adapter	N/A	
Battery	3.7V	
Connecting I/O Port(s)	Please refer to the User's Manual	

Note:

1. For a more detailed features description, please refer to the manufacturer's specifications or the User's Manual.

2.

Channel List					
Channel	Frequency (MHz)	Channel	Frequency (MHz)	Channel	Frequency (MHz)
00	2402	27	2429	54	2456
01	2403	28	2430	55	2457
02	2404	29	2431	56	2458
03	2405	30	2432	57	2459
04	2406	31	2433	58	2460
05	2407	32	2434	59	2461
06	2408	33	2435	60	2462
07	2409	34	2436	61	2463
08	2410	35	2437	62	2464
09	2411	36	2438	63	2465
10	2412	37	2439	64	2466
11	2413	38	2440	65	2467
12	2414	39	2441	66	2468
13	2415	40	2442	67	2469
14	2416	41	2443	68	2470
15	2417	42	2444	69	2471
16	2418	43	2445	70	2472
17	2419	44	2446	71	2473
18	2420	45	2447	72	2474
19	2421	46	2448	73	2475
20	2422	47	2449	74	2476
21	2423	48	2450	75	2477
22	2424	49	2451	76	2478
23	2425	50	2452	77	2479
24	2426	51	2453	78	2480
25	2427	52	2454		
26	2428	53	2455		

3.

Table for Filed Antenna

Ant	Brand	Model Name	Antenna Type	Connector	Gain (dBi)	NOTE
1	N/A	N/A	PCB Antenna	NA	1.21	BT Antenna

2.2 DESCRIPTION OF TEST MODES

To investigate the maximum EMI emission characteristics generates from EUT, the test system was pre-scanning tested base on the consideration of following EUT operation mode or test configuration mode which possible have effect on EMI emission level. Each of these EUT operation mode(s) or test configuration mode(s) mentioned above was evaluated respectively.

Pretest Mode	Description
Mode 1	CH00
Mode 2	CH39
Mode 3	CH78
Mode 4	BT Link

For Conducted Emission	
Final Test Mode	Description
Mode 4	BT Link

For Radiated Emission	
Final Test Mode	Description
Mode 1	CH00
Mode 2	CH39
Mode 3	CH78

Note:

- (1) The measurements are performed at the highest, middle, lowest available channels.
- (2) The EUT use new battery.
- (3)The data rate was set in 1Mbps for radiated emission due to the highest RF output power.

2.3 TABLE OF PARAMETERS OF TEXT SOFTWARE SETTING

During testing channel & power controlling software provided by the customer was used to control the operating channel as well as the output power level. The RF output power selection is for the setting of RF output power expected by the customer and is going to be fixed on the firmware of the final end product power parameters of FHSS

Test software Version	Test program: BCM20730		
Frequency	2402 MHz	2441 MHz	2480 MHz
Parameters(1/2/3Mbps)	DEF	DEF	DEF

2.4 BLOCK DIGRAM SHOWING THE CONFIGURATION OF SYSTEM TESTED

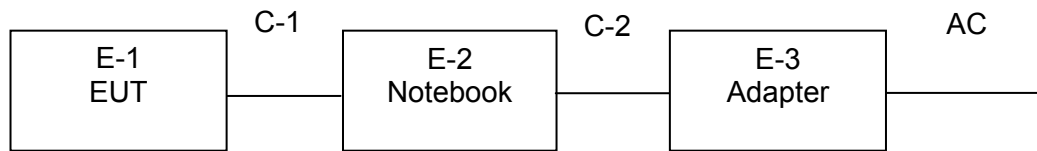

2.5 DESCRIPTION OF SUPPORT UNITS(CONDUCTED MODE)

The EUT has been tested as an independent unit together with other necessary accessories or support units. The following support units or accessories were used to form a representative test configuration during the tests.

Item	Equipment	Mfr/Brand	Model/Type No.	Series No.	Note
E-1	Bluetooth Speaker	Jonter ,Photive	M59	N/A	EUT
E-2	Notebook	IBM	08K8202	N/A	
E-3	Adapter	IBM	2366	N/A	

Item	Shielded Type	Ferrite Core	Length	Note
C1	No	No	0.8m	USB cable
C2	No	No	1.5m	DC cable

Note:

- (1) The support equipment was authorized by Declaration of Confirmation.
- (2) For detachable type I/O cable should be specified the length in cm in 『Length』 column.
- (3) “YES” is means “shielded” “with core”; “NO” is means “unshielded” “without core”.

2.6 EQUIPMENTS LIST FOR ALL TEST ITEMS

Radiation Test equipment

Item	Kind of Equipment	Manufacturer	Type No.	Serial No.	Last calibration	Calibrated until	Calibration period
1	Spectrum Analyzer	Agilent	E4407B	MY45108040	2014.07.06	2015.07.05	1 year
2	Test Receiver	R&S	ESPI	101318	2014.06.07	2015.06.06	1 year
3	Bilog Antenna	TESEQ	CBL6111D	31216	2014.07.06	2015.07.05	1 year
4	50Ω Coaxial Switch	Anritsu	MP59B	6200264416	2014.06.07	2015.06.06	1 year
5	Spectrum Analyzer	ADVANTEST	R3132	150900201	2014.06.07	2015.06.06	1 year
6	Horn Antenna	EM	EM-AH-10180	2011071402	2014.07.06	2015.07.05	1 year
7	Horn Ant	Schwarzbeck	BBHA 9170	9170-181	2014.07.06	2015.07.05	1 year
8	Amplifier	EM	EM-30180	060538	2014.12.22	2015.12.21	1 year
9	Loop Antenna	ARA	PLA-1030/B	1029	2014.06.08	2015.06.07	1 year
10	Power Meter	R&S	NRVS	100696	2014.07.06	2015.07.05	1 year
11	Power Sensor	R&S	URV5-Z4	0395.1619.05	2014.07.06	2015.07.05	1 year
12	RF cables	R&S	N/A	N/A	2014.07.06	2015.07.05	1 year

Conduction Test equipment

Item	Kind of Equipment	Manufacturer	Type No.	Serial No.	Last calibration	Calibrated until	Calibration period
1	Test Receiver	R&S	ESCI	101160	2014.06.06	2015.06.05	1 year
2	LISN	R&S	ENV216	101313	2014.08.24	2015.08.23	1 year
3	LISN	EMCO	3816/2	00042990	2014.08.24	2015.08.23	1 year
4	50Ω Coaxial Switch	Anritsu	MP59B	6200264417	2014.06.07	2015.06.06	1 year
5	Passive Voltage Probe	R&S	ESH2-Z3	100196	2014.06.07	2015.06.06	1 year
6	Absorbing clamp	R&S	MOS-21	100423	2014.06.08	2015.06.07	1 year

3. EMC EMISSION TEST

3.1 CONDUCTED EMISSION MEASUREMENT

3.1.1 POWER LINE CONDUCTED EMISSION Limits (Frequency Range 150KHz-30MHz)

FREQUENCY (MHz)	Class A (dBuV)		Class B (dBuV)		Standard
	Quasi-peak	Average	Quasi-peak	Average	
0.15 -0.5	79.00	66.00	66 - 56 *	56 - 46 *	CISPR
0.50 -5.0	73.00	60.00	56.00	46.00	CISPR
5.0 -30.0	73.00	60.00	60.00	50.00	CISPR

0.15 -0.5	79.00	66.00	66 - 56 *	56 - 46 *	FCC
0.50 -5.0	73.00	60.00	56.00	46.00	FCC
5.0 -30.0	73.00	60.00	60.00	50.00	FCC

Note:

- (1) The tighter limit applies at the band edges.
- (2) The limit of " * " marked band means the limitation decreases linearly with the logarithm of the frequency in the range.

The following table is the setting of the receiver

Receiver Parameters	Setting
Attenuation	10 dB
Start Frequency	0.15 MHz
Stop Frequency	30 MHz
IF Bandwidth	9 kHz

3.1.2 TEST PROCEDURE

- a. The EUT was placed 0.4 meters from the horizontal ground plane with EUT being connected to the power mains through a line impedance stabilization network (LISN). All other support equipments powered from additional LISN(s). The LISN provide 50 Ohm/ 50uH of coupling impedance for the measuring instrument.
- b. Interconnecting cables that hang closer than 40 cm to the ground plane shall be folded back and forth in the center forming a bundle 30 to 40 cm long.
- c. I/O cables that are not connected to a peripheral shall be bundled in the center. The end of the cable may be terminated, if required, using the correct terminating impedance. The overall length shall not exceed 1 m.
- d. LISN at least 80 cm from nearest part of EUT chassis.
- e. For the actual test configuration, please refer to the related Item –EUT Test Photos.

3.1.3 DEVIATION FROM TEST STANDARD

No deviation

3.1.4 TEST SETUP

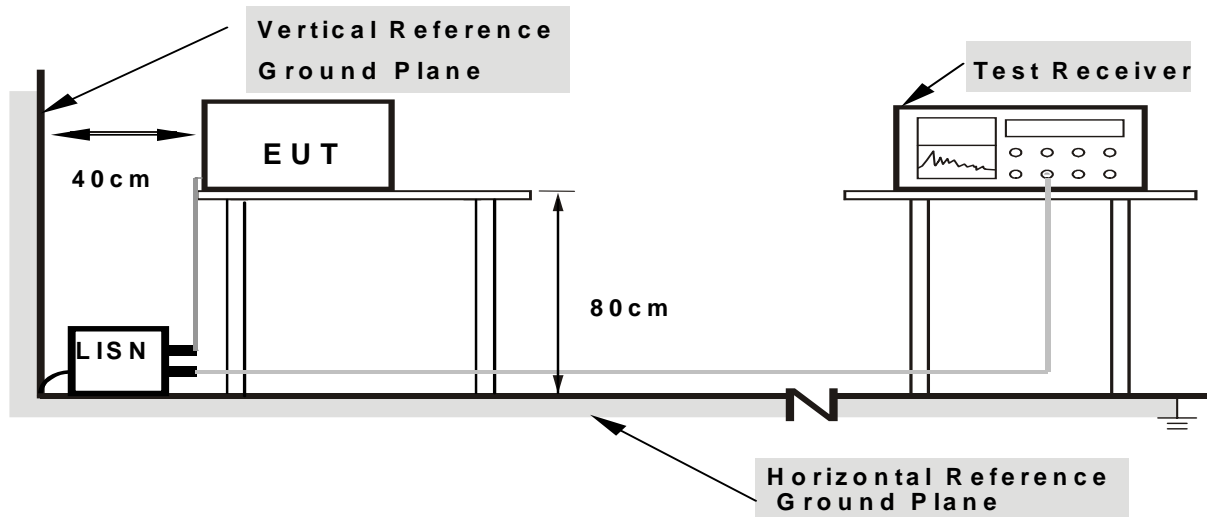

- Note:**
1. Support units were connected to second LISN.
 2. Both of LISNs (AMN) are 80 cm from EUT and at least 80 from other units and other metal planes

3.1.5 EUT OPERATING CONDITIONS

The EUT was configured for testing in a typical fashion (as a customer would normally use it). The EUT has been programmed to continuously transmit during test. This operating condition was tested and used to collect the included data.

3.1.6 TEST RESULTS

EUT :	Bluetooth Speaker	Model Name :	M59
Temperature :	26 °C	Relative Humidity :	54%
Pressure :	1010hPa	Phase :	L
Test Voltage :	AC120V	Test Mode :	Mode4

Frequency (MHz)	Reading Level (dBμV)	Correct Factor (dB)	Measure-ment (dBμV)	Limits (dBμV)	Margin (dB)	Detector Type
0.1780	48.19	9.79	57.98	64.57	-6.59	QP
0.1780	40.28	9.79	50.07	54.57	-4.50	AVG
3.9700	36.19	10.33	46.52	56.00	-9.48	QP
4.0300	31.47	10.33	41.80	46.00	-4.20	AVG

Remark:

1. All readings are Quasi-Peak and Average values.
2. Factor = Insertion Loss + Cable Loss.

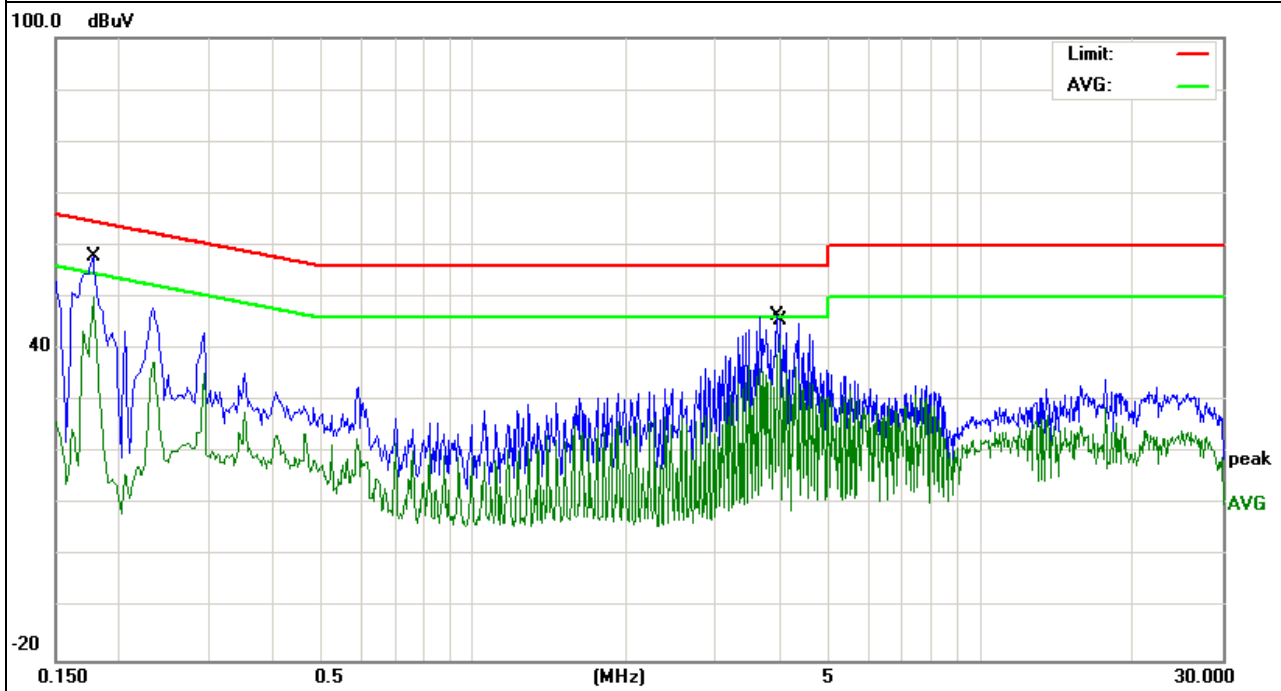

EUT :	Bluetooth Speaker	Model Name :	M59
Temperature :	26 °C	Relative Humidity :	54%
Pressure :	1010hPa	Phase :	N
Test Voltage :	AC120V	Test Mode :	Mode4

Frequency (MHz)	Reading Level (dBμV)	Correct Factor (dB)	Measure-ment (dBμV)	Limits (dBμV)	Margin (dB)	Detector Type
0.1739	44.34	9.80	54.14	64.77	-10.63	QP
0.1739	33.90	9.80	43.70	54.77	-11.07	AVG
4.2579	32.24	10.35	42.59	56.00	-13.41	QP
4.4939	25.71	10.36	36.07	46.00	-9.93	AVG

Remark:

1. All readings are Quasi-Peak and Average values.
2. Factor = Insertion Loss + Cable Loss.

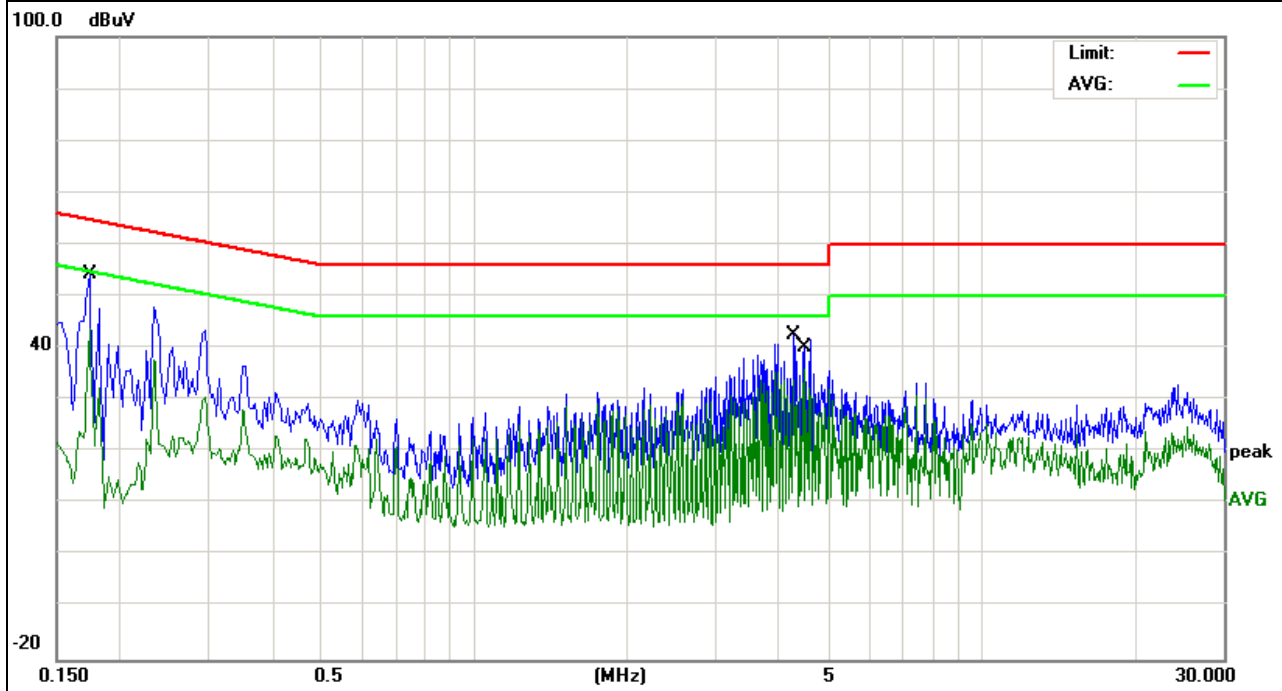

3.2 RADIATED EMISSION MEASUREMENT

3.2.1 RADIATED EMISSION LIMITS (Frequency Range 9kHz-1000MHz)

20dBc in any 100 kHz bandwidth outside the operating frequency band. In case the emission fall within the restricted band specified on 15.205(a), then the 15.209(a) limit in the table below has to be followed.

Frequencies (MHz)	Field Strength (microrvolts/meter)	Measurement Distance (meters)
0.009~0.490	2400/F(KHz)	300
0.490~1.705	24000/F(KHz)	30
1.705~30.0	30	30
30~88	100	3
88~216	150	3
216~960	200	3
Above 960	500	3

LIMITS OF RADIATED EMISSION MEASUREMENT (Above 1000MHz)

FREQUENCY (MHz)	Class A (dBuV/m) (at 3M)		Class B (dBuV/m) (at 3M)	
	PEAK	AVERAGE	PEAK	AVERAGE
Above 1000	80	60	74	54

Notes:

- (1) The limit for radiated test was performed according to FCC PART 15C.
- (2) The tighter limit applies at the band edges.
- (3) Emission level (dBuV/m)=20log Emission level (uV/m).

FREQUENCY RANGE OF RADIATED MEASUREMENT (For unintentional radiators)

Highest frequency generated or Upper frequency of measurement used in the device or on which the device operates or tunes (MHz)	Range (MHz)
Below 1.705	30
1.705 – 108	1000
108 – 500	2000
500 – 1000	5000
Above 1000	5 th harmonic of the highest frequency or 40 GHz, whichever is lower

Spectrum Parameter	Setting
Attenuation	Auto
Start Frequency	1000 MHz
Stop Frequency	10th carrier harmonic
RB / VB (emission in restricted band)	1 MHz / 1 MHz for Peak, 1 MHz / 10Hz for Average

Receiver Parameter	Setting
Attenuation	Auto
Start ~ Stop Frequency	9kHz~150kHz / RB 200Hz for QP
Start ~ Stop Frequency	150kHz~30MHz / RB 9kHz for QP
Start ~ Stop Frequency	30MHz~1000MHz / RB 120kHz for QP

3.2.2 TEST PROCEDURE

- a. The measuring distance of at 3 m shall be used for measurements at frequency up to 1GHz. For frequencies above 1GHz, any suitable measuring distance may be used.
- b. The EUT was placed on the top of a rotating table 0.8 meters above the ground at a 3 meter open area test site. The table was rotated 360 degrees to determine the position of the highest radiation.
- c. The height of the equipment or of the substitution antenna shall be 0.8 m; the height of the test antenna shall vary between 1 m to 4 m. Both horizontal and vertical polarizations of the antenna are set to make the measurement.
- d. The initial step in collecting conducted emission data is a spectrum analyzer peak detector mode pre-scanning the measurement frequency range. Significant peaks are then marked and then Quasi Peak detector mode re-measured.
- e. If the Peak Mode measured value compliance with and lower than Quasi Peak Mode Limit, the EUT shall be deemed to meet QP Limits and then no additional QP Mode measurement performed.
- f. For the actual test configuration, please refer to the related Item –EUT Test Photos.

Note:

Both horizontal and vertical antenna polarities were tested and performed pretest to three orthogonal axis. The worst case emissions were reported

3.2.3 DEVIATION FROM TEST STANDARD

No deviation

3.2.4 TEST SETUP

(A) Radiated Emission Test-Up Frequency Below 30MHz

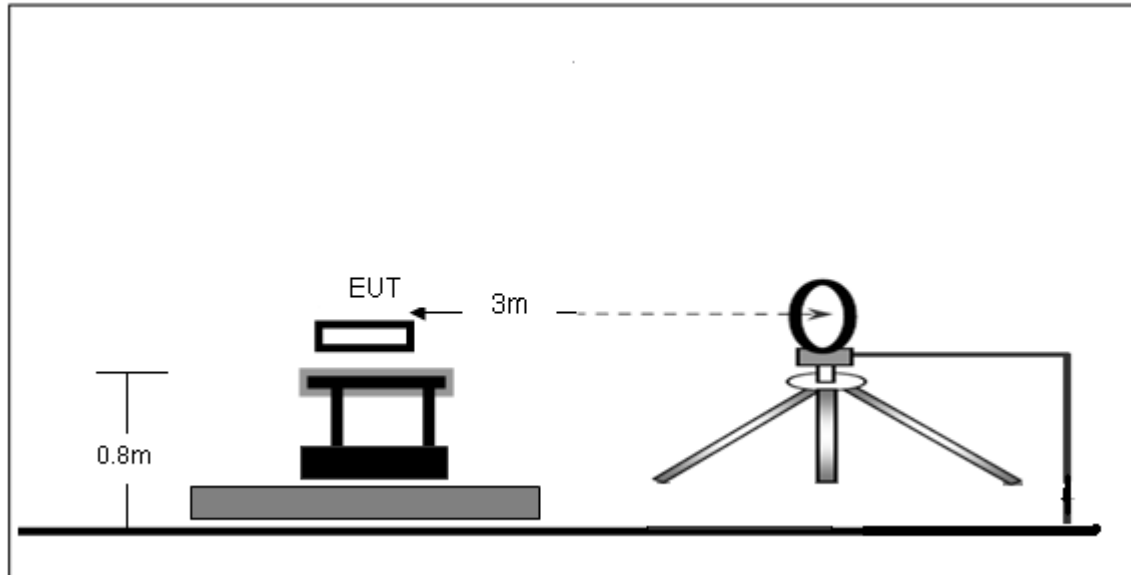

(B) Radiated Emission Test-Up Frequency 30MHz~1GHz

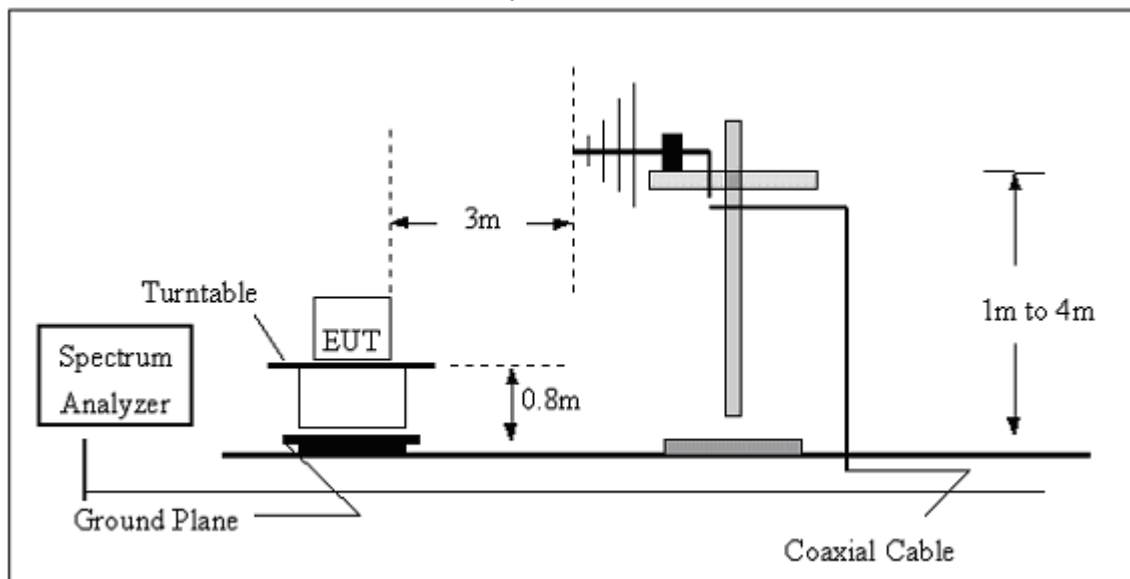

(C) Radiated Emission Test-Up Frequency Above 1GHz

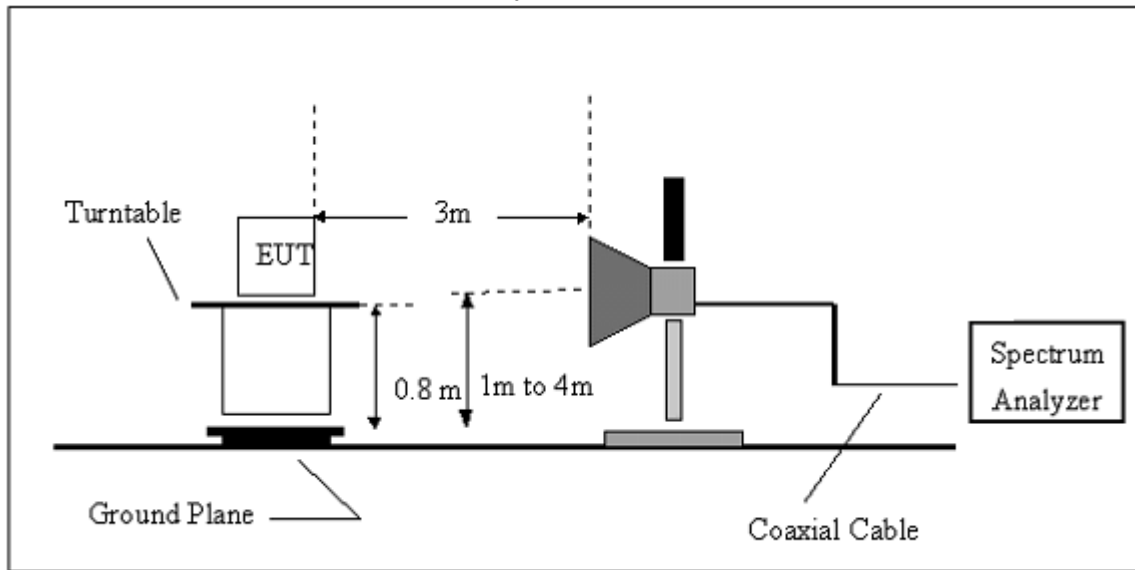

3.2.5 EUT OPERATING CONDITIONS

The EUT tested system was configured as the statements of 2.4 Unless otherwise a special operating condition is specified in the follows during the testing.

3.2.6 TEST RESULTS (BELOW 30 MHZ)

EUT :	Bluetooth Speaker	Model Name :	M59
Temperature :	20 °C	Relative Humidity :	48%
Pressure :	1010 hPa	Test Voltage :	AC 120V
Test Mode :	TX	Polarization :	---

Freq.	Reading	Limit	Margin	State
(MHz)	(dBuV/m)	(dBuV/m)	(dB)	P/F
--	--	--	--	PASS
--	--	--	--	PASS

NOTE:

The amplitude of spurious emissions which are attenuated by more than 20dB below the permissible value has no need to be reported.

Distance extrapolation factor = $40 \log(\text{specific distance}/\text{test distance})$ (dB);

Limit line = specific limits(dBuv) + distance extrapolation factor.

3.2.7 TEST RESULTS (BETWEEN 30M – 1000 MHZ)

EUT :	Bluetooth Speaker	Model Name :	M59
Temperature :	20 °C	Relative Humidity :	48%
Pressure :	1010 hPa	Test Voltage :	AC 120V
Test Mode :	Model 4	Polarization :	Horizontal

Frequency (MHz)	Meter Reading (dBµV)	Factor (dB)	Emission Level (dBµV/m)	Limits (dBµV/m)	Margin (dB)	Detector Type
197.8926	17.80	8.99	26.79	43.50	-16.71	QP
234.1682	18.76	11.03	29.79	46.00	-16.21	QP
267.2342	19.11	12.13	31.24	46.00	-14.76	QP
309.2531	15.46	14.23	29.69	46.00	-16.31	QP
774.1584	10.69	26.16	36.85	46.00	-9.15	QP

Remark:
Factor = Antenna Factor + Cable Loss – Pre-amplifier.

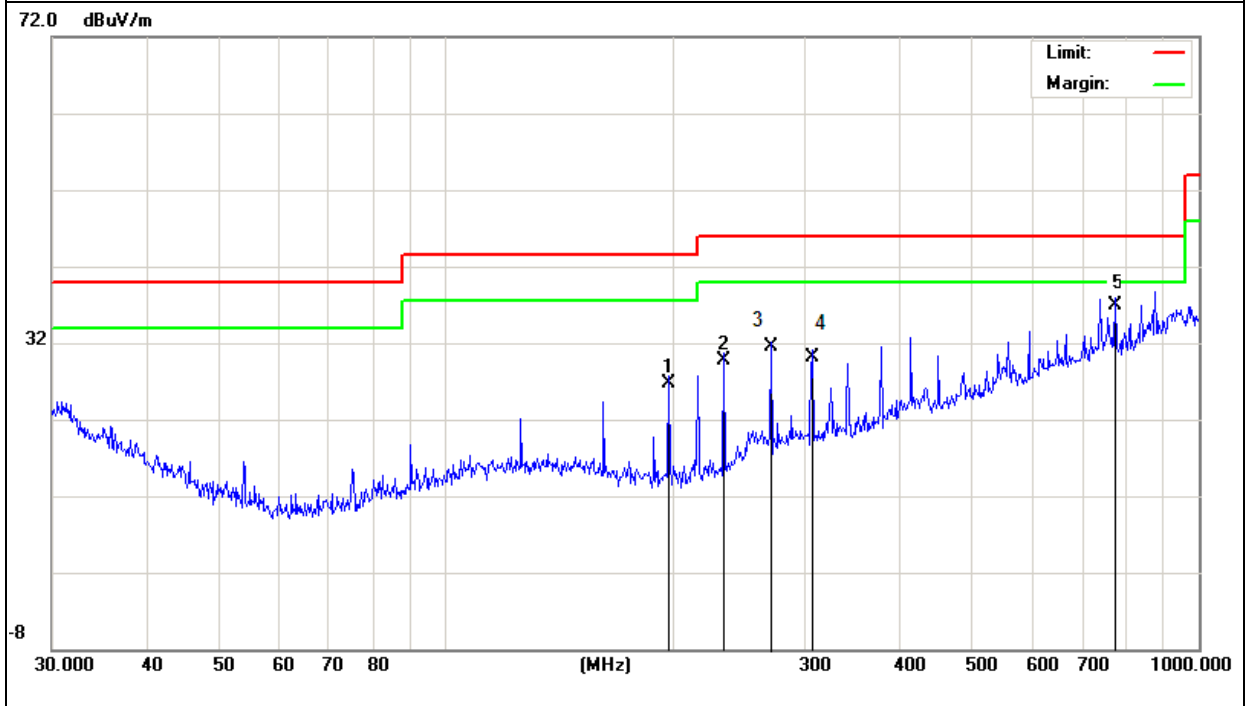

EUT :	Bluetooth Speaker	Model Name :	M59
Temperature :	20 °C	Relative Humidity :	48%
Pressure :	1010 hPa	Test Voltage :	AC 120V
Test Mode :	Mode 4	Polarization :	Vertical

Frequency (MHz)	Meter Reading (dBµV)	Factor (dB)	Emission Level (dBµV/m)	Limits (dBµV/m)	Margin (dB)	Detector Type
31.5093	13.67	17.66	31.33	40.00	-8.67	QP
119.7651	14.97	12.43	27.42	43.50	-16.08	QP
323.6751	13.15	13.97	27.12	46.00	-18.88	QP
541.3723	14.46	22.44	36.90	46.00	-9.10	QP
758.0407	10.38	26.40	36.78	46.00	-9.22	QP

Remark:
Factor = Antenna Factor + Cable Loss – Pre-amplifier.

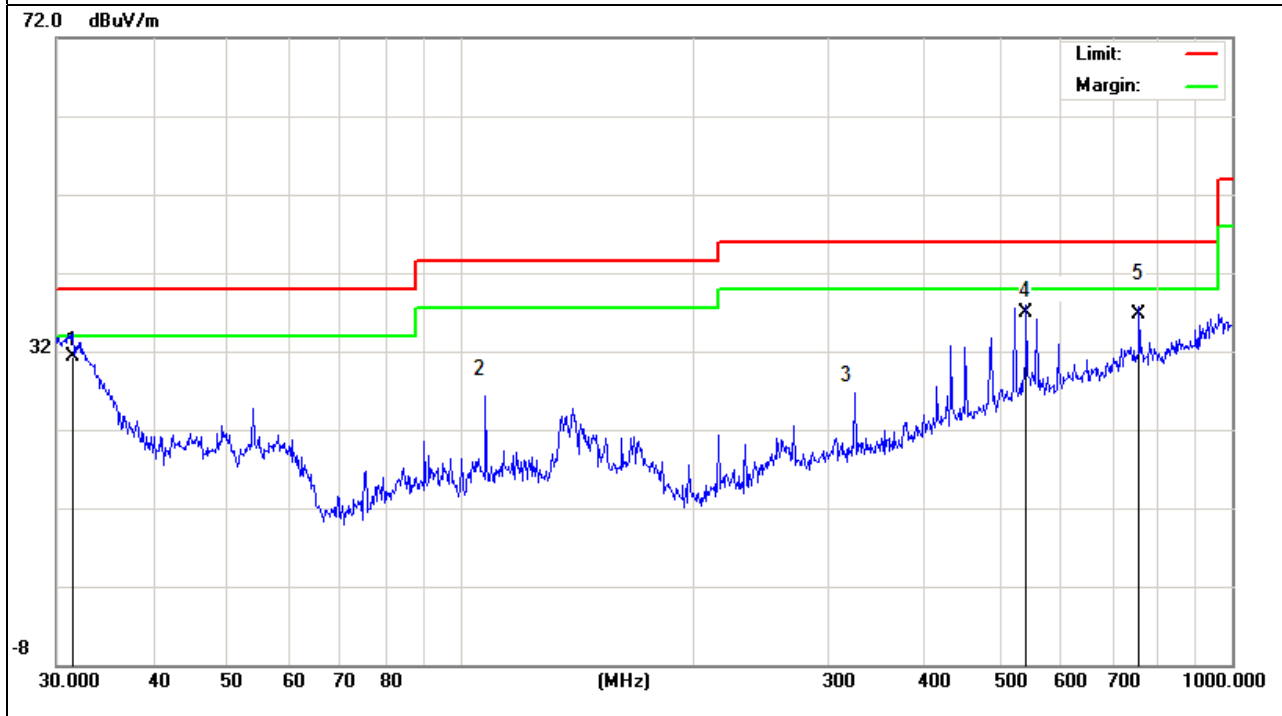

3.2.8 TEST RESULTS (ABOVE 1000 MHZ)

EUT :	Bluetooth Speaker	Model Name :	M59
Temperature :	20 °C	Relative Humidity :	48%
Pressure :	1010 hPa	Test Voltage :	AC 120V
Test Mode :	TX 2402MHz – CH 00(1Mbps)	Polarization :	Horizontal

Frequency (MHz)	Meter Reading (dBµV)	Factor (dB)	Emission Level (dBµV/m)	Limits (dBµV/m)	Margin (dB)	Detector Type
4804.121	64.95	-3.64	61.31	74.00	-12.69	peak
4804.121	48.32	-3.64	44.68	54.00	-9.32	AVG
7206.132	56.42	-0.95	55.47	74.00	-18.53	peak
7206.132	42.78	-0.95	41.83	54.00	-12.17	AVG

Remark:
 Factor = Antenna Factor + Cable Loss – Pre-amplifier.
 No emission detected above 18GHz

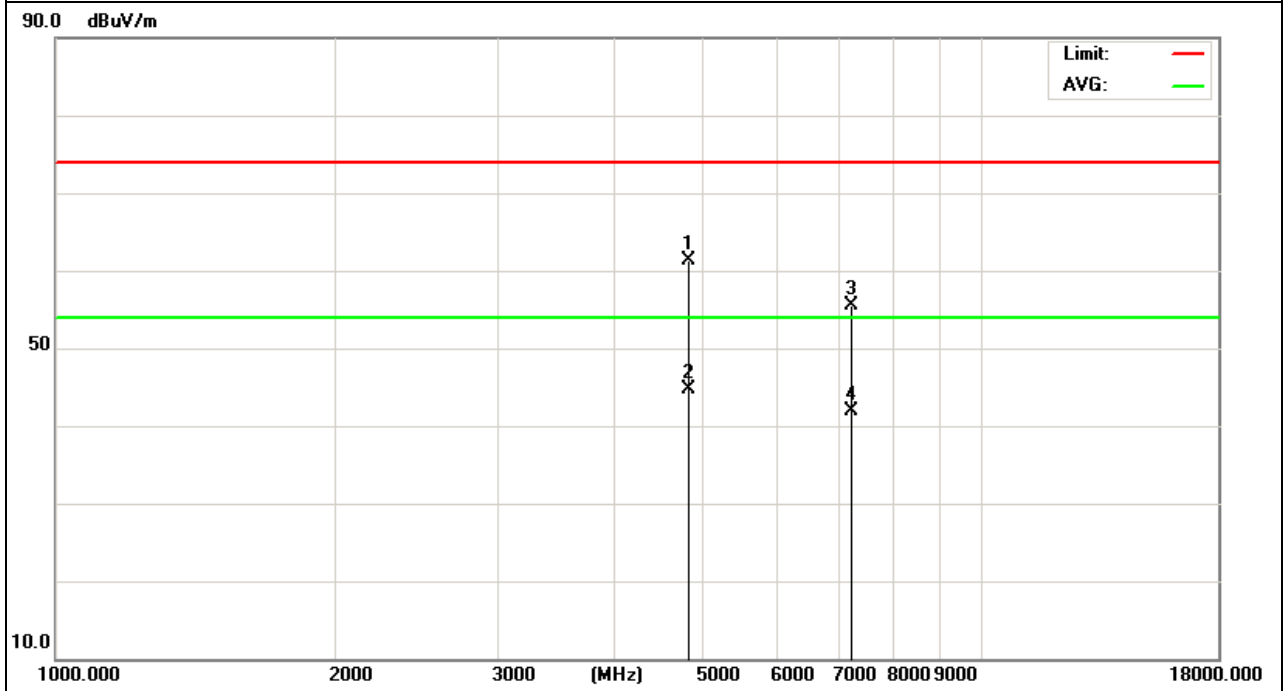

EUT :	Bluetooth Speaker	Model Name :	M59
Temperature :	20 °C	Relative Humidity :	48%
Pressure :	1010 hPa	Test Voltage :	AC 120V
Test Mode :	TX 2402MHz – CH 00(1Mbps)	Polarization :	Vertical

Frequency (MHz)	Meter Reading (dBµV)	Factor (dB)	Emission Level (dBµV/m)	Limits (dBµV/m)	Margin (dB)	Detector Type
4804.115	6.06	-3.64	2.42	74.00	-71.58	peak
4804.115	49.56	-3.64	45.92	54.00	-8.08	AVG
7206.122	57.33	-0.95	56.38	74.00	-17.62	peak
7206.122	44.32	-0.95	43.37	54.00	-10.63	AVG

Remark:
 Factor = Antenna Factor + Cable Loss – Pre-amplifier.
 No emission detected above 18GHz

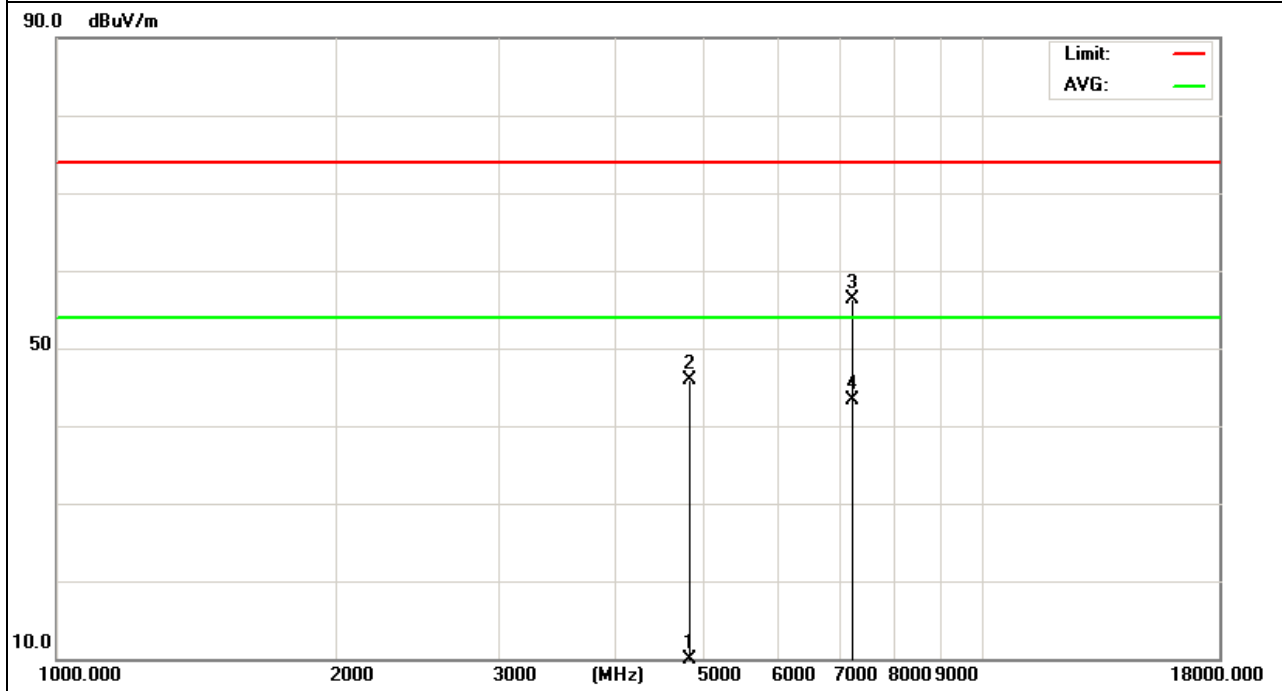

EUT :	Bluetooth Speaker	Model Name :	M59
Temperature :	20 °C	Relative Humidity :	48%
Pressure :	1010 hPa	Test Voltage :	AC 120V
Test Mode :	TX 2441MHz – CH 39(1Mbps)	Polarization :	Horizontal

Frequency (MHz)	Meter Reading (dBμV)	Factor (dB)	Emission Level (dBμV/m)	Limits (dBμV/m)	Margin (dB)	Detector Type
4882.163	64.64	-3.68	60.96	74.00	-13.04	peak
4882.163	46.26	-3.68	42.58	54.00	-11.42	AVG
7323.136	55.25	-0.82	54.43	74.00	-19.57	peak
7323.136	42.25	-0.82	41.43	54.00	-12.57	AVG

Remark:
 Factor = Antenna Factor + Cable Loss – Pre-amplifier.
 No emission detected above 18GHz

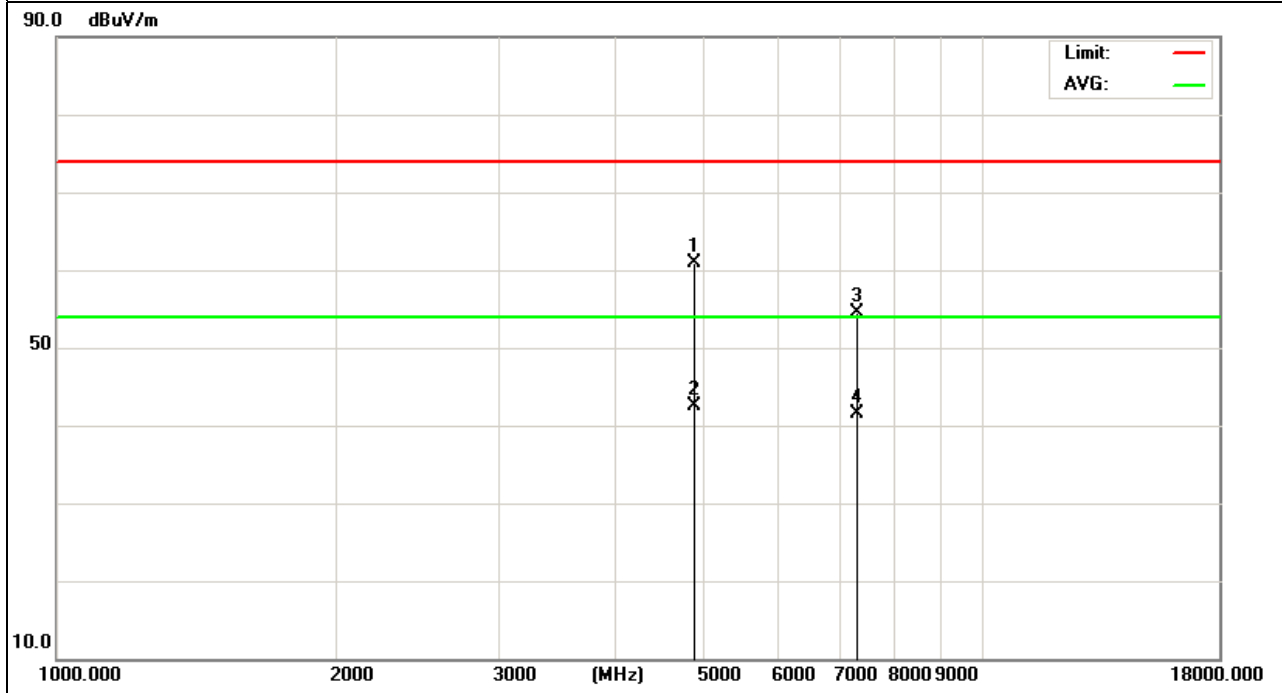

EUT :	Bluetooth Speaker	Model Name :	M59
Temperature :	20 °C	Relative Humidity :	48%
Pressure :	1010 hPa	Test Voltage :	AC 120V
Test Mode :	TX 2441MHz – CH 39(1Mbps)	Polarization :	Vertical

Frequency (MHz)	Meter Reading (dBµV)	Factor (dB)	Emission Level (dBµV/m)	Limits (dBµV/m)	Margin (dB)	Detector Type
4882.123	64.24	-3.68	60.56	74.00	-13.44	peak
4882.123	46.23	-3.68	42.55	54.00	-11.45	AVG
7323.146	55.48	-0.82	54.66	74.00	-19.34	peak
7323.146	41.45	-0.82	40.63	54.00	-13.37	AVG

Remark:
 Factor = Antenna Factor + Cable Loss – Pre-amplifier.
 No emission detected above 18GHz

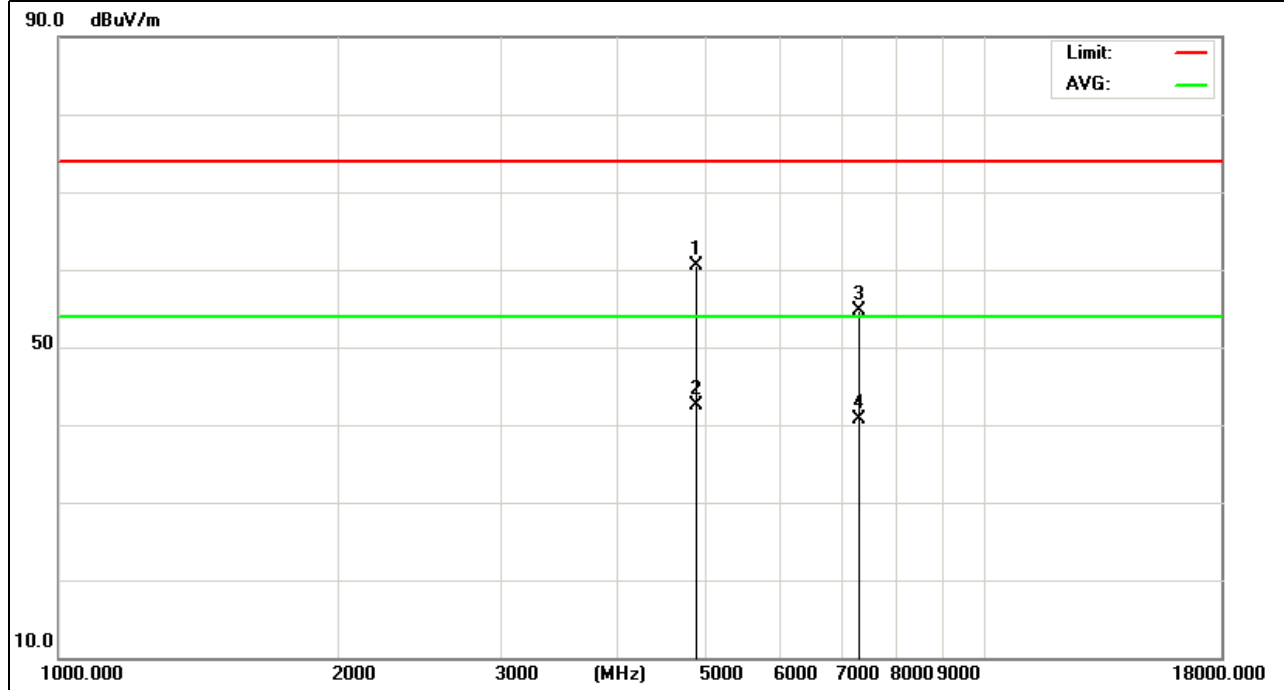

EUT :	Bluetooth Speaker	Model Name :	M59
Temperature :	20 °C	Relative Humidity :	48%
Pressure :	1010 hPa	Test Voltage :	AC 120V
Test Mode :	TX 2480MHz – CH 78(1Mbps)	Polarization :	Horizontal

Frequency (MHz)	Meter Reading (dBµV)	Factor (dB)	Emission Level (dBµV/m)	Limits (dBµV/m)	Margin (dB)	Detector Type
4960.156	65.86	-3.59	62.27	74.00	-11.73	peak
4960.156	46.58	-3.59	42.99	54.00	-11.01	AVG
7440.155	54.76	-0.68	54.08	74.00	-19.92	peak
7440.155	45.03	-0.68	44.35	54.00	-9.65	AVG

Remark:
 Factor = Antenna Factor + Cable Loss – Pre-amplifier.
 No emission detected above 18GHz

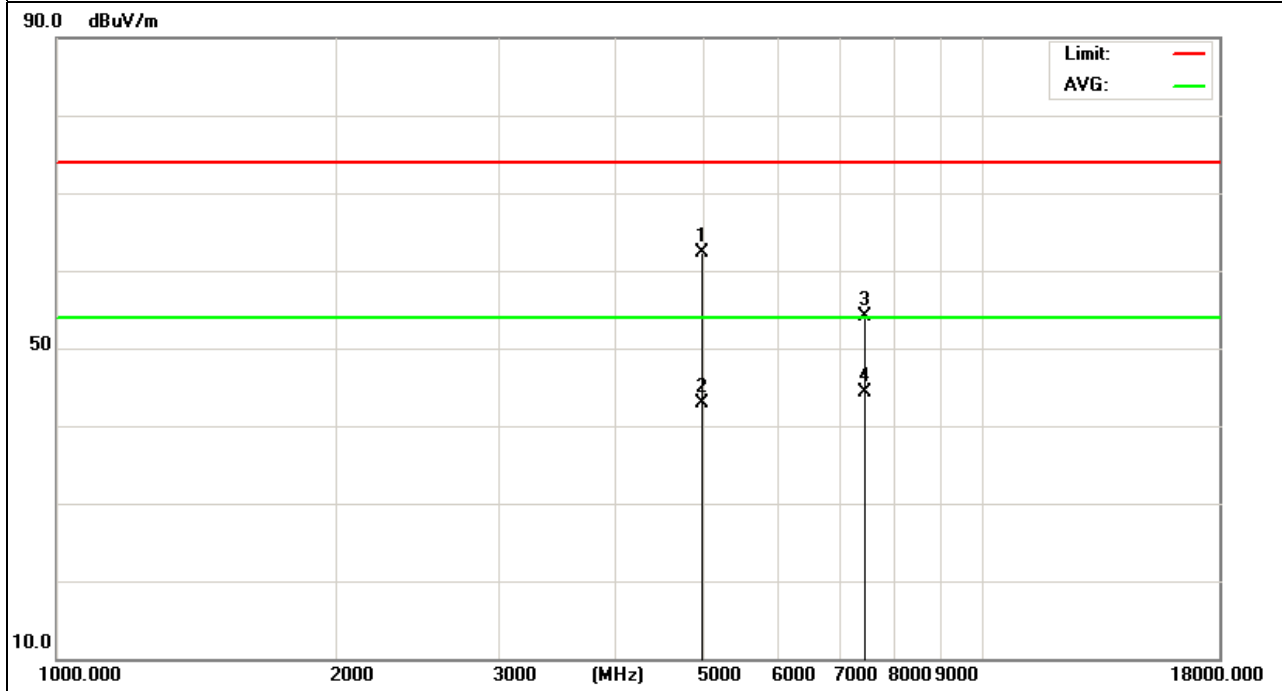

EUT :	Bluetooth Speaker	Model Name :	M59
Temperature :	20 °C	Relative Humidity :	48%
Pressure :	1010 hPa	Test Voltage :	AC 120V
Test Mode :	TX 2480MHz – CH 78(1Mbps)	Polarization :	Vertical

Frequency (MHz)	Meter Reading (dBµV)	Factor (dB)	Emission Level (dBµV/m)	Limits (dBµV/m)	Margin (dB)	Detector Type
4960.131	63.56	-3.59	59.97	74.00	-14.03	peak
4960.131	48.45	-3.59	44.86	54.00	-9.14	AVG
7440.150	56.26	-0.68	55.58	74.00	-18.42	peak
7440.150	44.56	-0.68	43.88	54.00	-10.12	AVG

Remark:
 Factor = Antenna Factor + Cable Loss – Pre-amplifier.
 No emission detected above 18GHz

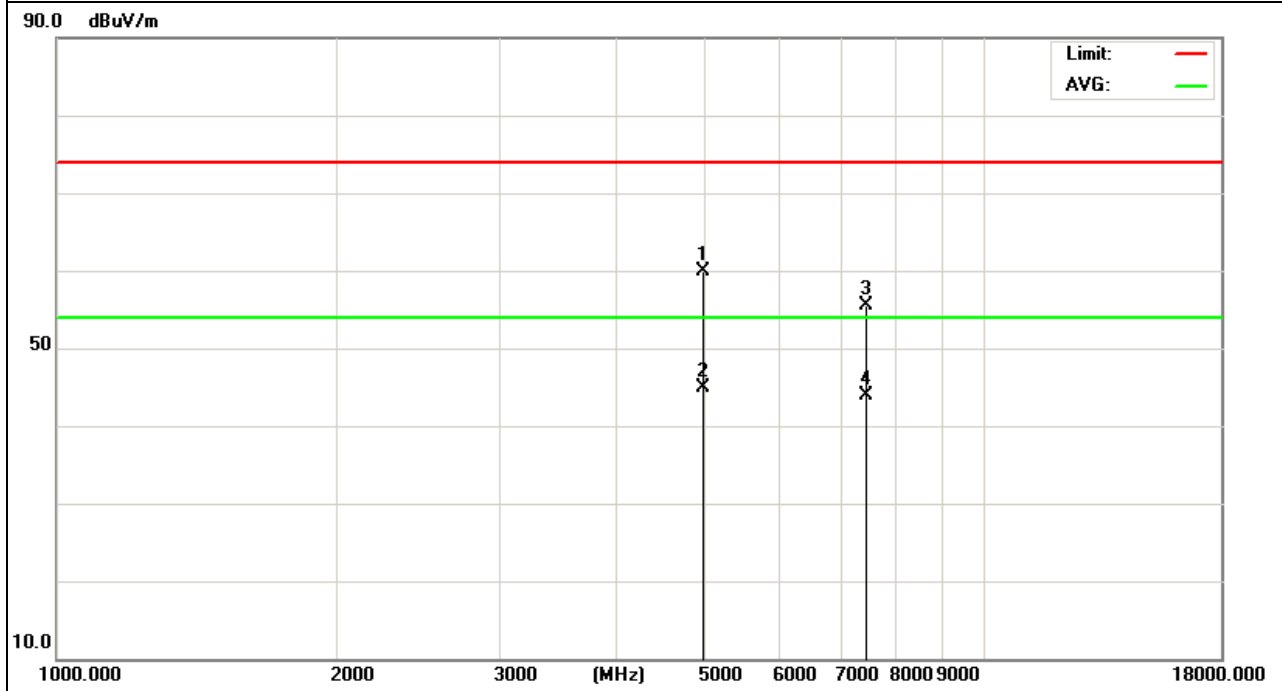

EUT :	Bluetooth Speaker	Model Name :	M59
Temperature :	20 °C	Relative Humidity :	48%
Pressure :	1010 hPa	Test Voltage :	AC 120V
Test Mode :	TX 2402MHz – CH 00(2Mbps)	Polarization :	Horizontal

Frequency (MHz)	Meter Reading (dBμV)	Factor (dB)	Emission Level (dBμV/m)	Limits (dBμV/m)	Margin (dB)	Detector Type
4804.126	63.03	-3.64	59.39	74.00	-14.61	peak
4804.126	47.56	-3.64	43.92	54.00	-10.08	AVG
7206.112	53.56	-0.95	52.61	74.00	-21.39	peak
7206.112	42.80	-0.95	41.85	54.00	-12.15	AVG

Remark:
 Factor = Antenna Factor + Cable Loss – Pre-amplifier.
 No emission detected above 18GHz

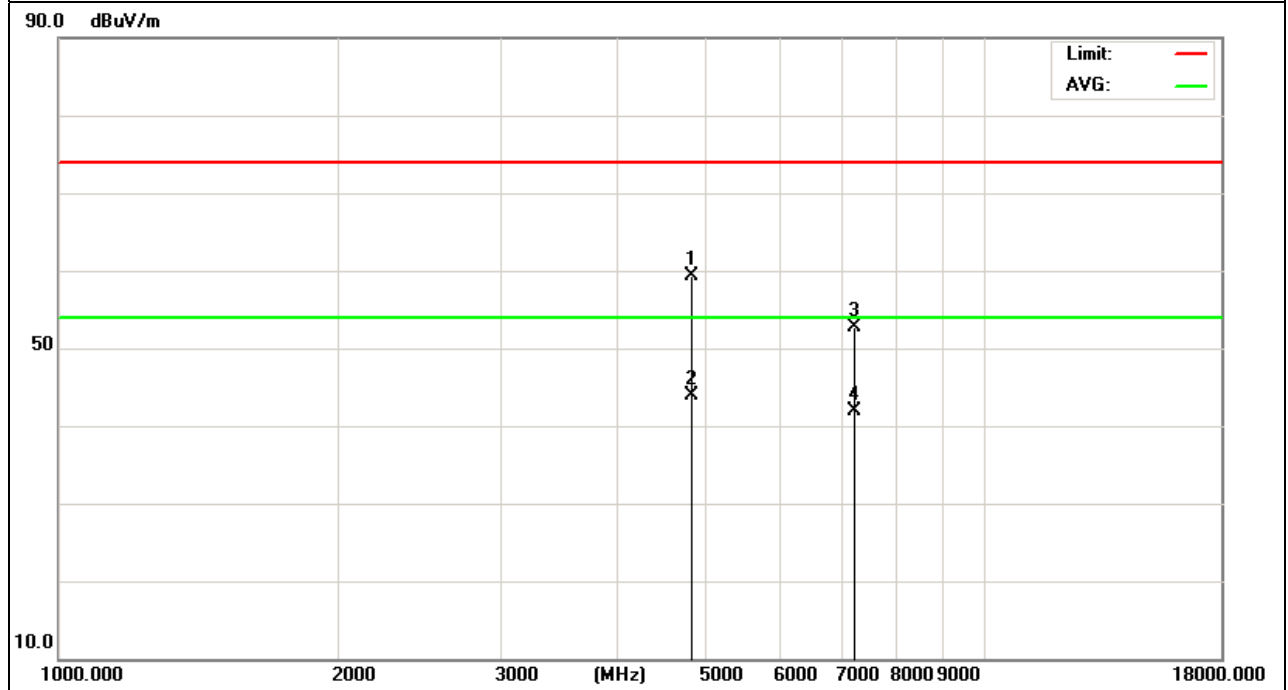

EUT :	Bluetooth Speaker	Model Name :	M59
Temperature :	20 °C	Relative Humidity :	48%
Pressure :	1010 hPa	Test Voltage :	AC 120V
Test Mode :	TX 2402MHz – CH 00(2Mbps)	Polarization :	Vertical

Frequency (MHz)	Meter Reading (dBμV)	Factor (dB)	Emission Level (dBμV/m)	Limits (dBμV/m)	Margin (dB)	Detector Type
4804.119	64.56	-3.64	60.92	74.00	-13.08	peak
4804.119	49.56	-3.64	45.92	54.00	-8.08	AVG
7206.128	56.78	-0.95	55.83	74.00	-18.17	peak
7206.128	41.23	-0.95	40.28	54.00	-13.72	AVG

Remark:
 Factor = Antenna Factor + Cable Loss – Pre-amplifier.
 No emission detected above 18GHz

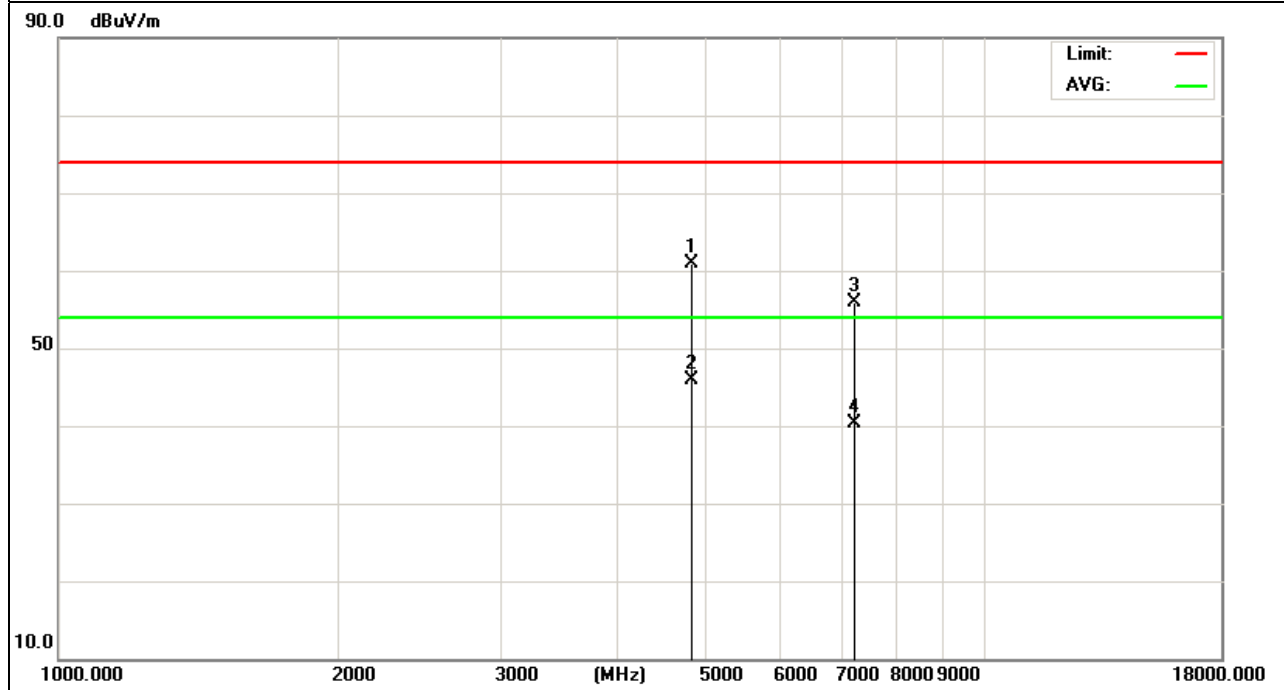

EUT :	Bluetooth Speaker	Model Name :	M59
Temperature :	20 °C	Relative Humidity :	48%
Pressure :	1010 hPa	Test Voltage :	AC 120V
Test Mode :	TX 2441MHz – CH 39(2Mbps)	Polarization :	Horizontal

Frequency (MHz)	Meter Reading (dBµV)	Factor (dB)	Emission Level (dBµV/m)	Limits (dBµV/m)	Margin (dB)	Detector Type
4882.158	64.56	-3.68	60.88	74.00	-13.12	peak
4882.158	45.89	-3.68	42.21	54.00	-11.79	AVG
7323.174	56.59	-0.82	55.77	74.00	-18.23	peak
7323.174	42.19	-0.82	41.37	54.00	-12.63	AVG

Remark:
 Factor = Antenna Factor + Cable Loss – Pre-amplifier.
 No emission detected above 18GHz

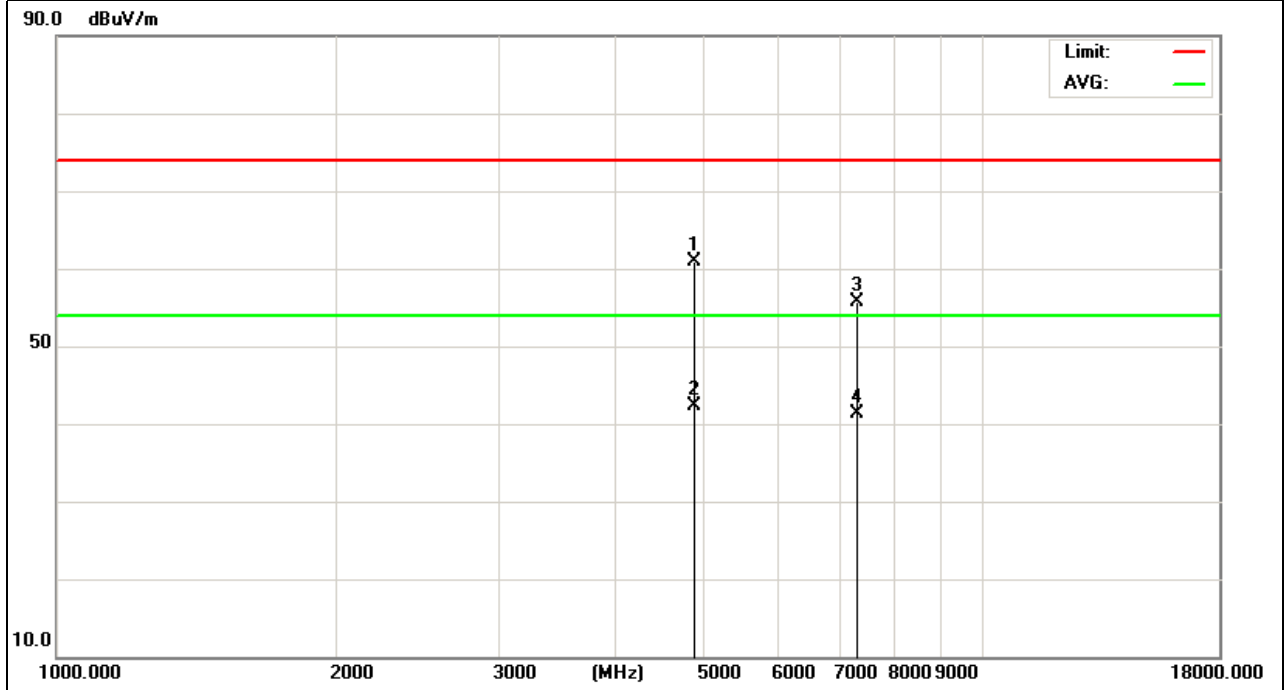

EUT :	Bluetooth Speaker	Model Name :	M59
Temperature :	20 °C	Relative Humidity :	48%
Pressure :	1010 hPa	Test Voltage :	AC 120V
Test Mode :	TX 2441MHz – CH 39(2Mbps)	Polarization :	Vertical

Frequency (MHz)	Meter Reading (dBμV)	Factor (dB)	Emission Level (dBμV/m)	Limits (dBμV/m)	Margin (dB)	Detector Type
4882.191	64.95	-3.68	61.27	74.00	-12.73	peak
4882.191	46.45	-3.68	42.77	54.00	-11.23	AVG
7323.165	57.65	-0.82	56.83	74.00	-17.17	peak
7323.165	41.32	-0.82	40.50	54.00	-13.50	AVG

Remark:
 Factor = Antenna Factor + Cable Loss – Pre-amplifier.
 No emission detected above 18GHz

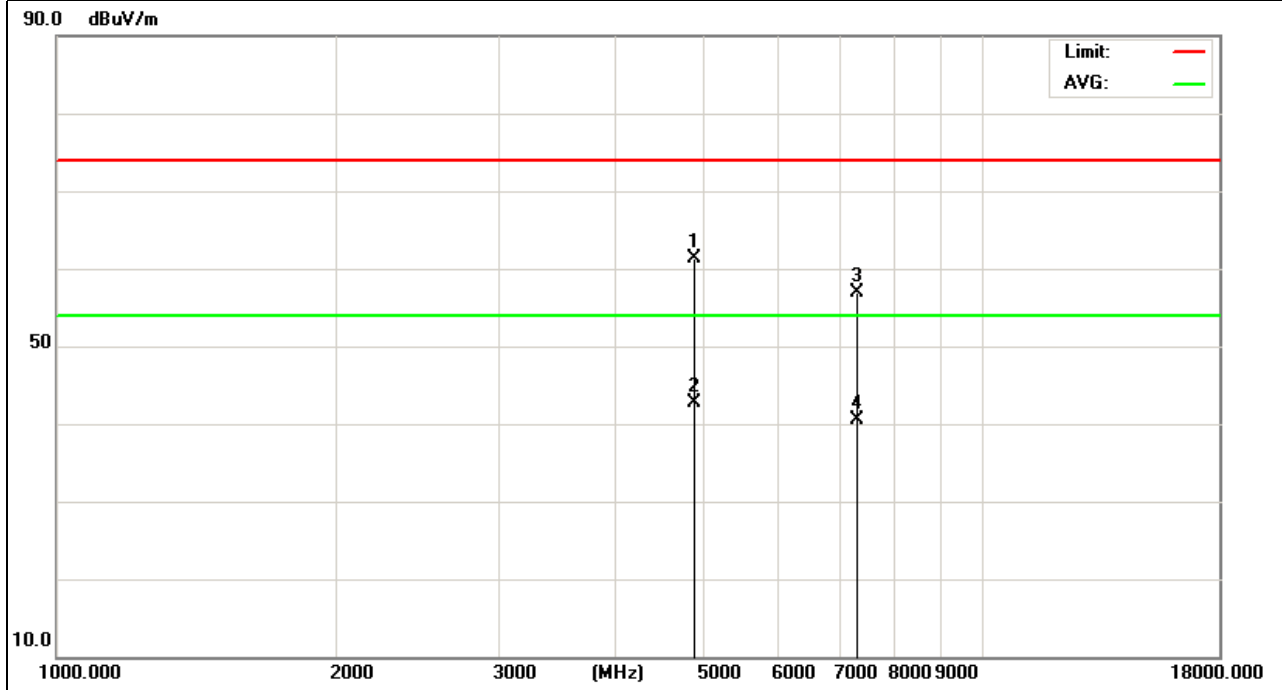

EUT :	Bluetooth Speaker	Model Name :	M59
Temperature :	20 °C	Relative Humidity :	48%
Pressure :	1010 hPa	Test Voltage :	AC 120V
Test Mode :	TX 2480MHz – CH 78(2Mbps)	Polarization :	Horizontal

Frequency (MHz)	Meter Reading (dBμV)	Factor (dB)	Emission Level (dBμV/m)	Limits (dBμV/m)	Margin (dB)	Detector Type
4960.126	65.99	-3.59	62.40	74.00	-11.60	peak
4960.126	42.11	-3.59	38.52	54.00	-15.48	AVG
7440.153	53.56	-0.68	52.88	74.00	-21.12	peak
7440.153	42.89	-0.68	42.21	54.00	-11.79	AVG

Remark:
 Factor = Antenna Factor + Cable Loss – Pre-amplifier.
 No emission detected above 18GHz

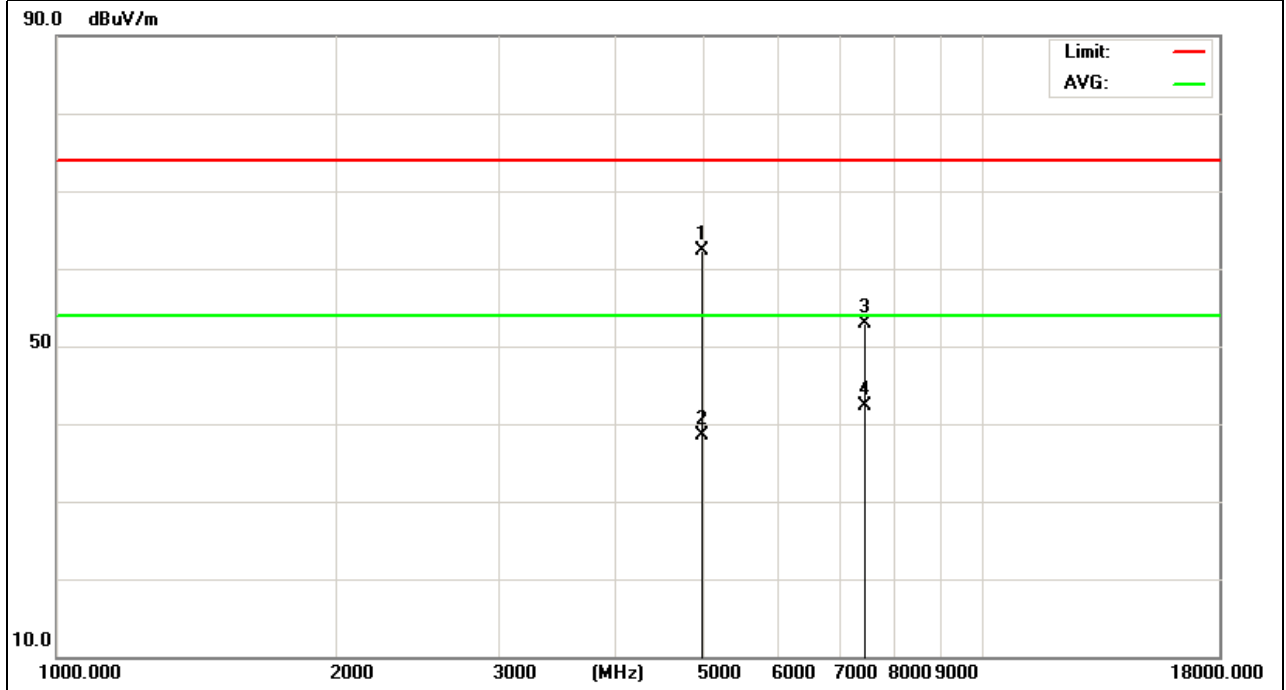

EUT :	Bluetooth Speaker	Model Name :	M59
Temperature :	20 °C	Relative Humidity :	48%
Pressure :	1010 hPa	Test Voltage :	AC 120V
Test Mode :	TX 2480MHz – CH 78(2Mbps)	Polarization :	Vertical

Frequency (MHz)	Meter Reading (dBµV)	Factor (dB)	Emission Level (dBµV/m)	Limits (dBµV/m)	Margin (dB)	Detector Type
4960.112	65.56	-3.59	61.97	74.00	-12.03	peak
4960.112	47.55	-3.59	43.96	54.00	-10.04	AVG
7440.126	58.57	-0.68	57.89	74.00	-16.11	peak
7440.126	45.56	-0.68	44.88	54.00	-9.12	AVG

Remark:
 Factor = Antenna Factor + Cable Loss – Pre-amplifier.
 No emission detected above 18GHz

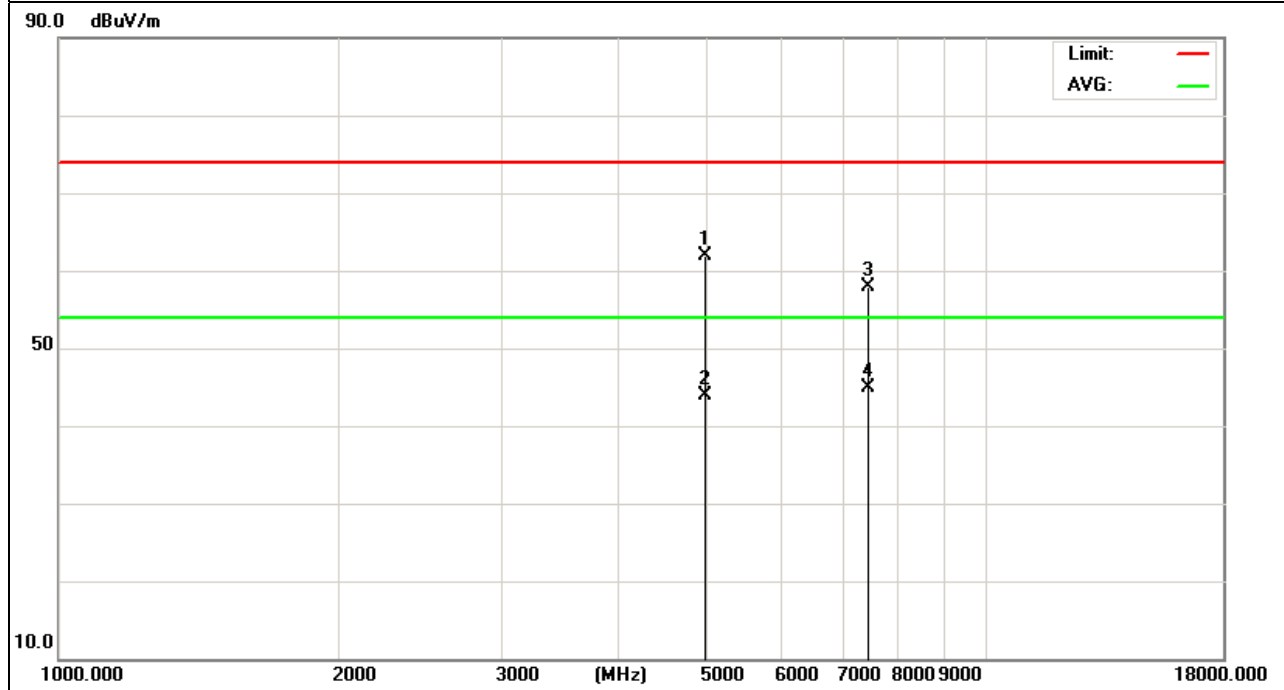

EUT :	Bluetooth Speaker	Model Name :	M59
Temperature :	20 °C	Relative Humidity :	48%
Pressure :	1010 hPa	Test Voltage :	AC 120V
Test Mode :	TX 2402MHz – CH00 (3Mbps)	Polarization :	Horizontal

Frequency (MHz)	Meter Reading (dBμV)	Factor (dB)	Emission Level (dBμV/m)	Limits (dBμV/m)	Margin (dB)	Detector Type
4804.130	63.25	-3.64	59.61	74.00	-14.39	peak
4804.130	46.31	-3.64	42.67	54.00	-11.33	AVG
7206.145	53.56	-0.95	52.61	74.00	-21.39	peak
7206.145	42.32	-0.95	41.37	54.00	-12.63	AVG

Remark:
 Factor = Antenna Factor + Cable Loss – Pre-amplifier.
 No emission detected above 18GHz

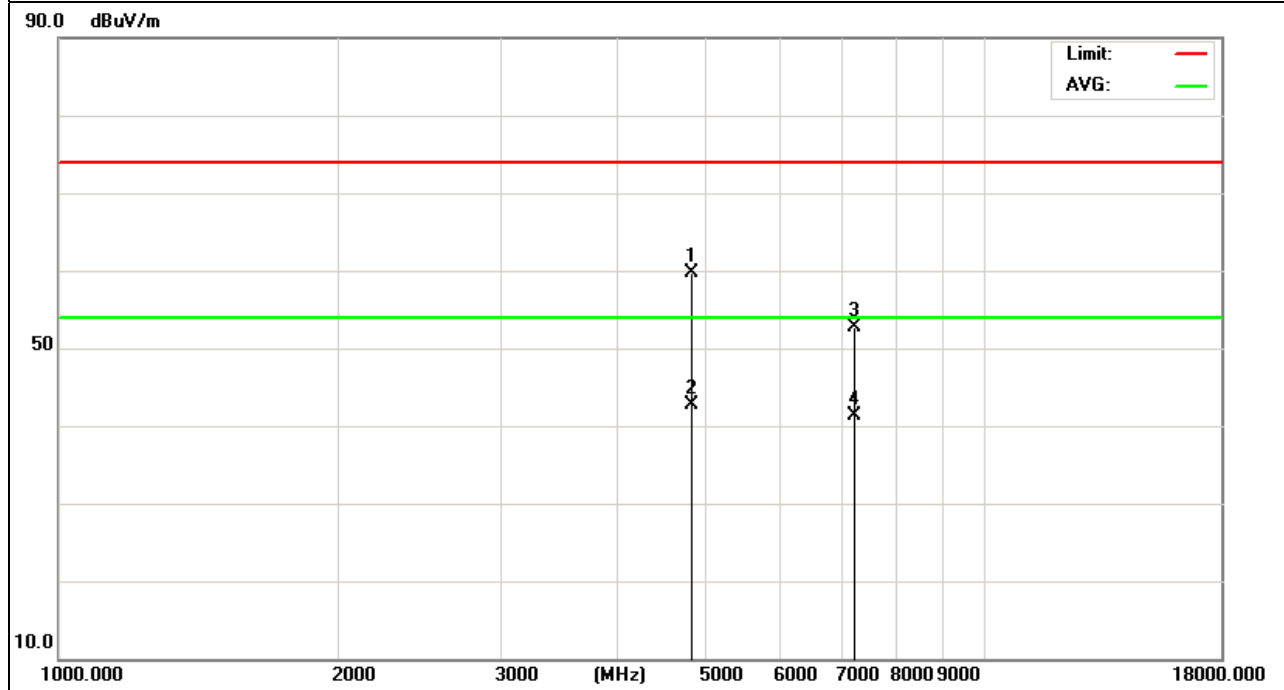

EUT :	Bluetooth Speaker	Model Name :	M59
Temperature :	20 °C	Relative Humidity :	48%
Pressure :	1010 hPa	Test Voltage :	AC 120V
Test Mode :	TX 2402MHz – CH00 (3Mbps)	Polarization :	Vertical

Frequency (MHz)	Meter Reading (dBμV)	Factor (dB)	Emission Level (dBμV/m)	Limits (dBμV/m)	Margin (dB)	Detector Type
4804.105	63.56	-3.64	59.92	74.00	-14.08	peak
4804.105	45.26	-3.64	41.62	54.00	-12.38	AVG
7206.127	56.67	-0.95	55.72	74.00	-18.28	peak
7206.127	42.25	-0.95	41.30	54.00	-12.70	AVG

Remark:
 Factor = Antenna Factor + Cable Loss – Pre-amplifier.
 No emission detected above 18GHz

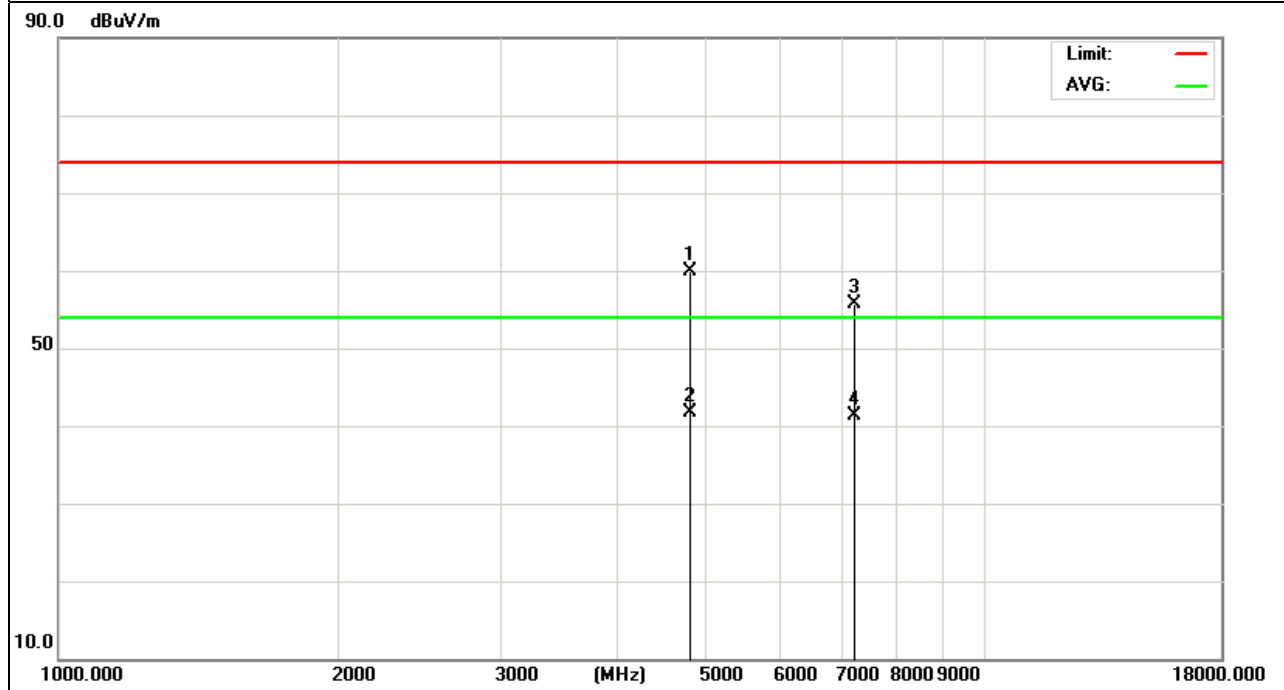

EUT :	Bluetooth Speaker	Model Name :	M59
Temperature :	20 °C	Relative Humidity :	48%
Pressure :	1010 hPa	Test Voltage :	AC 120V
Test Mode :	TX 2441MHz – CH39(3Mbps)	Polarization :	Horizontal

Frequency (MHz)	Meter Reading (dBμV)	Factor (dB)	Emission Level (dBμV/m)	Limits (dBμV/m)	Margin (dB)	Detector Type
4882.172	64.16	-3.68	60.48	74.00	-13.52	peak
4882.172	46.56	-3.68	42.88	54.00	-11.12	AVG
7323.188	55.86	-0.82	55.04	74.00	-18.96	peak
7323.188	42.75	-0.82	41.93	54.00	-12.07	AVG

Remark:
 Factor = Antenna Factor + Cable Loss – Pre-amplifier.
 No emission detected above 18GHz

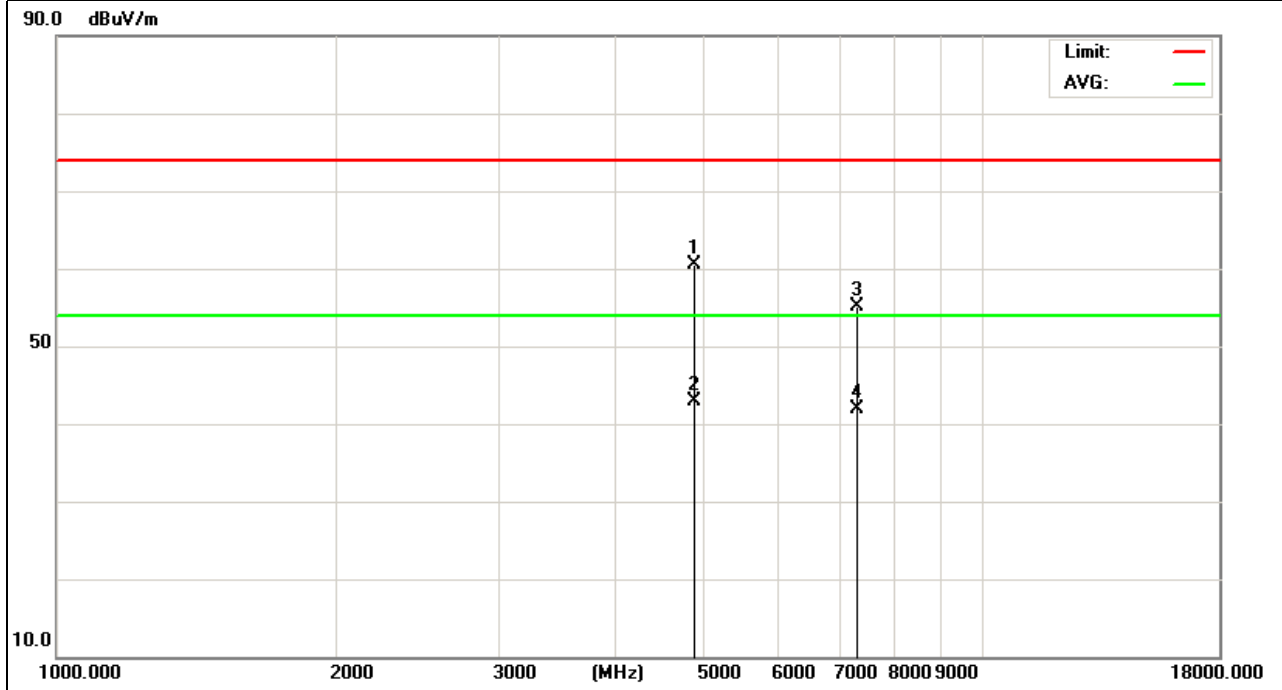

EUT :	Bluetooth Speaker	Model Name :	M59
Temperature :	20 °C	Relative Humidity :	48%
Pressure :	1010 hPa	Test Voltage :	AC 120V
Test Mode :	TX 2441MHz – CH39 (3Mbps)	Polarization :	Vertical

Frequency (MHz)	Meter Reading (dBμV)	Factor (dB)	Emission Level (dBμV/m)	Limits (dBμV/m)	Margin (dB)	Detector Type
4882.112	62.25	-3.68	58.57	74.00	-15.43	peak
4882.112	46.63	-3.68	42.95	54.00	-11.05	AVG
7323.141	54.53	-0.82	53.71	74.00	-20.29	peak
7323.141	42.25	-0.82	41.43	54.00	-12.57	AVG

Remark:
 Factor = Antenna Factor + Cable Loss – Pre-amplifier.
 No emission detected above 18GHz

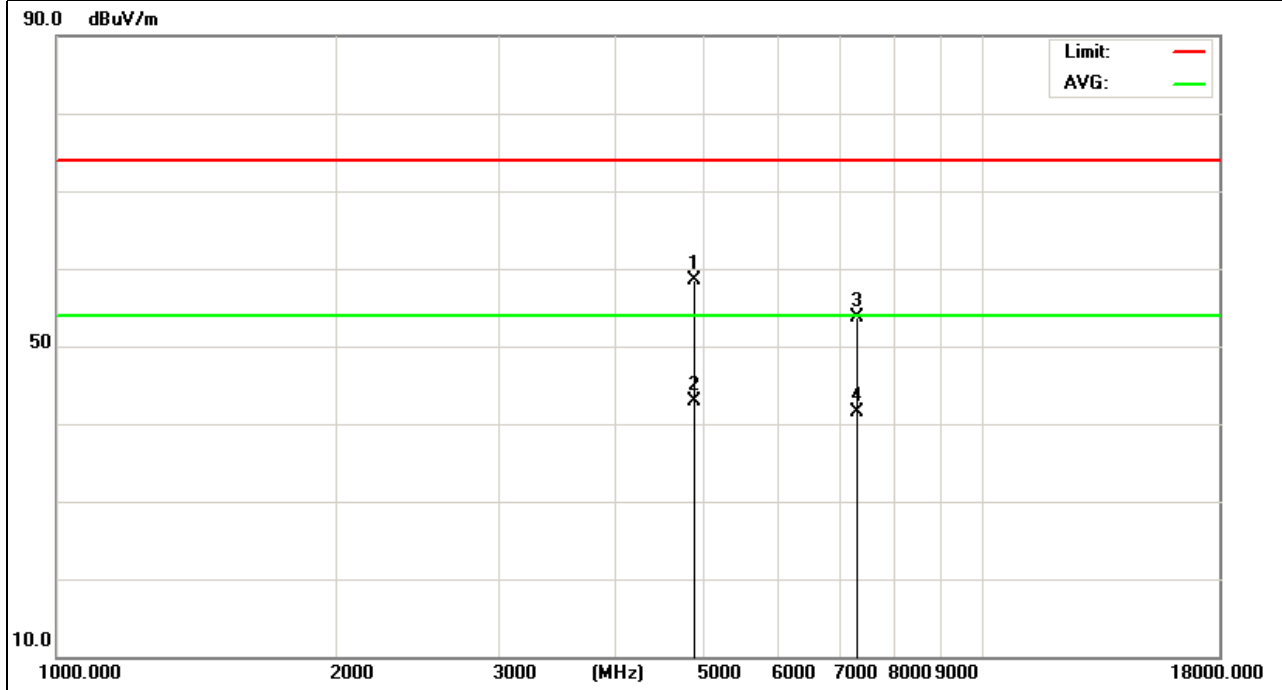

EUT :	Bluetooth Speaker	Model Name :	M59
Temperature :	20 °C	Relative Humidity :	48%
Pressure :	1010 hPa	Test Voltage :	AC 120V
Test Mode :	TX 2480MHz – CH78 (3Mbps)	Polarization :	Horizontal

Frequency (MHz)	Meter Reading (dBμV)	Factor (dB)	Emission Level (dBμV/m)	Limits (dBμV/m)	Margin (dB)	Detector Type
4960.176	61.87	-3.59	58.28	74.00	-15.72	peak
4960.176	46.87	-3.59	43.28	54.00	-10.72	AVG
7440.155	55.32	-0.68	54.64	74.00	-19.36	peak
7440.155	42.32	-0.68	41.64	54.00	-12.36	AVG

Remark:
 Factor = Antenna Factor + Cable Loss – Pre-amplifier.
 No emission detected above 18GHz

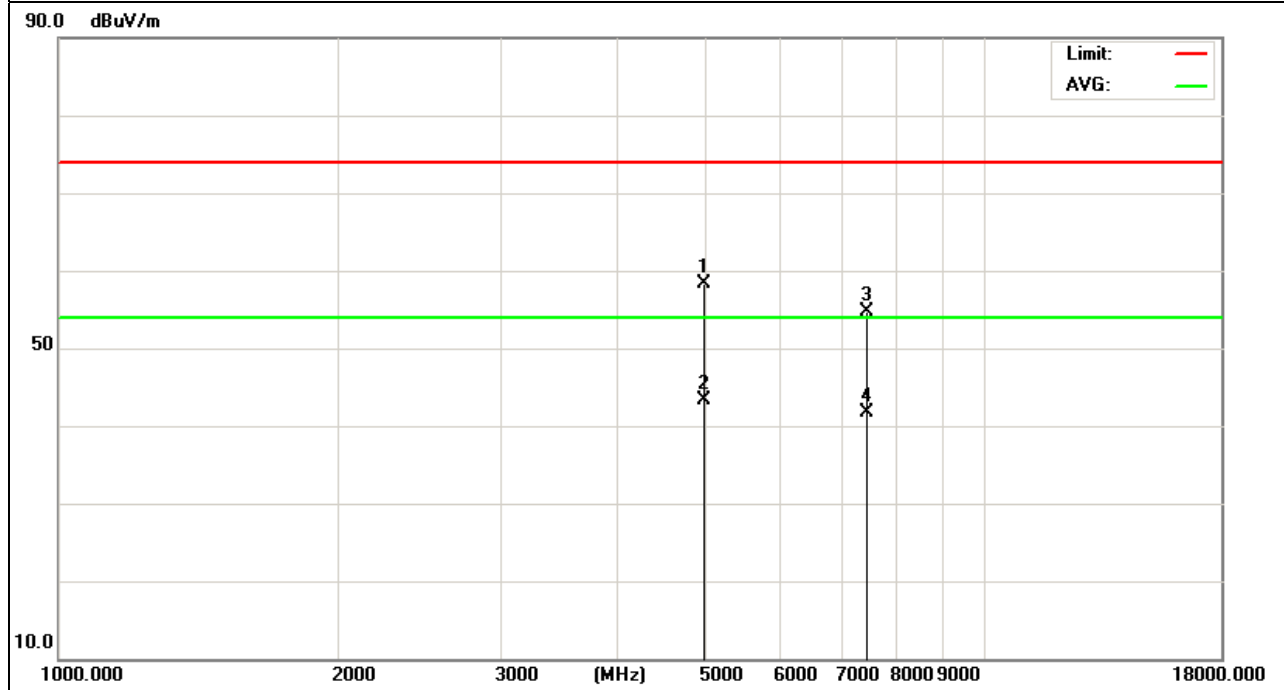

EUT :	Bluetooth Speaker	Model Name :	M59
Temperature :	20 °C	Relative Humidity :	48%
Pressure :	1010 hPa	Test Voltage :	AC 120V
Test Mode :	TX 2480MHz – CH78 (3Mbps)	Polarization :	Vertical

Frequency (MHz)	Meter Reading (dBμV)	Factor (dB)	Emission Level (dBμV/m)	Limits (dBμV/m)	Margin (dB)	Detector Type
4960.175	61.26	-3.59	57.67	74.00	-16.33	peak
4960.175	46.23	-3.59	42.64	54.00	-11.36	AVG
7440.114	53.12	-0.68	52.44	74.00	-21.56	peak
7440.114	41.23	-0.68	40.55	54.00	-13.45	AVG

Remark:
 Factor = Antenna Factor + Cable Loss – Pre-amplifier.
 No emission detected above 18GHz

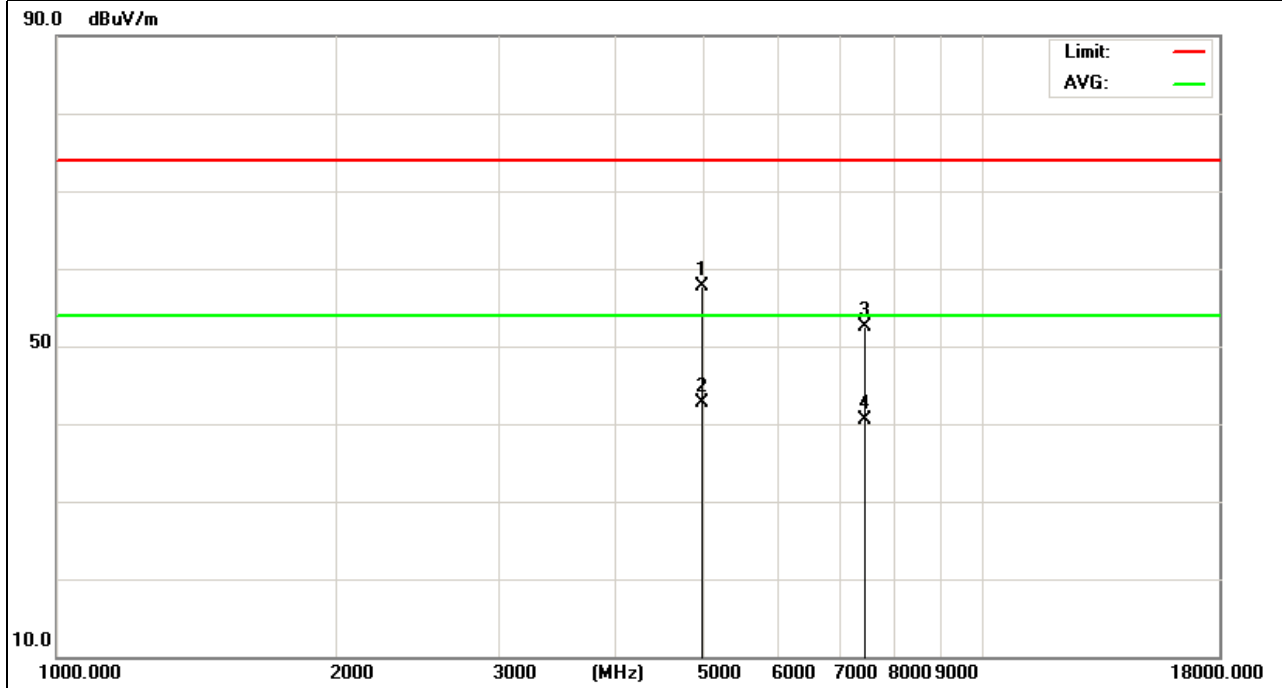

3.2.9 TEST RESULTS (RESTRICTED BANDS REQUIREMENTS)

EUT :	Bluetooth Speaker	Model Name :	M59
Temperature :	20 °C	Relative Humidity :	48%
Pressure :	1010 hPa	Test Voltage :	AC 120V
Test Mode :	TX /2402MHz-1Mbps	Polarization :	Vertical

Frequency (MHz)	Meter Reading (dBμV)	Factor (dB)	Emission Level (dBμV/m)	Limits (dBμV/m)	Margin (dB)	Detector Type
2310.000	51.00	-12.89	38.11	74.00	-35.89	peak
2390.000	52.44	-13.06	39.38	74.00	-34.62	peak
2400.000	81.24	-12.99	68.25	74.00	-5.75	peak
2400.000	57.43	-12.99	44.44	54.00	-9.56	AVG

Remark:

Factor = Antenna Factor + Cable Loss – Pre-amplifier.

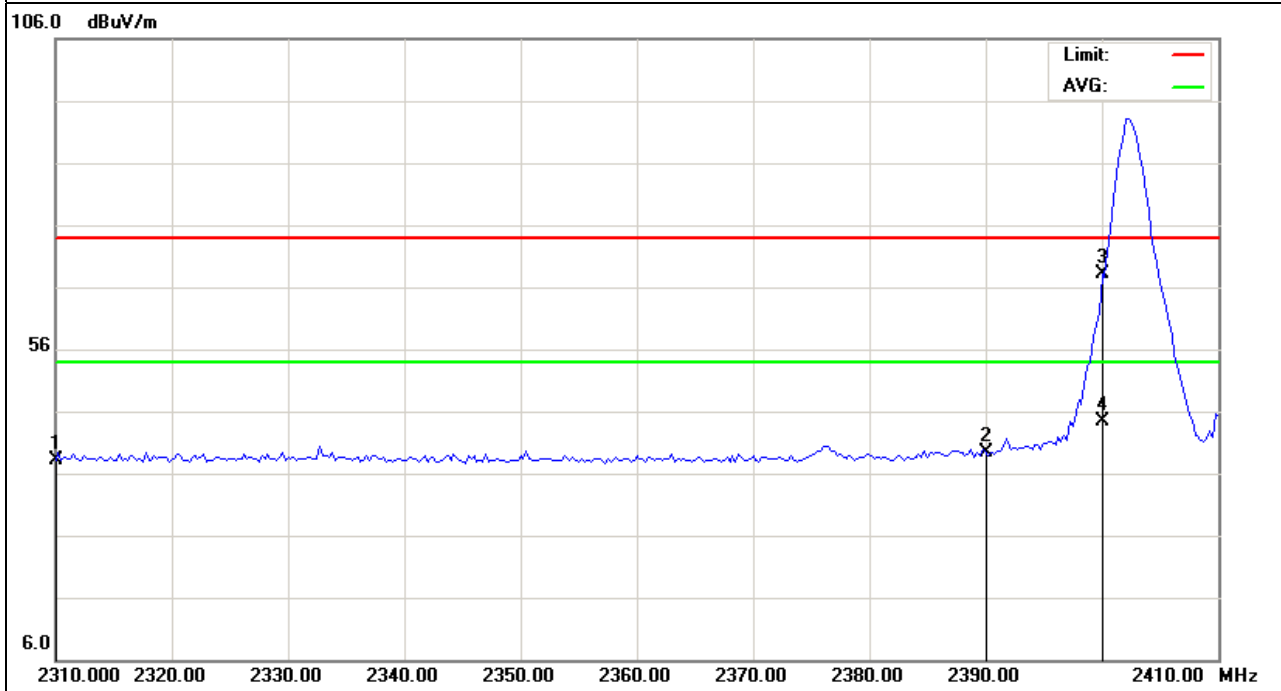

EUT :	Bluetooth Speaker	Model Name :	M59
Temperature :	20 °C	Relative Humidity :	48%
Pressure :	1010 hPa	Test Voltage :	AC 120V
Test Mode :	TX /2402MHz-1Mbps	Polarization :	Horizontal

Frequency (MHz)	Meter Reading (dBμV)	Factor (dB)	Emission Level (dBμV/m)	Limits (dBμV/m)	Margin (dB)	Detector Type
2310.000	50.76	-12.89	37.87	74.00	-36.13	peak
2390.000	50.75	-13.06	37.69	74.00	-36.31	peak
2400.000	74.95	-12.99	61.96	74.00	-12.04	peak
2400.000	59.01	-12.99	46.02	54.00	-7.98	AVG

Remark:
 Factor = Antenna Factor + Cable Loss – Pre-amplifier.

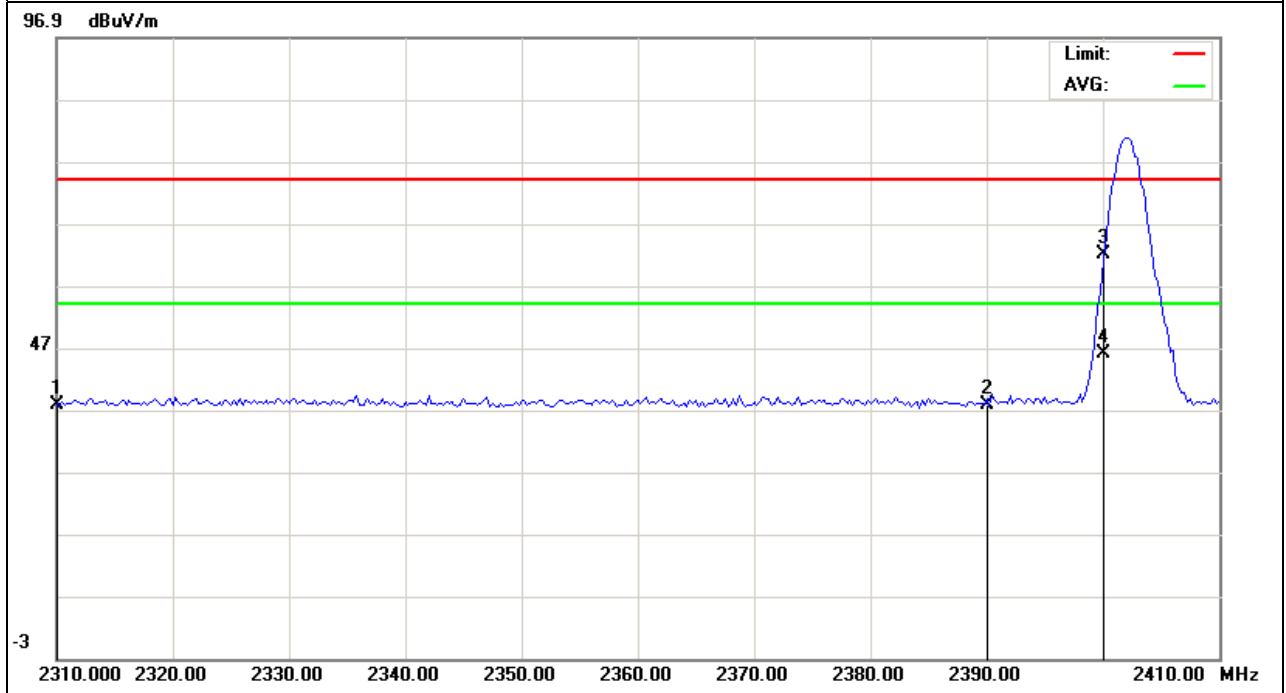

EUT :	Bluetooth Speaker	Model Name :	M59
Temperature :	20 °C	Relative Humidity :	48%
Pressure :	1010 hPa	Test Voltage :	AC 120V
Test Mode :	TX /2480MHz-1Mbps	Polarization :	Vertical

Frequency (MHz)	Meter Reading (dBμV)	Factor (dB)	Emission Level (dBμV/m)	Limits (dBμV/m)	Margin (dB)	Detector Type
2483.500	56.68	-12.78	43.90	74.00	-30.10	peak

Remark:
 Factor = Antenna Factor + Cable Loss – Pre-amplifier.

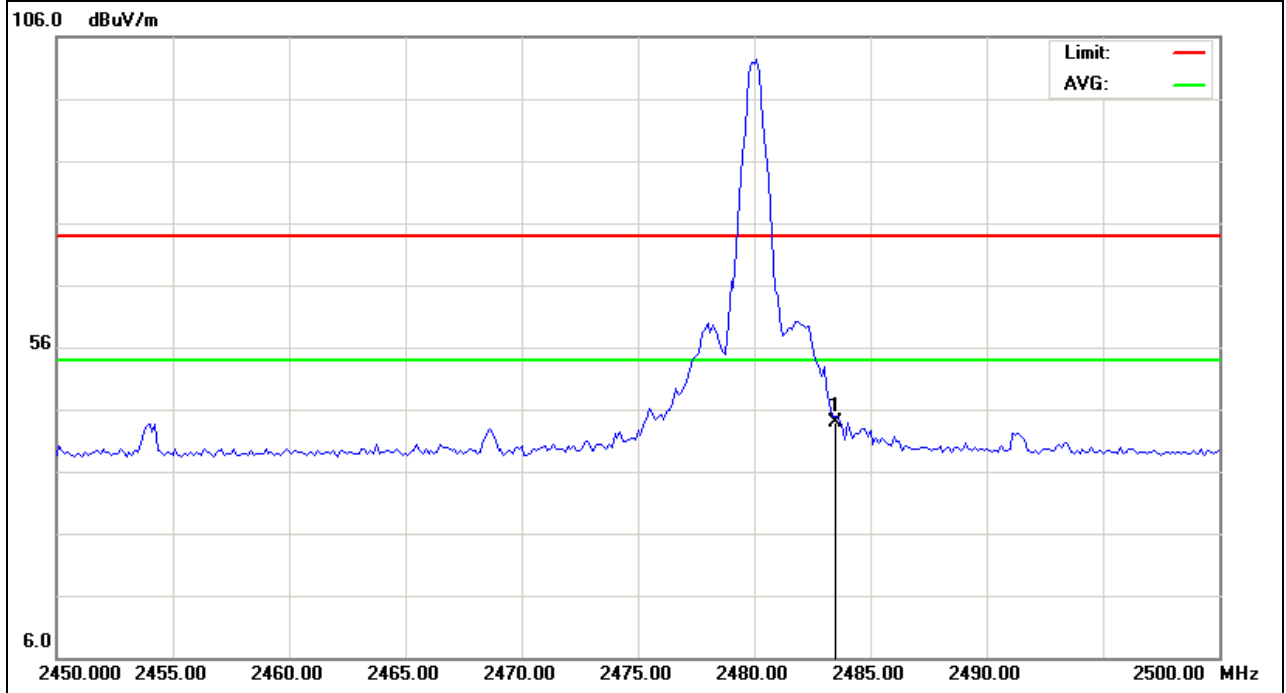

EUT :	Bluetooth Speaker	Model Name :	M59
Temperature :	20 °C	Relative Humidity :	48%
Pressure :	1010 hPa	Test Voltage :	AC 120V
Test Mode :	TX /2480MHz-1Mbps	Polarization :	Horizontal

Frequency (MHz)	Meter Reading (dBμV)	Factor (dB)	Emission Level (dBμV/m)	Limits (dBμV/m)	Margin (dB)	Detector Type
2483.500	53.68	-12.78	40.90	74.00	-33.10	peak

Remark:
Factor = Antenna Factor + Cable Loss – Pre-amplifier.

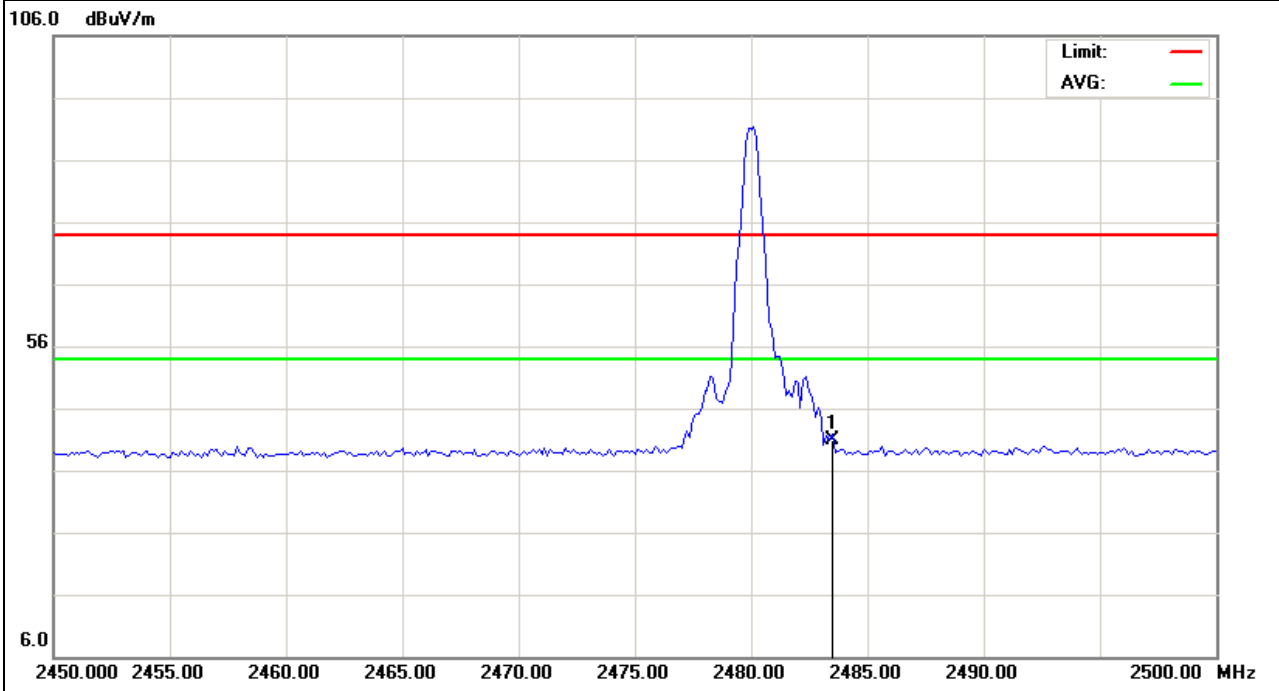

EUT :	Bluetooth Speaker	Model Name :	M59
Temperature :	20 °C	Relative Humidity :	48%
Pressure :	1010 hPa	Test Voltage :	AC 120V
Test Mode :	TX /2402MHz-2Mbps	Polarization :	Vertical

Frequency (MHz)	Meter Reading (dBμV)	Factor (dB)	Emission Level (dBμV/m)	Limits (dBμV/m)	Margin (dB)	Detector Type
2310.000	50.56	-12.89	37.67	74.00	-36.33	peak
2390.000	51.08	-13.06	38.02	74.00	-35.98	peak
2400.000	78.86	-12.99	65.87	74.00	-8.13	peak
2400.000	60.42	-12.99	47.43	54.00	-6.57	AVG

Remark:
 Factor = Antenna Factor + Cable Loss – Pre-amplifier.

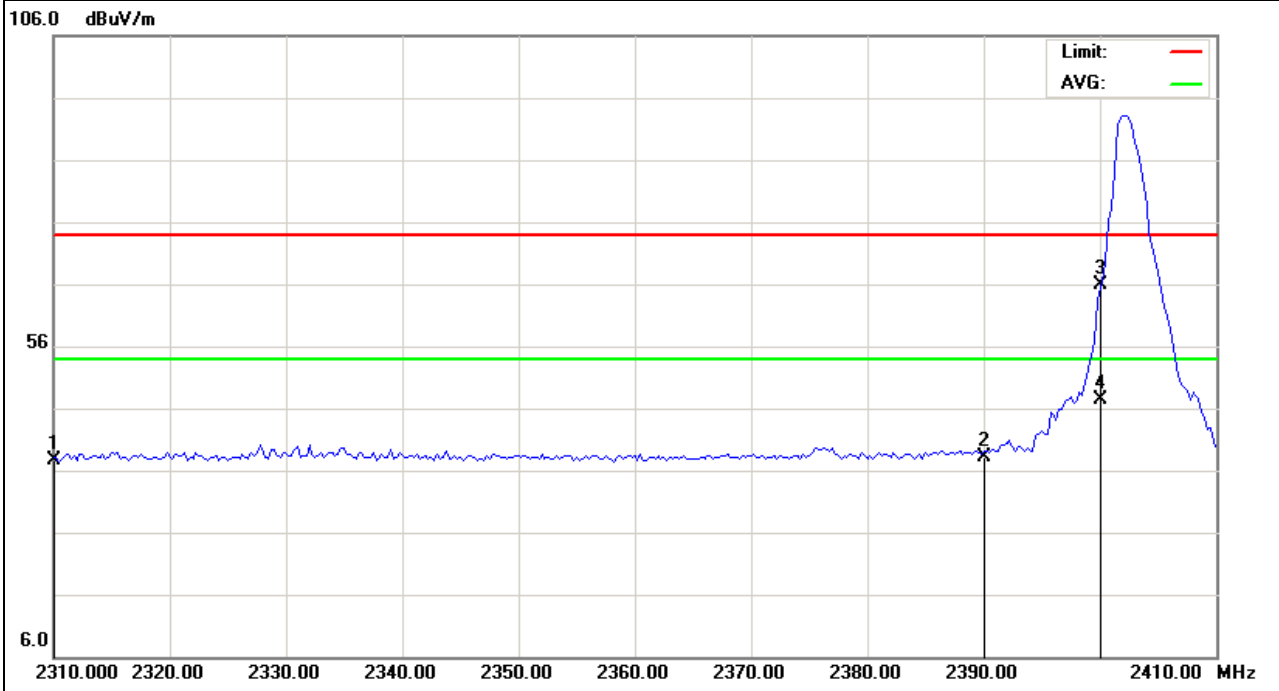

EUT :	Bluetooth Speaker	Model Name :	M59
Temperature :	20 °C	Relative Humidity :	48%
Pressure :	1010 hPa	Test Voltage :	AC 120V
Test Mode :	TX /2402MHz-2Mbps	Polarization :	Horizontal

Frequency (MHz)	Meter Reading (dBμV)	Factor (dB)	Emission Level (dBμV/m)	Limits (dBμV/m)	Margin (dB)	Detector Type
2310.000	50.56	-12.89	37.67	74.00	-36.33	peak
2390.000	50.75	-13.06	37.69	74.00	-36.31	peak
2400.000	72.89	-12.99	59.90	74.00	-14.10	peak
2400.000	56.86	-12.99	43.87	54.00	-10.13	AVG

Remark:
 Factor = Antenna Factor + Cable Loss – Pre-amplifier.

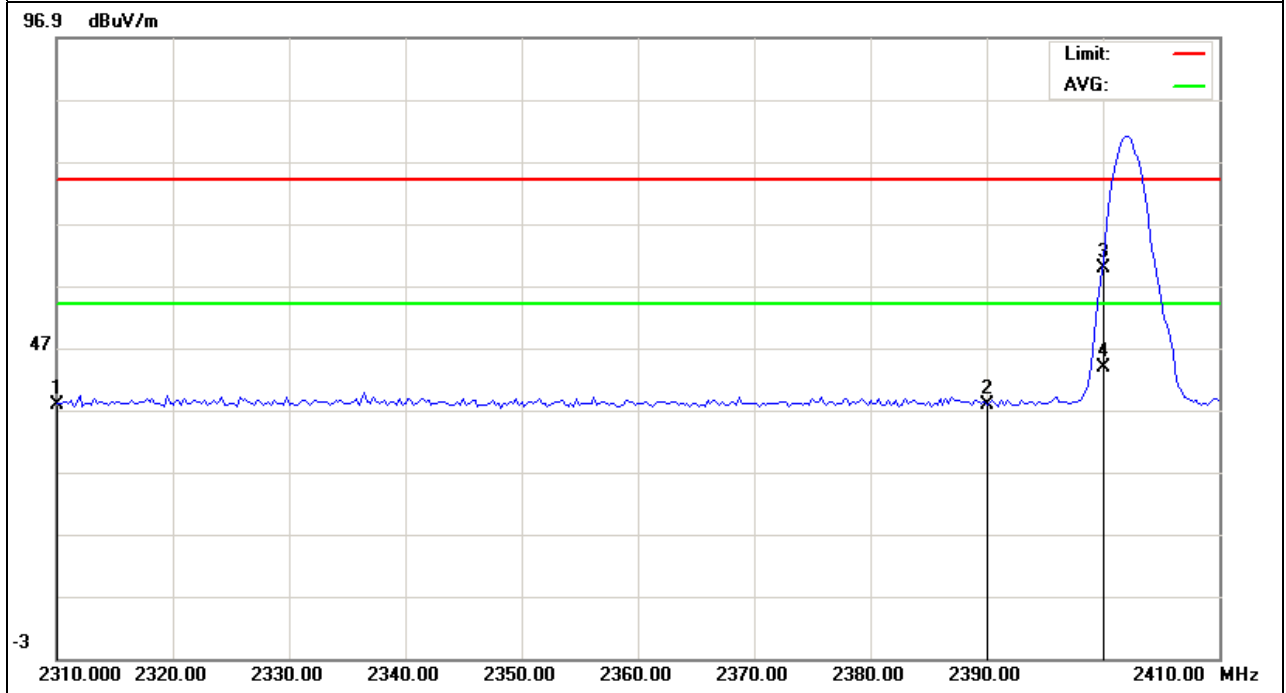

EUT :	Bluetooth Speaker	Model Name :	M59
Temperature :	20 °C	Relative Humidity :	48%
Pressure :	1010 hPa	Test Voltage :	AC 120V
Test Mode :	TX /2480MHz-2Mbps	Polarization :	Vertical

Frequency (MHz)	Meter Reading (dBμV)	Factor (dB)	Emission Level (dBμV/m)	Limits (dBμV/m)	Margin (dB)	Detector Type
2483.500	55.65	-12.78	42.87	74.00	-31.13	peak

Remark:
 Factor = Antenna Factor + Cable Loss – Pre-amplifier.

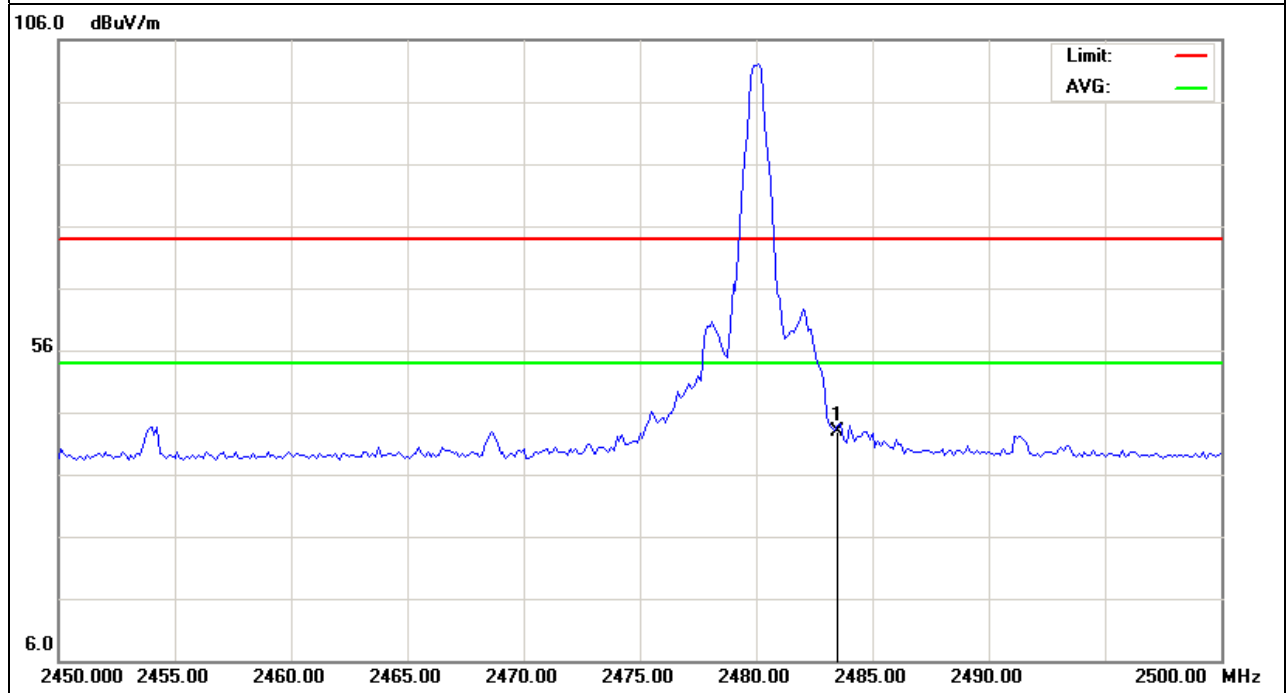

EUT :	Bluetooth Speaker	Model Name :	M59
Temperature :	20 °C	Relative Humidity :	48%
Pressure :	1010 hPa	Test Voltage :	AC 120V
Test Mode :	TX /2480MHz-2Mbps	Polarization :	Horizontal

Frequency (MHz)	Meter Reading (dBμV)	Factor (dB)	Emission Level (dBμV/m)	Limits (dBμV/m)	Margin (dB)	Detector Type
2483.500	51.56	-12.78	38.78	74.00	-35.22	peak

Remark:
 Factor = Antenna Factor + Cable Loss – Pre-amplifier.

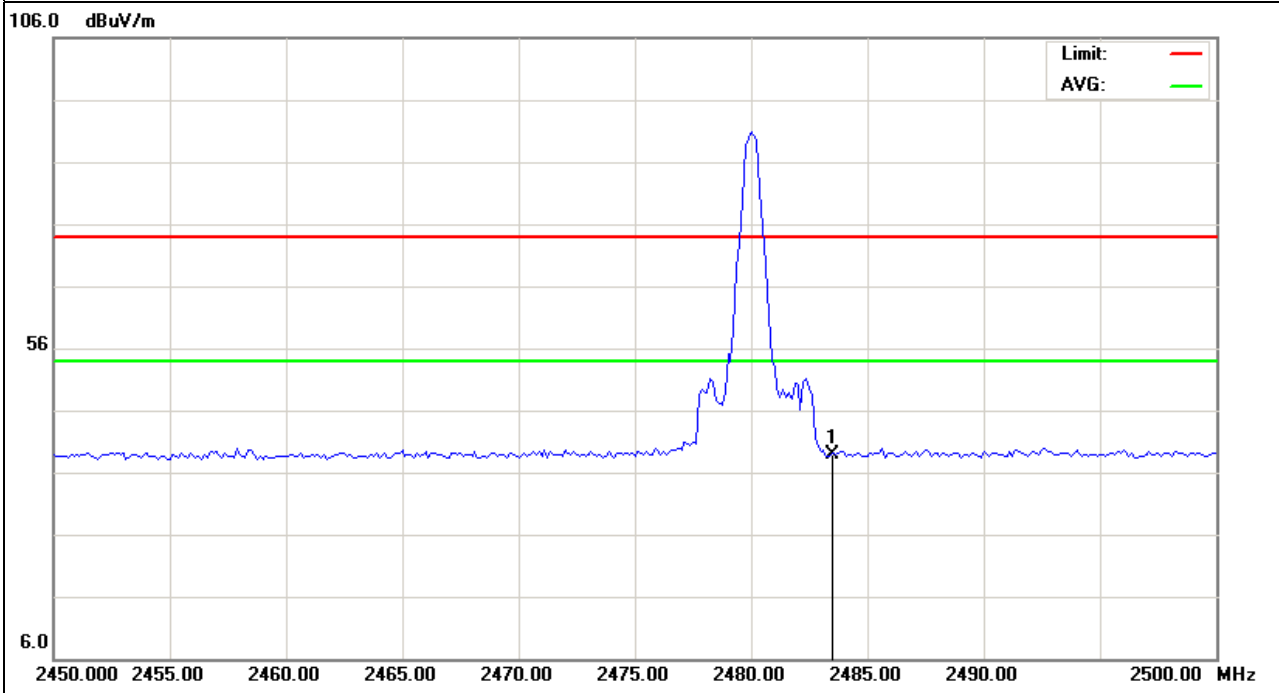

EUT :	Bluetooth Speaker	Model Name :	M59
Temperature :	20 °C	Relative Humidity :	48%
Pressure :	1010 hPa	Test Voltage :	AC 120V
Test Mode :	TX /2402MHz-3Mbps	Polarization :	Vertical

Frequency (MHz)	Meter Reading (dBμV)	Factor (dB)	Emission Level (dBμV/m)	Limits (dBμV/m)	Margin (dB)	Detector Type
2310.000	50.12	-12.89	37.23	74.00	-36.77	peak
2390.000	52.86	-13.06	39.80	74.00	-34.20	peak
2400.000	79.24	-12.99	66.25	74.00	-7.75	peak
2400.000	59.89	-12.99	46.90	54.00	-7.10	AVG

Remark:
 Factor = Antenna Factor + Cable Loss – Pre-amplifier.

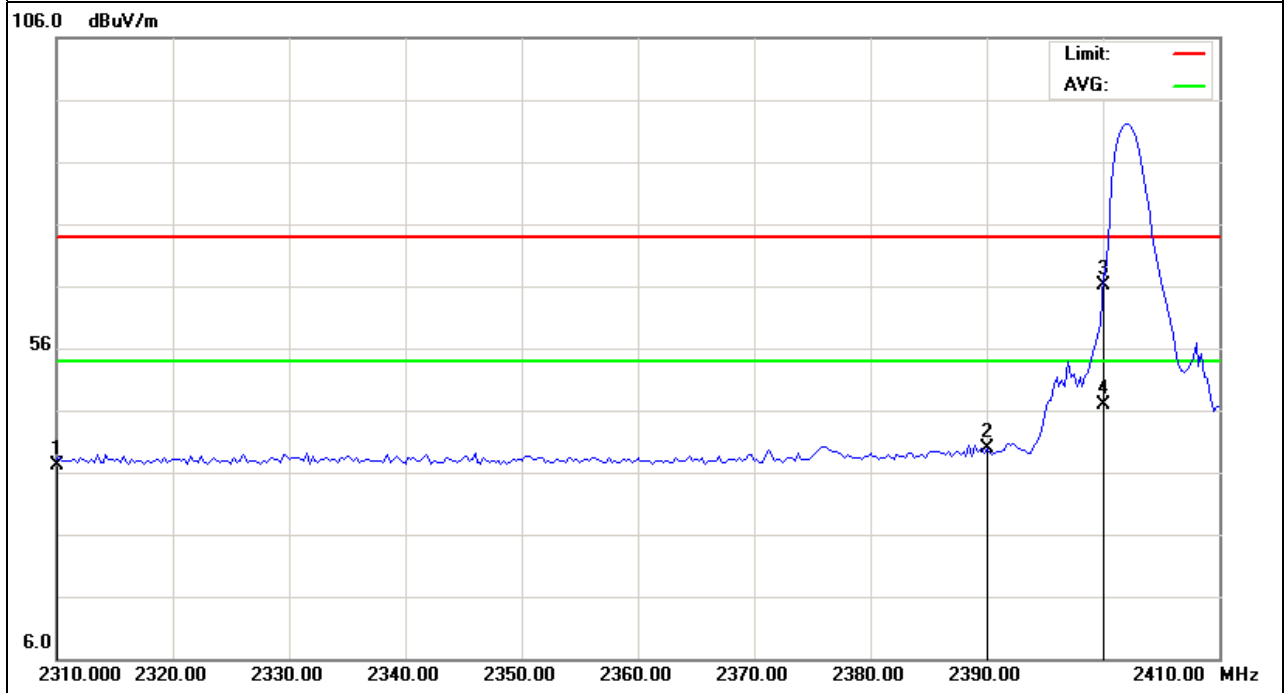

EUT :	Bluetooth Speaker	Model Name :	M59
Temperature :	20 °C	Relative Humidity :	48%
Pressure :	1010 hPa	Test Voltage :	AC 120V
Test Mode :	TX /2402MHz-3Mbps	Polarization :	Horizontal

Frequency (MHz)	Meter Reading (dBμV)	Factor (dB)	Emission Level (dBμV/m)	Limits (dBμV/m)	Margin (dB)	Detector Type
2310.000	50.49	-12.89	37.60	74.00	-36.40	peak
2390.000	51.56	-13.06	38.50	74.00	-35.50	peak
2400.000	74.46	-12.99	61.47	74.00	-12.53	peak
2400.000	58.07	-12.99	45.08	54.00	-8.92	AVG

Remark:
 Factor = Antenna Factor + Cable Loss – Pre-amplifier.

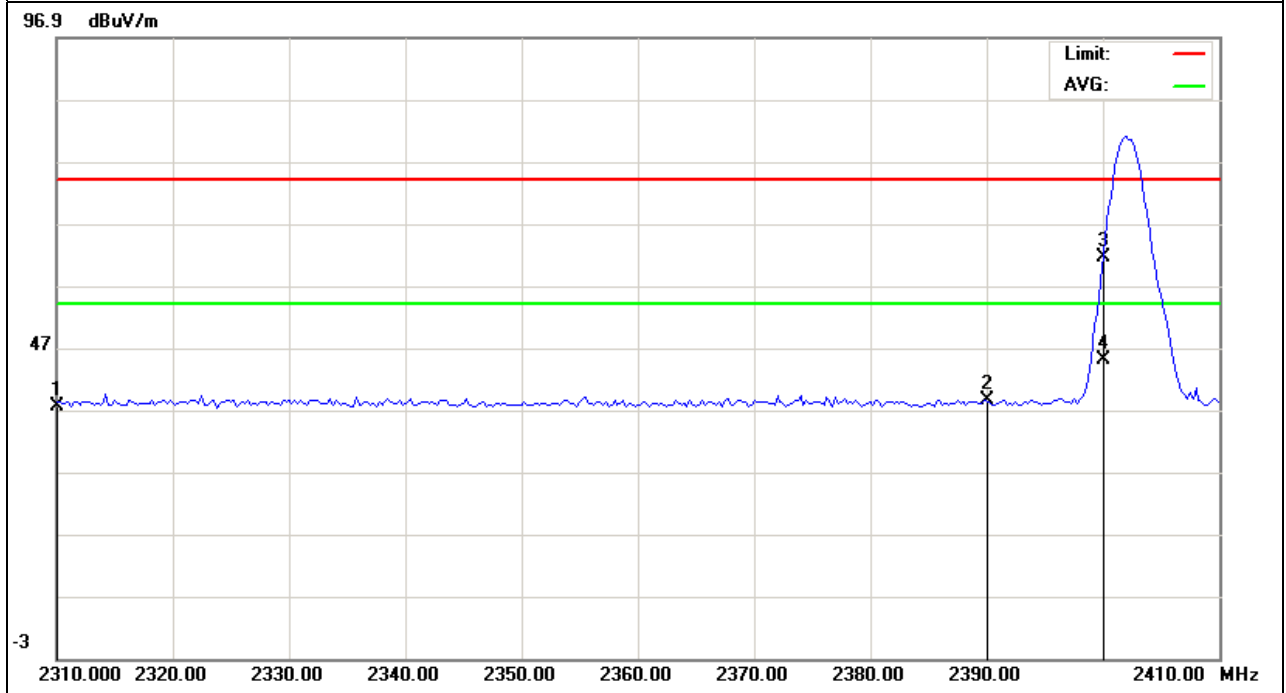

EUT :	Bluetooth Speaker	Model Name :	M59
Temperature :	20 °C	Relative Humidity :	48%
Pressure :	1010 hPa	Test Voltage :	AC 120V
Test Mode :	TX /2480MHz-3Mbps	Polarization :	Vertical

Frequency (MHz)	Meter Reading (dBμV)	Factor (dB)	Emission Level (dBμV/m)	Limits (dBμV/m)	Margin (dB)	Detector Type
2483.500	56.75	-12.78	43.97	74.00	-30.03	peak

Remark:
Factor = Antenna Factor + Cable Loss – Pre-amplifier.

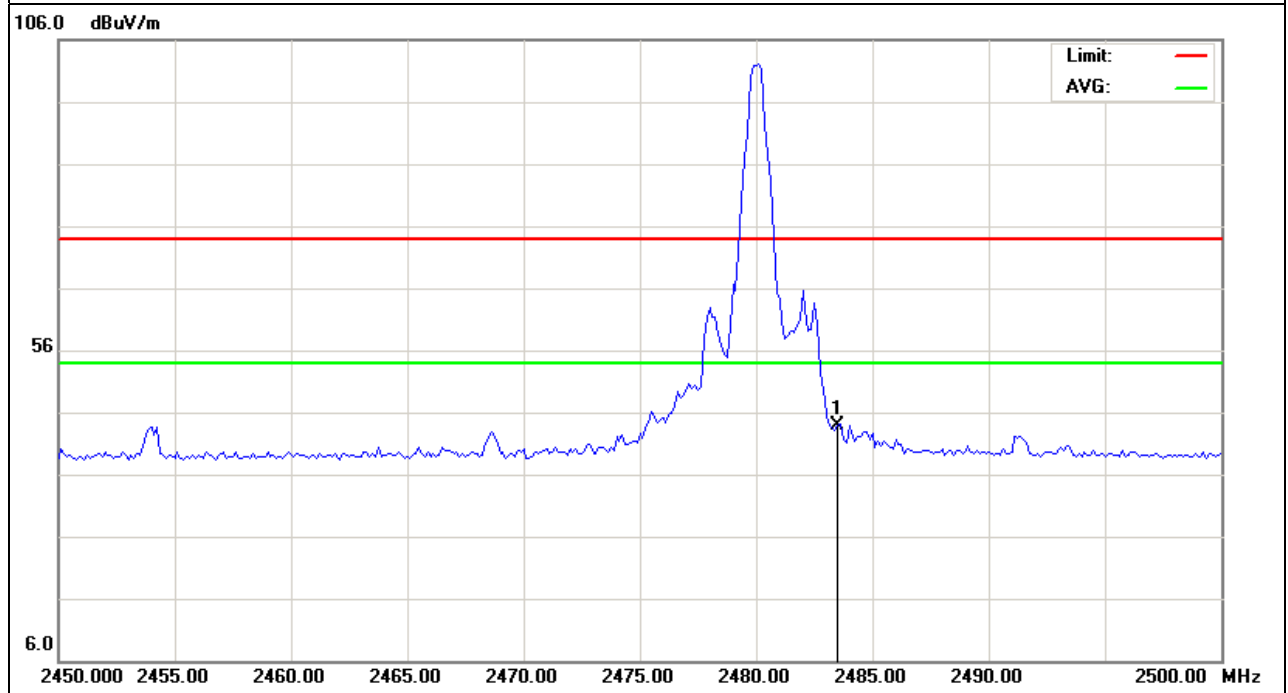

EUT :	Bluetooth Speaker	Model Name :	M59
Temperature :	20 °C	Relative Humidity :	48%
Pressure :	1010 hPa	Test Voltage :	AC 120V
Test Mode :	TX /2480MHz-3Mbps	Polarization :	Horizontal

Frequency (MHz)	Meter Reading (dBμV)	Factor (dB)	Emission Level (dBμV/m)	Limits (dBμV/m)	Margin (dB)	Detector Type
2483.500	51.79	-12.78	39.01	74.00	-34.99	peak

Remark:
 Factor = Antenna Factor + Cable Loss – Pre-amplifier.

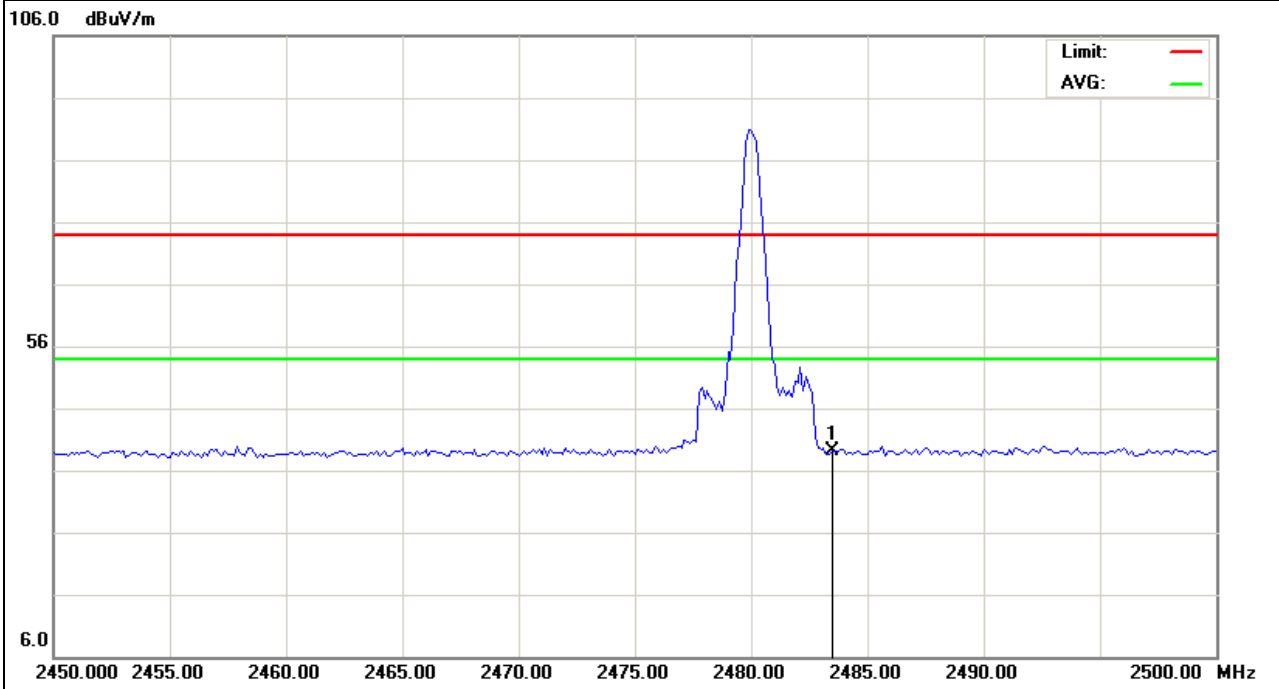

4. NUMBER OF HOPPING CHANNEL

4.1 APPLIED PROCEDURES / LIMIT

FCC Part15 (15.247) , Subpart C				
Section	Test Item	Limit	Frequency Range (MHz)	Result
15.247 (a)(1)(iii)	Number of Hopping Channel	≥15	2400-2483.5	PASS

Spectrum Parameters	Setting
Attenuation	Auto
Span Frequency	= the frequency band of operation
RB	RBW ≥ 1% of the span
VB	VBW ≥ RBW
Detector	Peak
Trace	Max Hold
Sweep Time	Auto

4.1.1 TEST PROCEDURE

- a. The EUT was directly connected to the spectrum analyzer and antenna output port as show in the block diagram below,
- b. Spectrum Setting : RBW= 1MHz, VBW=3MHz, Sweep time = Auto.

4.1.2 DEVIATION FROM STANDARD

No deviation.

4.1.3 TEST SETUP



4.1.4 EUT OPERATION CONDITIONS

The EUT tested system was configured as the statements of 2.4 Unless otherwise a special operating condition is specified in the follows during the testing.

4.1.5 TEST RESULTS

EUT :	Bluetooth Speaker	Model Name :	M59
Temperature :	25 °C	Relative Humidity :	60%
Pressure :	1015 hPa	Test Voltage :	AC 120V
Test Mode :	Hopping Mode		

Number of Hopping Channel	79
---------------------------	----

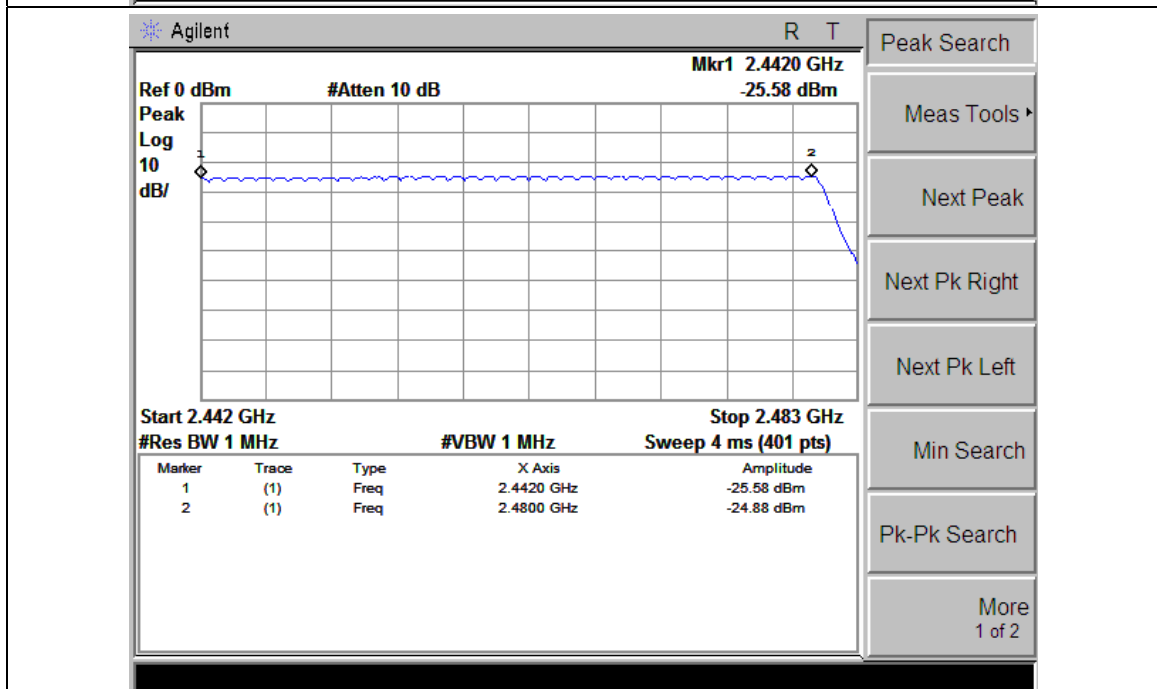
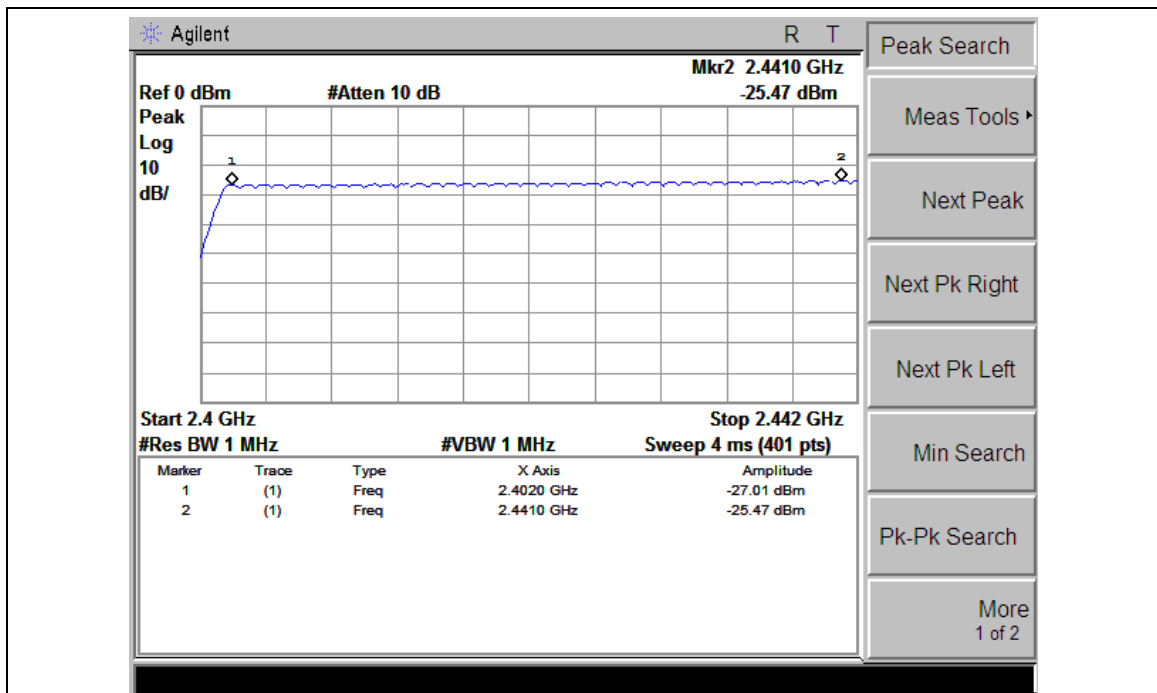

5. AVERAGE TIME OF OCCUPANCY

5.1 APPLIED PROCEDURES / LIMIT

FCC Part15 (15.247) , Subpart C				
Section	Test Item	Limit	Frequency Range (MHz)	Result
15.247 (a)(1)(iii)	Average Time of Occupancy	0.4sec	2400-2483.5	PASS

5.1.1 TEST PROCEDURE

- a. The transmitter output (antenna port) was connected to the spectrum analyzer
- b. Set RBW of spectrum analyzer to 1MHz and VBW to 1MHz.
- c. Use a video trigger with the trigger level set to enable triggering only on full pulses.
- d. Sweep Time is more than once pulse time.
- e. Set the center frequency on any frequency would be measure and set the frequency span to zero span.
- f. Measure the maximum time duration of one single pulse.
- g. Set the EUT for DH5, DH3 and DH1 packet transmitting.
- h. Measure the maximum time duration of one single pulse.
- i. A Period Time = (channel number)*0.4
 DH1 Time Slot: Reading * (1600/2)*31.6/(channel number)
 DH3 Time Slot: Reading * (1600/4)*31.6/(channel number)
 DH5 Time Slot: Reading * (1600/6)*31.6/(channel number)

5.1.2 DEVIATION FROM STANDARD

No deviation.

5.1.3 TEST SETUP



5.1.4 EUT OPERATION CONDITIONS

The EUT tested system was configured as the statements of 2.4 Unless otherwise a special operating condition is specified in the follows during the testing.

5.1.5 TEST RESULTS

EUT :	Bluetooth Speaker	Model Name :	M59
Temperature :	25 °C	Relative Humidity :	60%
Pressure :	1012 hPa	Test Voltage :	AC 120V
Test Mode :	CH39-DH5 ,2DH5,3DH5		

Data Packet	Frequency	Pulse Duration (ms)	Dwell Time (s)	Limits (s)
DH5	2441 MHz	2.95	0.315	0.4
2DH5	2441 MHz	2.95	0.315	0.4
3DH5	2441 MHz	2.96	0.316	0.4

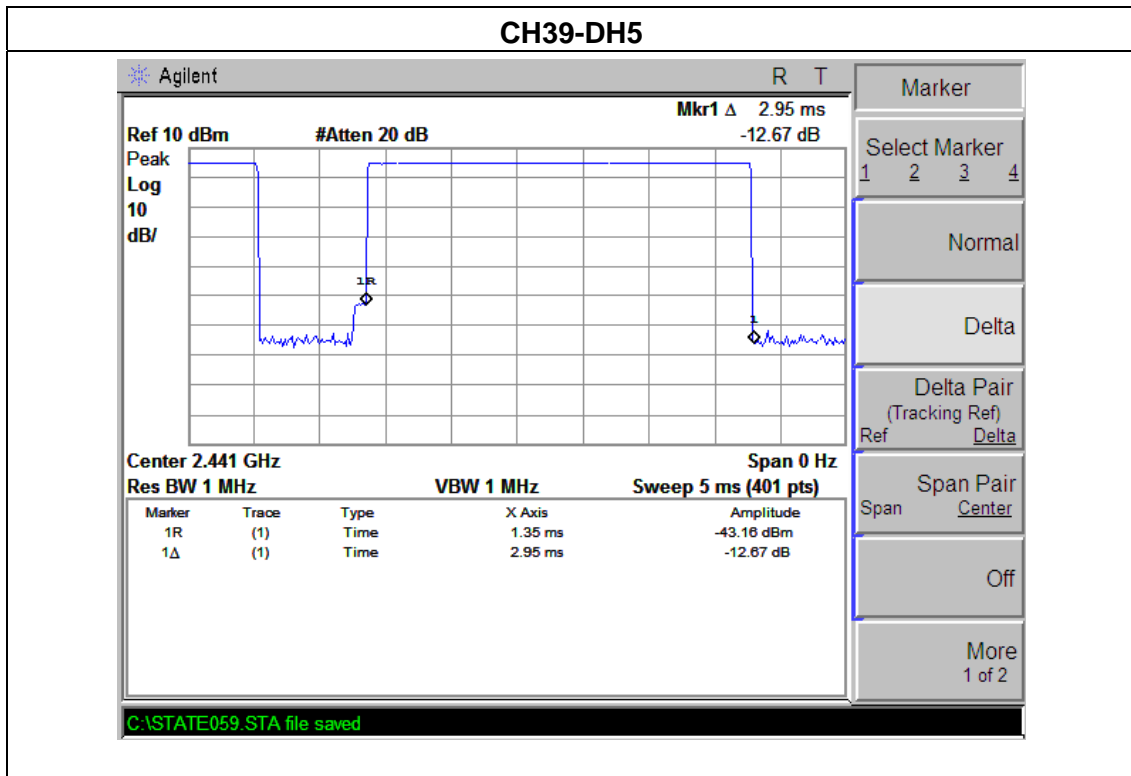

CH39-2DH5

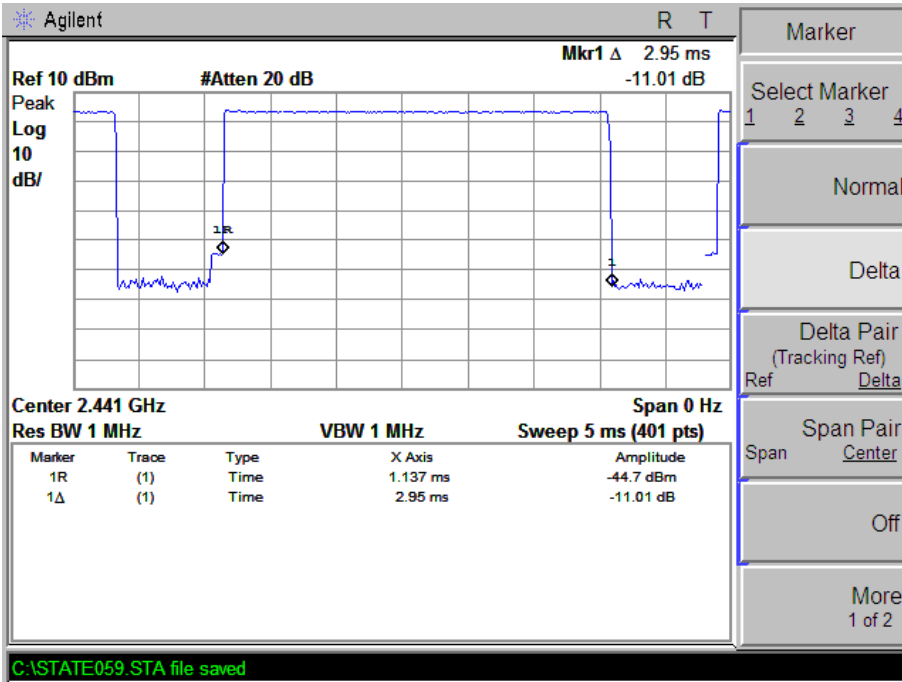

CH39-3DH5

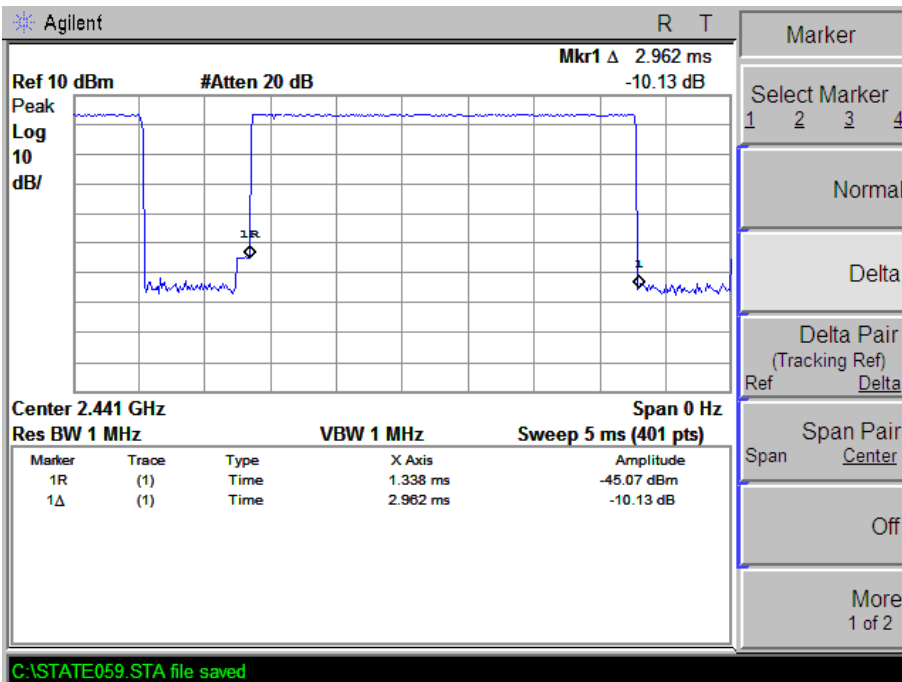

EUT :	Bluetooth Speaker	Model Name :	M59
Temperature :	25 °C	Relative Humidity :	60%
Pressure :	1012 hPa	Test Voltage :	AC 120V
Test Mode :	CH39-DH3,2DH3,3DH3		

Data Packet	Frequency	Pulse Duration (ms)	Dwell Time (s)	Limits (s)
DH3	2441 MHz	1.725	0.276	0.4
2DH3	2441 MHz	1.700	0.272	0.4
3DH3	2441 MHz	1.71	0.274	0.4

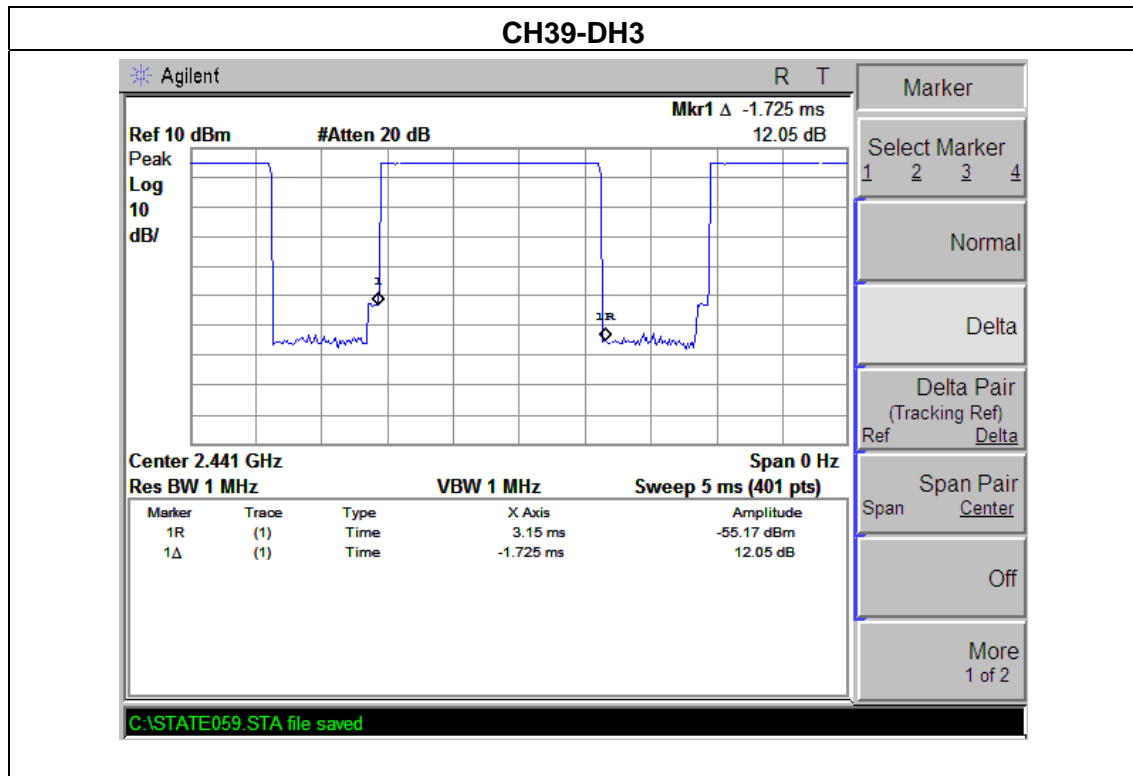

CH39-2DH3

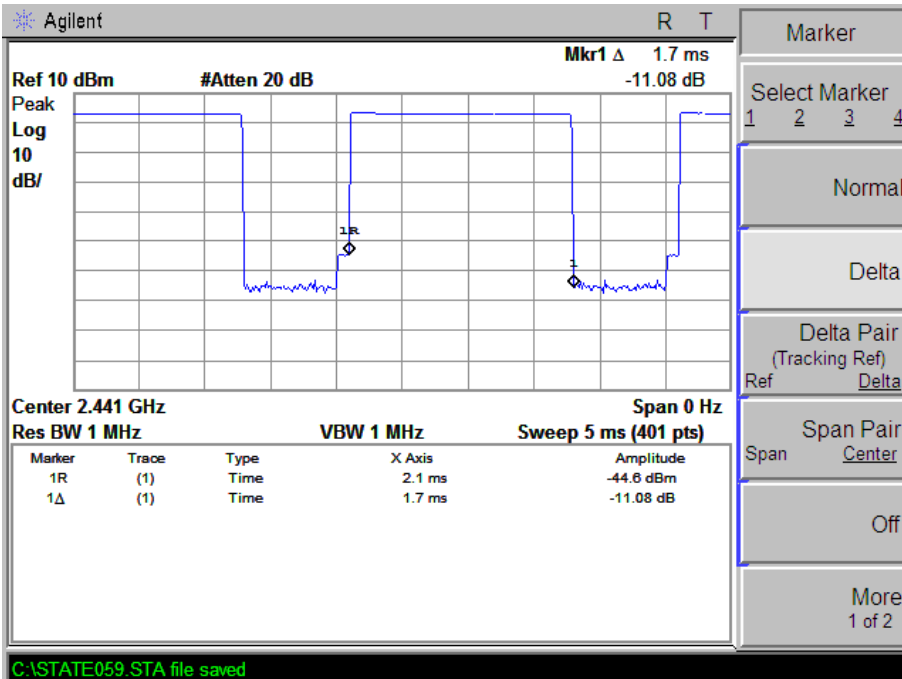

CH39-3DH3

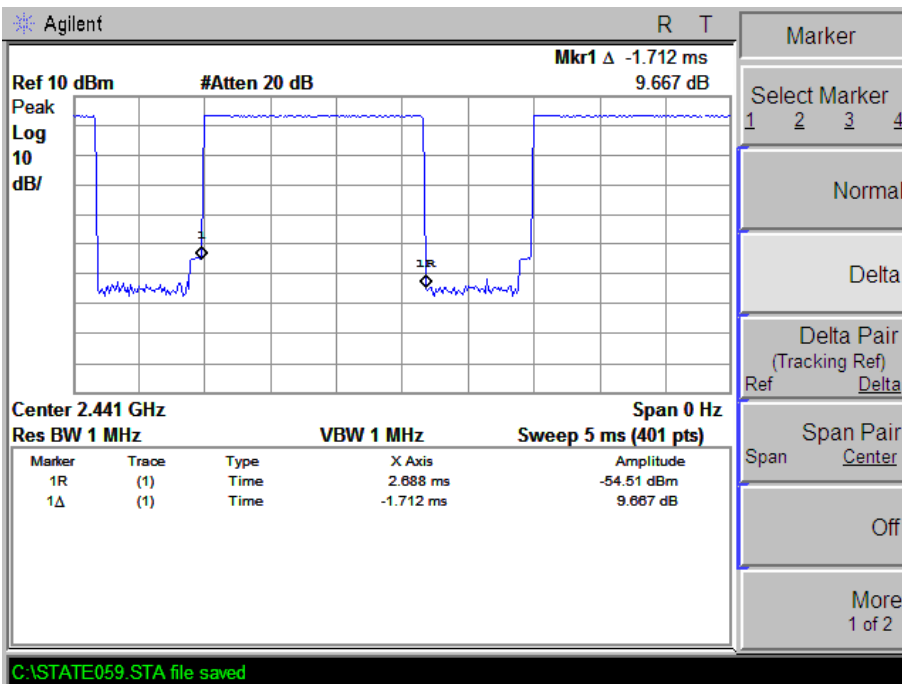

EUT :	Bluetooth Speaker	Model Name :	M59
Temperature :	25 °C	Relative Humidity :	60%
Pressure :	1012 hPa	Test Voltage :	AC 120V
Test Mode :	CH39-DH1,2DH1,3DH1		

Data Packet	Frequency	Pulse Duration (ms)	Dwell Time (s)	Limits (s)
DH1	2441 MHz	0.4875	0.16	0.4
2DH1	2441 MHz	0.4500	0.14	0.4
3DH1	2441 MHz	0.4625	0.15	0.4

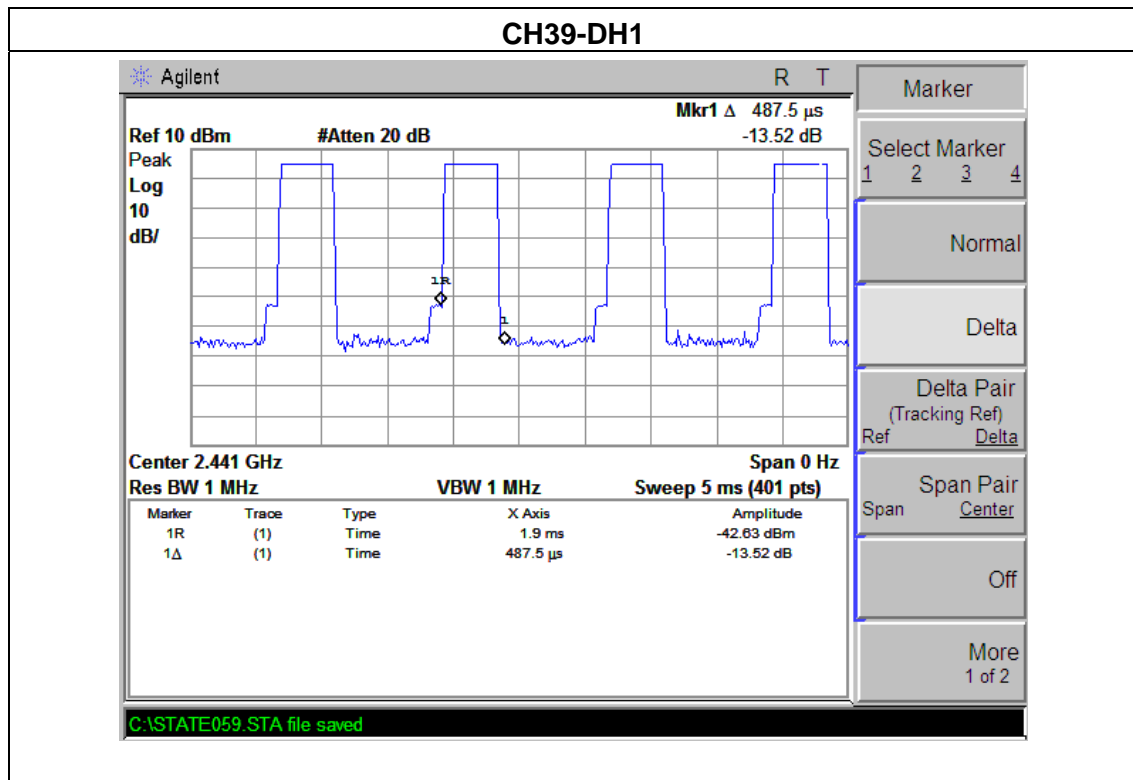

CH39-2DH1

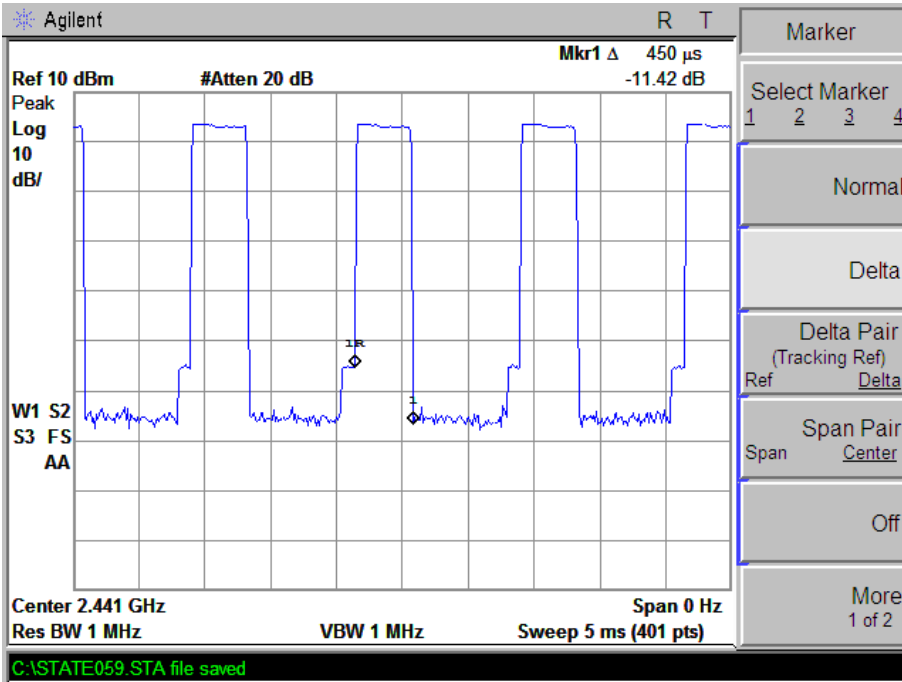

Marker

Select Marker 1 2 3 4

Normal

Delta

Delta Pair (Tracking Ref) Ref Delta

Span Pair Span Center

Off

More 1 of 2

CH39-3DH1

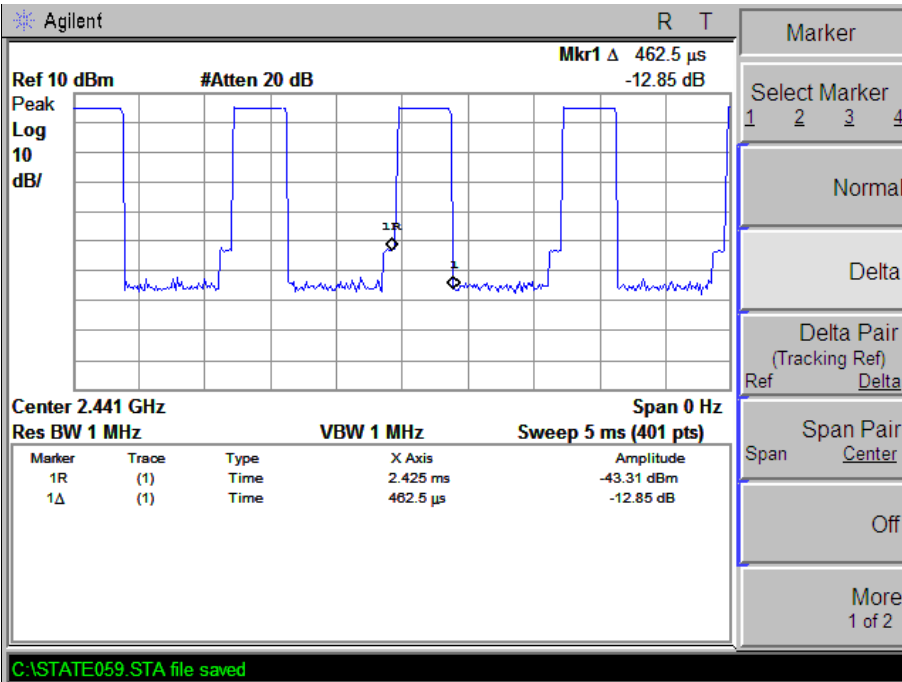

Marker

Select Marker 1 2 3 4

Normal

Delta

Delta Pair (Tracking Ref) Ref Delta

Span Pair Span Center

Off

More 1 of 2

6. HOPPING CHANNEL SEPARATION MEASUREMENT

6.1 APPLIED PROCEDURES / LIMIT

Frequency hopping systems operating in the 2400-2483.5 MHz band may have hopping channel carrier frequencies that are separated by 25 kHz or two-thirds of the 20 dB bandwidth of the hopping channel, whichever is greater.

Spectrum Parameter	Setting
Attenuation	Auto
Span Frequency	wide enough to capture the peaks of two adjacent channels
RB	$\geq 1\%$ of the span
VB	\geq RBW
Detector	Peak
Trace	Max Hold
Sweep Time	Auto

6.1.1 TEST PROCEDURE

- a. The transmitter output (antenna port) was connected to the spectrum analyser in peak hold mode.
- b. The resolution bandwidth of 30 kHz and the video bandwidth of 30 kHz were utilised for channel separation measurement.

6.1.2 DEVIATION FROM STANDARD

No deviation.

6.1.3 TEST SETUP

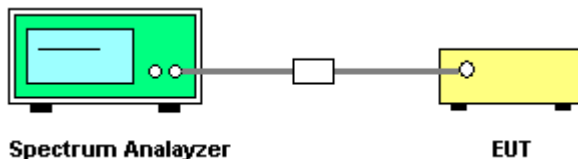

6.1.4 EUT OPERATION CONDITIONS

The EUT was programmed to be in continuously transmitting mode.

6.1.5 TEST RESULTS

EUT :	Bluetooth Speaker	Model Name :	M59
Temperature :	25 °C	Relative Humidity :	60%
Pressure :	1012 hPa	Test Voltage :	AC 120V
Test Mode :	CH00 / CH39 /CH78 (1Mbps Mode)		

Frequency	Ch. Separation(MHz)	Result
2402 MHz	1.005	PASS
2441 MHz	1.005	PASS
2480 MHz	1.005	PASS

Ch. Separation Limits: >3/2 of 20dB bandwidth

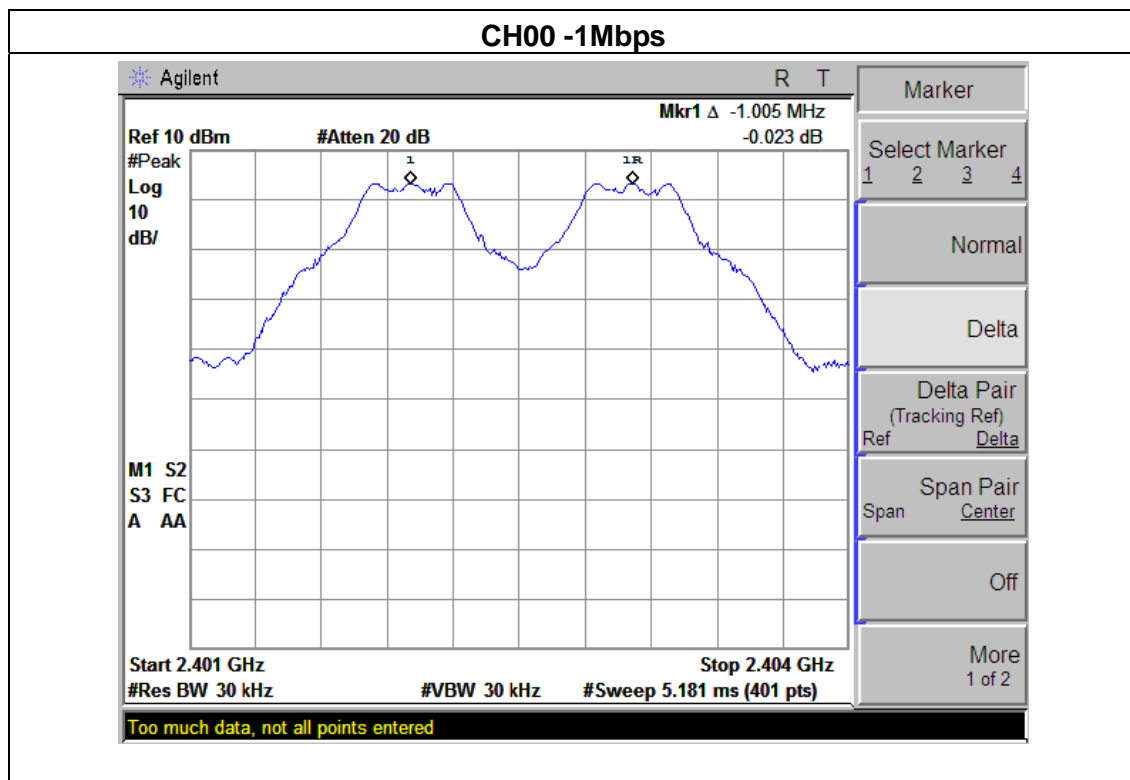

CH39 -1Mbps

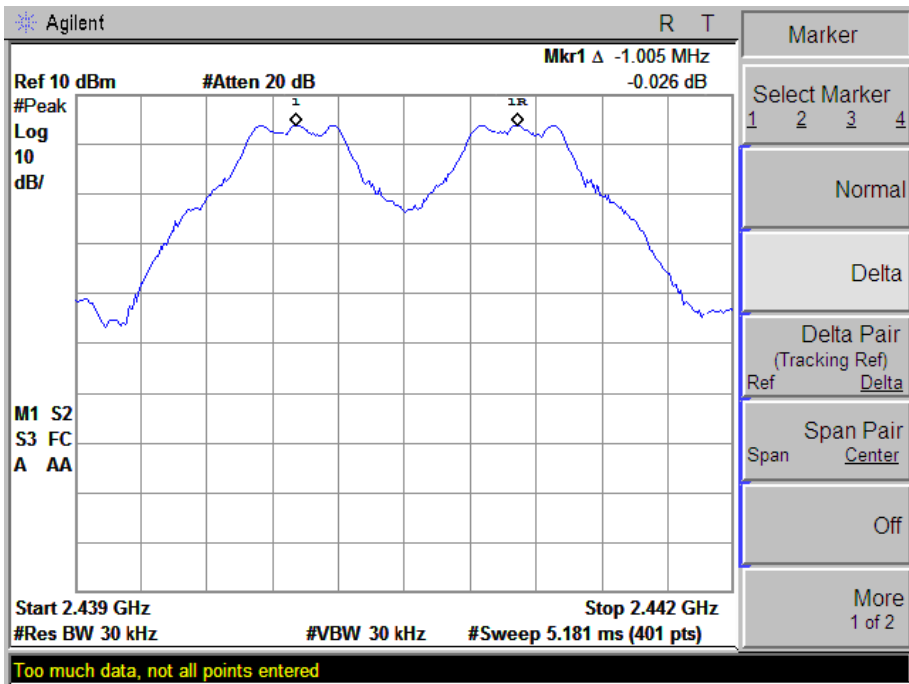

CH78 -1Mbps

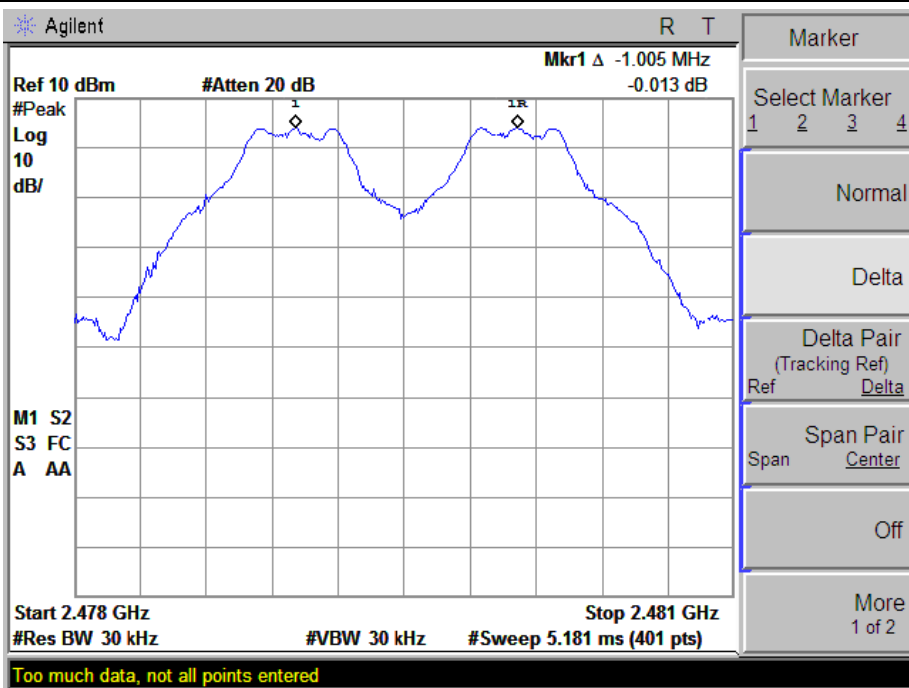

EUT :	Bluetooth Speaker	Model Name :	M59
Temperature :	25 °C	Relative Humidity :	60%
Pressure :	1012 hPa	Test Voltage :	AC 120V
Test Mode :	CH00 / CH39 /CH78 (2Mbps Mode)		

Frequency	Ch. Separation (MHz)	Limit (MHz)	Result
2402 MHz	1.005	1.152*2/3	PASS
2441 MHz	1.005	1.157*2/3	PASS
2480 MHz	1.005	1.149*2/3	PASS

Ch. Separation Limits: >2/3 of 20dB bandwidth

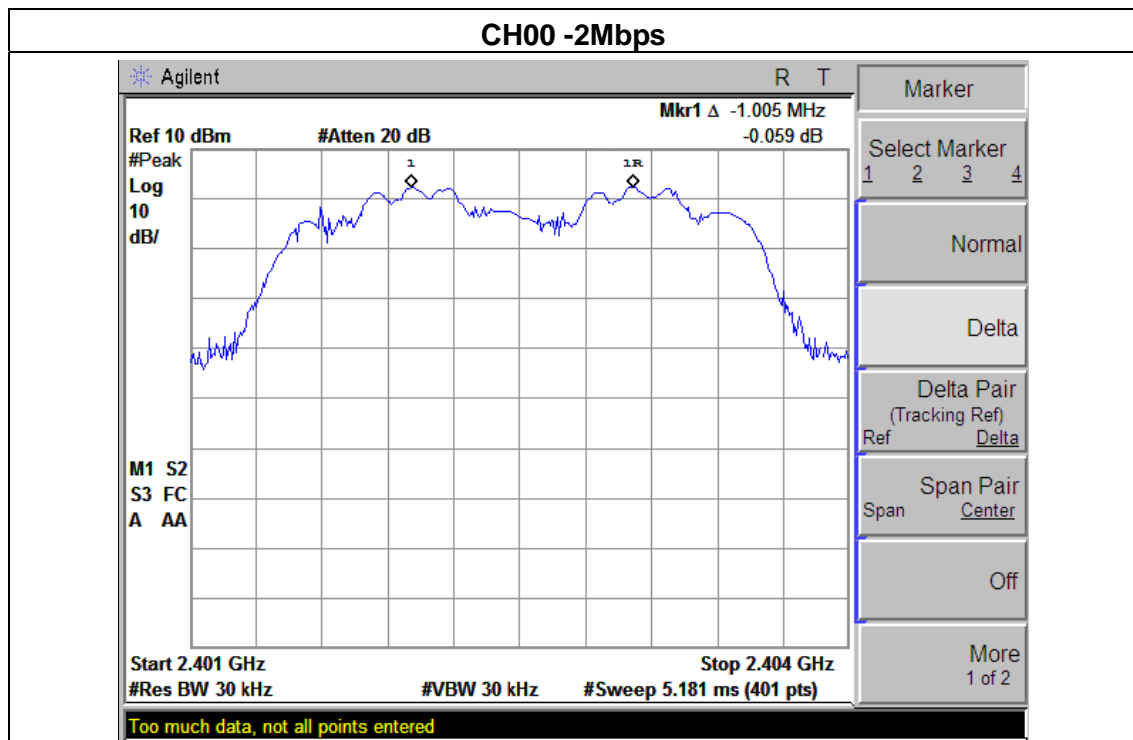

CH39 -2Mbps

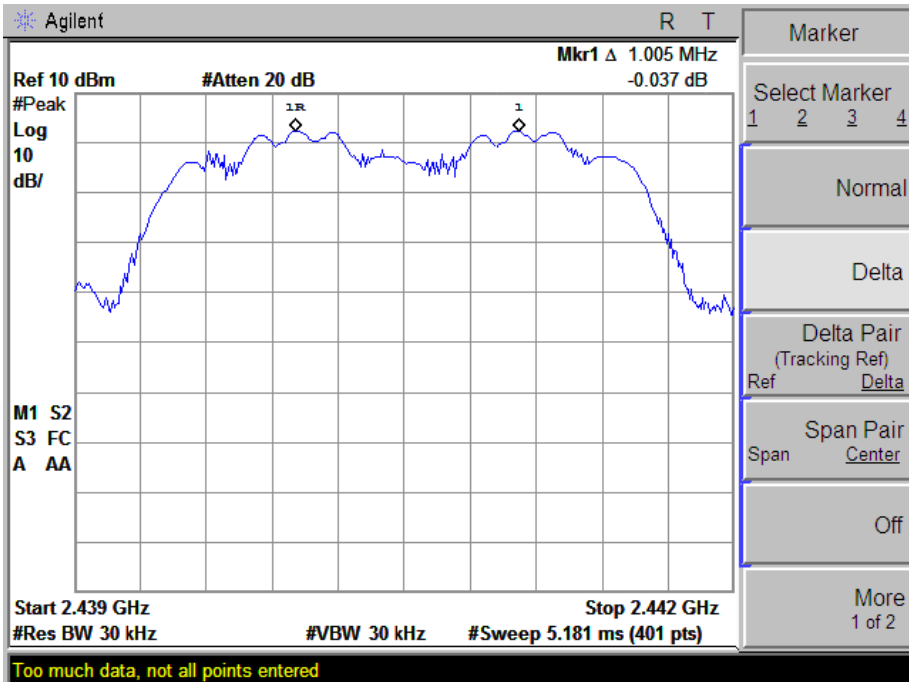

CH78 -2Mbps

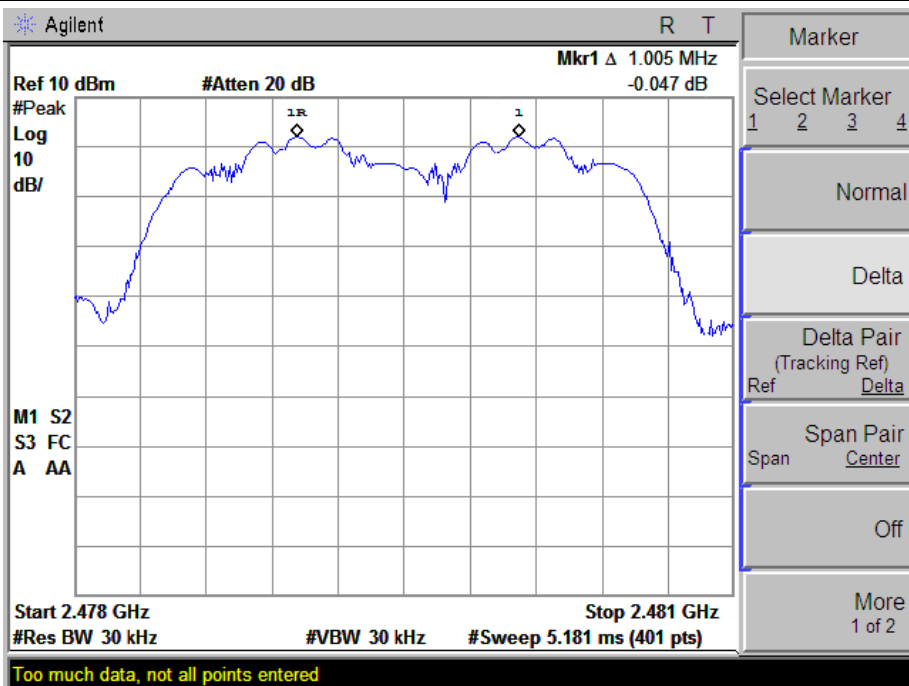

EUT :	Bluetooth Speaker	Model Name :	M59
Temperature :	25 °C	Relative Humidity :	60%
Pressure :	1012 hPa	Test Voltage :	AC 120V
Test Mode :	CH00 / CH39 /CH78 (3Mbps Mode)		

Frequency	Ch. Separation (MHz)	LIMIT (MHz)	Result
2402 MHz	1.005	1.164*2/3	PASS
2441 MHz	0.998	1.167*2/3	PASS
2480 MHz	1.005	1.161*2/3	PASS

Ch. Separation Limits: >2/3 of 20dB bandwidth

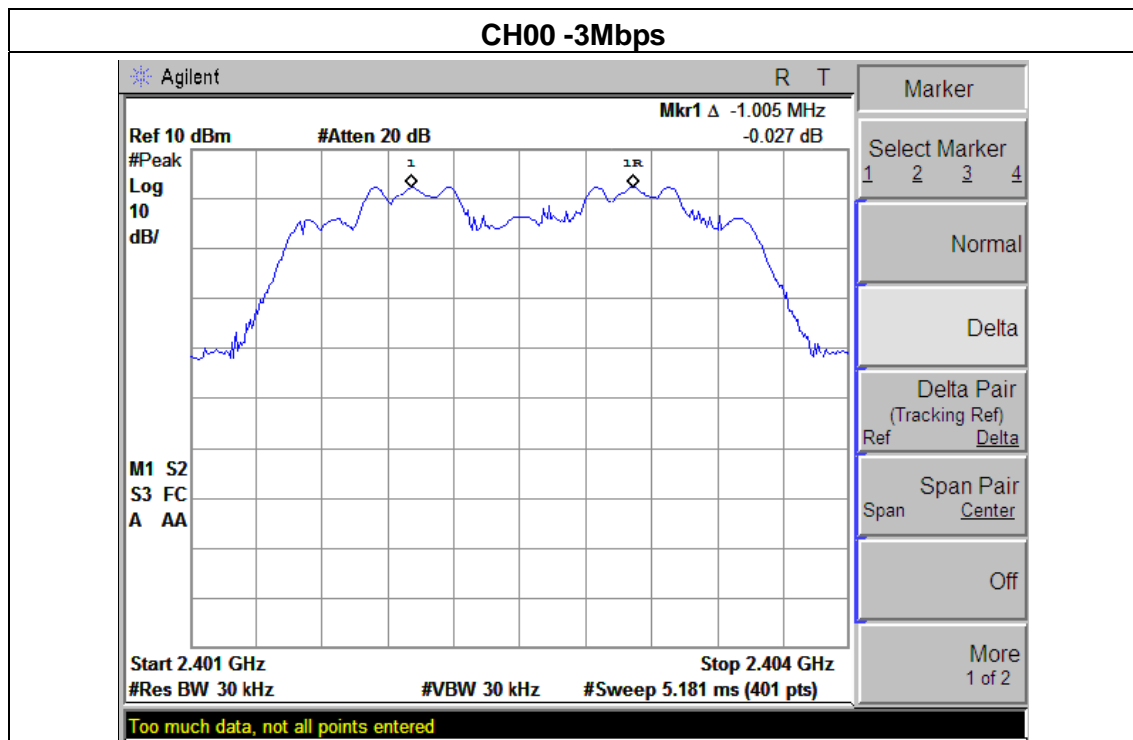

CH39 -3Mbps

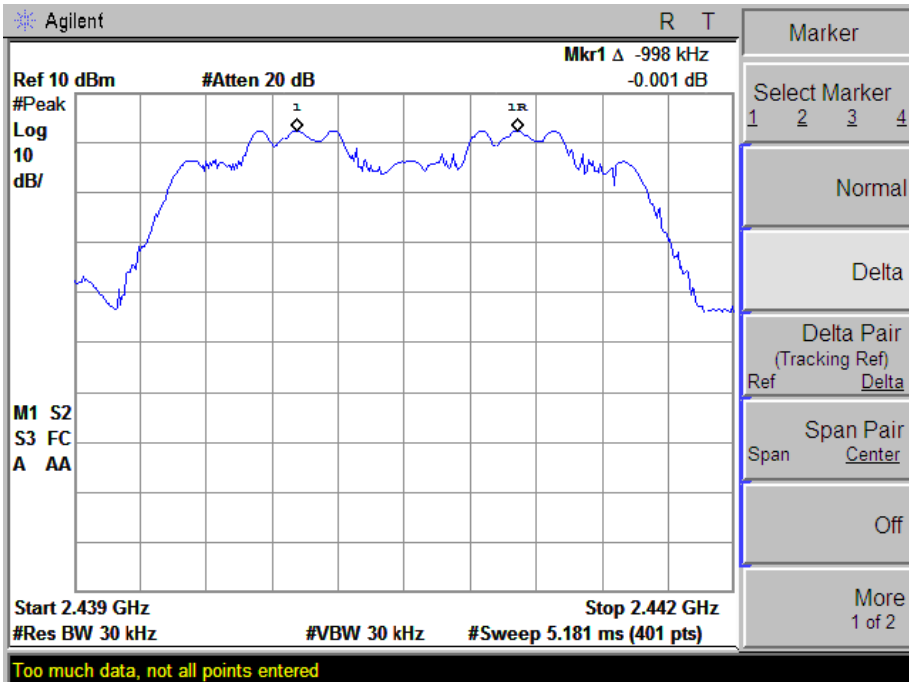

CH78 -3Mbps

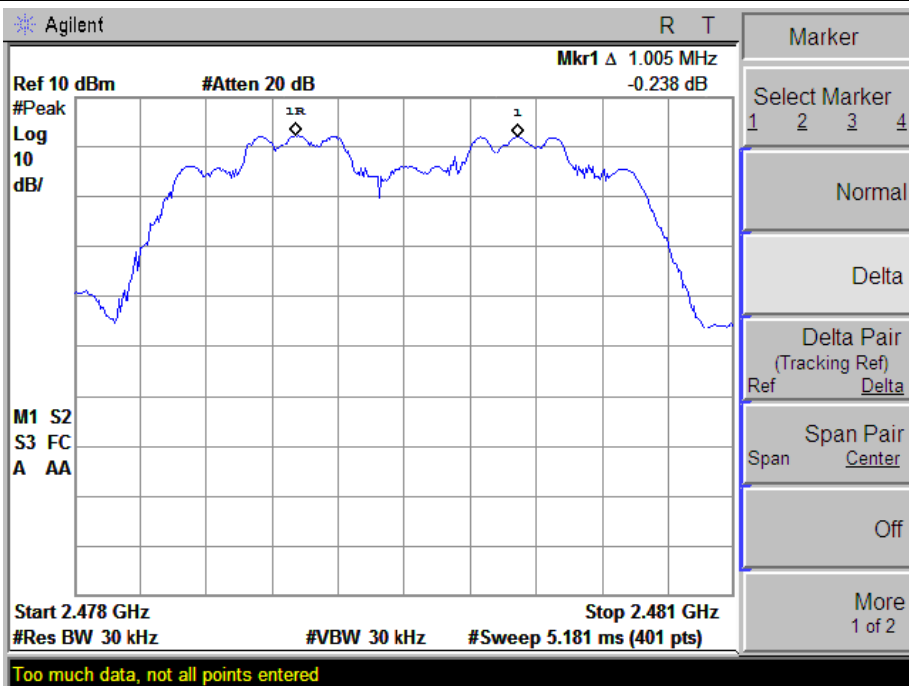

7. BANDWIDTH TEST

7.1 APPLIED PROCEDURES / LIMIT

FCC Part15 (15.247) , Subpart C				
Section	Test Item	Limit	Frequency Range (MHz)	Result
15.247 (a)(1)	Bandwidth	(20dB bandwidth)	2400-2483.5	PASS

Spectrum Parameter	Setting
Attenuation	Auto
Span Frequency	> Measurement Bandwidth or Channel Separation
RB	30 kHz
VB	100 kHz
Detector	Peak
Trace	Max Hold
Sweep Time	Auto

7.1.1 TEST PROCEDURE

- a. The EUT was directly connected to the spectrum analyzer and antenna output port as show in the block diagram below,
- b. Spectrum Setting : RBW= 30KHz, VBW=100KHz, Sweep time = Auto.

7.1.2 DEVIATION FROM STANDARD

No deviation.

7.1.3 TEST SETUP

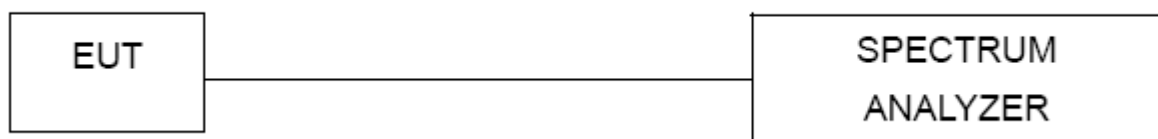

7.1.4 EUT OPERATION CONDITIONS

The EUT tested system was configured as the statements of 2.4 Unless otherwise a special operating condition is specified in the follows during the testing.

7.1.5 TEST RESULTS

EUT :	Bluetooth Speaker	Model Name :	M59
Temperature :	25 °C	Relative Humidity :	60%
Pressure :	1012 hPa	Test Voltage :	AC 120V
Test Mode :	CH00 / CH39 /C78(1Mbps)		

Frequency	20dB Bandwidth (kHz)	Result
2402 MHz	796.195	PASS
2441 MHz	734.692	PASS
2480 MHz	801.635	PASS

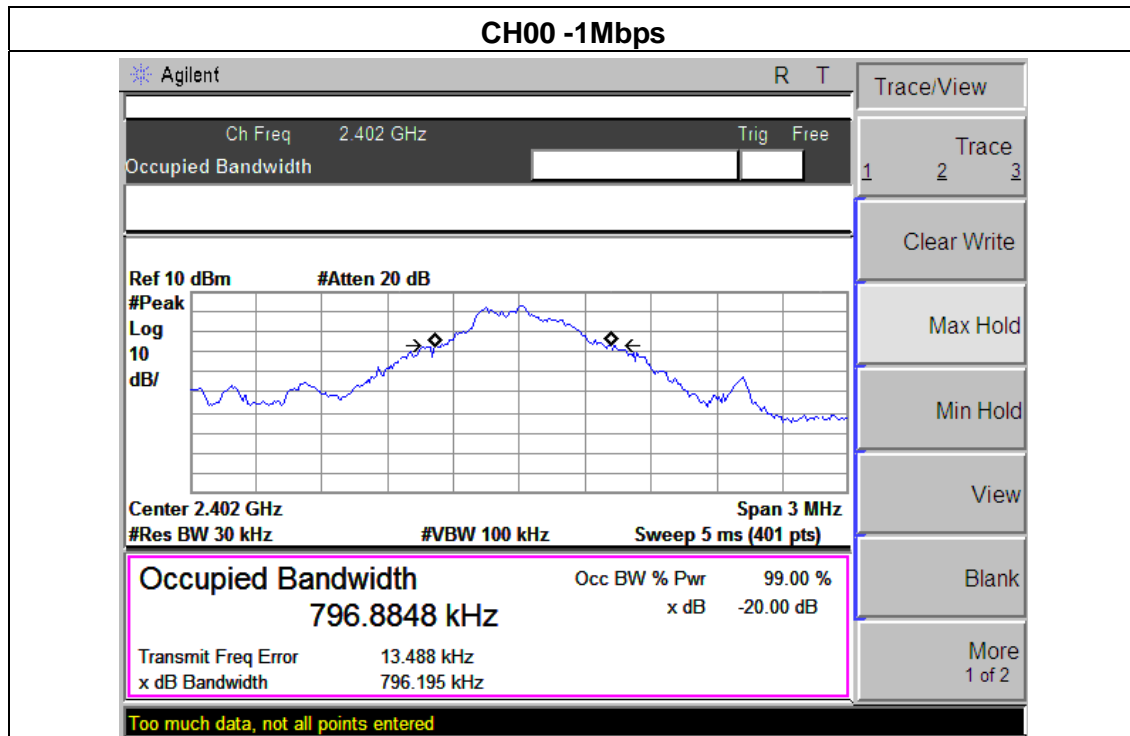

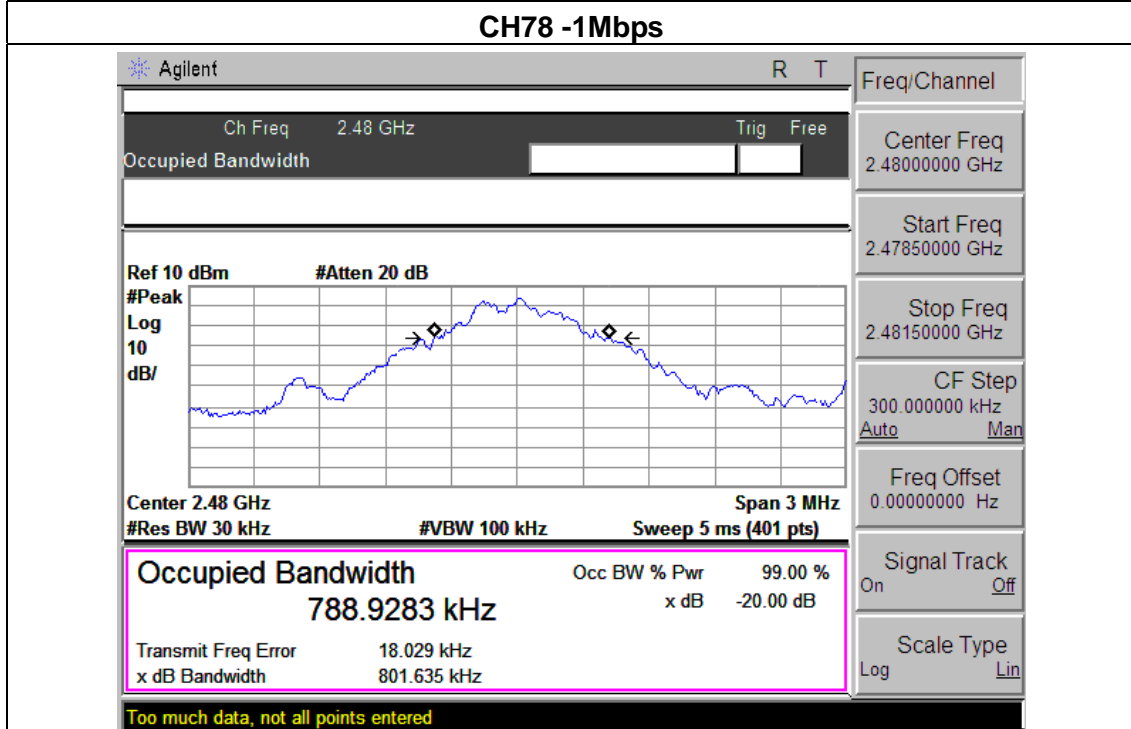
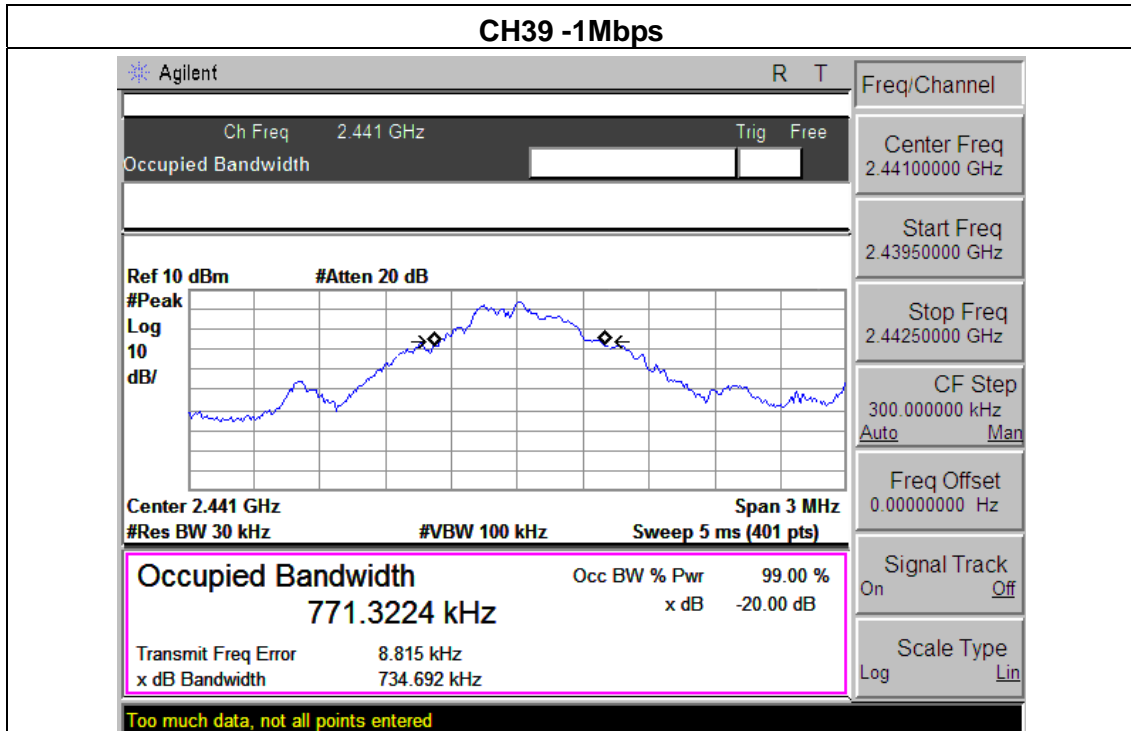

EUT :	Bluetooth Speaker	Model Name :	M59
Temperature :	25 °C	Relative Humidity :	60%
Pressure :	1012 hPa	Test Voltage :	AC 120V
Test Mode :	CH00 / CH39 /C78(2Mbps)		

Frequency	20dB Bandwidth (MHz)	Result
2402 MHz	1.152	PASS
2441 MHz	1.157	PASS
2480 MHz	1.149	PASS

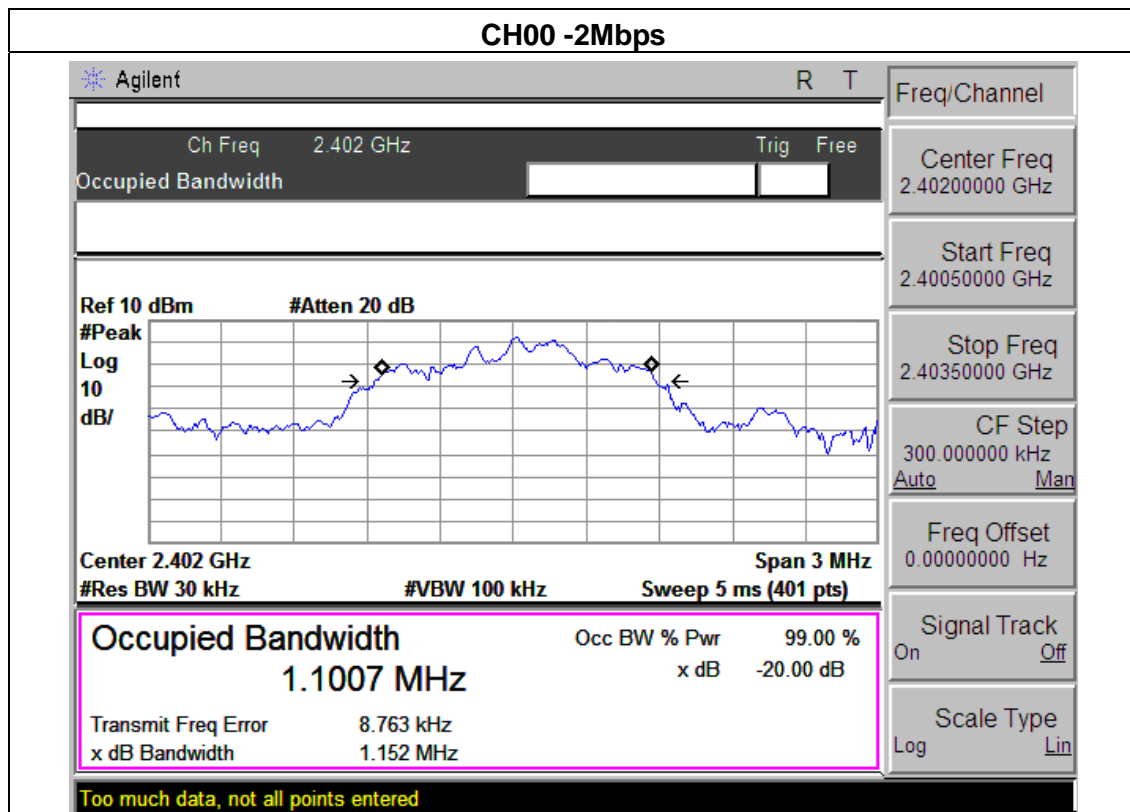

CH39 -2Mbps

Agilent		R	T	Freq/Channel	
Ch Freq 2.441 GHz		Trig Free		Center Freq 2.44100000 GHz	
Occupied Bandwidth				Start Freq 2.43950000 GHz	
Ref 10 dBm #Atten 20 dB				Stop Freq 2.44250000 GHz	
				CF Step 300.000000 kHz Auto Man	
Center 2.441 GHz		Span 3 MHz		Freq Offset 0.00000000 Hz	
#Res BW 30 kHz		#VBW 100 kHz		Sweep 5 ms (401 pts)	
Occupied Bandwidth 1.1080 MHz		Occ BW % Pwr 99.00 %		Signal Track On Off	
		x dB -20.00 dB		Scale Type Log Lin	
Transmit Freq Error 2.670 kHz					
x dB Bandwidth 1.157 MHz					
Too much data, not all points entered					

CH78 -2Mbps

Agilent		R	T	Trace/View	
Ch Freq 2.48 GHz		Trig Free		Trace 1 2 3	
Occupied Bandwidth				Clear Write	
Ref 10 dBm #Atten 20 dB				Max Hold	
				Min Hold	
Center 2.48 GHz		Span 3 MHz		View	
#Res BW 30 kHz		#VBW 100 kHz		Blank	
Sweep 5 ms (401 pts)				More 1 of 2	
Occupied Bandwidth 1.1029 MHz		Occ BW % Pwr 99.00 %			
		x dB -20.00 dB			
Transmit Freq Error 2.921 kHz					
x dB Bandwidth 1.149 MHz					
Too much data, not all points entered					

EUT :	Bluetooth Speaker	Model Name :	M59
Temperature :	25 °C	Relative Humidity :	60%
Pressure :	1012 hPa	Test Voltage :	AC 120V
Test Mode :	CH00 / CH39 /C78(3Mbps)		

Frequency	20dB Bandwidth (MHz)	Result
2402 MHz	1.164	PASS
2441 MHz	1.167	PASS
2480 MHz	1.161	PASS

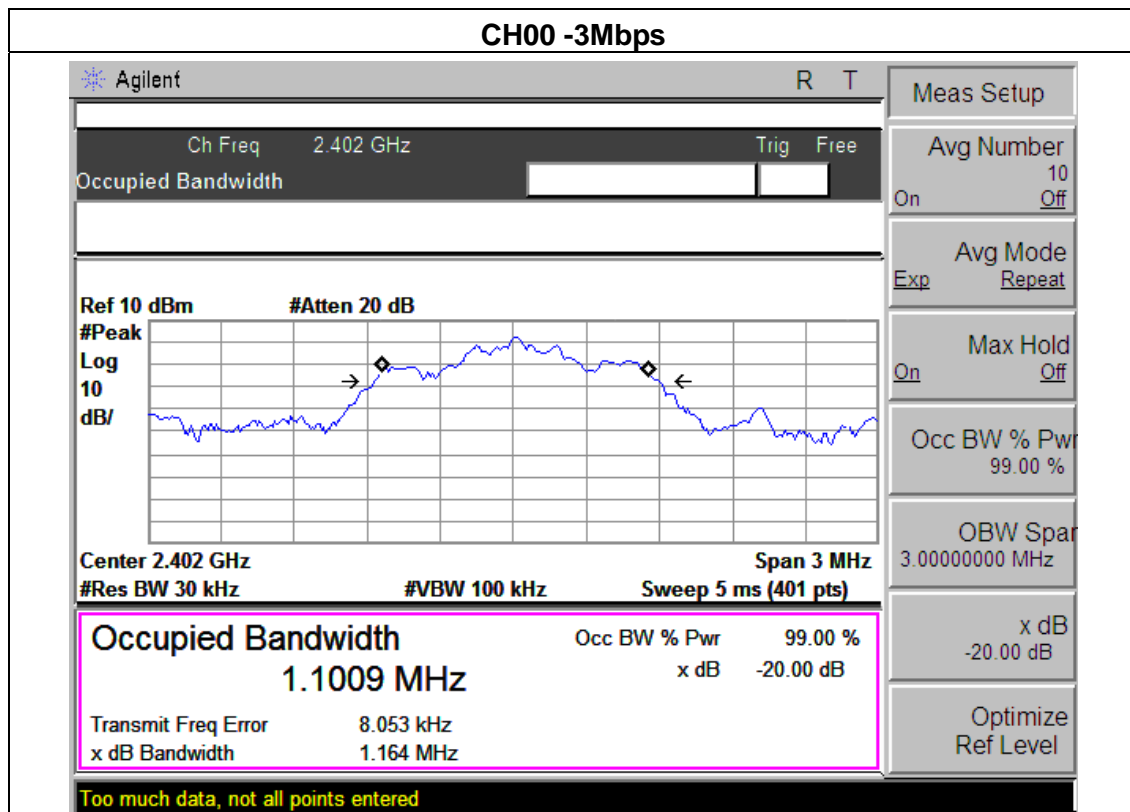

CH39 -3Mbps

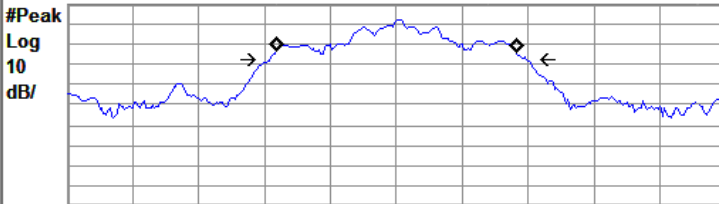
Agilent		R	T	Freq/Channel	
Ch Freq 2.441 GHz		Trig Free		Center Freq 2.44100000 GHz	
Occupied Bandwidth				Start Freq 2.43950000 GHz	
Ref 10 dBm #Atten 20 dB				Stop Freq 2.44250000 GHz	
				CF Step 300.000000 kHz Auto Man	
Center 2.441 GHz		Span 3 MHz		Freq Offset 0.00000000 Hz	
#Res BW 30 kHz		#VBW 100 kHz		Sweep 5 ms (401 pts)	
Occupied Bandwidth 1.0971 MHz		Occ BW % Pwr 99.00 %		Signal Track On Off	
		x dB -20.00 dB		Scale Type Log Lin	
Transmit Freq Error 201.199 Hz					
x dB Bandwidth 1.167 MHz					
Too much data, not all points entered					

CH78 -3Mbps

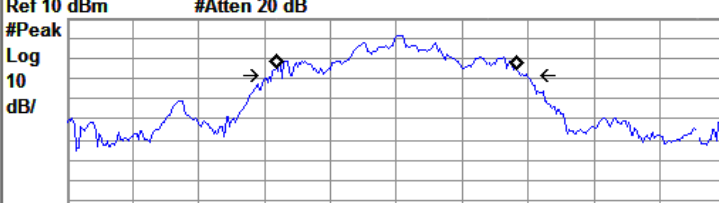
Agilent		R	T	Freq/Channel	
Ch Freq 2.48 GHz		Trig Free		Center Freq 2.48000000 GHz	
Occupied Bandwidth				Start Freq 2.47850000 GHz	
Ref 10 dBm #Atten 20 dB				Stop Freq 2.48150000 GHz	
				CF Step 300.000000 kHz Auto Man	
Center 2.48 GHz		Span 3 MHz		Freq Offset 0.00000000 Hz	
#Res BW 30 kHz		#VBW 100 kHz		Sweep 5 ms (401 pts)	
Occupied Bandwidth 1.0936 MHz		Occ BW % Pwr 99.00 %		Signal Track On Off	
		x dB -20.00 dB		Scale Type Log Lin	
Transmit Freq Error 1.463 kHz					
x dB Bandwidth 1.161 MHz					
Too much data, not all points entered					

8. PEAK OUTPUT POWER TEST

8.1 APPLIED PROCEDURES / LIMIT

FCC Part15 (15.247) , Subpart C				
Section	Test Item	Limit	Frequency Range (MHz)	Result
15.247 (b)(i)	Peak Output Power	30dbm or 20.96dBm	2400-2483.5	PASS

8.1.1 TEST PROCEDURE

- a. The EUT was directly connected to the spectrum analyzer and antenna output port as show in the block diagram below,
- b. Spectrum Setting : RBW > the 20 dB bandwidth of the emission being measured
 Span = approximately 5 times the 20 dB bandwidth, centered on a hopping channel
 VBW ≥ RBW
 Sweep = auto
 Detector function = peak
 Trace = max hold

8.1.2 DEVIATION FROM STANDARD

No deviation.

8.1.3 TEST SETUP



8.1.4 EUT OPERATION CONDITIONS

The EUT tested system was configured as the statements of 2.4 Unless otherwise a special operating condition is specified in the follows during the testing.

8.1.5 TEST RESULTS

EUT :	Bluetooth Speaker	Model Name :	M59
Temperature :	25 °C	Relative Humidity :	60%
Pressure :	1012 hPa	Test Voltage :	AC 120V
Test Mode :	CH00/ CH39 /CH78 (1M/2M/3Mbps Mode)		

1Mbps			
Test Channel	Frequency (MHz)	Peak Output Power (dBm)	LIMIT (dBm)
CH00	2402	3.129	20.96
CH39	2441	3.597	20.96
CH78	2480	3.628	20.96
2Mbps			
CH00	2402	2.653	20.96
CH39	2441	3.090	20.96
CH78	2480	2.787	20.96
3Mbps			
CH00	2402	2.661	20.96
CH39	2441	3.191	20.96
CH78	2480	2.997	20.96

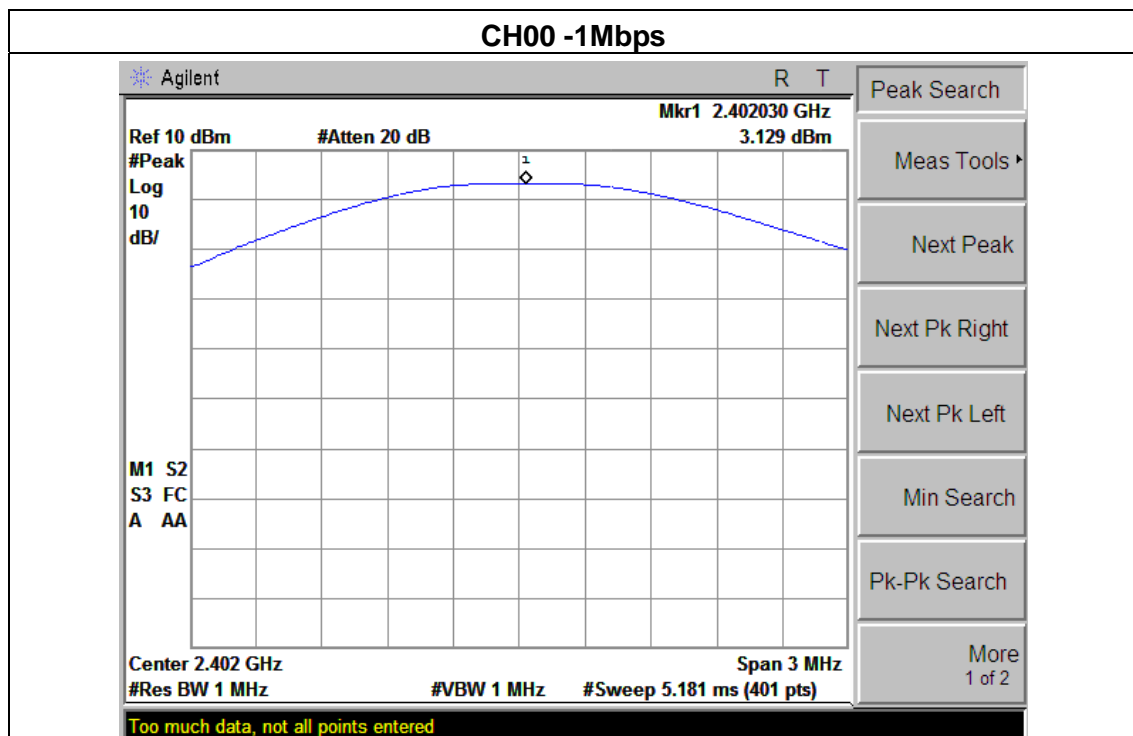

CH39 -1Mbps

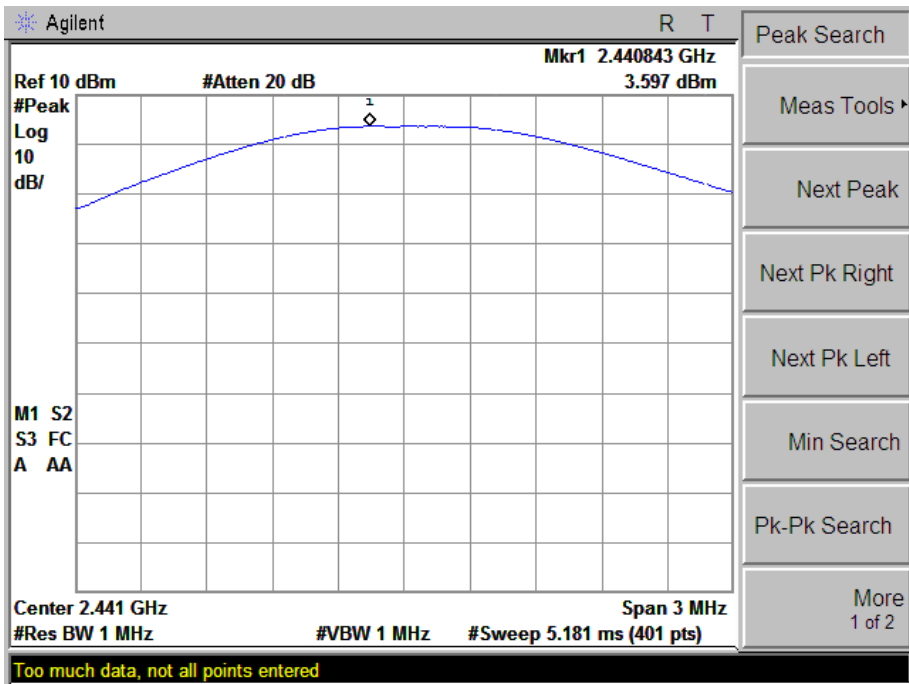

CH78 -1Mbps

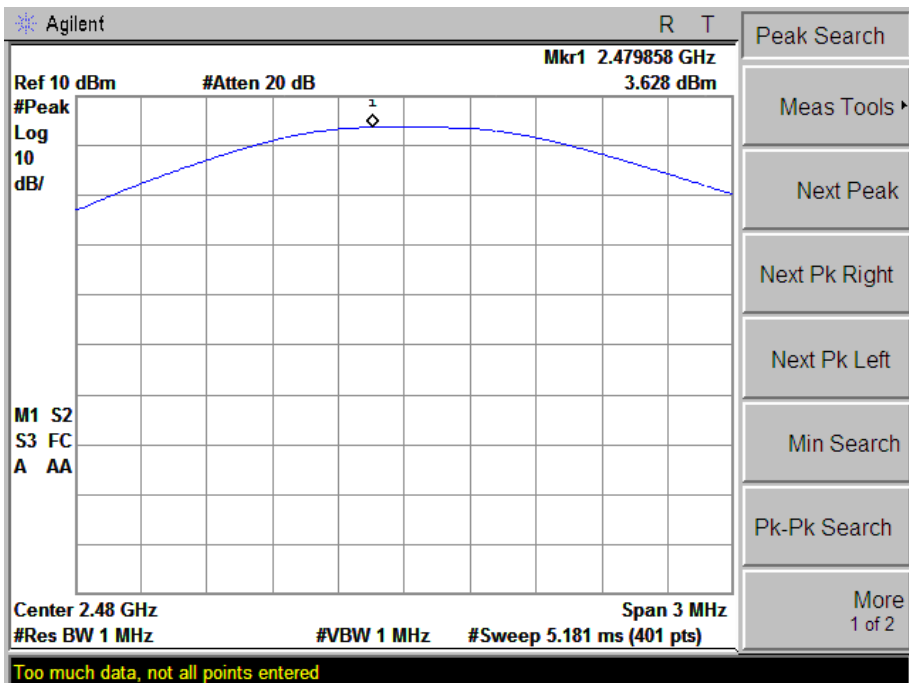

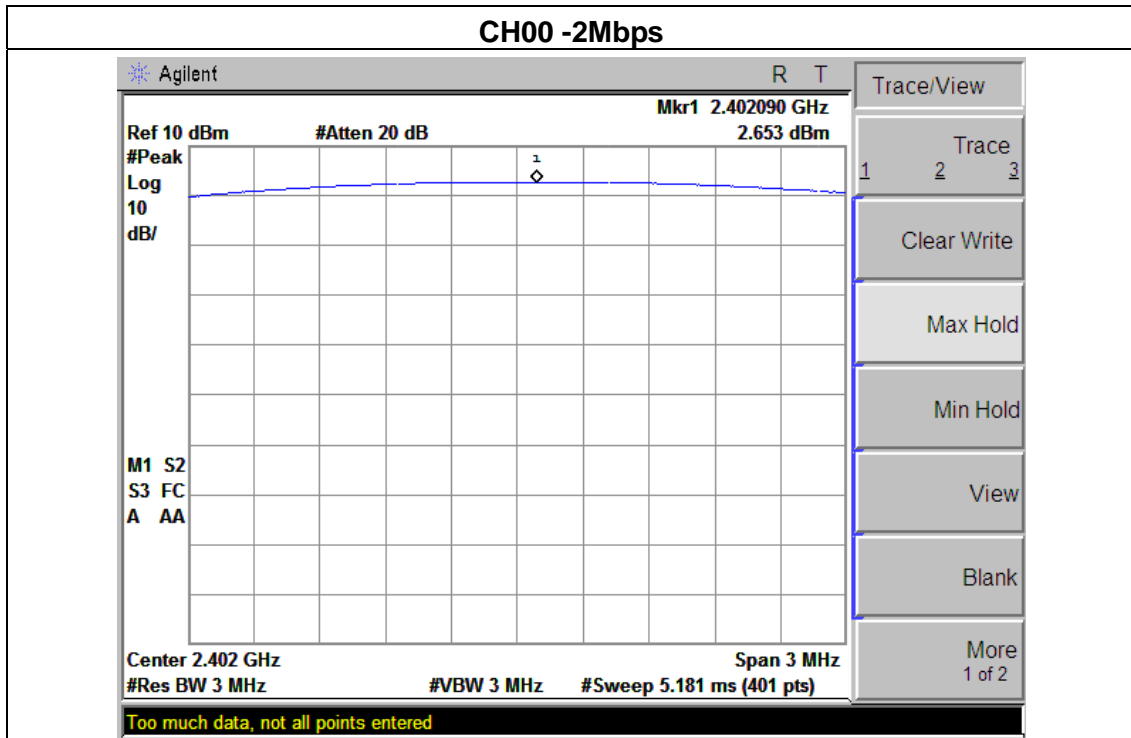

CH39 -2Mbps

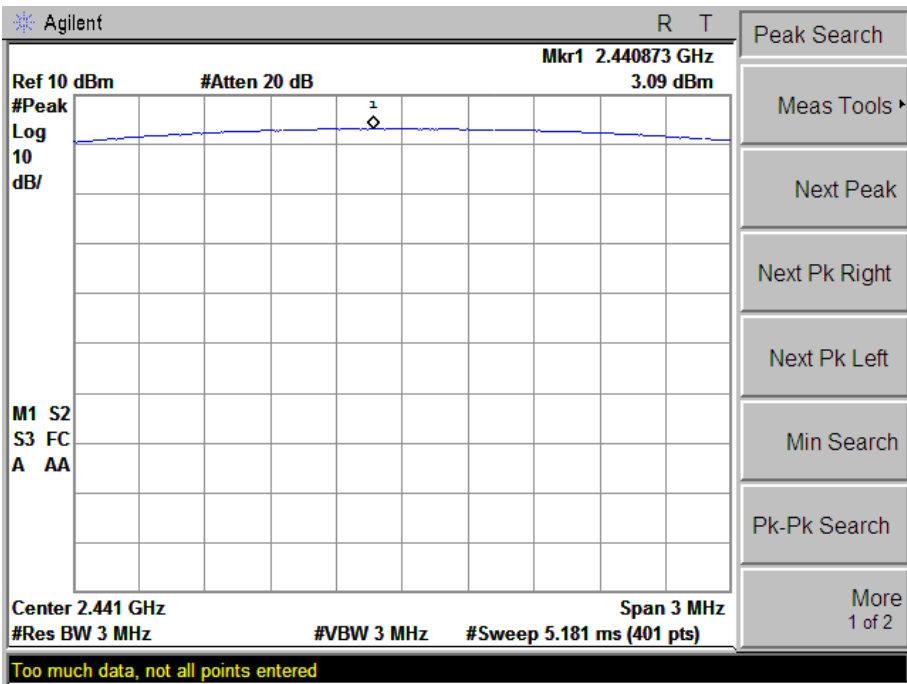

CH78 -2Mbps

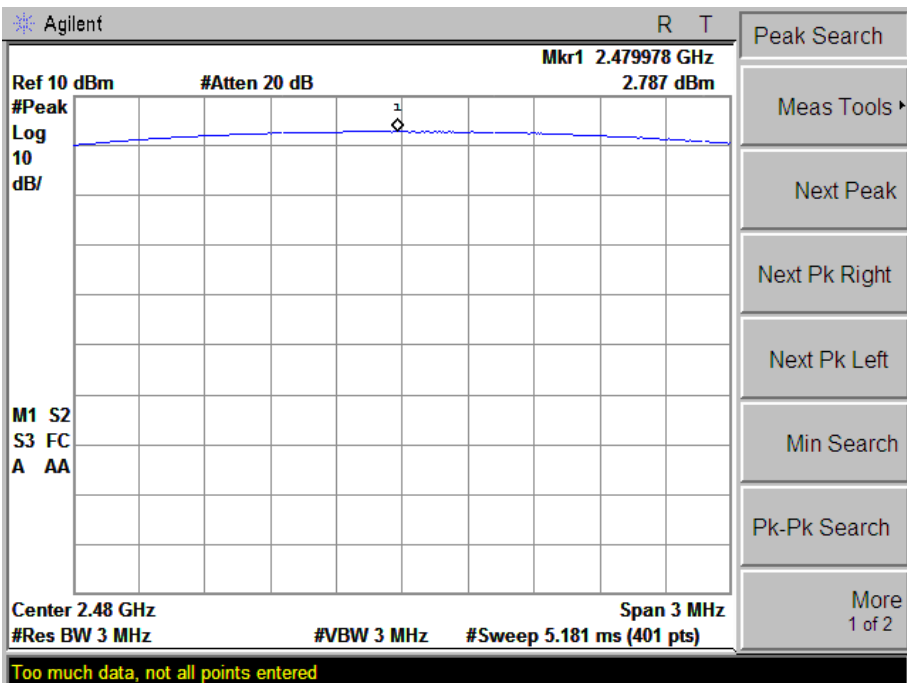

CH00 -3Mbps

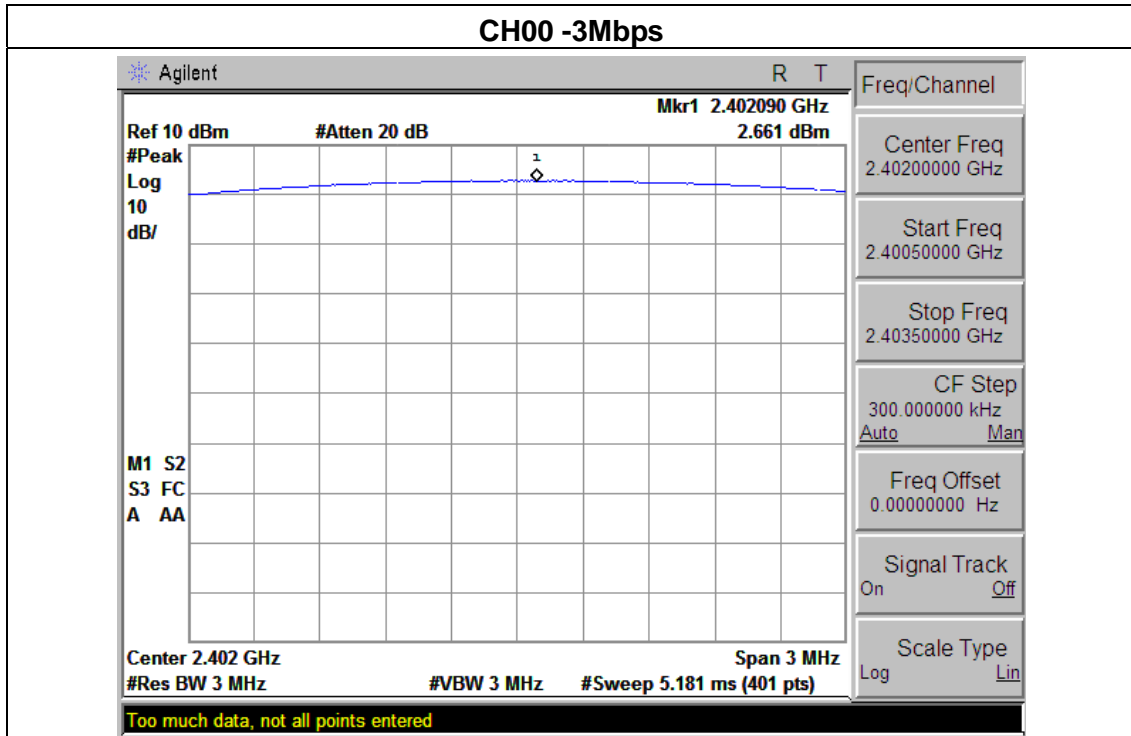

CH39 -3Mbps

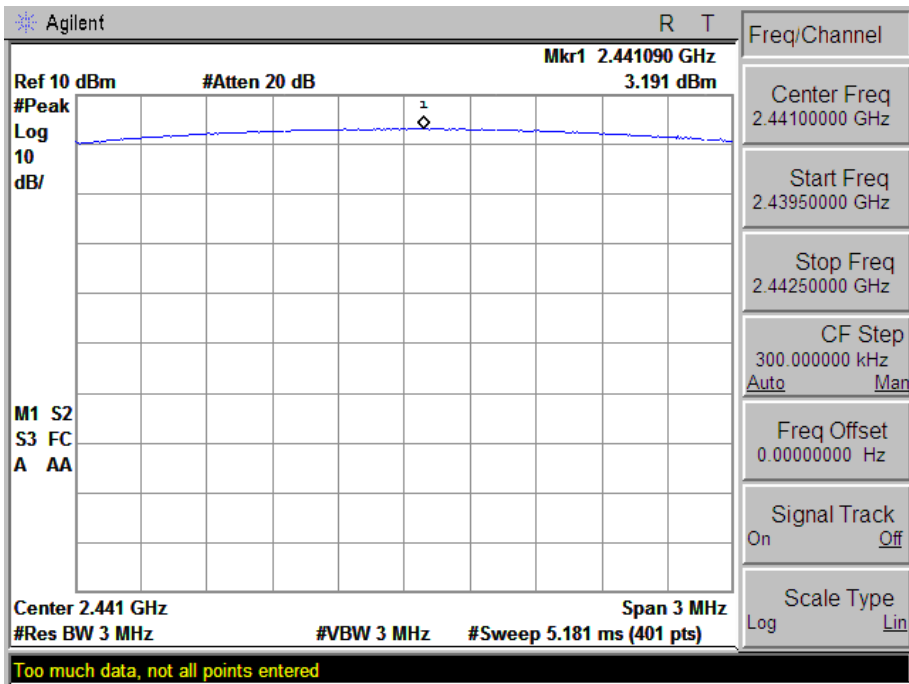

CH78 -3Mbps

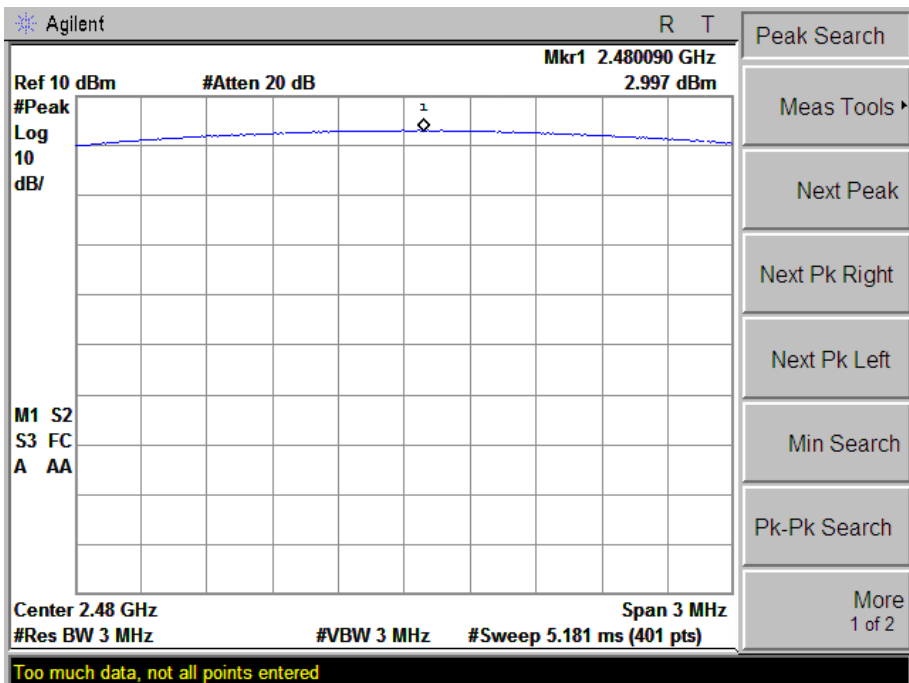

9. ANTENNA REQUIREMENT

9.1 STANDARD REQUIREMENT

15.203 requirement: For intentional device, according to 15.203: an intentional radiator shall be designed to ensure that no antenna other than that furnished by the responsible party shall be used with the device.

9.2 EUT ANTENNA

The EUT antenna is Integrated (PCB) antenna. It comply with the standard requirement.

10. EUT TEST PHOTO

Radiated Measurement Photos

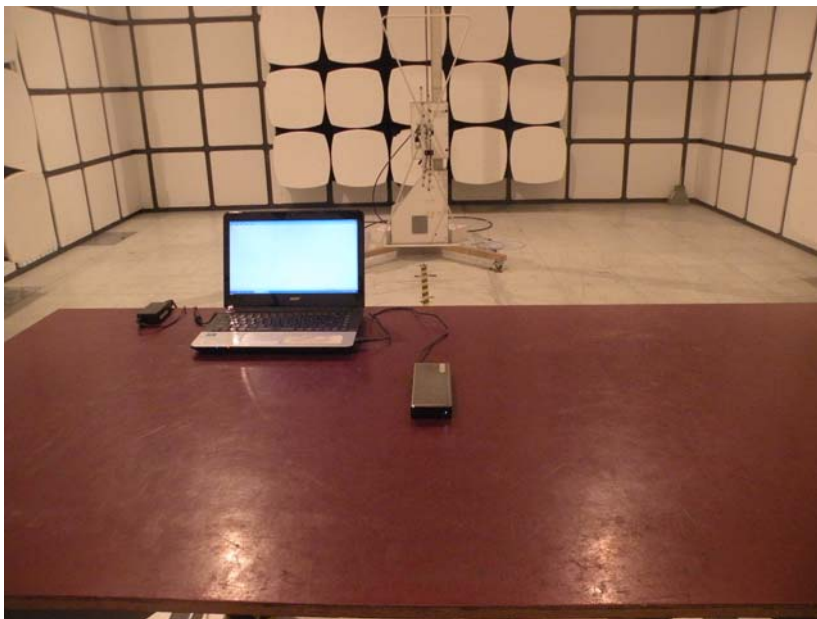

Conducted Measurement Photos

