

# MEASUREMENT REPORT

## FCC PART 15 Subpart C Bluetooth

---

**FCC ID:** 2AB9SM100

**APPLICANT:** Shenzhen Jonter Digital Co., Ltd

**Application Type:** Certification

**Product:** Bluetooth Speaker

**Brand Name:** ECOXGEAR

**Model No.:** M100

**Serial Model No.:** GDI-EXRMX101

**FCC Classification:** FCC Part 15 Spread Spectrum Transmitter(DSS)

**FCC Rule Part(s):** Part15 Subpart C (Section 15.247)

**Test Procedure(s):** ANSI C63.10-2013  
KDB 558074 D01v05r01

**Test Date:** March 20 ~ 26, 2019

Reviewed By:



( Jame Yuan )

Approved By:

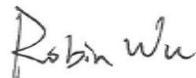

( Robin Wu )



The test results relate only to the samples tested.

This equipment has been shown to be capable of compliance with the applicable technical standards as indicated in the measurement report and was tested in accordance with the measurement procedures specified in ANSI C63.10-2013. Test results reported herein relate only to the item(s) tested.

The test report shall not be reproduced except in full without the written approval of MRT Technology (Suzhou) Co., Ltd.

---

## Revision History

Report No.	Version	Description	Issue Date	Note
1903RSU018-U1	Rev. 01	Initial Report	03-29-2019	Valid

---

## CONTENTS

Description	Page
<b>1. INTRODUCTION .....</b>	<b>7</b>
1.1. Scope .....	7
1.2. MRT Test Location .....	7
<b>2. PRODUCT INFORMATION .....</b>	<b>8</b>
2.1. Equipment Description.....	8
2.2. Product Specification Subjective to this Standard .....	8
2.3. Operation Frequency / Channel List .....	9
2.4. Pseudorandom Frequency Hopping Sequence.....	10
2.5. Device Capabilities .....	11
2.6. Test Configuration .....	12
2.7. Test Software .....	12
2.8. EMI Suppression Device(s)/Modifications.....	12
2.9. Labeling Requirements.....	12
<b>3. DESCRIPTION of TEST .....</b>	<b>13</b>
3.1. Evaluation Procedure .....	13
3.2. AC Line Conducted Emissions .....	13
3.3. Radiated Emissions .....	14
<b>4. ANTENNA REQUIREMENTS .....</b>	<b>15</b>
<b>5. TEST EQUIPMENT CALIBRATION DATE .....</b>	<b>16</b>
<b>6. MEASUREMENT UNCERTAINTY .....</b>	<b>18</b>
<b>7. TEST RESULT .....</b>	<b>19</b>
7.1. Summary .....	19
7.2. 20dB Bandwidth Measurement.....	20
7.2.1. Test Limit .....	20
7.2.2. Test Procedure Used .....	20
7.2.3. Test Setting.....	20
7.2.4. Test Setup.....	20
7.2.5. Test Result.....	21
7.3. Output Power Measurement.....	25
7.3.1. Test Limit .....	25
7.3.2. Test Procedure Used .....	25
7.3.3. Test Setting.....	25
7.3.4. Test Setup.....	25

7.3.5.	Test Result .....	26
7.4.	Carrier Frequency Separation Measurement .....	30
7.4.1.	Test Limit .....	30
7.4.2.	Test Procedure Used .....	30
7.4.3.	Test Setting .....	30
7.4.4.	Test Setup.....	30
7.4.5.	Test Result.....	31
7.5.	Number of Hopping Channels Measurement .....	35
7.5.1.	Test Limit .....	35
7.5.2.	Test Procedure Used .....	35
7.5.3.	Test Settintg .....	35
7.5.4.	Test Setup.....	35
7.5.5.	Test Result.....	36
7.6.	Time of Occupancy Measurement .....	39
7.6.1.	Test Limit .....	39
7.6.2.	Test Procedure Used .....	39
7.6.3.	Test Settintg .....	39
7.6.4.	Test Setup.....	39
7.6.5.	Test Result.....	40
7.7.	Band-edge Compliance Measurement.....	42
7.7.1.	Test Limit .....	42
7.7.2.	Test Procedure Used .....	42
7.7.3.	Test Setting.....	42
7.7.4.	Test Setup.....	43
7.7.5.	Test Result.....	44
7.8.	Conducted Spurious Emissions Measurement.....	47
7.8.1.	Test Limit .....	47
7.8.2.	Test Procedure Used .....	47
7.8.3.	Test Setting.....	47
7.8.4.	Test Setup.....	48
7.8.5.	Test Result.....	49
7.9.	Radiated Spurious Emission Measurement .....	53
7.9.1.	Test Limit .....	53
7.9.2.	Test Procedure Used .....	53
7.9.3.	Test Setting.....	53
7.9.4.	Test Setup.....	55
7.9.5.	Test Result.....	56
7.10.	Radiated Restricted Band Edge Measurement .....	67

---

7.10.1. Test Procedure Used .....	68
7.10.2. Test Setting .....	68
7.10.3. Test Setup.....	69
7.10.4. Test Result.....	70
7.11. AC Conducted Emissions Measurement.....	94
7.11.1. Test Limit .....	94
7.11.2. Test Setup.....	94
7.11.3. Test Result.....	95
<b>8. CONCLUSION.....</b>	<b>97</b>
<b>Appendix A - Test Setup Photograph .....</b>	<b>98</b>
<b>Appendix B - EUT Photograph.....</b>	<b>99</b>

## §2.1033 General Information

<b>Applicant:</b>	Shenzhen Jonter Digital Co., Ltd
<b>Applicant Address:</b>	3F/4B, Hezhou Jinfo Industrial Park, Hezhou, Xixiang Street, Baoan District, Shenzhen, Guangdong, China
<b>Manufacturer:</b>	Shenzhen Jonter Digital Co., Ltd
<b>Manufacturer Address:</b>	3F/4B, Hezhou Jinfo Industrial Park, Hezhou, Xixiang Street, Baoan District, Shenzhen, Guangdong, China
<b>Test Site:</b>	MRT Technology (Suzhou) Co., Ltd
<b>Test Site Address:</b>	D8 Building, No.2 Tian'edang Rd., Wuzhong Economic Development Zone, Suzhou, China
<b>MRT FCC Registration No.:</b>	893164
<b>Test Device Serial No.:</b>	N/A <input type="checkbox"/> Production <input checked="" type="checkbox"/> Pre-Production <input type="checkbox"/> Engineering

### Test Facility / Accreditations

Measurements were performed at MRT Laboratory located in Tian'edang Rd., Suzhou, China.

- MRT facility is a FCC registered (MRT Reg. No. 893164) test facility with the site description report on file and has met all the requirements specified in ANSI C63.4-2014.
- MRT facility is an IC registered (MRT Reg. No. 11384A-1) test laboratory with the site description on file at Industry Canada.
- MRT facility is a VCCI registered (R-20025, G-20034, C-20020, T-20020) test laboratory with the site description on file at VCCI Council.
- MRT Lab is accredited to ISO 17025 by the American Association for Laboratory Accreditation (A2LA) under the American Association for Laboratory Accreditation Program (A2LA Cert. No. 3628.01) in EMC, Telecommunications, Radio and SAR testing.



# 1. INTRODUCTION

## 1.1. Scope

Measurement and determination of electromagnetic emissions (EMC) of radio frequency devices including intentional and/or unintentional radiators for compliance with the technical rules and regulations of the Federal Communications Commission and the Industry Canada Certification and Engineering Bureau.

## 1.2. MRT Test Location

The map below shows the location of the MRT LABORATORY, its proximity to the Taihu Lake. These measurement tests were conducted at the MRT Technology (Suzhou) Co., Ltd. Facility located at D8 Building, No.2 Tian'edang Rd., Wuzhong Economic Development Zone, Suzhou, China. The measurement facility compliant with the test site requirements specified in ANSI C63.4-2014.



## 2. PRODUCT INFORMATION

### 2.1. Equipment Description

Product Name	Bluetooth Speaker
Brand Name	ECOXGEAR
Model No.	M100
Serial Model No.	GDI-EXRMX101
Bluetooth Specification	v4.2 (Single mode for EDR)

Note 1: The different models are only for marketing different clients, others are the same.

Note 2: The product does not come with adapter for marketing, and it's powered by adapter (model: ADS-12B-06 05010E) supplied by MRT for testing.

### 2.2. Product Specification Subjective to this Standard

Operating Frequency	2402~2480MHz
Channel Number	79
Type of modulation	GFSK, Pi/4 DQPSK, 8DPSK
Data Rate	1Mbps(GFSK), 2Mbps(Pi/4 DQPSK), 3Mbps (8DPSK)
Antenna Type	PCB Antenna
Antenna Gain	0dBi

The equipment under test (EUT) is the **Bluetooth Speaker**. The test data contained in this report pertains only to the emissions due to the EUT's Bluetooth transmitter.

- 15.247(g): In accordance with the Bluetooth Industry Standard, the system is designed to comply with all of the regulations in Section 15.247 when the transmitter is presented with a continuous data (or information) system.
- 15.247(h): In accordance with the Bluetooth Industry Standard, the system does not coordinate its channels selection/ hopping sequence with other frequency hopping systems for the express purpose of avoiding the simultaneous occupancy of individual hopping frequencies by multiple transmitters.
- 15.247(h): The EUT employs Adaptive Frequency Hopping (AFH) which identifies sources of interference namely devices operating in 802.11 WLAN and excludes them from the list of available channels. The process of re-mapping reduces the number of test channels from 79 channels to a minimum number of 20 channels.



### 2.3. Operation Frequency / Channel List

Channel	Frequency	Channel	Frequency	Channel	Frequency
00	2402 MHz	01	2403 MHz	02	2404 MHz
03	2405 MHz	04	2406 MHz	05	2407 MHz
06	2408 MHz	07	2409 MHz	08	2410 MHz
09	2411 MHz	10	2412 MHz	11	2413 MHz
12	2414 MHz	13	2415 MHz	14	2416 MHz
15	2417 MHz	16	2418 MHz	17	2419 MHz
18	2420 MHz	19	2421 MHz	20	2422 MHz
21	2423 MHz	22	2424 MHz	23	2425 MHz
24	2426 MHz	25	2427 MHz	26	2428 MHz
27	2429 MHz	28	2430 MHz	29	2431 MHz
30	2432 MHz	31	2433 MHz	32	2434 MHz
33	2435 MHz	34	2436 MHz	35	2437 MHz
36	2438 MHz	37	2439 MHz	38	2440 MHz
39	2441 MHz	40	2442 MHz	41	2443 MHz
42	2444 MHz	43	2445 MHz	44	2446 MHz
45	2447 MHz	46	2448 MHz	47	2449 MHz
48	2450 MHz	49	2451 MHz	50	2452 MHz
51	2453 MHz	52	2454 MHz	53	2455 MHz
54	2456 MHz	55	2457 MHz	56	2458 MHz
57	2459 MHz	58	2460 MHz	59	2461 MHz
60	2462 MHz	61	2463 MHz	62	2464 MHz
63	2465 MHz	64	2466 MHz	65	2467 MHz
66	2468 MHz	67	2469 MHz	68	2470 MHz
69	2471 MHz	70	2472 MHz	71	2473 MHz
72	2474 MHz	73	2475 MHz	74	2476 MHz
75	2477 MHz	76	2478 MHz	77	2479 MHz
78	2480 MHz	--	--	--	--

### 2.4. Pseudorandom Frequency Hopping Sequence

The pseudorandom sequence may be generated in a nine-stage shift register whose 5th and 9th stage outputs are added in a modulo-two addition stage. And the result is fed back to the input of the first stage. The sequence begins with the first ONE of 9 consecutive ONES; i.e. the shift register is initialized with nine ones.

- Number of shift register stages: 9
- Length of pseudo-random sequence:  $2^9 - 1 = 511$  bits
- Longest sequence of zeros: 8 (non-inverted signal)

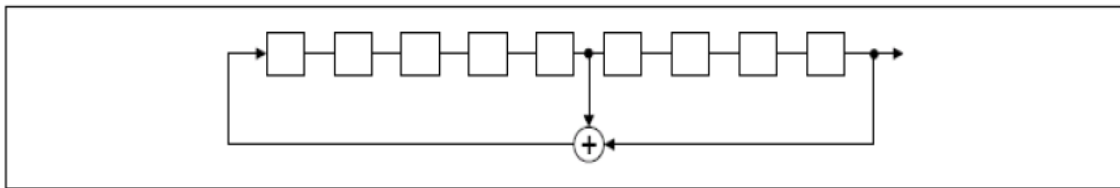

Linear Feedback Shift Register for Generation of the PRBS sequence

An example of Pseudorandom Frequency Hopping Sequence as follow:

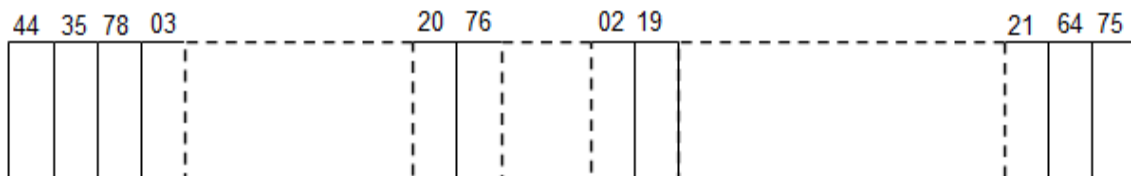

Each frequency used equally on the average by each transmitter.

The system receivers have input bandwidths that match the hopping channel bandwidths of their Corresponding transmitters and shift frequencies in synchronization with the transmitted signals.

## 2.5. Device Capabilities

This device contains the following capabilities:

Bluetooth v4.2 (Single mode for EDR)

**Note:** The maximum achievable duty cycle was determined based on measurements performed on a spectrum analyzer in zero-span mode with RBW = 8MHz, VBW = 50MHz. The RBW and VBW were both greater than 50/T, where T is the minimum transmission duration, and the number of sweep points across T was greater than 100. The duty cycles are as follows:

Test Mode	Duty Cycle
DH5	99.48%
2DH5	99.55%
3DH5	99.58%

### Duty Cycle (T = Transmission Duration)

DH5 (T = 2.865ms)

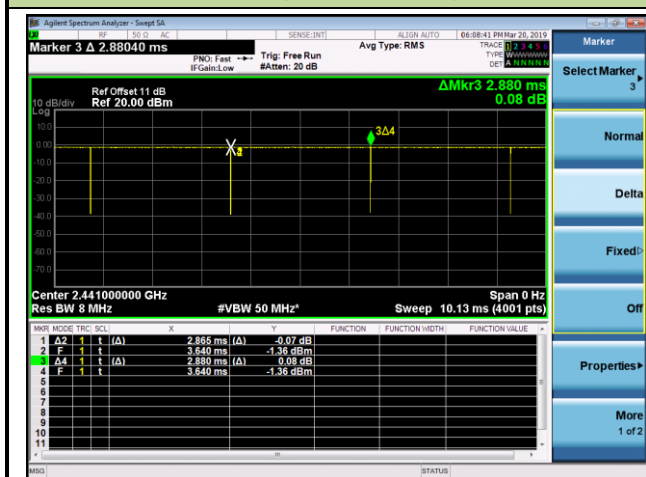

2DH5 (T = 2.870ms)

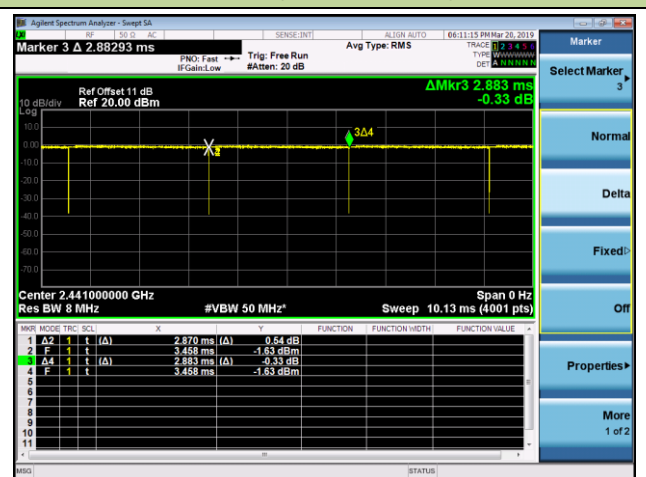

3DH5 (T = 2.873ms)

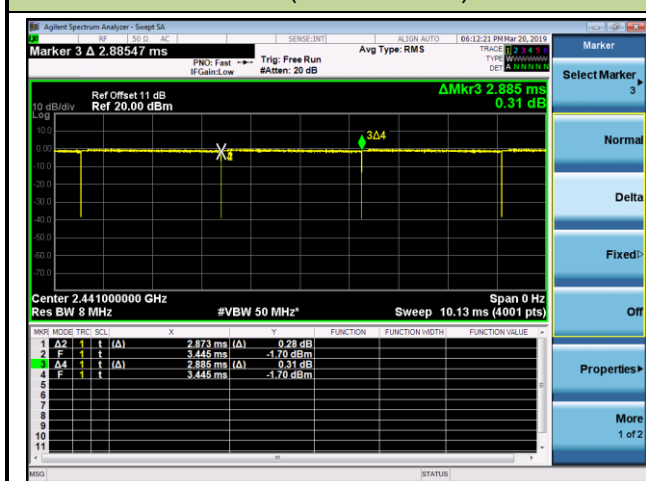

## 2.6. Test Configuration

The **Bluetooth Speaker** was tested per the guidance of ANSI C63.10-2013. ANSI C63.10-2013 was used to reference the appropriate EUT setup for radiated emissions testing and AC line conducted testing.

## 2.7. Test Software

The test utility software used during testing was “BT FCC Tool”, and the version was “1.02”.

## 2.8. EMI Suppression Device(s)/Modifications

No EMI suppression device(s) were added and/or no modifications were made during testing.

## 2.9. Labeling Requirements

Per 2.1074 & 15.19; Docket 95-19

The label shall be permanently affixed at a conspicuous location on the device; instruction manual or pamphlet supplied to the user and be readily visible to the purchaser at the time of purchase.

However, when the device is so small wherein placement of the label with specified statement is not practical, only the FCC ID must be displayed on the device per Section 15.19(a)(5). Please see attachment for FCC ID label and label location.

### 3. DESCRIPTION of TEST

#### 3.1. Evaluation Procedure

The measurement procedures described in the American National Standard of Procedures for Compliance Testing of Unlicensed Wireless Devices (ANSI C63.10-2013), and the procedure was used in the measurement of the **Bluetooth Speaker**.

**Deviation from measurement procedure.....None**

#### 3.2. AC Line Conducted Emissions

The line-conducted facility is located inside an 8'x4'x4' shielded enclosure. A 1m x 2m wooden table 80cm high is placed 40cm away from the vertical wall and 80cm away from the sidewall of the shielded room. Two 10kHz-30MHz, 50Ω/50uH Line-Impedance Stabilization Networks (LISNs) are bonded to the shielded room floor. Power to the LISNs is filtered by external high-current high-insertion loss power line filters. These filters attenuate ambient signal noise from entering the measurement lines. These filters are also bonded to the shielded enclosure.

The EUT is powered from one LISN and the support equipment is powered from the second LISN. All interconnecting cables more than 1 meter were shortened to a 1 meter length by non-inductive bundling (serpentine fashion) and draped over the back edge of the test table. All cables were at least 40cm above the horizontal reference ground-plane. Power cables for support equipment were routed down to the second LISN while ensuring that that cables were not draped over the second LISN.

Sufficient time for the EUT, support equipment, and test equipment was allowed in order for them to warm up to their normal operating condition. The RF output of the LISN was connected to the receiver and exploratory measurements were made to determine the frequencies producing the maximum emission from the EUT. The receiver was scanned from 150kHz to 30MHz. The detector function was set to peak mode for exploratory measurements while the bandwidth of the analyzer was set to 9kHz. The EUT, support equipment, and interconnecting cables were arranged and manipulated to maximize each emission. Each emission was also maximized by varying: power lines, the mode of operation or data exchange speed, or support equipment whichever determined the worst-case emission. Once the worst case emissions have been identified, the one EUT cable configuration/arrangement and mode of operation that produced these emissions were used for final measurements on the same test site. The analyzer is set to CISPR quasi-peak and average detectors with a 9kHz resolution bandwidth for final measurements.

An extension cord was used to connect to a single LISN which powered by EUT. The extension cord was calibrated with LISN, the impedance and insertion loss are compliance with the requirements as stated in ANSI C63.10-2013.

### 3.3. Radiated Emissions

The radiated test facilities consisted of an indoor 3 meter semi-anechoic chamber used for final measurements and exploratory measurements, when necessary. The measurement area is contained within the semi-anechoic chamber which is shielded from any ambient interference. For measurements above 1GHz absorbers are arranged on the floor between the turn table and the antenna mast in such a way so as to maximize the reduction of reflections. For measurements below 1GHz, the absorbers are removed. An MF Model 210SS turntable is used for radiated measurement. It is a continuously rotatable, remote controlled, metallic turntable and 2 meters (6.56 ft.) in diameter. The turn table is flush with the raised floor of the chamber in order to maintain its function as a ground plane. An 80cm high PVC support structure is placed on top of the turntable.

For all measurements, the spectrum was scanned through all EUT azimuths and from 1 to 4 meter receive antenna height using a broadband antenna from 30MHz up to the upper frequency shown in 15.33(b)(1) depending on the highest frequency generated or used in the device or on which the device operates or tunes. For frequencies above 1GHz, linearly polarized double ridge horn antennas were used. For frequencies below 30MHz, a calibrated loop antenna was used. When exploratory measurements were necessary, they were performed at 1 meter test distance inside the semi-anechoic chamber using broadband antennas, broadband amplifiers, and spectrum analyzers to determine the frequencies and modes producing the maximum emissions. Sufficient time for the EUT, support equipment, and test equipment was allowed in order for them to warm up to their normal operating condition. The test set-up for frequencies below 1GHz was placed on top of the 0.8 meter high, 1 x 1.5 meter table; and test set-up for frequencies 1-40GHz was placed on top of the 1.5 meter high, 1 x 1.5 meter table. The EUT, support equipment, and interconnecting cables were arranged and manipulated to maximize each emission. Appropriate precaution was taken to ensure that all emissions from the EUT were maximized and investigated. The system configuration, clock speed, mode of operation or video resolution, if applicable, turntable azimuth, and receive antenna height was noted for each frequency found.

Final measurements were made in the semi-anechoic chamber using calibrated, linearly polarized broadband and horn antennas. The test setup was configured to the setup that produced the worst case emissions. The spectrum analyzer was set to investigate all frequencies required for testing to compare the highest radiated disturbances with respect to the specified limits. The turntable containing the EUT was rotated through 360 degrees and the height of the receive antenna was varied 1 to 4 meters and stopped at the azimuth and height producing the maximum emission. Each emission was maximized by changing the orientation of the EUT through three orthogonal planes and changing the polarity of the receive antenna, whichever produced the worst-case emissions. According to 3dB beamwidth of horn antenna, the horn antenna should be always directed to the EUT when rising height.

## 4. ANTENNA REQUIREMENTS

### Excerpt from §15.203 of the FCC Rules/Regulations:

“An intentional radiator antenna shall be designed to ensure that no antenna other than that furnished by the responsible party can be used with the device. The use of a permanently attached antenna or of an antenna that uses a unique coupling to the intentional radiator shall be considered sufficient to comply with the provisions of this section.”

- The antenna of the **Bluetooth Speaker** is permanently attached.
- There's no condition for connecting to an external antenna.

### Conclusion:

The unit complies with the requirement of §15.203.

## 5. TEST EQUIPMENT CALIBRATION DATE

### Conducted Emissions - SR2

Instrument	Manufacturer	Type No.	Asset No.	Cali. Interval	Cali. Due Date
EMI Test Receiver	R&S	ESR3	MRTSUE06185	1 year	2019/04/20
Two-Line V-Network	R&S	ENV216	MRTSUE06002	1 year	2019/06/15
Two-Line V-Network	R&S	ENV216	MRTSUE06003	1 year	2019/06/15
Thermohygrometer	testo	608-H1	MRTSUE06404	1 year	2019/08/15
Shielding Room	MIK-BEN	Chamber-SR2	MRTSUE06215	N/A	N/A

### Radiated Emissions - AC1

Instrument	Manufacturer	Type No.	Asset No.	Cali. Interval	Cali. Due Date
EXA Signal Analyzer	Keysight	N9020A	MRTSUE06106	1 year	2019/04/19
EMI Test Receiver	R&S	ESR7	MRTSUE06001	1 year	2019/08/14
Loop Antenna	Schwarzbeck	FMZB 1519	MRTSUE06025	1 year	2019/11/09
Bilog Period Antenna	Schwarzbeck	VULB 9168	MRTSUE06172	1 year	2019/04/12
Broad Band Horn Antenna	Schwarzbeck	BBHA 9120D	MRTSUE06023	1 year	2019/10/19
Broad Band Horn Antenna	Schwarzbeck	BBHA 9170	MRTSUE06024	1 year	2019/12/17
Microwave System Amplifier	Agilent	83017A	MRTSUE06076	1 year	2019/11/16
Preamplifier	Schwarzbeck	BBV 9721	MRTSUE06121	1 year	2019/06/12
Thermohygrometer	testo	608-H1	MRTSUE06403	1 year	2019/08/14
Anechoic Chamber	TDK	Chamber-AC1	MRTSUE06212	1 year	2019/05/01

### Radiated Emissions - AC2

Instrument	Manufacturer	Type No.	Asset No.	Cali. Interval	Cali. Due Date
MXE EMI Receiver	Keysight	N9038A	MRTSUE06125	1 year	2019/08/13
Loop Antenna	Schwarzbeck	FMZB 1519	MRTSUE06025	1 year	2019/11/09
Bilog Period Antenna	Schwarzbeck	VULB 9162	MRTSUE06022	1 year	2019/10/19
Broad-Band Horn Antenna	Schwarzbeck	BBHA 9120D	MRTSUE06171	1 year	2019/11/09
Broad Band Horn Antenna	Schwarzbeck	BBHA 9170	MRTSUE06024	1 year	2019/12/17
Broadband Coaxial Preamplifier	Schwarzbeck	BBV 9718	MRTSUE06176	1 year	2019/11/16
Preamplifier	Schwarzbeck	BBV 9721	MRTSUE06121	1 year	2019/06/12
Temperature/Humidity Meter	Yuhuaze	HTC-2	MRTSUE06178	1 year	2019/09/08
Anechoic Chamber	RIKEN	Chamber-AC2	MRTSUE06213	1 year	2019/05/01



## Conducted Test Equipment - TR3

Instrument	Manufacturer	Type No.	Asset No.	Cali. Interval	Cali. Due Date
EXA Signal Analyzer	Keysight	N9020A	MRTSUE06106	1 year	2019/04/19
Power Meter	Agilent	U2021XA	MRTSUE06030	1 year	2019/11/16
Thermohygrometer	testo	608-H1	MRTSUE06401	1 year	2019/08/15

Software	Version	Function
EMI Software	V3	EMI Test Software

## 6. MEASUREMENT UNCERTAINTY

Where relevant, the following test uncertainty levels have been estimated for tests performed on the EUT as specified in CISPR 16-4-2. This uncertainty represents an expanded uncertainty expressed at approximately the 95% confidence level using a coverage factor of  $k = 2$ .

<b>AC Conducted Emission Measurement - SR2</b>
Measuring Uncertainty for a Level of Confidence of 95% ( $U=2Uc(y)$ ): 9kHz~150kHz: $\pm 3.84\text{dB}$ 150kHz~30MHz: $\pm 3.46\text{dB}$
<b>Radiated Emission Measurement - AC1</b>
Measuring Uncertainty for a Level of Confidence of 95% ( $U=2Uc(y)$ ): Horizontal: 30MHz~300MHz: $\pm 4.07\text{dB}$ 300MHz~1GHz: $\pm 3.63\text{dB}$ 1GHz~40GHz: $\pm 4.16\text{dB}$ Vertical: 30MHz~300MHz: $\pm 4.18\text{dB}$ 300MHz~1GHz: $\pm 3.60\text{dB}$ 1GHz~40GHz: $\pm 4.76\text{dB}$
<b>Radiated Emission Measurement - AC2</b>
Measuring Uncertainty for a Level of Confidence of 95% ( $U=2Uc(y)$ ): Horizontal: 30MHz~300MHz: $\pm 3.75\text{dB}$ 300MHz~1GHz: $\pm 3.53\text{dB}$ 1GHz~40GHz: $\pm 4.28\text{dB}$ Vertical: 30MHz~300MHz: $\pm 3.86\text{dB}$ 300MHz~1GHz: $\pm 3.53\text{dB}$ 1GHz~40GHz: $\pm 4.33\text{dB}$
<b>Spurious Emissions, Conducted - TR3</b>
Measuring Uncertainty for a Level of Confidence of 95% ( $U=2Uc(y)$ ): 0.78dB
<b>Output Power - TR3</b>
Measuring Uncertainty for a Level of Confidence of 95% ( $U=2Uc(y)$ ): 1.13dB
<b>Occupied Bandwidth - TR3</b>
Measuring Uncertainty for a Level of Confidence of 95% ( $U=2Uc(y)$ ): 0.28%

## 7. TEST RESULT

### 7.1. Summary

**Product Name:** Bluetooth Speaker  
**Method/System:** Frequency Hopping Spread Spectrum (FHSS)  
**Number of Channels:** 79

FCC Part Section(s)	Test Description	Test Limit	Test Condition	Test Result	Reference
15.247(a)(1)	20dB Bandwidth	N/A	Conducted	Pass	Section 7.2
15.247(b)(1)	Peak Transmitter Output Power	< 1 Watt		Pass	Section 7.3
15.247(a)(1)	Channel Separation	> 2/3 of 20 dB BW for systems with Output Power < 125mW		Pass	Section 7.4
15.247(a)(1)(iii)	Number of Channels	> 15 Channels		Pass	Section 7.5
15.247(a)(1)(iii)	Time of Occupancy	< 0.4 sec in 31.6 sec period		Pass	Section 7.6
15.247(d)	Band Edge / out- of-Band Emissions	Conducted $\geq$ 20dBc		Pass	Section 7.7 Section 7.8
15.205, 15.209	General Field Strength Limits (Restricted Bands and Radiated Emission Limits)	Emissions in restricted bands must meet the radiated limits detailed in 15.209	Radiated	Pass	Section 7.9 Section 7.10
15.207	AC Conducted Emissions 150kHz - 30MHz	< FCC 15.207 limits	Line Conducted	Pass	Section 7.11

#### Notes:

- 1) The analyzer plots shown in this section were all taken with a correction table loaded into the analyzer. The correction table was used to account for the losses of the cables and attenuators used as part of the system to connect the EUT to the analyzer at all frequencies of interest.
- 2) All modes of operation and data rates were investigated. For radiated emission test, every axis (X, Y, Z) was also verified. The test results shown in the following sections represent the worst case emissions.

## 7.2. 20dB Bandwidth Measurement

### 7.2.1. Test Limit

N/A

### 7.2.2. Test Procedure Used

ANSI C63.10-2013 - Section 6.9.2

### 7.2.3. Test Setting

1. Set RBW  $\geq$  1% to 5% of the 20dB bandwidth
2. VBW = approximately three times RBW
3. Span = approximately 2 to 5 times the 20dB bandwidth, centered on a hopping channel
4. Detector = peak
5. Trace mode = max hold
6. Sweep = auto couple
7. Allow the trace to stabilize
8. Measure the maximum width of the emission that is constrained by the frequencies associated with the two outermost amplitude points (upper and lower frequencies) that are attenuated by 20 dB relative to the maximum level measured in the fundamental emission.

### 7.2.4. Test Setup

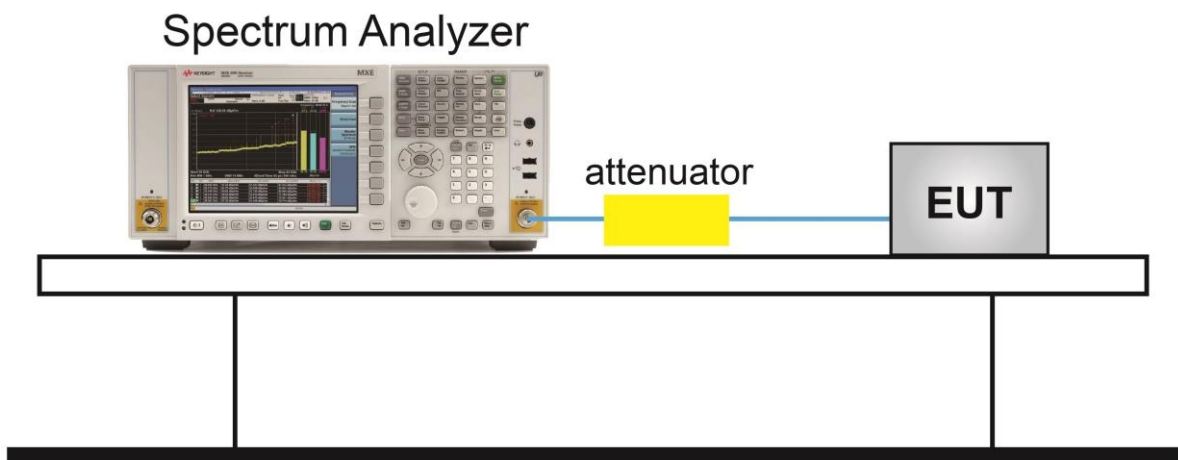

**7.2.5. Test Result**

Product	Bluetooth Speaker	Temperature	25 °C
Test Engineer	Snake Ni	Relative Humidity	56%
Test Site	TR3	Test Date	2019/03/20

Test Mode	Channel No.	Frequency (MHz)	20dB Bandwidth (kHz)	Result
DH5	00	2402	916.8	Pass
DH5	39	2441	917.9	Pass
DH5	78	2480	917.6	Pass
2DH5	00	2402	1284.0	Pass
2DH5	39	2441	1284.0	Pass
2DH5	78	2480	1283.0	Pass
3DH5	00	2402	1259.0	Pass
3DH5	39	2441	1260.0	Pass
3DH5	78	2480	1259.0	Pass

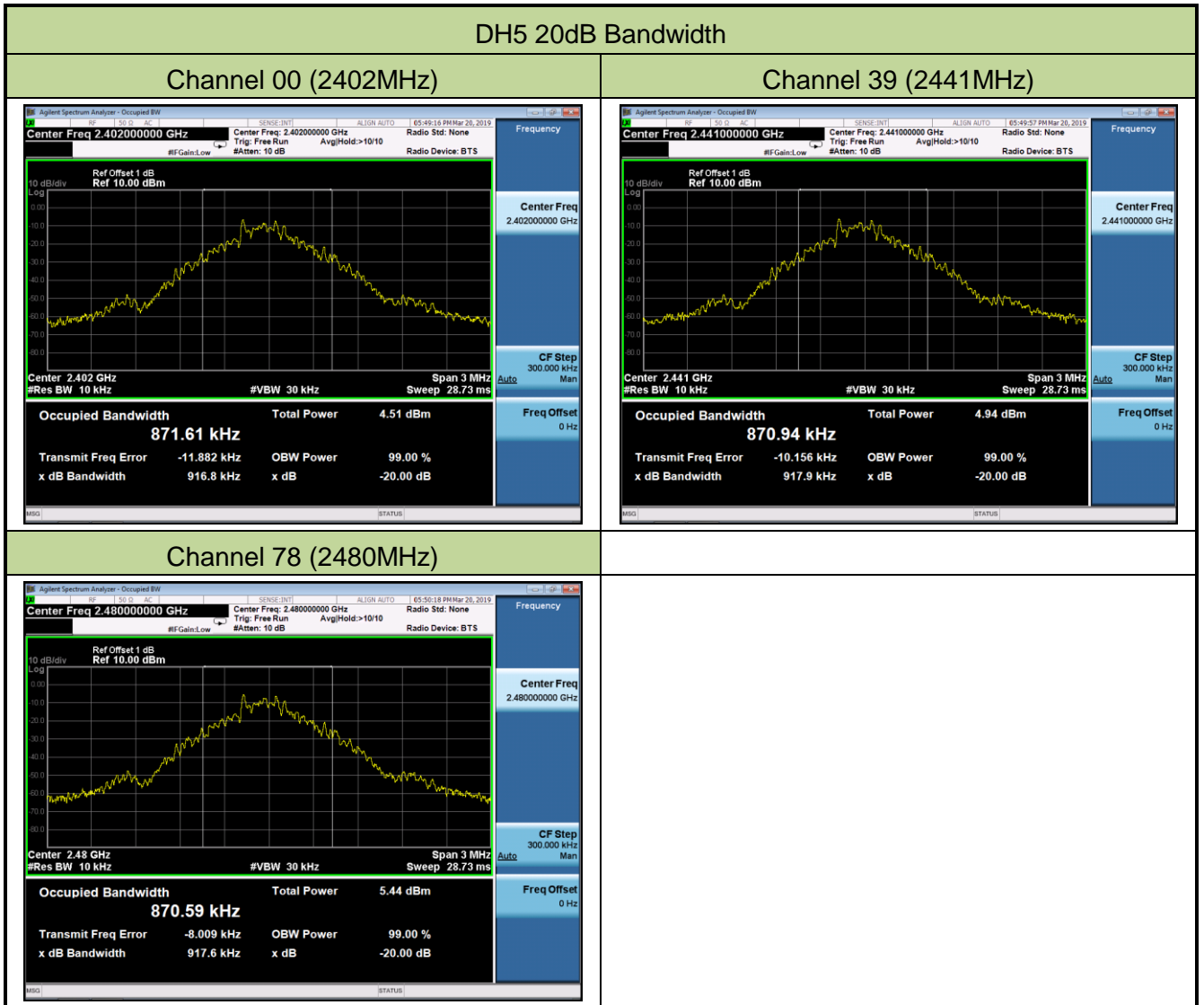

2DH5 20dB Bandwidth

Channel 00 (2402MHz)

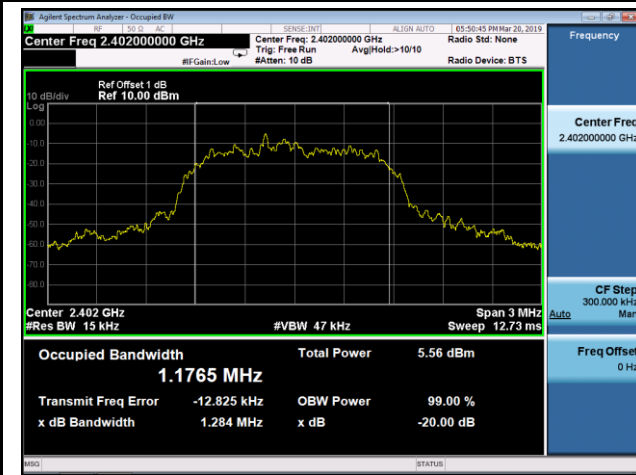

Channel 39 (2441MHz)

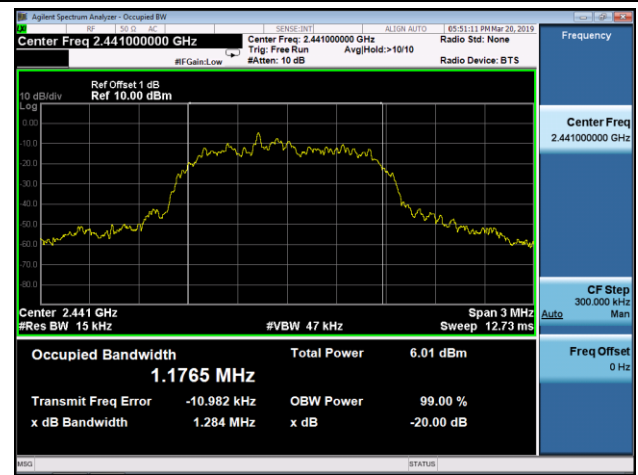

Channel 78 (2480MHz)

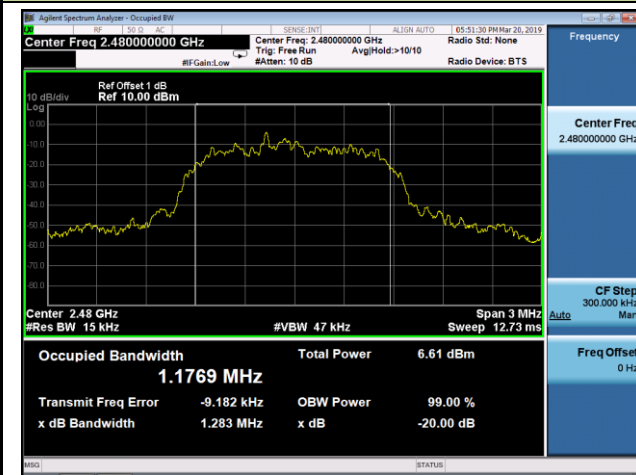

3DH5 20dB Bandwidth

Channel 00 (2402MHz)

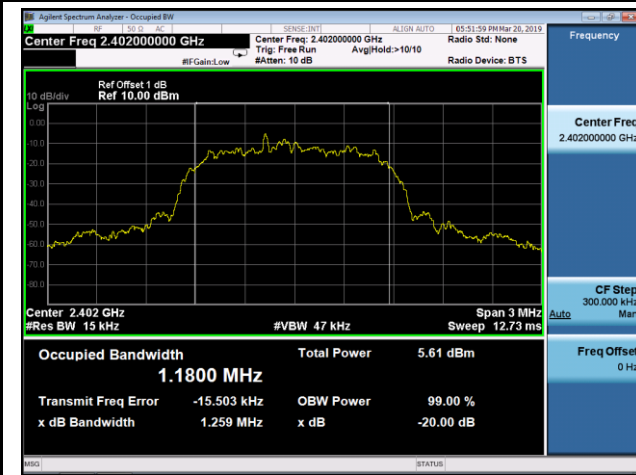

Channel 39 (2441MHz)

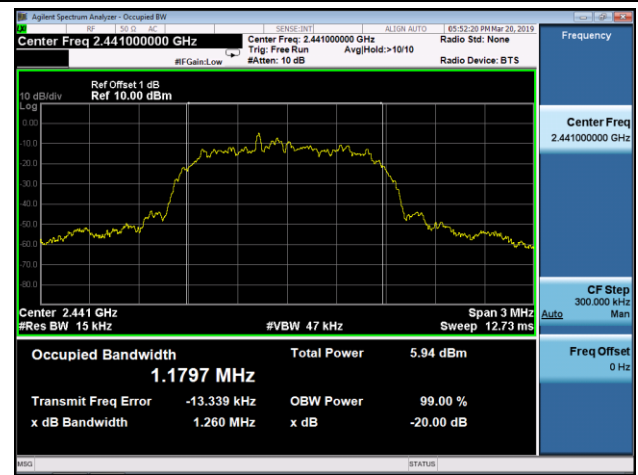

Channel 78 (2480MHz)

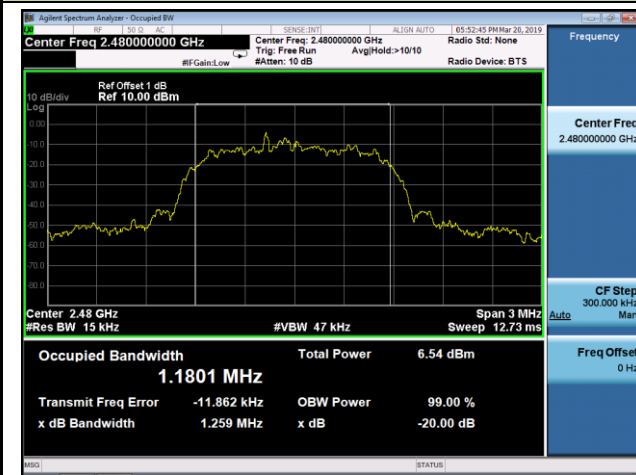



### 7.3. Output Power Measurement

#### 7.3.1. Test Limit

For frequency hopping systems operating in the 2400-2483.5MHz band employing at least 75 non-overlapping hopping channels: 1 watt.

For all other frequency hopping systems in the 2400-2483.5MHz band: 0.125 watt

#### 7.3.2. Test Procedure Used

ANSI C63.10-2013 - Section 7.8.5

#### 7.3.3. Test Setting

1. Set RBW  $\geq$  20 dB bandwidth of the emission being measured.
2. VBW  $\geq$  RBW
3. Span = approximately five times the 20dB bandwidth, centered on a hopping channel
4. Detector = peak
5. Trace mode = max hold
6. Sweep = auto couple
7. Allow the trace to stabilize, Use the marker-to-peak function to set the marker to the peak of the emission. The indicated level is the peak output power (don't forget added the external attenuation and cable loss)

#### 7.3.4. Test Setup

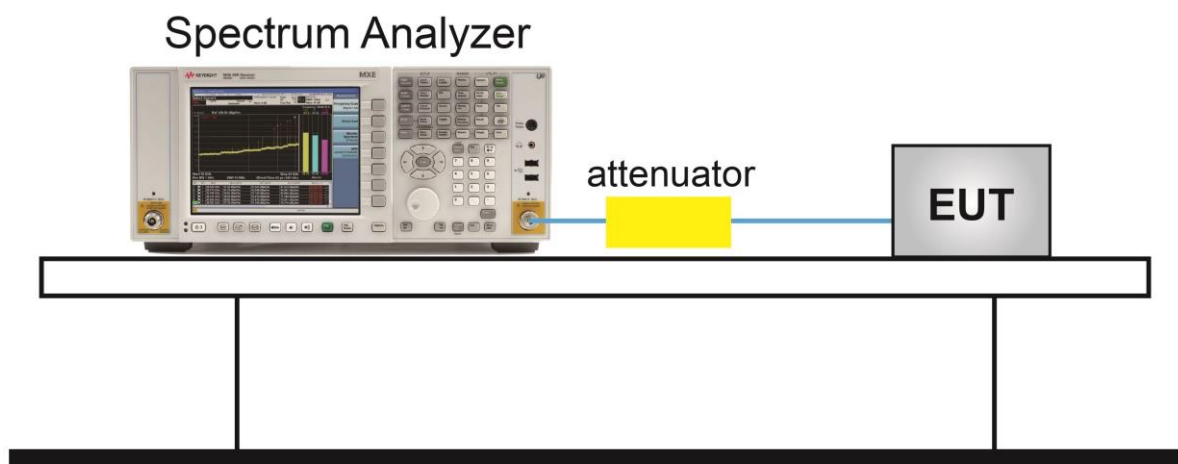

**7.3.5. Test Result**

Product	Bluetooth Speaker	Temperature	25°C
Test Engineer	Snake Ni	Relative Humidity	58%
Test Site	TR3	Test Date	2019/03/20

Test Mode	Channel No.	Frequency (MHz)	Peak Power (dBm)	Peak Power Limit (dBm)
DH5	00	2402	-1.27	≤ 30.00
DH5	39	2441	-1.04	≤ 30.00
DH5	78	2480	-0.59	≤ 30.00
2DH5	00	2402	1.72	≤ 30.00
2DH5	39	2441	1.95	≤ 30.00
2DH5	78	2480	2.57	≤ 30.00
3DH5	00	2402	2.29	≤ 30.00
3DH5	39	2441	2.55	≤ 30.00
3DH5	78	2480	3.19	≤ 30.00

DH5 Output Power

Channel 00 (2402MHz)

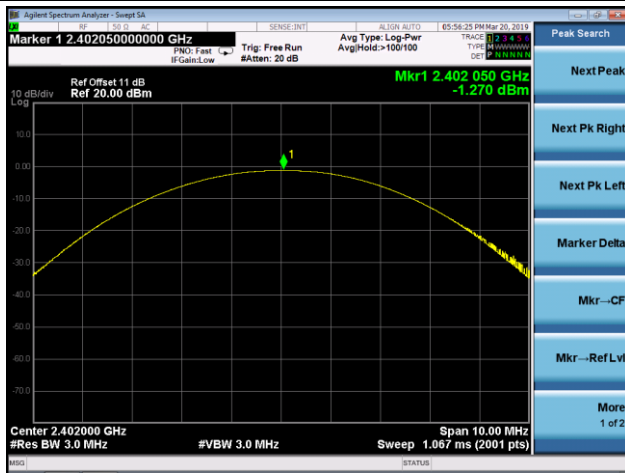

Channel 39 (2441MHz)

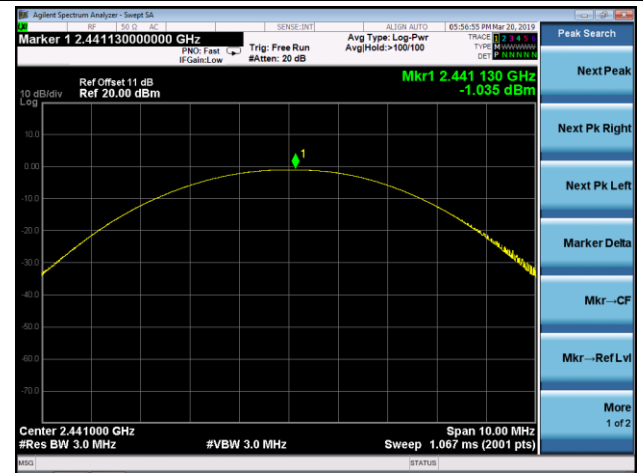

Channel 78 (2480MHz)

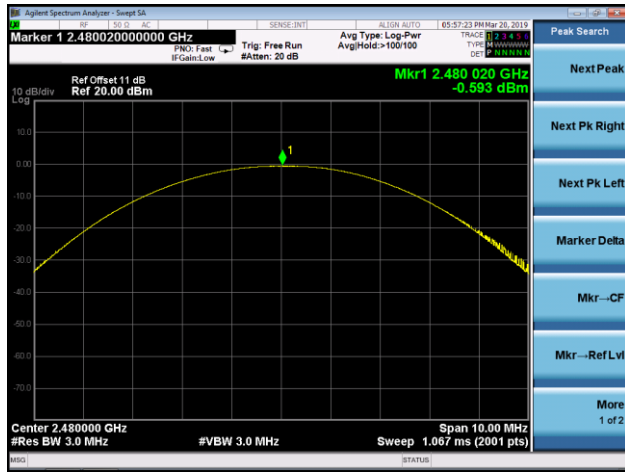

2DH5 Output Power

Channel 00 (2402MHz)

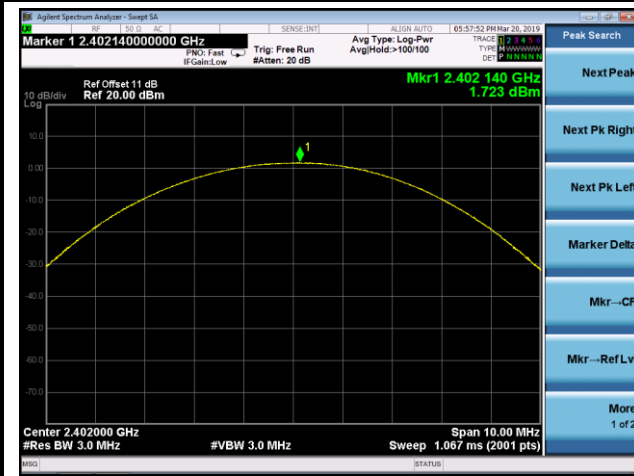

Channel 39 (2441MHz)

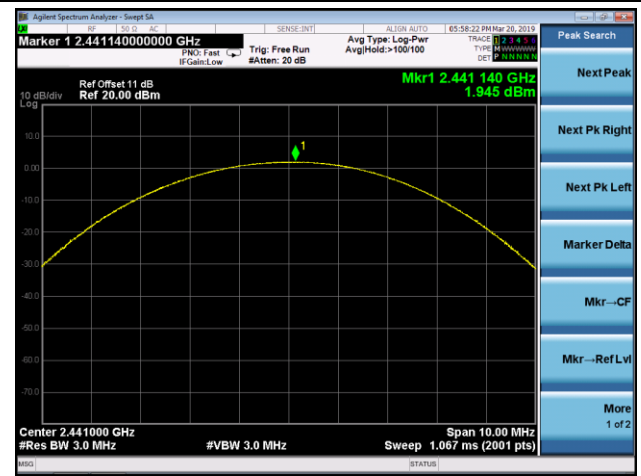

Channel 78 (2480MHz)

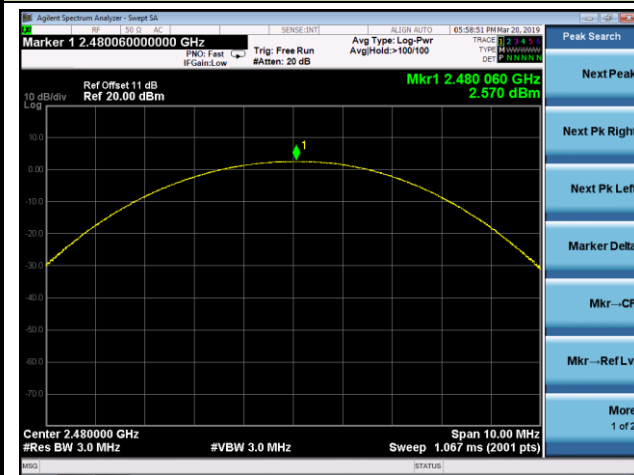

### 3DH5 Output Power

Channel 00 (2402MHz)

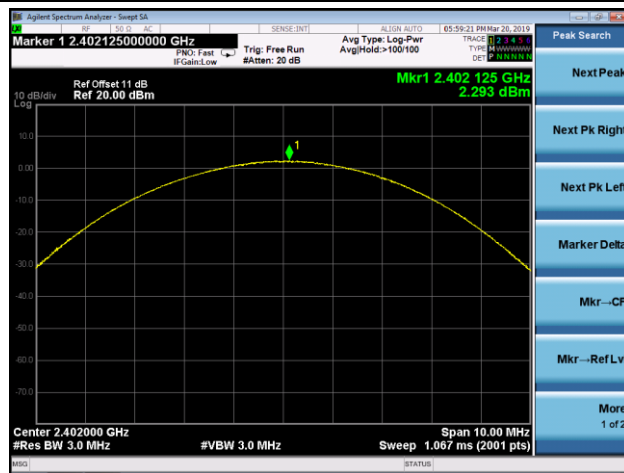

Channel 39 (2441MHz)

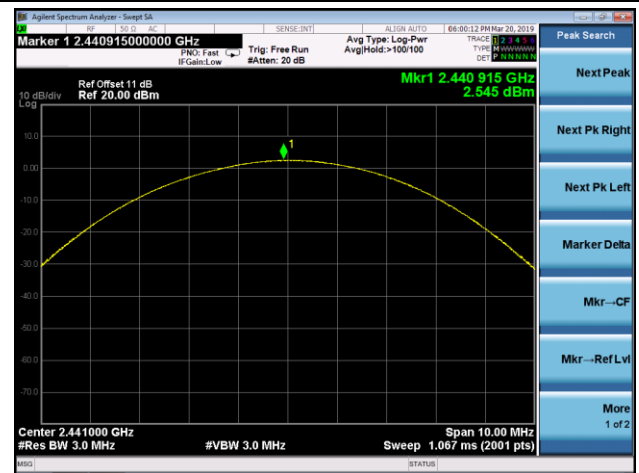

Channel 78 (2480MHz)

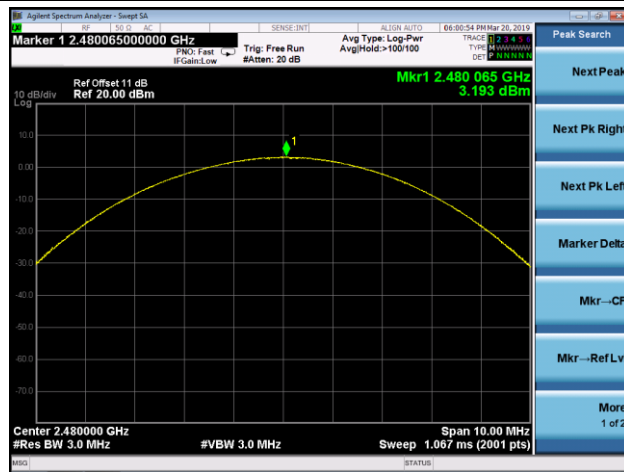

## 7.4. Carrier Frequency Separation Measurement

### 7.4.1. Test Limit

The minimum permissible channel separation for this system is  $2/3$  the value of the 20dB BW.

### 7.4.2. Test Procedure Used

ANSI C63.10-2013 - Section 7.8.2

### 7.4.3. Test Setting

1. Span = wide enough to capture the peaks of two adjacent channels.
2. Start with the RBW set to approximately 30% of the channel spacing; adjust as necessary to best identify the center of each individual channel.
3. VBW  $\geq$  RBW
4. Sweep time = auto couple
5. Detector = peak
6. Trace mode = max hold
7. Allowed the trace to stabilize
8. Use the marker-delta function to determine the separation between the peaks of the adjacent channels.

### 7.4.4. Test Setup

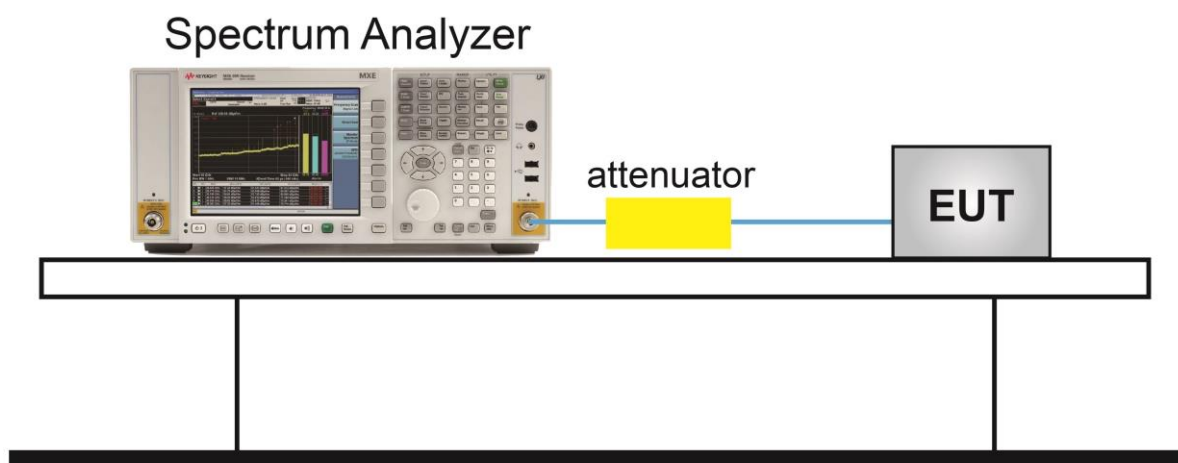

**7.4.5. Test Result**

Product	Bluetooth Speaker	Temperature	25°C
Test Engineer	Snake Ni	Relative Humidity	58%
Test Site	TR3	Test Date	2019/03/20

Test Mode	Channel No.	Frequency (MHz)	Limit (kHz)	Result
DH5	00	2402	≥ 611.20	Pass
DH5	39	2440	≥ 611.93	Pass
DH5	78	2480	≥ 611.73	Pass
2DH5	00	2402	≥ 856.00	Pass
2DH5	39	2440	≥ 856.00	Pass
2DH5	78	2480	≥ 855.33	Pass
3DH5	00	2402	≥ 839.33	Pass
3DH5	39	2440	≥ 840.00	Pass
3DH5	78	2480	≥ 839.33	Pass

Note: The Limit is 2/3 the value of the 20dB BW.

### DH5 Carrier Frequency Separation

Channel 00 (2402MHz)

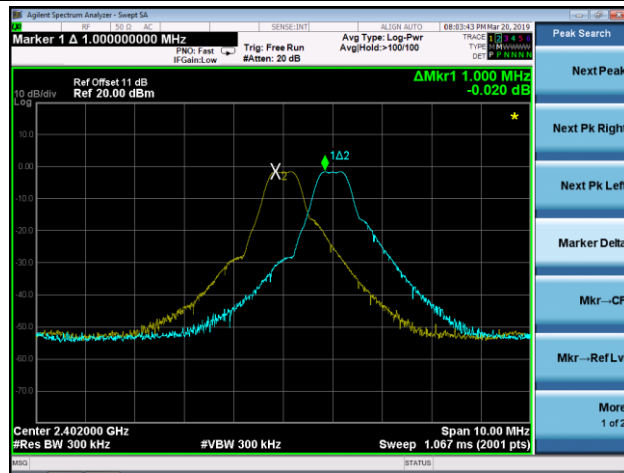

Channel 39 (2441MHz)

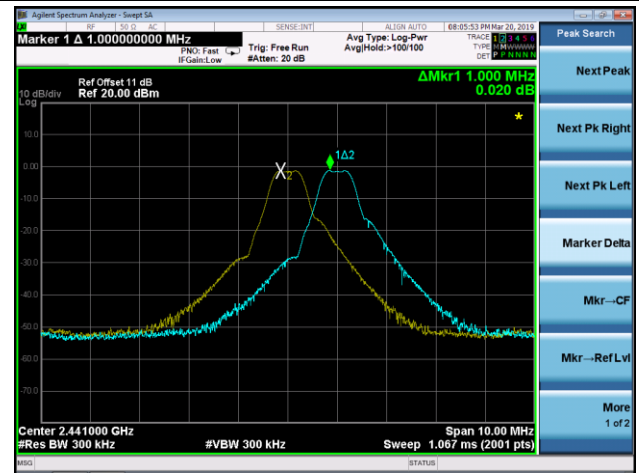

Channel 78 (2480MHz)

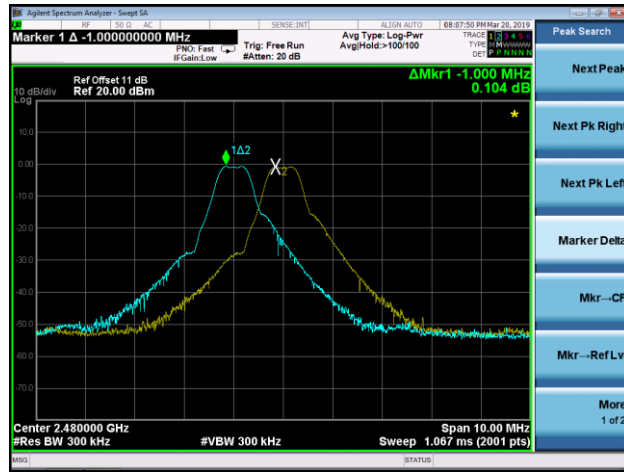



## 2DH5 Carrier Frequency Separation

Channel 00 (2402MHz)

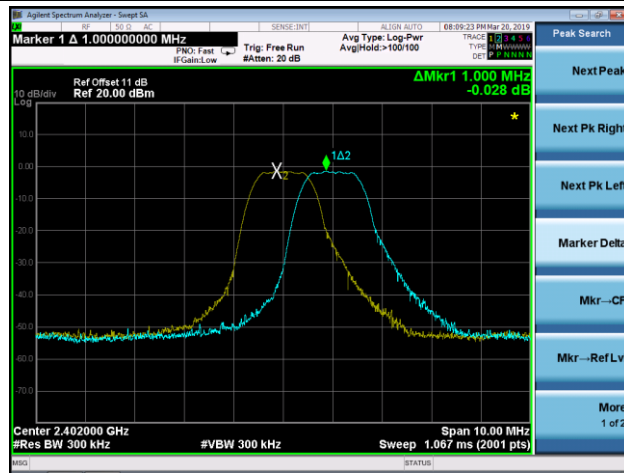

Channel 39 (2441MHz)

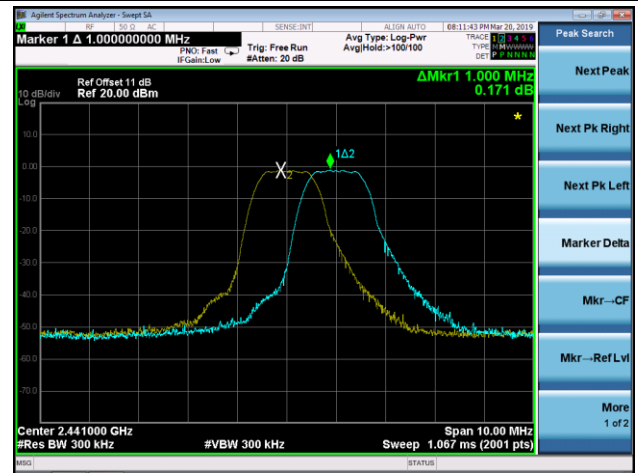

Channel 78 (2480MHz)

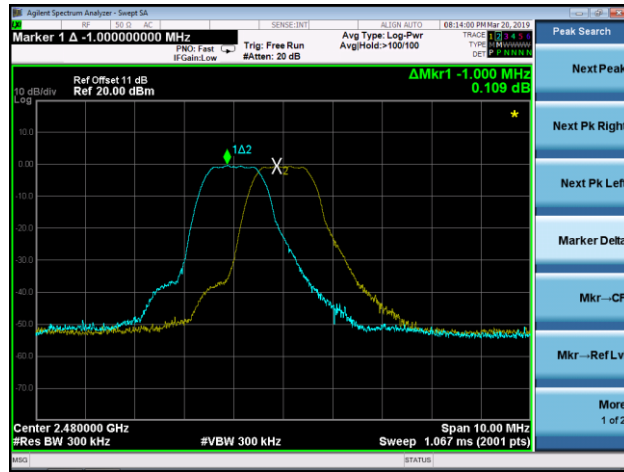

### 3DH5 Carrier Frequency Separation

Channel 00 (2402MHz)

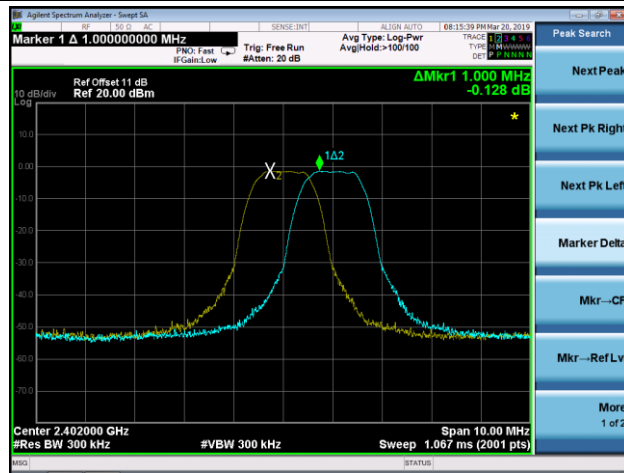

Channel 39 (2441MHz)

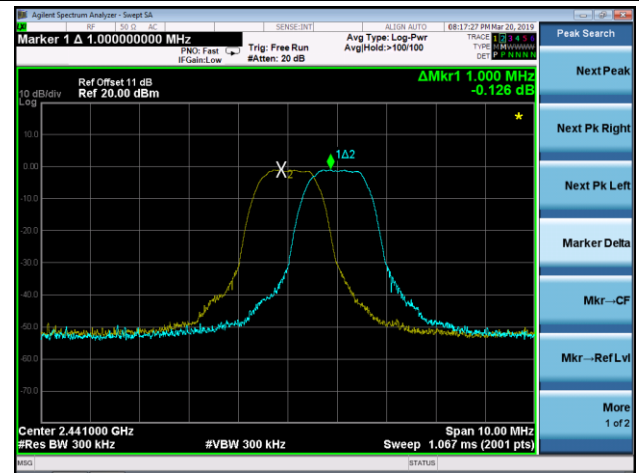

Channel 78 (2480MHz)

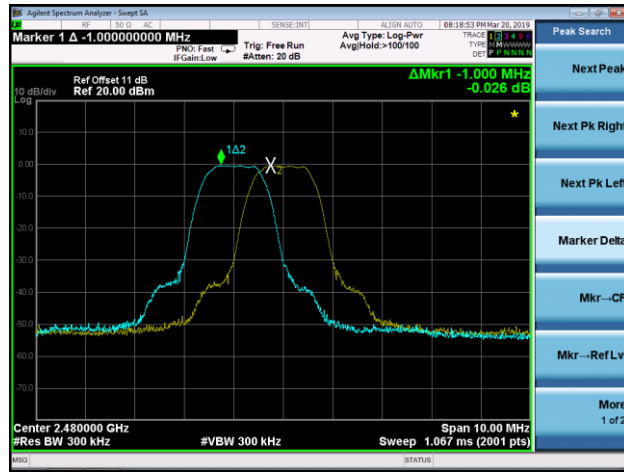

## 7.5. Number of Hopping Channels Measurement

### 7.5.1. Test Limit

This frequency hopping system must employ a minimum of 15 hopping channels.

### 7.5.2. Test Procedure Used

ANSI C63.10-2013 - Section 7.8.3

### 7.5.3. Test Setting

1. Span = the frequency band of operation. Depending on the number of channels the device supports, it may be necessary to divide the frequency range of operation across multiple spans, to allow the individual channels to be clearly seen.
2. To identify clearly the individual channels, set the RBW to less than 30% of the channel spacing or the 20 dB bandwidth, whichever is smaller.
3. VBW  $\geq$  RBW
4. Sweep time = auto couple
5. Detector = peak
6. Trace mode = max hold
7. Allow the trace to stabilize

### 7.5.4. Test Setup

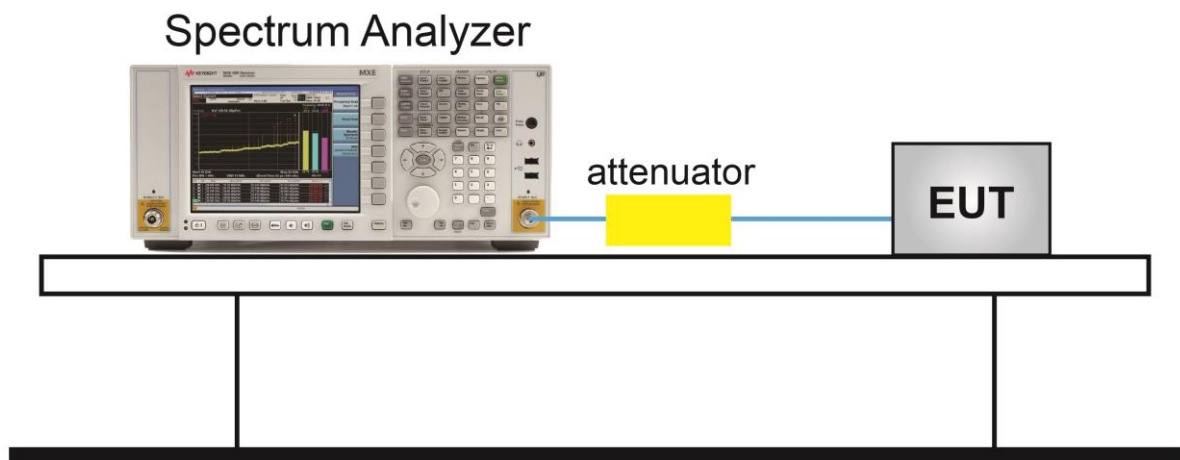

### 7.5.5. Test Result

Product	Bluetooth Speaker	Temperature	25°C
Test Engineer	Snake Ni	Relative Humidity	58%
Test Site	TR3	Test Date	2019/03/20

Test Mode (Hopping)	Channel Numbers	Frequency (MHz)	Limit (Hopping Channels)	Result
DH5	79	2402 ~ 2480	≥ 15	Pass
2DH5	79	2402 ~ 2480	≥ 15	Pass
3DH5	79	2402 ~ 2480	≥ 15	Pass



### 2DH5 Number of Hopping Channels

2402 ~ 2421MHz

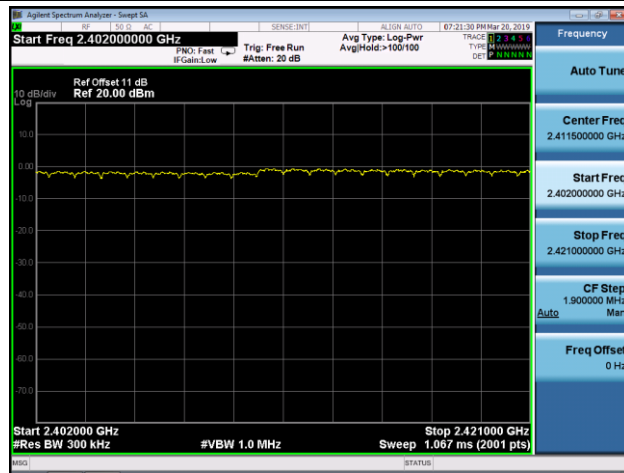

2422 ~ 2441MHz

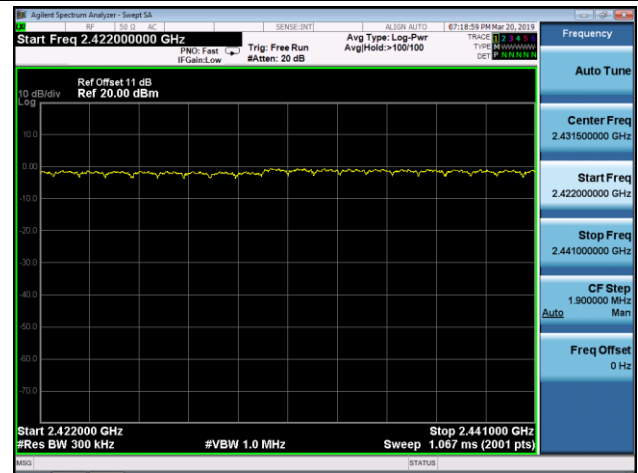

2442 ~ 2461MHz

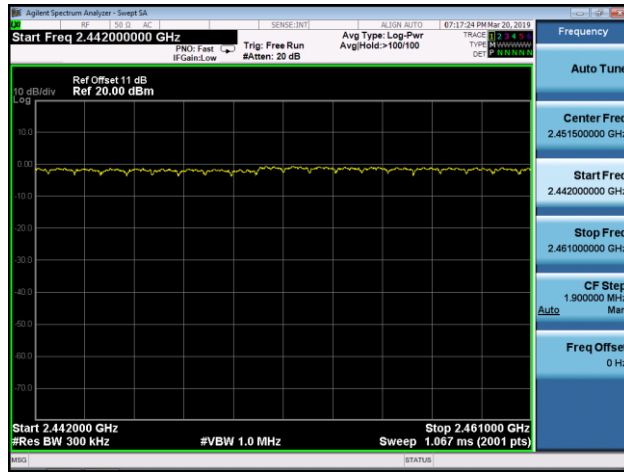

2462 ~ 2480MHz

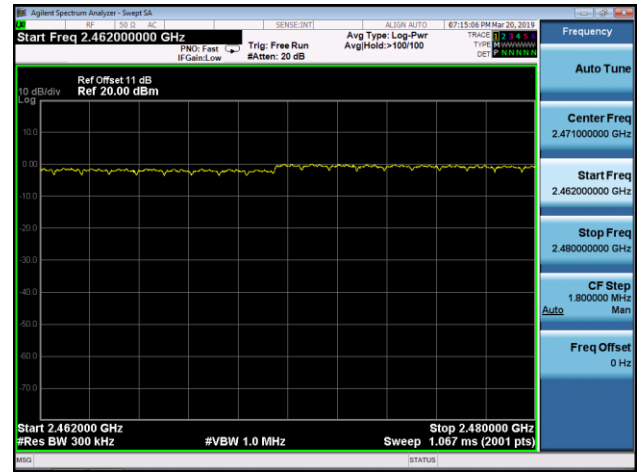

### 3DH5 Number of Hopping Channels

2402 ~ 2421MHz

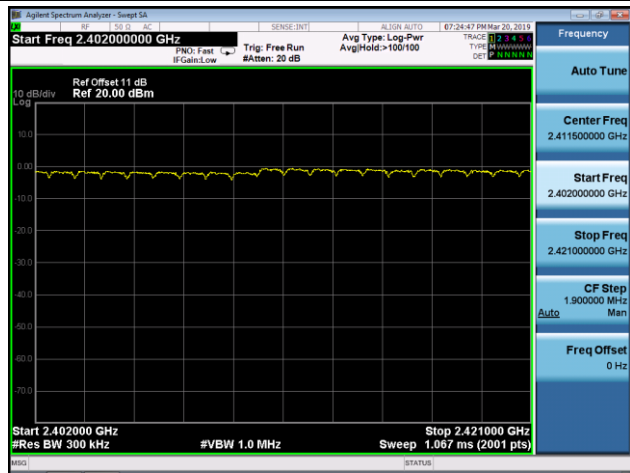

2422 ~ 2441MHz

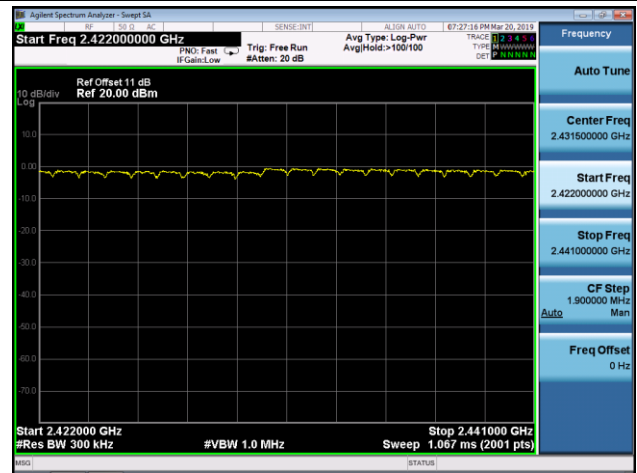

2442 ~ 2461MHz

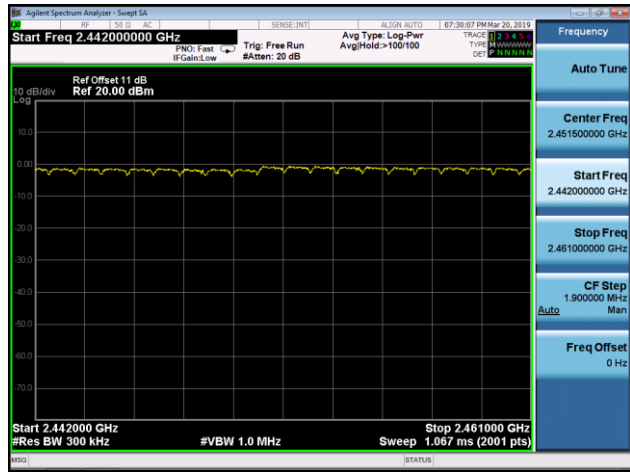

2462 ~ 2480MHz

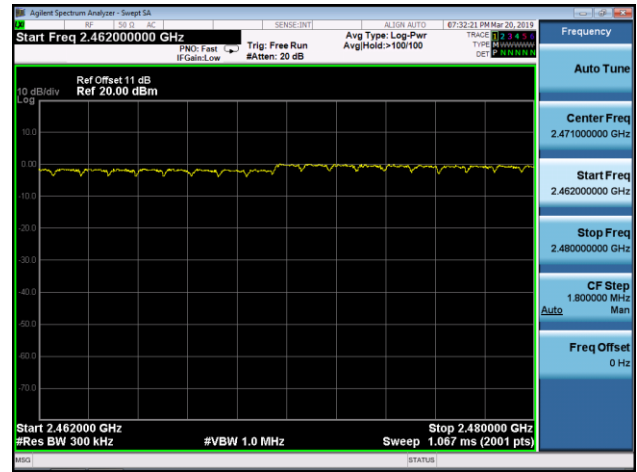

## 7.6. Time of Occupancy Measurement

### 7.6.1. Test Limit

The maximum permissible time of occupancy is 400ms within a period of 400ms multiplied by the number of hopping channels employed.

### 7.6.2. Test Procedure Used

ANSI C63.10-2013 - Section 7.8.4

### 7.6.3. Test Setting

1. Span = zero span, centered on a hopping channel.
2. RBW shall be  $\leq$  channel spacing and where possible RBW should be set  $\gg 1 / T$ , where T is the expected dwell time per channel.
3. VBW  $\geq$  RBW
4. Sweep time = as necessary to capture the entire dwell time per hopping channel
5. Detector = peak
6. Trace mode = max hold
7. Use the marker-delta function to determine the transmit time per hop. If this value varies with different modes of operation (data rate, modulation format, number of hopping channels, etc.), then repeat this test for each variation in transmit time.

### 7.6.4. Test Setup

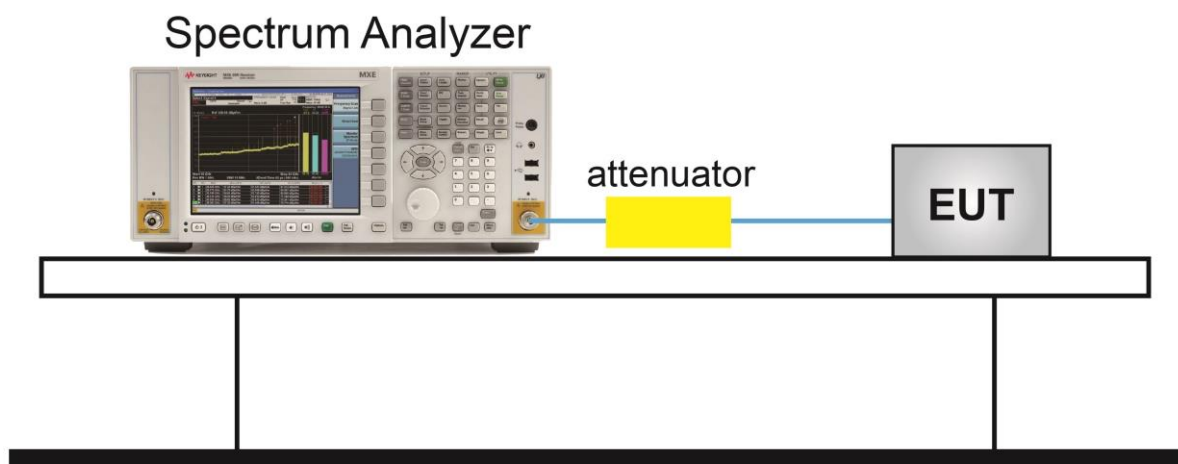

7.6.5. Test Result

Product	Bluetooth Speaker	Temperature	25 °C
Test Engineer	Snake Ni	Relative Humidity	56%
Test Site	TR3	Test Date	2019/03/20

Test Mode	Channel No.	Frequency (MHz)	Hops Over Occupancy Time(Hops)	Packet Transfer Time (ms)	Time of Occupancy (ms)	Limit (ms)	Result
3DH1	39	2441	320	0.373	119.360	≤ 400	Pass
3DH3	39	2441	160	1.623	259.680	≤ 400	Pass
3DH5	39	2441	107	2.875	307.625	≤ 400	Pass

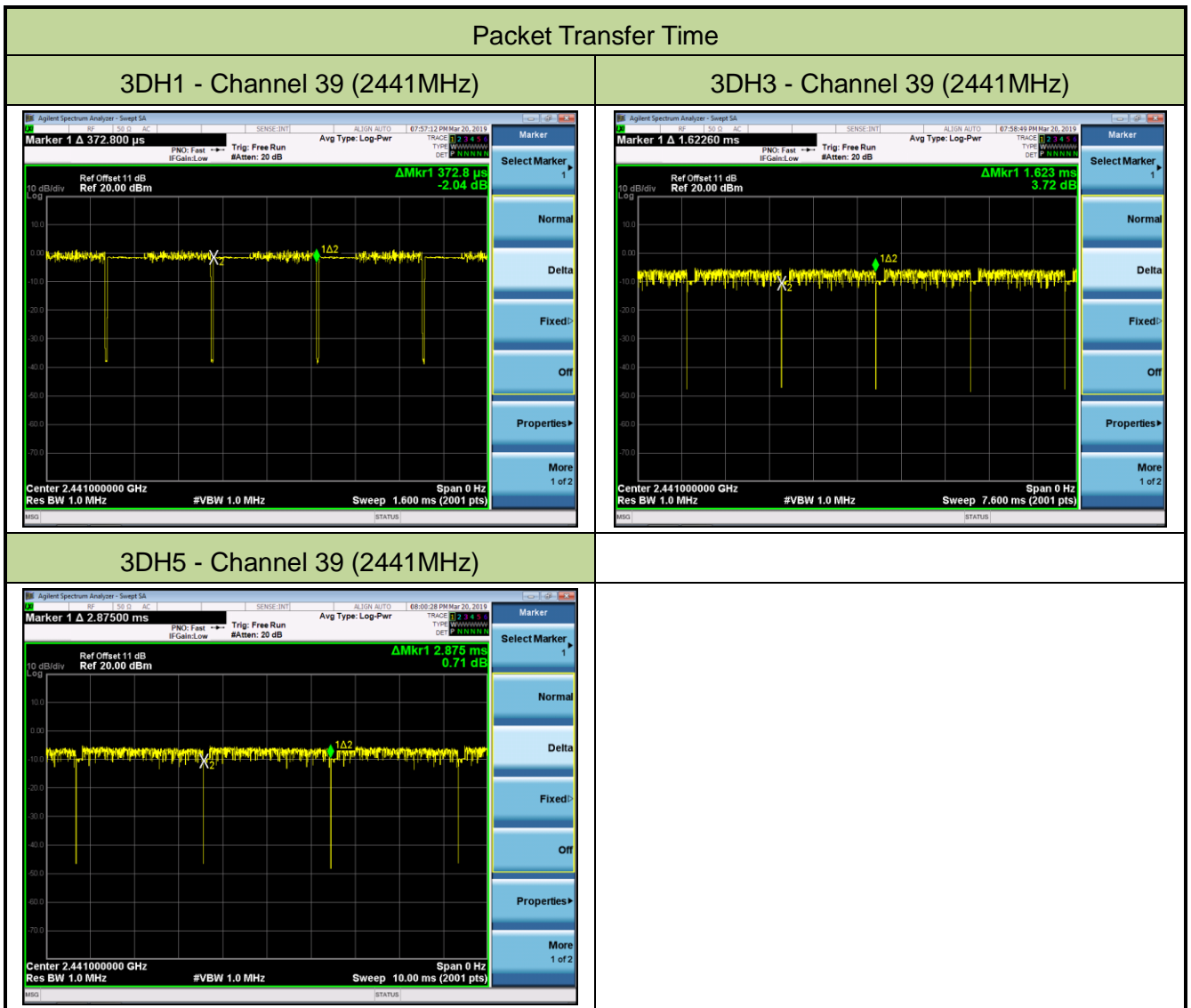



Note 1: According the Bluetooth Standard Specification, the nominal hop rate is 1600 hops/s. All Bluetooth unit participating in the piconet are time and hop synchronized to the channel.

Hops Over Occupancy Time in 31.6s for 3DH1 =  $1600 / 2 / 79 * 31.6 = 320$ .

Hops Over Occupancy Time in 31.6s for 3DH3 =  $1600 / 4 / 79 * 31.6 = 160$ .

Hops Over Occupancy Time in 31.6s for 3DH5 =  $1600 / 6 / 79 * 31.6 = 107$ .

Note 2: Time of Occupancy = Packet Transfer Time \* Hops Over Occupancy Time in 31.6s.

## **7.7. Band-edge Compliance Measurement**

### **7.7.1. Test Limit**

The maximum permissible emission level is 20dBc. Any emissions were lying outside of the emission bandwidth and in authorized band edges to a field strength limit specified in Section 15.209 of the Title 47 CFR.

### **7.7.2. Test Procedure Used**

ANSI C63.10-2013 - Section 6.10.4

### **7.7.3. Test Setting**

1. Span = wide enough to capture the peak level of the emission operating on the channel closest to the band edge, as well as any modulation products which fall outside of the authorized band of operation.
2. RBW = 100kHz
3. VBW = 300kHz
4. Detector = peak
5. Sweep time = auto couple
6. Trace mode = max hold
7. Trace was allowed to stabilize
8. Allow the trace to stabilize. Set the marker on the emission at the band edge, or on the highest modulation product outside of the band, if this level is greater than that at the band edge. Enable the marker-delta function, then use the marker-to-peak function to move the marker to the peak of the in-band emission.

### 7.7.4. Test Setup

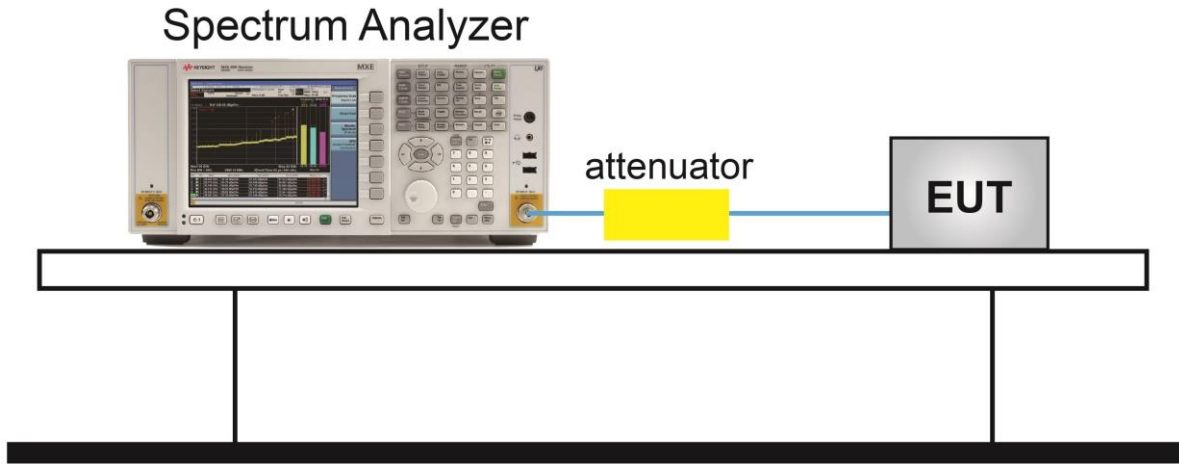

**7.7.5. Test Result**

Product	Bluetooth Speaker	Temperature	25 °C
Test Engineer	Snake Ni	Relative Humidity	56%
Test Site	TR3	Test Date	2019/03/20

Test Mode	Channel No.	Frequency (MHz)	Limit	Result
DH5	00	2402	20dBc	Pass
DH5	78	2480	20dBc	Pass
2DH5	00	2402	20dBc	Pass
2DH5	78	2480	20dBc	Pass
3DH5	00	2402	20dBc	Pass
3DH5	78	2480	20dBc	Pass