FCC Test Report

Report No.: AGC00275190902FE03

FCC ID : 2AB9SBTE008
APPLICATION PURPOSE : Original Equipment
PRODUCT DESIGNATION : Wireless headphone
BRAND NAME : Jonter, Yinko, BAUHN
MODEL NAME : BTE008, HE180292
APPLICANT : Shenzhen Jonter Digital Co., Ltd.
DATE OF ISSUE : Sep. 20, 2019
STANDARD(S) : FCC Part 15.247
REPORT VERSION : V1.0

Attestation of Global Compliance (Shenzhen) Co., Ltd

CAUTION:

This report shall not be reproduced except in full without the written permission of the test laboratory and shall not be quoted out of context.

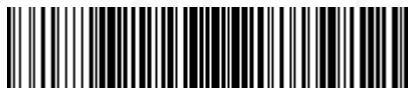

REPORT REVISE RECORD

| Report Version | Revise Time | Issued Date | Valid Version | Notes |
|----------------|-------------|---------------|---------------|-----------------|
| V1.0 | / | Sep. 20, 2019 | Valid | Initial Release |



TABLE OF CONTENTS

| | |
|---|-----------|
| 1. VERIFICATION OF CONFORMITY | 5 |
| 2. GENERAL INFORMATION | 6 |
| 2.1. PRODUCT DESCRIPTION | 6 |
| 2.2. TABLE OF CARRIER FREQUENCIES | 6 |
| 2.3. RECEIVER INPUT BANDWIDTH | 7 |
| 2.4. EXAMPLE OF A HOPPING SEQUENCY IN DATA MODE | 7 |
| 2.5. EQUALLY AVERAGE USE OF FREQUENCIES AND BEHAVIOUR | 7 |
| 2.6. RELATED SUBMITTAL(S) / GRANT (S) | 8 |
| 2.7. TEST METHODOLOGY | 8 |
| 2.8. SPECIAL ACCESSORIES | 8 |
| 2.9. EQUIPMENT MODIFICATIONS | 8 |
| 3. MEASUREMENT UNCERTAINTY | 9 |
| 4. DESCRIPTION OF TEST MODES | 10 |
| 5. SYSTEM TEST CONFIGURATION | 11 |
| 5.1. CONFIGURATION OF EUT SYSTEM | 11 |
| 5.2. EQUIPMENT USED IN TESTED SYSTEM | 11 |
| 5.3. SUMMARY OF TEST RESULTS | 11 |
| 6. TEST FACILITY | 12 |
| 7. PEAK OUTPUT POWER | 13 |
| 7.1. MEASUREMENT PROCEDURE | 13 |
| 7.2. TEST SET-UP (BLOCK DIAGRAM OF CONFIGURATION) | 13 |
| 7.3. LIMITS AND MEASUREMENT RESULT | 14 |
| 8. 20DB BANDWIDTH | 20 |
| 8.1. MEASUREMENT PROCEDURE | 20 |
| 8.2. TEST SET-UP (BLOCK DIAGRAM OF CONFIGURATION) | 20 |
| 8.3. LIMITS AND MEASUREMENT RESULTS | 20 |
| 9. CONDUCTED SPURIOUS EMISSION | 27 |
| 9.1. MEASUREMENT PROCEDURE | 27 |
| 9.2. TEST SET-UP (BLOCK DIAGRAM OF CONFIGURATION) | 27 |
| 9.3. MEASUREMENT EQUIPMENT USED | 27 |

9.4. LIMITS AND MEASUREMENT RESULT 27

10. RADIATED EMISSION..... 37

10.1. MEASUREMENT PROCEDURE 37

10.2. TEST SETUP..... 39

10.3. LIMITS AND MEASUREMENT RESULT 40

10.4. TEST RESULT..... 40

11. NUMBER OF HOPPING FREQUENCY 50

11.1. MEASUREMENT PROCEDURE 50

11.2. TEST SETUP (BLOCK DIAGRAM OF CONFIGURATION)..... 50

11.3. MEASUREMENT EQUIPMENT USED 50

11.4. LIMITS AND MEASUREMENT RESULT 50

12. TIME OF OCCUPANCY (DWELL TIME) 51

12.1. MEASUREMENT PROCEDURE 51

12.2. TEST SETUP (BLOCK DIAGRAM OF CONFIGURATION)..... 51

12.3. MEASUREMENT EQUIPMENT USED 51

12.4. LIMITS AND MEASUREMENT RESULT 51

13. FREQUENCY SEPARATION..... 55

13.1. MEASUREMENT PROCEDURE 55

13.2. TEST SETUP (BLOCK DIAGRAM OF CONFIGURATION)..... 55

13.3. MEASUREMENT EQUIPMENT USED 55

13.4. LIMITS AND MEASUREMENT RESULT 55

APPENDIX A: PHOTOGRAPHS OF TEST SETUP 56

APPENDIX B: PHOTOGRAPHS OF EUT 57

1. VERIFICATION OF CONFORMITY

| | |
|---------------------------------|--|
| Applicant | Shenzhen Jonter Digital Co., Ltd. |
| Address | Floor 3, Building 4, Jinfo Industrial Park, Hezhou Village Hangcheng Street, Bao'an District, Shenzhen, China |
| Manufacturer | Shenzhen Jonter Digital Co., Ltd. |
| Address | Floor 3, Building 4, Jinfo Industrial Park, Hezhou Village Hangcheng Street, Bao'an District, Shenzhen, China |
| Factory | Shenzhen Jonter Digital Co., Ltd. |
| Address | Floor 3, Building 4, Jinfo Industrial Park, Hezhou Village Hangcheng Street, Bao'an District, Shenzhen, China |
| Product Designation | Wireless headphone |
| Brand Name | Jonter, Yinko, BAUHN |
| Test Model | BTE008 |
| Series Model | HE180292 |
| Difference description | All the same except for the model name Jonter and Yinko correspond to the model number: BTE008 BAUHN's corresponding model: HE180292 |
| Date of test | Sep. 11, 2019 to Sep. 19, 2019 |
| Deviation | None |
| Condition of Test Sample | Normal |
| Test Result | Pass |
| Report Template | AGCRT-US-BR/RF |

We hereby certify that:

The above equipment was tested by Attestation of Global Compliance (Shenzhen) Co., Ltd. The test data, data evaluation, test procedures, and equipment configurations shown in this report were made in accordance with the procedures given in ANSI C63.10 (2013) and the energy emitted by the sample EUT tested as described in this report is in compliance with radiated emission limits of FCC PART 15.247.

Prepared By

Nini

Nini Guo
(Project Engineer)

Sep. 19, 2019

Reviewed By

Max Zhang

Max Zhang
(Reviewer)

Sep. 20, 2019

Approved By

Forrest Lei

Forrest Lei
(Authorized Officer)

Sep. 20, 2019



2. GENERAL INFORMATION

2.1. PRODUCT DESCRIPTION

The EUT is designed as “Wireless headphone”. It is designed by way of utilizing the GFSK, Pi/4 DQPSK and 8DPSK technology to achieve the system operation.

A major technical description of EUT is described as following

| | |
|----------------------------|---|
| Operation Frequency | 2.402 GHz to 2.480GHz |
| RF Output Power | -0.547dBm(Max) |
| Bluetooth Version | V 5.0 |
| Modulation | BR <input checked="" type="checkbox"/> GFSK, EDR <input checked="" type="checkbox"/> π /4-DQPSK, <input checked="" type="checkbox"/> 8DPSK BLE <input type="checkbox"/> GFSK 1Mbps <input type="checkbox"/> GFSK 2Mbps |
| Number of channels | 79 |
| Hardware Version | V03 |
| Software Version | V0.04 |
| Antenna Designation | Ceramic Antenna (Comply with requirements of the FCC part 15.203) |
| Antenna Gain | 2dBi |
| Power Supply | DC 3.7V by battery or DC 5V by adapter |

2.2. TABLE OF CARRIER FREQUENCIES

| Frequency Band | Channel Number | Frequency |
|----------------|----------------|-----------|
| 2402~2480MHZ | 0 | 2402MHZ |
| | 1 | 2403MHZ |
| | : | : |
| | 38 | 2440 MHZ |
| | 39 | 2441 MHZ |
| | 40 | 2442 MHZ |
| | : | : |
| | 77 | 2479 MHZ |
| | 78 | 2480 MHZ |

2.3. RECEIVER INPUT BANDWIDTH

The input bandwidth of the receiver is 1.3MHz. In every connection one Bluetooth device is the master and the other one is slave. The master determines the hopping sequence. The slave follows this sequence. Both devices shift between RX and TX time slot according to the clock of the master. Additionally the type of connection (e.g. single or multislot packet) is set up at the beginning of the connection. The master adapts its hopping frequency and its TX/RX timing according to the packet type of the connection. Also the slave of the connection will use these settings.

Repeating of a packet has no influence on the hopping sequence. The hopping sequence generated by the master of the connection will be followed in any case. That means, a repeated packet will not be sent on the same frequency, it is sent on the next frequency of the hopping sequence.

2.4. EXAMPLE OF A HOPPING SEQUENCE IN DATA MODE

Example of a 79 hopping sequence in data mode:

40,21,44,23,42,53,46,55,48,33,52,35,50,65,54,67
56,37,60,39,58,69,62,71,64,25,68,27,66,57,70,59
72,29,76,31,74,61,78,63,01,41,05,43,03,73,07,75
09,45,13,47,11,77,15,00,64,49,66,53,68,02,70,06
01, 51, 03, 55, 05, 04

2.5. EQUALLY AVERAGE USE OF FREQUENCIES AND BEHAVIOUR

The generation of the hopping sequence in connection mode depends essentially on two input values:

1. LAP/UAP of the master of the connection.
2. Internal master clock

The LAP (lower address part) are the 24 LSB's of the 48 BD_ADDRESS. The BD_ADDRESS is an unambiguous number of every Bluetooth unit. The UAP (upper address part) are the 24 MSB's of the 48 BD_ADDRESS.

The internal clock of a Bluetooth unit is derived from a free running clock which is never adjusted and is never turned off. For synchronization with other units only offsets are used. It has no relation to the time of the day. Its resolution is at least half the RX/TX slot length of 312.5us. The clock has a cycle of about one day (23h30). In most cases it is implemented as a 28-bit counter. For the deriving of the hopping sequence the entire LAP (24 bits), 4 LSB's (4 bits) (Input 1) and the 27 MSB's of the clock (Input 2) are used. With these input values different mathematical procedures (permutations, additions, XOR-operations) are performed to generate the sequence. This will be done at the beginning of every new transmission.

Regarding short transmissions the Bluetooth system has the following behavior:

The first connection between the two devices is established, a hopping sequence was generated. For transmitting the wanted data the complete hopping sequence was not used. The connection ended.

The second connection will be established. A new hopping sequence is generated. Due to the fact the Bluetooth clock has a different value, because the period between the two transmissions is longer (and it cannot be shorter) than the minimum resolution of the clock (312.5us). The hopping sequence will always differ from the first one.

2.6. RELATED SUBMITTAL(S) / GRANT (S)

This submittal(s) (test report) is intended for **FCC ID: 2AB9SBTE008** filing to comply with the FCC PART 15.247 requirements.

2.7. TEST METHODOLOGY

Both conducted and radiated testing was performed according to the procedures in ANSI C63.10 (2013). Radiated testing was performed at an antenna to EUT distance 3 meters.

2.8. SPECIAL ACCESSORIES

Refer to section 5.2.

2.9. EQUIPMENT MODIFICATIONS

Not available for this EUT intended for grant.



3. MEASUREMENT UNCERTAINTY

The reported uncertainty of measurement $y \pm U$, where expanded uncertainty U is based on a standard uncertainty multiplied by a coverage factor of $k=2$, providing a level of confidence of approximately 95%.

- Uncertainty of Conducted Emission, $U_c = \pm 3.2$ dB
- Uncertainty of Radiated Emission below 1GHz, $U_c = \pm 3.9$ dB
- Uncertainty of Radiated Emission above 1GHz, $U_c = \pm 4.8$ dB
- Uncertainty of total RF power, conducted, $U_c = \pm 0.8$ dB
- Uncertainty of spurious emissions, conducted, $U_c = \pm 2.7$ dB
- Uncertainty of Occupied Channel Bandwidth: $U_c = \pm 2$ %
- Uncertainty of Dwell Time: $U_c = \pm 2$ %
- Uncertainty of Frequency: $U_c = \pm 2$ %



4. DESCRIPTION OF TEST MODES

| NO. | TEST MODE DESCRIPTION |
|-----|-------------------------------|
| 1 | Low channel GFSK |
| 2 | Middle channel GFSK |
| 3 | High channel GFSK |
| 4 | Low channel $\pi/4$ -DQPSK |
| 5 | Middle channel $\pi/4$ -DQPSK |
| 6 | High channel $\pi/4$ -DQPSK |
| 7 | Low channel 8DPSK |
| 8 | Middle channel 8DPSK |
| 9 | High channel 8DPSK |
| 10 | Hopping mode GFSK |
| 11 | Hopping mode $\pi/4$ -DQPSK |
| 12 | Hopping mode 8DPSK |

Note:

1. Only the result of the worst case was recorded in the report, if no other cases.
2. For Radiated Emission, 3axis were chosen for testing for each applicable mode.
3. For Conducted Test method, a temporary antenna connector is provided by the manufacture.
4. The test software is the Airoha.AB152xU_LabTestTool which can set the EUT into the individual test modes.



5. SYSTEM TEST CONFIGURATION

5.1. CONFIGURATION OF EUT SYSTEM

Radiated Emission Configure :



5.2 EQUIPMENT USED IN TESTED SYSTEM

| Item | Equipment | Model No. | ID or Specification | Remark |
|------|--------------------|-----------|---------------------|--------|
| 1 | Wireless headphone | BTE008 | 2AB9SBTE008 | EUT |

5.3. SUMMARY OF TEST RESULTS

| FCC RULES | DESCRIPTION OF TEST | RESULT |
|--------------------|-----------------------------|-----------|
| 15.247 (b)(1) | Peak Output Power | Compliant |
| 15.247 (a)(1) | 20 dB Bandwidth | Compliant |
| 15.247 (d) | Conducted Spurious Emission | Compliant |
| 15.209 | Radiated Emission | Compliant |
| 15.247 (a)(1)(iii) | Number of Hopping Frequency | Compliant |
| 15.247 (a)(1)(iii) | Time of Occupancy | Compliant |
| 15.247 (a)(1) | Frequency Separation | Compliant |
| 15.207 | Conducted Emission | N/A |

Note: The EUT can not use the BT function with charging



6. TEST FACILITY

| | |
|--|--|
| Test Site | Attestation of Global Compliance (Shenzhen) Co., Ltd |
| Location | 1-2/F, Building 19, Junfeng Industrial Park, Chongqing Road, Heping Community, Fuhai Street, Bao'an District, Shenzhen, Guangdong, China |
| Designation Number | CN1259 |
| FCC Test Firm Registration Number | 975832 |
| A2LA Cert. No. | 5054.02 |
| Description | Attestation of Global Compliance(Shenzhen) Co., Ltd is accredited by A2LA |

TEST EQUIPMENT OF RADIATED EMISSION TEST

| Equipment | Manufacturer | Model | S/N | Cal. Date | Cal. Due |
|--------------------------------|----------------|--------------|------------|---------------|---------------|
| TEST RECEIVER | R&S | ESCI | 10096 | Jun. 12, 2019 | Jun. 11, 2020 |
| EXA Signal Analyzer | Aglient | N9010A | MY53470504 | Dec. 20, 2018 | Dec. 19, 2019 |
| 2.4GHz Fliter | EM Electronics | 2400-2500MHz | N/A | Feb. 27, 2019 | Feb. 26, 2020 |
| Attenuator | ZHINAN | E-002 | N/A | Aug. 26, 2019 | Aug. 25, 2020 |
| Horn antenna | SCHWARZBECK | BBHA 9170 | #768 | Sep. 21, 2017 | Sep. 20, 2020 |
| Active loop antenna (9K-30MHz) | ZHINAN | ZN30900C | 18051 | Jun. 14, 2018 | Jun. 13, 2020 |
| Double-Ridged Waveguide Horn | ETS LINDGREN | 3117 | 00034609 | May. 26, 2018 | May. 25, 2020 |
| Broadband Preamplifier | ETS LINDGREN | 3117PA | 00225134 | Oct. 25, 2018 | Oct. 24, 2019 |
| ANTENNA | SCHWARZBECK | VULB9168 | D69250 | Sep. 28, 2017 | Sep. 27, 2019 |



7. PEAK OUTPUT POWER

7.1. MEASUREMENT PROCEDURE

For peak power test:

1. Connect EUT RF output port to the Spectrum Analyzer through an RF attenuator
2. Span: Approximately five times the 20 dB bandwidth, centered on a hopping channel.
3. RBW > 20 dB bandwidth of the emission being measured.
4. VBW \geq RBW.
5. Sweep: Auto.
6. Detector function: Peak.
7. Trace: Max hold.

Allow trace to stabilize. Use the marker-to-peak function to set the marker to the peak of the emission. The indicated level is the peak output power, after any corrections for external attenuators and cables.

7.2. TEST SET-UP (BLOCK DIAGRAM OF CONFIGURATION)

PEAK POWER TEST SETUP

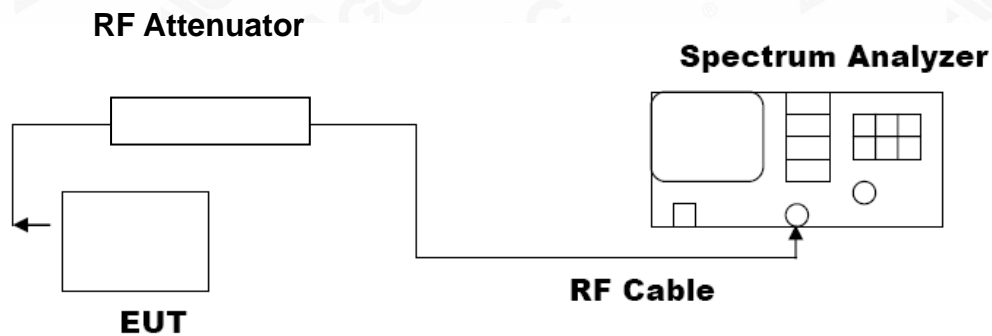

7.3. LIMITS AND MEASUREMENT RESULT

| PEAK OUTPUT POWER MEASUREMENT RESULT FOR GFSK MOUDULATION | | | |
|--|------------------|-------------------------|--------------|
| Frequency (GHz) | Peak Power (dBm) | Applicable Limits (dBm) | Pass or Fail |
| 2.402 | -1.157 | 30 | Pass |
| 2.441 | -1.580 | 30 | Pass |
| 2.480 | -2.214 | 30 | Pass |

CH0

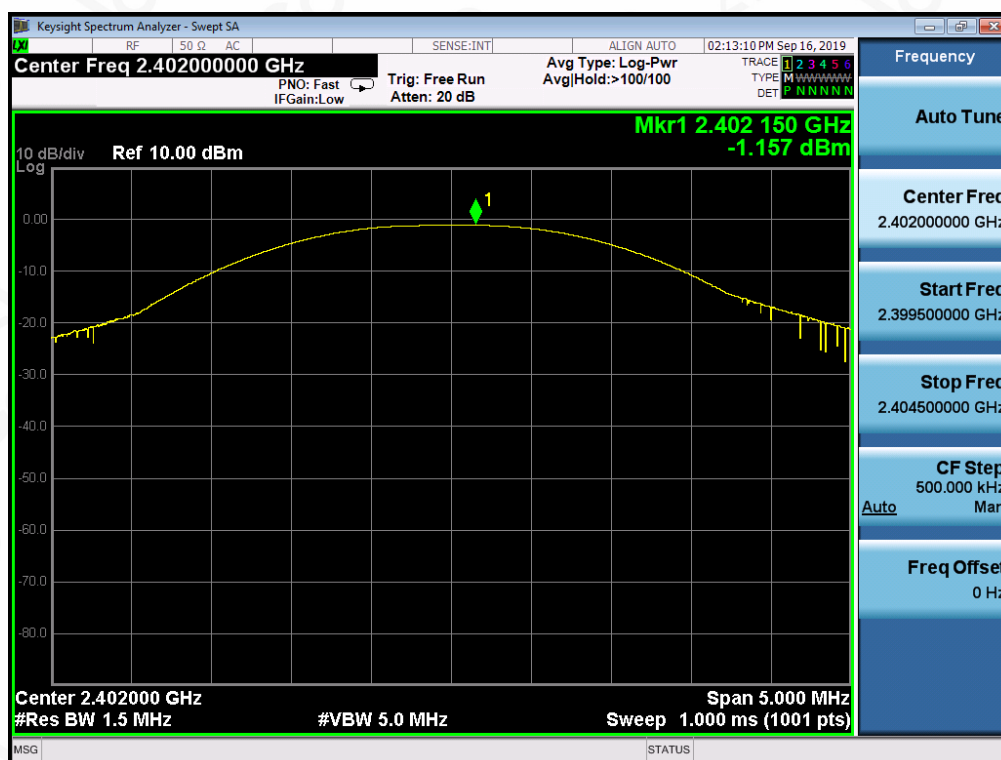

Attestation of Global Compliance

Attestation of Global Compliance(Shenzhen)Co.,Ltd.
Add: 2/F., Building 2, Sanwei Chaxi Industrial Park, Sanwei Community,
Hangcheng Street, Bao'an District, Shenzhen, Guangdong, China
Tel: +86-755 2523 4088 E-mail: agc@agc-cert.com Service Hotline:400 089 2118

CH39



CH78



Attestation of Global Compliance

Attestation of Global Compliance(Shenzhen)Co.,Ltd.
Add: 2/F., Building 2, Sanwei Chaxi Industrial Park, Sanwei Community,
Hangcheng Street, Bao'an District, Shenzhen, Guangdong, China
Tel: +86-755 2523 4088 E-mail: agc@agc-cert.com Service Hotline:400 089 2118

| PEAK OUTPUT POWER MEASUREMENT RESULT FOR Π /4-DQPSK MODULATION | | | |
|---|------------------|-------------------------|--------------|
| Frequency (GHz) | Peak Power (dBm) | Applicable Limits (dBm) | Pass or Fail |
| 2.402 | -0.620 | 30 | Pass |
| 2.441 | -0.878 | 30 | Pass |
| 2.480 | -1.398 | 30 | Pass |

CH0

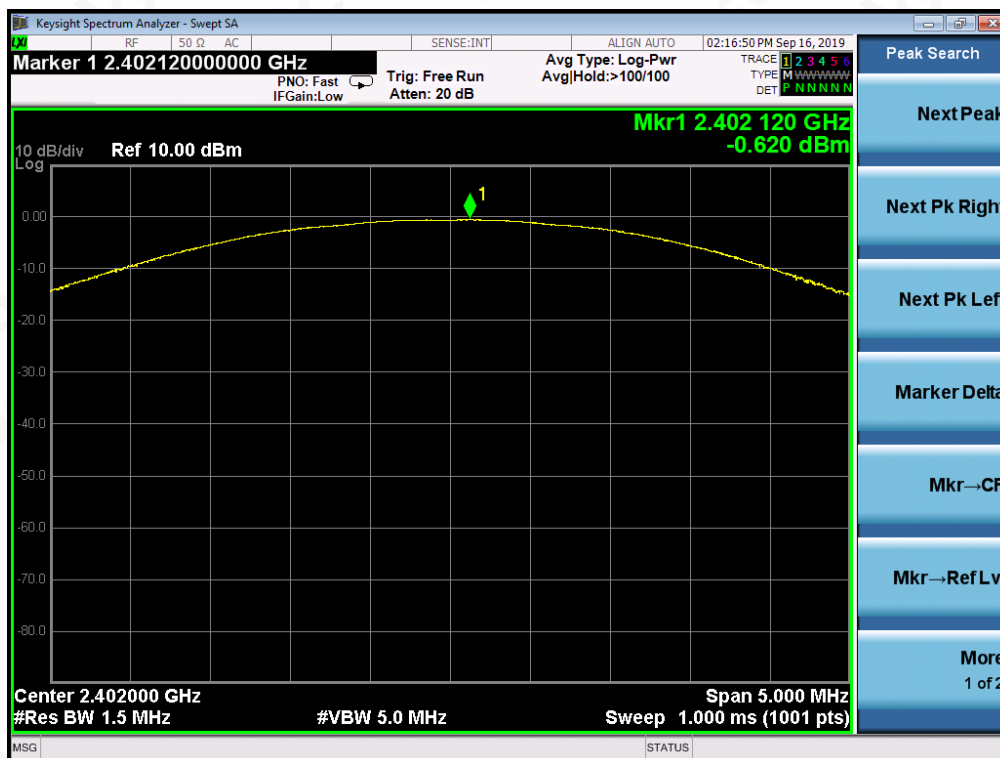

Attestation of Global Compliance

Attestation of Global Compliance(Shenzhen)Co.,Ltd.
Add: 2/F., Building 2, Sanwei Chaxi Industrial Park, Sanwei Community,
Hangcheng Street, Bao'an District, Shenzhen, Guangdong, China
Tel: +86-755 2523 4088 E-mail: agc@agc-cert.com Service Hotline:400 089 2118

CH39



CH78

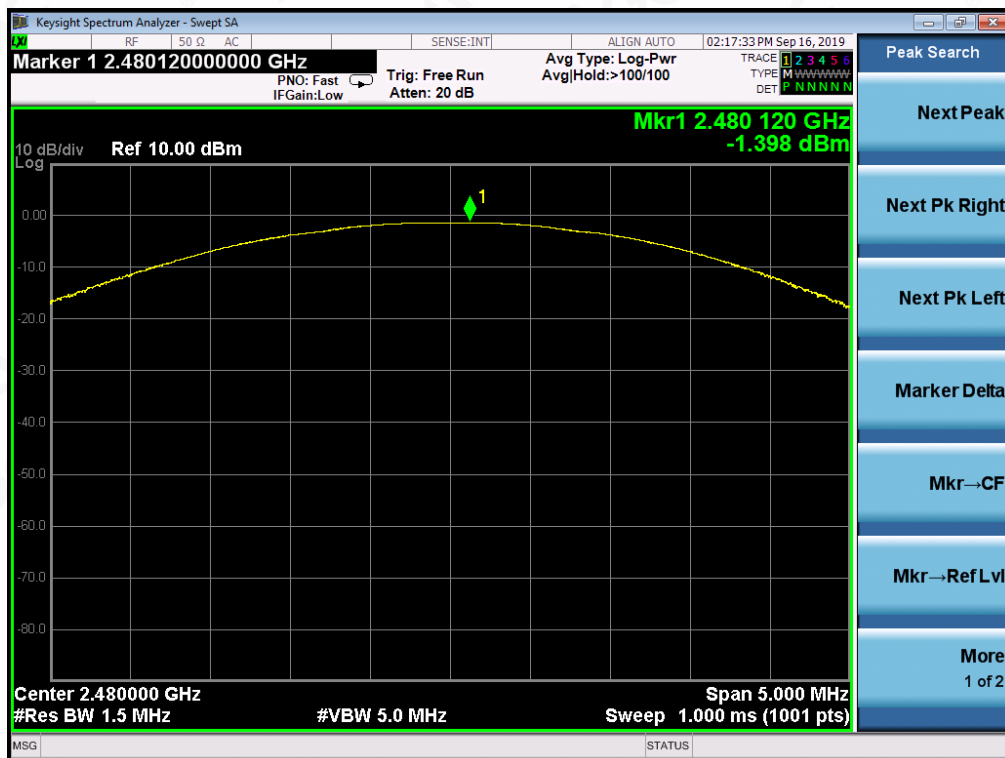

| PEAK OUTPUT POWER MEASUREMENT RESULT FOR 8-DPSK MODULATION | | | |
|---|------------------|-------------------------|--------------|
| Frequency (GHz) | Peak Power (dBm) | Applicable Limits (dBm) | Pass or Fail |
| 2.402 | -0.547 | 30 | Pass |
| 2.441 | -0.804 | 30 | Pass |
| 2.480 | -1.293 | 30 | Pass |

CH0

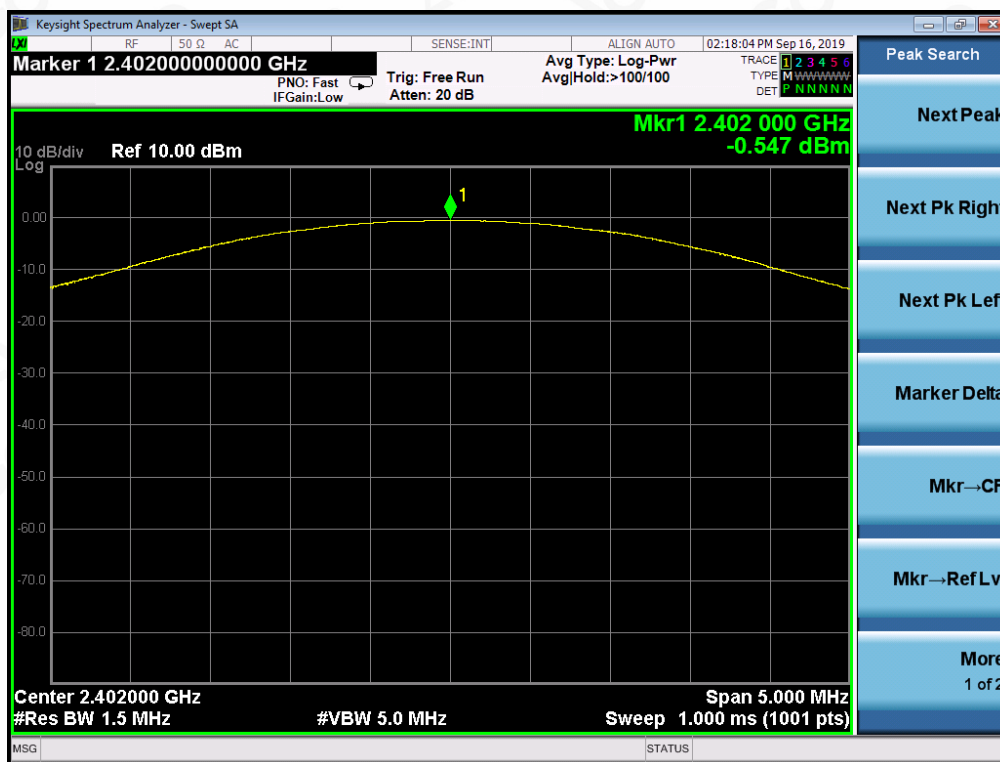

Attestation of Global Compliance

Attestation of Global Compliance(Shenzhen)Co.,Ltd.
Add: 2/F., Building 2, Sanwei Chaxi Industrial Park, Sanwei Community,
Hangcheng Street, Bao'an District, Shenzhen, Guangdong, China
Tel: +86-755 2523 4088 E-mail: agc@agc-cert.com Service Hotline:400 089 2118

CH39

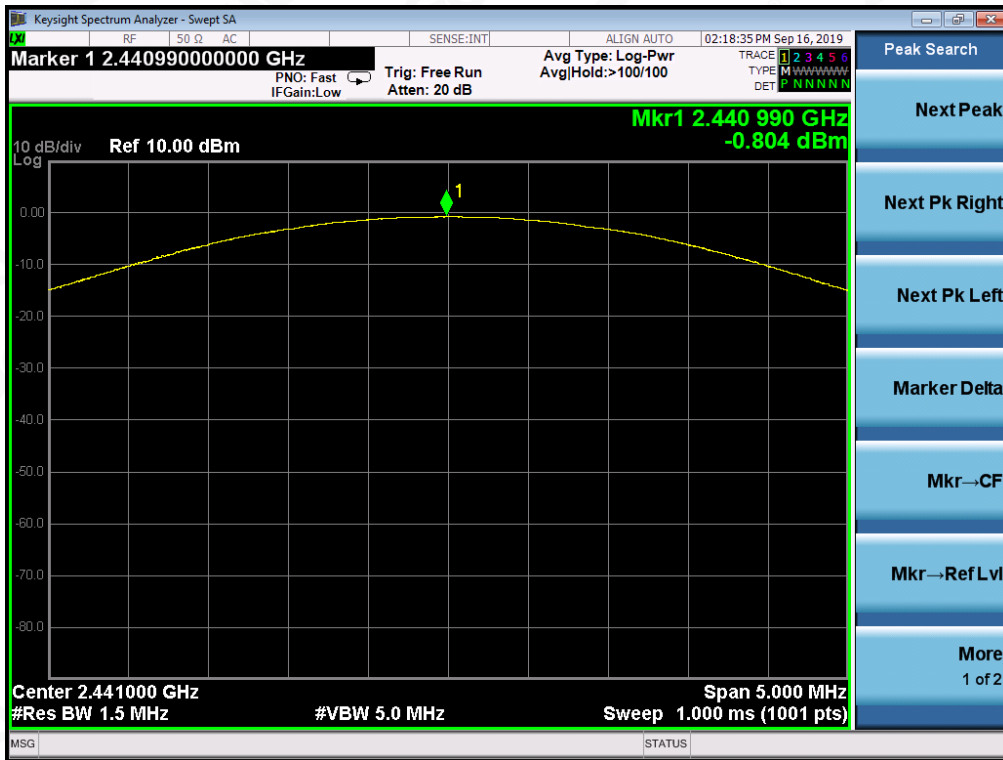

CH78

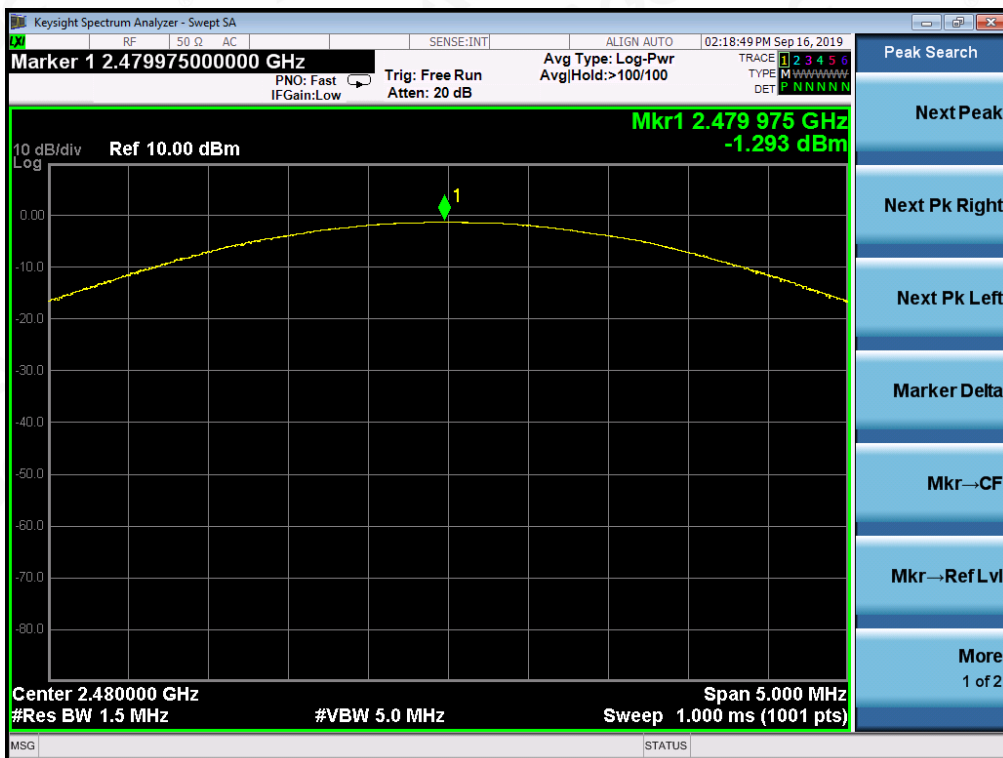

8. 20DB BANDWIDTH

8.1. MEASUREMENT PROCEDURE

1. Connect EUT RF output port to the Spectrum Analyzer through an RF attenuator
2. Set the EUT Work on the top, the middle and the bottom operation frequency individually.
3. Set Span = approximately 2 to 5 times the 20 dB bandwidth, centered on a hopping channel
The nominal IF filter bandwidth (3 dB RBW) shall be in the range of 1% to 5% of the OBW and video bandwidth (VBW) shall be approximately three times RBW; Sweep = auto; Detector function = peak
4. Set SPA Trace 1 Max hold, then View.

8.2. TEST SET-UP (BLOCK DIAGRAM OF CONFIGURATION)

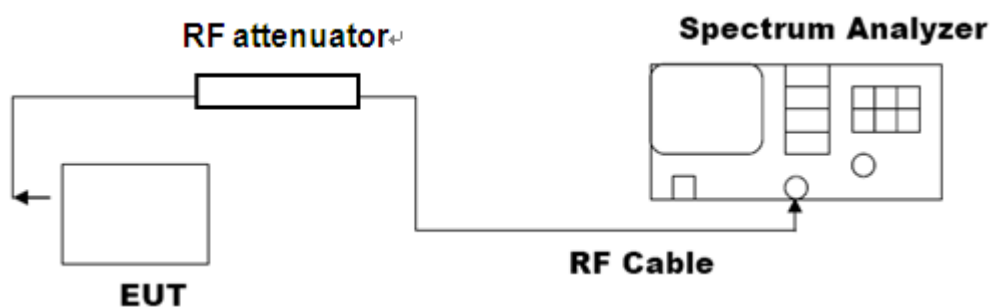

8.3. LIMITS AND MEASUREMENT RESULTS

| MEASUREMENT RESULT FOR GFSK MODULATION | | | |
|--|--------------------|--------|----------|
| Applicable Limits | Measurement Result | | |
| | Test Data (MHz) | | Criteria |
| N/A | Low Channel | 0.9202 | PASS |
| | Middle Channel | 0.9215 | PASS |
| | High Channel | 0.9194 | PASS |



TEST PLOT OF BANDWIDTH FOR LOW CHANNEL

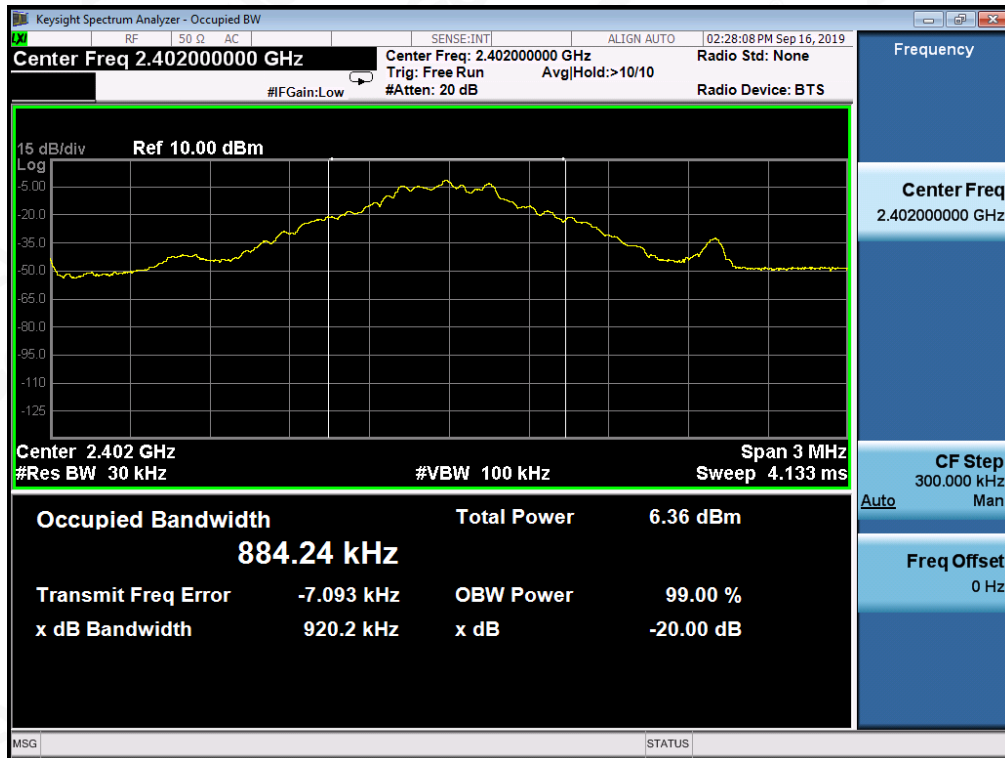

TEST PLOT OF BANDWIDTH FOR MIDDLE CHANNEL

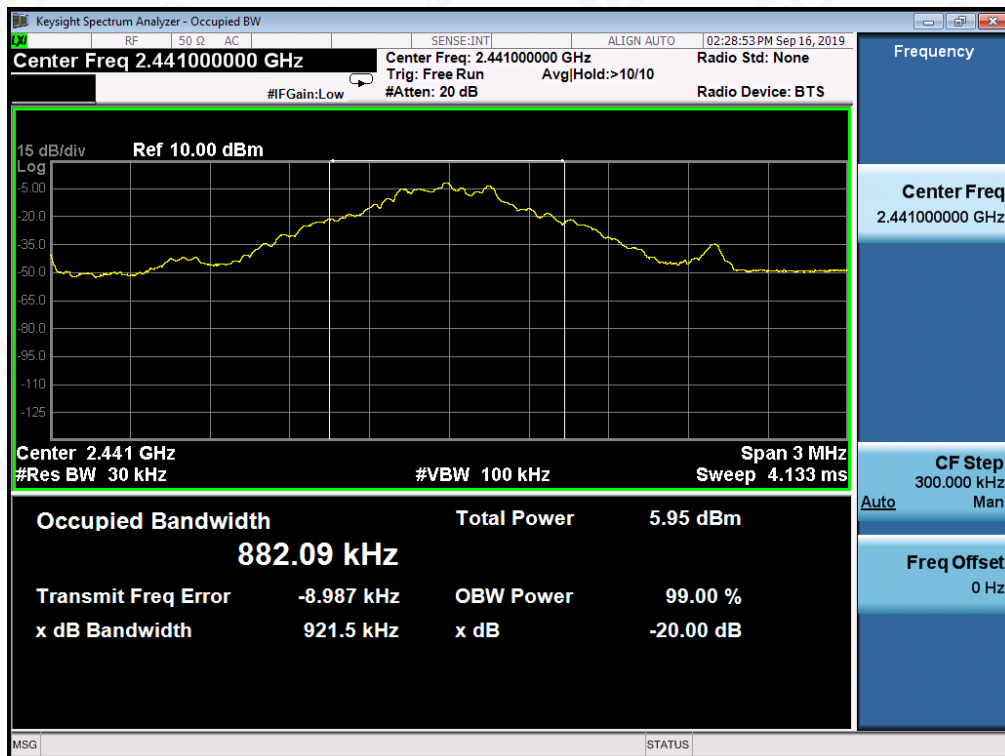

TEST PLOT OF BANDWIDTH FOR HIGH CHANNEL

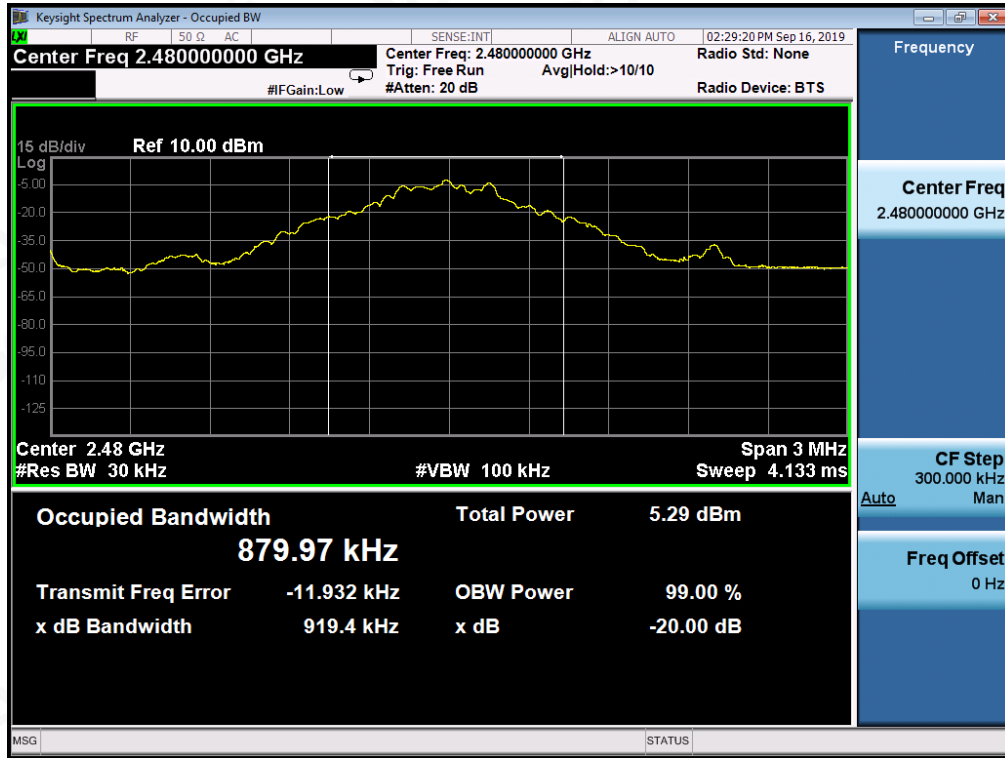

Attestation of Global Compliance

Attestation of Global Compliance(Shenzhen)Co.,Ltd.

Add: 2/F., Building 2, Sanwei Chaxi Industrial Park, Sanwei Community,
Hangcheng Street, Bao'an District, Shenzhen, Guangdong, China

Tel: +86-755 2523 4088

E-mail: agc@agc-cert.com

Service Hotline: 400 089 2118

| MEASUREMENT RESULT FOR II /4-DQPSK MODULATION | | | |
|---|--------------------|-------|----------|
| Applicable Limits | Measurement Result | | |
| | Test Data (MHz) | | Criteria |
| N/A | Low Channel | 1.265 | PASS |
| | Middle Channel | 1.261 | PASS |
| | High Channel | 1.260 | PASS |

TEST PLOT OF BANDWIDTH FOR LOW CHANNEL

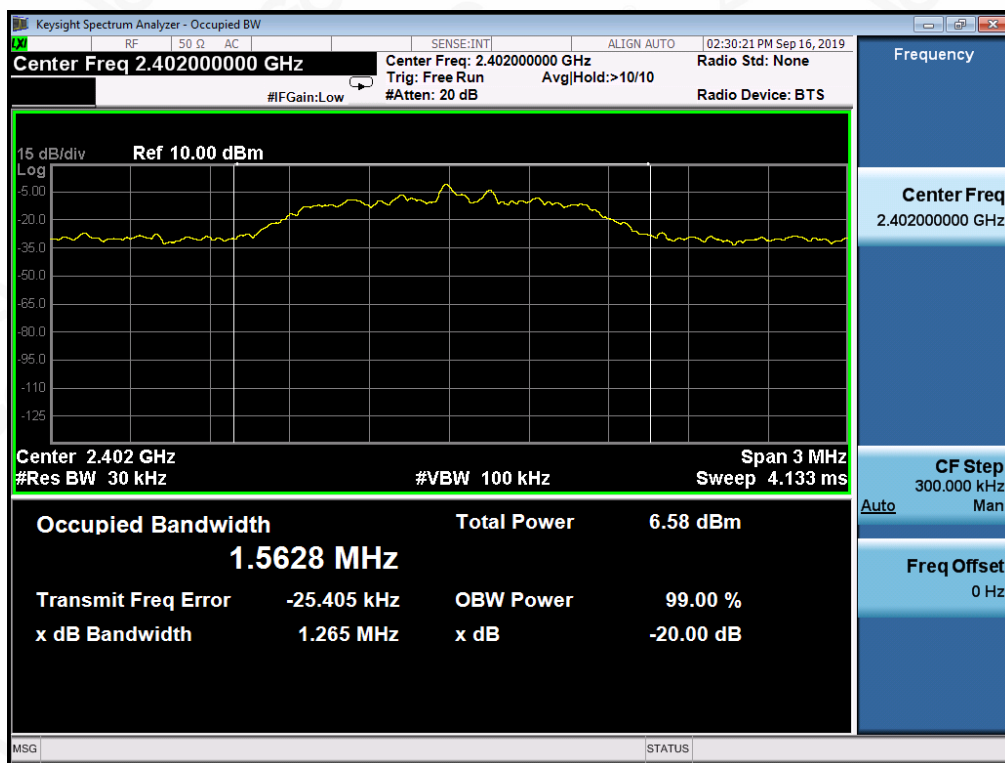

TEST PLOT OF BANDWIDTH FOR MIDDLE CHANNEL

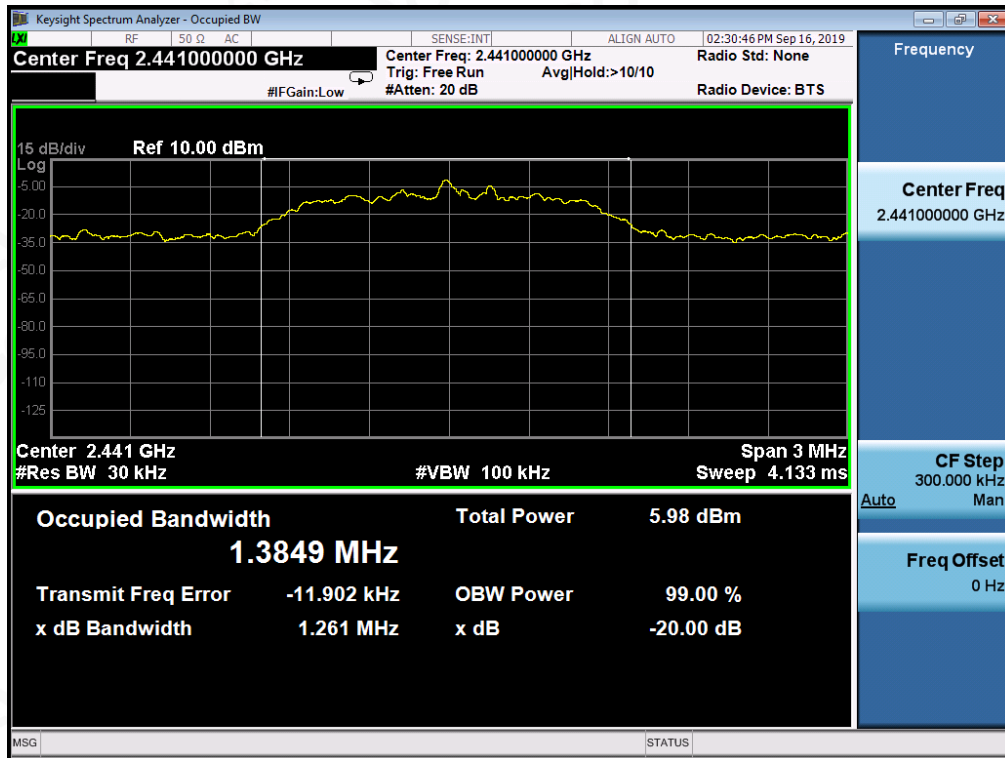

TEST PLOT OF BANDWIDTH FOR HIGH CHANNEL

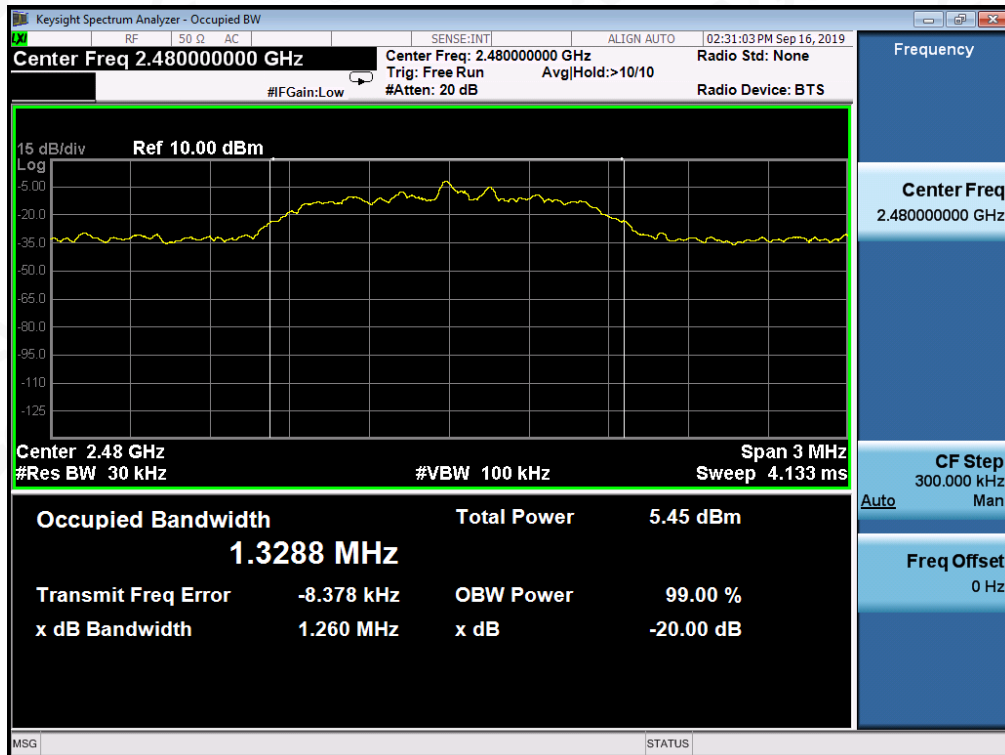

Attestation of Global Compliance

Attestation of Global Compliance(Shenzhen)Co.,Ltd.
Add: 2/F., Building 2, Sanwei Chaxi Industrial Park, Sanwei Community,
Hangcheng Street, Bao'an District, Shenzhen, Guangdong, China
Tel: +86-755 2523 4088 E-mail: agc@agc-cert.com Service Hotline:400 089 2118

| MEASUREMENT RESULT FOR 8-DPSK MODULATION | | | |
|--|--------------------|-------|----------|
| Applicable Limits | Measurement Result | | |
| | Test Data (MHz) | | Criteria |
| N/A | Low Channel | 1.297 | PASS |
| | Middle Channel | 1.291 | PASS |
| | High Channel | 1.285 | PASS |

TEST PLOT OF BANDWIDTH FOR LOW CHANNEL

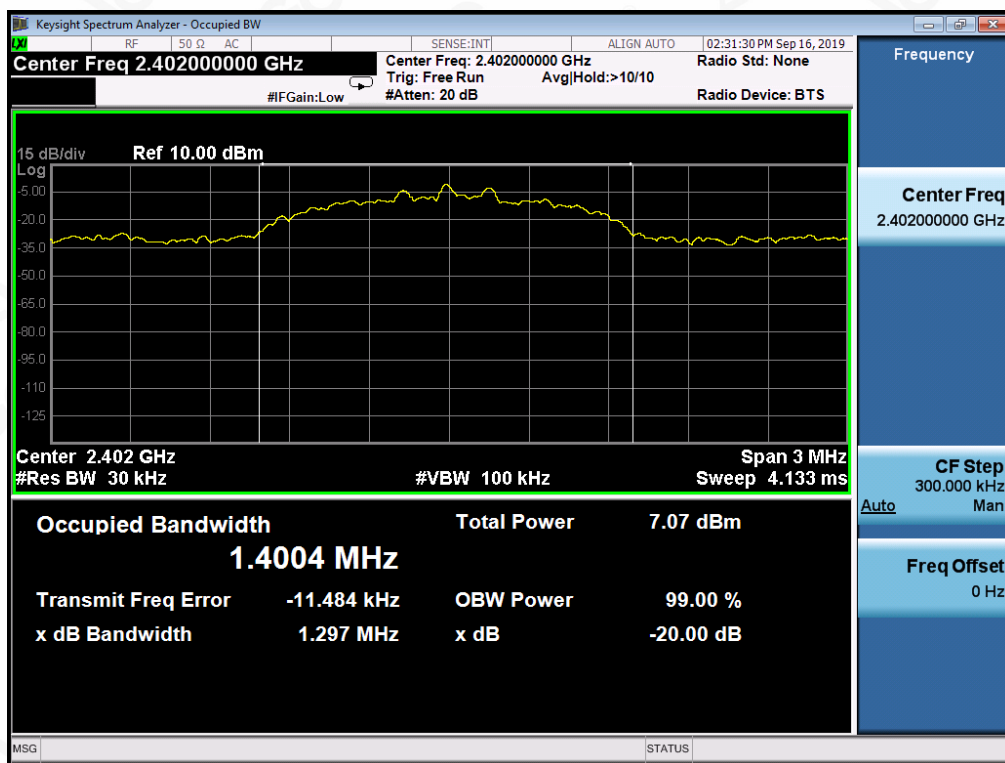

TEST PLOT OF BANDWIDTH FOR MIDDLE CHANNEL

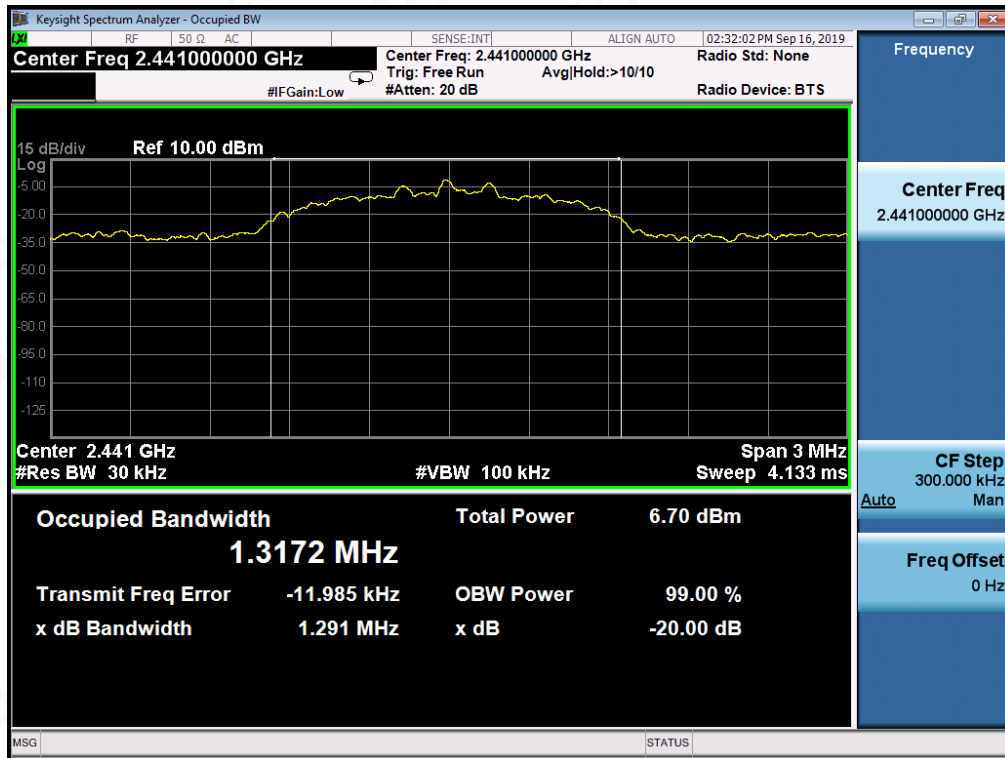

TEST PLOT OF BANDWIDTH FOR HIGH CHANNEL

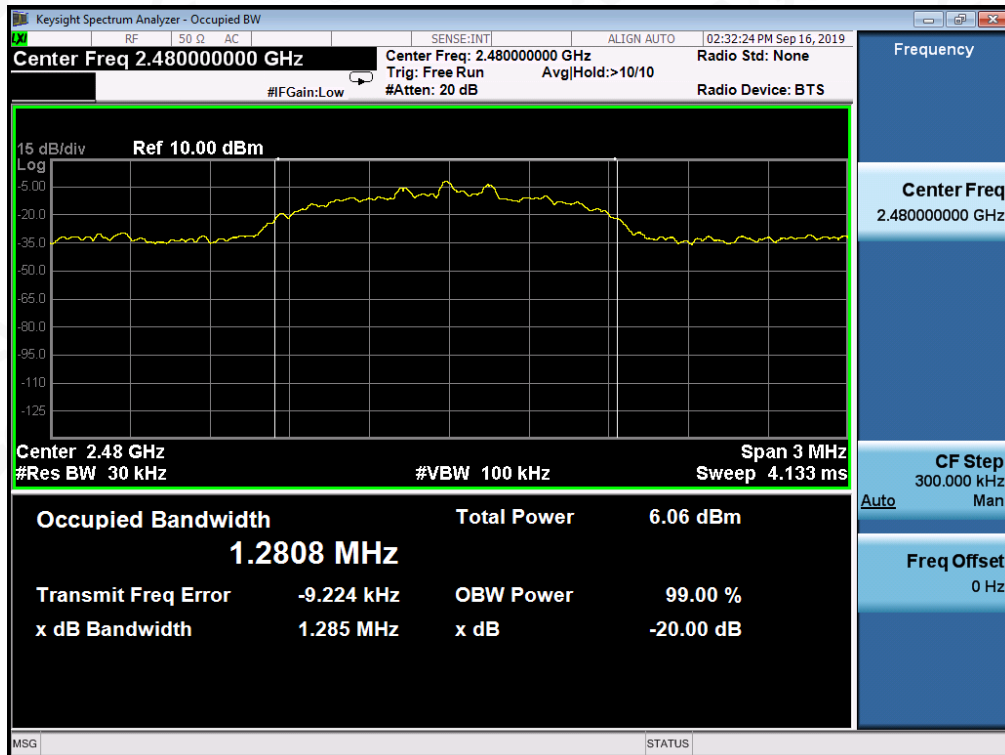

9. CONDUCTED SPURIOUS EMISSION

9.1. MEASUREMENT PROCEDURE

1. Connect EUT RF output port to the Spectrum Analyzer through an RF attenuator
2. Set the EUT Work on the top, the Middle and the bottom operation frequency individually.
3. Set the Span = wide enough to capture the peak level of the in-band emission and all spurious emissions from the lowest frequency generated in the EUT up through the 10th harmonic.
RBW = 100 kHz; VBW= 300 kHz; Sweep = auto; Detector function = peak.
4. Set SPA Trace 1 Max hold, then View.

9.2. TEST SET-UP (BLOCK DIAGRAM OF CONFIGURATION)

The same as described in section 8.2

9.3. MEASUREMENT EQUIPMENT USED

The same as described in section 6

9.4. LIMITS AND MEASUREMENT RESULT

| LIMITS AND MEASUREMENT RESULT | | |
|--|--|----------|
| Applicable Limits | Measurement Result | |
| | Test Data | Criteria |
| In any 100 KHz Bandwidth Outside the frequency band in which the spread spectrum intentional radiator is operating, the radio frequency power that is produce by the intentional radiator shall be at least 20 dB below that in 100KHz bandwidth within the band that contains the highest level of the desired power. In addition, radiation emissions which fall in the restricted bands, as defined in §15.205(a), must also comply with the radiated emission limits specified in§15.209(a) | At least -20dBc than the limit Specified on the BOTTOM Channel | PASS |
| | At least -20dBc than the limit Specified on the TOP Channel | PASS |



TEST RESULT FOR ENTIRE FREQUENCY RANGE
TEST PLOT OF OUT OF BAND EMISSIONS WITH THE WORST CASE
OF 8-DPSK MODULATION IN LOW CHANNEL

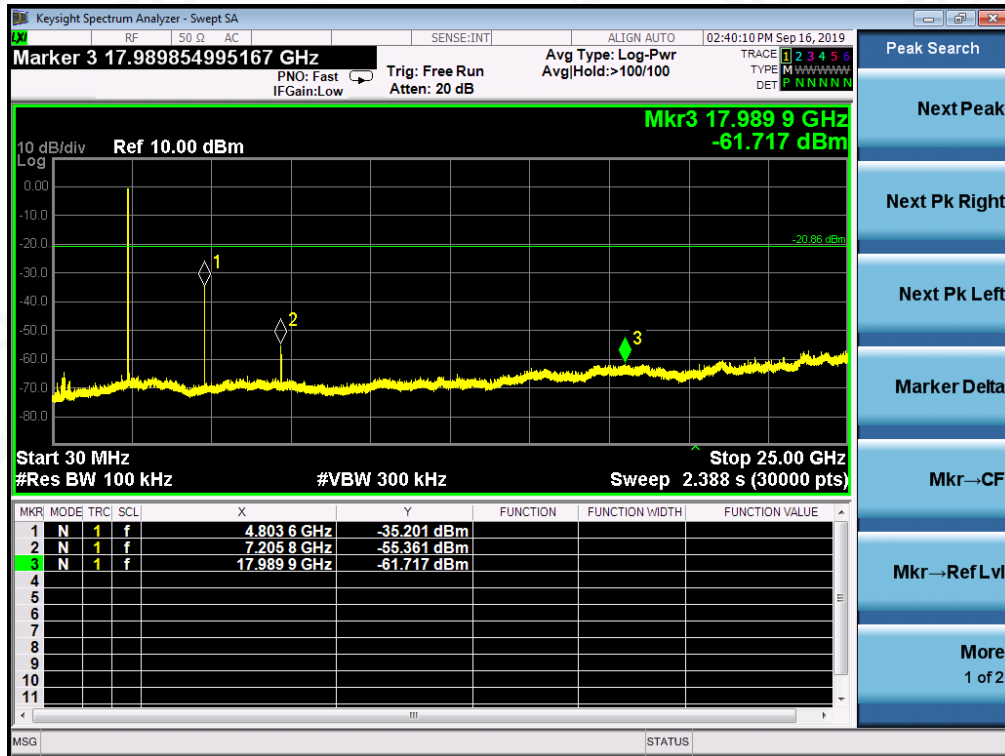
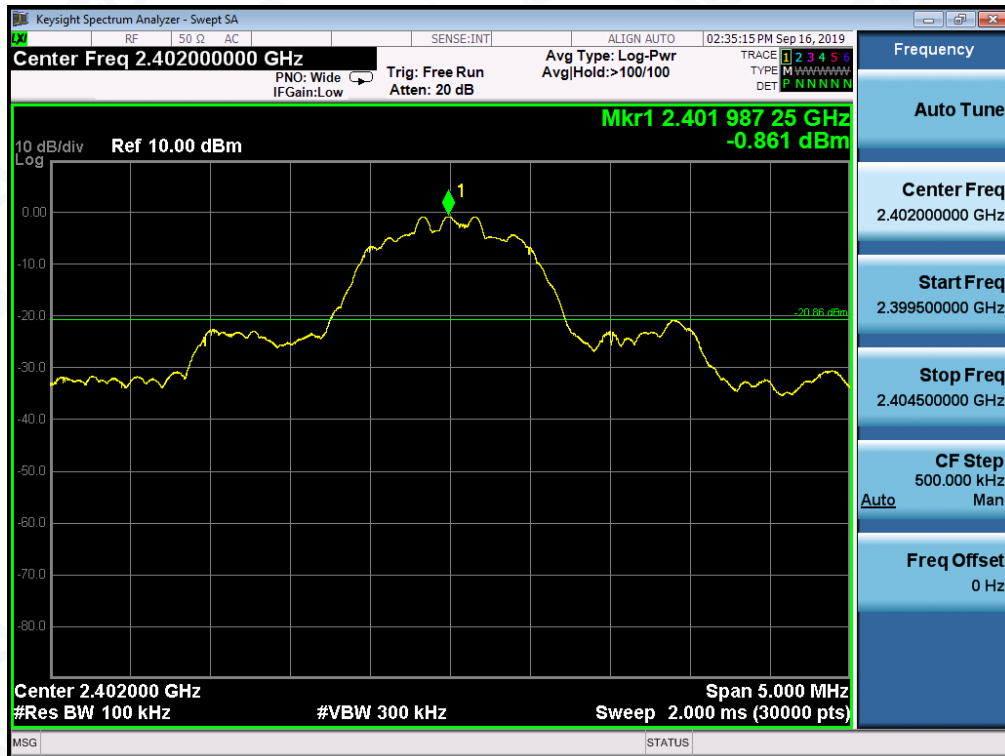

Attestation of Global Compliance

Attestation of Global Compliance(Shenzhen)Co.,Ltd.
Add: 2/F., Building 2, Sanwei Chaxi Industrial Park, Sanwei Community,
Hangcheng Street, Bao'an District, Shenzhen, Guangdong, China
Tel: +86-755 2523 4088 E-mail: agc@agc-cert.com Service Hotline: 400 089 2118

TEST PLOT OF OUT OF BAND EMISSIONS OF 8-DPSK MODULATION IN MIDDLE CHANNEL

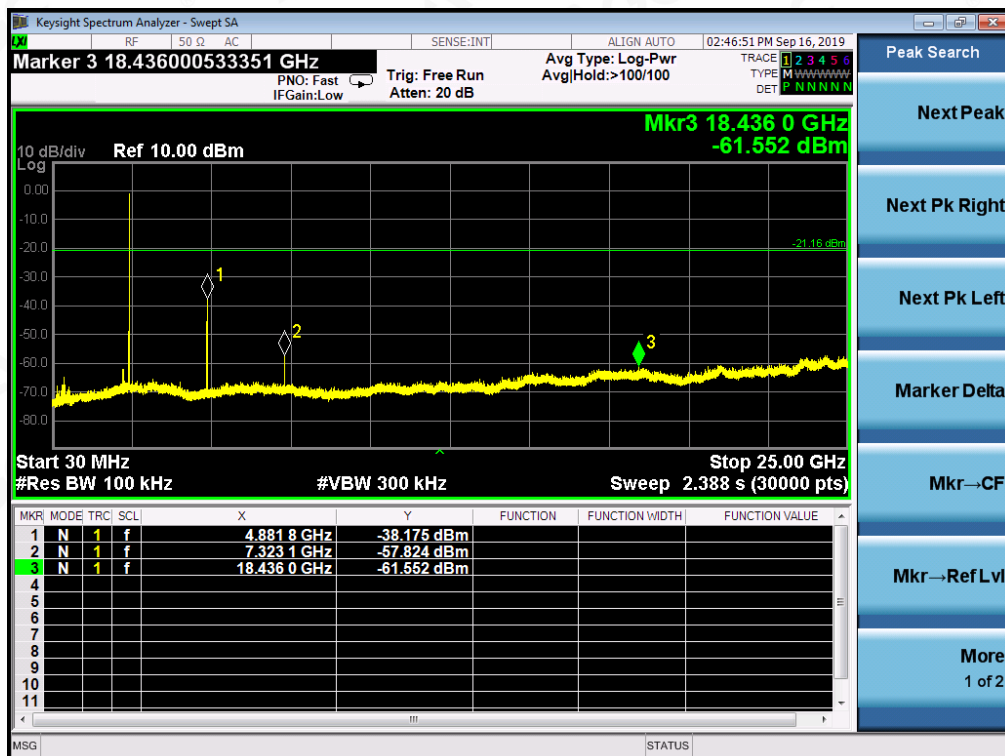

Attestation of Global Compliance

Attestation of Global Compliance(Shenzhen)Co.,Ltd.

Add: 2/F., Building 2, Sanwei Chaxi Industrial Park, Sanwei Community,
Hangcheng Street, Bao'an District, Shenzhen, Guangdong, China

Tel: +86-755 2523 4088

E-mail: agc@agc-cert.com

Service Hotline: 400 089 2118

TEST PLOT OF OUT OF BAND EMISSIONS
OF 8-DPSK MODULATION IN HIGH CHANNEL

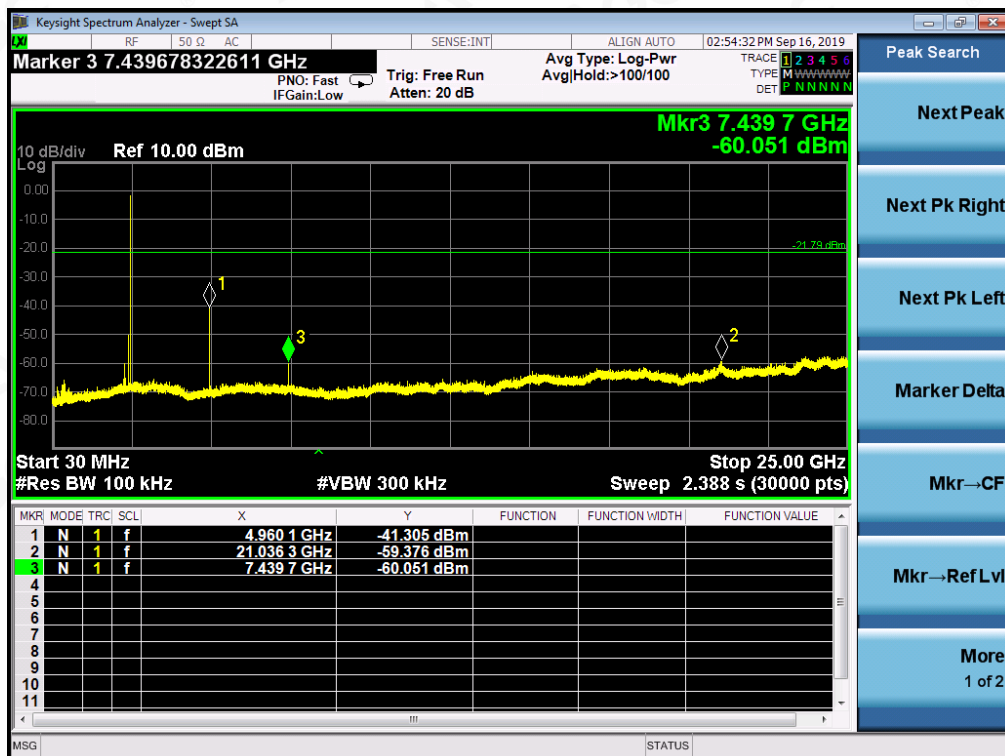

Note: The peak emissions without marker on the above plots are fundamental wave and need not to compare with the limit. The 8-DPSK modulation is the worst case and only those data recorded in the report.



Attestation of Global Compliance

Attestation of Global Compliance(Shenzhen)Co.,Ltd.
Add: 2/F., Building 2, Sanwei Chaxi Industrial Park, Sanwei Community,
Hangcheng Street, Bao'an District, Shenzhen, Guangdong, China
Tel: +86-755 2523 4088 E-mail: agc@agc-cert.com Service Hotline:400 089 2118

TEST RESULT FOR BAND EDGE
GFSK MODULATION IN LOW CHANNEL
Hopping off



Hopping on

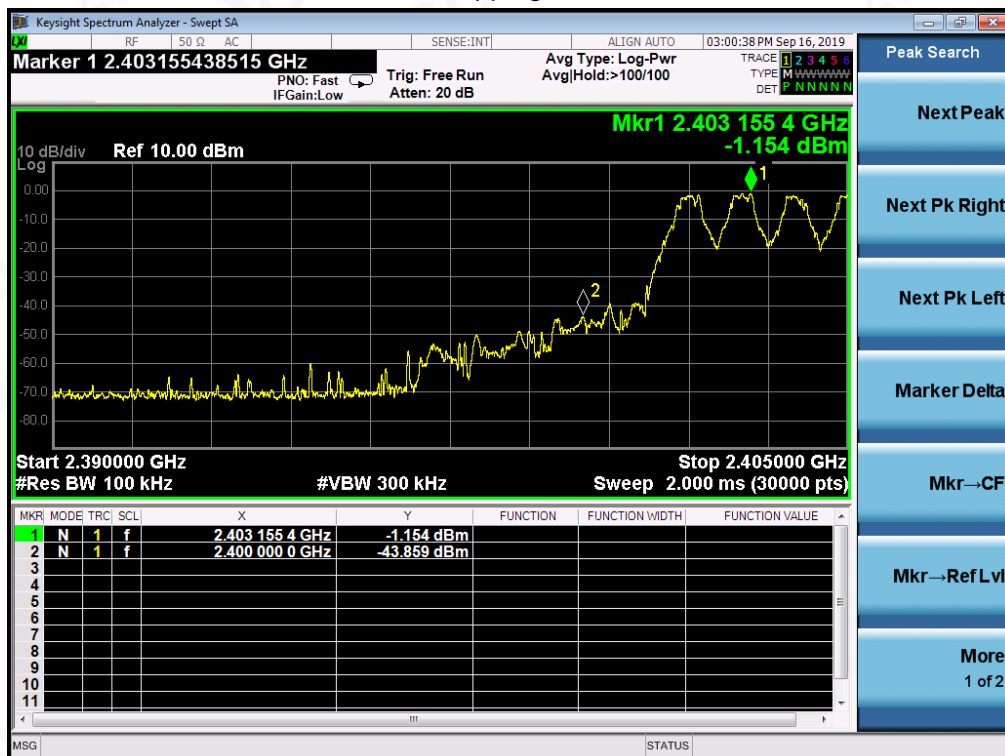

GFSK MODULATION IN HIGH CHANNEL Hopping off



Hopping on

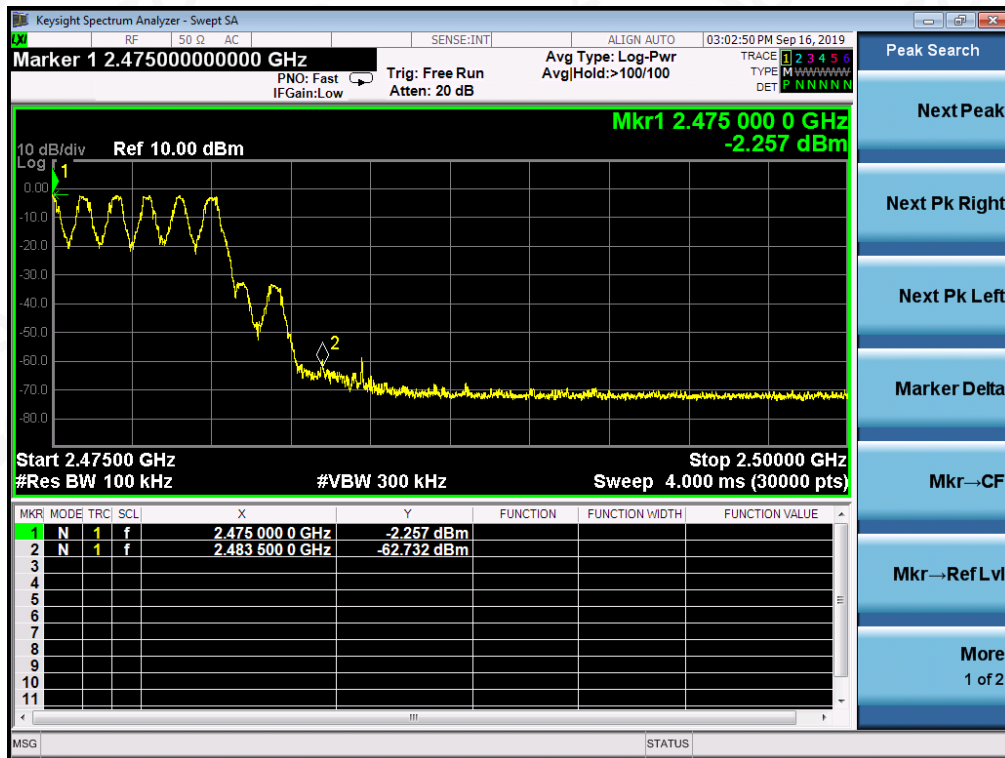

Attestation of Global Compliance

Attestation of Global Compliance(Shenzhen)Co.,Ltd.

Add: 2/F., Building 2, Sanwei Chaxi Industrial Park, Sanwei Community,
Hangcheng Street, Bao'an District, Shenzhen, Guangdong, China

Tel: +86-755 2523 4088

E-mail: agc@agc-cert.com

Service Hotline: 400 089 2118

π /4-DQPSK MODULATION IN LOW CHANNEL
Hopping off

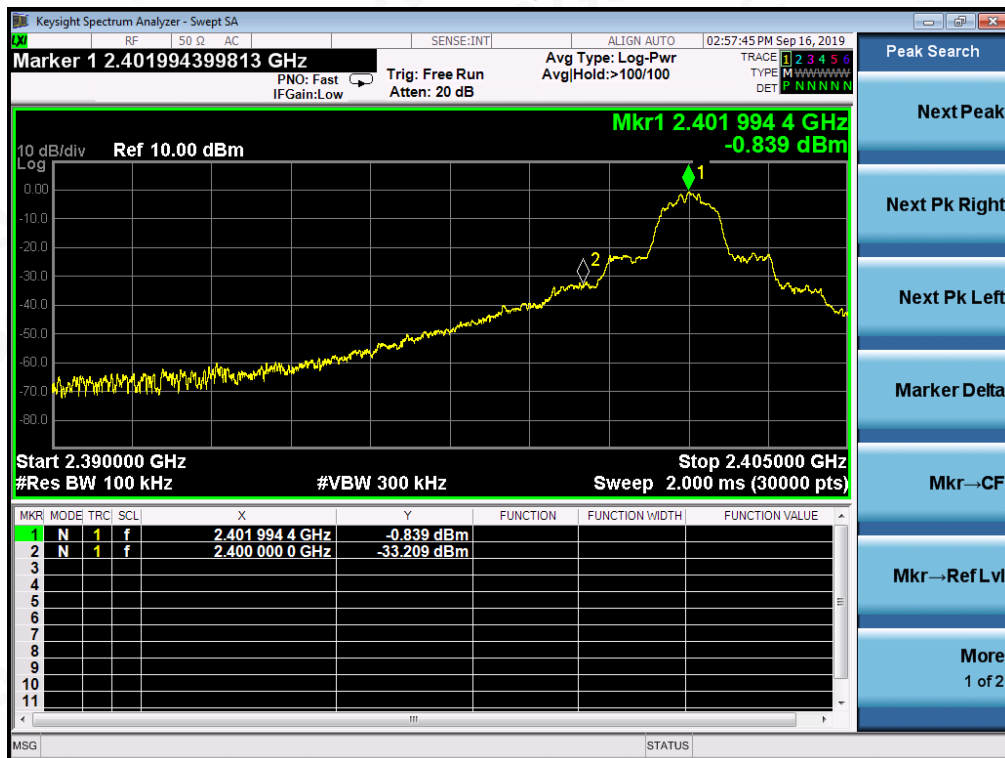

Hopping on

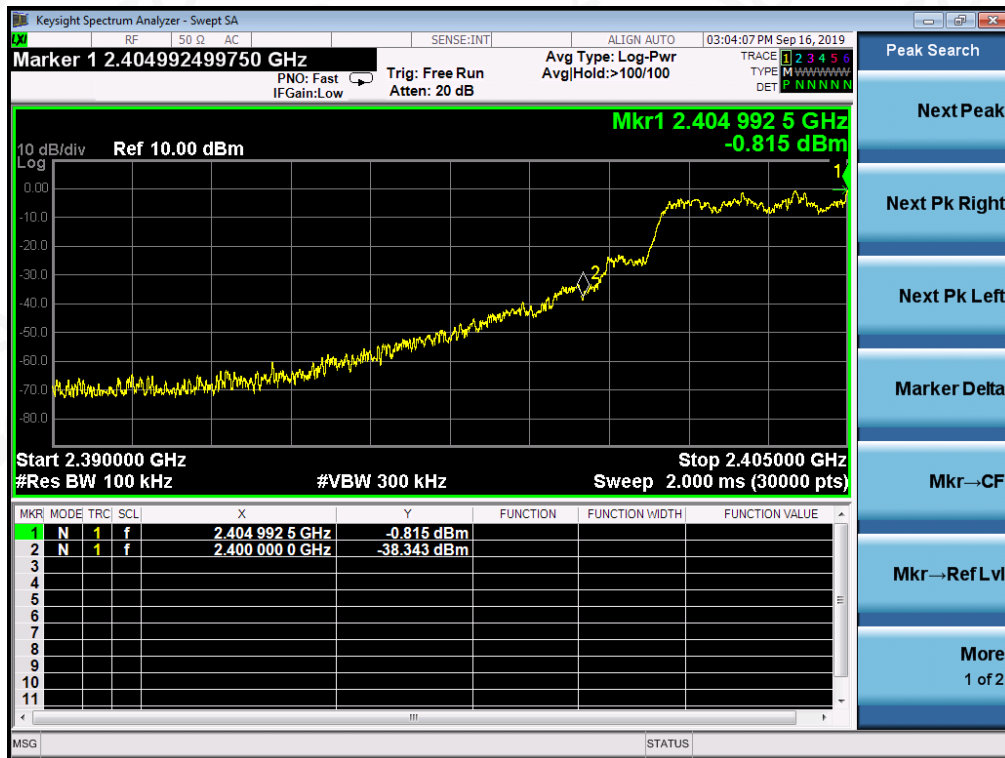

Attestation of Global Compliance

Attestation of Global Compliance(Shenzhen)Co.,Ltd.

Add: 2/F., Building 2, Sanwei Chaxi Industrial Park, Sanwei Community,
Hangcheng Street, Bao'an District, Shenzhen, Guangdong, China

Tel: +86-755 2523 4088

E-mail: agc@agc-cert.com

Service Hotline: 400 089 2118

π /4-DQPSK MODULATION IN HIGH CHANNEL
Hopping off

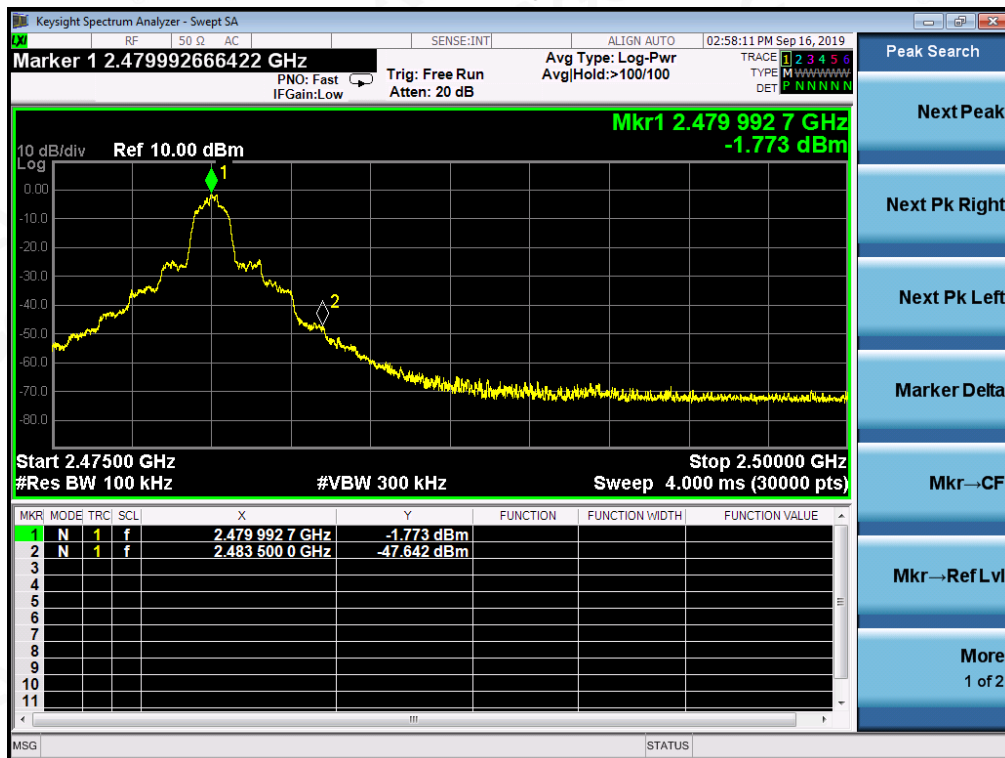

Hopping on



8-DPSK MODULATION IN LOW CHANNEL Hopping off

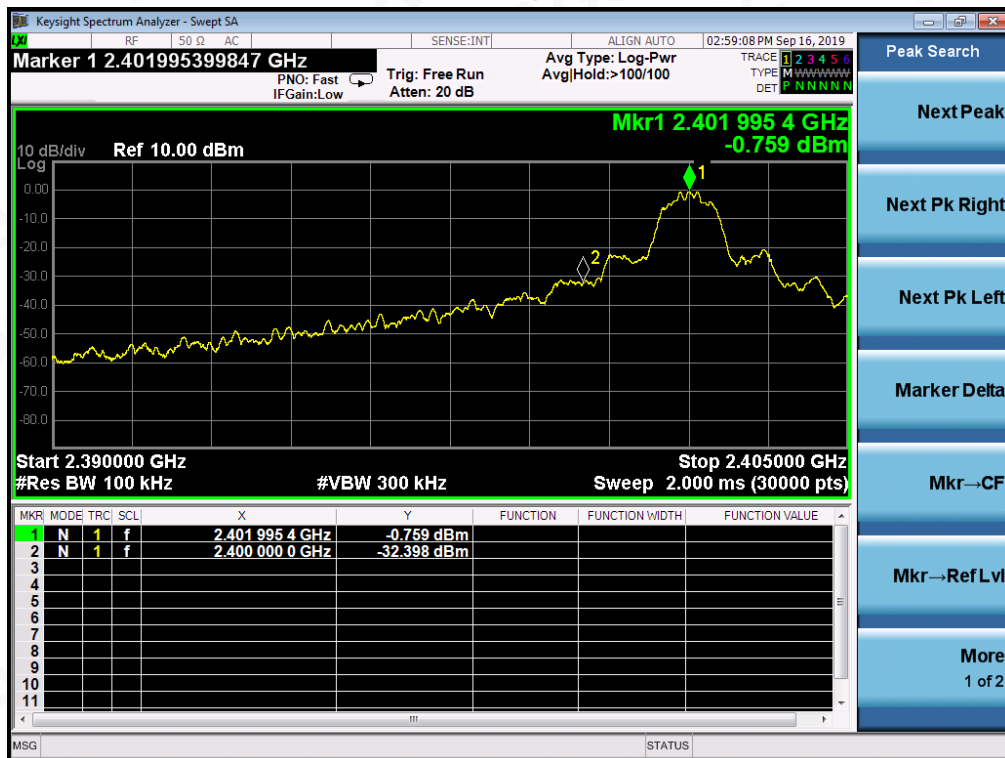

Hopping on

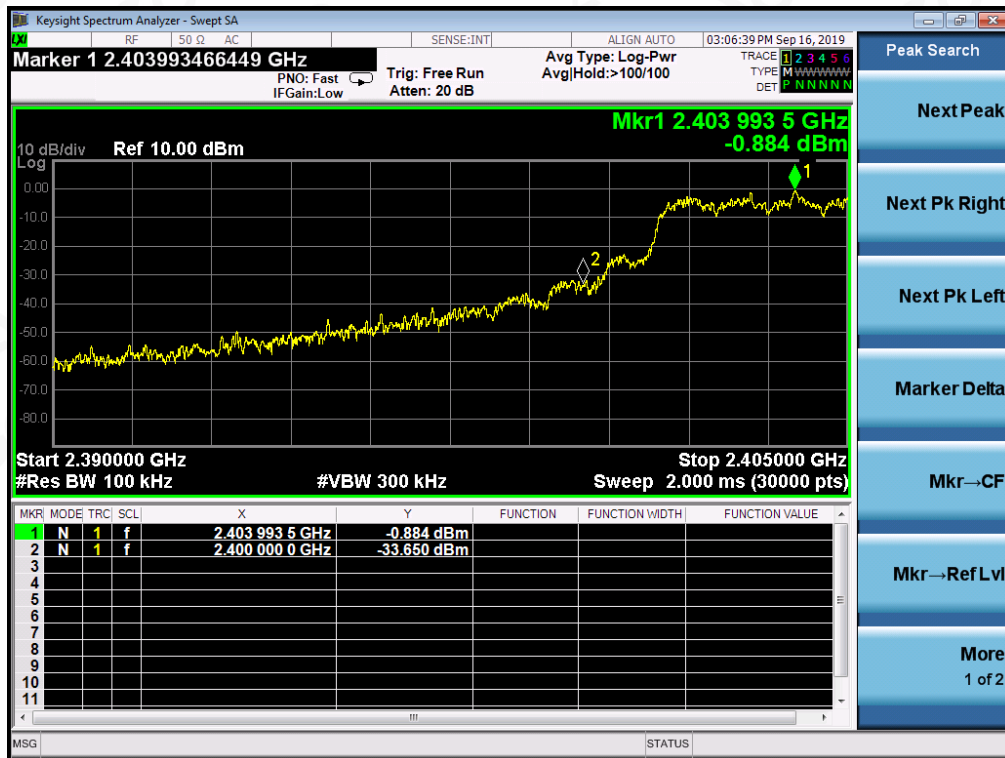

8-DPSK MODULATION IN HIGH CHANNEL Hopping off



Hopping on



10. RADIATED EMISSION

10.1. MEASUREMENT PROCEDURE

1. The EUT was placed on the top of the turntable 0.8 or 1.5 meter above ground. The phase center of the receiving antenna mounted on the top of a height-variable antenna tower was placed 3 meters far away from the turntable.
2. Power on the EUT and all the supporting units. The turntable was rotated by 360 degrees to determine the position of the highest radiation.
3. The height of the broadband receiving antenna was varied between one meter and four meters above ground to find the maximum emissions field strength of both horizontal and vertical polarization.
4. For each suspected emissions, the antenna tower was scan (from 1 M to 4 M) and then the turntable was rotated (from 0 degree to 360 degrees) to find the maximum reading.
5. Set the test-receiver system to Peak or CISPR quasi-peak Detect Function with specified bandwidth under Maximum Hold Mode.
6. For emissions above 1GHz, use 1MHz RBW and 3MHz VBW for peak reading. Place the measurement antenna away from each area of the EUT determined to be a source of emissions at the specified measurement distance, while keeping the measurement antenna aimed at the source of emissions at each frequency of significant emissions, with polarization oriented for maximum response. The measurement antenna may have to be higher or lower than the EUT, depending on the radiation pattern of the emission and staying aimed at the emission source for receiving the maximum signal. The final measurement antenna elevation shall be that which maximizes the emissions. The measurement antenna elevation for maximum emissions shall be restricted to a range of heights of from 1 m to 4 m above the ground or reference ground plane.
7. When the radiated emissions limits are expressed in terms of the average value of the emissions, and pulsed operation is employed, the measurement field strength shall be determined by averaging over one complete pulse train, including blanking intervals, as long as the pulse train does not exceed 0.1 seconds. As an alternative (provided the transmitter operates for longer than 0.1 seconds) or in cases where the pulse train exceeds 0.1 seconds, the measured field strength shall be determined from the average absolute voltage during a 0.1 second interval during which the field strength is at its maximum values.
8. If the emissions level of the EUT in peak mode was 3 dB lower than the average limit specified, then testing will be stopped and peak values of EUT will be reported, otherwise, the emissions which do not have 3 dB margin will be repeated one by one using the quasi-peak method for below 1GHz.
9. For testing above 1GHz, the emissions level of the EUT in peak mode was lower than average limit (that means the emissions level in peak mode also complies with the limit in average mode), then testing will be stopped and peak values of EUT will be reported, otherwise, the emissions will be measured in average mode again and reported.
10. In case the emission is lower than 30MHz, loop antenna has to be used for measurement and the recorded data should be QP measured by receiver. High - Low scan is not required in this case.

The following table is the setting of spectrum analyzer and receiver.

| Spectrum Parameter | Setting |
|-----------------------|---|
| Start ~Stop Frequency | 9KHz~150KHz/RB 200Hz for QP |
| Start ~Stop Frequency | 150KHz~30MHz/RB 9KHz for QP |
| Start ~Stop Frequency | 30MHz~1000MHz/RB 120KHz for QP |
| Start ~Stop Frequency | 1GHz~26.5GHz 1MHz/3MHz for Peak, 1MHz/3MHz for Average |

| Receiver Parameter | Setting |
|-----------------------|--------------------------------|
| Start ~Stop Frequency | 9KHz~150KHz/RB 200Hz for QP |
| Start ~Stop Frequency | 150KHz~30MHz/RB 9KHz for QP |
| Start ~Stop Frequency | 30MHz~1000MHz/RB 120KHz for QP |



10.2. TEST SETUP

Radiated Emission Test-Setup Frequency Below 30MHz

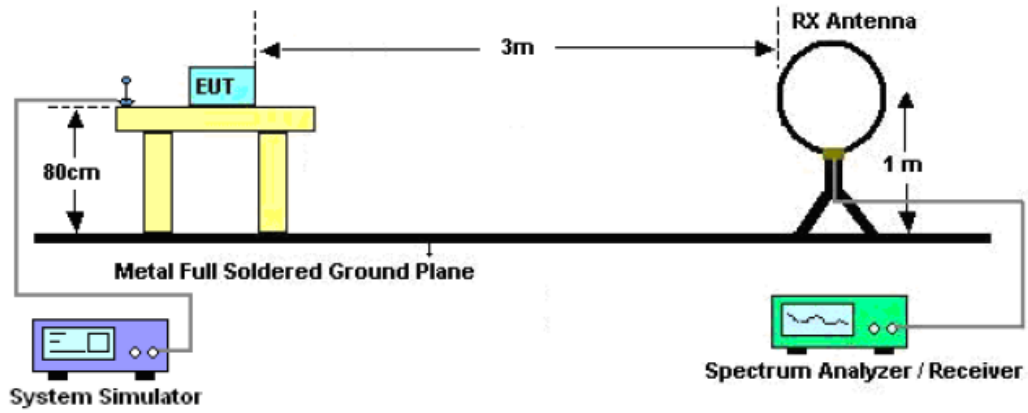

RADIATED EMISSION TEST SETUP 30MHz-1000MHz

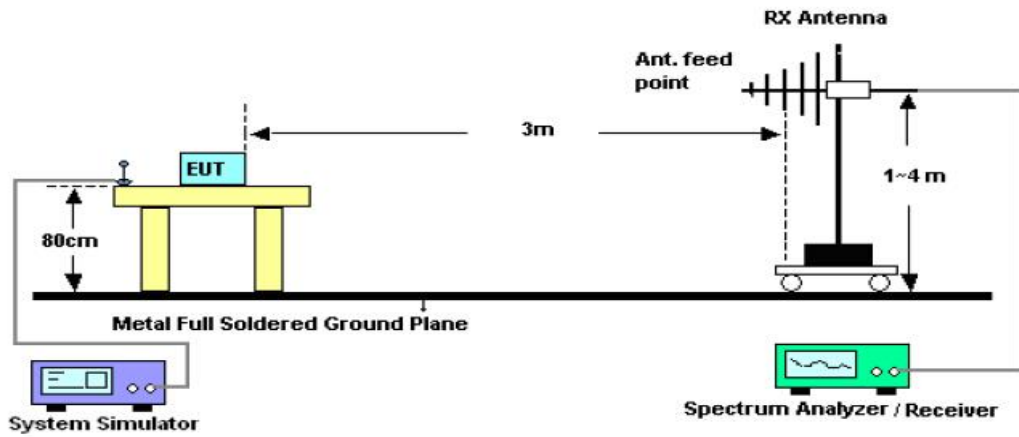

RADIATED EMISSION TEST SETUP ABOVE 1000MHz

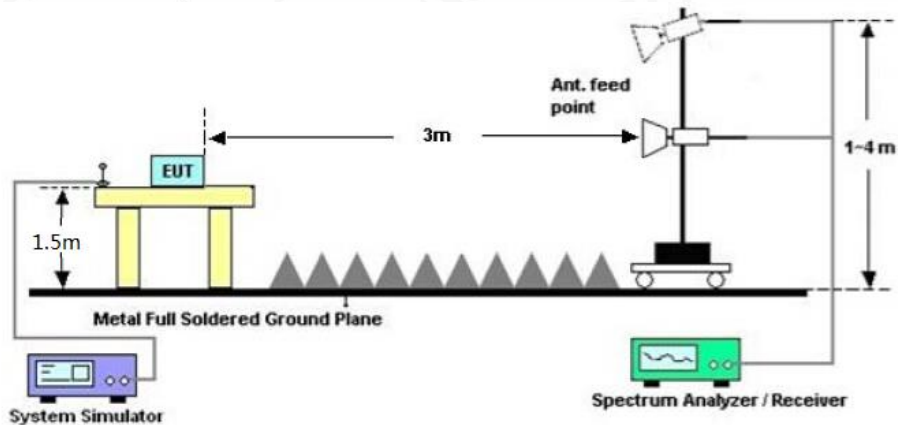

10.3. LIMITS AND MEASUREMENT RESULT

15.209 Limit in the below table has to be followed

| Frequencies (MHz) | Field Strength (micovolts/meter) | Measurement Distance (meters) |
|-------------------|----------------------------------|-------------------------------|
| 0.009~0.490 | 2400/F(KHz) | 300 |
| 0.490~1.705 | 24000/F(KHz) | 30 |
| 1.705~30.0 | 30 | 30 |
| 30~88 | 100 | 3 |
| 88~216 | 150 | 3 |
| 216~960 | 200 | 3 |
| Above 960 | 500 | 3 |

Note: All modes were tested For restricted band radiated emission, the test records reported below are the worst result compared to other modes.

10.4. TEST RESULT

RADIATED EMISSION BELOW 30MHZ

No emission found between lowest internal used/generated frequencies to 30MHz.



RADIATED EMISSION BELOW 1GHZ

| | | | |
|--------------------|--------------------|--------------------------|----------------|
| EUT | Wireless headphone | Model Name | BTE008 |
| Temperature | 25°C | Relative Humidity | 55.4% |
| Pressure | 960hPa | Test Voltage | Normal Voltage |
| Test Mode | Mode 4 | Antenna | Horizontal |

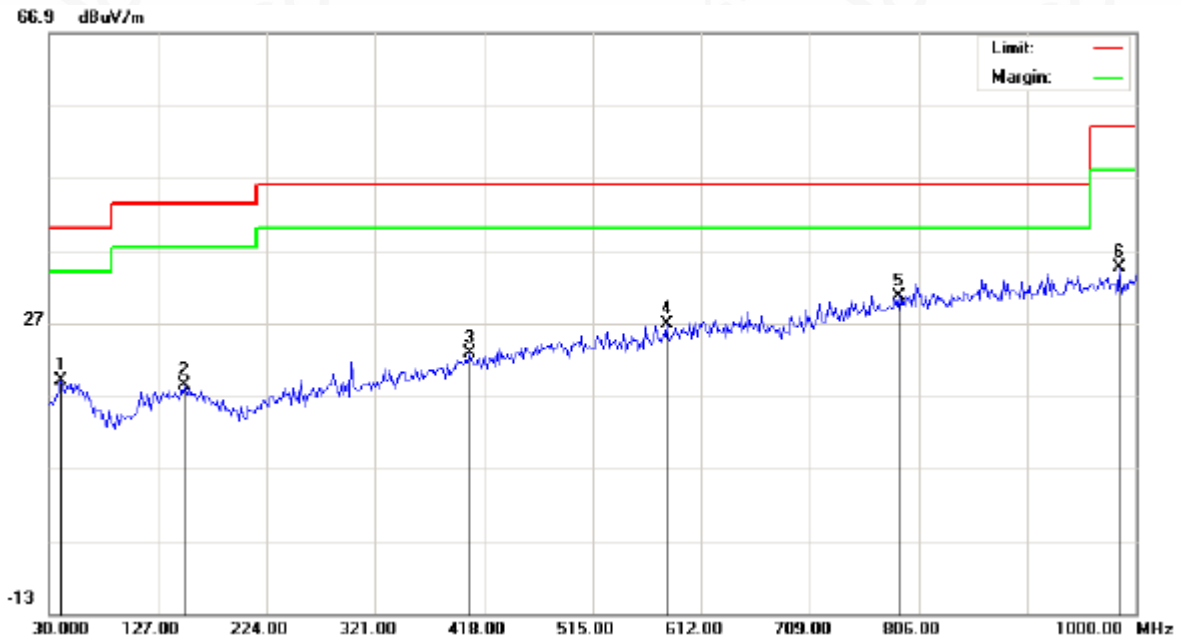

| No. | Mk | Freq. | Reading | Factor | Measurement | Limit | Over | Detector | Antenna Height | Table Degree | Comment |
|-----|----|----------|---------|--------|-------------|--------|--------|----------|----------------|--------------|---------|
| | | MHz | dBuV | dB/m | dBuV/m | dBuV/m | dB | | cm | degree | |
| 1 | | 41.3167 | -1.08 | 20.04 | 18.96 | 40.00 | -21.04 | peak | | | |
| 2 | | 151.2500 | -0.89 | 19.21 | 18.32 | 43.50 | -25.18 | peak | | | |
| 3 | | 405.0667 | -0.31 | 23.08 | 22.77 | 46.00 | -23.23 | peak | | | |
| 4 | | 581.2833 | 0.31 | 26.58 | 26.89 | 46.00 | -19.11 | peak | | | |
| 5 | * | 788.2167 | 0.56 | 30.14 | 30.70 | 46.00 | -15.30 | peak | | | |
| 6 | | 985.4500 | 2.16 | 32.43 | 34.59 | 54.00 | -19.41 | peak | | | |

RESULT: PASS



Attestation of Global Compliance

| | | | |
|--------------------|--------------------|--------------------------|----------------|
| EUT | Wireless headphone | Model Name | BTE008 |
| Temperature | 25°C | Relative Humidity | 55.4% |
| Pressure | 960hPa | Test Voltage | Normal Voltage |
| Test Mode | Mode 4 | Antenna | Vertical |

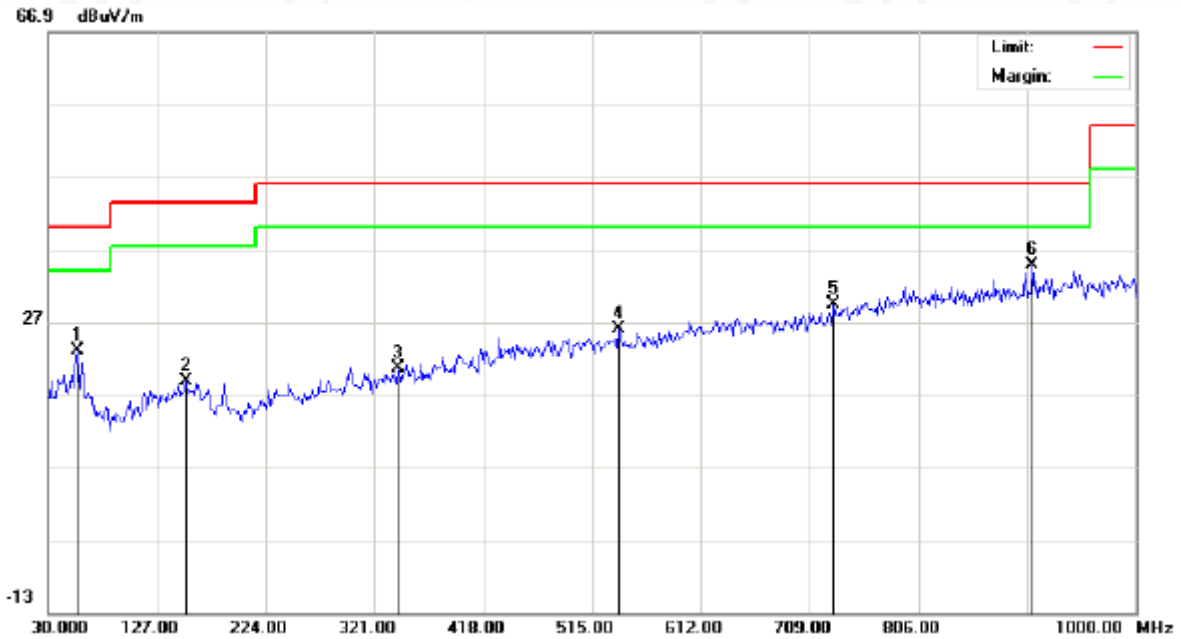

| No. | Mk | Freq. | Reading | Factor | Measurement | Limit | Over | Detector | Antenna Height | Table Degree | Comment |
|-----|----|----------|---------|--------|-------------|--------|--------|----------|----------------|--------------|---------|
| | | MHz | dBuV | dB/m | dBuV/m | dBuV/m | dB | | cm | degree | |
| 1 | | 55.8667 | 3.79 | 19.23 | 23.02 | 40.00 | -16.98 | peak | | | |
| 2 | | 152.8667 | -0.42 | 19.20 | 18.78 | 43.50 | -24.72 | peak | | | |
| 3 | | 342.0167 | -0.24 | 20.94 | 20.70 | 46.00 | -25.30 | peak | | | |
| 4 | | 539.2500 | 0.33 | 25.76 | 26.09 | 46.00 | -19.91 | peak | | | |
| 5 | | 730.0167 | 0.56 | 28.83 | 29.39 | 46.00 | -16.61 | peak | | | |
| 6 | * | 907.8500 | 2.98 | 31.77 | 34.75 | 46.00 | -11.25 | peak | | | |

RESULT: PASS

Note: 1. Factor=Antenna Factor + Cable loss, Margin=Measurement-Limit.

2. All test modes had been pre-tested. The mode 4 is the worst case and recorded in the report.



RADIATED EMISSION ABOVE 1GHZ

| | | | |
|--------------------|--------------------|--------------------------|----------------|
| EUT | Wireless headphone | Model Name | BTE008 |
| Temperature | 25°C | Relative Humidity | 55.4% |
| Pressure | 960hPa | Test Voltage | Normal Voltage |
| Test Mode | Mode 1 | Antenna | Horizontal |

| Frequency (MHz) | Meter Reading (dBµV) | Factor (dB) | Emission Level (dBµV/m) | Limits (dBµV/m) | Margin (dB) | Value Type |
|--------------------|-------------------------|----------------|----------------------------|--------------------|----------------|------------|
| 4804.022 | 49.84 | 0.08 | 49.92 | 74.00 | -24.08 | peak |
| 4804.022 | 45.62 | 0.08 | 45.70 | 54.00 | -8.30 | AVG |
| 7206.033 | 38.36 | 2.21 | 40.57 | 74.00 | -33.43 | peak |
| 7206.033 | 35.47 | 2.21 | 37.68 | 54.00 | -16.32 | AVG |
| | | | | | | |
| | | | | | | |

Remark:
Factor = Antenna Factor + Cable Loss – Pre-amplifier.

| | | | |
|--------------------|--------------------|--------------------------|----------------|
| EUT | Wireless headphone | Model Name | BTE008 |
| Temperature | 25°C | Relative Humidity | 55.4% |
| Pressure | 960hPa | Test Voltage | Normal Voltage |
| Test Mode | Mode 1 | Antenna | Vertical |

| Frequency (MHz) | Meter Reading (dBµV) | Factor (dB) | Emission Level (dBµV/m) | Limits (dBµV/m) | Margin (dB) | Value Type |
|--------------------|-------------------------|----------------|----------------------------|--------------------|----------------|------------|
| 4804.022 | 48.84 | 0.08 | 48.92 | 74.00 | -25.08 | peak |
| 4804.022 | 44.23 | 0.08 | 44.31 | 54.00 | -9.69 | AVG |
| 7206.033 | 40.01 | 2.21 | 42.22 | 74.00 | -31.78 | peak |
| 7206.033 | 38.36 | 2.21 | 40.57 | 54.00 | -13.43 | AVG |
| | | | | | | |
| | | | | | | |

Remark:
Factor = Antenna Factor + Cable Loss – Pre-amplifier.



| | | | |
|--------------------|--------------------|--------------------------|----------------|
| EUT | Wireless headphone | Model Name | BTE008 |
| Temperature | 25°C | Relative Humidity | 55.4% |
| Pressure | 960hPa | Test Voltage | Normal Voltage |
| Test Mode | Mode 2 | Antenna | Horizontal |

| Frequency (MHz) | Meter Reading (dBμV) | Factor (dB) | Emission Level (dBμV/m) | Limits (dBμV/m) | Margin (dB) | Value Type |
|-----------------|----------------------|-------------|-------------------------|-----------------|-------------|------------|
| 4882.022 | 49.77 | 0.14 | 49.91 | 74.00 | -24.09 | peak |
| 4882.022 | 47.58 | 0.14 | 47.72 | 54.00 | -6.28 | AVG |
| 7323.033 | 40.36 | 2.36 | 42.72 | 74.00 | -31.28 | peak |
| 7323.033 | 37.21 | 2.36 | 39.57 | 54.00 | -14.43 | AVG |
| | | | | | | |
| | | | | | | |

Remark:
Factor = Antenna Factor + Cable Loss – Pre-amplifier.

| | | | |
|--------------------|--------------------|--------------------------|----------------|
| EUT | Wireless headphone | Model Name | BTE008 |
| Temperature | 25°C | Relative Humidity | 55.4% |
| Pressure | 960hPa | Test Voltage | Normal Voltage |
| Test Mode | Mode 2 | Antenna | Vertical |

| Frequency (MHz) | Meter Reading (dBμV) | Factor (dB) | Emission Level (dBμV/m) | Limits (dBμV/m) | Margin (dB) | Value Type |
|-----------------|----------------------|-------------|-------------------------|-----------------|-------------|------------|
| 4882.022 | 50.84 | 0.14 | 50.98 | 74.00 | -23.02 | peak |
| 4882.022 | 48.26 | 0.14 | 48.40 | 54.00 | -5.60 | AVG |
| 7323.033 | 38.96 | 2.36 | 41.32 | 74.00 | -32.68 | peak |
| 7323.033 | 36.47 | 2.36 | 38.83 | 54.00 | -15.17 | AVG |
| | | | | | | |
| | | | | | | |

Remark:
Factor = Antenna Factor + Cable Loss – Pre-amplifier.



| | | | |
|--------------------|--------------------|--------------------------|----------------|
| EUT | Wireless headphone | Model Name | BTE008 |
| Temperature | 25°C | Relative Humidity | 55.4% |
| Pressure | 960hPa | Test Voltage | Normal Voltage |
| Test Mode | Mode 3 | Antenna | Horizontal |

| Frequency (MHz) | Meter Reading (dBμV) | Factor (dB) | Emission Level (dBμV/m) | Limits (dBμV/m) | Margin (dB) | Value Type |
|-----------------|----------------------|-------------|-------------------------|-----------------|-------------|------------|
| 4960.022 | 49.14 | 0.22 | 49.36 | 74.00 | -24.64 | peak |
| 4960.022 | 46.83 | 0.22 | 47.05 | 54.00 | -6.95 | AVG |
| 7440.033 | 40.23 | 2.64 | 42.87 | 74.00 | -31.13 | peak |
| 7440.033 | 35.67 | 2.64 | 38.31 | 54.00 | -15.69 | AVG |
| | | | | | | |

Remark:
Factor = Antenna Factor + Cable Loss – Pre-amplifier.

| | | | |
|--------------------|--------------------|--------------------------|----------------|
| EUT | Wireless headphone | Model Name | BTE008 |
| Temperature | 25°C | Relative Humidity | 55.4% |
| Pressure | 960hPa | Test Voltage | Normal Voltage |
| Test Mode | Mode 3 | Antenna | Vertical |

| Frequency (MHz) | Meter Reading (dBμV) | Factor (dB) | Emission Level (dBμV/m) | Limits (dBμV/m) | Margin (dB) | Value Type |
|-----------------|----------------------|-------------|-------------------------|-----------------|-------------|------------|
| 4960.022 | 48.75 | 0.22 | 48.97 | 74.00 | -25.03 | peak |
| 4960.022 | 45.12 | 0.22 | 45.34 | 54.00 | -8.66 | AVG |
| 7440.033 | 46.02 | 2.64 | 48.66 | 74.00 | -25.34 | peak |
| 7440.033 | 40.14 | 2.64 | 42.78 | 54.00 | -11.22 | AVG |
| | | | | | | |

Remark:
Factor = Antenna Factor + Cable Loss – Pre-amplifier.

RESULT: PASS

Note:

Other emissions from 1G to 25 GHz are considered as ambient noise. No recording in the test report.
Factor = Antenna Factor + Cable loss - Amplifier gain, Over=Measure-Limit.
The “Factor” value can be calculated automatically by software of measurement system.
All test modes had been tested. The GFSK modulation is the worst case and recorded in the report.



TEST RESULT FOR RESTRICTED BANDS REQUIREMENTS

| | | | |
|-------------|--------------------|-------------------|----------------|
| EUT | Wireless headphone | Model Name | BTE008 |
| Temperature | 25°C | Relative Humidity | 55.4% |
| Pressure | 960hPa | Test Voltage | Normal Voltage |
| Test Mode | Mode 1 | Antenna | Horizontal |

PK

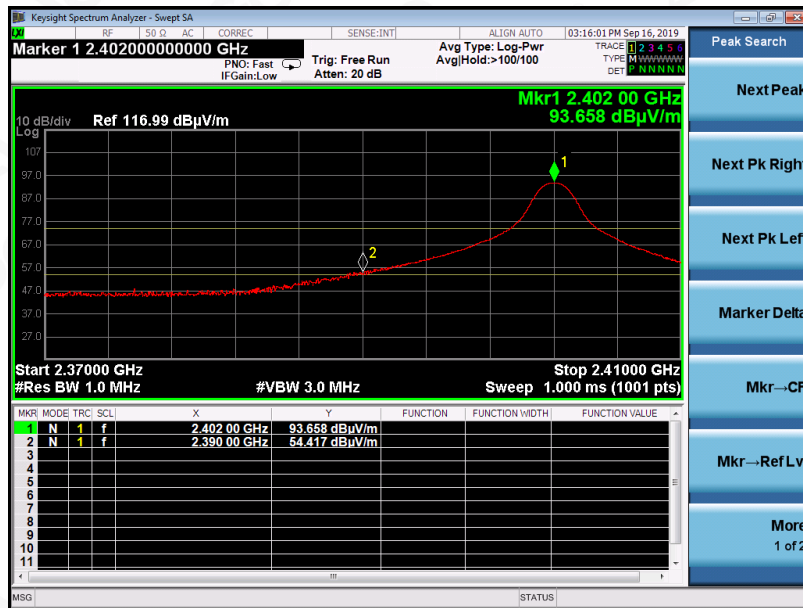

AV



RESULT: PASS



Attestation of Global Compliance

Attestation of Global Compliance(Shenzhen)Co.,Ltd.
 Add: 2/F., Building 2, Sanwei Chaxi Industrial Park, Sanwei Community,
 Hangcheng Street, Bao'an District, Shenzhen, Guangdong, China
 Tel: +86-755 2523 4088 E-mail: agc@agc-cert.com Service Hotline:400 089 2118

| | | | |
|-------------|--------------------|-------------------|----------------|
| EUT | Wireless headphone | Model Name | BTE008 |
| Temperature | 25°C | Relative Humidity | 55.4% |
| Pressure | 960hPa | Test Voltage | Normal Voltage |
| Test Mode | Mode 1 | Antenna | Vertical |

PK

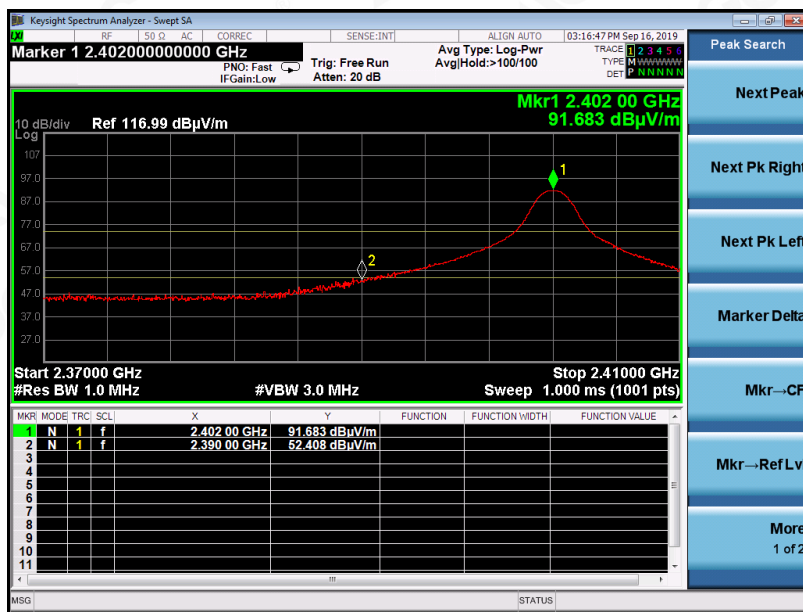

AV



RESULT: PASS



Attestation of Global Compliance

Attestation of Global Compliance(Shenzhen)Co.,Ltd.
Add: 2/F., Building 2, Sanwei Chaxi Industrial Park, Sanwei Community,
Hangcheng Street, Bao'an District, Shenzhen, Guangdong, China
Tel: +86-755 2523 4088 E-mail: agc@agc-cert.com Service Hotline:400 089 2118

| | | | |
|-------------|--------------------|-------------------|----------------|
| EUT | Wireless headphone | Model Name | BTE008 |
| Temperature | 25°C | Relative Humidity | 55.4% |
| Pressure | 960hPa | Test Voltage | Normal Voltage |
| Test Mode | Mode 3 | Antenna | Horizontal |

PK



AV



RESULT: PASS



Attestation of Global Compliance

Attestation of Global Compliance(Shenzhen)Co.,Ltd.

Add: 2/F., Building 2, Sanwei Chaxi Industrial Park, Sanwei Community,
Hangcheng Street, Bao'an District, Shenzhen, Guangdong, China

Tel: +86-755 2523 4088

E-mail: agc@agc-cert.com

Service Hotline: 400 089 2118

| | | | |
|-------------|--------------------|-------------------|----------------|
| EUT | Wireless headphone | Model Name | BTE008 |
| Temperature | 25°C | Relative Humidity | 55.4% |
| Pressure | 960hPa | Test Voltage | Normal Voltage |
| Test Mode | Mode 3 | Antenna | Vertical |

PK



AV



RESULT: PASS

Note: The factor had been edited in the "Input Correction" of the Spectrum Analyzer. So the Amplitude of test plots is equal to Reading level plus the Factor in dB. Use the A dB(µV) to represent the Amplitude. Use the F dB(µV/m) to represent the Field Strength. So A=F. All test modes had been pre-tested. The GFSK modulation is the worst case and recorded in the report.



Attestation of Global Compliance

Attestation of Global Compliance(Shenzhen)Co.,Ltd.
Add: 2/F., Building 2, Sanwei Chaxi Industrial Park, Sanwei Community,
Hangcheng Street, Bao'an District, Shenzhen, Guangdong, China
Tel: +86-755 2523 4088 E-mail: agc@agc-cert.com Service Hotline:400 089 2118

11. NUMBER OF HOPPING FREQUENCY

11.1. MEASUREMENT PROCEDURE

The EUT shall have its hopping function enabled. Use the following spectrum analyzer settings:

1. Span: The frequency band of operation. Depending on the number of channels the device supports, it may be necessary to divide the frequency range of operation across multiple spans, to allow the individual channels to be clearly seen.
2. RBW: To identify clearly the individual channels, set the RBW to less than 30% of the channel spacing or the 20 dB bandwidth, whichever is smaller.
3. VBW \geq RBW. Sweep: Auto. Detector function: Peak. Trace: Max hold.
4. Allow the trace to stabilize.

11.2. TEST SETUP (BLOCK DIAGRAM OF CONFIGURATION)

Same as described in section 8.2

11.3. MEASUREMENT EQUIPMENT USED

The same as described in section 6

11.4. LIMITS AND MEASUREMENT RESULT

| TOTAL NO. OF HOPPING CHANNEL | LIMIT (NO. OF CH) | MEASUREMENT (NO. OF CH) | RESULT |
|------------------------------|-------------------|-------------------------|--------|
| | | ≥ 15 | 79 |

TEST PLOT FOR NO. OF TOTAL CHANNELS

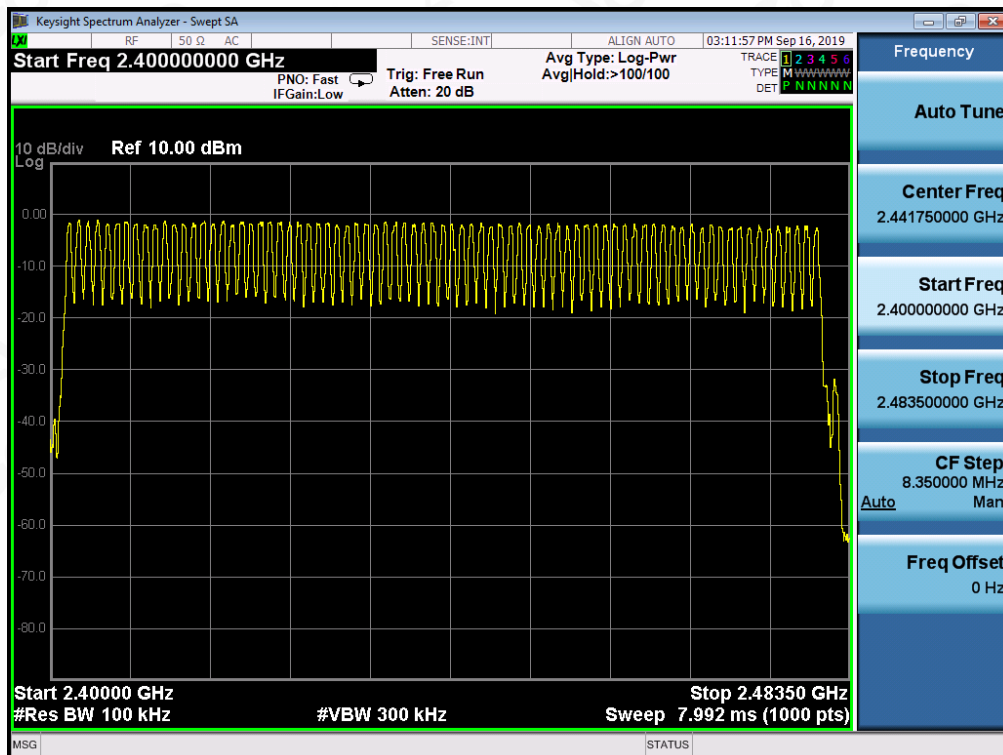

Note: The GFSK modulation is the worst case and recorded in the report.

12. TIME OF OCCUPANCY (DWELL TIME)

12.1. MEASUREMENT PROCEDURE

The EUT shall have its hopping function enabled. Use the following spectrum analyzer settings:

1. Span: Zero span, centered on a hopping channel.
2. RBW shall be \leq channel spacing and where possible RBW should be set $\gg 1 / T$, where T is the expected dwell time per channel.
3. Sweep: As necessary to capture the entire dwell time per hopping channel; where possible use a video trigger and trigger delay so that the transmitted signal starts a little to the right of the start of the plot. The trigger level might need slight adjustment to prevent triggering when the system hops on an adjacent channel; a second plot might be needed with a longer sweep time to show two successive hops on a channel.
4. Detector function: Peak. Trace: Max hold.
5. Use the marker-delta function to determine the transmit time per hop.
6. Repeat the measurement using a longer sweep time to determine the number of hops over the period specified in the requirements. The sweep time shall be equal to, or less than, the period specified in the requirements. Determine the number of hops over the sweep time and calculate the total number of hops in the period specified in the requirements, using the following equation:
(Number of hops in the period specified in the requirements) = (number of hops on spectrum analyzer) \times (period specified in the requirements / analyzer sweep time)
7. The average time of occupancy is calculated from the transmit time per hop multiplied by the number of hops in the period specified in the requirements.

12.2. TEST SETUP (BLOCK DIAGRAM OF CONFIGURATION)

Same as described in section 8.2

12.3. MEASUREMENT EQUIPMENT USED

The same as described in section 6

12.4. LIMITS AND MEASUREMENT RESULT

| Channel | Time of Pulse for DH5 (ms) | Number of hops in the period specified in the requirements | Sweep Time (ms) | Limit (ms) |
|---------|----------------------------|--|-----------------|------------|
| Low | 2.930 | 27*4 | 316.440 | 400 |
| Middle | 2.930 | 26*4 | 304.720 | 400 |
| High | 2.921 | 27*4 | 315.468 | 400 |

Note: The 8-DPSK modulation is the worst case and recorded in the report.

TEST PLOT OF LOW CHANNEL

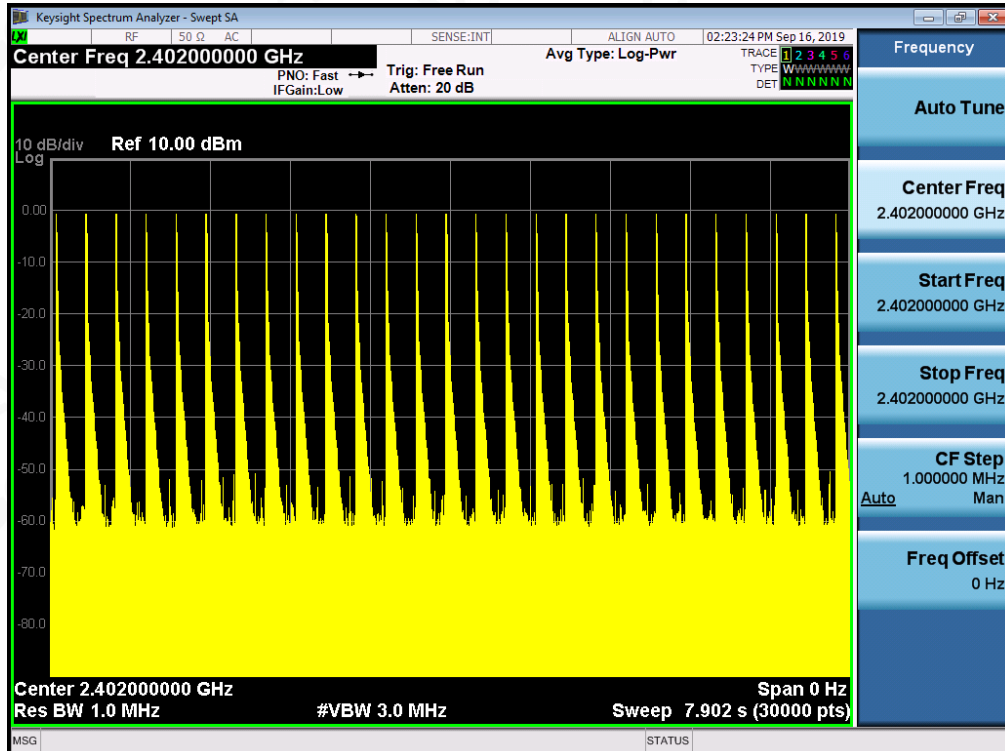
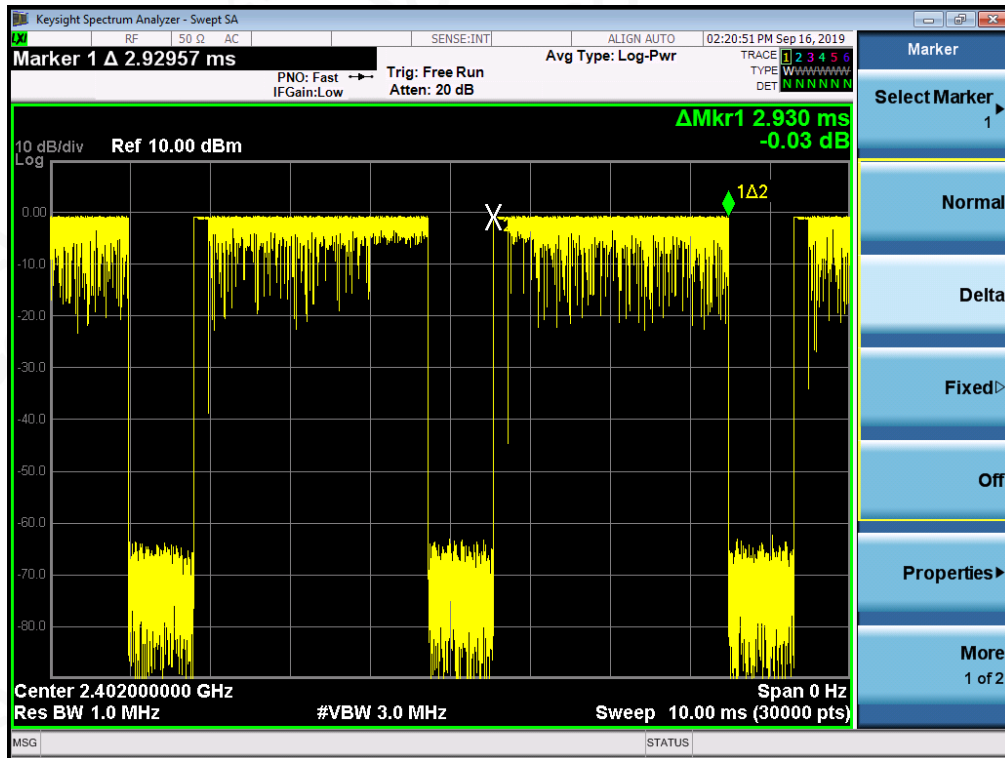

Attestation of Global Compliance

Attestation of Global Compliance(Shenzhen)Co.,Ltd.

Add: 2/F., Building 2, Sanwei Chaxi Industrial Park, Sanwei Community, Hangcheng Street, Bao'an District, Shenzhen, Guangdong, China

Tel: +86-755 2523 4088

E-mail: agc@agc-cert.com

Service Hotline: 400 089 2118

TEST PLOT OF MIDDLE CHANNEL

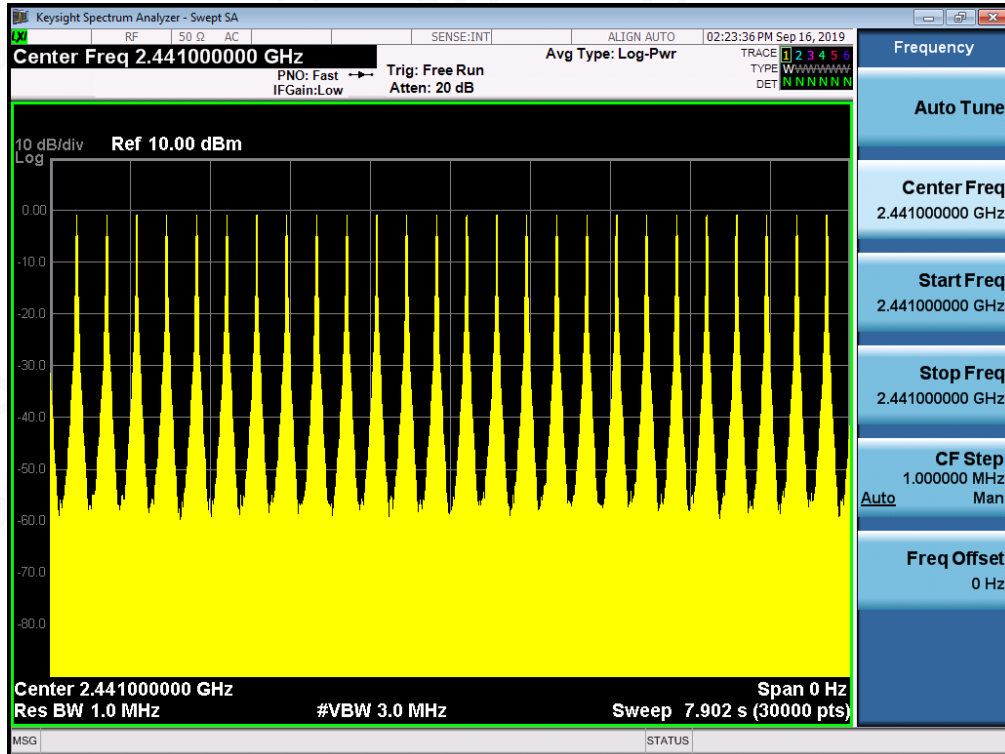
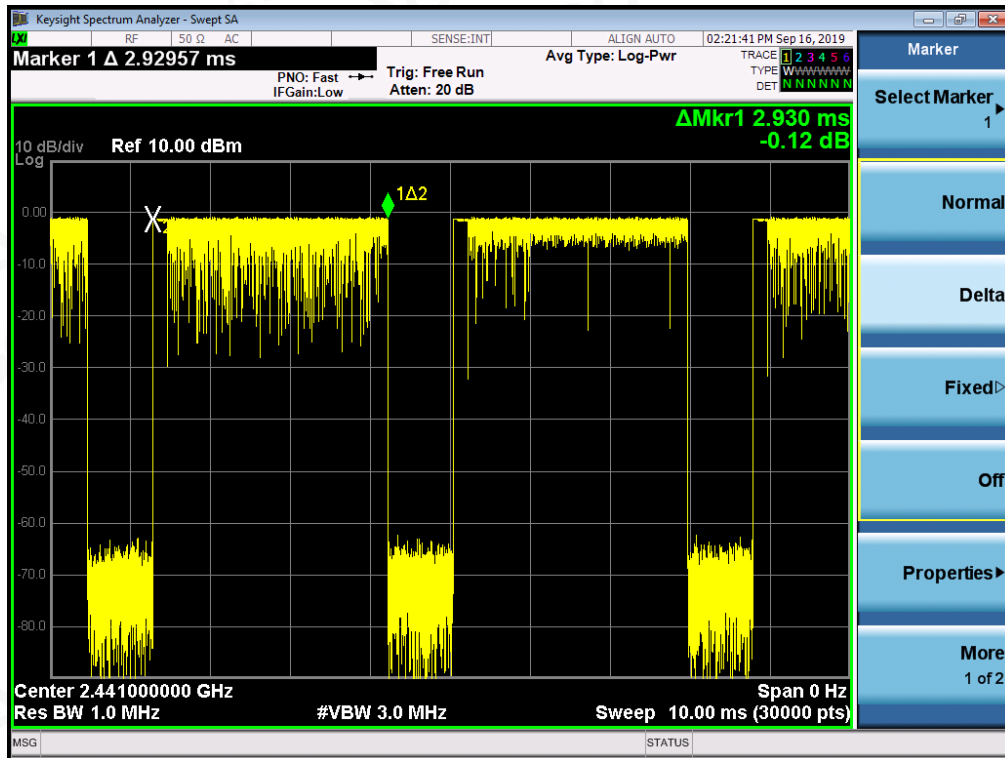

Attestation of Global Compliance

Attestation of Global Compliance(Shenzhen)Co.,Ltd.

Add: 2/F., Building 2, Sanwei Chaxi Industrial Park, Sanwei Community,
Hangcheng Street, Bao'an District, Shenzhen, Guangdong, China

Tel: +86-755 2523 4088

E-mail: agc@agc-cert.com

Service Hotline: 400 089 2118

TEST PLOT OF HIGH CHANNEL

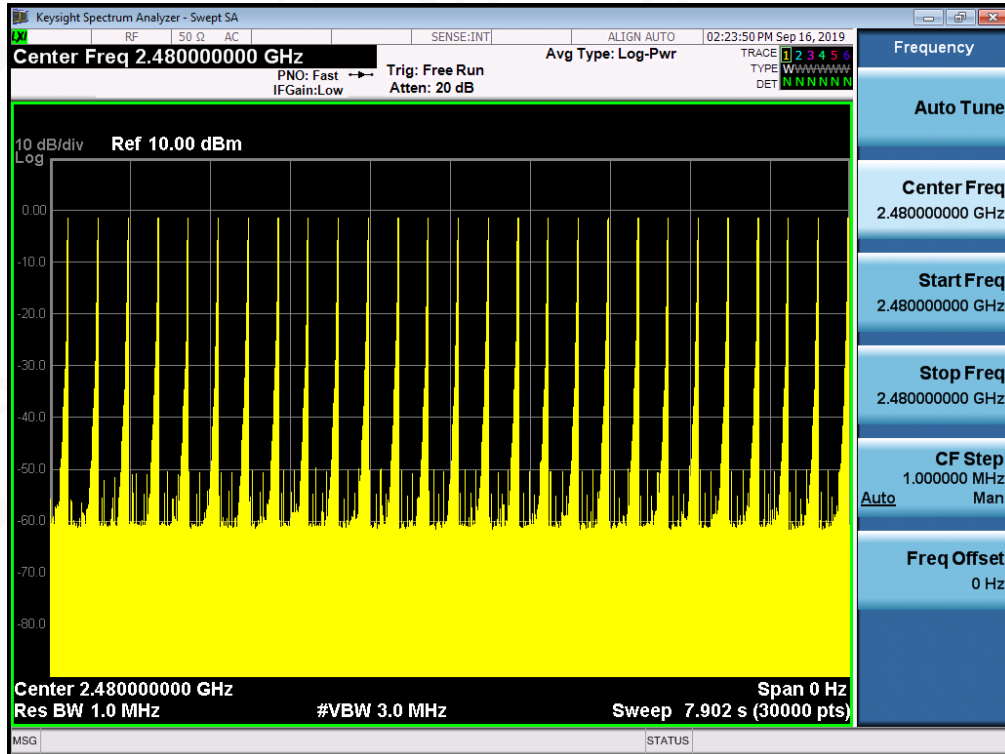
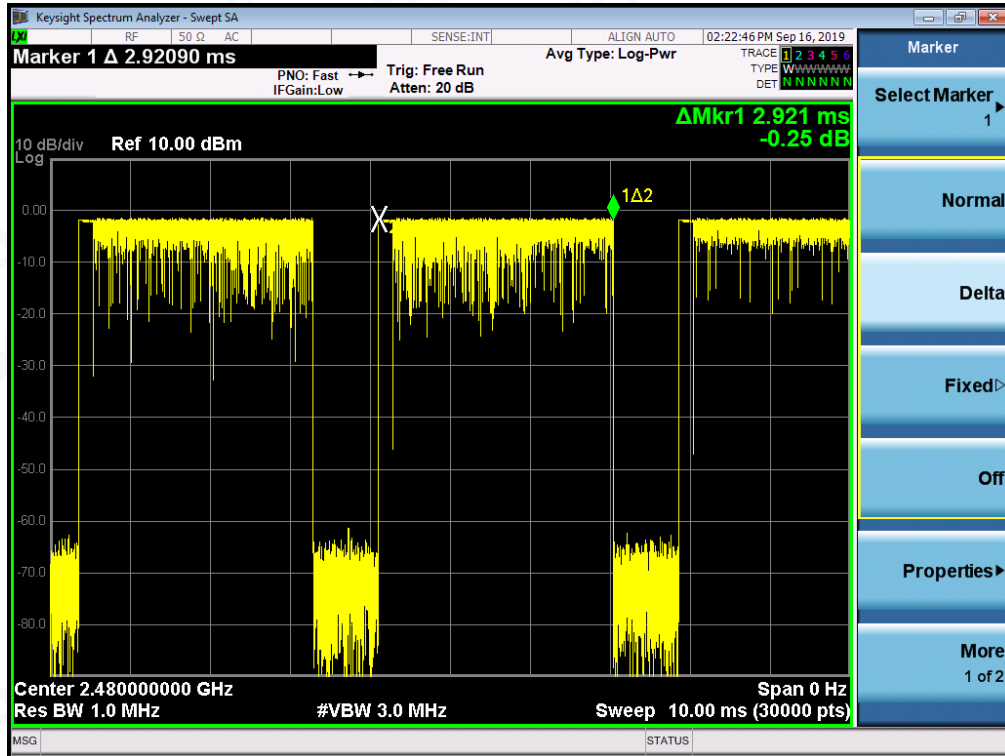

Attestation of Global Compliance

Attestation of Global Compliance(Shenzhen)Co.,Ltd.

Add: 2/F., Building 2, Sanwei Chaxi Industrial Park, Sanwei Community,
Hangcheng Street, Bao'an District, Shenzhen, Guangdong, China

Tel: +86-755 2523 4088

E-mail: agc@agc-cert.com

Service Hotline: 400 089 2118

13. FREQUENCY SEPARATION

13.1. MEASUREMENT PROCEDURE

The EUT shall have its hopping function enabled. Use the following spectrum analyzer settings:

1. Span: Wide enough to capture the peaks of two adjacent channels.
2. RBW: Start with the RBW set to approximately 30% of the channel spacing; adjust as necessary to best identify the center of each individual channel.
3. Video (or average) bandwidth (VBW) \geq RBW.
4. Sweep: Auto. e) Detector function: Peak. f) Trace: Max hold. g) Allow the trace to stabilize.

Use the marker-delta function to determine the separation between the peaks of the adjacent channels.

13.2. TEST SETUP (BLOCK DIAGRAM OF CONFIGURATION)

Same as described in section 6.2

13.3. MEASUREMENT EQUIPMENT USED

The same as described in section 6.3

13.4. LIMITS AND MEASUREMENT RESULT

| CHANNEL | CHANNEL SEPARATION | LIMIT | RESULT |
|-----------|--------------------|-------------------------------|--------|
| | KHz | KHz | |
| CH01-CH02 | 1001 | ≥ 25 KHz or 2/3 20 dB BW | Pass |

TEST PLOT FOR FREQUENCY SEPARATION

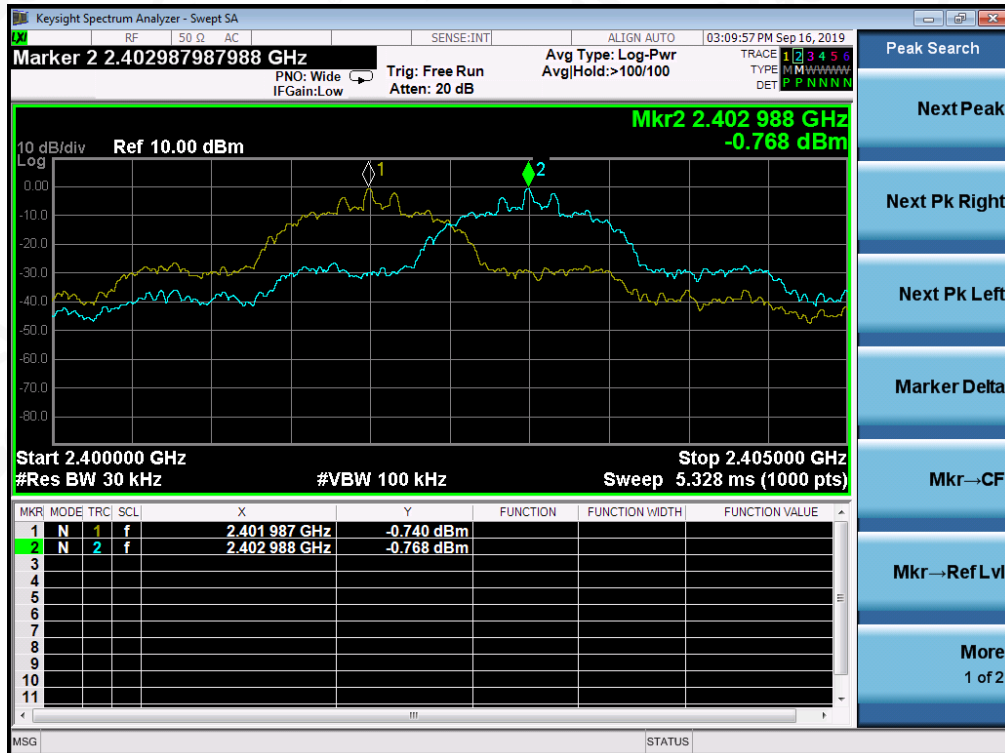

Note: The 8-DPSK modulation is the worst case and recorded in the report.

APPENDIX A: PHOTOGRAPHS OF TEST SETUP

RADIATED EMISSION TEST SETUP BELOW 1GHZ

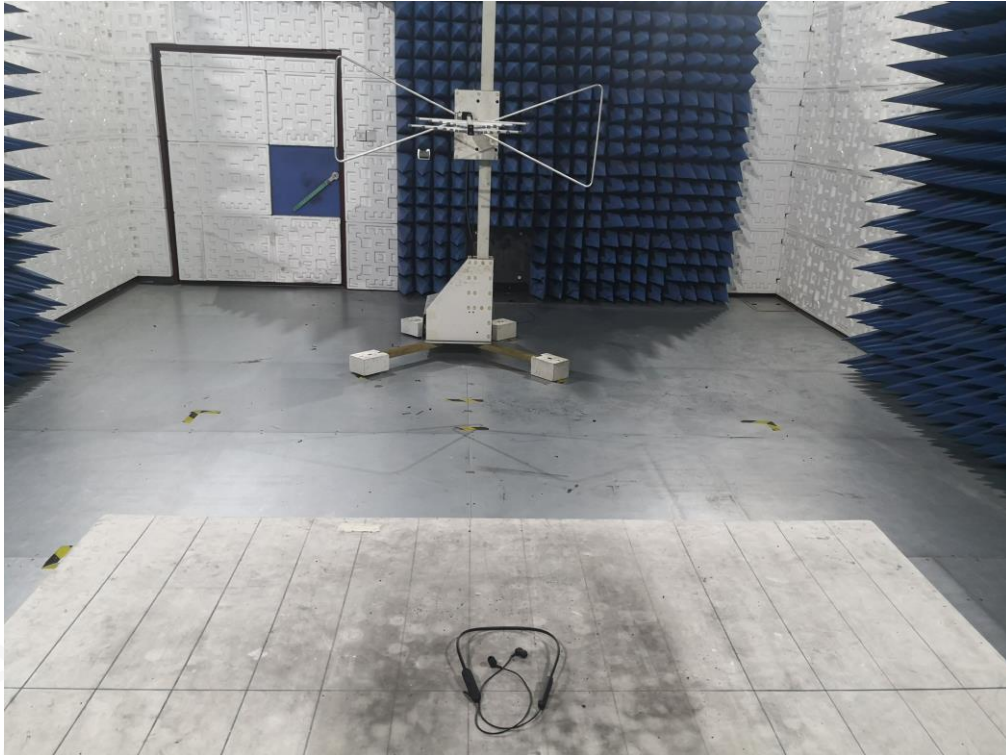

RADIATED EMISSION TEST SETUP ABOVE 1GHZ



APPENDIX B: PHOTOGRAPHS OF EUT

TOP VIEW OF EUT

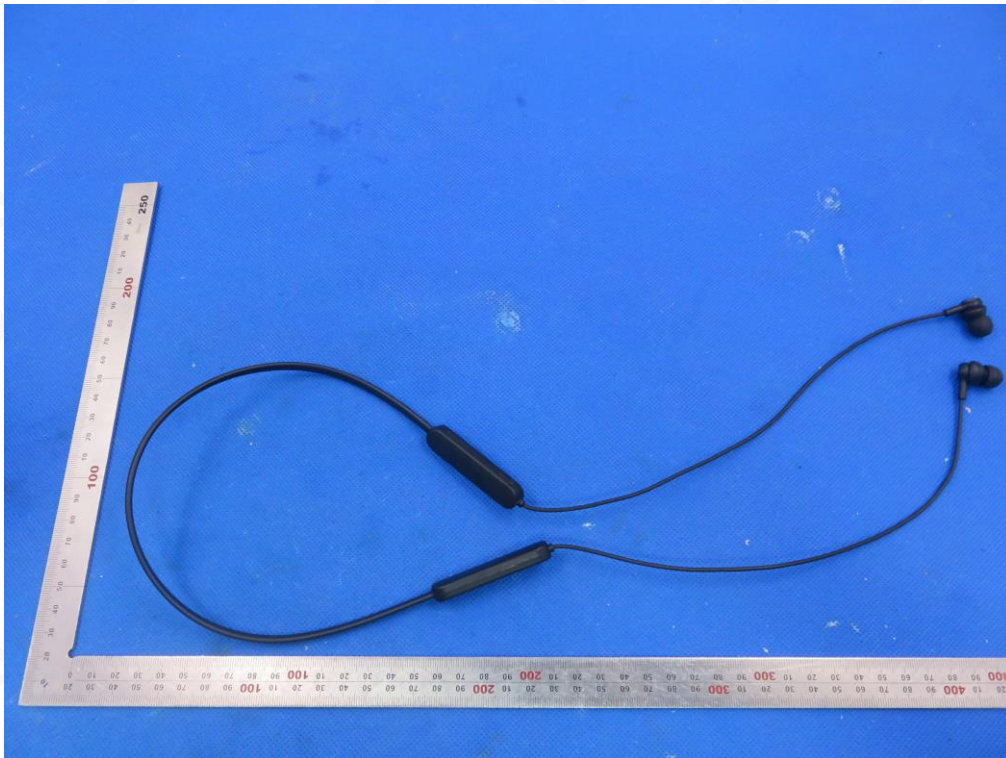

BOTTOM VIEW OF EUT

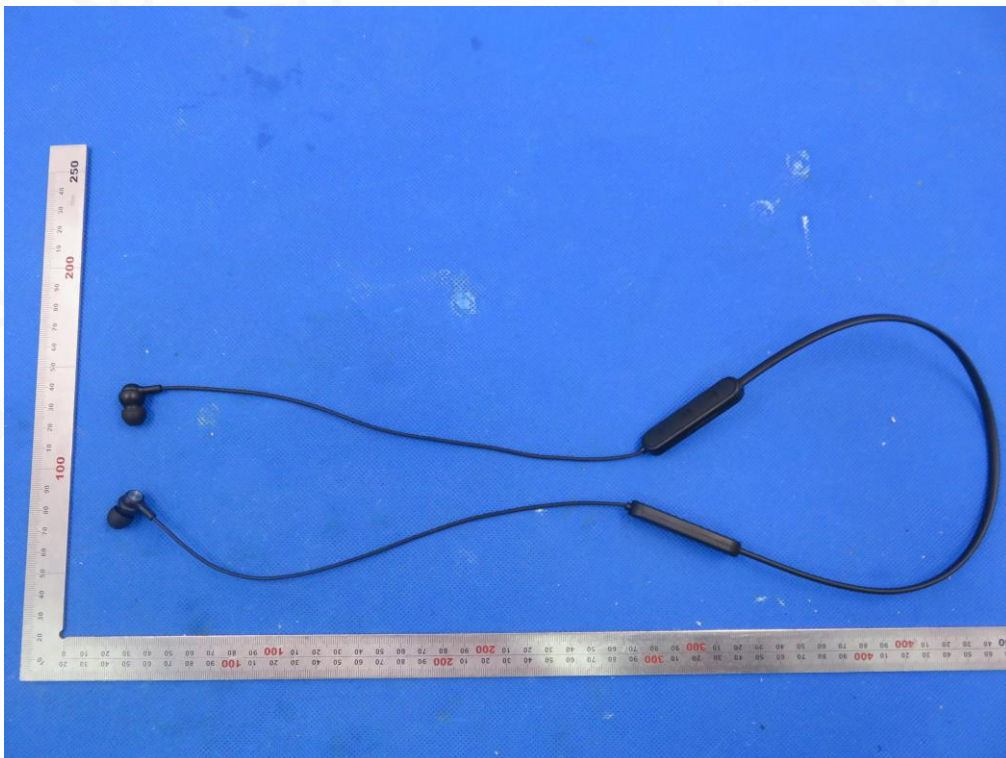

FRONT VIEW OF EUT



BACK VIEW OF EUT



LEFT VIEW OF EUT

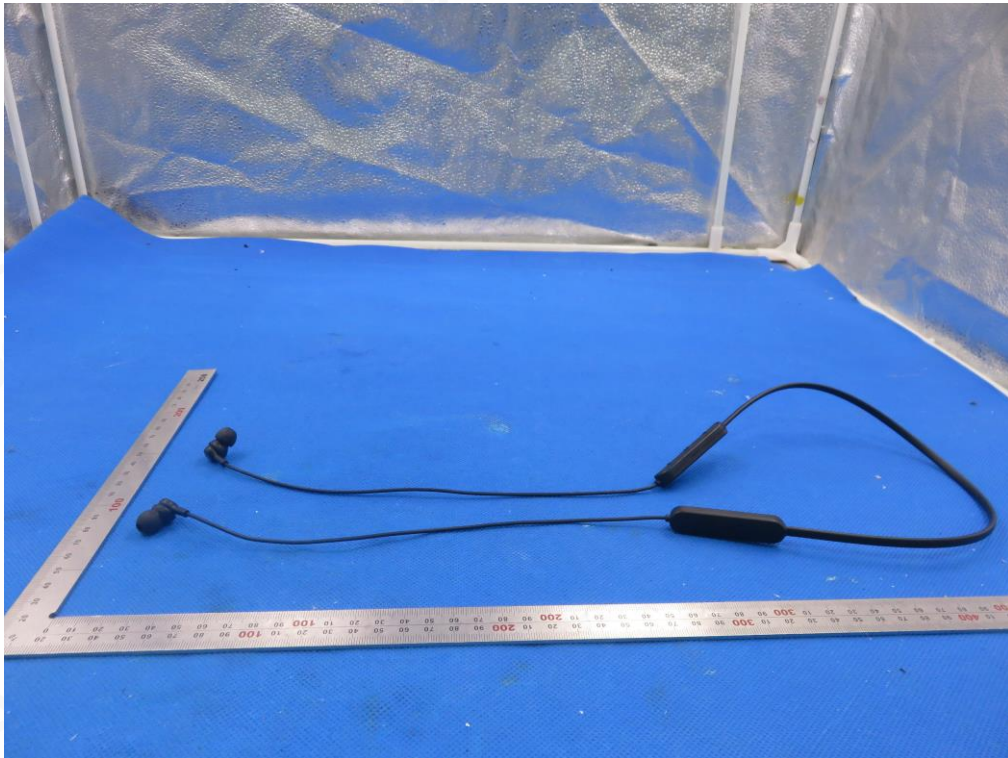

RIGHT VIEW OF EUT

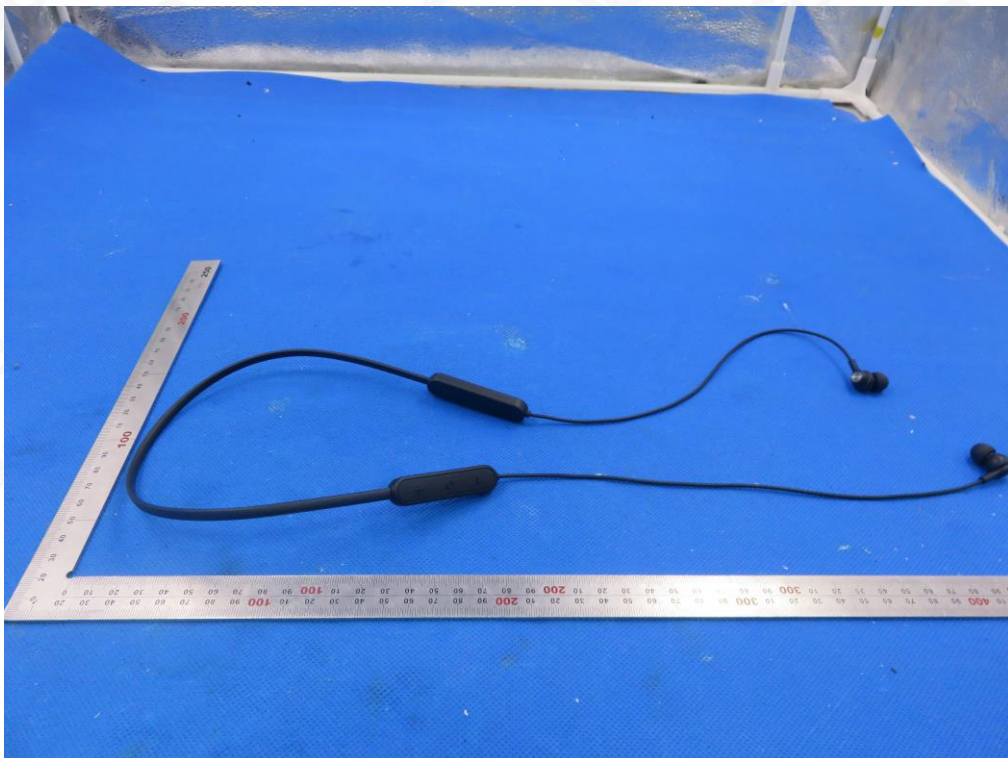

VIEW OF EUT (PORT)



OPEN VIEW OF EUT

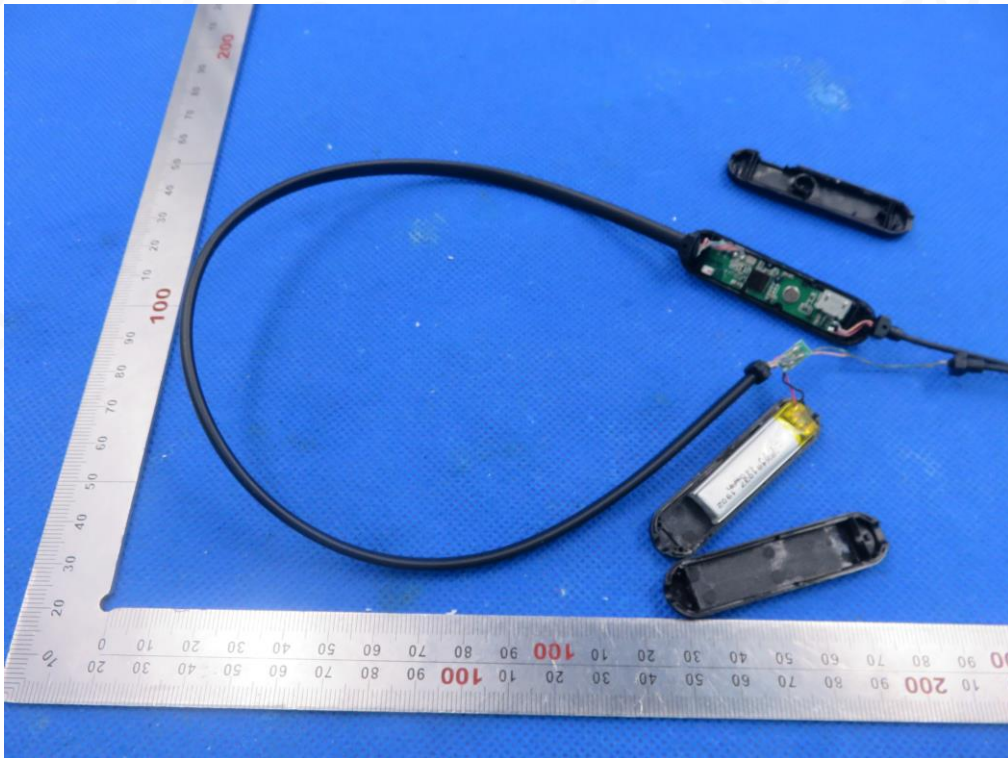

VIEW OF BATTERY

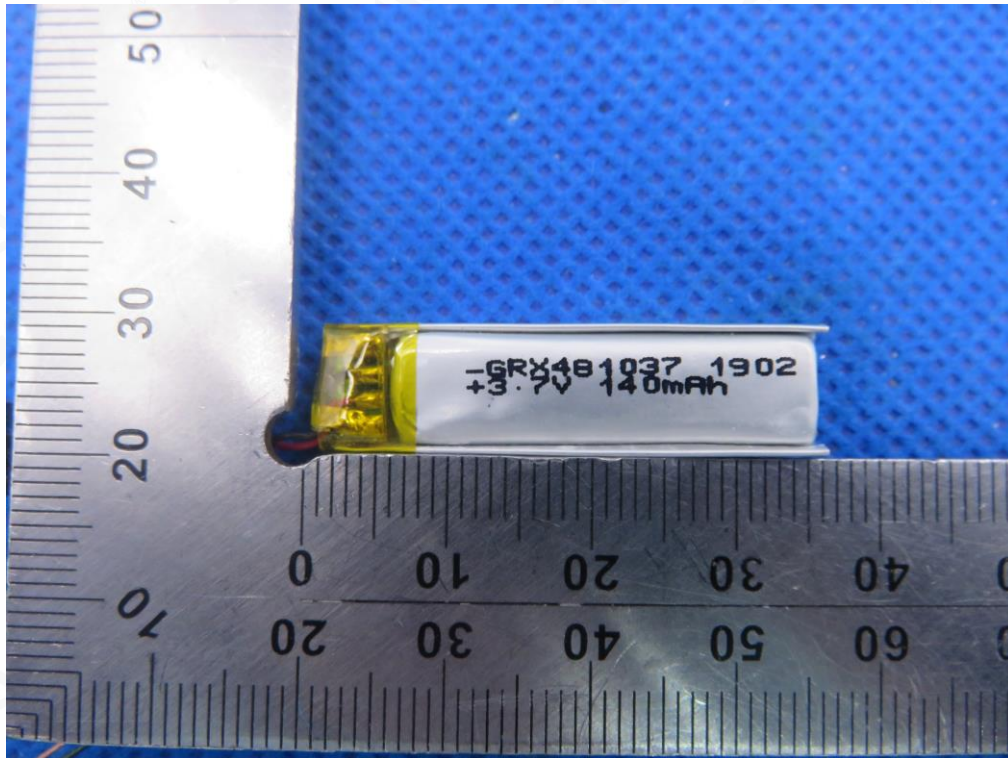

INTERNAL VIEW-1 OF EUT

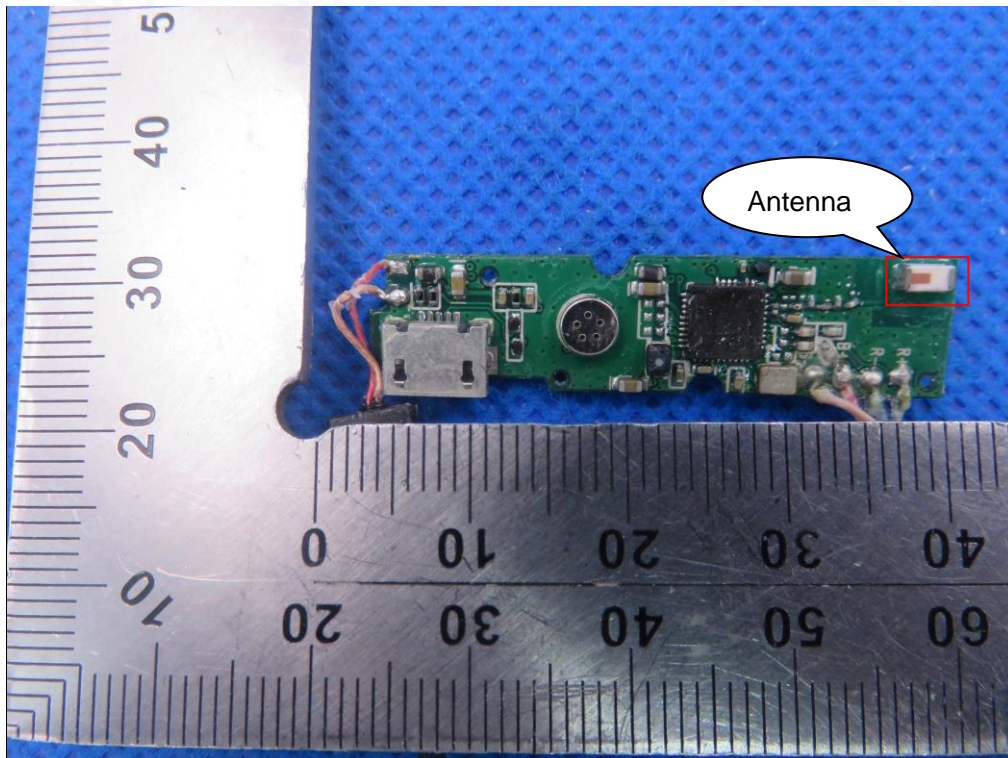

INTERNAL VIEW-2 OF EUT

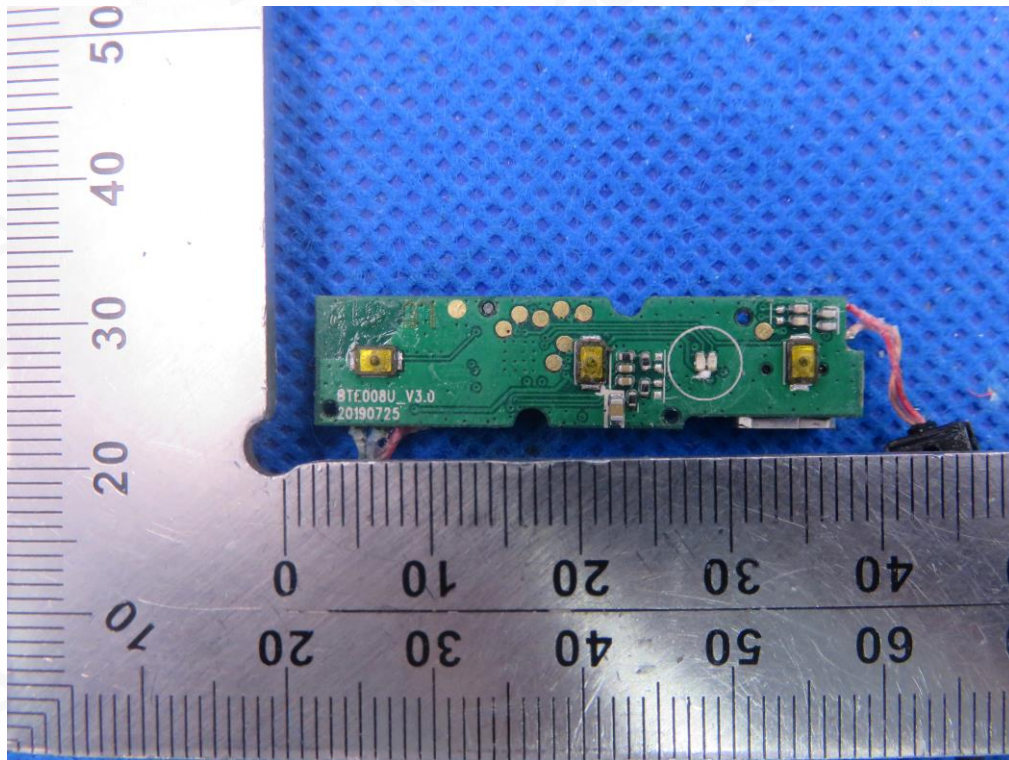

----END OF REPORT----

