



**FCC 47 CFR PART 15 SUBPART C
INDUSTRY CANADA RSS-247 ISSUE 1**

**BLUETOOTH LOW ENERGY
CERTIFICATION TEST REPORT**

FOR

BLE WEARABLE PLATFORM

MODEL NUMBER: CURIE CRB

**FCC ID: 2AB8ZND17
IC: 1000X-ND17**

REPORT NUMBER: 16U23126-E1V3

ISSUE DATE: MAY 09, 2016, 2016

Prepared for
**INTEL CORPORATION
2200 MISSION COLLEGE BOULEVARD,
SANTA CLARA, CA 95052, U.S.A**

Prepared by
**UL VERIFICATION SERVICES INC.
47173 BENICIA STREET
FREMONT, CA 94538, U.S.A.
TEL: (510) 771-1000
FAX: (510) 661-0888**



NVLAP LAB CODE 200065-0

Revision History

<u>Rev.</u>	<u>Issue Date</u>	<u>Revisions</u>	<u>Revised By</u>
V1	03/25/2016	Initial Issue	C. Pang
V2	4/28/2016	Revision to model name	Grace Rincand
V3	05/09/2016	Add below 30MHz radiated spurious data	C. Pang

TABLE OF CONTENTS

1. ATTESTATION OF TEST RESULTS	5
2. TEST METHODOLOGY	6
3. FACILITIES AND ACCREDITATION	6
4. CALIBRATION AND UNCERTAINTY	7
4.1. MEASURING INSTRUMENT CALIBRATION	7
4.2. SAMPLE CALCULATION	7
4.3. MEASUREMENT UNCERTAINTY.....	7
5. EQUIPMENT UNDER TEST	8
5.1. DESCRIPTION OF EUT	8
5.2. MAXIMUM OUTPUT POWER.....	8
5.3. DESCRIPTION OF AVAILABLE ANTENNAS	8
5.4. SOFTWARE AND FIRMWARE.....	8
5.5. WORST-CASE CONFIGURATION AND MODE.....	8
5.6. DESCRIPTION OF TEST SETUP.....	9
6. TEST AND MEASUREMENT EQUIPMENT	13
7. ANTENNA PORT TEST RESULTS	14
7.1. MEASUREMENT METHODS	14
7.2. ON TIME, DUTY CYCLE	15
7.3. 6 dB BANDWIDTH.....	16
7.4. 99% BANDWIDTH.....	19
7.5. OUTPUT POWER.....	22
7.6. AVERAGE POWER.....	25
7.7. POWER SPECTRAL DENSITY	26
7.8. CONDUCTED SPURIOUS EMISSIONS.....	29
8. RADIATED TEST RESULTS.....	33
8.1. LIMITS AND PROCEDURE	33
8.2. TRANSMITTER ABOVE 1 GHz.	34
8.3. WORST-CASE BELOW 1 GHz.....	44
8.4. TX SPURIOUS FROM 0.15 TO 30 MHz	46
8.5. AC POWER LINE CONDUCTED EMISSIONS	47
8.5.1. EUT WITH USB POWER ADAPTER	48
8.5.2. EUT WITH LAPTOP	52

9. SETUP PHOTOS.....56

1. ATTESTATION OF TEST RESULTS

COMPANY NAME: INTEL CORPORATION
2200 MISSION COLLEGE BOULEVARD
SANTA CLARA, CA 95052, U.S.A.

EUT DESCRIPTION: BLE WEARABLE PLATFORM

MODEL: CURIE CRB

SERIAL NUMBER: CRBSQ6040102, CRBSQ6040040 (Conducted)
CRBEV1SQ061600096 (Radiated)

DATE TESTED: MARCH 21-25 and MAY 06, 2016

APPLICABLE STANDARDS	
STANDARD	TEST RESULTS
CFR 47 Part 15 Subpart C	Pass
INDUSTRY CANADA RSS-247 Issue 1	Pass
INDUSTRY CANADA RSS-GEN Issue 4	Pass

UL Verification Services Inc. tested the above equipment in accordance with the requirements set forth in the above standards. All indications of Pass/Fail in this report are opinions expressed by UL Verification Services Inc. based on interpretations and/or observations of test results. Measurement Uncertainties were not taken into account and are published for informational purposes only. The test results show that the equipment tested is capable of demonstrating compliance with the requirements as documented in this report.

Note: The results documented in this report apply only to the tested sample, under the conditions and modes of operation as described herein. This document may not be altered or revised in any way unless done so by UL Verification Services Inc. and all revisions are duly noted in the revisions section. Any alteration of this document not carried out by UL Verification Services Inc. will constitute fraud and shall nullify the document. This report must not be used by the client to claim product certification, approval, or endorsement by NVLAP, NIST, any agency of the Federal Government, or any agency of any government.

Approved & Released For
UL Verification Services Inc. By:



PREPARED By:

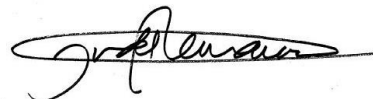

CHIN PANG
EMC SENIOR ENGINEER
UL VERIFICATION SERVICES INC.

JUDE SEMANA
EMC ENGINEER
UL VERIFICATION SERVICES INC.

2. TEST METHODOLOGY

The tests documented in this report were performed in accordance with FCC CFR 47 Part 2, FCC CFR 47 Part 15, ANSI C63.10-2013, RSS-GEN Issue 4 and RSS-247 Issue 1.

3. FACILITIES AND ACCREDITATION

The test sites and measurement facilities used to collect data are located at 47173 Benicia Street, Fremont, California, USA. Line conducted emissions are measured only at the 47173 address. The following table identifies which facilities were utilized for radiated emission measurements documented in this report. Specific facilities are also identified in the test results sections.

47173 Benicia Street	47266 Benicia Street
<input type="checkbox"/> Chamber A	<input type="checkbox"/> Chamber D
<input checked="" type="checkbox"/> Chamber B	<input type="checkbox"/> Chamber E
<input type="checkbox"/> Chamber C	<input type="checkbox"/> Chamber F
	<input type="checkbox"/> Chamber G
	<input type="checkbox"/> Chamber H

The above test sites and facilities are covered under FCC Test Firm Registration # 208313. Chambers A through H are covered under Industry Canada company address code 2324B with site numbers 2324B -1 through 2324B-8, respectively.

UL Verification Services Inc. is accredited by NVLAP, Laboratory Code 200065-0. The full scope of accreditation can be viewed at <http://ts.nist.gov/standards/scopes/2000650.htm>.

4. CALIBRATION AND UNCERTAINTY

4.1. MEASURING INSTRUMENT CALIBRATION

The measuring equipment utilized to perform the tests documented in this report has been calibrated in accordance with the manufacturer's recommendations, and is traceable to recognized national standards.

4.2. SAMPLE CALCULATION

Where relevant, the following sample calculation is provided:

$$\begin{aligned} \text{Field Strength (dBuV/m)} &= \text{Measured Voltage (dBuV)} + \text{Antenna Factor (dB/m)} + \\ &\text{Cable Loss (dB)} - \text{Preamp Gain (dB)} \\ 36.5 \text{ dBuV} + 18.7 \text{ dB/m} + 0.6 \text{ dB} - 26.9 \text{ dB} &= 28.9 \text{ dBuV/m} \end{aligned}$$

4.3. MEASUREMENT UNCERTAINTY

Where relevant, the following measurement uncertainty levels have been estimated for tests performed on the apparatus:

PARAMETER	UNCERTAINTY
Conducted Disturbance, 0.15 to 30 MHz	± 3.52 dB
Radiated Disturbance, 30 to 1000 MHz	± 4.94 dB
Radiated Disturbance, 1 to 6 GHz	± 3.86 dB
Radiated Disturbance, 6 to 18 GHz	± 4.23 dB
Radiated Disturbance, 18 to 26 GHz	± 5.30 dB
Radiated Disturbance, 26 to 40 GHz	± 5.23 dB

Uncertainty figures are valid to a confidence level of 95%.

5. EQUIPMENT UNDER TEST

5.1. DESCRIPTION OF EUT

The EUT is a BLE smart watch development kit.

5.2. MAXIMUM OUTPUT POWER

The transmitter has a maximum peak conducted output power as follows:

Frequency Range (MHz)	Mode	Output Power (dBm)	Output Power (mW)
2402 - 2480	BLE	2.78	1.90

5.3. DESCRIPTION OF AVAILABLE ANTENNAS

The radio utilizes a chip antenna, with a maximum gain of 1.7 dBi.

5.4. SOFTWARE AND FIRMWARE

The firmware installed in the EUT during testing was MFG.

5.5. WORST-CASE CONFIGURATION AND MODE

Radiated emission and power line conducted emission were performed with the EUT set to transmit at the channel with highest output power as worst-case scenario.

The fundamental of the EUT was investigated in three orthogonal orientations X, Y and Z, it was determined that Y orientation was worst-case orientation; therefore, all final radiated testing was performed with the EUT in Y orientation.

Worst-case data rates as provided by the client were:

BLE: 1 Mbps.

5.6. DESCRIPTION OF TEST SETUP

SUPPORT EQUIPMENT

Support Equipment List				
Description	Manufacturer	Model	Serial Number	FCC ID
Laptop	Lenovo	Yoga 2 11	YB04499042	N/A
AC Adapter	Lenovo	ADLX45NCC3A	11S45N0297ZSH443G	N/A

I/O CABLES

I/O Cable List					
Cable No	Port	# of identical ports	Connector Type	Cable Type	Cable Length (m)
1	AC	1	3-Prong	Un-Shielded	1.8
2	DC	1	DC	Un-Shielded	1
3	USB	2	USB	Shielded	1.8
4	Serial	1	Ribbon Cable Connector	Un-Shielded	0.25
5	Antenna	1	SMA	Un-Shielded	0.025

TEST SETUP

Test software exercised the radio card.

SETUP DIAGRAM FOR CONDUCTED TESTS

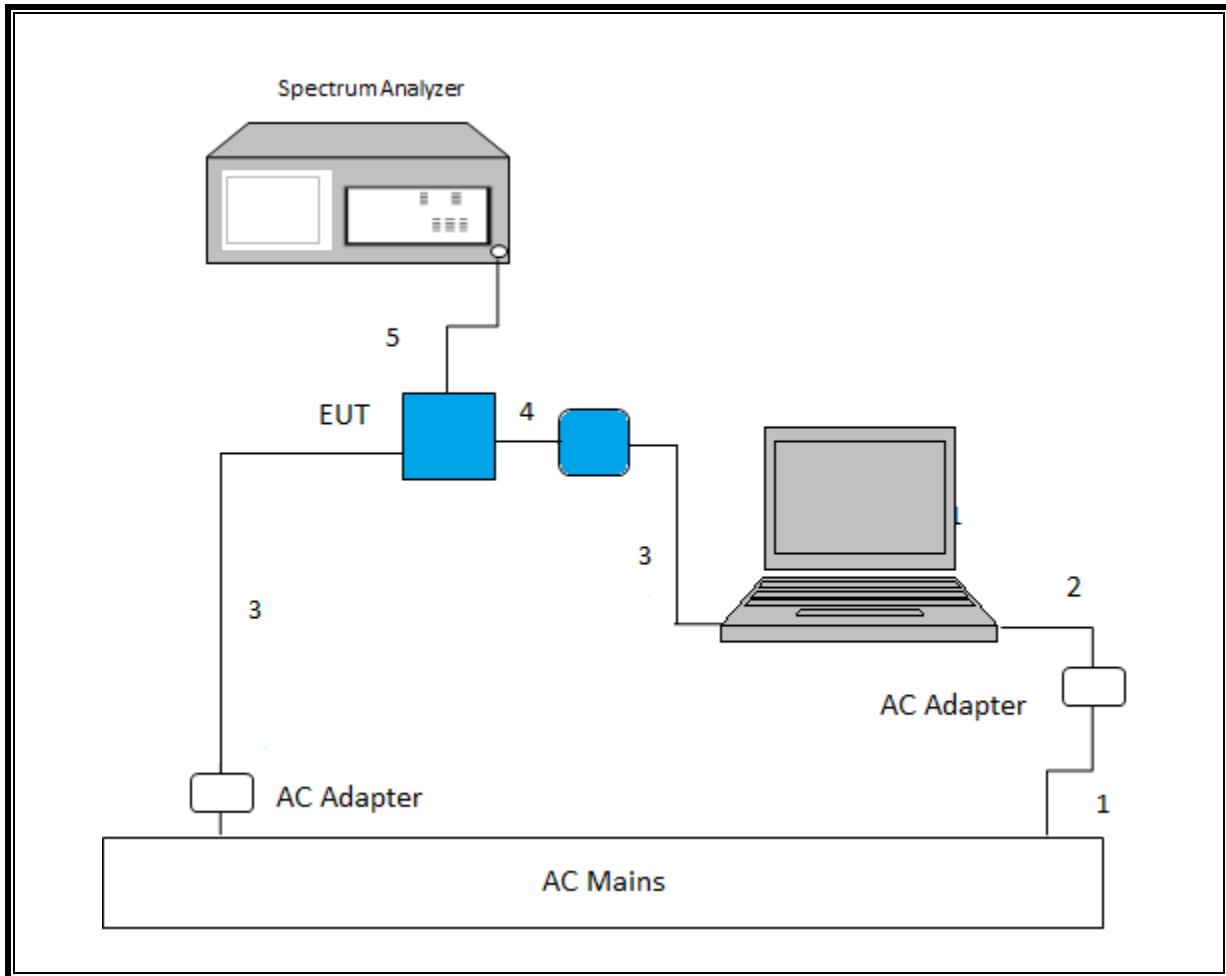

SETUP DIAGRAM FOR RADIATED TESTS

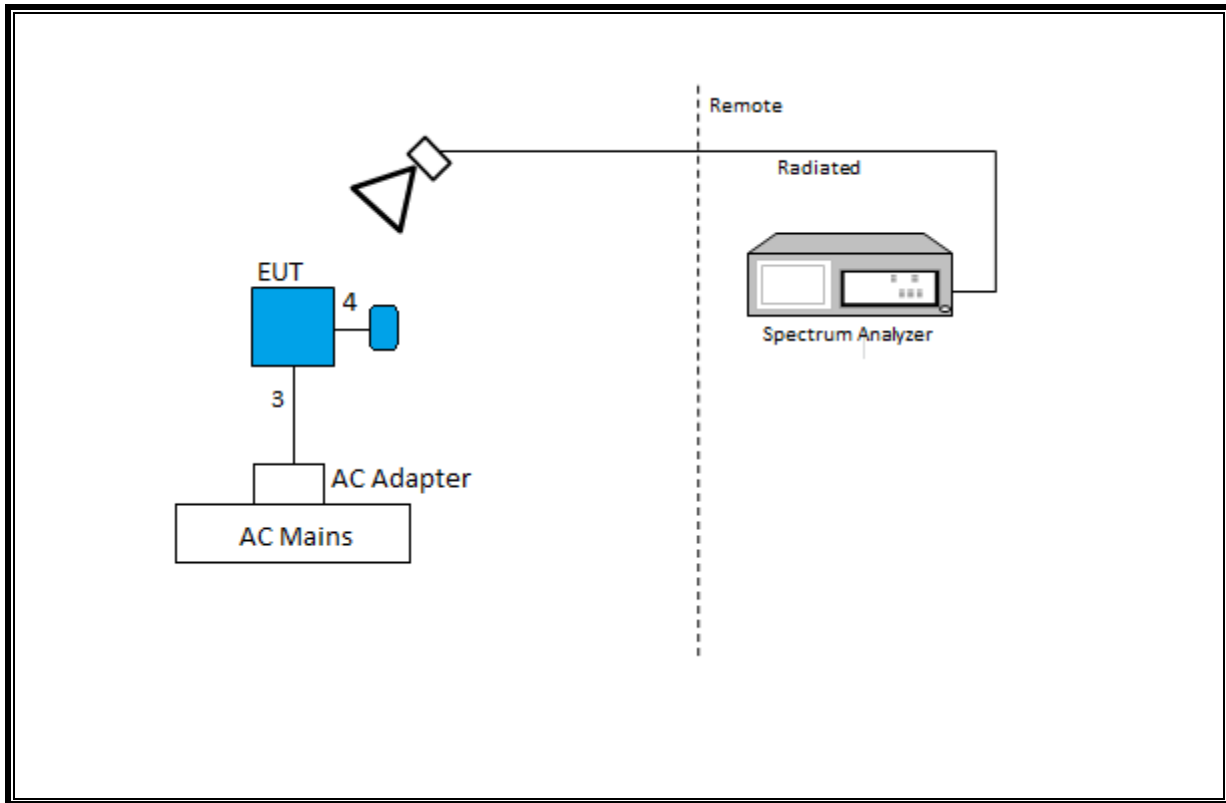

SETUP DIAGRAM FOR LINE CONDUCTED TEST

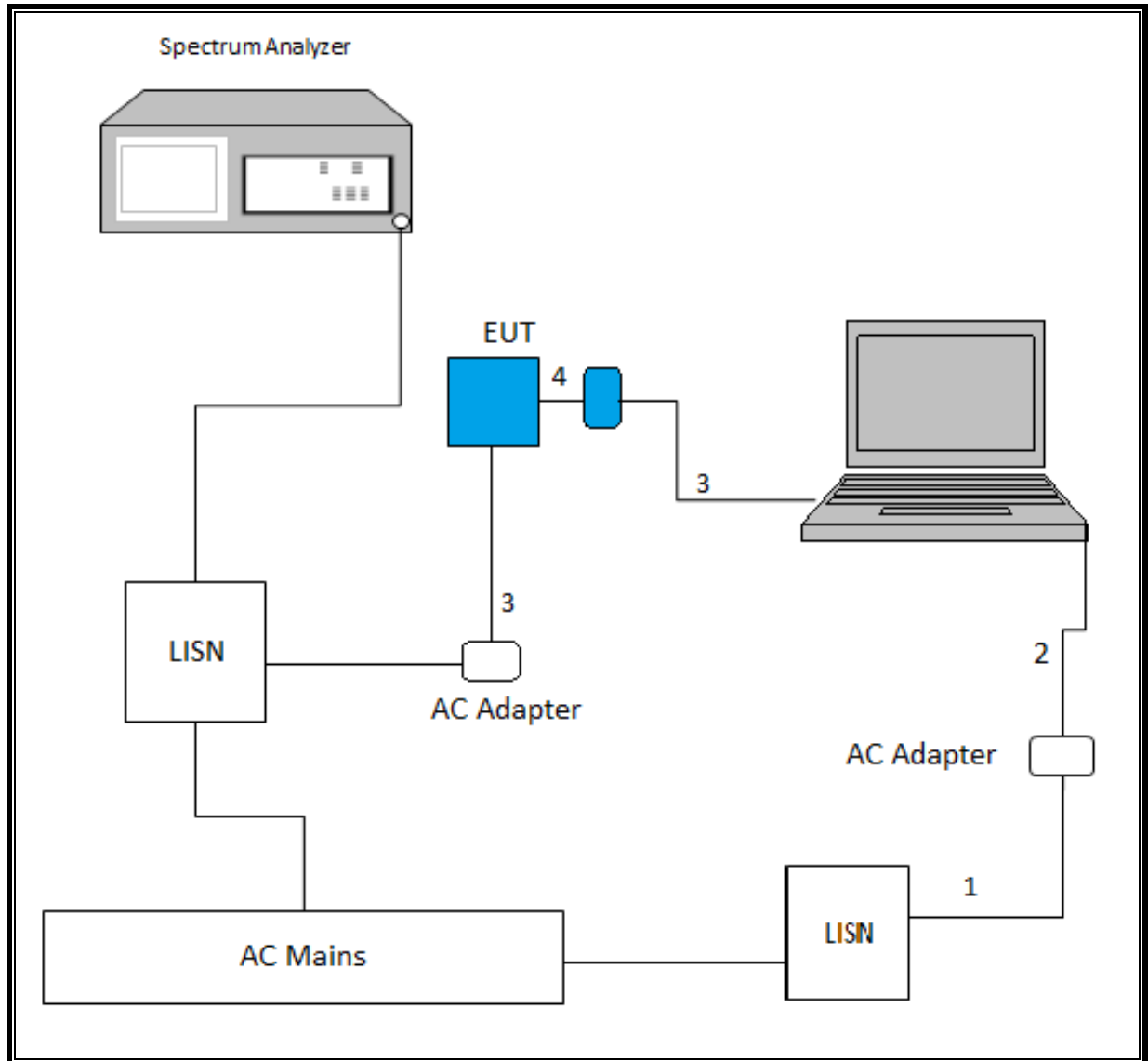

6. TEST AND MEASUREMENT EQUIPMENT

The following test and measurement equipment was utilized for the tests documented in this report:

Test Equipment List					
Description	Manufacturer	Model	T No.	Cal Date	Cal Due
Radiated Software	UL	UL EMC		Ver 9.5	
Conducted Software	UL	UL EMC		Ver 3.5	
Amplifier, 1-18GHz	Miteq	AFS42-00101800-25-S-42	493	03/09/16	03/09/17
Amplifier, 1-8GHz, 35 dB	Miteq	AMF-4D-01000800-30-29P	1156	03/09/16	03/09/17
Antenna, Biconolog, 30MHz-1 GHz	Sunol Sciences	JB1	122	01/29/16	01/29/17
Antenna, Horn, 18GHz	ETS Lindgren	3117	346	02/22/16	02/22/17
Antenna, Horn, 26.5 GHz	ARA	MWH-1826/B	447	05/12/15	05/12/16
ESR7 EMI Test Receiver 7GHz	Rohde & Schwarz	ESR	1436	12/19/15	12/19/16
High Pass Filter 3GHz	Micro-Tronics	HPS17543	485	03/09/16	03/09/17
High Pass Filter 3GHz	Micro-Tronics	HPS17543	486	07/20/15	07/20/16
High Pass Filter 6GHz	Micro-Tronics	HPS17542	483	03/09/16	03/09/17
High Pass Filter 6GHz	Micro-Tronics	HPS17542	484	07/20/15	07/20/16
LISN, 30 MHz	FCC	FCC-LISN-50/250-25-2	24	02/09/16	02/09/17
Low Pass Filter 5GHz	Micro-Tronics	LPS17541	482	03/09/16	03/09/17
Reject Filter, 2.4GHz	Micro-Tronics	BRM50702	160	CNR	CNR
Low Pass Filter 5GHz	Micro-Tronics	LPS17541	481	07/20/15	07/20/16
Peak / Average Power Sensor	Keysight	N1921A	750	09/17/15	09/17/16
Peak Power Meter	Agilent / HP	N1911A	1268	07/06/16	07/06/17
Antenna, Loop 9KHz to 30MHz	ETS Lindgren	6502	T757	05/21/15	05/21/16
RF Preamplifier, 1GHz - 18GHz	Miteq	NSP4000-SP2	88	04/07/15	04/07/16
RF Preamplifier, 1GHz - 26.5GHz	HP	8449B	404	06/29/15	06/29/16

7. ANTENNA PORT TEST RESULTS

7.1. MEASUREMENT METHODS

6 dB BW: KDB 558074 D01 v03r04, Section 8.1.

Output Power: KDB 558074 D01 v03r04, Section 9.1.2.

Power Spectral Density: KDB 558074 D01 v03r04, Section 10.2.

Out-of-band emissions in non-restricted bands: KDB 558074 D01 v03r04, Section 11.0.

Out-of-band emissions in restricted bands: KDB 558074 D01 v03r04, Section 12.1.

Band-edge: KDB 558074 D01 v03r04, Section 12.1

7.2. ON TIME, DUTY CYCLE

None; for reporting purposes only.

PROCEDURE

KDB 558074 Zero-Span Spectrum Analyzer Method.

ON TIME AND DUTY CYCLE RESULTS

Mode	ON Time B (msec)	Period (msec)	Duty Cycle x (linear)	Duty Cycle (%)	Duty Cycle Correction Factor (dB)	1/B Minimum VBW (kHz)
BLE	0.171	0.625	0.273	27.36%	5.63	584.800

DUTY CYCLE PLOTS

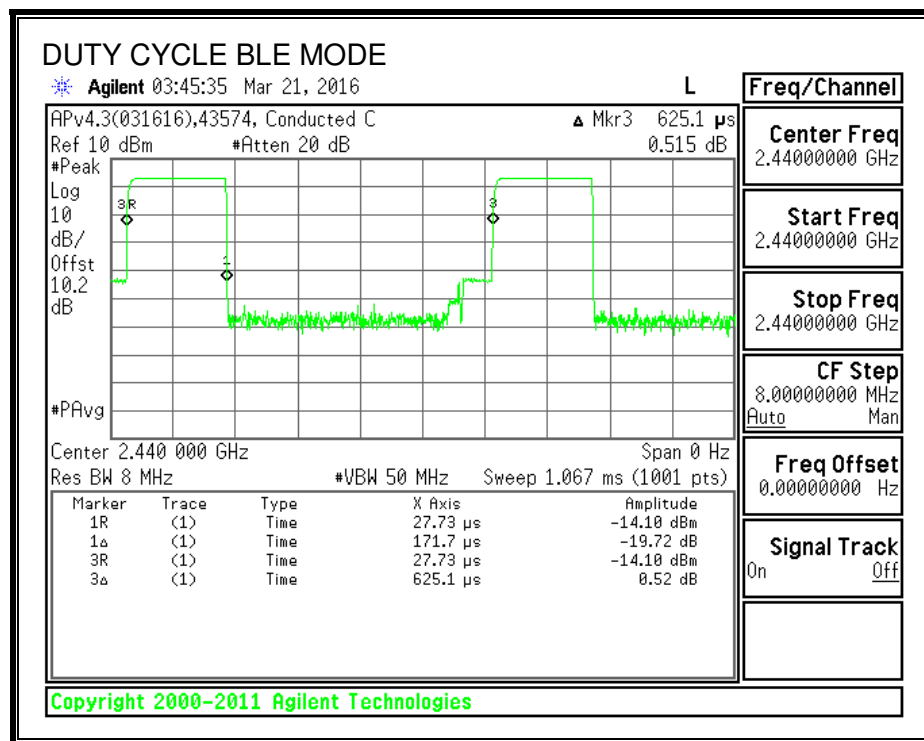

7.3. 6 dB BANDWIDTH

LIMITS

FCC §15.247 (a) (2)

IC RSS-247 (5.2) (1)

The minimum 6 dB bandwidth shall be at least 500 kHz.

RESULTS

Channel	Frequency (MHz)	6 dB Bandwidth (MHz)	Minimum Limit (MHz)
Low	2402	0.662	0.5
Middle	2440	0.652	0.5
High	2480	0.663	0.5

6 dB BANDWIDTH

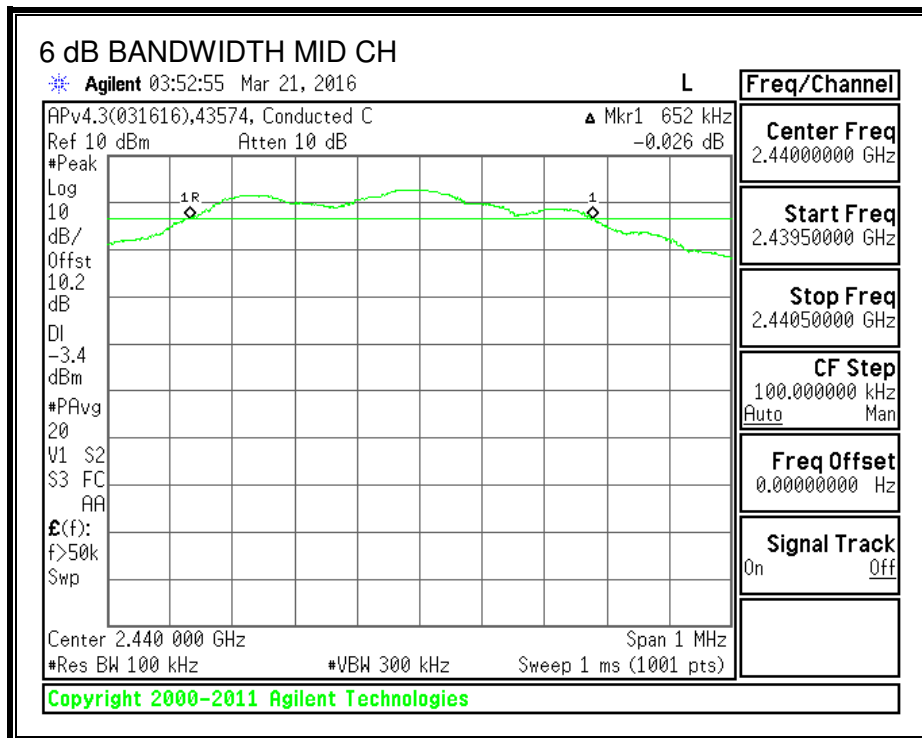
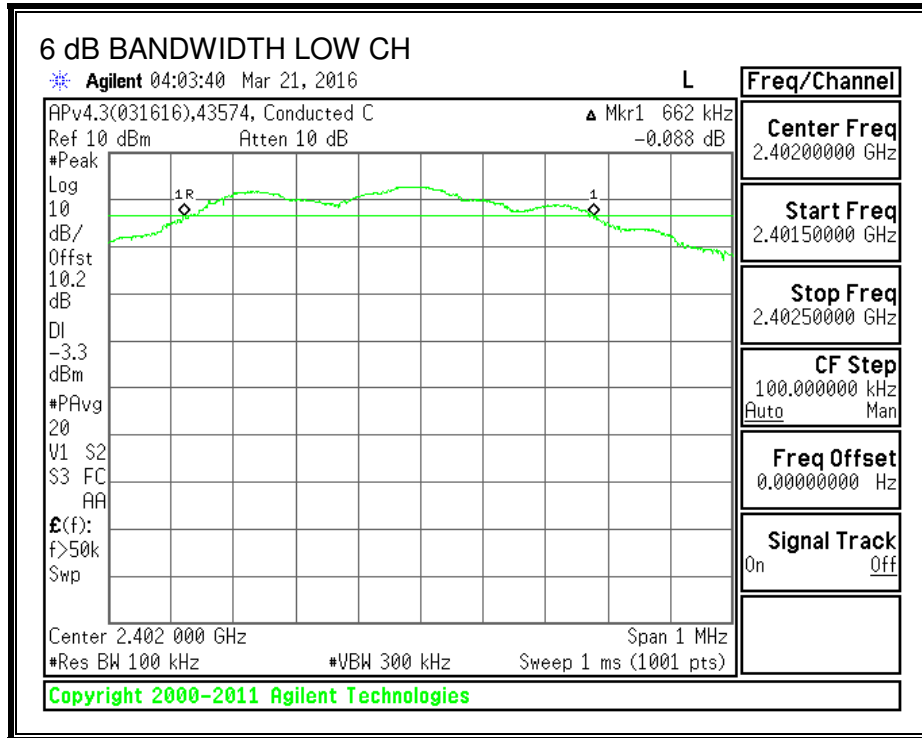

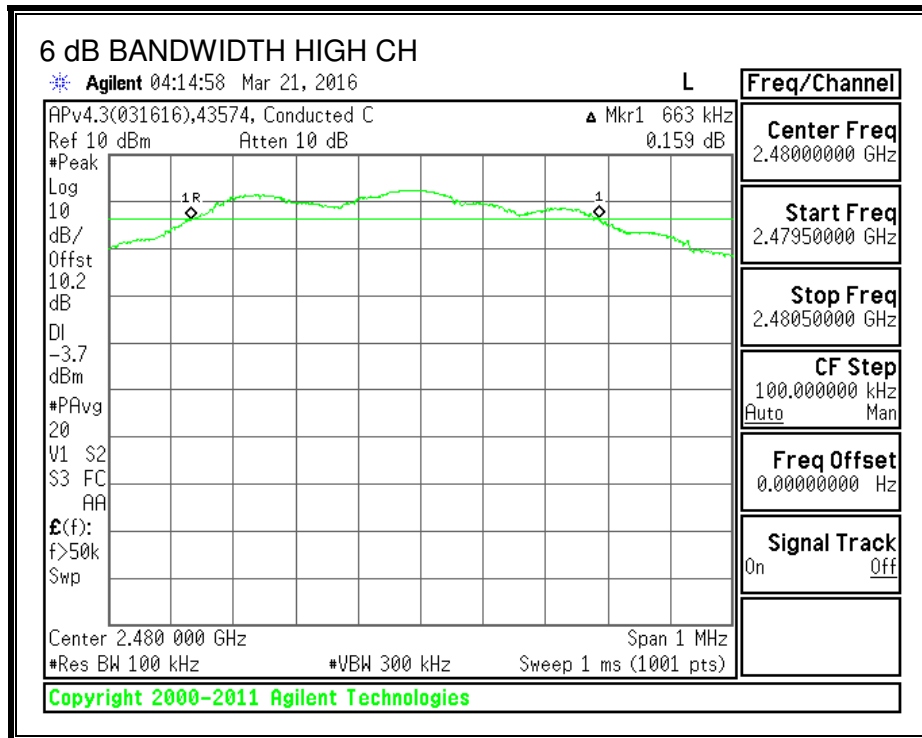

7.4. 99% BANDWIDTH

LIMITS

None; for reporting purposes only.

TEST PROCEDURE

The transmitter output is connected to the spectrum analyzer. The RBW is set to 1% to 3% of the 99 % bandwidth and to 1% of the span. The VBW is set to 3 times the RBW. The sweep time is coupled. The spectrum analyzer internal 99% bandwidth function is utilized.

RESULTS

Channel	Frequency (MHz)	99% Bandwidth (MHz)
Low	2402	0.9727718
Middle	2440	0.9667535
High	2480	0.9715281

99% BANDWIDTH

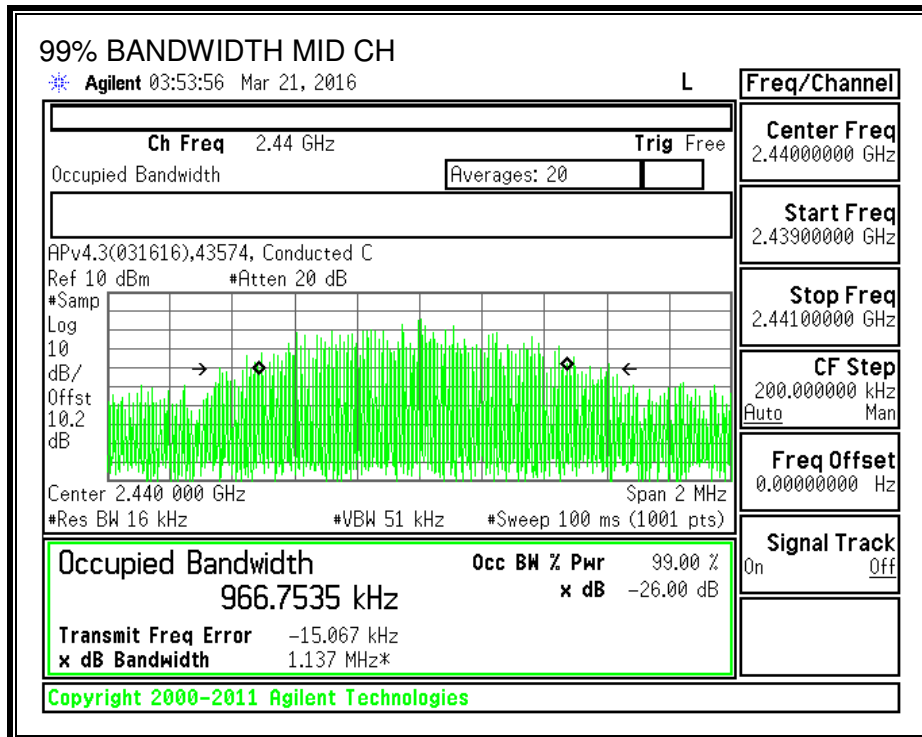
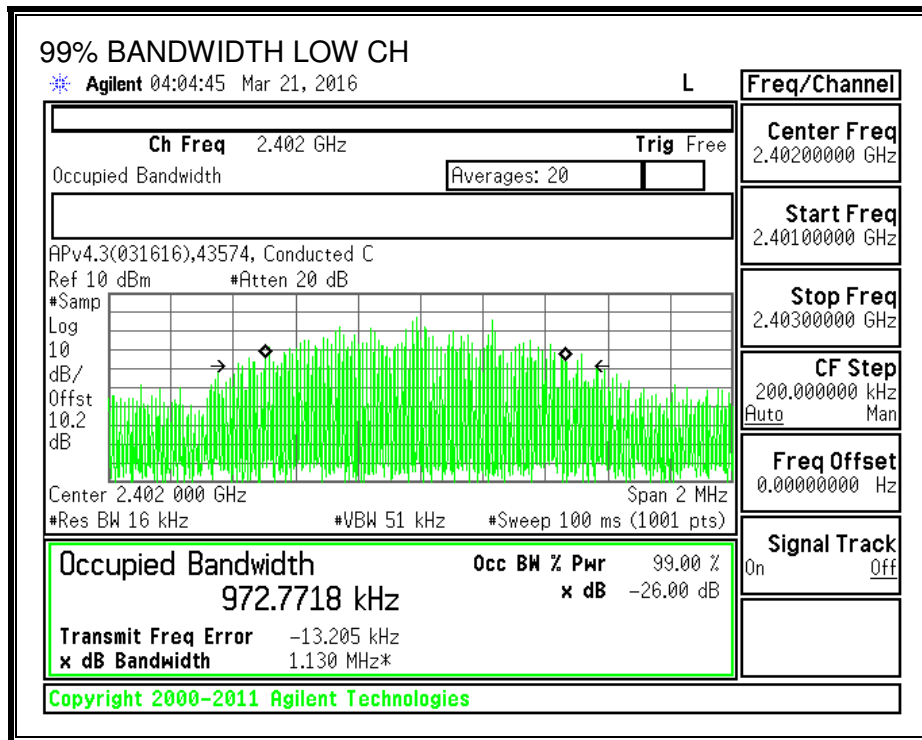

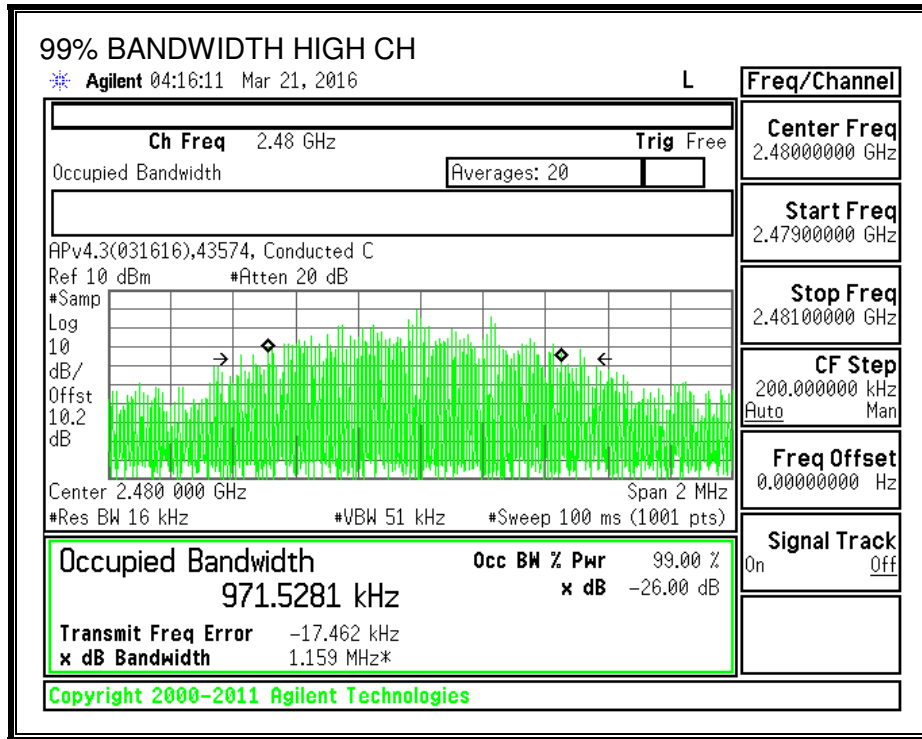

7.5. OUTPUT POWER

LIMITS

FCC §15.247 (b)

IC RSS-247 (5.4) (4)

The maximum antenna gain is less than or equal to 6 dBi, therefore the limit is 30 dBm.

RESULTS

Channel	Frequency (MHz)	Peak Power Reading (dBm)	Limit (dBm)	Margin (dB)
Low	2402	2.750	30	-27.250
Middle	2440	2.779	30	-27.221
High	2480	2.450	30	-27.550

OUTPUT POWER

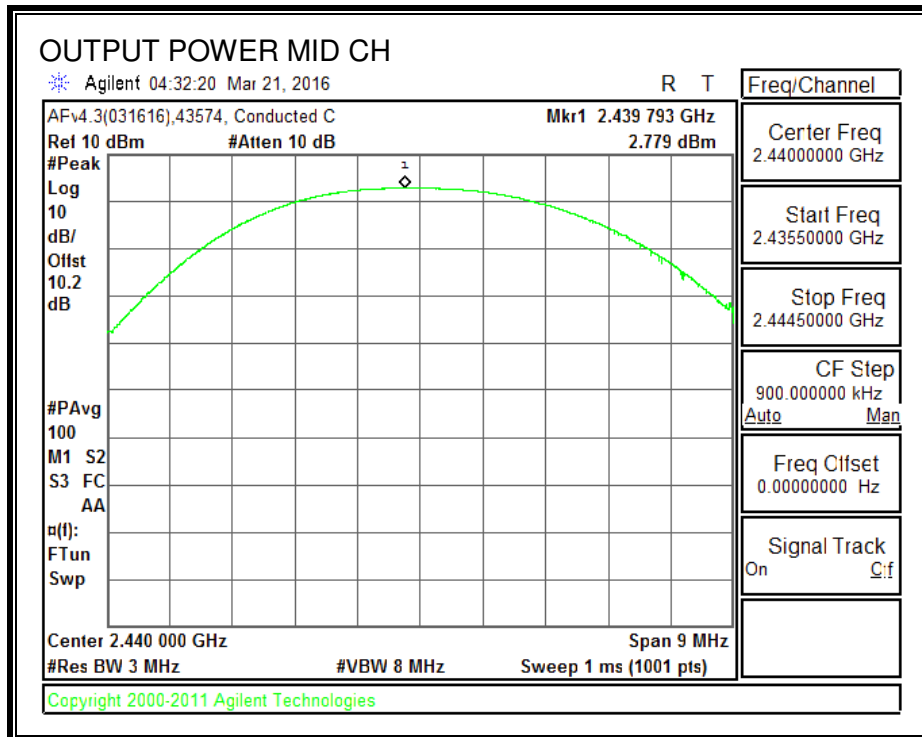
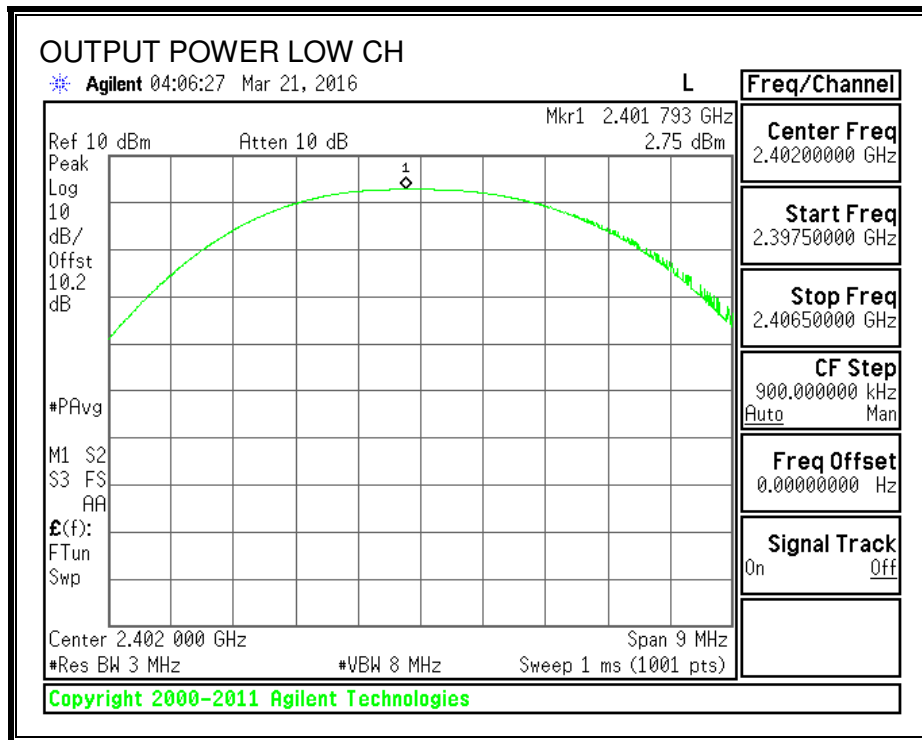

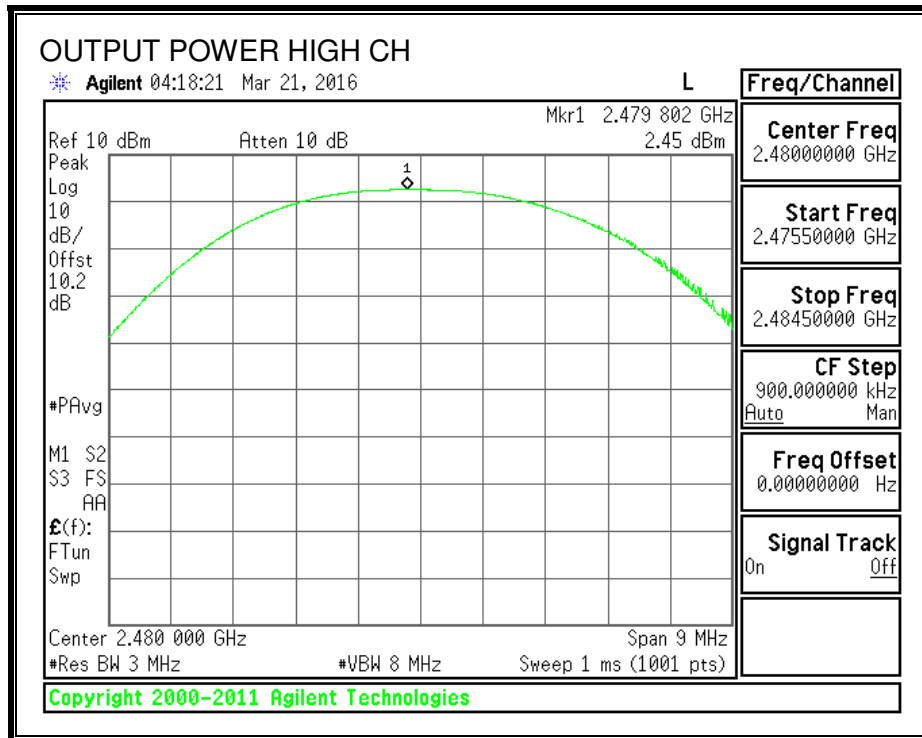

7.6. AVERAGE POWER

LIMITS

None; for reporting purposes only.

RESULTS

The cable assembly insertion loss of 10.25 dB (including 10 dB pad and 0.25 dB cable) was entered as an offset in the power meter to allow for direct reading of power.

Channel	Frequency (MHz)	AV power (dBm)
Low	2402	2.65
Middle	2440	2.49
High	2480	2.40

7.7. POWER SPECTRAL DENSITY

LIMITS

FCC §15.247 (e)

IC RSS-247 (5.2) (2)

The power spectral density conducted from the transmitter to the antenna shall not be greater than 8 dBm in any 3 kHz band during any time interval of continuous transmission.

RESULTS

Channel	Frequency (MHz)	PSD (dBm)	Limit (dBm)	Margin (dB)
Low	2402	2.242	8	-5.76
Middle	2440	2.362	8	-5.64
High	2480	1.740	8	-6.26

POWER SPECTRAL DENSITY

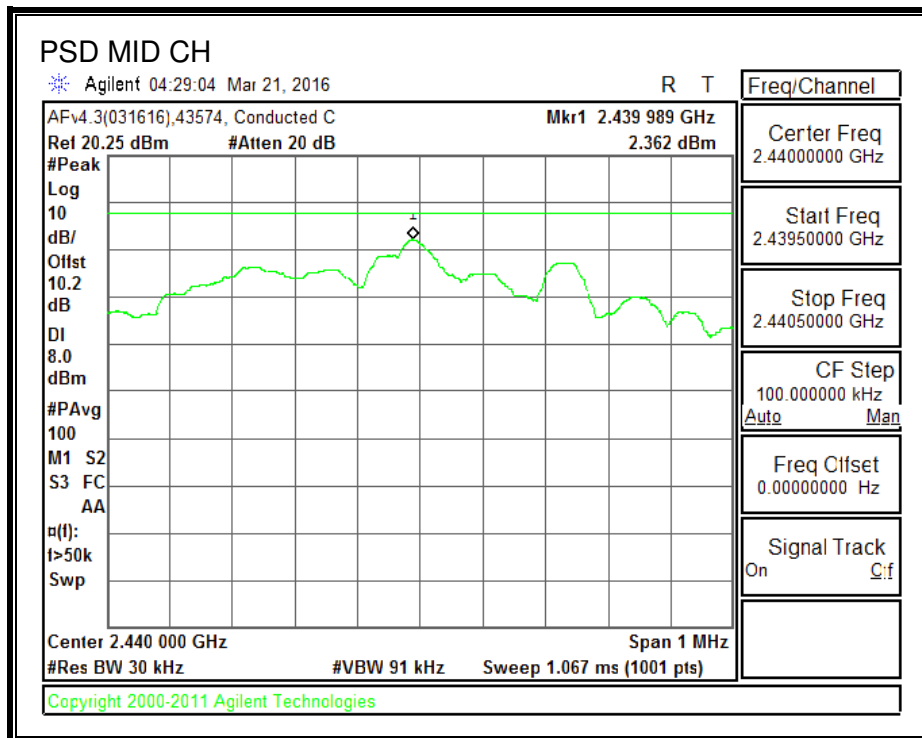
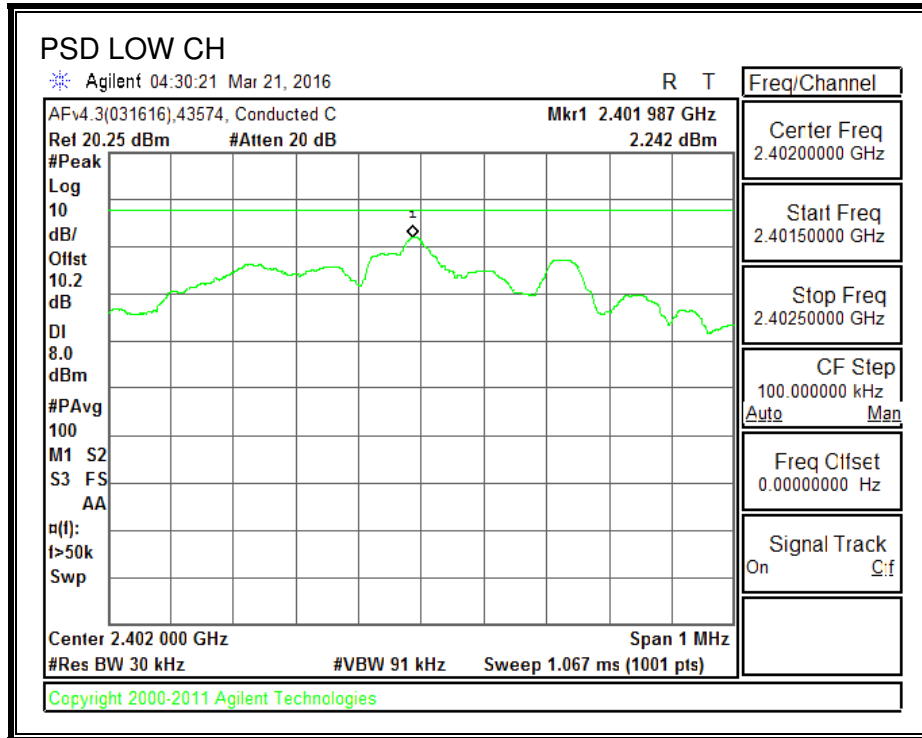

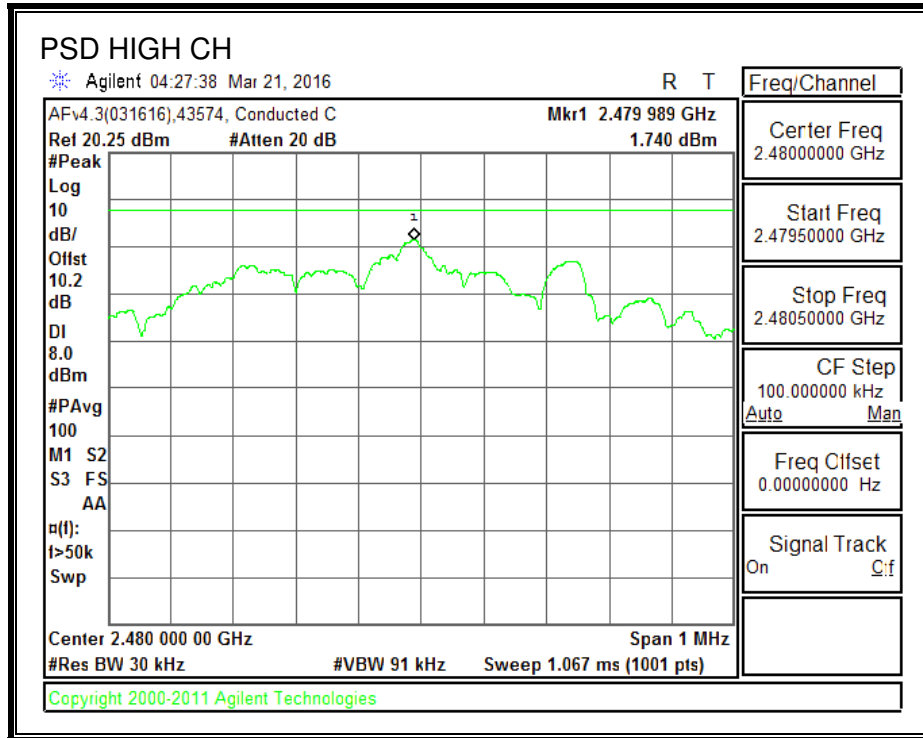

7.8. CONDUCTED SPURIOUS EMISSIONS

LIMITS

FCC §15.247 (d)

IC RSS-247 (5.5)

Output power was measured based on the use of a peak measurement, therefore the required attenuation is 20 dB.

RESULTS

SPURIOUS EMISSIONS, LOW CHANNEL

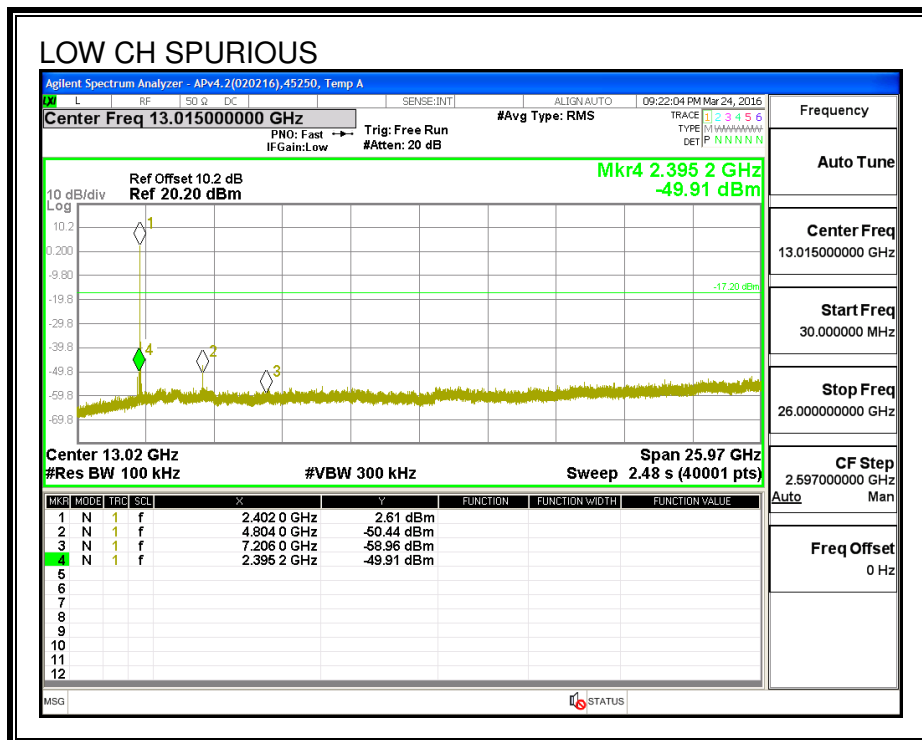
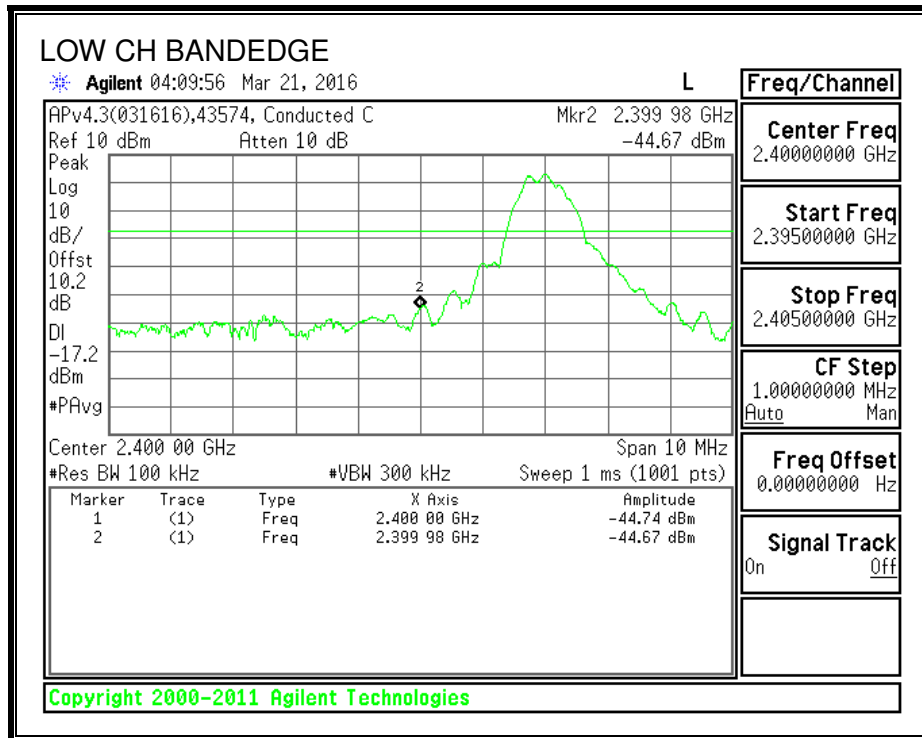

SPURIOUS EMISSIONS, MID CHANNEL

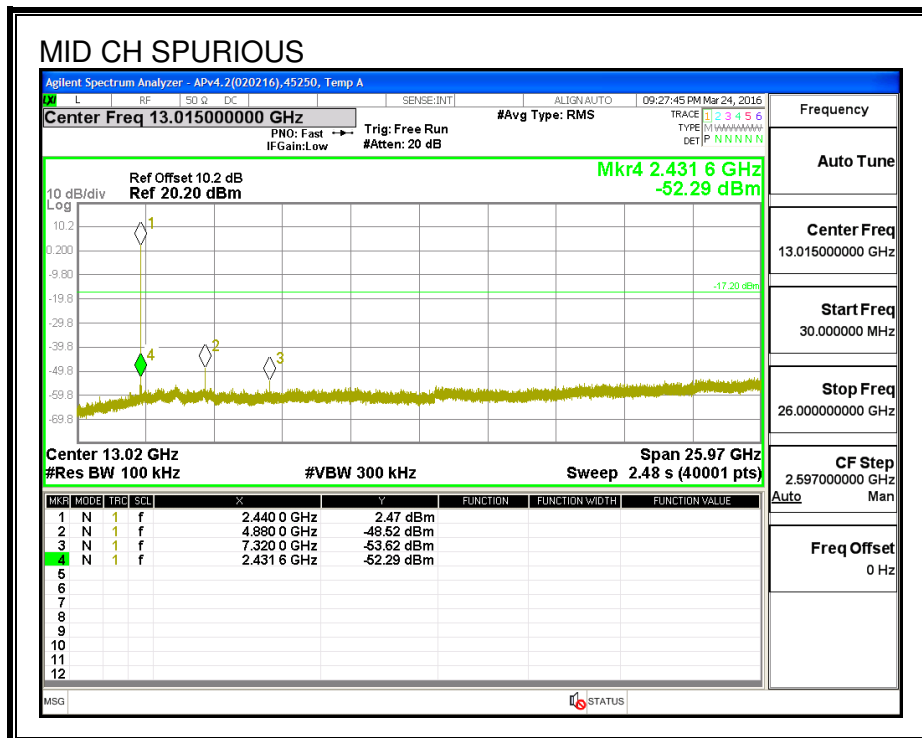
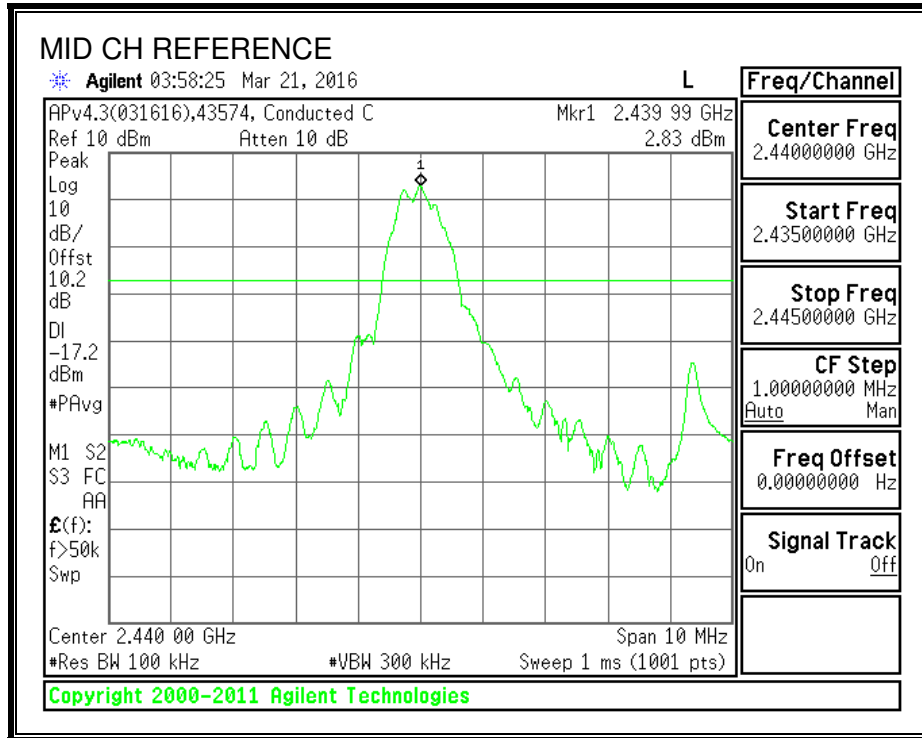

SPURIOUS EMISSIONS, HIGH CHANNEL

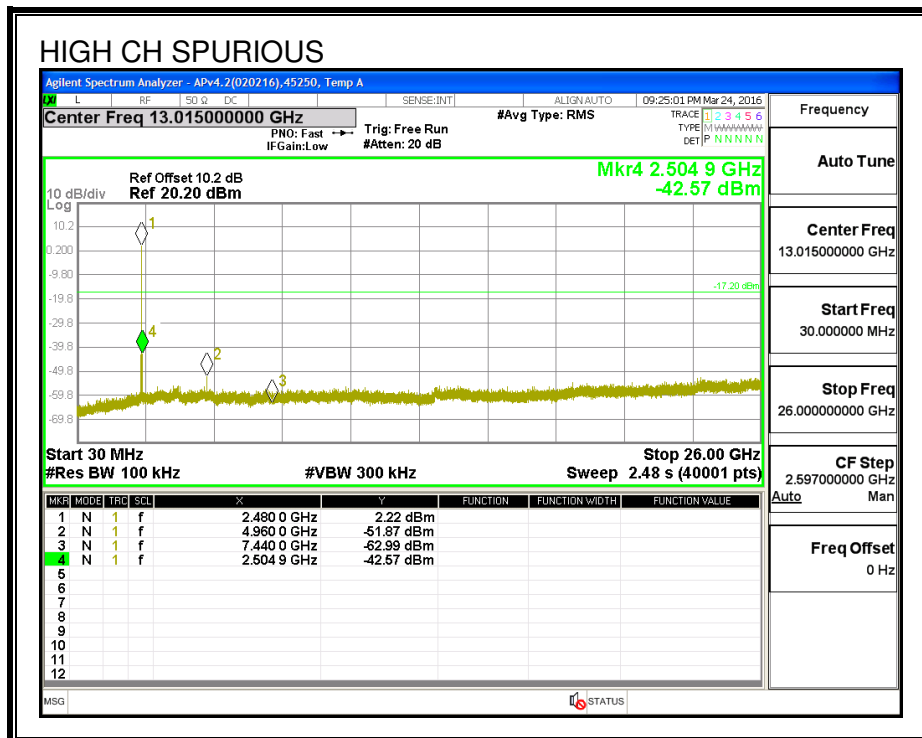
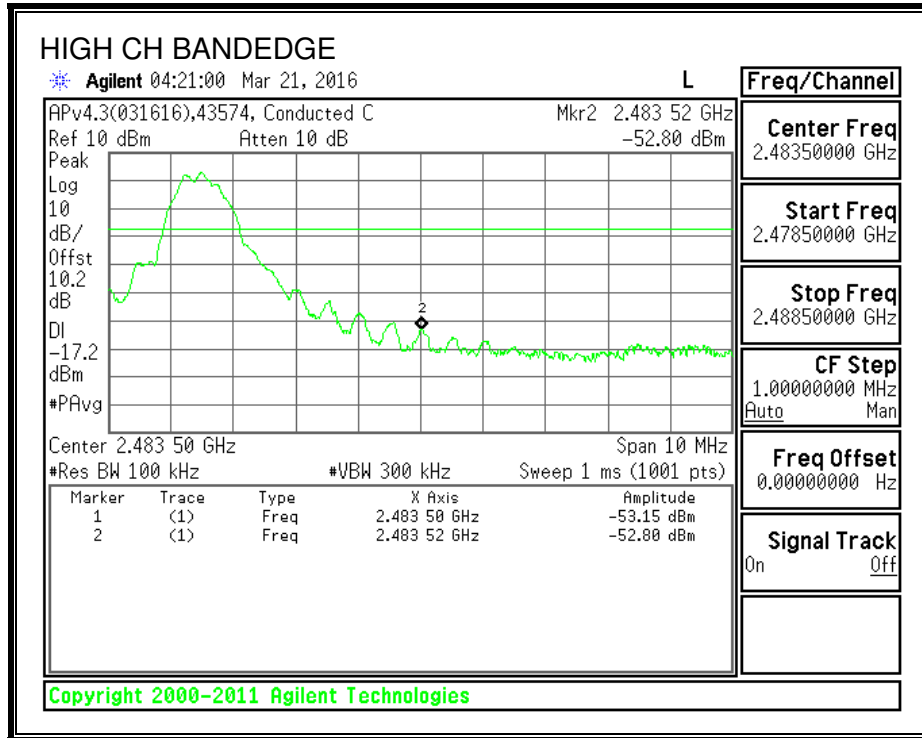

8. RADIATED TEST RESULTS

8.1. LIMITS AND PROCEDURE

LIMITS

FCC §15.205 and §15.209

IC RSS-GEN Clause 8.9 and 8.10

Frequency Range (MHz)	Field Strength Limit (uV/m) at 3 m	Field Strength Limit (dBuV/m) at 3 m
30 - 88	100	40
88 - 216	150	43.5
216 - 960	200	46
Above 960	500	54

8.2. TRANSMITTER ABOVE 1 GHz.

RESTRICTED BANDEDGE (LOW CHANNEL)

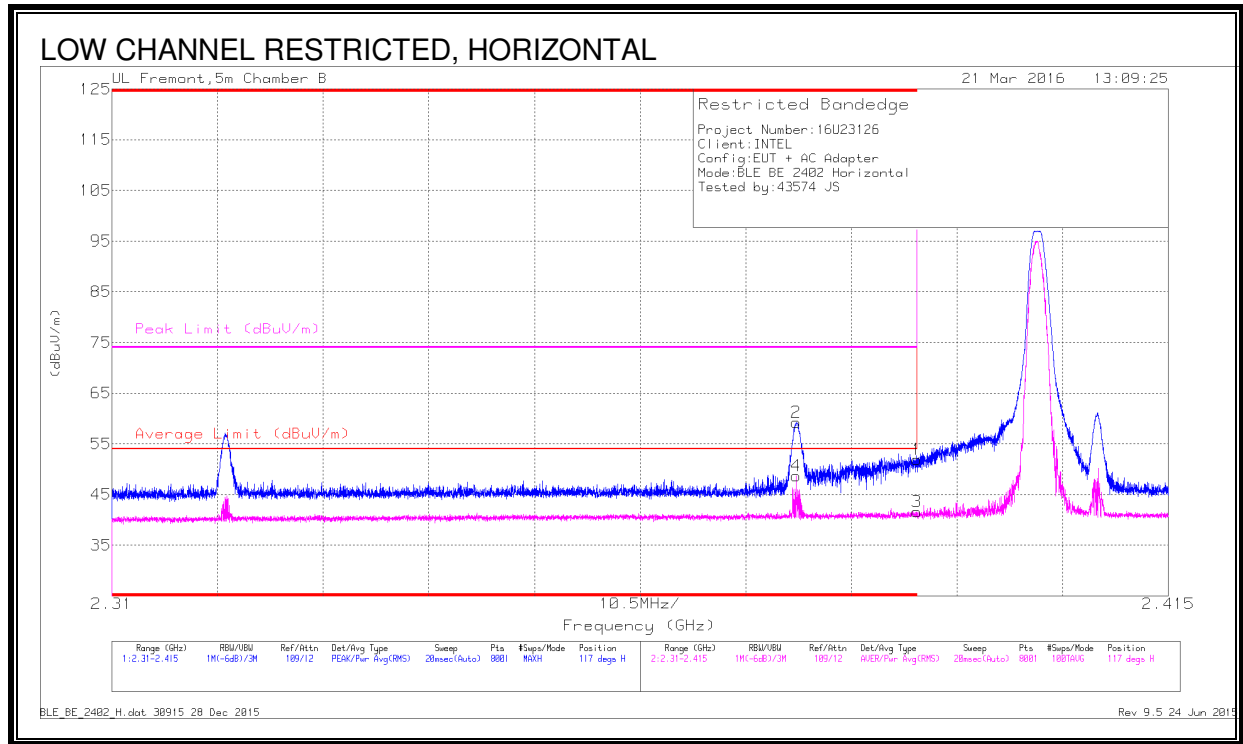

DATA

Trace Markers

Marker	Frequency (GHz)	Meter Reading (dBuV)	Det	AF T344 (dB/m)	Amp/Cb/Fit r/Pad (dB)	DC Corr (dB)	Corrected Reading (dBuV/m)	Average Limit (dBuV/m)	Margin (dB)	Peak Limit (dBuV/m)	PK Margin (dB)	Azimuth (Degs)	Height (cm)	Polarity
2	* 2.378	49.48	Pk	32.1	-22.3	0	59.28	-	-	74	-14.72	117	155	H
4	* 2.378	33.88	RMS	32.1	-22.3	5.63	49.31	54	-4.69	-	-	117	155	H
1	* 2.39	42.05	Pk	32.1	-22.3	0	51.85	-	-	74	-22.15	117	155	H
3	* 2.39	26.9	RMS	32.1	-22.3	5.63	42.33	54	-11.67	-	-	117	155	H

* - indicates frequency in CFR15.205/IC8.10 Restricted Band

Pk - Peak detector

RMS - RMS detection

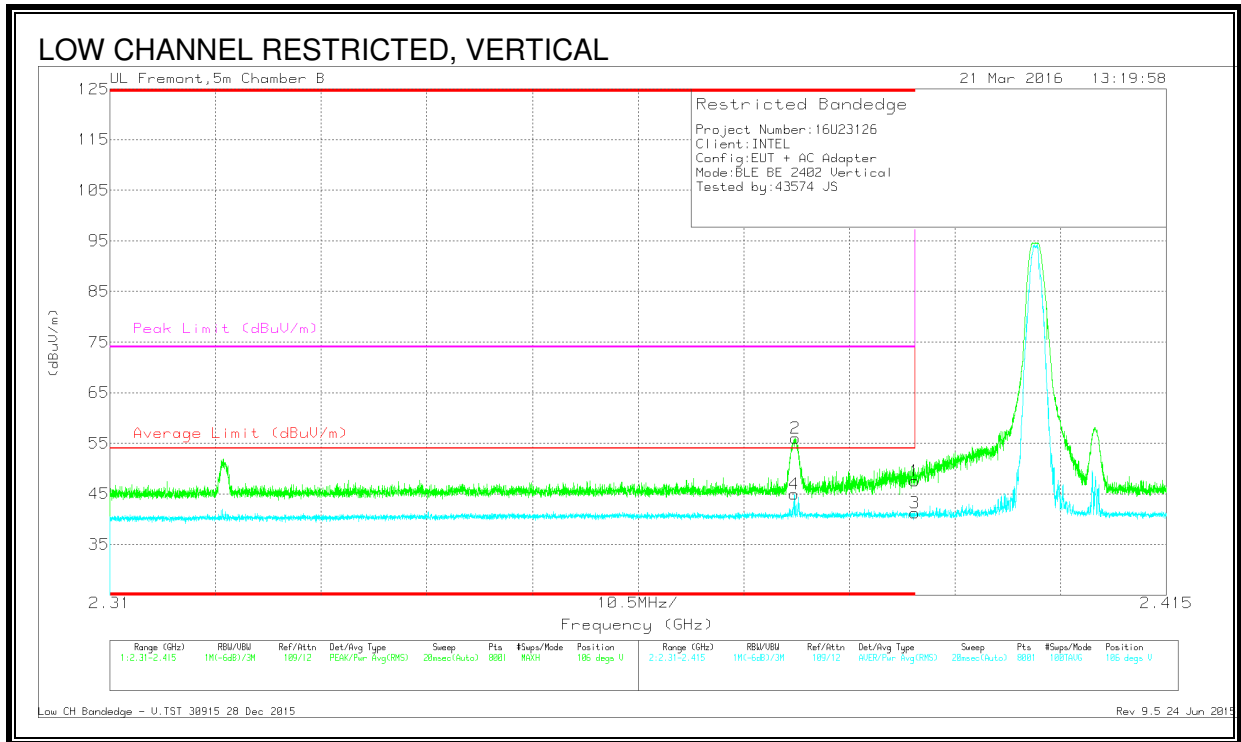

DATA

Trace Markers

Marker	Frequency (GHz)	Meter Reading (dBuV)	Det	AF T344 (dB/m)	Amp/Cbl/Fit r/Pad (dB)	DC Corr (dB)	Corrected Reading (dBuV/m)	Average Limit (dBuV/m)	Margin (dB)	Peak Limit (dBuV/m)	PK Margin (dB)	Azimuth (Degs)	Height (cm)	Polarity
2	* 2.378	46.17	Pk	32.1	-22.3	0	55.97	-	-	74	-18.03	106	149	V
4	* 2.378	30.22	RMS	32.1	-22.3	5.63	45.65	54	-8.35	-	-	106	149	V
1	* 2.39	37.77	Pk	32.1	-22.3	0	47.57	-	-	74	-26.43	106	149	V
3	* 2.39	26.45	RMS	32.1	-22.3	5.63	41.88	54	-12.12	-	-	106	149	V

* - indicates frequency in CFR15.205/IC8.10 Restricted Band

Pk - Peak detector

RMS - RMS detection

RESTRICTED BANDEGE (HIGH CHANNEL)

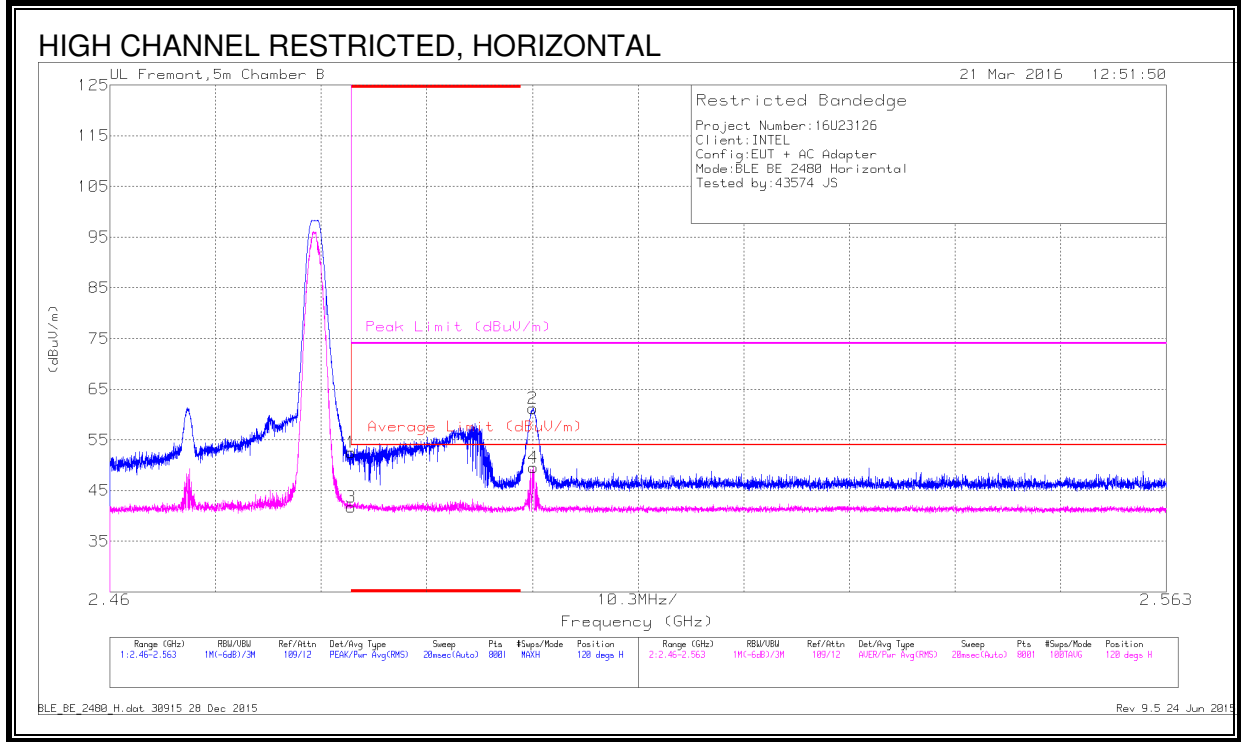

DATA

Trace Markers

Marker	Frequency (GHz)	Meter Reading (dBuV)	Det	AF T344 (dB/m)	Amp/Cb/Filter/Pad (dB)	DC Corr (dB)	Corrected Reading (dBuV/m)	Average Limit (dBuV/m)	Margin (dB)	Peak Limit (dBuV/m)	PK Margin (dB)	Azimuth (Degs)	Height (cm)	Polarity
1	* 2.484	42.49	Pk	32.3	-22.3	0	52.49	-	-	74	-21.51	120	160	H
3	* 2.484	26.78	RMS	32.3	-22.3	5.63	42.41	54	-11.59	-	-	120	160	H
2	2.501	51.09	Pk	32.3	-22.2	0	61.19	-	-	74	-12.81	120	160	H
4	2.501	34.54	RMS	32.3	-22.2	5.63	50.27	54	-3.73	-	-	120	160	H

* - indicates frequency in CFR15.205/IC8.10 Restricted Band

Pk - Peak detector

RMS - RMS detection

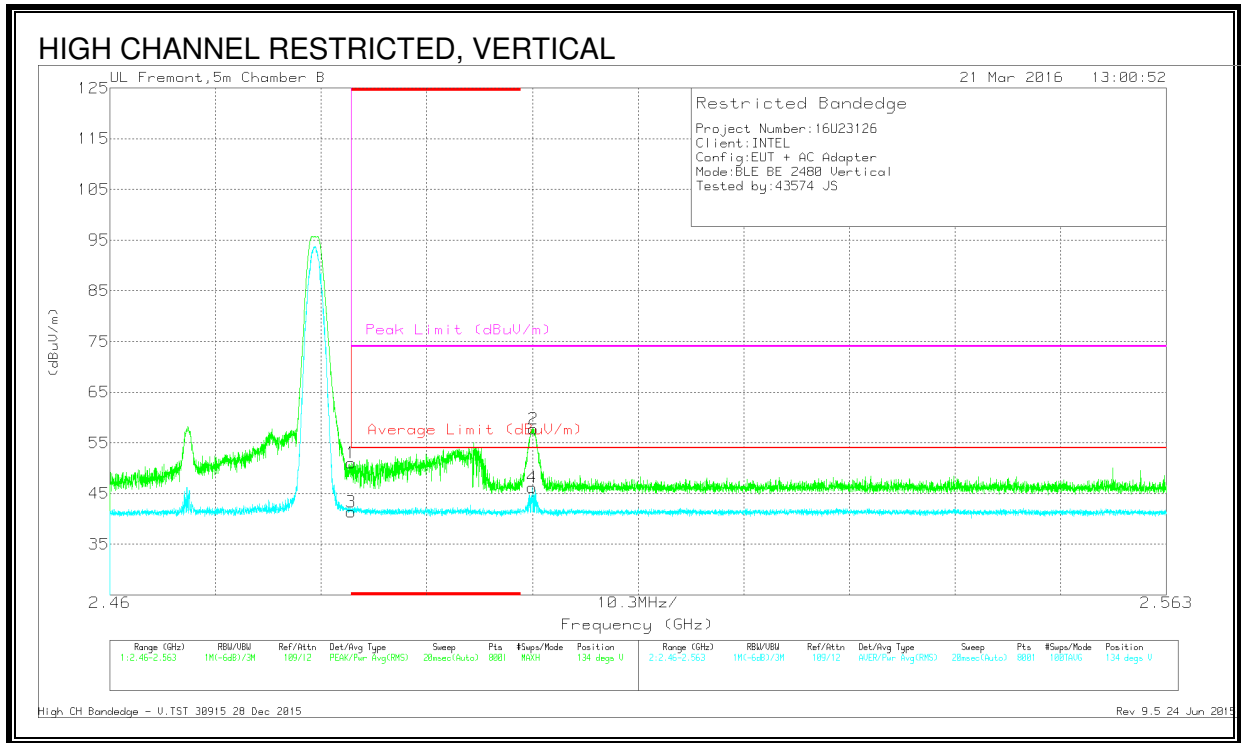

DATA

Trace Markers

Marker	Frequency (GHz)	Meter Reading (dBuV)	Det	AF T344 (dB/m)	Amp/Cb/Fit r/Pad (dB)	DC Corr (dB)	Corrected Reading (dBuV/m)	Average Limit (dBuV/m)	Margin (dB)	Peak Limit (dBuV/m)	PK Margin (dB)	Azimuth (Degs)	Height (cm)	Polarity
1	* 2.484	41.09	Pk	32.3	-22.3	0	51.09	-	-	74	-22.91	134	229	V
3	* 2.484	26.4	RMS	32.3	-22.3	5.63	42.03	54	-11.97	-	-	134	229	V
2	2.501	47.66	Pk	32.3	-22.2	0	57.76	-	-	74	-16.24	134	229	V
4	2.501	31.16	RMS	32.3	-22.2	5.63	46.89	54	-7.11	-	-	134	229	V

* - indicates frequency in CFR15.205/IC8.10 Restricted Band

Pk - Peak detector

RMS - RMS detection

HARMONICS AND SPURIOUS EMISSIONS

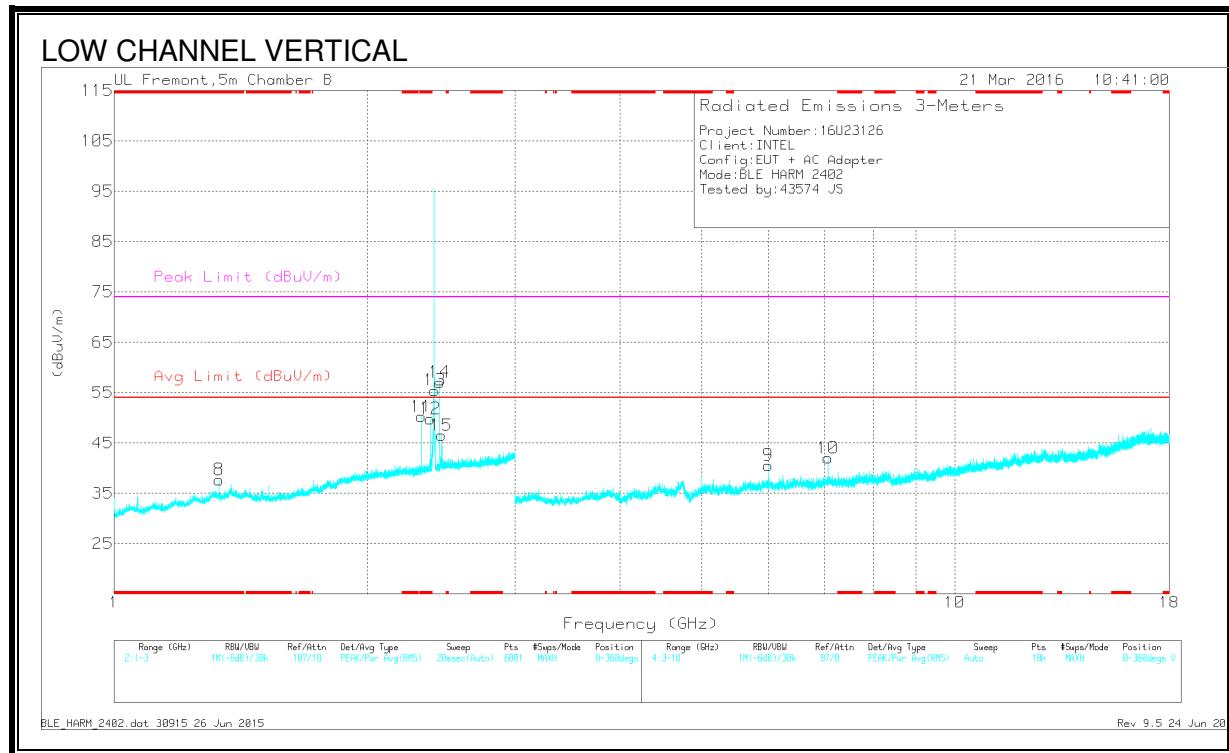
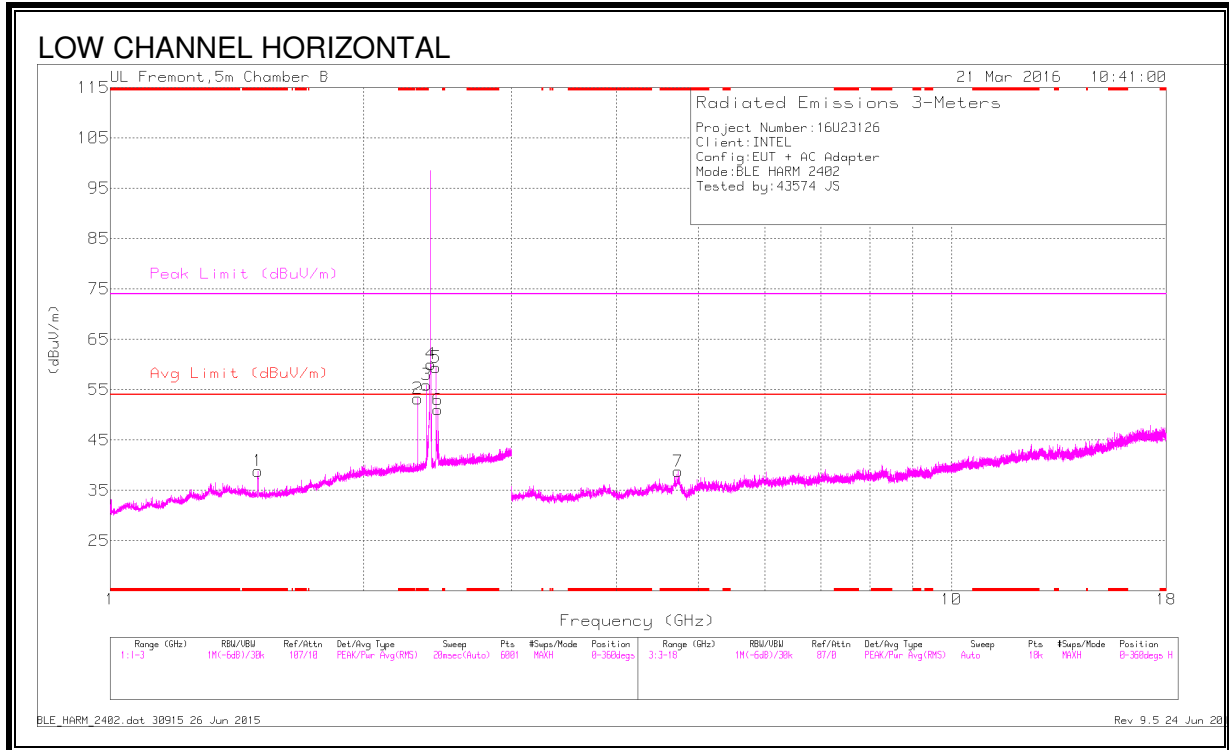

DATA

Radiated Emissions

Marker	Frequenc y (GHz)	Meter Reading (dBuV)	Det	AF T344 (dB/m)	Amp/Cbl/ Filtr/Pad (dB)	DC Corr (dB)	Corrected Reading (dBuV/m)	Avg Limit (dBuV/m)	Margin (dB)	Peak Limit (dBuV/m)	PK Margin (dB)	Azimuth (Degs)	Height (cm)	Polarity
1	* 1.5	30.68	PK2	28	-22.4	0	36.28	-	-	74	-37.72	106	102	H
	* 1.5	26.81	MAv1	28	-22.4	5.63	38.04	54	-15.96	-	-	106	102	H
2	* 2.321	33.84	PK2	31.8	-22.5	0	43.14	-	-	74	-30.86	119	142	H
	* 2.321	29.48	MAv1	31.8	-22.5	5.63	44.41	54	-9.59	-	-	119	142	H
3	* 2.378	33.9	PK2	32.1	-22.3	0	43.7	-	-	74	-30.3	119	164	H
	* 2.378	31.35	MAv1	32.1	-22.3	5.63	46.78	54	-7.22	-	-	119	164	H
11	* 2.321	40.87	PK2	31.8	-22.4	0	50.27	-	-	74	-23.73	115	101	V
	* 2.321	32.55	MAv1	31.8	-22.4	5.63	47.58	54	-6.42	-	-	115	101	H
8	* 1.334	29.19	PK2	29.1	-22.9	0	35.39	-	-	74	-38.61	123	200	V
	* 1.331	25.28	MAv1	29.1	-22.9	5.63	37.11	54	-16.89	-	-	123	200	V
7	* 4.735	34.99	PK2	34.1	-31	0	38.09	-	-	74	-35.91	123	102	H
	* 4.735	31.33	MAv1	34.1	-31	5.63	40.06	54	-13.94	-	-	123	102	H
4	2.408	50.27	PK2	32.2	-22.4	0	60.07	-	-	-	-	116	183	H
	2.408	50.06	MAv1	32.2	-22.4	5.63	65.49	-	-	-	-	116	183	H
5	2.439	49.53	PK2	32.2	-22.3	0	59.43	-	-	-	-	118	151	H
	2.439	35.19	MAv1	32.2	-22.3	5.63	50.62	-	-	-	-	118	151	H
6	2.454	33.46	PK2	32.3	-22.3	0	43.46	-	-	-	-	123	145	H
	2.454	27.47	MAv1	32.3	-22.3	5.63	43.1	-	-	-	-	123	145	H
9	6	33.8	PK2	35.4	-31.3	0	37.9	-	-	-	-	123	200	V
	6	30.3	MAv1	35.4	-31.3	5.63	40.03	-	-	-	-	123	200	V
10	7.07	36.75	PK2	35.6	-30	0	42.35	-	-	-	-	122	200	V
	7.07	30.27	MAv1	35.6	-30	5.63	41.5	-	-	-	-	122	200	V
12	* 2.377	40	PK2	32.1	-22.3	0	49.8	-	-	74	-24.2	110	151	V
	* 2.377	34.8	MAv1	32.1	-22.3	5.63	50.2	54	-3.8	-	-	110	151	V
13	2.407	45.66	PK2	32.2	-22.4	0	55.46	-	-	-	-	105	162	V
14	2.439	47.17	PK2	32.2	-22.3	0	57.07	-	-	-	-	125	175	V

* - indicates frequency in CFR15.205/IC7.2.2 Restricted Band

Av - Average detection

PK2 - KDB558074 Method: Maximum Peak

MAv1 - KDB558074 Option 1 Maximum RMS Average

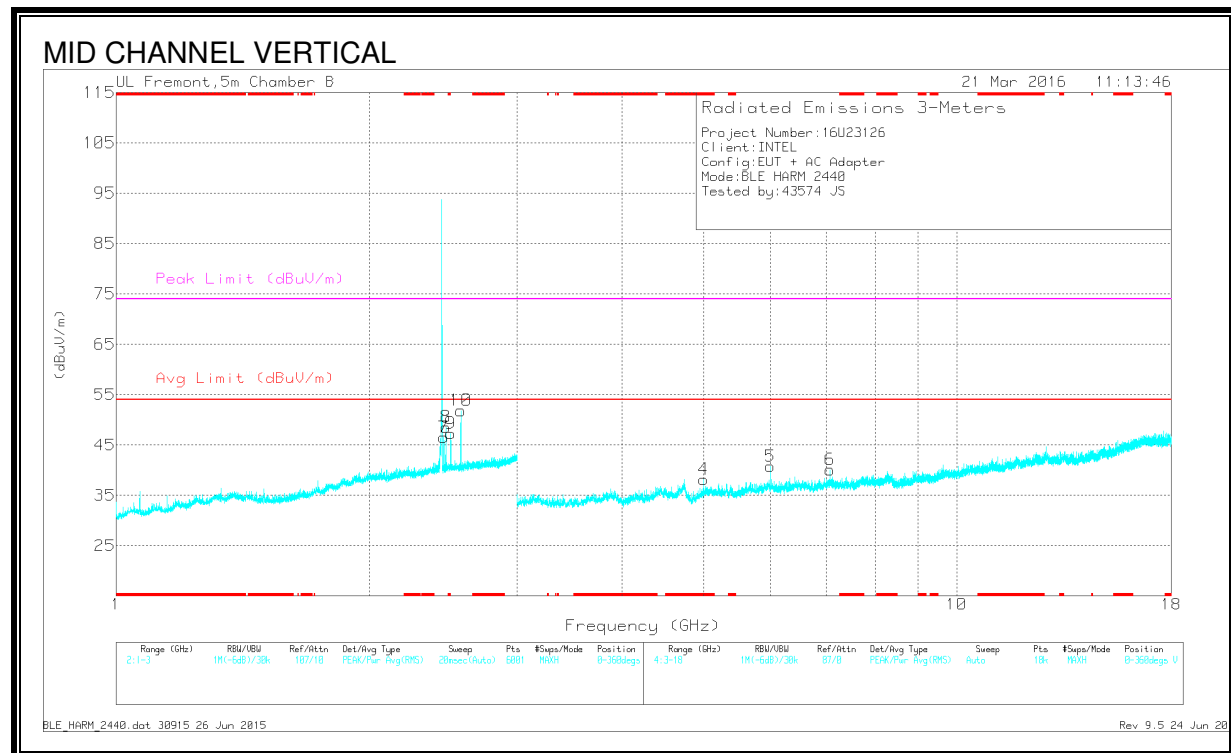
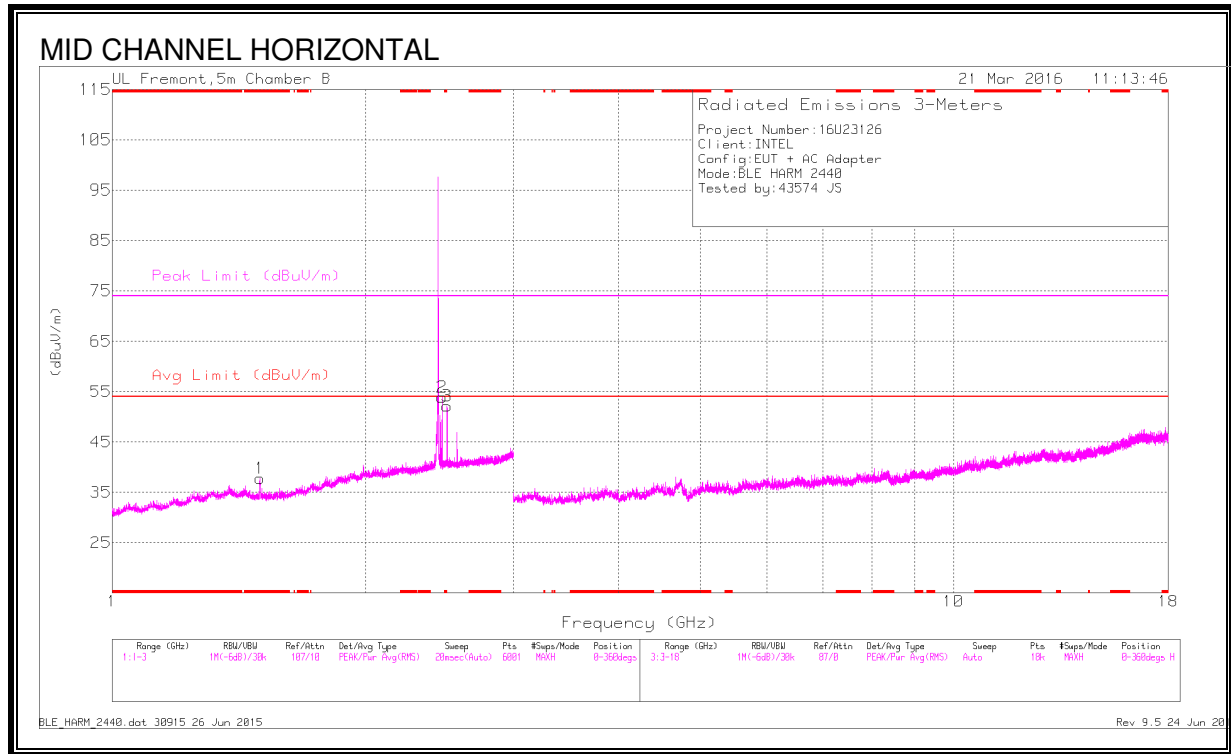

DATA

Radiated Emissions

Marker	Frequenc y (GHz)	Meter Reading (dBuV)	Det	AF T344 (dB/m)	Amp/Cbl/ Fitr/Pad (dB)	DC Corr (dB)	Corrected Reading (dBuV/m)	Avg Limit (dBuV/m)	Margin (dB)	Peak Limit (dBuV/m)	PK Margin (dB)	Azimuth (Degs)	Height (cm)	Polarity
1	* 1.498	38.41	PK2	28	-22.4	0	44.01	-	-	74	-29.99	101	102	H
	* 1.5	27.48	MAv1	28	-22.4	5.63	38.71	54	-15.29	-	-	101	102	H
7	* 2.454	34.99	PK2	34.1	-31	0	38.09	-	-	74	-35.91	123	102	H
	2.454	31.33	MAv1	34.1	-31	5.63	40.16	54	-13.84	-	-	123	102	H
4	* 5	34.54	PK2	34.2	-31.5	0	37.24	-	-	74	-36.76	122	200	V
	* 5	31.3	MAv1	34.2	-31.5	5.63	39.73	54	-14.27	-	-	122	200	V
2	2.468	50.73	PK2	32.3	-22.3	0	60.73	-	-	-	-	135	200	H
	2.468	30.97	MAv1	32.3	-22.3	5.63	46.6	-	-	-	-	135	200	H
8	2.469	33.68	PK2	32.3	-22.3	0	43.68	-	-	-	-	119	139	H
	2.469	32.92	MAv1	32.3	-22.3	5.63	48.55	-	-	-	-	119	139	H
3	2.501	42.03	PK2	32.3	-22.2	0	52.13	-	-	-	-	101	155	H
	2.501	29.63	MAv1	32.3	-22.2	5.63	45.36	-	-	-	-	101	155	H
9	2.501	37.19	PK2	32.3	-22.2	0	47.29	-	-	-	-	166	146	V
5	6	30.66	MAv1	35.5	-31.3	5.63	40.49	-	-	-	-	101	200	V
	6	33.8	PK2	35.5	-31.3	0	37.9	-	-	-	-	101	200	V
6	7.07	41.14	PK2	35.6	-30	0	46.74	-	-	-	-	101	102	V
	7.07	30.27	MAv1	35.6	-30	5.63	41.5	-	-	-	-	101	102	V
10	2.571	41.84	PK2	32.2	-22.2	0	51.84	-	-	-	-	145	200	V
	2.571	35.67	MAv1	32.2	-22.2	5.63	51.3	-	-	-	-	145	200	V

* - indicates frequency in CFR15.205/IC7.2.2 Restricted Band

PK2 - KDB558074 Method: Maximum Peak

MAv1 - KDB558074 Option 1 Maximum RMS Average

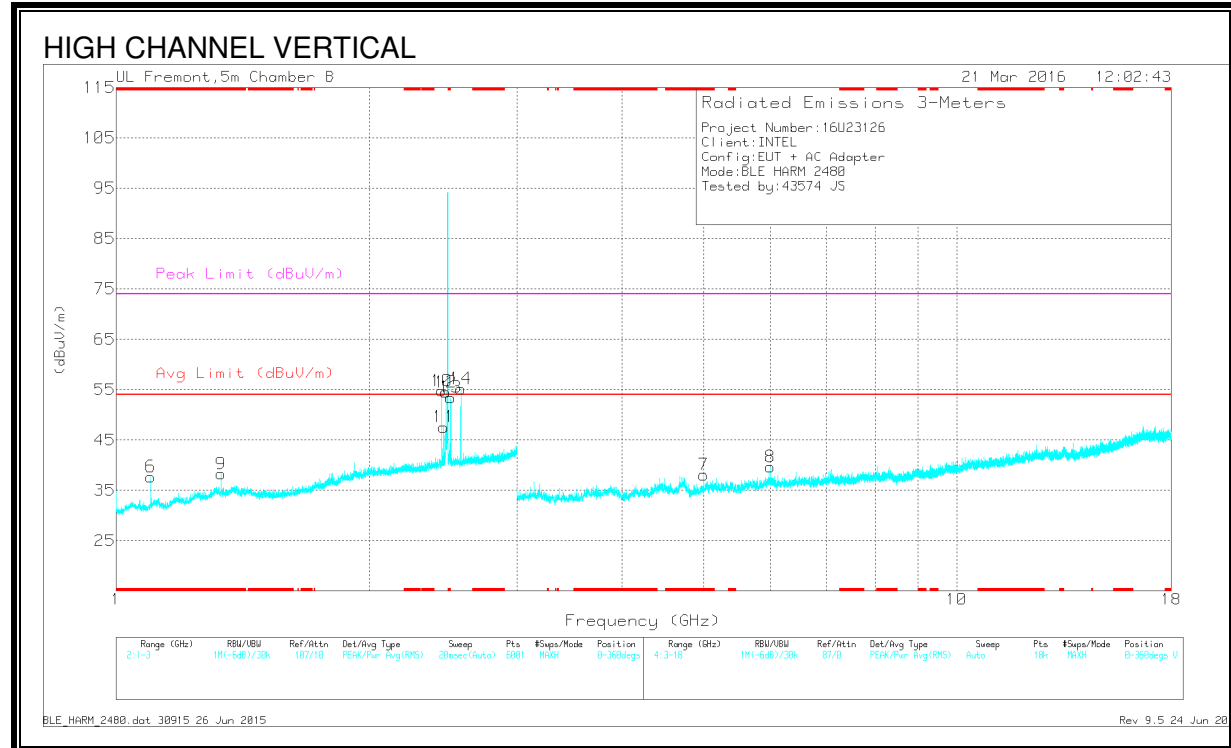
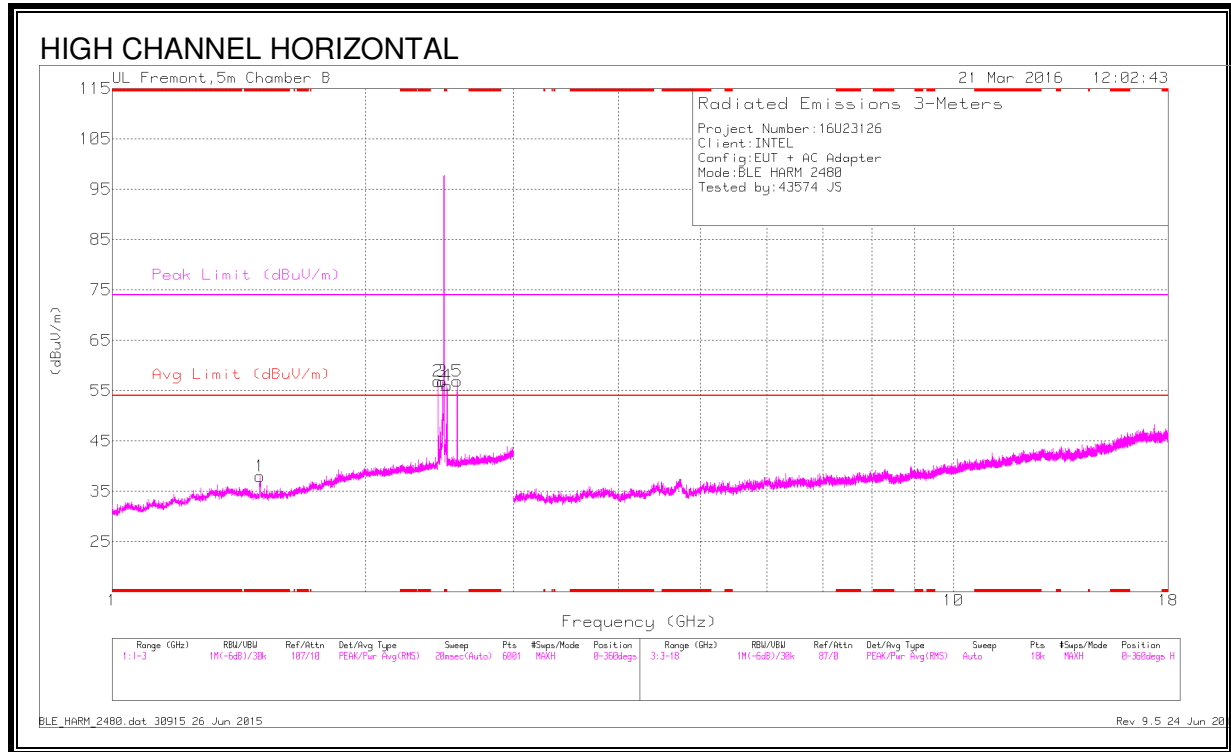

DATA

Radiated Emissions

Marker	Frequenc y (GHz)	Meter Reading (dBuV)	Det	AF T344 (dB/m)	Amp/Cbl/ Fitr/Pad (dB)	DC Corr (dB)	Corrected Reading (dBuV/m)	Avg Limit (dBuV/m)	Margin (dB)	Peak Limit (dBuV/m)	PK Margin (dB)	Azimuth (Degs)	Height (cm)	Polarity
1	* 1.499	38.7	PK2	28	-22.4	0	44.3	-	-	74	-29.7	1	101	H
	* 1.5	27.22	MAv1	28	-22.4	5.63	38.45	54	-15.55	-	-	1	101	H
6	* 1.101	29.36	PK2	28	-24.1	0	33.26	-	-	74	-40.74	121	200	V
	* 1.099	25.51	MAv1	28	-24.1	5.63	35.04	54	-18.96	-	-	121	200	V
10	2.439	44.98	Pk2	32.2	-22.4	0	54.78	-	-	-	-	125	101	V
	2.439	31.33	MAv1	32.2	-22.4	5.63	46.76	54	-7.24	-	-	123	101	H
7	* 5	34.25	PK2	34.2	-31.5	0	36.95	-	-	74	-37.05	121	200	V
	* 5	30.74	MAv1	34.2	-31.5	5.63	39.07	54	-14.93	-	-	121	200	V
2	2.439	33.98	PK2	32.2	-22.4	0	43.78	-	-	-	-	8	113	H
	2.439	33.71	MAv1	32.2	-22.4	5.63	49.14	-	-	-	-	8	113	H
3	2.468	46.79	Pk2	32.3	-22.3	0	56.79	-	-	-	-	120	136	H
	2.468	43.87	MAv1	32.3	-22.3	5.63	59.5	-	-	-	-	120	136	H
4	2.501	34.32	PK2	32.3	-22.2	0	44.42	-	-	-	-	120	113	H
	2.501	34.22	MAv1	32.3	-22.2	5.63	49.95	-	-	-	-	120	113	H
5	2.572	34.52	PK2	32.2	-22.2	0	44.52	-	-	-	-	121	131	H
	2.572	33.99	MAv1	32.2	-22.2	5.63	49.62	-	-	-	-	121	131	H
8	6	34.94	PK2	35.5	-31.3	0	39.14	-	-	-	-	121	102	V
	6	31.71	MAv1	35.5	-31.3	5.63	41.54	-	-	-	-	121	102	V
9	* 1.333	31.98	Pk2	29.1	-22.8	0	38.28	-	-	74	-35.72	120	200	V
	*1.333	26.6	MAv1	29.1	-22.8	5.63	38.53	54	-15.47	-	-	120	200	V
11	2.454	37.58	Pk2	32.3	-22.3	0	47.58	-	-	-	-	155	155	V
12	2.467	44.5	Pk2	32.3	-22.3	0	54.5	-	-	-	-	175	200	V
13	2.501	43.36	Pk2	32.3	-22.2	0	53.46	-	-	-	-	122	200	V
14	2.571	45.19	Pk2	32.2	-22.2	0	55.19	-	-	-	-	132	155	V

* - indicates frequency in CFR15.205/IC7.2.2 Restricted Band

Av - Average detection

PK2 - KDB558074 Method: Maximum Peak

MAv1 - KDB558074 Option 1 Maximum RMS Average

8.3. WORST-CASE BELOW 1 GHz

SPURIOUS EMISSIONS 30 TO 1000 MHz (WORST-CASE CONFIGURATION, HORIZONTAL)

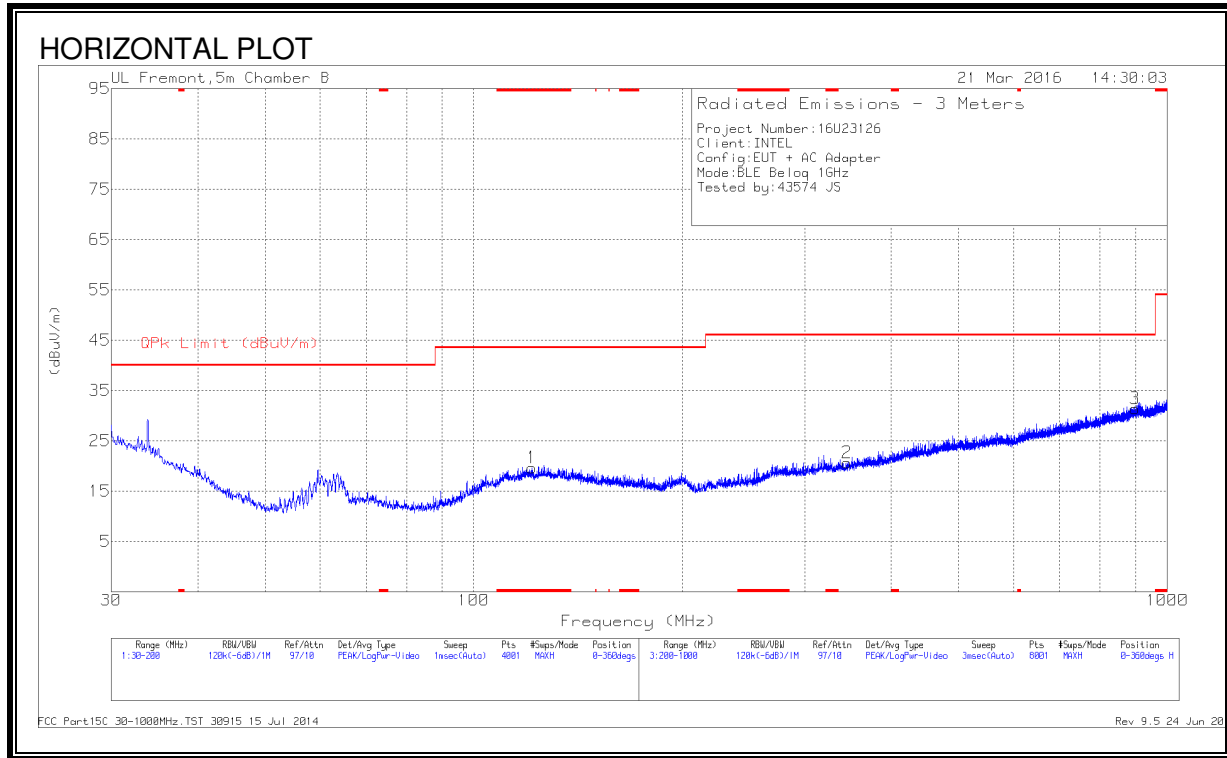

SPURIOUS EMISSIONS 30 TO 1000 MHz (WORST-CASE CONFIGURATION, VERTICAL)

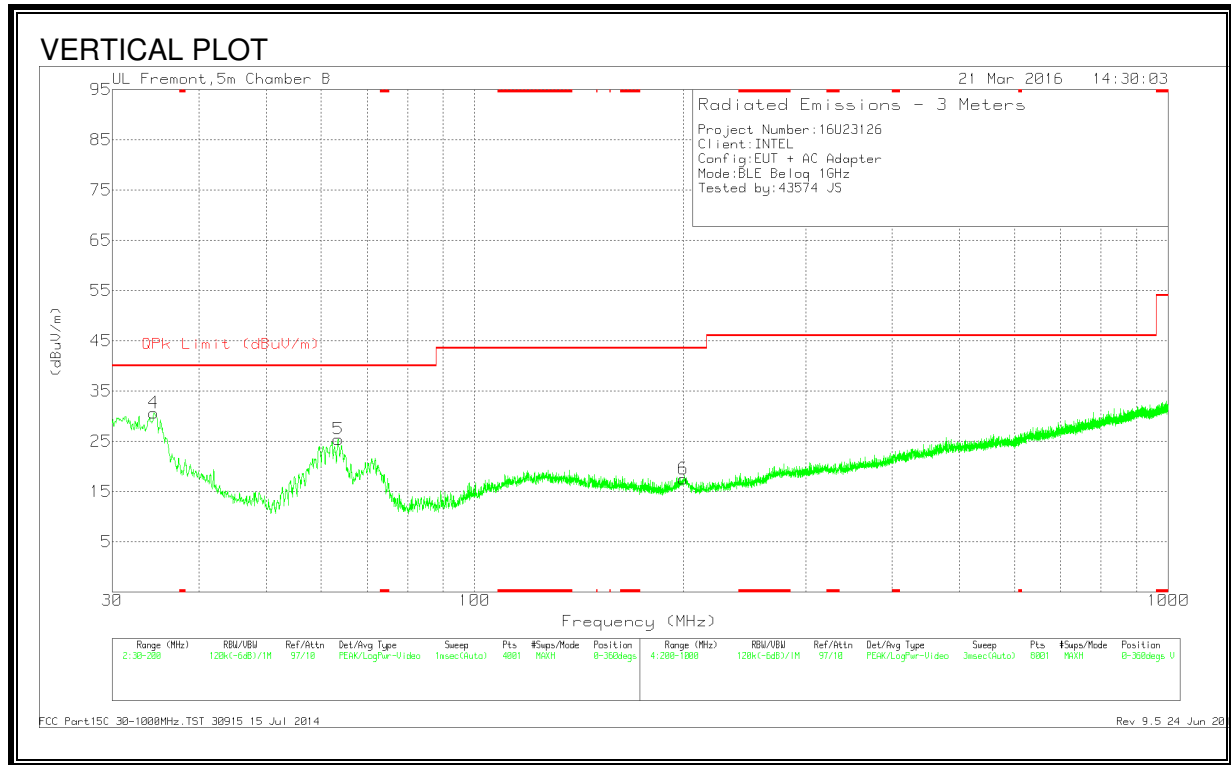

DATA

Trace Markers

Marker	Frequency (MHz)	Meter Reading (dBuV)	Det	AF T130 (dB/m)	Amp/C bl (dB)	DC Corr (dB)	Corrected Reading (dBuV/m)	QPk Limit (dBuV/m)	Margin (dB)	Azimuth (Degs)	Height (cm)	Polarity
1	* 121.2475	29.63	Pk	17.8	-27.8	0	19.63	43.52	-23.89	0-360	101	H
4	34.4625	37.44	Pk	22	-28.8	0	30.64	40	-9.36	0-360	101	V
5	63.575	42	Pk	11.9	-28.5	0	25.4	40	-14.6	0-360	101	V
6	199.915	28.11	Pk	16.5	-27.1	0	17.51	43.52	-26.01	0-360	101	V
2	345.2	28.63	PK	18.1	-26.1	0	20.63	46.02	-25.39	0-360	199	H
3	898.4	28.79	Pk	26.4	-23.8	0	31.39	46.02	-14.63	0-360	101	H

* - indicates frequency in CFR15.205/IC8.10 Restricted Band

Pk - Peak detector

8.4. TX SPURIOUS FROM 0.15 TO 30 MHz

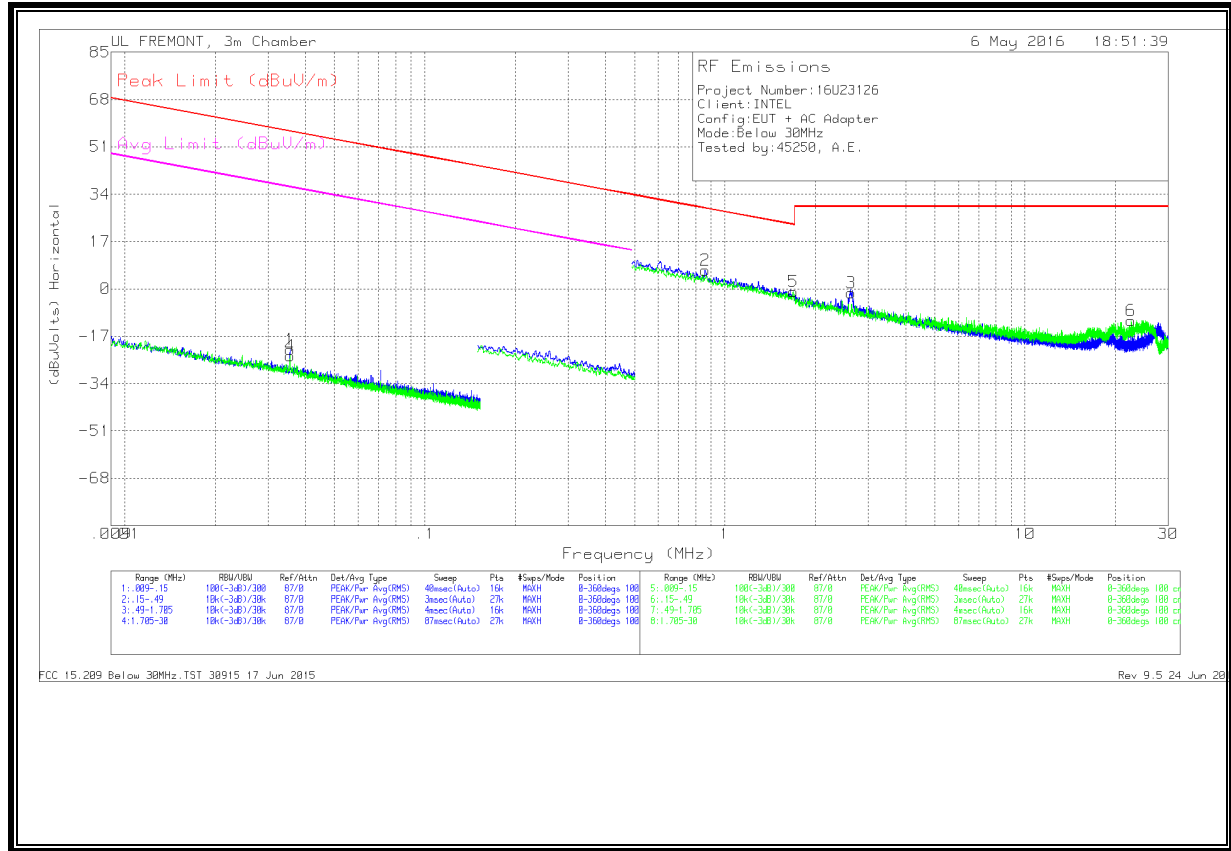

DATA

Marker	Frequency (MHz)	Meter Reading (dBuV)	Det	Loop Antenna (dB/m)	Cbl (dB)	Dist Corr 30m	Corrected Reading (dBuVolts)	Peak Limit (dBuV/m)	Margin (dB)	Avg Limit (dBuV/m)	Margin (dB)	Azimuth (Degs)
1	.03553	44.4	Pk	12.5	1.4	-80	-21.7	56.59	-78.29	36.59	-58.29	0-360
2	.85925	34.65	PK	10.6	1.5	-40	6.75	28.92	-22.17	-	-	0-360
3	2.63824	26.2	Pk	10.8	1.5	-40	-1.5	29.54	-31.04	-	-	0-360
4	.03554	42.12	Pk	12.5	1.4	-80	-23.98	56.59	-80.57	36.59	-60.57	0-360
5	1.68605	26.62	Pk	10.8	1.5	-40	-1.08	23.07	-24.15	-	-	0-360
6	22.60107	17.2	Pk	9.6	1.7	-40	-11.5	29.54	-41.04	-	-	0-360

Pk - Peak detector

FCC 15.209 Below 30MHz.TST 30915 17 Jun 2015

Rev 9.5 24 Jun 2015

8.5. AC POWER LINE CONDUCTED EMISSIONS

LIMITS

FCC §15.207 (a)

RSS-Gen 8.8

Frequency of Emission (MHz)	Conducted Limit (dB μ V)	
	Quasi-peak	Average
0.15-0.5	66 to 56 *	56 to 46 *
0.5-5	56	46
5-30	60	50

*Decreases with the logarithm of the frequency.

TEST PROCEDURE

The EUT is placed on a non-conducting table 40 cm from the vertical ground plane and 80 cm above the horizontal ground plane. The EUT is configured in accordance with ANSI C63.10-2013

The receiver is set to a resolution bandwidth of 9 kHz. Peak detection is used unless otherwise noted as quasi-peak or average.

Line conducted data is recorded for both NEUTRAL and HOT lines

8.5.1. EUT WITH USB POWER ADAPTER

LINE 1 RESULTS

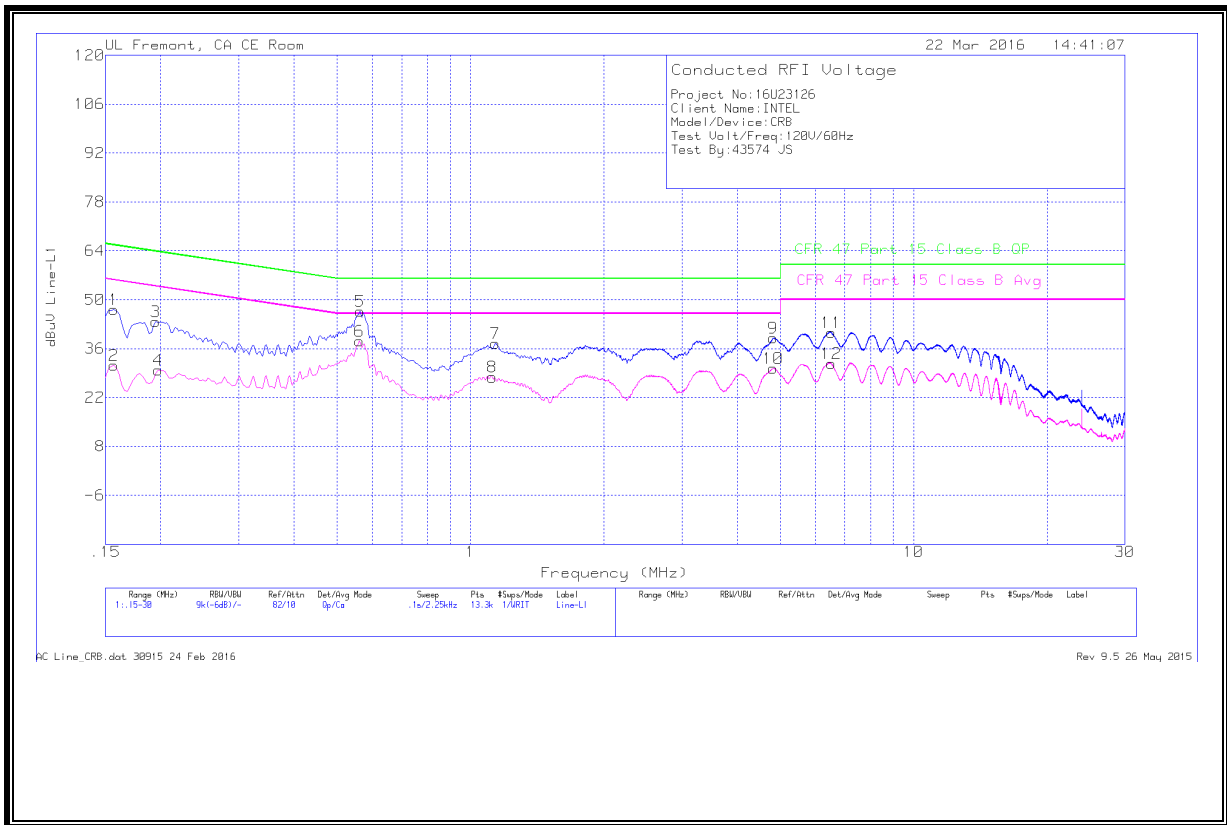

DATA

Line-L1 .15 - 30MHz

Marker	Frequency (MHz)	Meter Reading (dBuV)	Det	T24 IL L1	LC Cables 1&3	Limiter (dB)	Corrected Reading dBuV	CFR 47 Part 15 Class B QP	QP Margin (dB)	CFR 47 Part 15 Class B Avg	Av(CISPR) Margin (dB)
1	.15675	35.75	Qp	1.3	0	10.1	47.15	65.63	-18.48	-	-
2	.15675	19.77	Ca	1.3	0	10.1	31.17	-	-	55.63	-24.46
3	.195	32.63	Qp	1	0	10.1	43.73	63.82	-20.09	-	-
4	.19725	18.67	Ca	1	0	10.1	29.77	-	-	53.73	-23.96
5	.564	36.26	Qp	.3	0	10.1	46.66	56	-9.34	-	-
6	.56175	27.85	Ca	.3	0	10.1	38.25	-	-	46	-7.75
7	1.13775	27.12	Qp	.3	0	10.1	37.52	56	-18.48	-	-
8	1.11975	17.44	Ca	.3	0	10.1	27.84	-	-	46	-18.16
9	4.82325	28.61	Qp	.2	.1	10.1	39.01	56	-16.99	-	-
10	4.8165	19.98	Ca	.2	.1	10.1	30.38	-	-	46	-15.62
11	6.52088	30.16	Qp	.2	.1	10.2	40.66	60	-19.34	-	-
12	6.5175	21.31	Ca	.2	.1	10.2	31.81	-	-	50	-18.19

Qp - Quasi-Peak detector

Ca - CISPR average detection

LINE 2 RESULTS

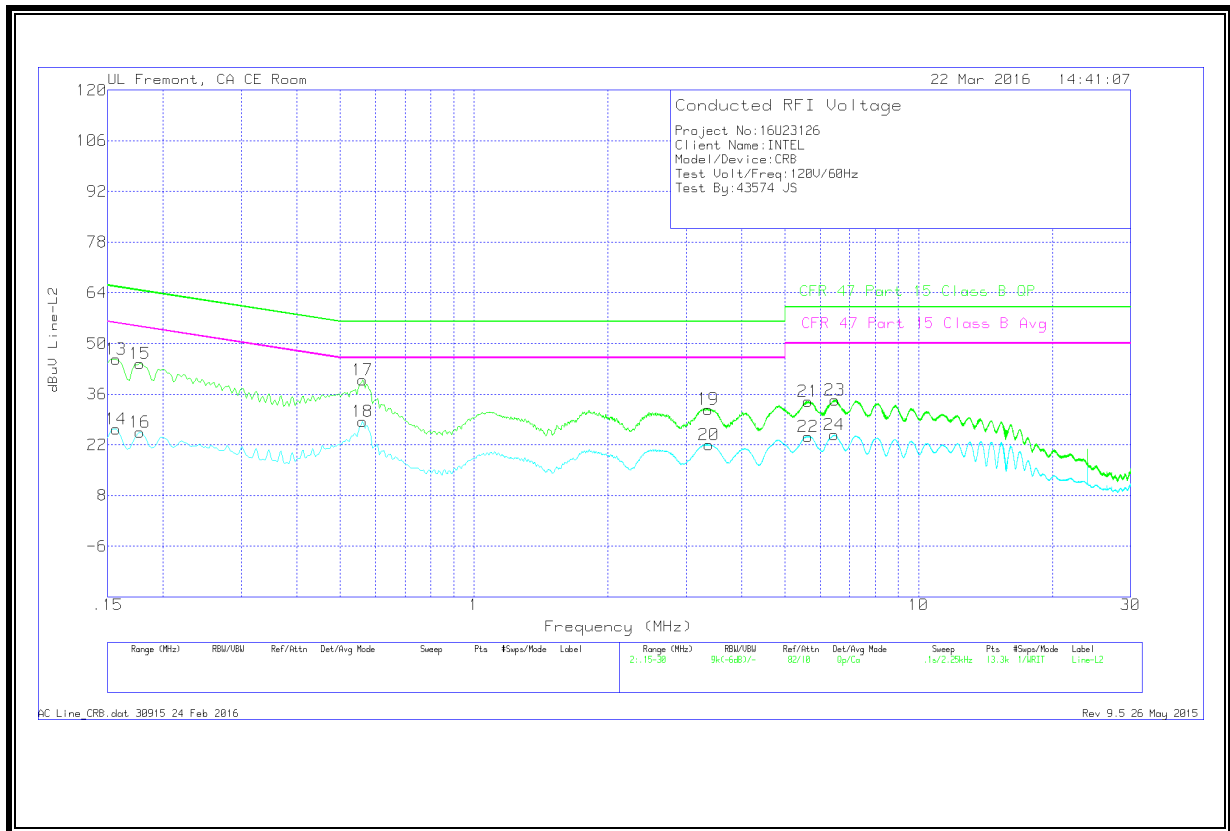

DATA

Line-L2 .15 - 30MHz

Marker	Frequency (MHz)	Meter Reading (dBuV)	Det	T24 IL L2	LC Cables 2&3	Limiter (dB)	Corrected Reading dBuV	CFR 47 Part 15 Class B QP	QP Margin (dB)	CFR 47 Part 15 Class B Avg	Av(CISPR) Margin (dB)
13	.15675	34.12	Qp	1.4	0	10.1	45.62	65.63	-20.01	-	-
14	.15675	14.91	Ca	1.4	0	10.1	26.41	-	-	55.63	-29.22
15	.177	33.19	Qp	1.2	0	10.1	44.49	64.63	-20.14	-	-
16	.177	14.18	Ca	1.2	0	10.1	25.48	-	-	54.63	-29.15
17	.56175	29.57	Qp	.3	0	10.1	39.97	56	-16.03	-	-
18	.56175	18.05	Ca	.3	0	10.1	28.45	-	-	46	-17.55
19	3.36188	21.43	Qp	.2	.1	10.1	31.83	56	-24.17	-	-
20	3.37425	11.68	Ca	.2	.1	10.1	22.08	-	-	46	-23.92
21	5.6445	23.59	Qp	.2	.1	10.1	33.99	60	-26.01	-	-
22	5.64225	13.92	Ca	.2	.1	10.1	24.32	-	-	50	-25.68
23	6.4725	23.91	Qp	.2	.1	10.2	34.41	60	-25.59	-	-
24	6.4635	14.26	Ca	.2	.1	10.2	24.76	-	-	50	-25.24

Qp - Quasi-Peak detector

Ca - CISPR average detection

8.5.2. EUT WITH LAPTOP

LINE 1 RESULTS

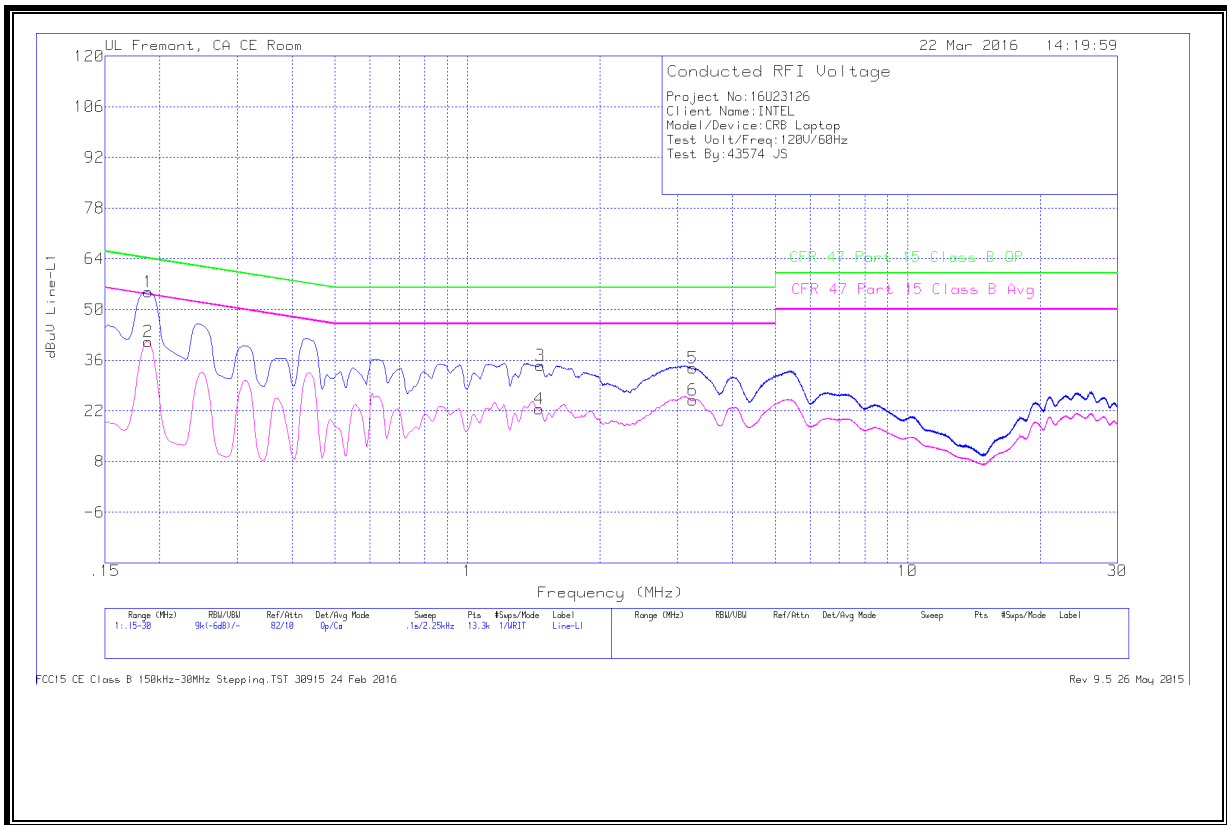

DATA

Line-L1 .15 - 30MHz

Marker	Frequency (MHz)	Meter Reading (dBuV)	Det	T24 IL L1	LC Cables 1&3	Limiter (dB)	Corrected Reading dBuV	CFR 47 Part 15 Class B QP	QP Margin (dB)	CFR 47 Part 15 Class B Avg	Av(CISPR) Margin (dB)
1	.18825	43.79	Qp	1	0	10.1	54.89	64.11	-9.22	-	-
2	.18825	30.09	Ca	1	0	10.1	41.19	-	-	54.11	-12.92
3	1.464	24.15	Qp	.2	.1	10.1	34.55	56	-21.45	-	-
4	1.45275	12.18	Ca	.2	.1	10.1	22.58	-	-	46	-23.42
5	3.255	23.36	Qp	.2	.1	10.1	33.76	56	-22.24	-	-
6	3.25275	14.59	Ca	.2	.1	10.1	24.99	-	-	46	-21.01

Qp - Quasi-Peak detector

Ca - CISPR average detection

LINE 2 RESULTS

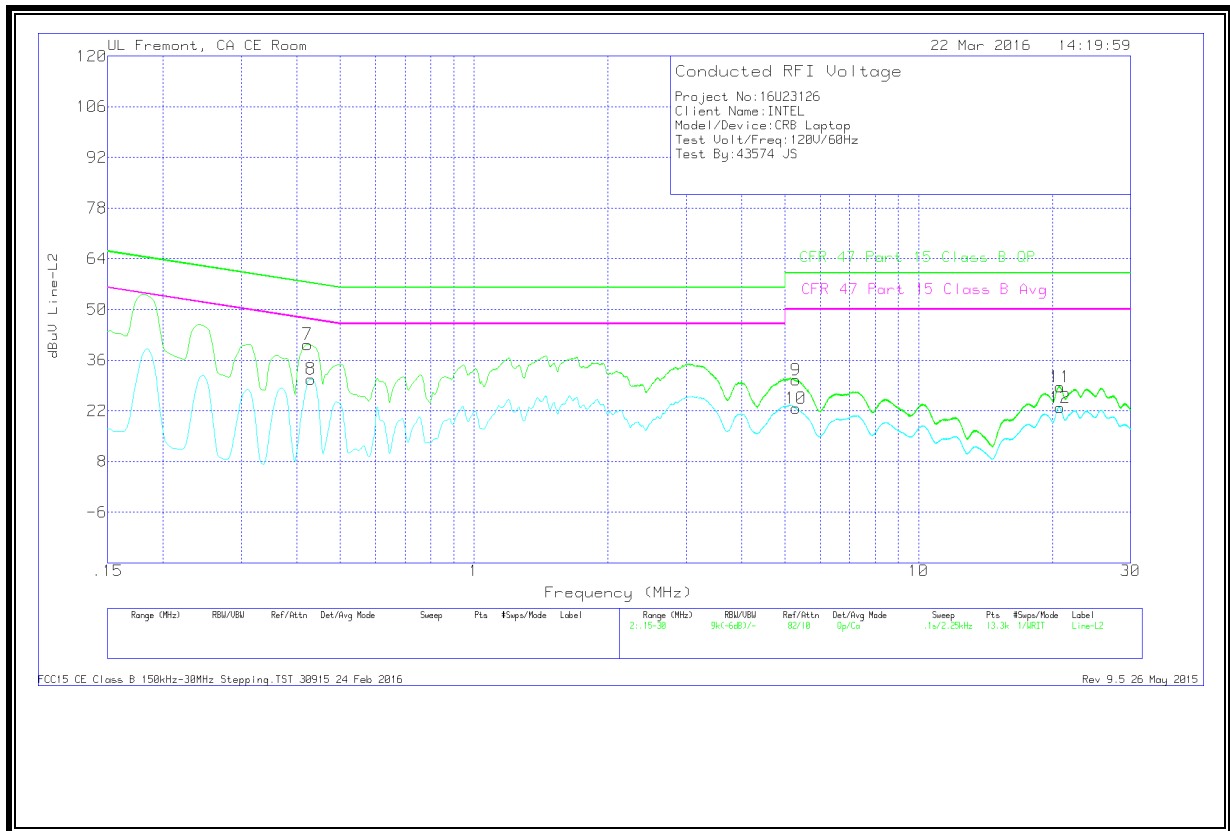

DATA

Line-L2 .15 - 30MHz

Marker	Frequency (MHz)	Meter Reading (dBuV)	Det	T24 IL L2	LC Cables 2&3	Limiter (dB)	Corrected Reading dBuV	CFR 47 Part 15 Class B QP	QP Margin (dB)	CFR 47 Part 15 Class B Avg	Av(CISPR) Margin (dB)
7	.42225	29.85	Qp	.4	0	10.1	40.35	57.4	-17.05	-	-
8	.429	20.29	Ca	.4	0	10.1	30.79	-	-	47.27	-16.48
9	5.29013	20.08	Qp	.2	.1	10.1	30.48	60	-29.52	-	-
10	5.3025	12.33	Ca	.2	.1	10.1	22.73	-	-	50	-27.27
11	20.79375	17.78	Qp	.3	.2	10.4	28.68	60	-31.32	-	-
12	20.79825	11.99	Ca	.3	.2	10.4	22.89	-	-	50	-27.11

Qp - Quasi-Peak detector

Ca - CISPR average detection