



FCC 47 CFR PART 15 SUBPART C

**BLUETOOTH LOW ENERGY
CERTIFICATION TEST REPORT**

FOR

BLE MODULE

MODEL NUMBER: Radon

FCC ID: 2AB8ZND16

REPORT NUMBER: 16U22697-E1V1

ISSUE DATE: JANUARY 27, 2016

Prepared for
**INTEL CORPORATION
2200 MISSION COLLEGE BOULEVARD,
SANTA CLARA, CA 95052, U.S.A**

Prepared by
**UL VERIFICATION SERVICES INC.
47173 BENICIA STREET
FREMONT, CA 94538, U.S.A.
TEL: (510) 771-1000
FAX: (510) 661-0888**



NVLAP LAB CODE 200065-0

Revision History

<u>Rev.</u>	<u>Issue Date</u>	<u>Revisions</u>	<u>Revised By</u>
V1	01/26/2016	Initial Issue	C. Pang

TABLE OF CONTENTS

1. ATTESTATION OF TEST RESULTS	4
2. TEST METHODOLOGY	5
3. FACILITIES AND ACCREDITATION	5
4. CALIBRATION AND UNCERTAINTY	6
4.1. <i>MEASURING INSTRUMENT CALIBRATION</i>	<i>6</i>
4.2. <i>SAMPLE CALCULATION</i>	<i>6</i>
4.3. <i>MEASUREMENT UNCERTAINTY.....</i>	<i>6</i>
5. EQUIPMENT UNDER TEST	7
5.1. <i>DESCRIPTION OF EUT</i>	<i>7</i>
5.2. <i>MAXIMUM OUTPUT POWER.....</i>	<i>7</i>
5.3. <i>DESCRIPTION OF AVAILABLE ANTENNAS</i>	<i>7</i>
5.4. <i>SOFTWARE AND FIRMWARE.....</i>	<i>7</i>
5.5. <i>WORST-CASE CONFIGURATION AND MODE.....</i>	<i>7</i>
5.6. <i>DESCRIPTION OF TEST SETUP.....</i>	<i>8</i>
6. TEST AND MEASUREMENT EQUIPMENT	12
7. ANTENNA PORT TEST RESULTS	13
7.1. <i>MEASUREMENT METHODS</i>	<i>13</i>
7.2. <i>ON TIME, DUTY CYCLE</i>	<i>14</i>
7.3. <i>6 dB BANDWIDTH.....</i>	<i>15</i>
7.4. <i>99% BANDWIDTH.....</i>	<i>18</i>
7.5. <i>OUTPUT POWER.....</i>	<i>21</i>
7.6. <i>AVERAGE POWER.....</i>	<i>24</i>
7.7. <i>POWER SPECTRAL DENSITY</i>	<i>25</i>
7.8. <i>CONDUCTED SPURIOUS EMISSIONS.....</i>	<i>28</i>
8. RADIATED TEST RESULTS.....	32
8.1. <i>LIMITS AND PROCEDURE</i>	<i>32</i>
8.2. <i>TRANSMITTER ABOVE 1 GHz.....</i>	<i>33</i>
8.3. <i>WORST-CASE BELOW 1 GHz.....</i>	<i>43</i>
8.1. <i>WORST-CASE 18 – 26 GHz.....</i>	<i>45</i>
9. AC POWER LINE CONDUCTED EMISSIONS.....	47
10. SETUP PHOTOS	52

1. ATTESTATION OF TEST RESULTS

COMPANY NAME: INTEL CORPORATION
2200 MISSION COLLEGE BOULEVARD
SANTA CLARA, CA 95052, U.S.A.

EUT DESCRIPTION: BLE MODULE

MODEL: Radon

SERIAL NUMBER: 984FEEOF67FF(CONDUCTED);984FEEOF6779(RADIATED)

DATE TESTED: JANUARY 21-25, 2016

APPLICABLE STANDARDS	
STANDARD	TEST RESULTS
CFR 47 Part 15 Subpart C	Pass

UL Verification Services Inc. tested the above equipment in accordance with the requirements set forth in the above standards. All indications of Pass/Fail in this report are opinions expressed by UL Verification Services Inc. based on interpretations and/or observations of test results. Measurement Uncertainties were not taken into account and are published for informational purposes only. The test results show that the equipment tested is capable of demonstrating compliance with the requirements as documented in this report.

Note: The results documented in this report apply only to the tested sample, under the conditions and modes of operation as described herein. This document may not be altered or revised in any way unless done so by UL Verification Services Inc. and all revisions are duly noted in the revisions section. Any alteration of this document not carried out by UL Verification Services Inc. will constitute fraud and shall nullify the document. This report must not be used by the client to claim product certification, approval, or endorsement by NVLAP, NIST, any agency of the Federal Government, or any agency of any government.

Approved & Released For
UL Verification Services Inc. By:

Tested By:

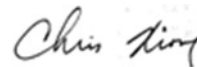

CHIN PANG
EMC SENIOR ENGINEER
UL VERIFICATION SERVICES INC.

CHRIS XIONG
EMC ENGINEER
UL VERIFICATION SERVICES INC.

2. TEST METHODOLOGY

The tests documented in this report were performed in accordance with FCC CFR 47 Part 2, FCC CFR 47 Part 15, ANSI C63.10-2013.

3. FACILITIES AND ACCREDITATION

The test sites and measurement facilities used to collect data are located at 47173 and 47266 Benicia Street, Fremont, California, USA. Line conducted emissions are measured only at the 47173 address. The following table identifies which facilities were utilized for radiated emission measurements documented in this report. Specific facilities are also identified in the test results sections.

47173 Benicia Street	47266 Benicia Street
<input type="checkbox"/> Chamber A	<input type="checkbox"/> Chamber D
<input type="checkbox"/> Chamber B	<input checked="" type="checkbox"/> Chamber E
<input type="checkbox"/> Chamber C	<input type="checkbox"/> Chamber F
	<input checked="" type="checkbox"/> Chamber G
	<input type="checkbox"/> Chamber H

The above test sites and facilities are covered under FCC Test Firm Registration # 208313. Chambers A through H are covered under Industry Canada company address code 2324B with site numbers 2324B -1 through 2324B-8, respectively.

UL Verification Services Inc. is accredited by NVLAP, Laboratory Code 200065-0. The full scope of accreditation can be viewed at <http://ts.nist.gov/standards/scopes/2000650.htm>.

4. CALIBRATION AND UNCERTAINTY

4.1. MEASURING INSTRUMENT CALIBRATION

The measuring equipment utilized to perform the tests documented in this report has been calibrated in accordance with the manufacturer's recommendations, and is traceable to recognized national standards.

4.2. SAMPLE CALCULATION

Where relevant, the following sample calculation is provided:

$$\begin{aligned} \text{Field Strength (dBuV/m)} &= \text{Measured Voltage (dBuV)} + \text{Antenna Factor (dB/m)} + \\ &\text{Cable Loss (dB)} - \text{Preamp Gain (dB)} \\ 36.5 \text{ dBuV} + 18.7 \text{ dB/m} + 0.6 \text{ dB} - 26.9 \text{ dB} &= 28.9 \text{ dBuV/m} \end{aligned}$$

4.3. MEASUREMENT UNCERTAINTY

Where relevant, the following measurement uncertainty levels have been estimated for tests performed on the apparatus:

PARAMETER	UNCERTAINTY
Conducted Disturbance, 0.15 to 30 MHz	± 3.52 dB
Radiated Disturbance, 30 to 1000 MHz	± 4.94 dB
Radiated Disturbance, 1 to 6 GHz	± 3.86 dB
Radiated Disturbance, 6 to 18 GHz	± 4.23 dB
Radiated Disturbance, 18 to 26 GHz	± 5.30 dB
Radiated Disturbance, 26 to 40 GHz	± 5.23 dB

Uncertainty figures are valid to a confidence level of 95%.

5. EQUIPMENT UNDER TEST

5.1. DESCRIPTION OF EUT

The EUT is a BLE module.

5.2. MAXIMUM OUTPUT POWER

The transmitter has a maximum peak conducted output power as follows:

Frequency Range (MHz)	Mode	Output Power (dBm)	Output Power (mW)
2402 - 2480	BLE	3.987	2.50

5.3. DESCRIPTION OF AVAILABLE ANTENNAS

The radio utilizes a chip antenna, with a maximum gain of 1.7 dBi.

5.4. SOFTWARE AND FIRMWARE

The firmware installed in the EUT during testing was MFG.

5.5. WORST-CASE CONFIGURATION AND MODE

Radiated emission and power line conducted emission were performed with the EUT set to transmit at the channel with highest output power as worst-case scenario.

The fundamental of the EUT was investigated in three orthogonal orientations X, Y and Z, it was determined that X orientation was worst-case orientation; therefore, all final radiated testing was performed with the EUT in X orientation.

Worst-case data rates as provided by the client were:

BLE: 1 Mbps.

5.6. DESCRIPTION OF TEST SETUP

SUPPORT EQUIPMENT

Support Equipment List				
Description	Manufacturer	Model	Serial Number	FCC ID
Laptop	Lenovo	Yoga 2 11	YB04499042	N/A
AC Adapter	Lenovo	ADLX45NCC3A	11S45N0297ZSH443G	N/A
Test Board	Zitrades	CP2102	X0000IXYXP3	N/A

I/O CABLES

I/O Cable List						
Cable No	Port	# of identical ports	Connector Type	Cable Type	Cable Length (m)	Remarks
1	AC	1	3-Prong	Un-Shielded	1.8	N/A
2	DC	1	DC	Un-Shielded	1	N/A
3	USB	1	USB	Un-Shielded	0.2	Laptop to EUT
4	TX/RX/GND Pins	1	TX/RX/GND Pins	Un-Shielded	0.1	Test board to EUT
5	Antenna	1	SMA	Un-Shielded	0.025	To Spectrum Analyzer
6	USB	1	USB	Shielded	1.8	Laptop to EUT

TEST SETUP

Test software exercised the radio card.

SETUP DIAGRAM FOR CONDUCTED TESTS

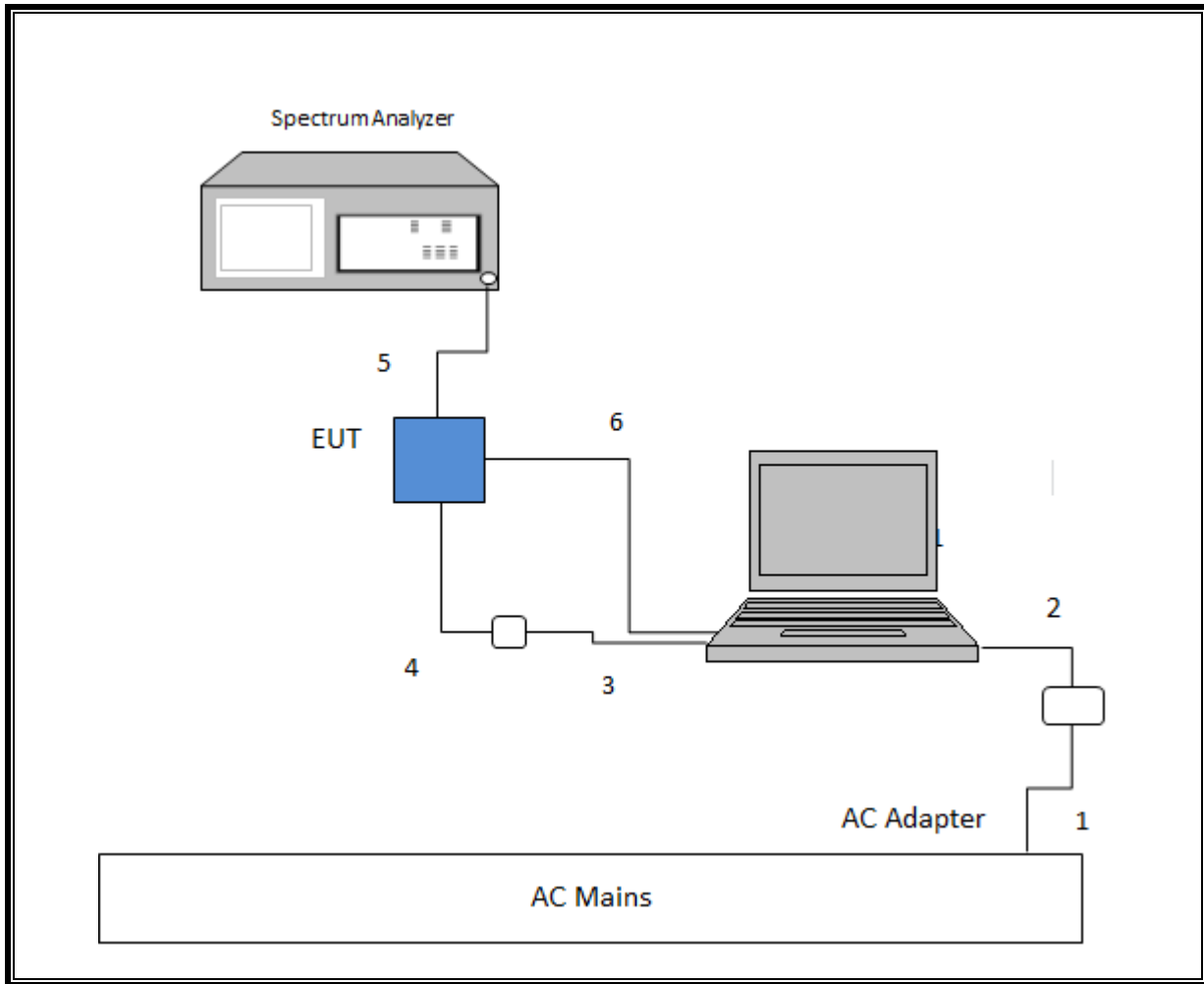

SETUP DIAGRAM FOR RADIATED TESTS

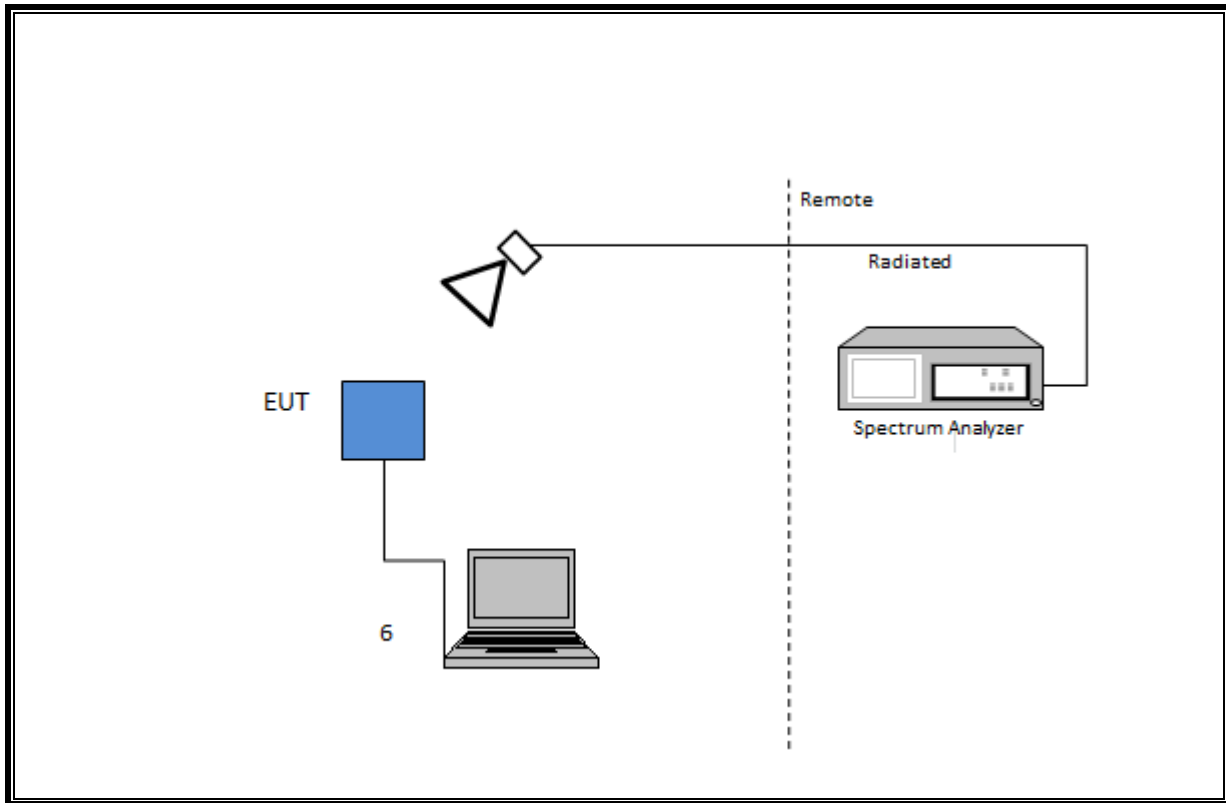

SETUP DIAGRAM FOR LINE CONDUCTED TEST

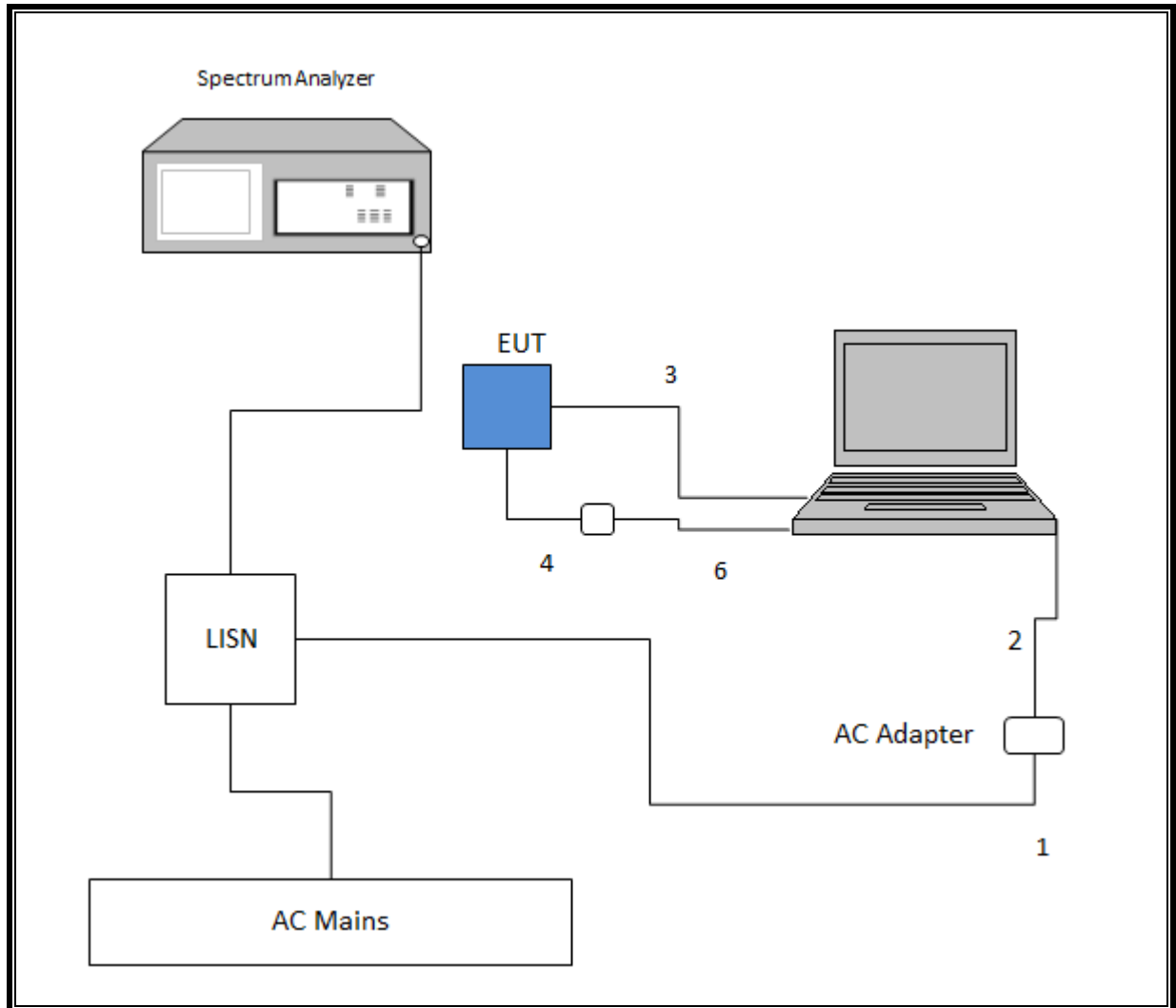

6. TEST AND MEASUREMENT EQUIPMENT

The following test and measurement equipment was utilized for the tests documented in this report:

Test Equipment List					
Description	Manufacturer	Model	ID No.	Cal Date	Cal Due
Radiated Software	UL	UL EMC	Ver 9.5		
Conducted Software	UL	UL EMC	Ver 4.1		
Spectrum Analyzer, PXA, 3Hz to 44GHz	Keysight	N9030A	905	6/16/2015	5/26/2016
Antenna, Horn 1-18GHz	ETS Lindgren	3117	862	4/10/2015	4/10/2016
Antenna, Broadband Hybrid, 30 to 2000MHz	Sunol Sciences	JB1	243	9/25/2015	9/25/2016
Amplifier, 1-18GHz	Miteq	AFS42-00101800-25-S-42	491	4/25/2015	4/25/2016
Amplifier, 10kHz to 1GHz	Sonoma	310N	285	6/8/2015	6/8/2016
Power Meter	Keysight	N1911A	1244	7/2/2015	7/2/2016
Power Sensor	Keysight	N1921A	1226	7/6/2015	7/6/2016
Amplifier, 1-26.5GHz	Keysight	8449B	404	6/29/2015	6/29/2016
Antenna, Horn 18 - 26GHz	ARA	MWH-1826	447	5/12/2015	5/12/2016
Spectrum Analyzer, 40GHz	Keysight	8564E	106	8/14/2015	8/14/2016
Filter, HPF 3.0GHz	Micro-Tronics	HPM17543	898	4/25/2015	4/25/2016
Spectrum Analyzer, PXA, 3Hz to 44GHz	Keysight	N9030A	126762	12/8/2015	12/8/2016
Spectrum Analyzer, PXA, 3Hz to 44GHz	Keysight	N9030A	126763	12/9/2015	12/9/2016
Spectrum Analyzer, PXA, 3Hz to 44GHz	Keysight	N9030A	917	6/2/2015	3/31/2016

7. ANTENNA PORT TEST RESULTS

7.1. MEASUREMENT METHODS

6 dB BW: KDB 558074 D01 v03r04, Section 8.1.

Output Power: KDB 558074 D01 v03r04, Section 9.1.2.

Power Spectral Density: KDB 558074 D01 v03r04, Section 10.2.

Out-of-band emissions in non-restricted bands: KDB 558074 D01 v03r04, Section 11.0.

Out-of-band emissions in restricted bands: KDB 558074 D01 v03r04, Section 12.1.

Band-edge: KDB 558074 D01 v03r04, Section 12.1

7.2. ON TIME, DUTY CYCLE

None; for reporting purposes only.

PROCEDURE

KDB 558074 Zero-Span Spectrum Analyzer Method.

ON TIME AND DUTY CYCLE RESULTS

Mode	ON Time B (msec)	Period (msec)	Duty Cycle x (linear)	Duty Cycle (%)	Duty Cycle Correction Factor (dB)	1/B Minimum VBW (kHz)
BLE	0.172	0.625	0.275	27.51%	5.61	5.814

DUTY CYCLE PLOTS

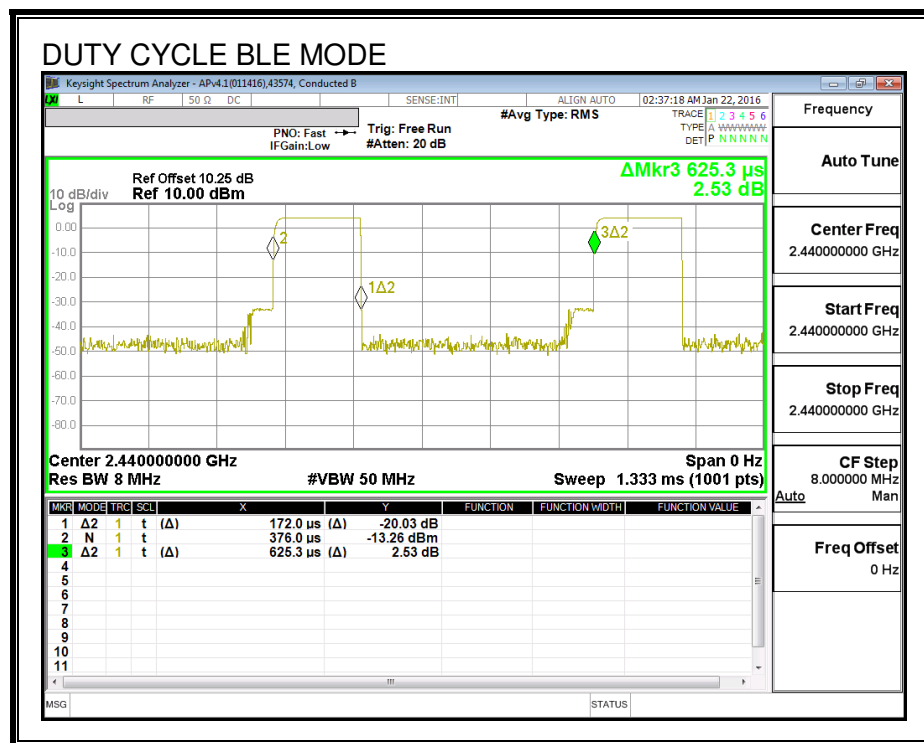

7.3. 6 dB BANDWIDTH

LIMITS

FCC §15.247 (a) (2)

The minimum 6 dB bandwidth shall be at least 500 kHz.

RESULTS

Channel	Frequency (MHz)	6 dB Bandwidth (MHz)	Minimum Limit (MHz)
Low	2402	0.568	0.5
Middle	2440	0.588	0.5
High	2480	0.632	0.5

6 dB BANDWIDTH

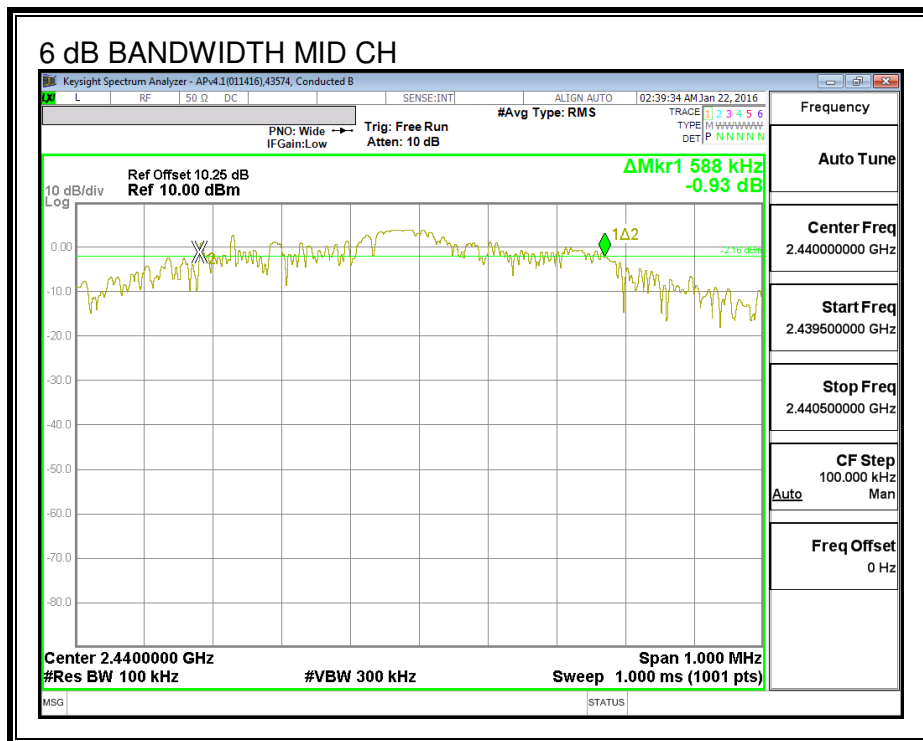
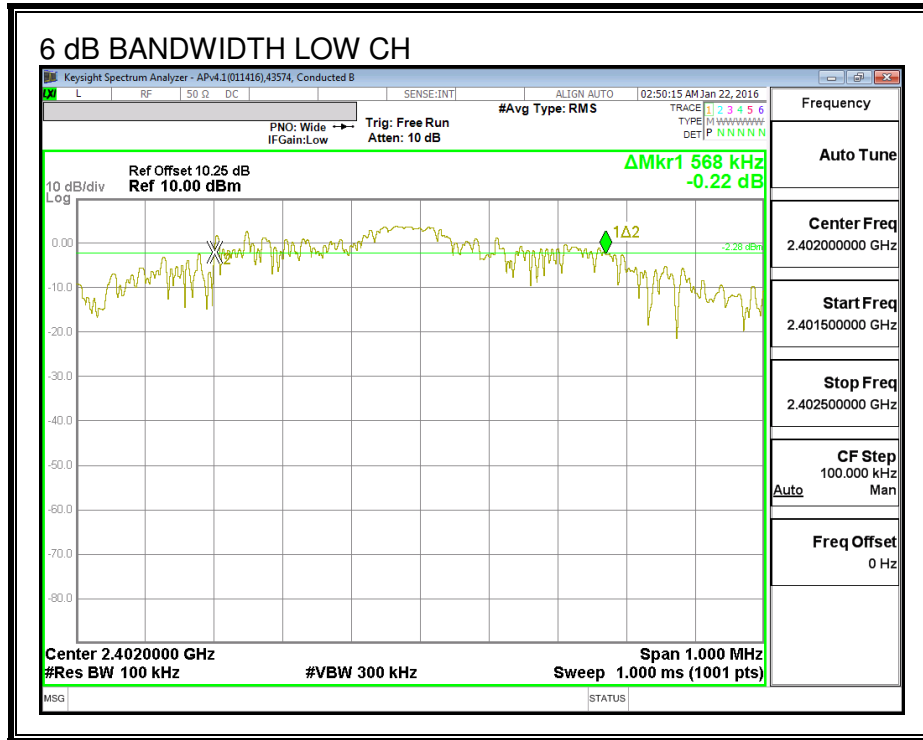

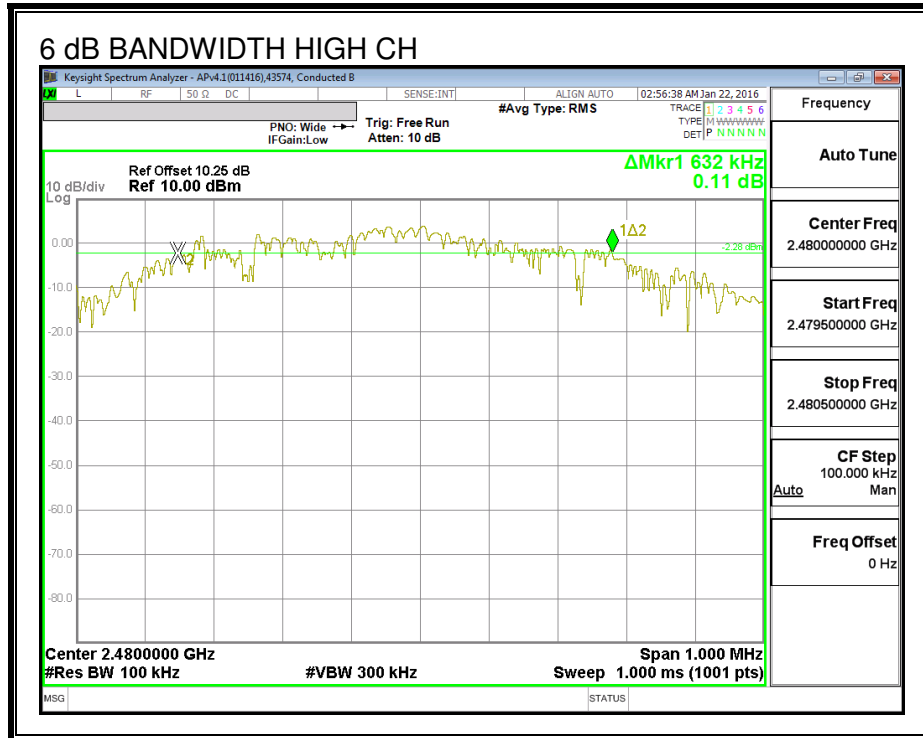

7.4. 99% BANDWIDTH

LIMITS

None; for reporting purposes only.

TEST PROCEDURE

The transmitter output is connected to the spectrum analyzer. The RBW is set to 1% to 3% of the 99 % bandwidth and to 1% of the span. The VBW is set to 3 times the RBW. The sweep time is coupled. The spectrum analyzer internal 99% bandwidth function is utilized.

RESULTS

Frequency (MHz)	99% Bandwidth (MHz)
2402	0.95303
2440	0.95191
2480	0.94049

99% BANDWIDTH

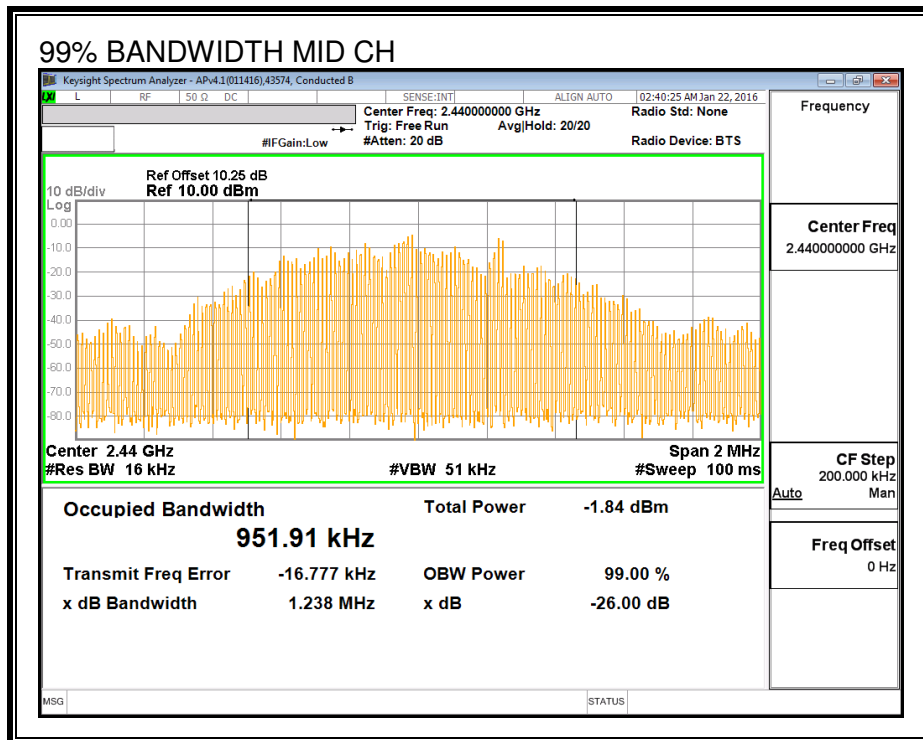
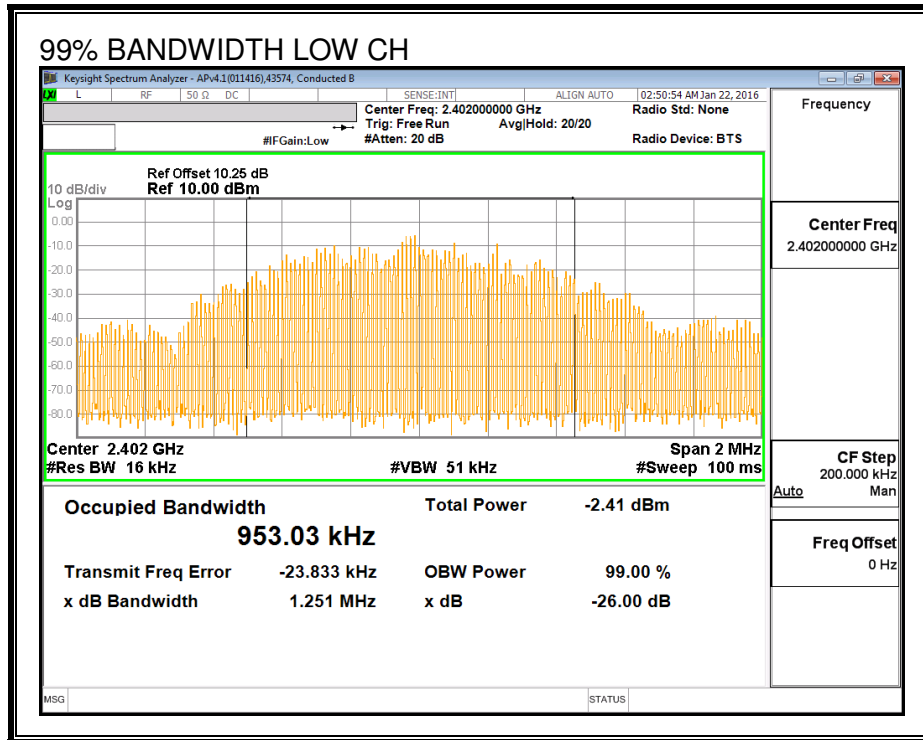

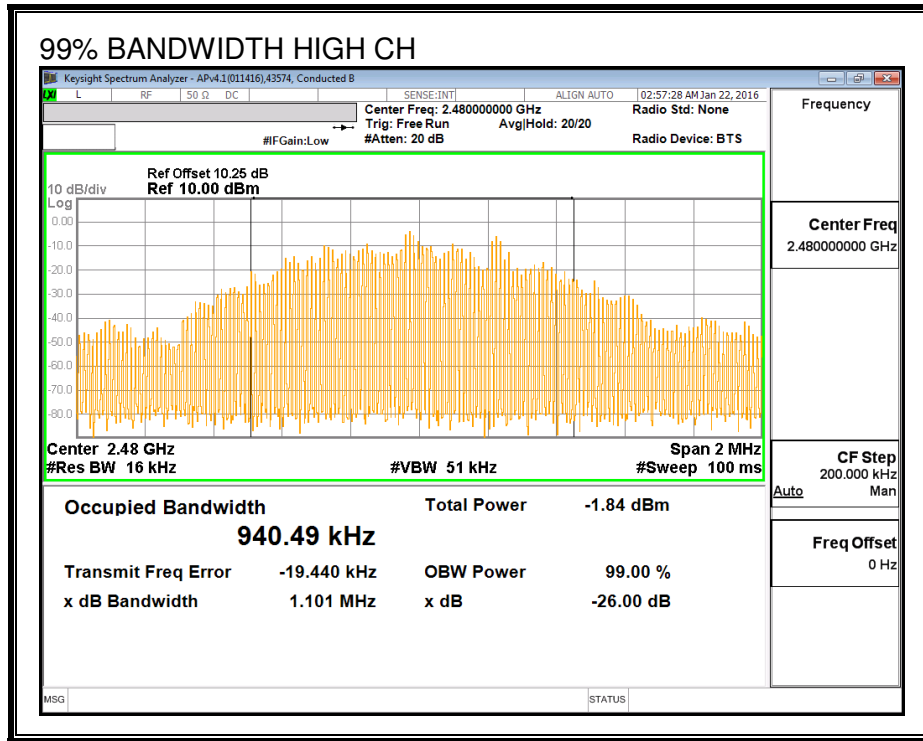

7.5. OUTPUT POWER

LIMITS

FCC §15.247 (b)

The maximum antenna gain is less than or equal to 6 dBi, therefore the limit is 30 dBm.

RESULTS

Channel	Frequency (MHz)	Peak Power Reading (dBm)	Limit (dBm)	Margin (dB)
Low	2402	3.919	30	-26.081
Middle	2440	3.987	30	-26.013
High	2480	3.845	30	-26.155

OUTPUT POWER

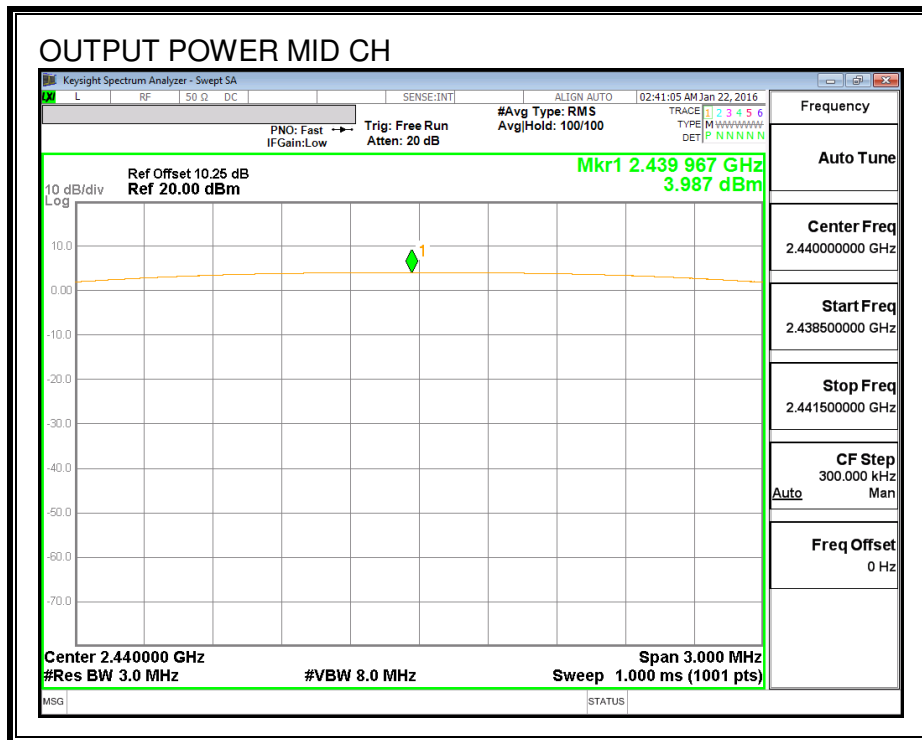
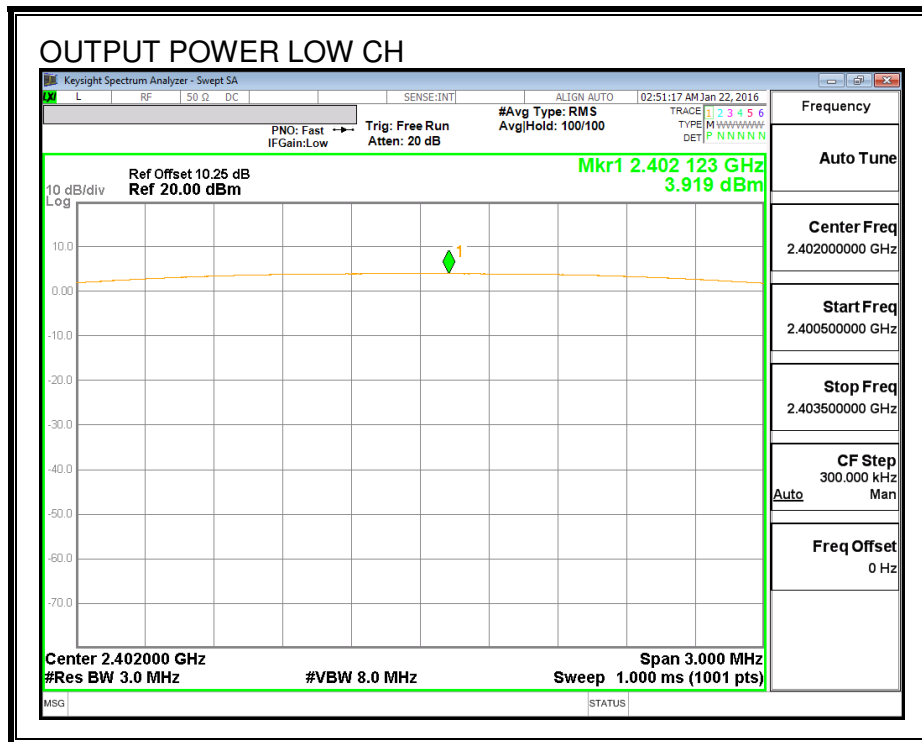

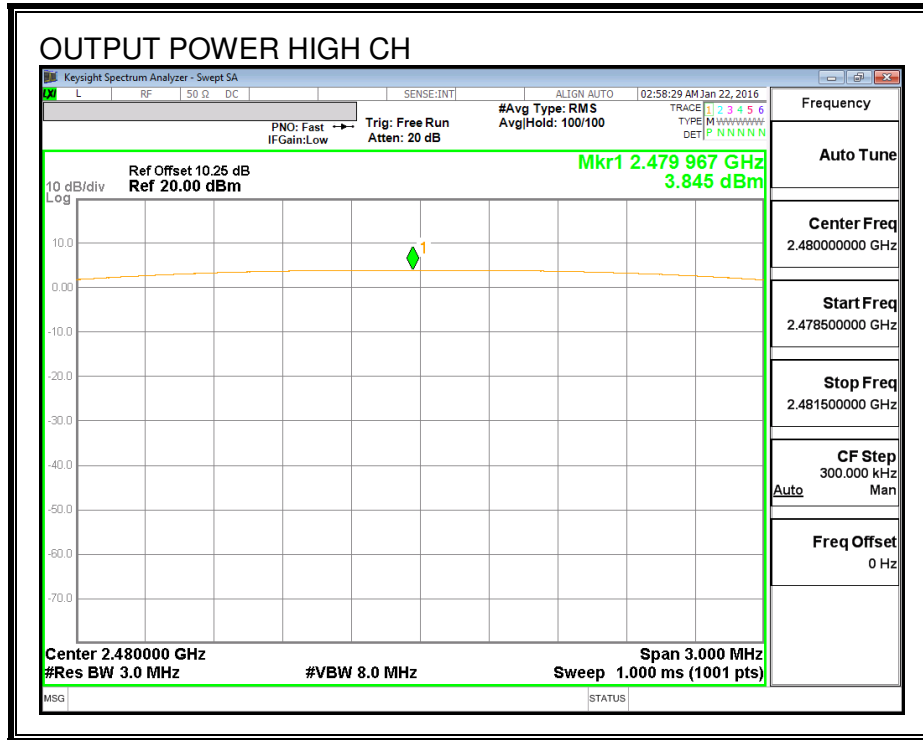

7.6. AVERAGE POWER

LIMITS

None; for reporting purposes only.

RESULTS

The cable assembly insertion loss of 10.25 dB (including 10 dB pad and 0.25 dB cable) was entered as an offset in the power meter to allow for direct reading of power.

Channel	Frequency (MHz)	AV power (dBm)
Low	2402	3.77
Middle	2440	3.84
High	2480	3.80

7.7. POWER SPECTRAL DENSITY

LIMITS

FCC §15.247 (e)

The power spectral density conducted from the transmitter to the antenna shall not be greater than 8 dBm in any 3 kHz band during any time interval of continuous transmission.

RESULTS

Channel	Frequency (MHz)	PSD (dBm)	Limit (dBm)	Margin (dB)
Low	2402	3.25	8	-4.75
Middle	2440	3.16	8	-4.84
High	2480	3.00	8	-5.00

POWER SPECTRAL DENSITY

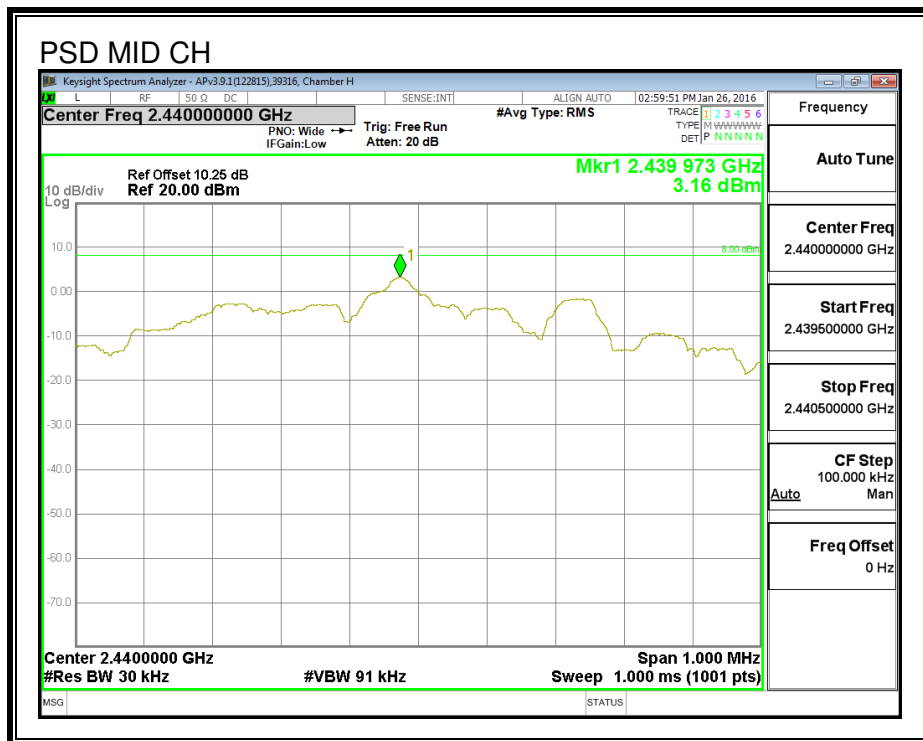
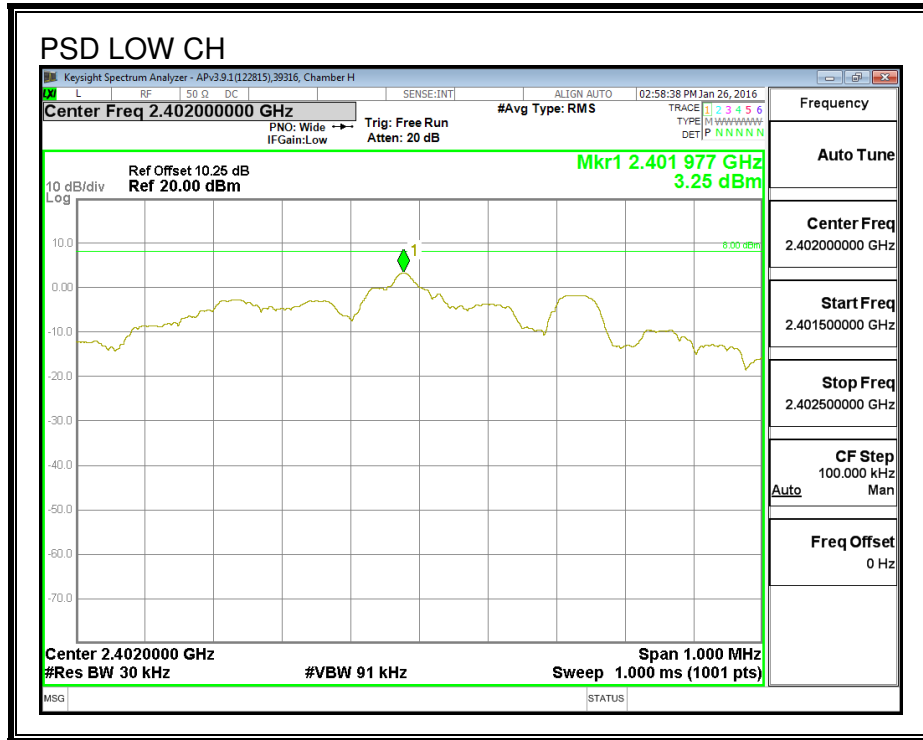

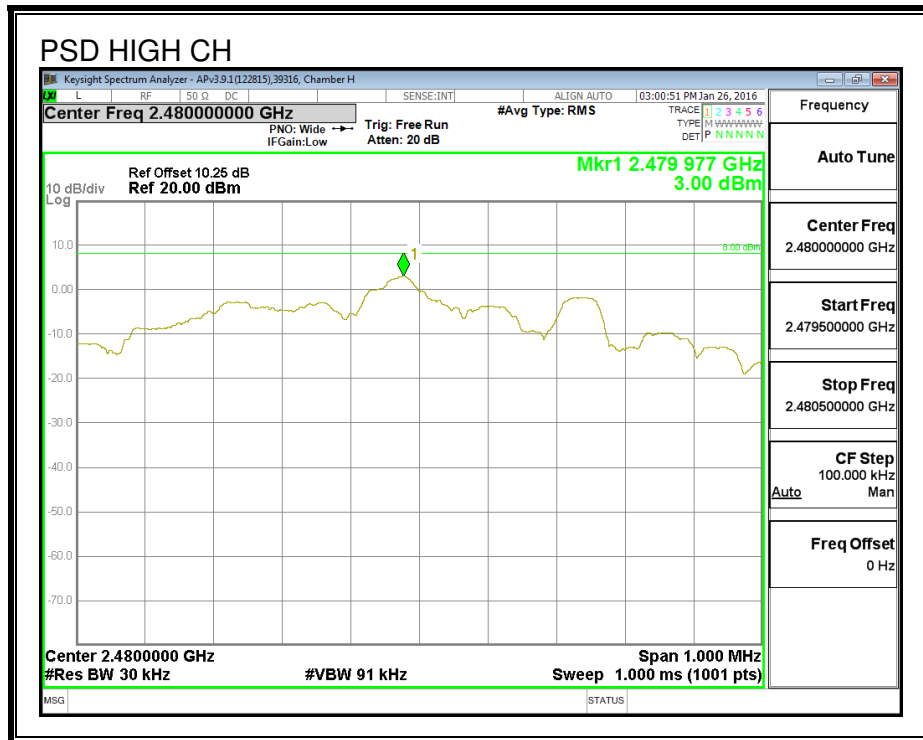

7.8. CONDUCTED SPURIOUS EMISSIONS

LIMITS

FCC §15.247 (d)

Output power was measured based on the use of a peak measurement, therefore the required attenuation is 20 dB.

RESULTS

SPURIOUS EMISSIONS, LOW CHANNEL

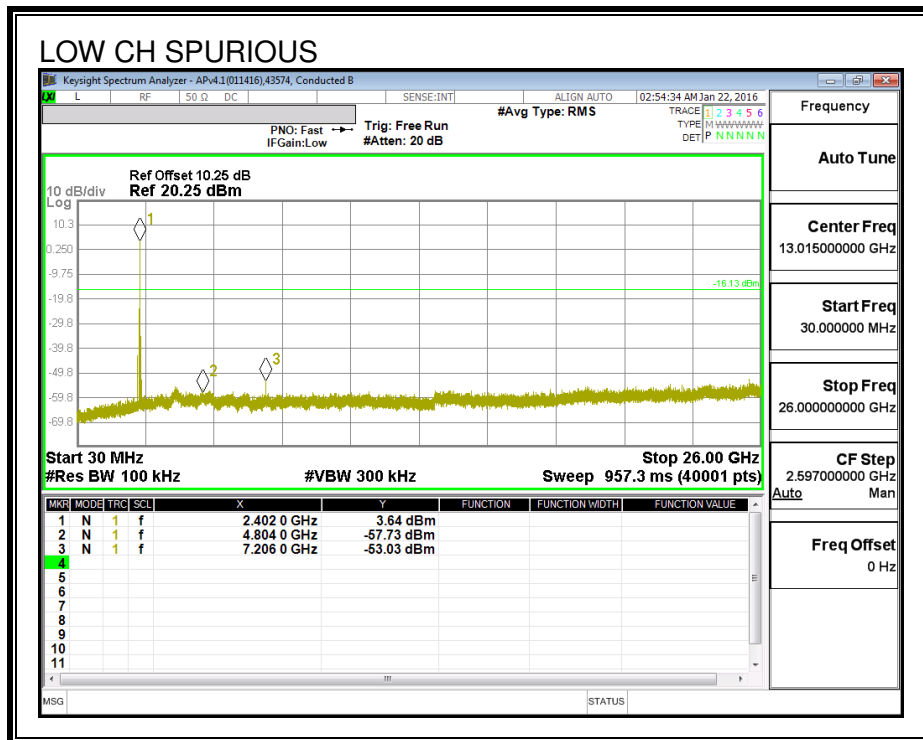
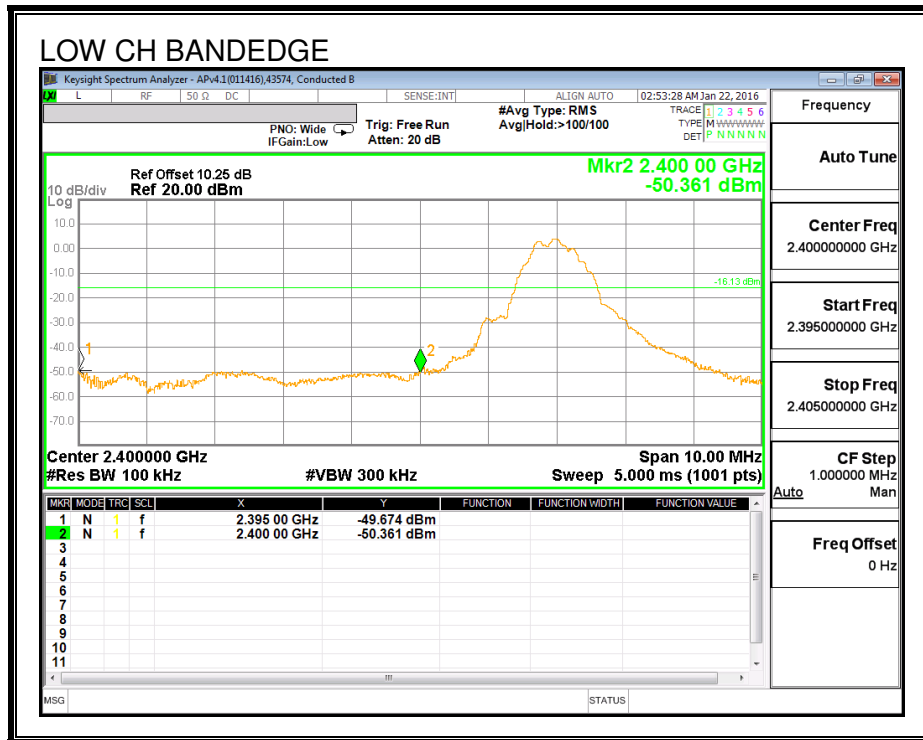

SPURIOUS EMISSIONS, MID CHANNEL

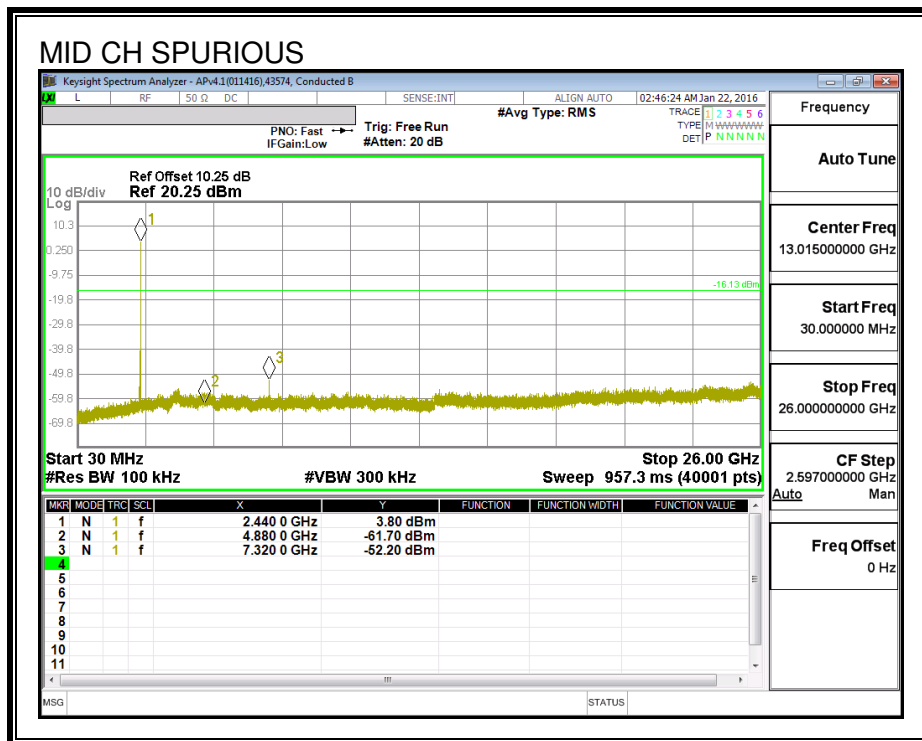
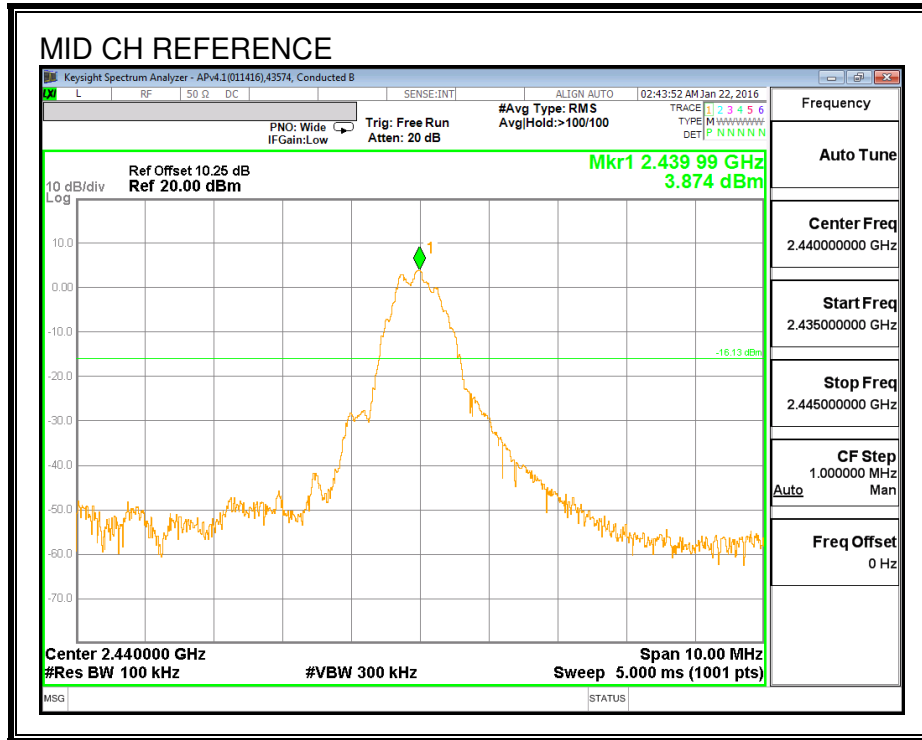

SPURIOUS EMISSIONS, HIGH CHANNEL

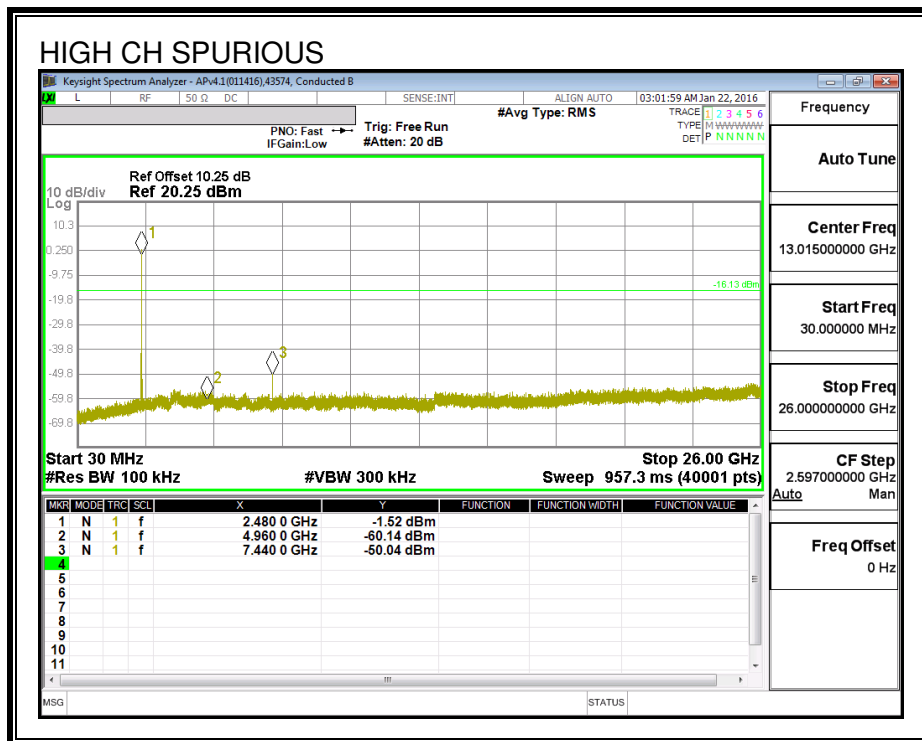
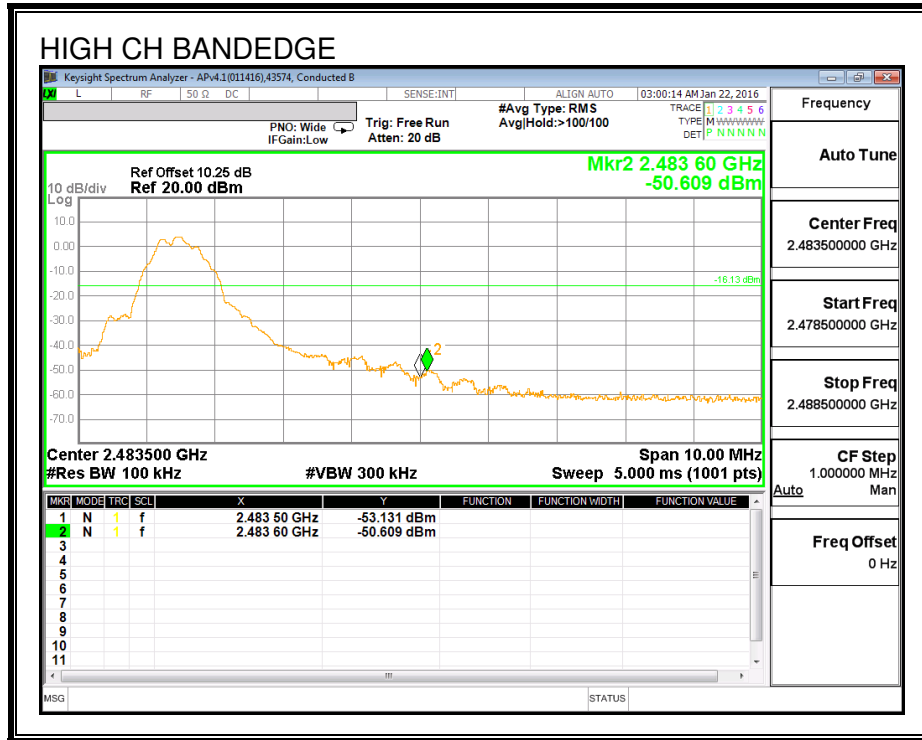

8. RADIATED TEST RESULTS

8.1. LIMITS AND PROCEDURE

LIMITS

FCC §15.205 and §15.209

Frequency Range (MHz)	Field Strength Limit (uV/m) at 3 m	Field Strength Limit (dBuV/m) at 3 m
30 - 88	100	40
88 - 216	150	43.5
216 - 960	200	46
Above 960	500	54

8.2. TRANSMITTER ABOVE 1 GHz

RESTRICTED BANDEGE (LOW CHANNEL)

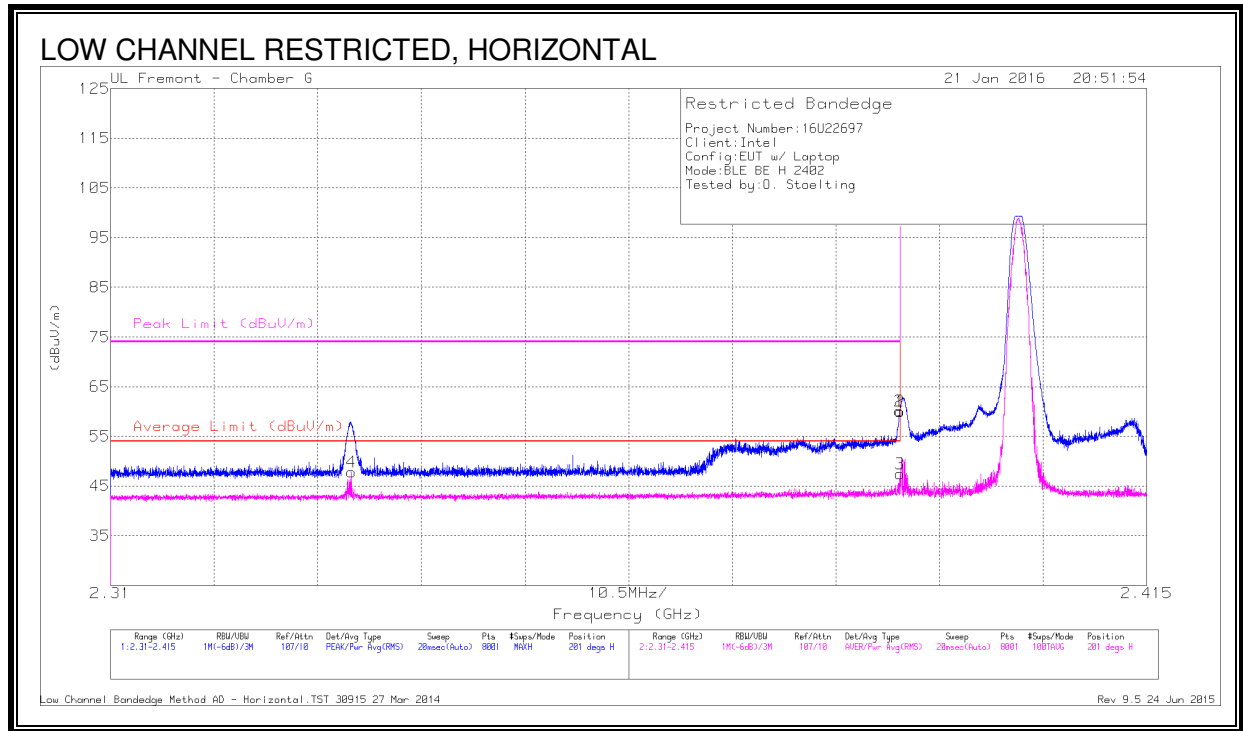

DATA

Marker	Frequency (GHz)	Meter Reading (dBuV)	Det	AF T862 (dB/m)	Amp/Cbl/Fit r/Pad (dB)	DC Corr (dB)	Corrected Reading (dBuV/m)	Average Limit (dBuV/m)	Margin (dB)	Peak Limit (dBuV/m)	PK Margin (dB)	Azimuth (Degs)	Height (cm)	Polarity
1	* 2.39	52.63	Pk	31.9	-24.5	0	60.03	-	-	74	-13.97	201	217	H
2	* 2.39	52.73	Pk	31.9	-24.5	0	60.13	-	-	74	-13.87	201	217	H
3	* 2.39	34.43	RMS	31.9	-24.5	5.61	47.44	54	-6.56	-	-	201	217	H
4	* 2.334	35.25	RMS	31.6	-24.6	5.61	47.86	54	-6.14	-	-	201	217	H

* - indicates frequency in CFR15.205/IC7.2.2 Restricted Band

Pk - Peak detector

RMS - RMS detection

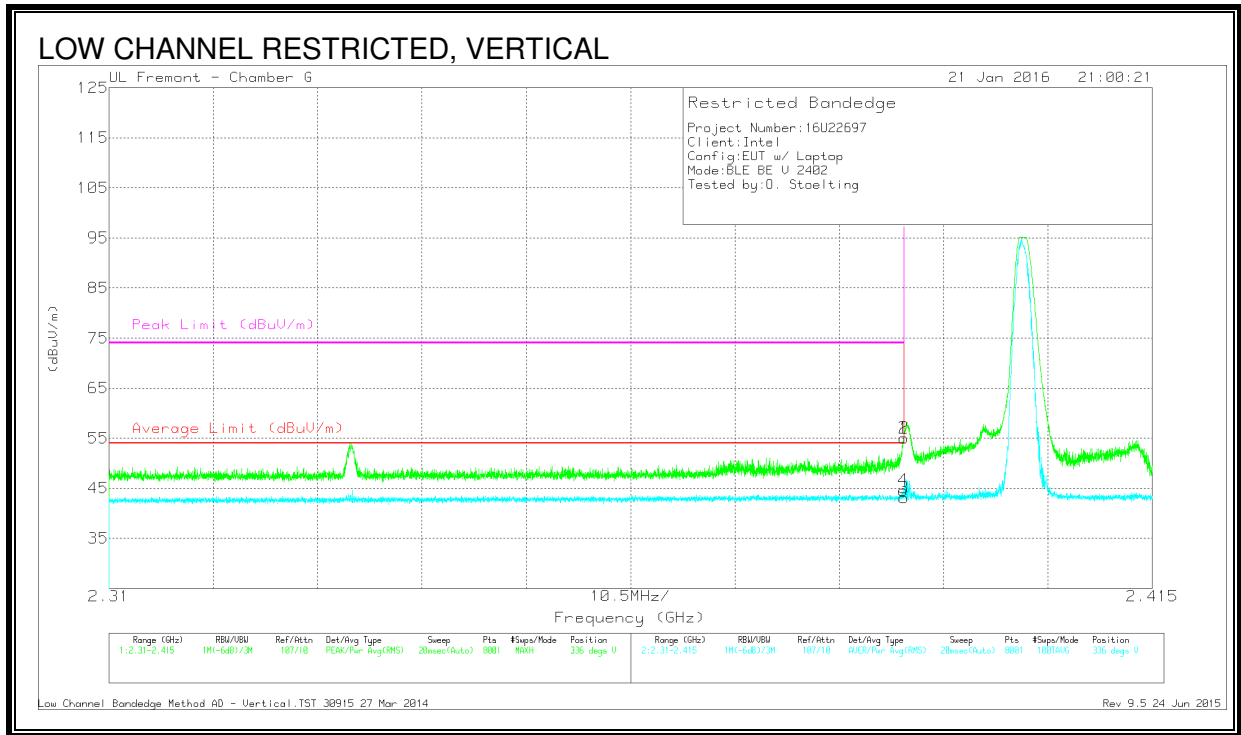

DATA

Marker	Frequency (GHz)	Meter Reading (dBuV)	Det	AF T862 (dB/m)	Amp/Cb/Filter/Pad (dB)	DC Corr (dB)	Corrected Reading (dBuV/m)	Average Limit (dBuV/m)	Margin (dB)	Peak Limit (dBuV/m)	PK Margin (dB)	Azimuth (Degs)	Height (cm)	Polarity
1	* 2.39	47.64	Pk	31.9	-24.5	0	55.04	-	-	74	-18.96	336	193	V
2	* 2.39	47.67	Pk	31.9	-24.5	0	55.07	-	-	74	-18.93	336	193	V
3	* 2.39	30.07	RMS	31.9	-24.5	5.61	43.08	54	-10.92	-	-	336	193	V
4	* 2.39	31.63	RMS	31.9	-24.5	5.61	44.64	54	-9.36	-	-	336	193	V

* - indicates frequency in CFR15.205/IC7.2.2 Restricted Band

Pk - Peak detector

RMS - RMS detection

RESTRICTED BANDEGE (HIGH CHANNEL)

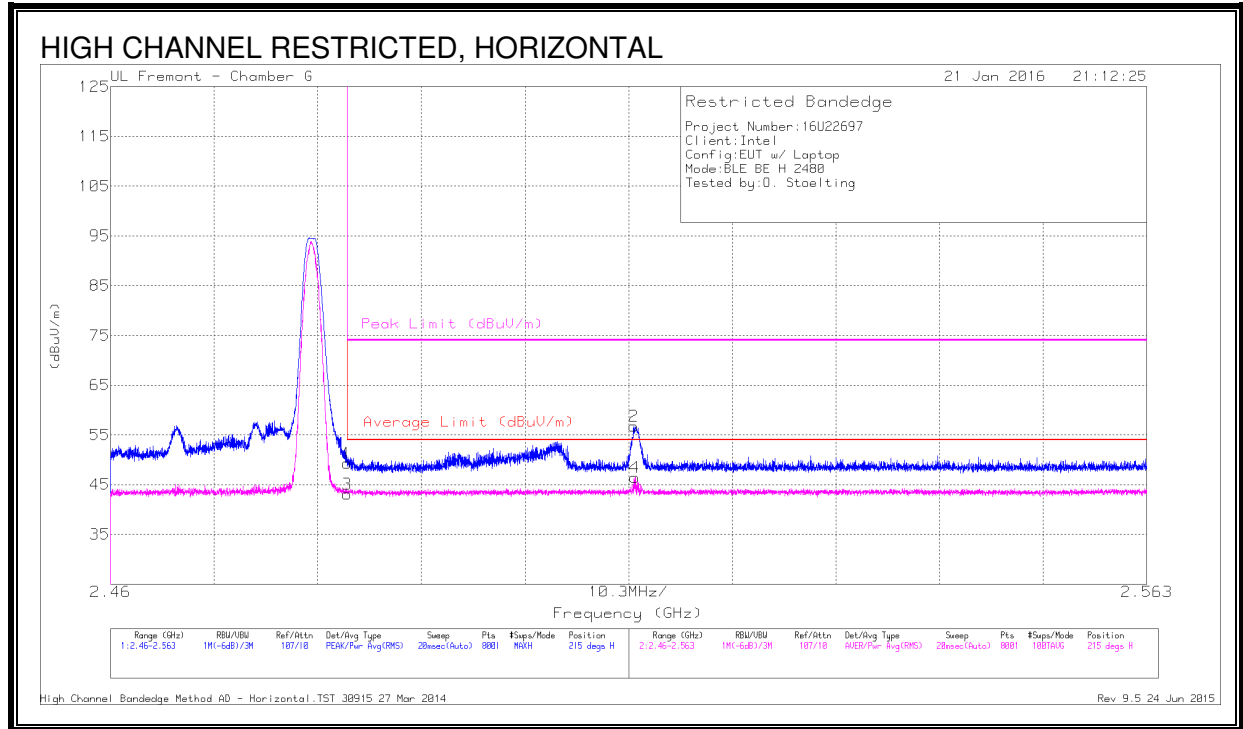

DATA

Marker	Frequency (GHz)	Meter Reading (dBuV)	Det	AF T862 (dB/m)	Amp/Cbl/Fit r/Pad (dB)	DC Corr (dB)	Corrected Reading (dBuV/m)	Average Limit (dBuV/m)	Margin (dB)	Peak Limit (dBuV/m)	PK Margin (dB)	Azimuth (Degs)	Height (cm)	Polarity
1	* 2.484	41.54	Pk	32.3	-24.5	0	49.34	-	-	74	-24.66	215	137	H
3	* 2.484	29.64	RMS	32.3	-24.5	5.61	43.05	54	-10.95	-	-	215	137	H
2	2.512	48.85	Pk	32.4	-24.5	0	56.75	-	-	74	-17.25	215	137	H
4	2.512	32.91	RMS	32.4	-24.5	5.61	46.42	54	-7.58	-	-	215	137	H

* - indicates frequency in CFR15.205/IC7.2.2 Restricted Band

Pk - Peak detector

RMS - RMS detection

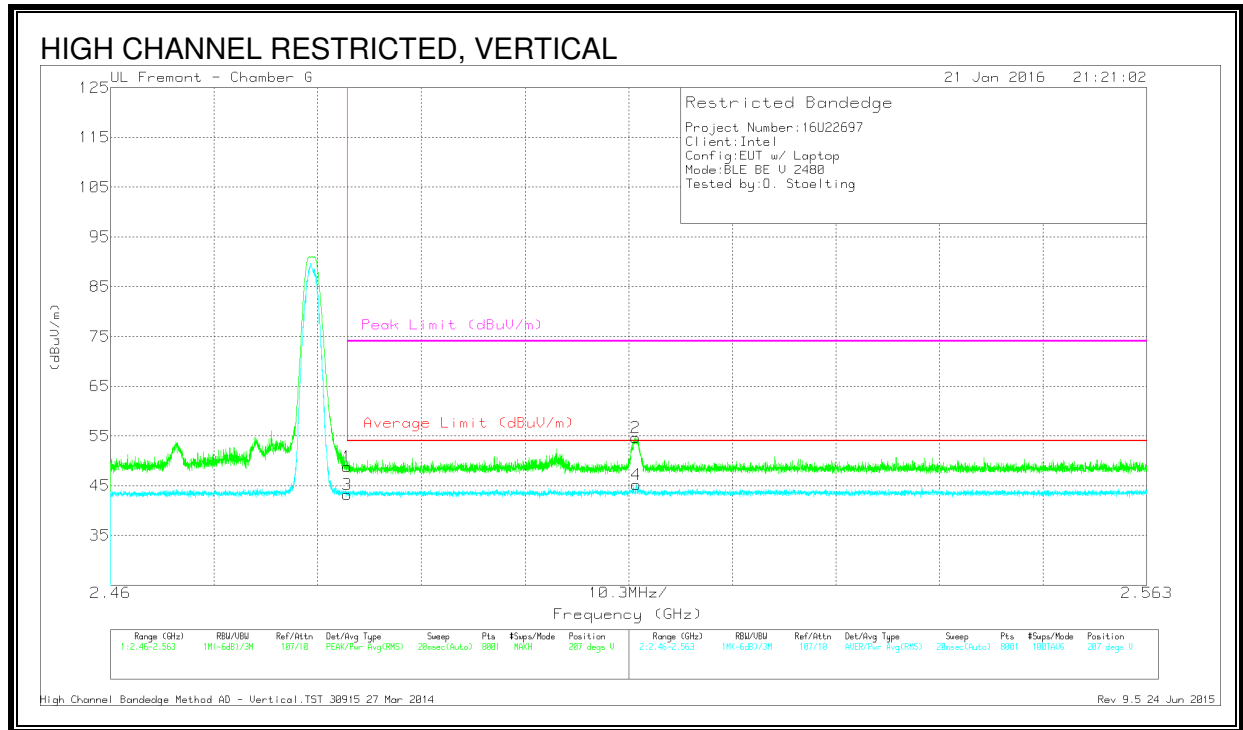

DATA

Marker	Frequency (GHz)	Meter Reading (dBuV)	Det	AF T862 (dB/m)	Amp/Cb/Fit r/Pad (dB)	DC Corr (dB)	Corrected Reading (dBuV/m)	Average Limit (dBuV/m)	Margin (dB)	Peak Limit (dBuV/m)	PK Margin (dB)	Azimuth (Degs)	Height (cm)	Polarity
1	* 2.484	41	Pk	32.3	-24.5	0	48.8	-	-	74	-25.2	207	228	V
3	* 2.484	29.77	RMS	32.3	-24.5	5.61	43.18	54	-10.82	-	-	207	228	V
2	2.512	46.71	Pk	32.4	-24.5	0	54.61	-	-	74	-19.39	207	228	V
4	2.512	31.72	RMS	32.4	-24.5	5.61	45.23	54	-8.77	-	-	207	228	V

* - indicates frequency in CFR15.205/IC7.2.2 Restricted Band

Pk - Peak detector

RMS - RMS detection

HARMONICS AND SPURIOUS EMISSIONS

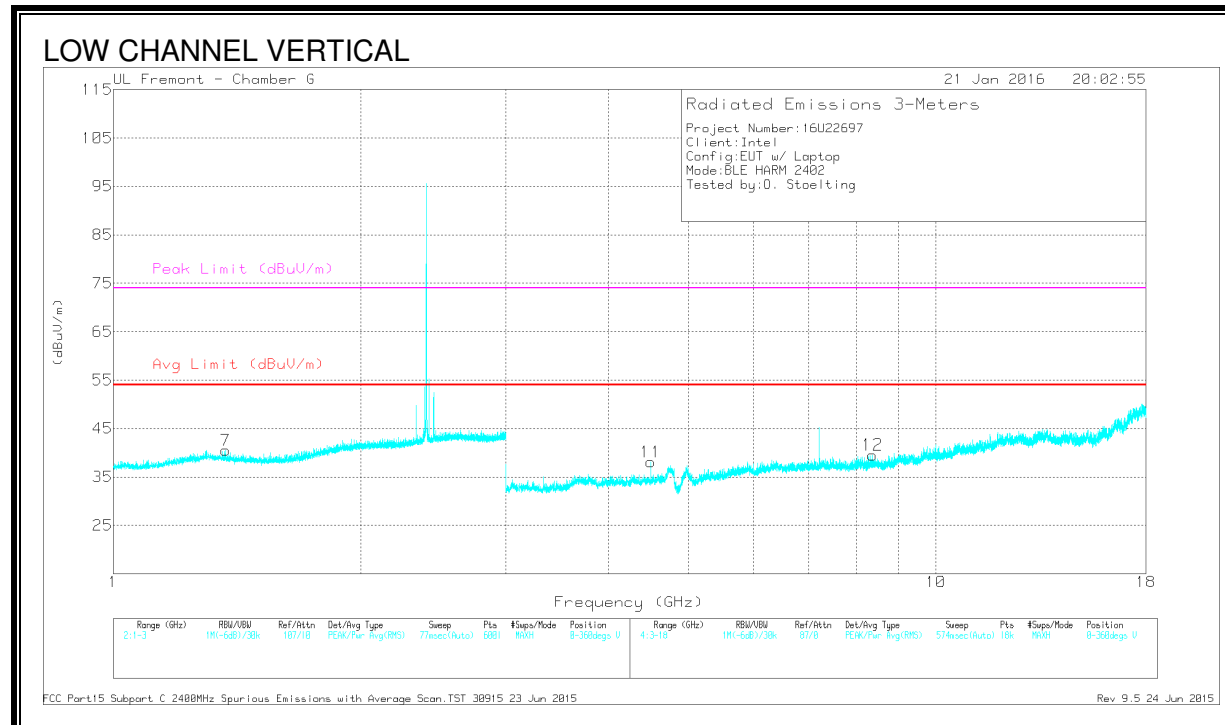
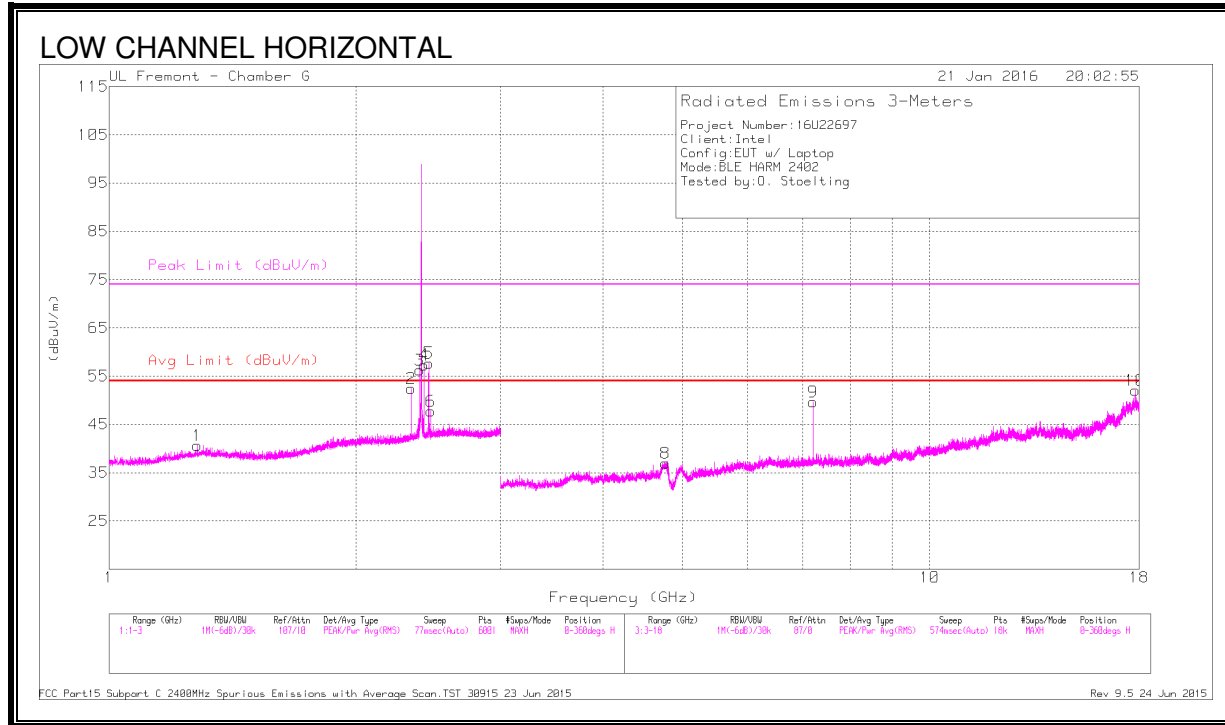

DATA

Marker	Frequency (GHz)	Meter Reading (dBuV)	Det	AF T862 (dB/m)	Amp/Cb/Fitr /Pad (dB)	DC Corr (dB)	Corrected Reading (dBuV/m)	Avg Limit (dBuV/m)	Margin (dB)	Peak Limit (dBuV/m)	PK Margin (dB)	Azimuth (Degs)	Height (cm)	Polarity
1	* 1.282	44.49	PK2	29.2	-25.7	0	47.99	-	-	74	-26.01	160	140	H
	* 1.283	32.31	MAv1	29.2	-25.7	5.61	41.42	54	-12.58	-	-	160	140	H
2	* 2.334	51.31	PK2	31.6	-24.6	0	58.31	-	-	74	-15.69	190	205	H
	* 2.334	33.05	MAv1	31.6	-24.6	5.61	45.66	54	-8.34	-	-	190	205	H
7	* 1.37	44.64	PK2	29	-25.5	0	48.14	-	-	74	-25.86	89	399	V
	* 1.369	32.6	MAv1	29	-25.5	5.61	41.71	54	-12.58	-	-	89	399	V
8	* 4.763	44.08	PK2	34	-32.5	0	45.58	-	-	74	-28.42	53	209	H
	* 4.767	32.33	MAv1	34	-32.5	5.61	39.44	54	-14.56	-	-	53	209	H
10	* 17.798	36.16	PK2	41.4	-19	0	58.56	-	-	74	-15.44	217	137	H
	* 17.799	24.98	MAv1	41.4	-19	5.61	52.99	54	-1.01	-	-	217	137	H
12	* 8.369	39.69	PK2	35.7	-29.5	0	45.89	-	-	74	-28.11	117	161	V
	* 8.368	28.42	MAv1	35.7	-29.5	5.61	40.23	54	-13.77	-	-	117	161	V
3	2.39	48.89	Pk	31.9	-24.5	0	56.29	-	-	74	-17.71	0-360	101	H
4	2.42	49.84	Pk	32	-24.5	0	57.34	-	-	74	-16.66	0-360	201	H
5	2.451	50.12	Pk	32.1	-24.5	0	57.72	-	-	74	-16.28	0-360	101	H
6	2.466	40.05	Pk	32.2	-24.5	0	47.75	-	-	74	-26.25	0-360	201	H
11	4.5	37.17	Pk	33.7	-32.8	0	38.07	-	-	74	-35.93	0-360	200	V
9	7.206	44.41	Pk	35.6	-30.3	0	49.71	-	-	74	-24.29	0-360	201	H

* - indicates frequency in CFR15.205/IC7.2.2 Restricted Band

Pk - Peak detector

PK2 - KDB558074 Method: Maximum Peak

MAv1 - KDB558074 Option 1 Maximum RMS Average

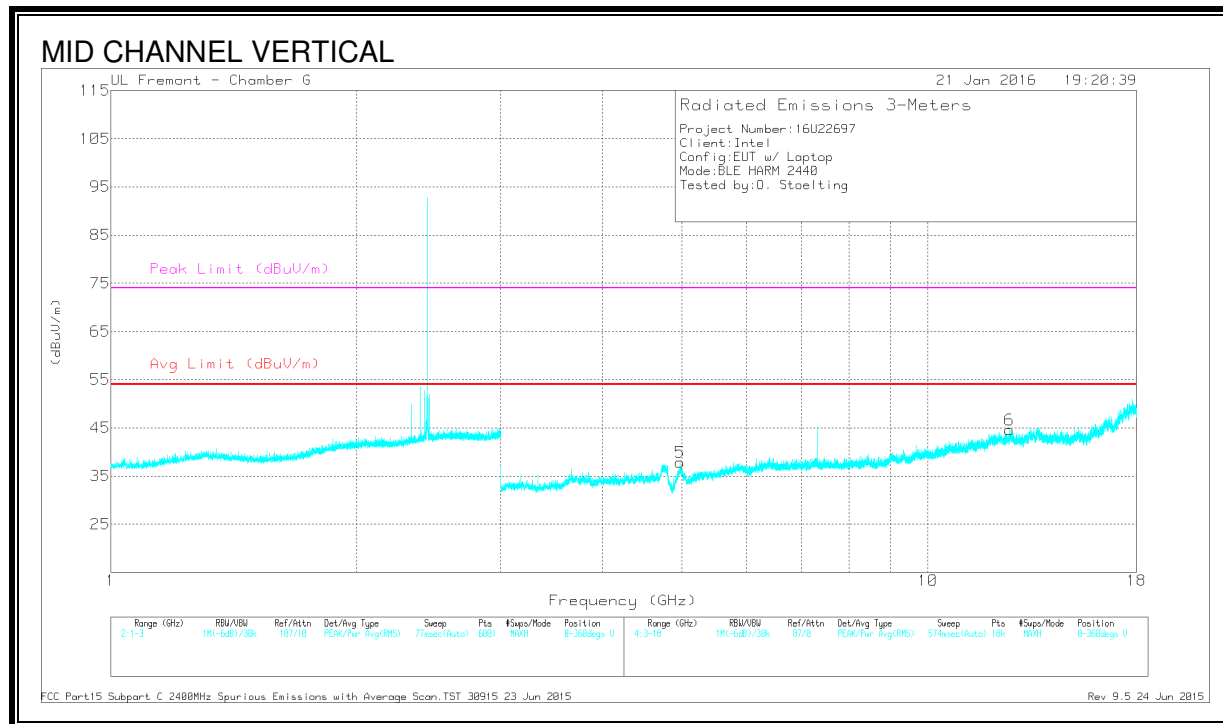
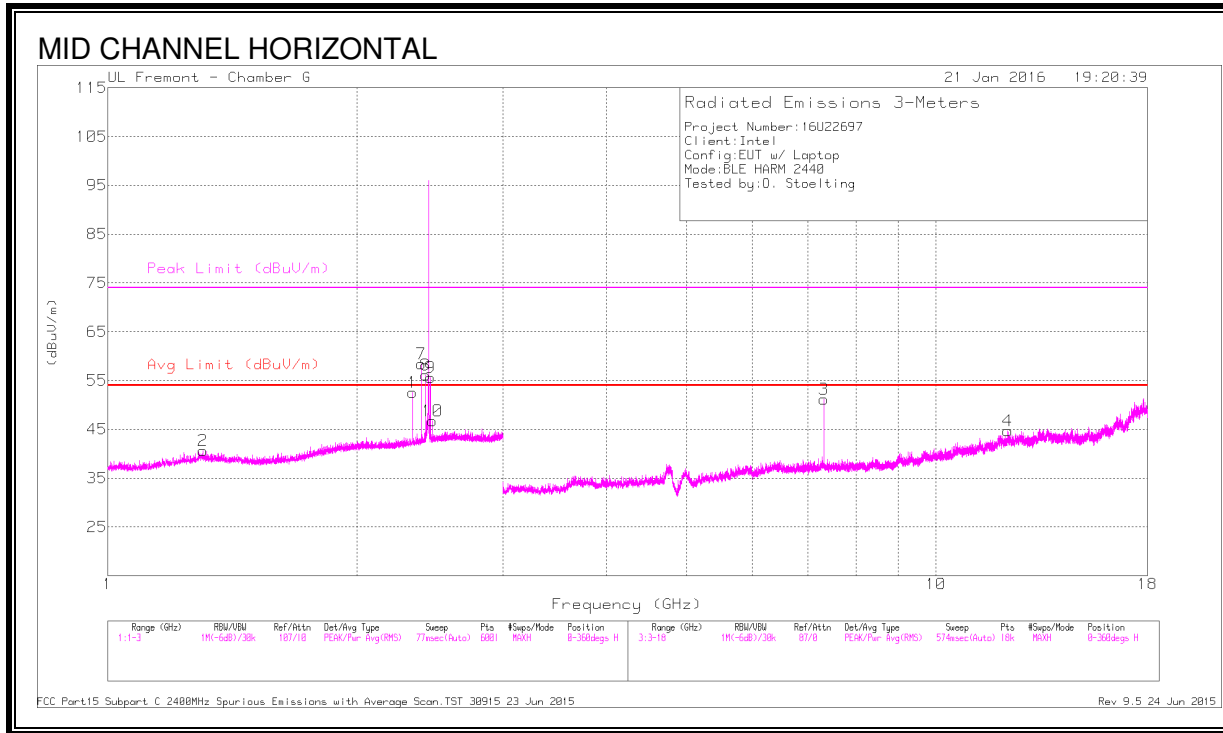

DATA

Marker	Frequency (GHz)	Meter Reading (dBuV)	Det	AF T862 (dB/m)	Amp/Cbl/Filtr /Pad (dB)	DC Corr (dB)	Corrected Reading (dBuV/m)	Avg Limit (dBuV/m)	Margin (dB)	Peak Limit (dBuV/m)	PK Margin (dB)	Azimuth (Degs)	Height (cm)	Polarity
2	* 1.302	44.56	PK2	29.3	-25.6	0	48.26	-	-	74	-25.74	118	171	H
	* 1.303	32.31	MAv1	29.3	-25.6	5.61	41.62	54	-12.38	-	-	118	171	H
4	* 12.21	37.4	PK2	39	-24.6	0	51.8	-	-	74	-22.2	105	197	H
	* 12.212	26.2	MAv1	39	-24.7	5.61	46.11	54	-7.89	-	-	105	197	H
6	* 12.585	37.48	PK2	39.2	-25.2	0	51.48	-	-	74	-22.52	189	252	V
	* 12.586	25.97	MAv1	39.2	-25.1	5.61	45.68	54	-8.32	-	-	189	252	V
1	* 2.334	52.01	PK2	31.6	-24.6	0	59.01	-	-	74	-14.99	199	226	H
	* 2.334	34.07	MAv1	31.6	-24.6	5.61	46.68	54	-7.32	-	-	199	226	H
5	* 4.971	43.91	PK2	34.2	-32.4	0	45.71	-	-	74	-28.29	132	144	V
	* 4.97	31.3	MAv1	34.2	-32.4	5.61	38.71	54	-15.29	-	-	132	144	V
3	* 7.319	50.67	PK2	35.6	-30.6	0	55.67	-	-	74	-18.33	230	242	H
	* 7.32	41.13	MAv1	35.6	-30.6	5.61	51.74	54	-8.32	-	-	230	242	H
7	2.39	51.06	Pk	31.9	-24.5	0	58.46	-	-	74	-15.54	0-360	101	H
8	2.42	48.61	Pk	32	-24.5	0	56.11	-	-	74	-17.89	0-360	201	H
9	2.451	48.06	Pk	32.1	-24.5	0	55.66	-	-	74	-18.34	0-360	101	H
10	2.466	39.1	Pk	32.2	-24.5	0	46.8	-	-	74	-27.2	0-360	101	H

* - indicates frequency in CFR15.205/IC7.2.2 Restricted Band

Pk - Peak detector

PK2 - KDB558074 Method: Maximum Peak

MAv1 - KDB558074 Option 1 Maximum RMS Average

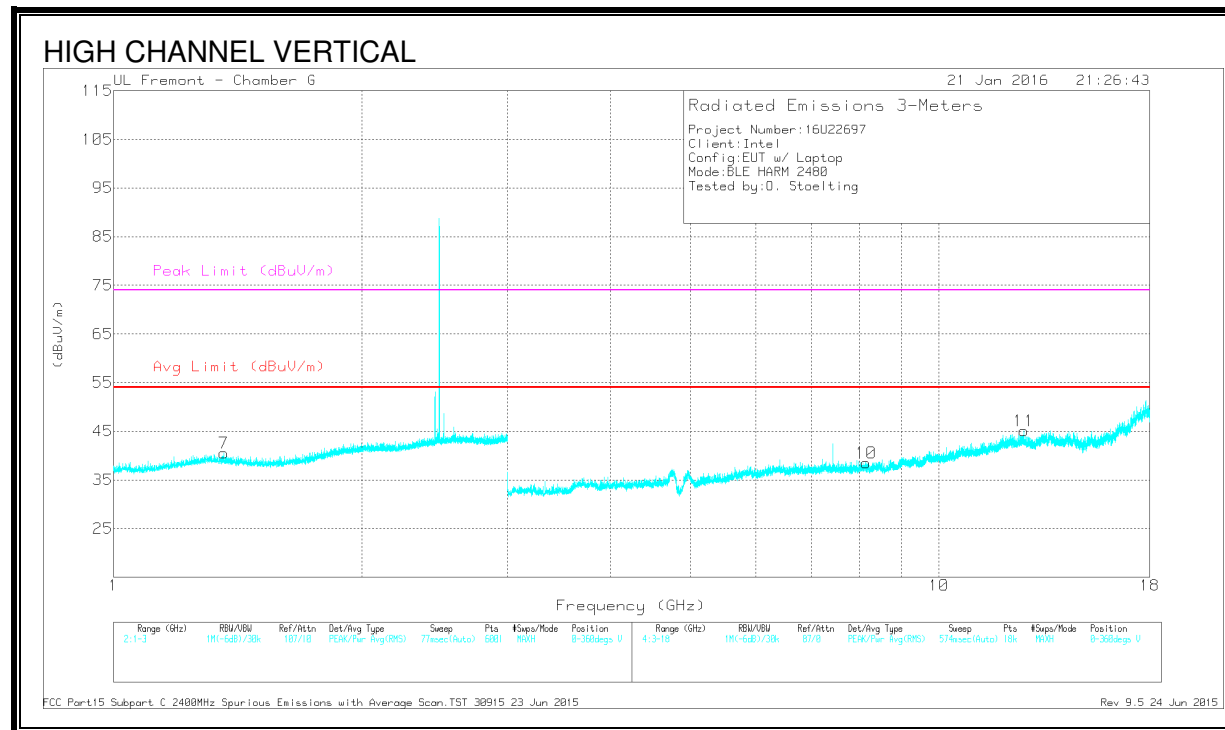
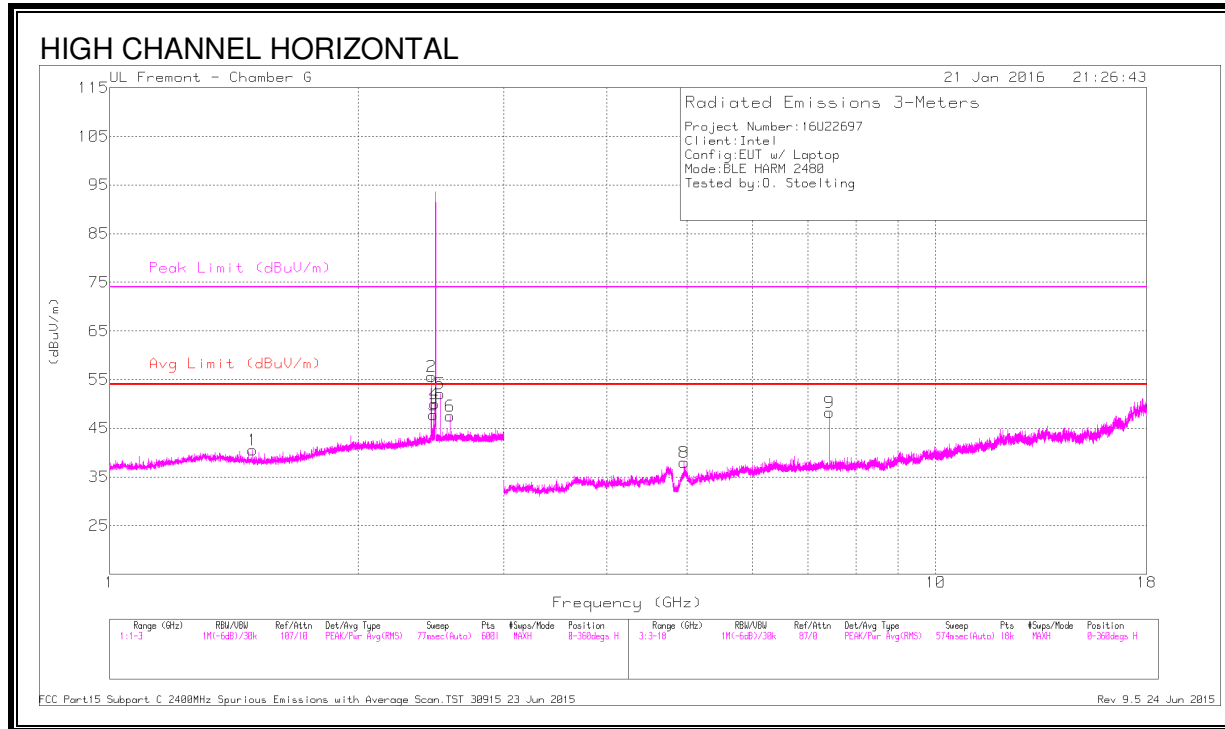

DATA

Marker	Frequency (GHz)	Meter Reading (dBuV)	Det	AF T862 (dB/m)	Amp/Cbl/Filtr /Pad (dB)	DC Corr (dB)	Corrected Reading (dBuV/m)	Avg Limit (dBuV/m)	Margin (dB)	Peak Limit (dBuV/m)	PK Margin (dB)	Azimuth (Degs)	Height (cm)	Polarity
7	* 1.358	44.21	PK2	29	-25.5	0	47.71	-	-	74	-26.29	176	187	V
	* 1.357	32.18	MAv1	29	-25.5	5.61	41.29	54	-12.71	-	-	176	187	V
1	* 1.488	43.96	PK2	28.4	-25.2	0	47.16	-	-	74	-26.84	355	115	H
	* 1.489	32.08	MAv1	28.4	-25.2	5.61	40.89	54	-13.11	-	-	355	115	H
11	* 12.674	37.59	PK2	39.3	-25	0	51.89	-	-	74	-22.11	360	173	V
	* 12.673	25.78	MAv1	39.3	-25	5.61	45.69	54	-8.31	-	-	360	173	V
8	* 4.96	43.42	PK2	34.1	-32.4	0	45.12	-	-	74	-28.88	152	105	H
	* 4.96	32.21	MAv1	34.1	-32.4	5.61	39.52	54	-8.32	-	-	152	105	H
9	* 7.439	47.31	PK2	35.6	-30.7	0	52.21	-	-	74	-21.79	212	113	H
	* 7.44	36.7	MAv1	35.6	-30.7	5.61	47.21	54	-6.79	-	-	212	113	H
10	* 8.164	39.86	PK2	35.7	-29.4	0	46.16	-	-	74	-27.84	77	138	V
	* 8.162	28.36	MAv1	35.7	-29.4	5.61	40.27	54	-13.73	-	-	77	138	V
2	2.451	48.07	Pk	32.1	-24.5	0	55.67	-	-	74	-18.33	0-360	201	H
3	2.467	40.04	Pk	32.2	-24.5	0	47.74	-	-	74	-26.26	0-360	201	H
4	2.474	42.3	Pk	32.2	-24.5	0	50	-	-	74	-24	0-360	201	H
5	2.512	44.2	Pk	32.4	-24.5	0	52.1	-	-	74	-21.9	0-360	201	H
6	2.582	39.49	Pk	32.4	-24.4	0	47.49	-	-	74	-26.51	0-360	201	H

* - indicates frequency in CFR15.205/IC7.2.2 Restricted Band

Pk - Peak detector

PK2 - KDB558074 Method: Maximum Peak

MAv1 - KDB558074 Option 1 Maximum RMS Average

8.3. WORST-CASE BELOW 1 GHz

SPURIOUS EMISSIONS 30 TO 1000 MHz (WORST-CASE CONFIGURATION, HORIZONTAL)

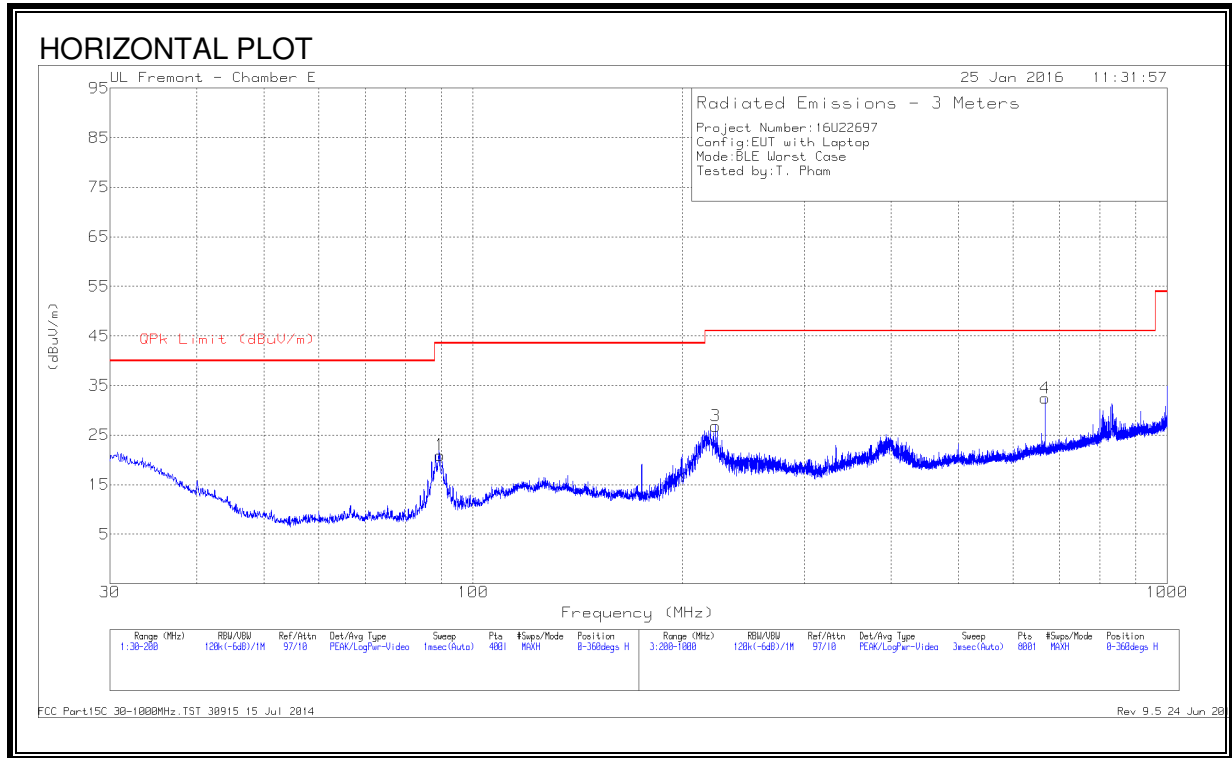

SPURIOUS EMISSIONS 30 TO 1000 MHz (WORST-CASE CONFIGURATION, VERTICAL)

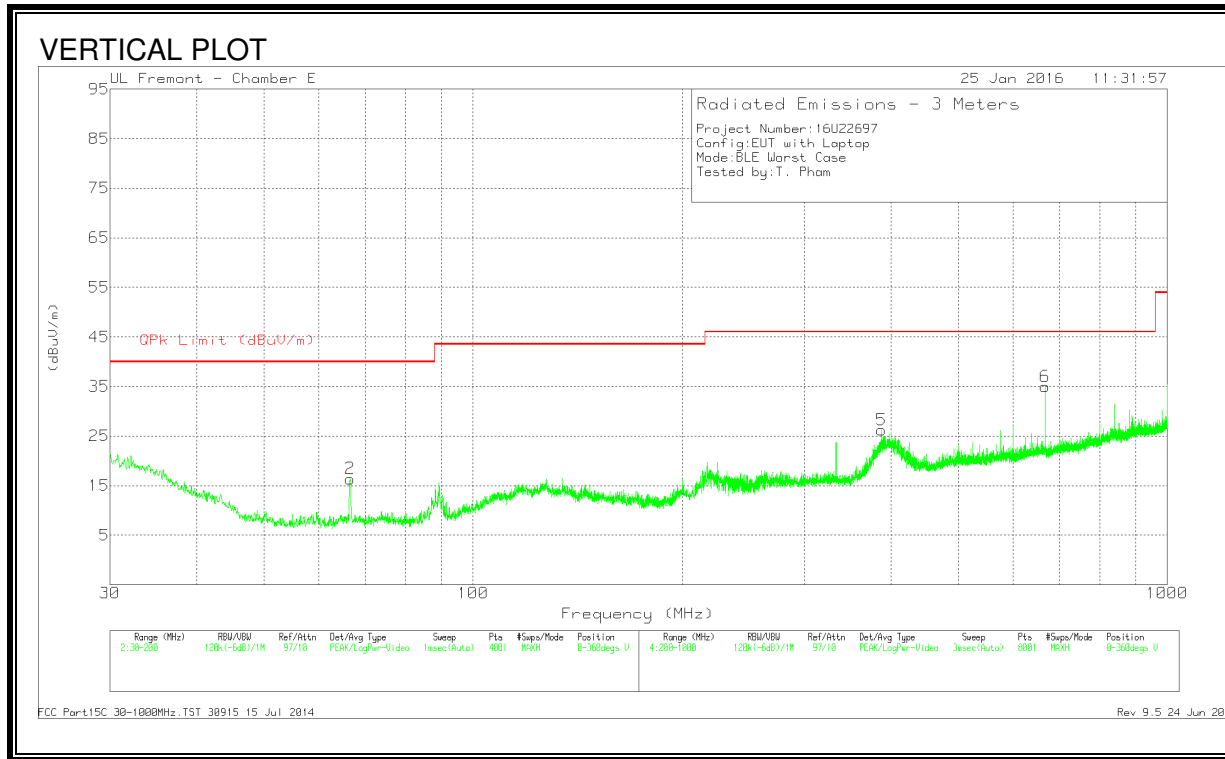

DATA

Marker	Frequency (MHz)	Meter Reading (dBuV)	Det	AF T243 (dB/m)	Amp/Cbl (dB)	Corrected Reading (dBuV/m)	QPk Limit (dBuV/m)	Margin (dB)	Azimuth (Degs)	Height (cm)	Polarity
2	66.5075	36	Pk	11.9	-31.5	16.4	40	-23.6	0-360	100	V
1	89.6275	40.77	Pk	11.5	-31.3	20.97	43.52	-22.55	0-360	201	H
3	223.6	42.81	Pk	14.7	-30.7	26.81	46.02	-19.21	0-360	100	H
5	388	37.15	Pk	19.1	-30	26.25	46.02	-19.77	0-360	201	V
4	666.7	38.01	Pk	23.7	-29.2	32.51	46.02	-13.51	0-360	100	H
6	666.7	40.47	Pk	23.7	-29.2	34.97	46.02	-11.05	0-360	99	V

Pk - Peak detector

8.1. WORST-CASE 18 – 26 GHz

SPURIOUS EMISSIONS 18 -26GHz (WORST-CASE CONFIGURATION)

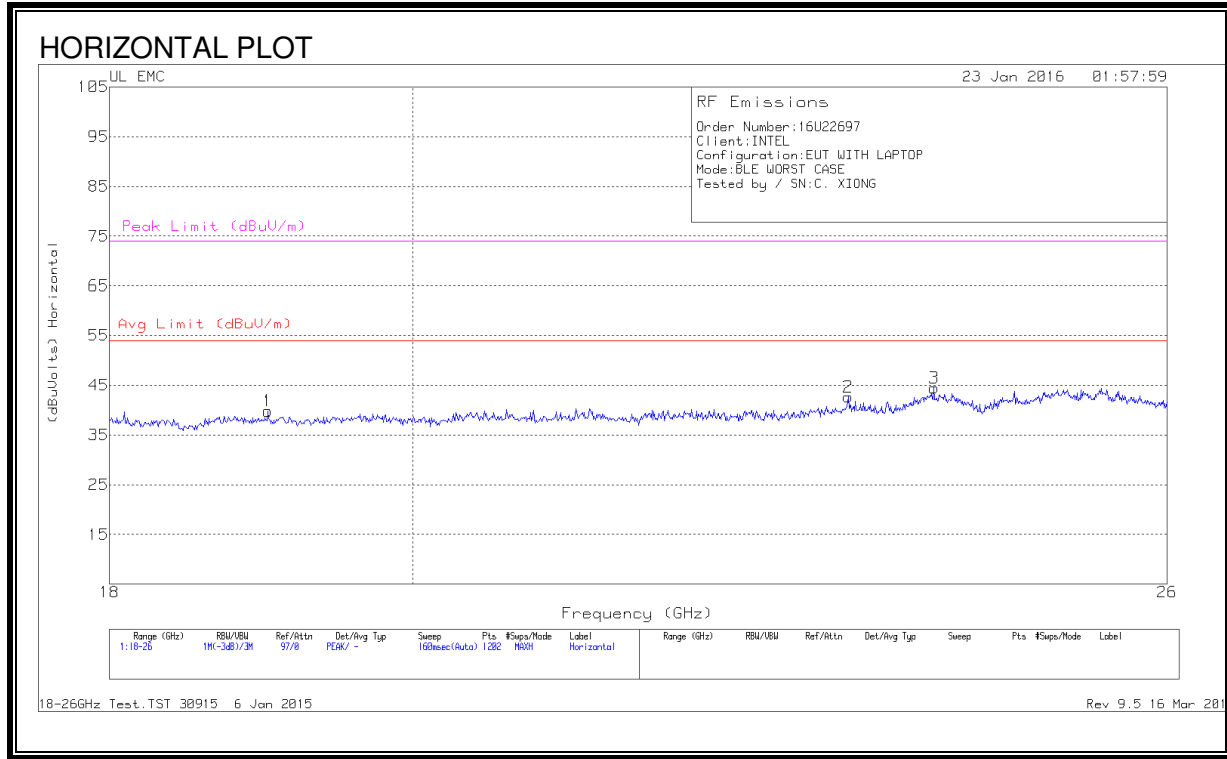

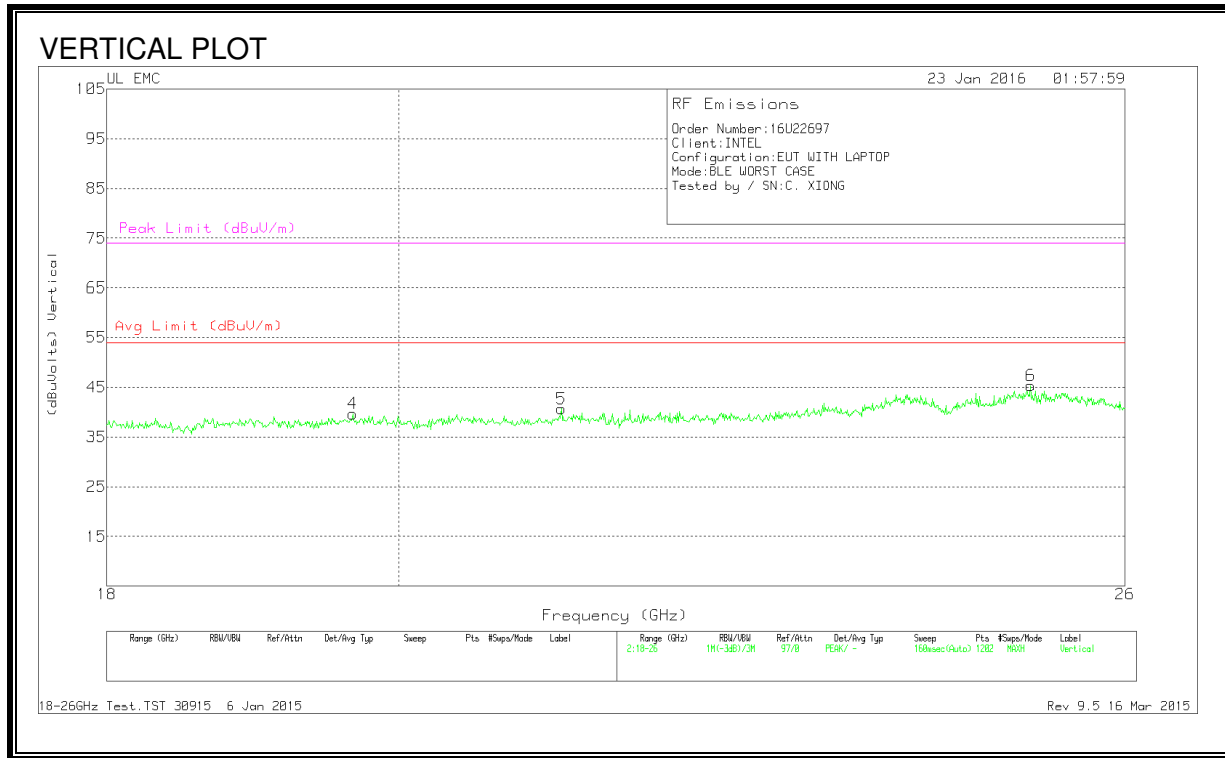

DATA

Marker	Frequency (GHz)	Meter Reading (dBuV)	Det	T477 AF (dB/m)	Amp/Cbl (dB)	Dist Corr (dB)	Corrected Reading (dBuVolts)	Avg Limit (dBuV/m)	Margin (dB)	Peak Limit (dBuV/m)	PK Margin (dB)
1	19.019	41.53	Pk	32.5	-24.7	-9.5	39.83	54	-14.16	74	-34.16
2	23.269	43.37	Pk	33.5	-24.7	-9.5	42.66	54	-11.33	74	-31.33
3	23.975	44.6	Pk	33.6	-24.2	-9.5	44.5	54	-9.5	74	-29.5
4	19.672	41.37	Pk	32.8	-25	-9.5	39.66	54	-14.33	74	-34.33
5	21.211	41.87	Pk	33	-24.7	-9.5	40.66	54	-13.33	74	-33.33
6	25.127	45.23	Pk	34.2	-24.6	-9.5	45.33	54	-8.66	74	-28.66

Pk - Peak detector

9. AC POWER LINE CONDUCTED EMISSIONS

LIMITS

FCC §15.207 (a)

Frequency of Emission (MHz)	Conducted Limit (dB μ V)	
	Quasi-peak	Average
0.15-0.5	66 to 56 *	56 to 46 *
0.5-5	56	46
5-30	60	50

*Decreases with the logarithm of the frequency.

TEST PROCEDURE

The EUT is placed on a non-conducting table 40 cm from the vertical ground plane and 80 cm above the horizontal ground plane. The EUT is configured in accordance with ANSI C63.10-2013

The receiver is set to a resolution bandwidth of 9 kHz. Peak detection is used unless otherwise noted as quasi-peak or average.

Line conducted data is recorded for both NEUTRAL and HOT lines

RESULTS

LINE 1 RESULTS

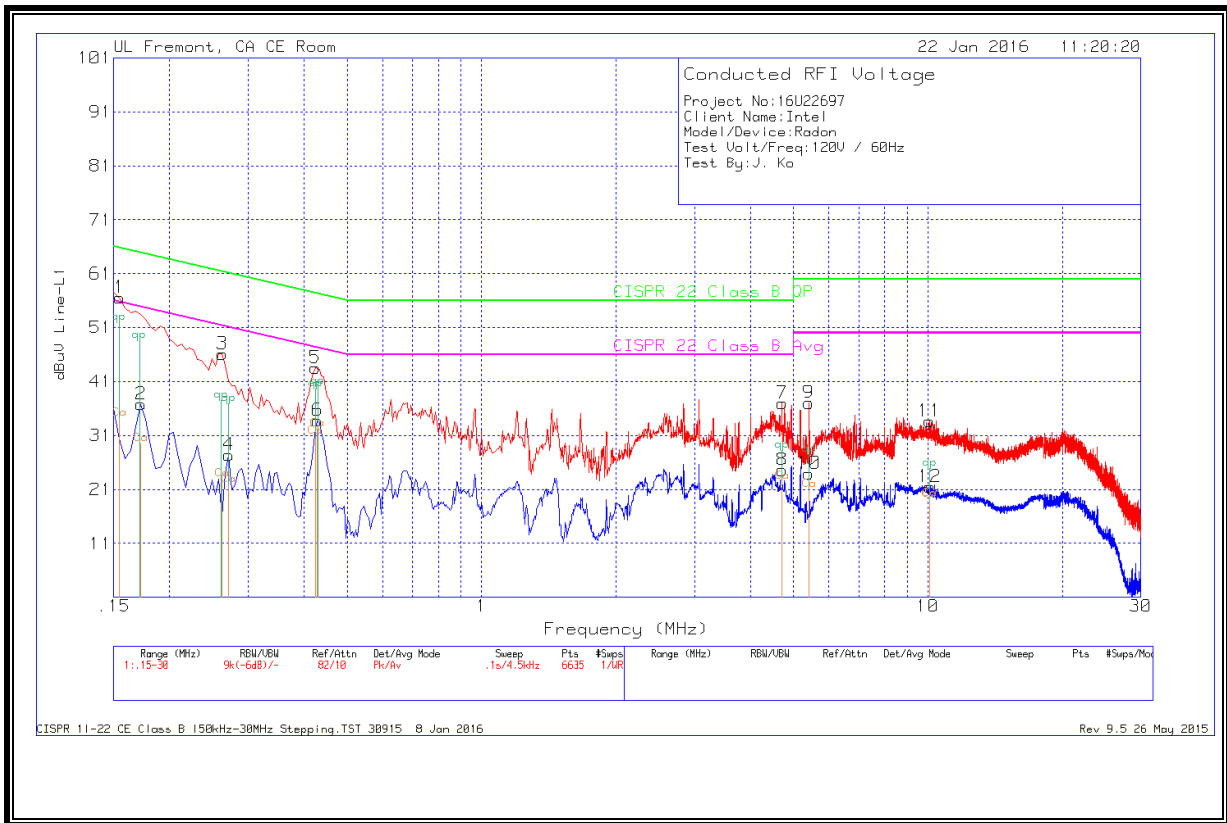

DATA

Range 1: Line-L1 .15 - 30MHz									
Frequency (MHz)	Meter Reading (dBuV)	Det	T1310 IL L1	LC Cables 1&3	Corrected Reading dBuV	CISPR 22 Class B QP	Margin (dB)	CISPR 22 Class B Avg	Margin (dB)
.15428	34.11	Ca	0	0	34.11	-	-	55.77	-21.66
.15428	51.97	Qp	0	0	51.97	65.77	-13.8	-	-
.17138	29.5	Ca	0	0	29.5	-	-	54.89	-25.39
.17138	48.52	Qp	0	0	48.52	64.89	-16.37	-	-
.26138	22.87	Ca	0	0	22.87	-	-	51.39	-28.52
.26138	37.49	Qp	0	0	37.49	61.39	-23.9	-	-
.27128	21.79	Ca	0	0	21.79	-	-	51.08	-29.29
.27128	36.92	Qp	0	0	36.92	61.08	-24.16	-	-
.42518	30.81	Ca	0	0	30.81	-	-	47.35	-16.54
.42518	39.69	Qp	0	0	39.69	57.35	-17.66	-	-
.42968	32.14	Ca	0	0	32.14	-	-	47.26	-15.12
.42968	40.04	Qp	0	0	40.04	57.26	-17.22	-	-
4.71368	22.32	Ca	0	.1	22.42	-	-	46	-23.58
4.71368	28.2	Qp	0	.1	28.3	56	-27.7	-	-
5.41568	20.86	Ca	0	.1	20.96	-	-	50	-29.04
5.41568	27.43	Qp	0	.1	27.53	60	-32.47	-	-
10.0916	18.96	Ca	0	.2	19.16	-	-	50	-30.84
10.0916	24.72	Qp	0	.2	24.92	60	-35.08	-	-
10.1038	19.11	Ca	0	.2	19.31	-	-	50	-30.69
10.1038	24.62	Qp	0	.2	24.82	60	-35.18	-	-

Ca - CISPR average detection

Qp - Quasi-Peak detector

LINE 2 RESULTS

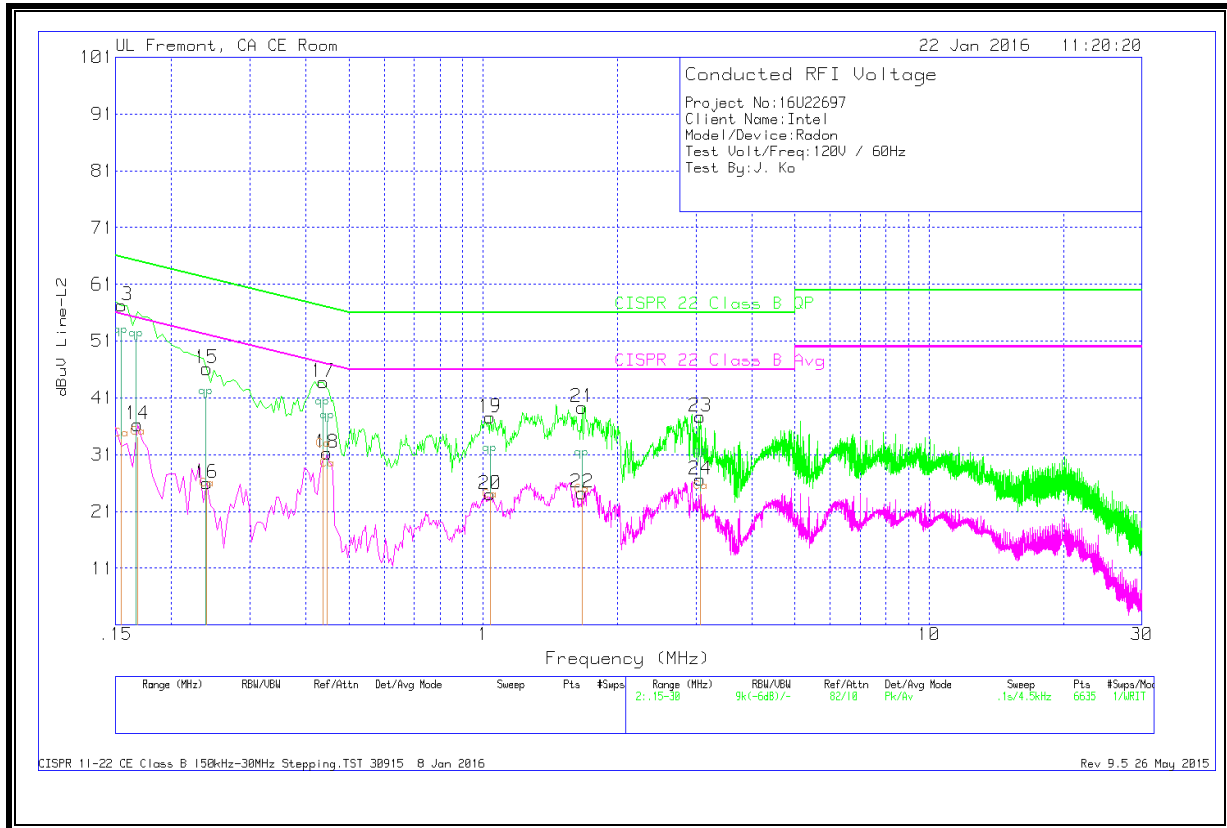

DATA

Range 2: Line-L2 .15 - 30MHz									
Frequency (MHz)	Meter Reading (dBuV)	Det	T1310 IL L2	LC Cables 2&3	Corrected Reading dBuV	CISPR 22 Class B QP	Margin (dB)	CISPR 22 Class B Avg	Margin (dB)
.15428	33.68	Ca	0	0	33.68	-	-	55.77	-22.09
.15428	51.98	Qp	0	0	51.98	65.77	-13.79	-	-
.16688	34.02	Ca	0	0	34.02	-	-	55.11	-21.09
.16688	51.26	Qp	0	0	51.26	65.11	-13.85	-	-
.23888	24.88	Ca	0	0	24.88	-	-	52.14	-27.26
.23888	41.2	Qp	0	0	41.2	62.14	-20.94	-	-
.43688	31.85	Ca	0	0	31.85	-	-	47.12	-15.27
.43688	39.36	Qp	0	0	39.36	57.12	-17.76	-	-
.44768	28.37	Ca	0	0	28.37	-	-	46.92	-18.55
.44768	36.87	Qp	0	0	36.87	56.92	-20.05	-	-
1.03718	22.95	Ca	0	0	22.95	-	-	46	-23.05
1.03718	31.16	Qp	0	0	31.16	56	-24.84	-	-
1.66628	23.74	Ca	0	.1	23.84	-	-	46	-22.16
1.66628	30.21	Qp	0	.1	30.31	56	-25.69	-	-
3.07163	24.3	Ca	0	.1	24.4	-	-	46	-21.6
3.07163	30.49	Qp	0	.1	30.59	56	-25.41	-	-

Ca - CISPR average detection

Qp - Quasi-Peak detector