



**FCC 47 CFR PART 15 SUBPART C
INDUSTRY CANADA RSS-247 ISSUE 1**

CERTIFICATION TEST REPORT

FOR

SMART WATCH with 802.11b/g/n, Bluetooth and BLE

MODEL NUMBER: SAR8A80

**FCC ID: 2AB8ZND11
IC: 1000X-ND11**

REPORT NUMBER: 15U21865-E1V1

ISSUE DATE: OCTOBER 12, 2015

Prepared for
**INTEL CORPORATION
2200 MISSION COLLEGE BOULEVARD,
SANTA CLARA, CA 95052, U.S.A**

Prepared by
**UL VERIFICATION SERVICES INC.
47173 BENICIA STREET
FREMONT, CA 94538, U.S.A.
TEL: (510) 771-1000
FAX: (510) 661-0888**



NVLAP LAB CODE 200065-0

Revision History

<u>Rev.</u>	<u>Issue Date</u>	<u>Revisions</u>	<u>Revised By</u>
V1	10/12/2015	Initial Issue	C. Pang

TABLE OF CONTENTS

1. ATTESTATION OF TEST RESULTS	5
2. TEST METHODOLOGY	6
3. FACILITIES AND ACCREDITATION	6
4. CALIBRATION AND UNCERTAINTY	6
4.1. <i>MEASURING INSTRUMENT CALIBRATION</i>	<i>6</i>
4.2. <i>SAMPLE CALCULATION</i>	<i>6</i>
4.3. <i>MEASUREMENT UNCERTAINTY.....</i>	<i>7</i>
5. EQUIPMENT UNDER TEST	8
5.1. <i>DESCRIPTION OF EUT</i>	<i>8</i>
5.2. <i>MAXIMUM OUTPUT POWER.....</i>	<i>8</i>
5.3. <i>DESCRIPTION OF AVAILABLE ANTENNAS</i>	<i>8</i>
5.4. <i>SOFTWARE AND FIRMWARE.....</i>	<i>8</i>
5.5. <i>WORST-CASE CONFIGURATION AND MODE.....</i>	<i>9</i>
5.6. <i>DESCRIPTION OF TEST SETUP.....</i>	<i>10</i>
6. TEST AND MEASUREMENT EQUIPMENT	15
7. ANTENNA PORT TEST RESULTS	16
7.1. <i>ON TIME AND DUTY CYCLE.....</i>	<i>16</i>
7.1.1. <i>ON TIME AND DUTY CYCLE RESULTS.....</i>	<i>16</i>
7.2. <i>BASIC DATA RATE GFSK MODULATION.....</i>	<i>18</i>
7.2.1. <i>20 dB AND 99% BANDWIDTH</i>	<i>18</i>
7.2.2. <i>HOPPING FREQUENCY SEPARATION</i>	<i>21</i>
7.2.3. <i>NUMBER OF HOPPING CHANNELS.....</i>	<i>23</i>
7.2.4. <i>AVERAGE TIME OF OCCUPANCY</i>	<i>27</i>
7.2.5. <i>OUTPUT POWER</i>	<i>31</i>
7.2.6. <i>AVERAGE POWER.....</i>	<i>34</i>
7.2.7. <i>CONDUCTED SPURIOUS EMISSIONS.....</i>	<i>35</i>
7.3. <i>ENHANCED DATA RATE QPSK MODULATION.....</i>	<i>40</i>
7.3.1. <i>OUTPUT POWER</i>	<i>40</i>
7.3.2. <i>AVERAGE POWER.....</i>	<i>43</i>
7.4. <i>ENHANCED DATA RATE 8PSK MODULATION</i>	<i>44</i>
7.4.1. <i>20 dB AND 99% BANDWIDTH</i>	<i>44</i>
7.4.2. <i>HOPPING FREQUENCY SEPARATION</i>	<i>47</i>
7.4.3. <i>NUMBER OF HOPPING CHANNELS.....</i>	<i>49</i>
7.4.4. <i>AVERAGE TIME OF OCCUPANCY</i>	<i>53</i>
7.4.5. <i>OUTPUT POWER</i>	<i>57</i>
7.4.6. <i>AVERAGE POWER.....</i>	<i>60</i>
7.4.7. <i>CONDUCTED SPURIOUS EMISSIONS.....</i>	<i>61</i>

8. RADIATED TEST RESULTS.....66

8.1. *LIMITS AND PROCEDURE.....66*

8.2. *TX ABOVE 1 GHz BASIC DATA RATE GFSK MODULATION67*

8.3. *TX ABOVE 1 GHz ENHANCED DATA RATE 8PSK MODULATION.....77*

8.4. *WORST-CASE BELOW 1 GHz.....87*

8.5. *WORST-CASE ABOVE 18 GHz89*

9. AC POWER LINE CONDUCTED EMISSIONS91

9.1. *EUT WITH AC ADAPTER.....92*

9.2. *EUT WITH USB LAPTOP96*

10. SETUP PHOTOS100

1. ATTESTATION OF TEST RESULTS

COMPANY NAME: INTEL CORPORATION
2200 MISSION COLLEGE BOULEVARD
SANTA CLARA, CA 95052, U.S.A.

EUT DESCRIPTION: SMART WATCH with 802.11b/g/n, Bluetooth and BLE

MODEL: SAR8A80

SERIAL NUMBER: GLDPD1FZ535008P (Conducted);
GLDPD1FZ535009V(Radiated)

DATE TESTED: SEPTEMBER 30TH – OCTOBER 10TH 2015

APPLICABLE STANDARDS	
STANDARD	TEST RESULTS
CFR 47 Part 15 Subpart C	Pass
INDUSTRY CANADA RSS-247 Issue 1	Pass
INDUSTRY CANADA RSS-GEN Issue 4	Pass

UL Verification Services Inc. tested the above equipment in accordance with the requirements set forth in the above standards. All indications of Pass/Fail in this report are opinions expressed by UL Verification Services Inc. based on interpretations and/or observations of test results. Measurement Uncertainties were not taken into account and are published for informational purposes only. The test results show that the equipment tested is capable of demonstrating compliance with the requirements as documented in this report.

Note: The results documented in this report apply only to the tested sample, under the conditions and modes of operation as described herein. This document may not be altered or revised in any way unless done so by UL Verification Services Inc. and all revisions are duly noted in the revisions section. Any alteration of this document not carried out by UL Verification Services Inc. will constitute fraud and shall nullify the document. This report must not be used by the client to claim product certification, approval, or endorsement by NVLAP, NIST, any agency of the Federal Government, or any agency of any government.

Approved & Released For
UL Verification Services Inc. By:

Tested By:



CHIN PANG
SENIOR ENGINEER
UL Verification Services Inc.

CLIFFORD SUSAS
EMC ENGINEER
UL Verification Services Inc.

2. TEST METHODOLOGY

The tests documented in this report were performed in accordance with FCC CFR 47 Part 2, FCC CFR 47 Part 15, ANSI C63.10-2013, RSS-GEN Issue 4, RSS-247 Issue 1.

3. FACILITIES AND ACCREDITATION

The test sites and measurement facilities used to collect data are located at 47173 and 47266 Benicia Street, Fremont, California, USA. Line conducted emissions are measured only at the 47173 address. The following table identifies which facilities were utilized for radiated emission measurements documented in this report. Specific facilities are also identified in the test results sections.

47173 Benicia Street	47266 Benicia Street
<input type="checkbox"/> Chamber A	<input type="checkbox"/> Chamber D
<input checked="" type="checkbox"/> Chamber B	<input type="checkbox"/> Chamber E
<input type="checkbox"/> Chamber C	<input type="checkbox"/> Chamber F
	<input checked="" type="checkbox"/> Chamber G
	<input type="checkbox"/> Chamber H

The above test sites and facilities are covered under FCC Test Firm Registration # 208313. Chambers A through H are covered under Industry Canada company address code 2324B with site numbers 2324B -1 through 2324B-8, respectively.

UL Verification Services Inc. is accredited by NVLAP, Laboratory Code 200065-0. The full scope of accreditation can be viewed at <http://ts.nist.gov/standards/scopes/2000650.htm>.

4. CALIBRATION AND UNCERTAINTY

4.1. MEASURING INSTRUMENT CALIBRATION

The measuring equipment utilized to perform the tests documented in this report has been calibrated in accordance with the manufacturer's recommendations, and is traceable to recognized national standards.

4.2. SAMPLE CALCULATION

Where relevant, the following sample calculation is provided:

$$\begin{aligned} \text{Field Strength (dBuV/m)} &= \text{Measured Voltage (dBuV)} + \text{Antenna Factor (dB/m)} + \\ &\text{Cable Loss (dB)} - \text{Preamp Gain (dB)} \\ 36.5 \text{ dBuV} + 18.7 \text{ dB/m} + 0.6 \text{ dB} - 26.9 \text{ dB} &= 28.9 \text{ dBuV/m} \end{aligned}$$

4.3. MEASUREMENT UNCERTAINTY

Where relevant, the following measurement uncertainty levels have been estimated for tests performed on the apparatus:

PARAMETER	UNCERTAINTY
Conducted Disturbance, 0.15 to 30 MHz	± 3.52 dB
Radiated Disturbance, 30 to 1000 MHz	± 4.94 dB
Radiated Disturbance, 1 to 6 GHz	± 3.86 dB
Radiated Disturbance, 6 to 18 GHz	± 4.23 dB
Radiated Disturbance, 18 to 26 GHz	± 5.30 dB
Radiated Disturbance, 26 to 40 GHz	± 5.23 dB

Uncertainty figures are valid to a confidence level of 95%.

5. EQUIPMENT UNDER TEST

5.1. DESCRIPTION OF EUT

The EUT is a smart watch with SMART WATCH with 802.11b/g/n, Bluetooth and BLE

5.2. MAXIMUM OUTPUT POWER

The transmitter has a maximum peak conducted output power as follows:

Frequency Range (MHz)	Mode	Output Power (dBm)	Output Power (mW)
2402 - 2480	Basic GFSK	11.83	15.24
2402 - 2480	DQPSK	9.37	8.65
2402 - 2480	Enhanced 8PSK	9.77	9.48

5.3. DESCRIPTION OF AVAILABLE ANTENNAS

The radio utilizes a trace antenna, with a maximum gain of 0 dBi.

5.4. SOFTWARE AND FIRMWARE

The firmware installed in the EUT during testing was DVT Eng. Build.

5.5. WORST-CASE CONFIGURATION AND MODE

Radiated emission and power line conducted emission were performed with the EUT set to transmit at the channel with highest output power as worst-case scenario.

The fundamental of the EUT was investigated in three orthogonal orientations X, Y and Z, it was determined that Z orientation was worst-case orientation; therefore, all final radiated testing was performed with the EUT in Z orientation.

5.6. DESCRIPTION OF TEST SETUP

SUPPORT EQUIPMENT

Support Equipment List				
Description	Manufacturer	Model	Serial Number	FCC ID
Laptop	Lenovo	Yoga 2 11	YB04282152	N/A
AC adapter	Lenovo	ADLX45NCC3A	11S45N0297Z1ZSH443G0XE	N/A

I/O CABLES

I/O Cable List						
Cable No	Port	# of identical ports	Connector Type	Cable Type	Cable Length (m)	Remarks
1	AC	1	3-Prong	Un-Shielded	1.8	N/A
2	DC	1	DC	Un-Shielded	1	N/A
3	USB	1	USB	Un-Shielded	0.9	Laptop to EUT
4	Antenna	1	SMA	Shielded	0.3	EUT to spectrum Analyzer
5	AC/DC	1	USB Micro	Un-Shielded	0.9	

TEST SETUP

Test software exercised the radio card.

SETUP DIAGRAM FOR CONDUCTED TESTS

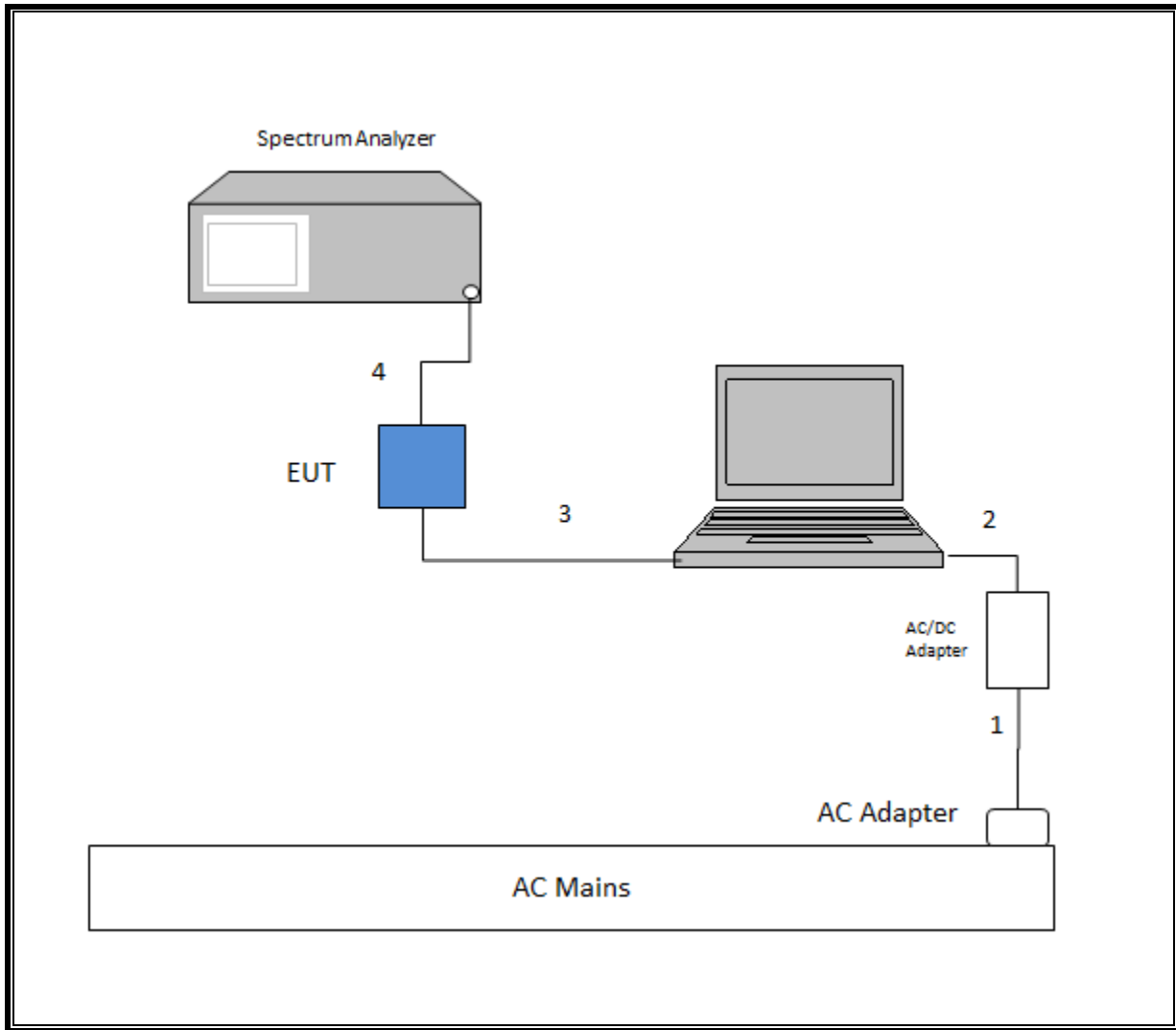

SETUP DIAGRAM FOR RADIATED TESTS

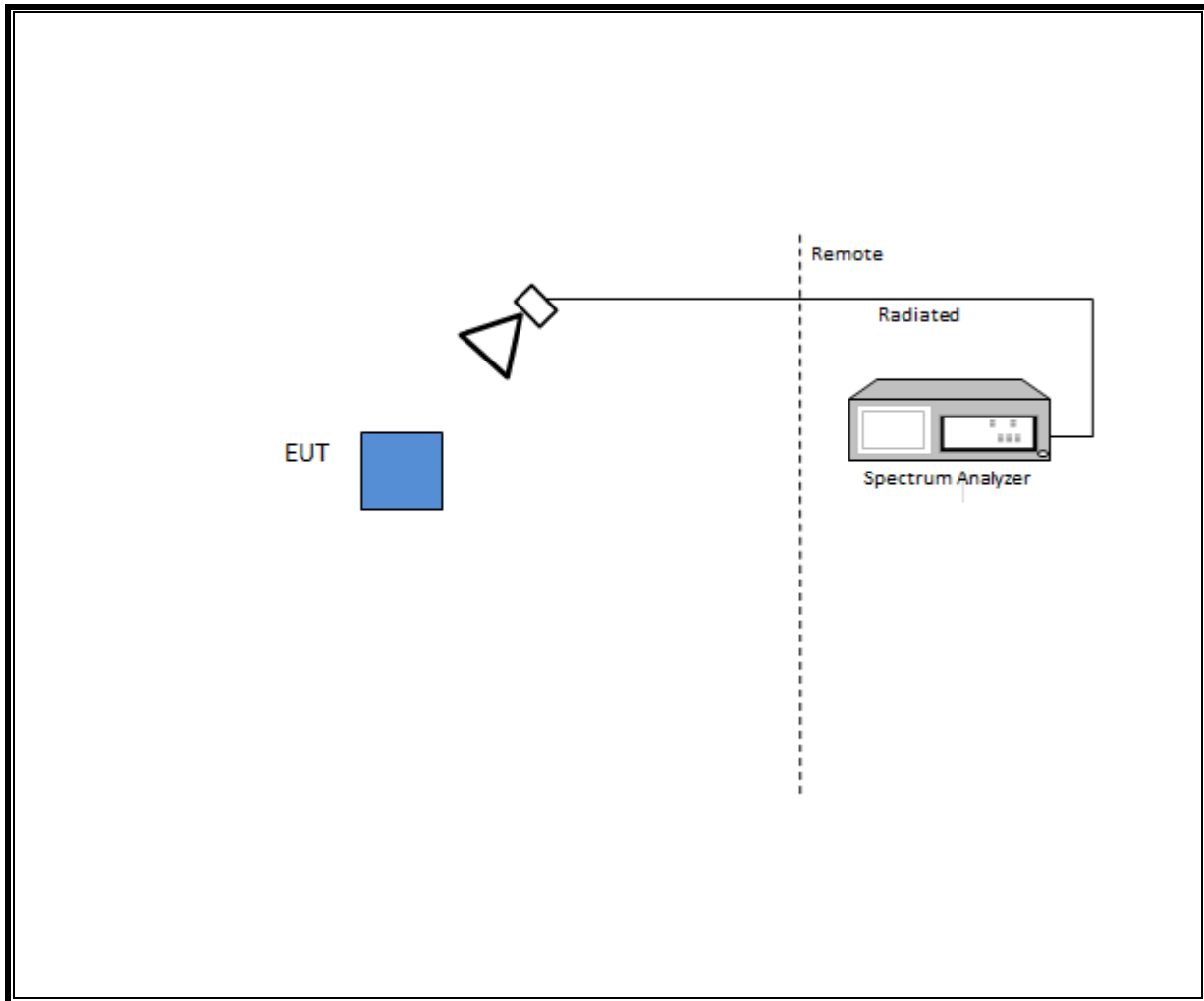

SETUP DIAGRAM 1 FOR LINE CONDUCTED TEST

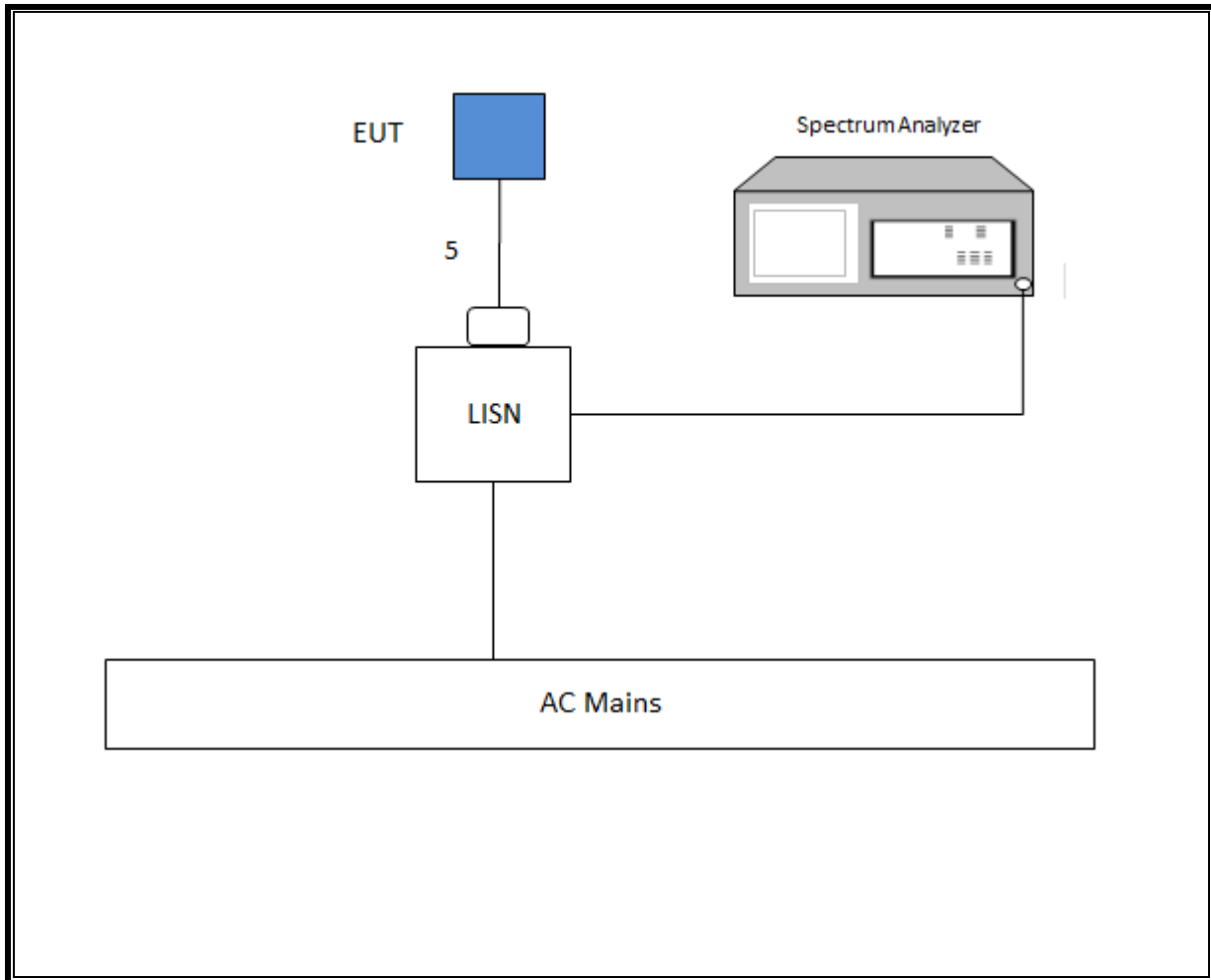

SETUP DIAGRAM 2 FOR LINE CONDUCTED TEST

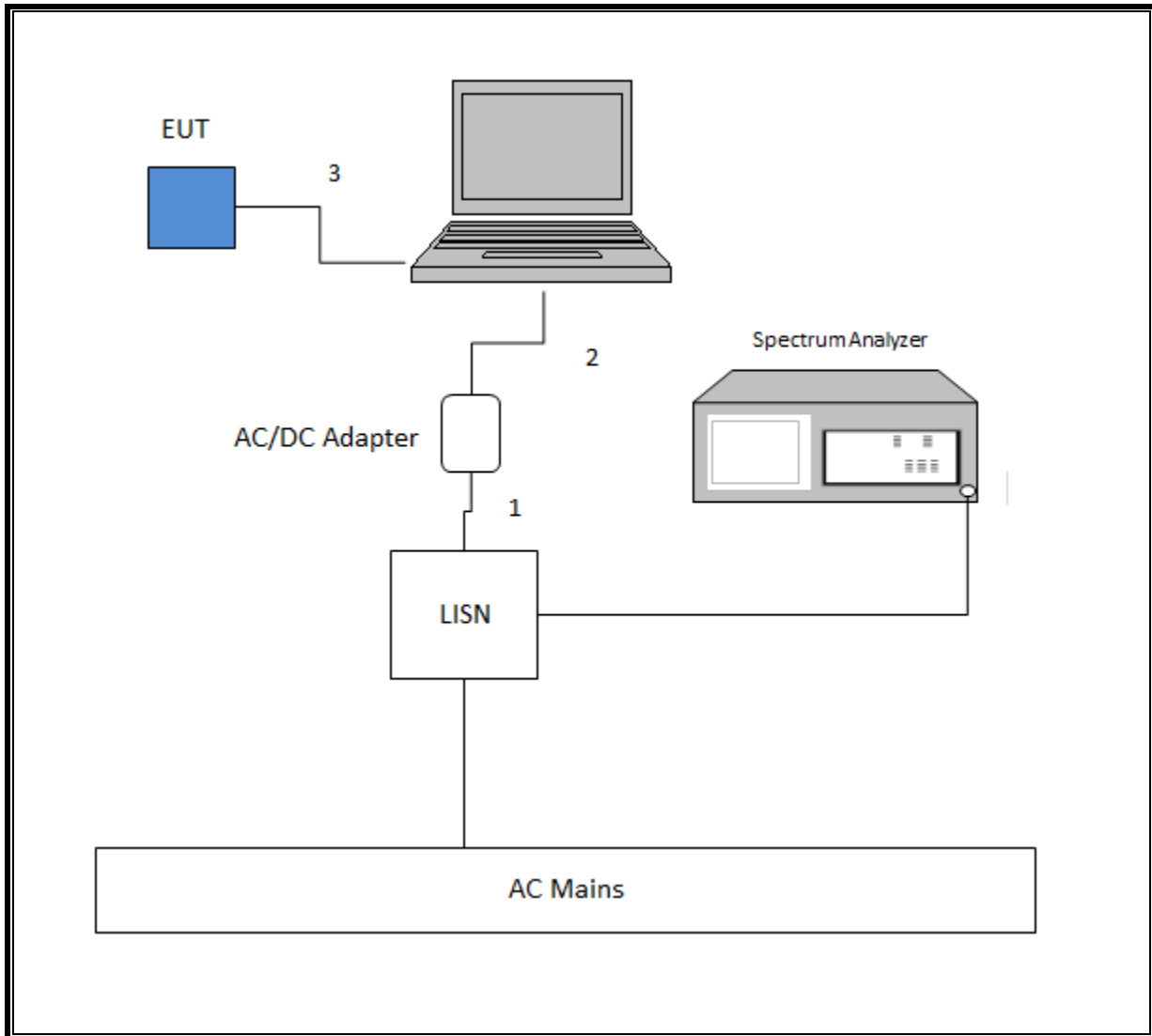

6. TEST AND MEASUREMENT EQUIPMENT

The following test and measurement equipment was utilized for the tests documented in this report:

Test Equipment List					
Description	Manufacturer	Model	T No.	Cal Date	Cal Due
Radiated Software	UL	UL EMC	Ver 9.5, June 24, 2015		
Conducted Software	UL	UL EMC	Ver 3.5		
Spectrum Analyzer, PXA, 3Hz to 44GHz	Keysight	N9030A	342	06/29/15	06/29/16
Spectrum Analyzer, PXA, 3Hz to 44GHz	Keysight	N9030A	905	06/16/15	05/26/16
Antenna, Horn 1-18GHz	ETS Lindgren	3117	862	04/10/15	04/10/16
Antenna, Broadband Hybrid, 30 to 2000MHz	Sunol Sciences	JB3	899	04/30/15	04/30/16
Filter, HPF, 3.0GHz	Micro-Tronics	HPM17543	898	04/25/15	04/25/16
Amplifier, 1-18GHz	Miteq	AFS42-00101800-25-S-42	491	04/25/15	04/25/16
Amplifier, 10kHz to 1GHz, 32dB	Sonoma	310N	834	06/08/15	06/08/16
Power Meter	Keysight	N1911A	1244	07/02/15	07/02/16
Power Sensor	Keysight	N1921A	1228	07/06/15	07/06/16
LISN, 30MHz	FCC	50/250-25-2	24	01/16/15	01/16/16
EMI Test Receiver, 9kHz to 7GHz	Rhode & Schwarz	ESCI 7	212	08/07/15	08/07/16

7. ANTENNA PORT TEST RESULTS

7.1. ON TIME AND DUTY CYCLE

LIMITS

None; for reporting purposes only.

PROCEDURE

KDB 558074 Zero-Span Spectrum Analyzer Method.

7.1.1. ON TIME AND DUTY CYCLE RESULTS

Mode	ON Time B (msec)	Period (msec)	Duty Cycle x (linear)	Duty Cycle (%)	Duty Cycle Correction Factor (dB)	1/B Minimum VBW (kHz)
2.4 GHz band						
Bluetooth GFSK	2.884	3.750	0.769	76.91%	1.14	0.347
Bluetooth 8PSK	2.886	3.744	0.771	77.08%	1.13	0.347

DUTY CYCLE PLOTS

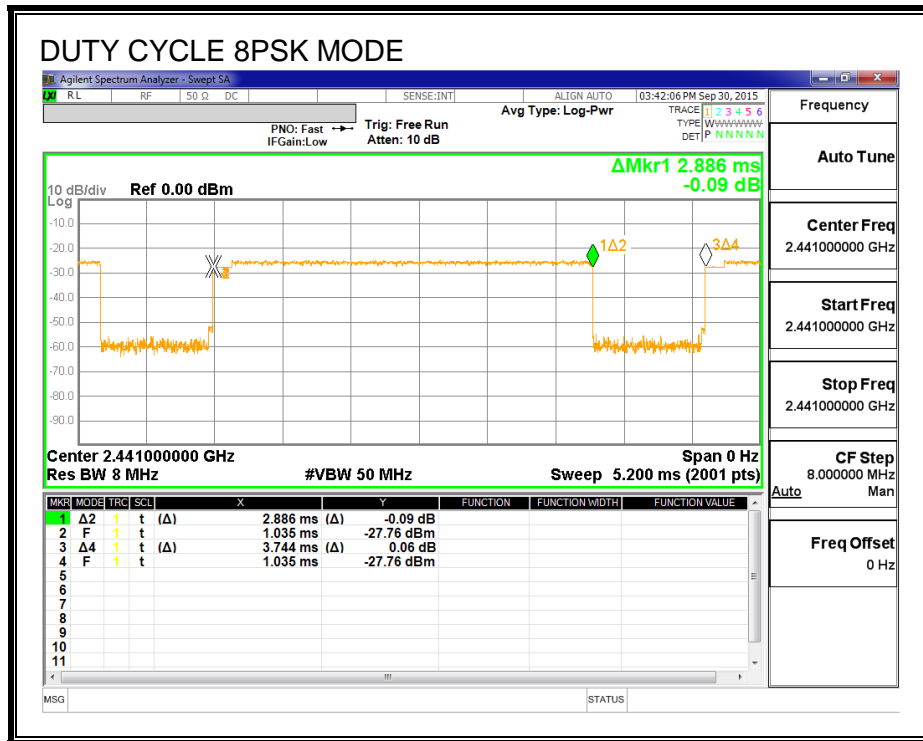
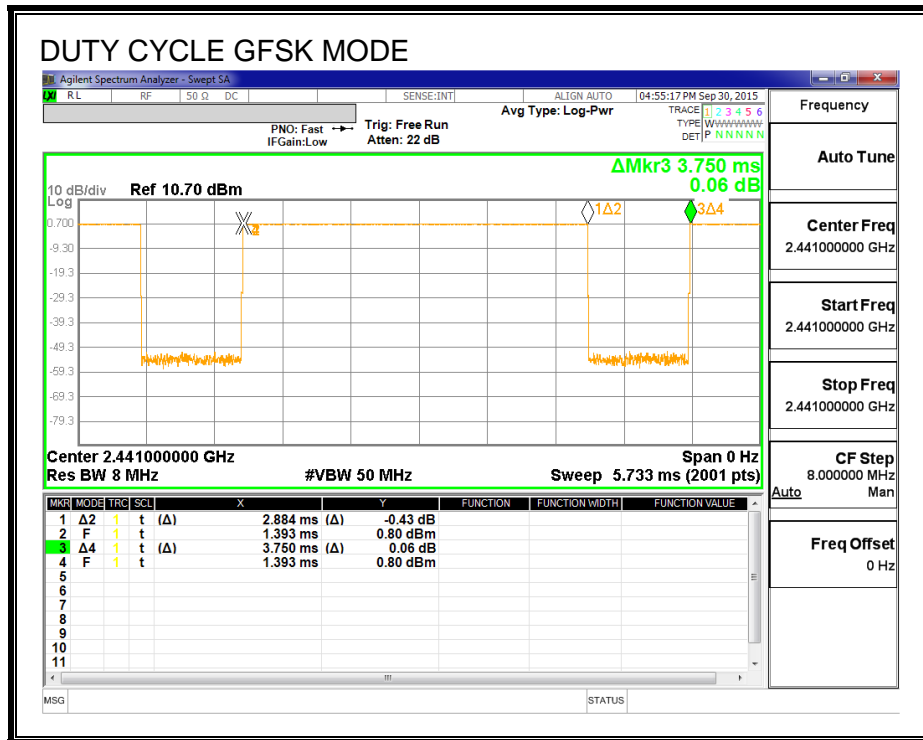

7.2. BASIC DATA RATE GFSK MODULATION

7.2.1. 20 dB AND 99% BANDWIDTH

GFSK MODULATION

LIMIT

None; for reporting purposes only.

TEST PROCEDURE

The transmitter output is connected to a spectrum analyzer. The RBW is set to $\geq 1\%$ of the 20 dB bandwidth. The VBW is set to \geq RBW. The sweep time is coupled.

RESULTS

Channel	Frequency (MHz)	20 dB Bandwidth (kHz)	99% Bandwidth (kHz)
Low	2402	931.6	908.44
Middle	2441	927.6	934.27
High	2480	860.6	877.46

20 dB AND 99% BANDWIDTH

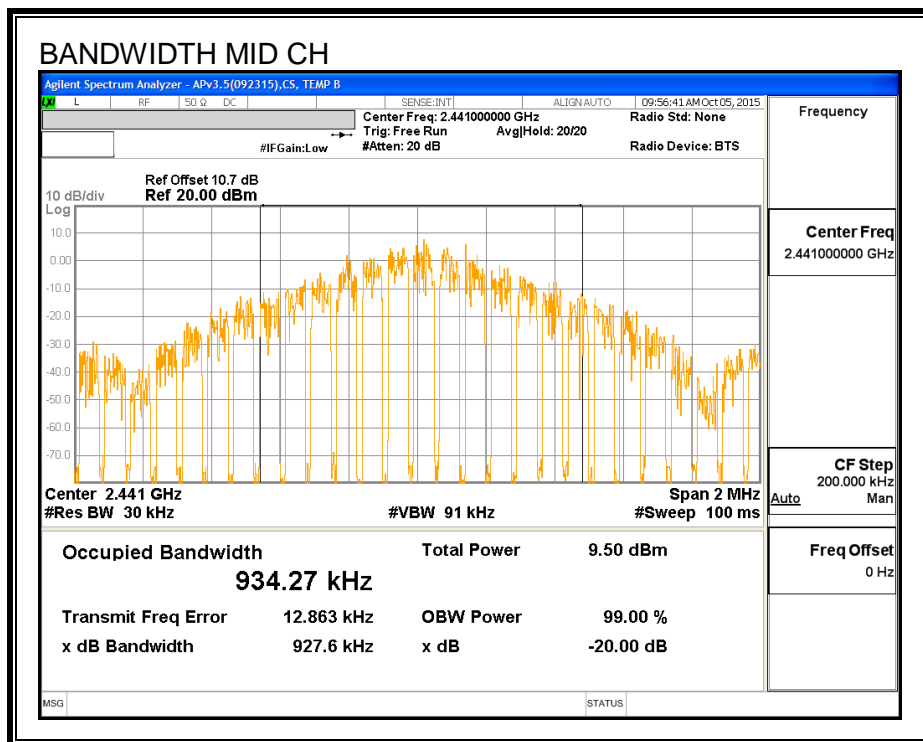
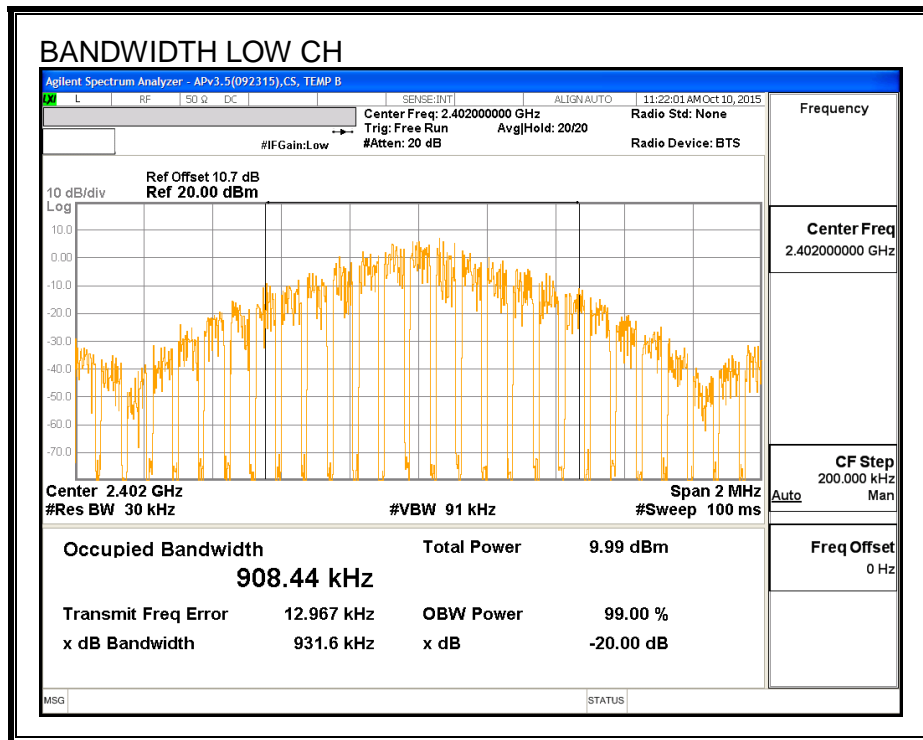

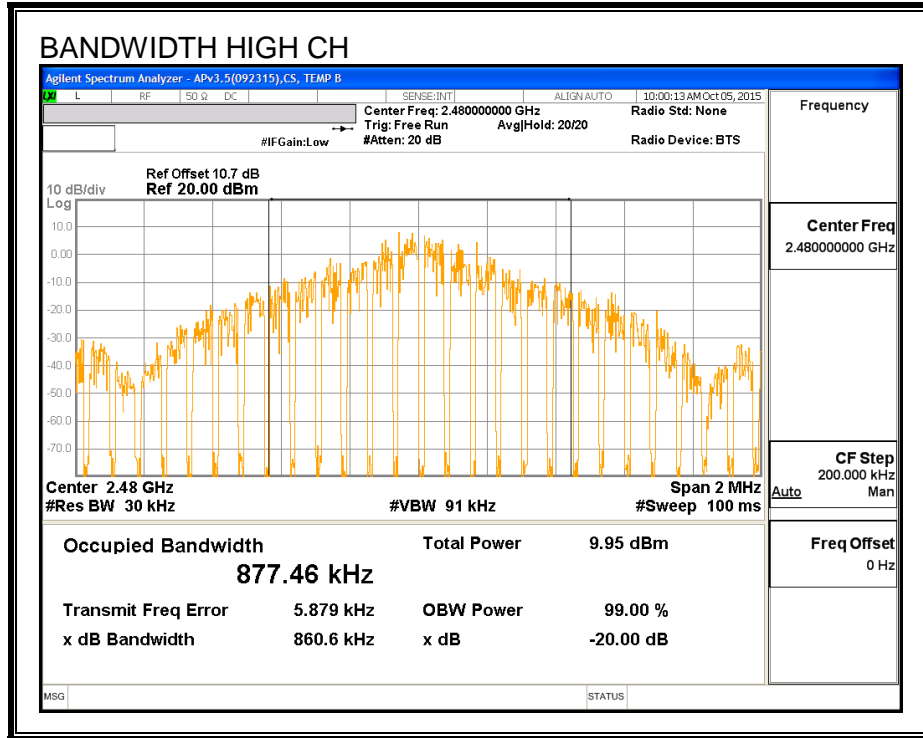

7.2.2. HOPPING FREQUENCY SEPARATION

LIMIT

FCC §15.247 (a) (1)

IC RSS-247 (5.1) (2)

Frequency hopping systems shall have hopping channel carrier frequencies separated by a minimum of 25 kHz or the 20 dB bandwidth of the hopping channel, whichever is greater.

Alternatively, frequency hopping systems operating in the 2400-2483.5 MHz band may have hopping channel carrier frequencies that are separated by 25 kHz or two-thirds of the 20 dB bandwidth of the hopping channel, whichever is greater, provided the systems operate with an output power no greater than 125 mW.

TEST PROCEDURE

The transmitter output is connected to a spectrum analyzer. The RBW is set to 300 kHz and the VBW is set to 910 kHz. The sweep time is coupled.

RESULTS

HOPPING FREQUENCY SEPARATION

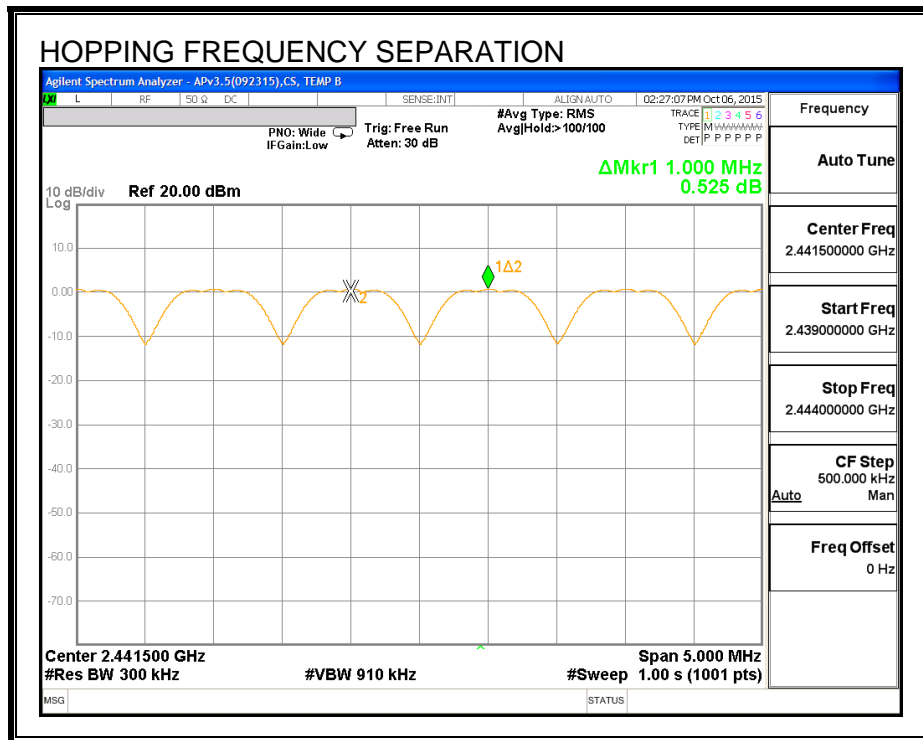

7.2.3. NUMBER OF HOPPING CHANNELS

LIMIT

FCC §15.247 (a) (1) (iii)

IC RSS-247 (5.1) (4)

Frequency hopping systems in the 2400 – 2483.5 MHz band shall use at least 15 non-overlapping channels.

TEST PROCEDURE

The transmitter output is connected to a spectrum analyzer. The span is set to cover the entire authorized band, in either a single sweep or in multiple contiguous sweeps. The RBW is set to a maximum of 1 % of the span. The analyzer is set to Max Hold.

RESULTS

Normal Mode: 79 Channels observed.

NUMBER OF HOPPING CHANNELS

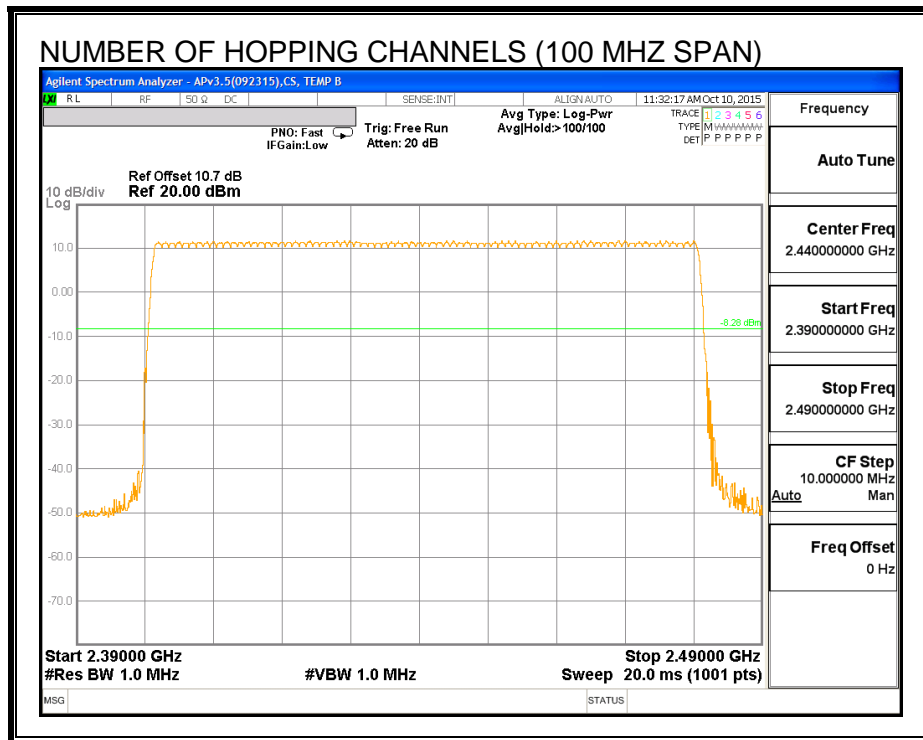

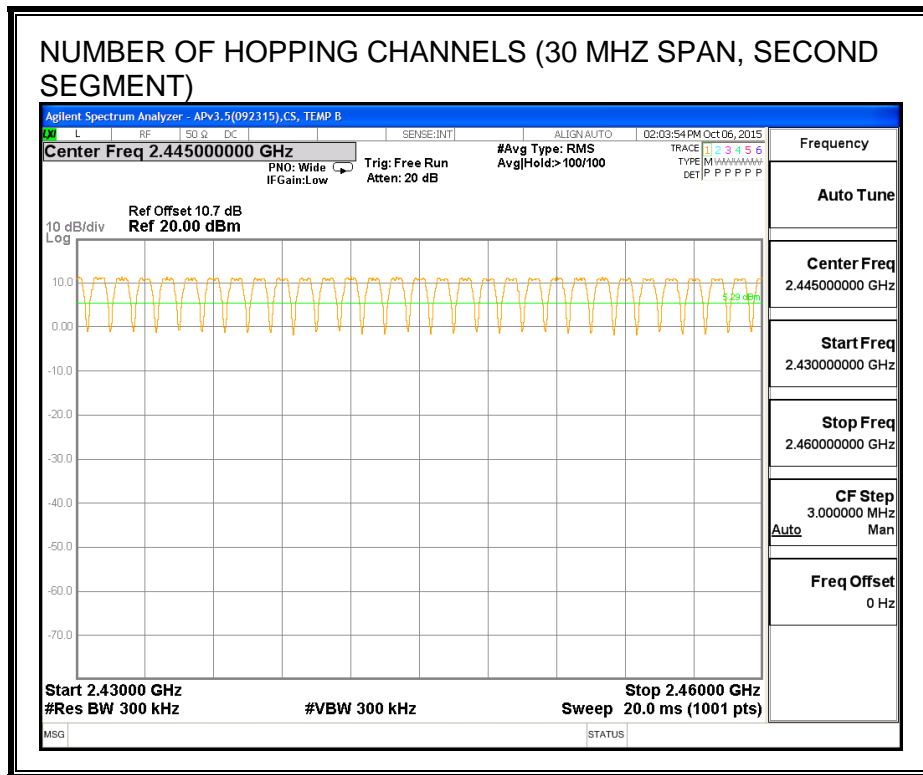
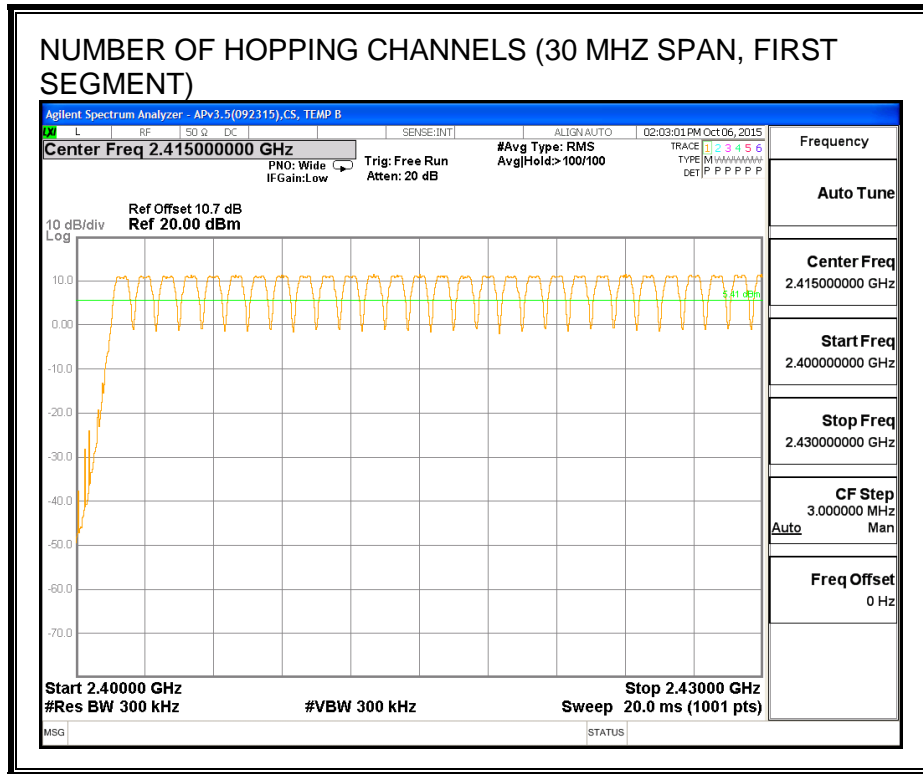

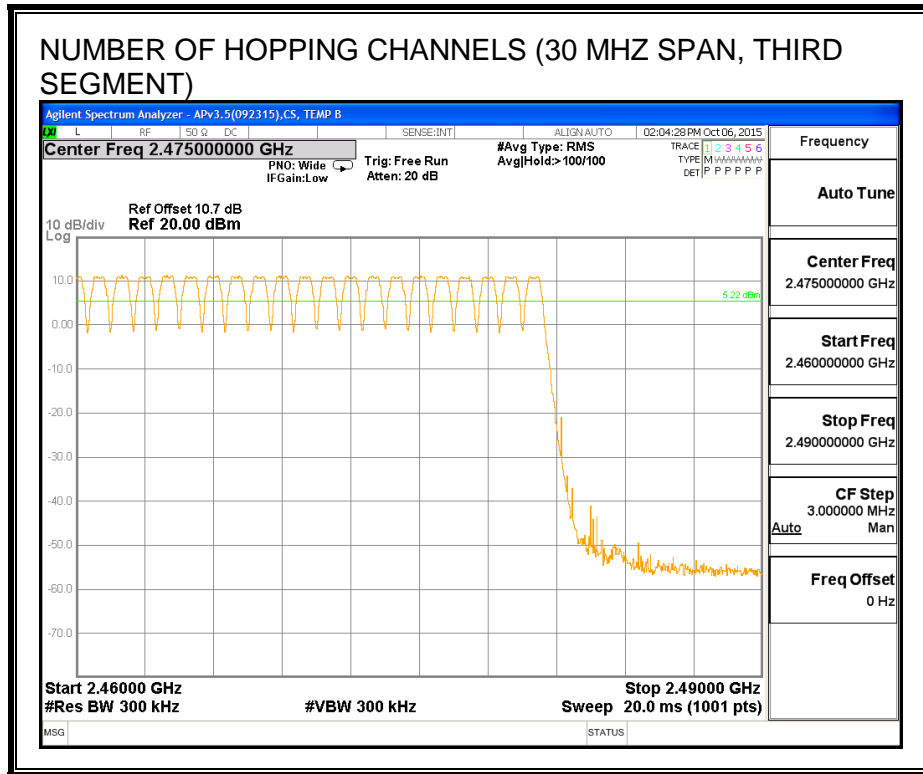

7.2.4. AVERAGE TIME OF OCCUPANCY

LIMIT

FCC §15.247 (a) (1) (iii)

IC RSS-247 (5.1) (4)

The average time of occupancy on any channel shall not be greater than 0.4 seconds within a period of 0.4 seconds multiplied by the number of hopping channels employed.

TEST PROCEDURE

The transmitter output is connected to a spectrum analyzer. The span is set to 0 Hz, centered on a single, selected hopping channel. The width of a single pulse is measured in a fast scan. The number of pulses is measured in a 3.16 second scan, to enable resolution of each occurrence.

The average time of occupancy in the specified 31.6 second period (79 channels * 0.4 s) is equal to $10 * (\# \text{ of pulses in } 3.16 \text{ s}) * \text{ pulse width}$.

For AFH mode, the average time of occupancy in the specified 8 second period (20 channels * 0.4 seconds) is equal to $10 * (\# \text{ of pulses in } 0.8 \text{ s}) * \text{ pulse width}$.

RESULTS

DH Packet	Pulse Width (msec)	Number of Pulses in 3.16 seconds	Average Time of Occupancy (sec)	Limit (sec)	Margin (sec)
GFSK Normal Mode					
DH1	0.319	9	0.029	0.4	-0.371
DH3	1.676	13	0.218	0.4	-0.182
DH5	2.888	10	0.289	0.4	-0.111
GFSK AFH Mode					
DH Packet	Pulse Width (msec)	Number of Pulses in 0.8 seconds	Average Time of Occupancy (sec)	Limit (sec)	Margin (sec)
DH1	0.319	2.25	0.007	0.4	-0.393
DH3	1.676	3.25	0.054	0.4	-0.346
DH5	2.888	2.5	0.072	0.4	-0.328

PULSE WIDTH - DH1

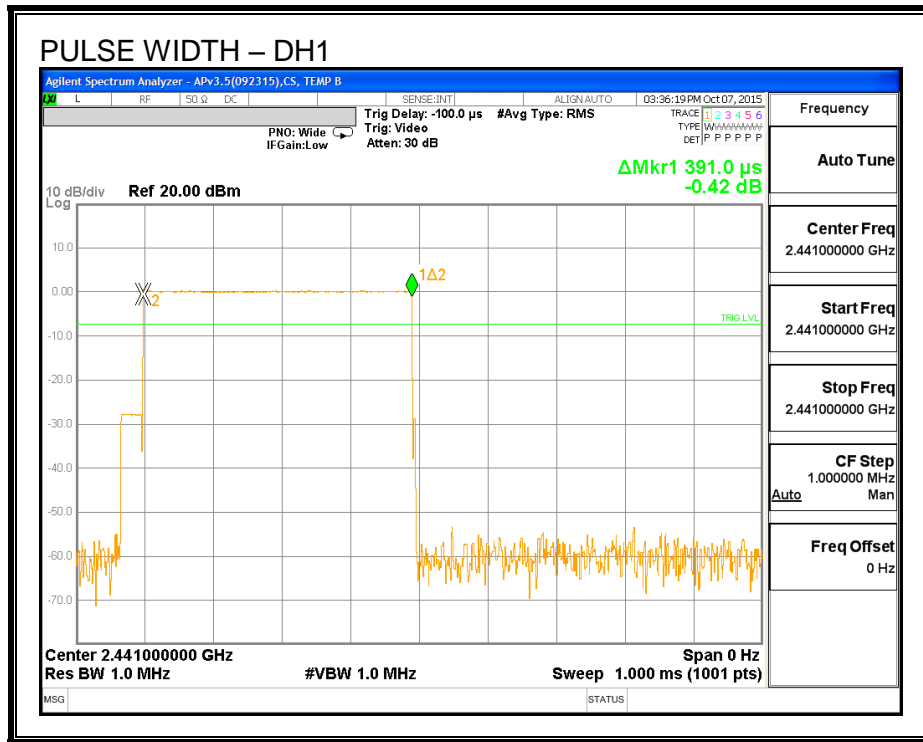

NUMBER OF PULSES IN 3.16 SECOND OBSERVATION PERIOD – DH1

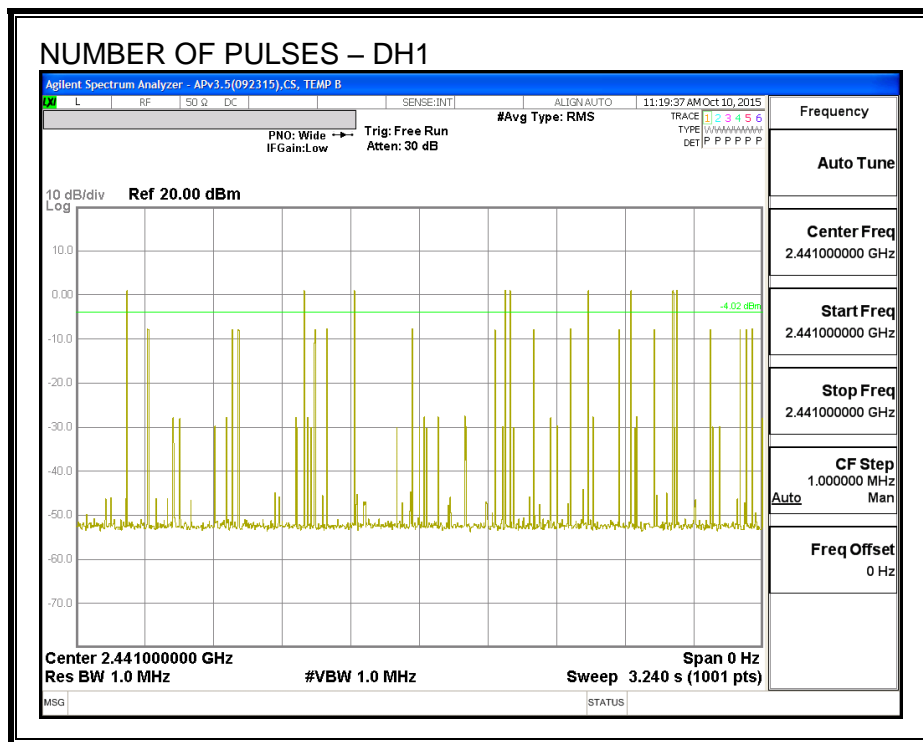

PULSE WIDTH – DH3

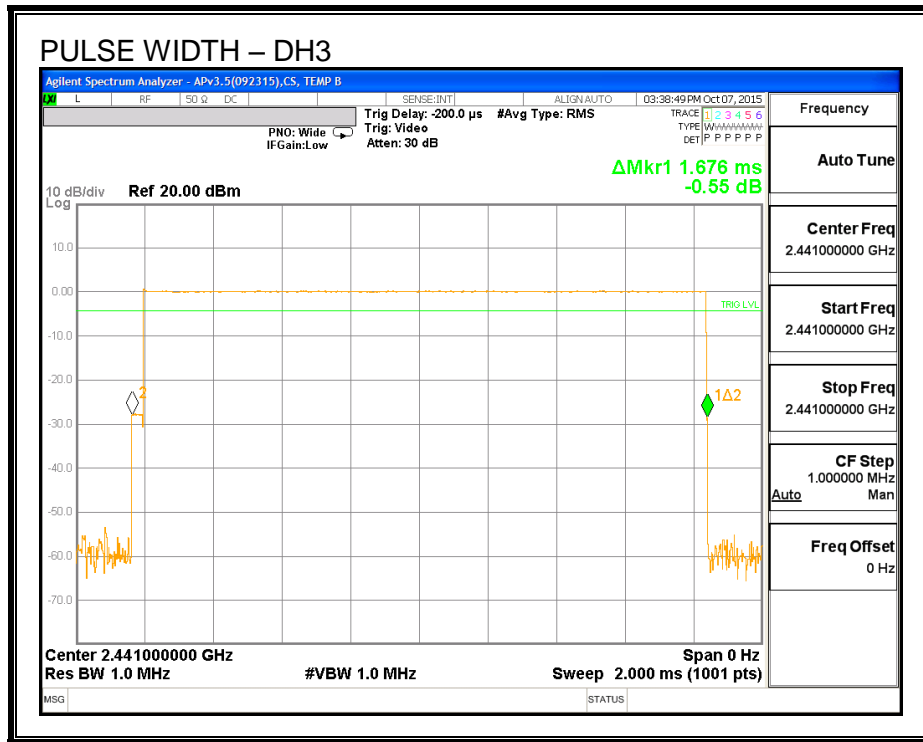

NUMBER OF PULSES IN 3.16 SECOND OBSERVATION PERIOD – DH3

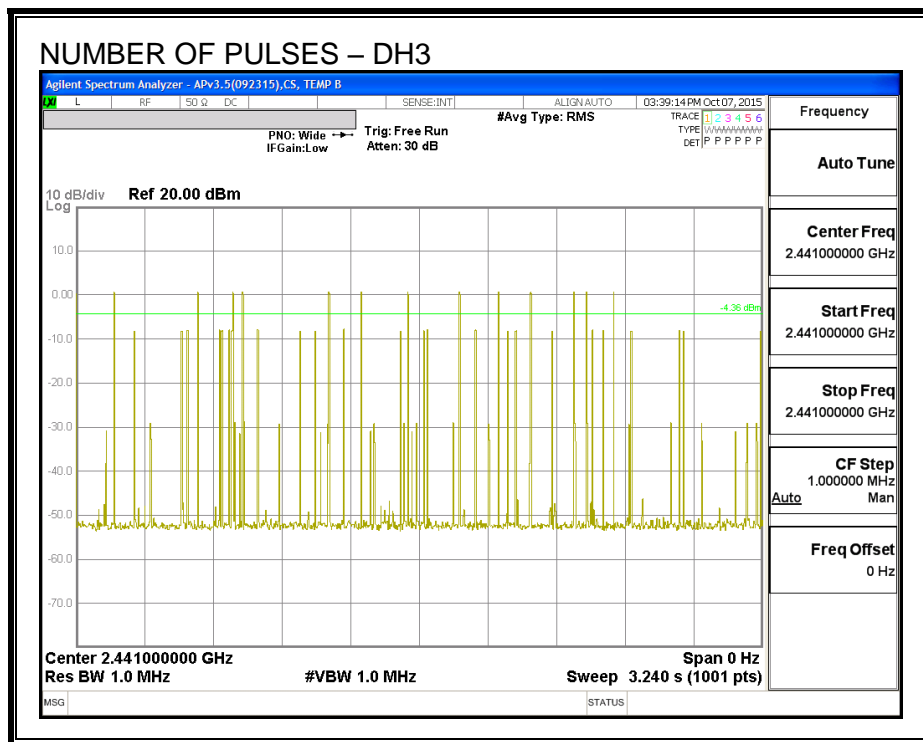

PULSE WIDTH – DH5

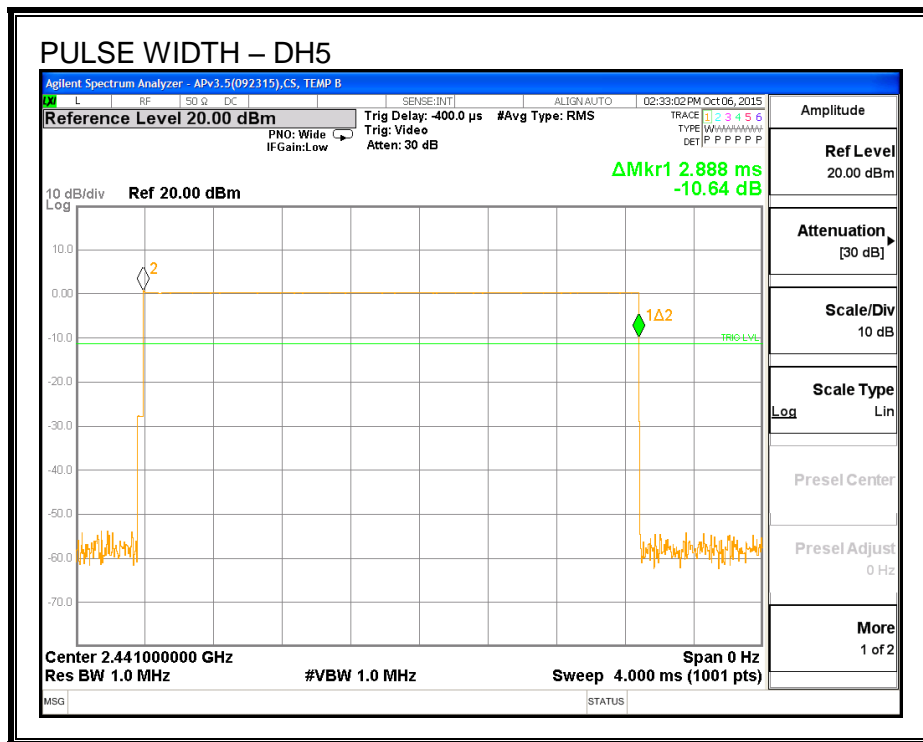

NUMBER OF PULSES IN 3.16 SECOND OBSERVATION PERIOD – DH5

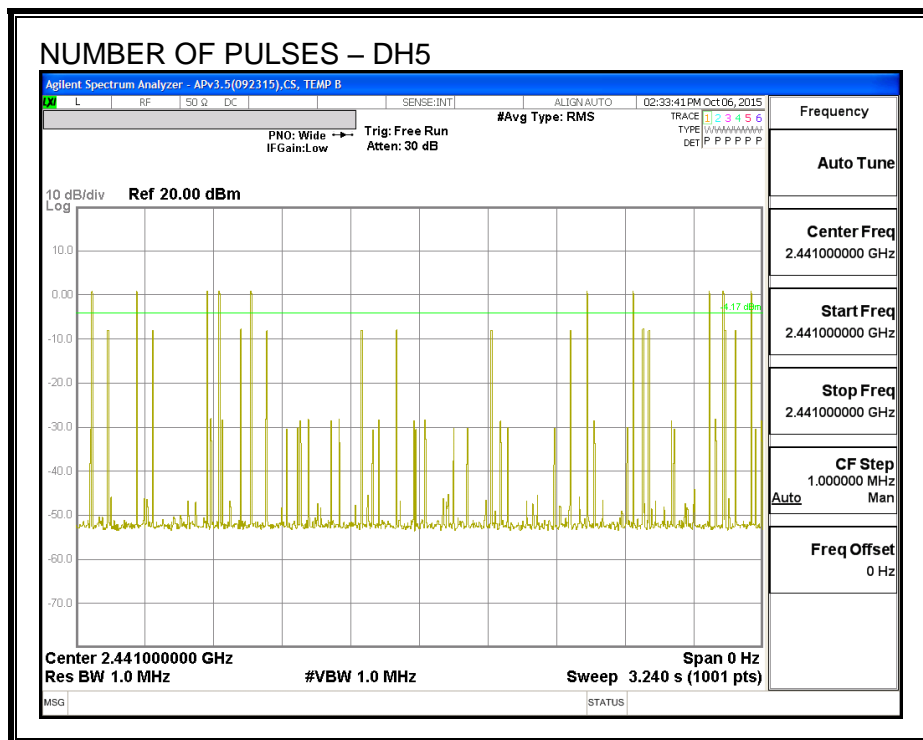

7.2.5. OUTPUT POWER

LIMIT

§15.247 (b) (1)

IC RSS-247 (5.1) (2)

The maximum antenna gain is less than 6 dBi, therefore the limit is 30 dBm.

TEST PROCEDURE

The transmitter output is connected to a spectrum analyzer the analyzer bandwidth is set to a value greater than the 20 dB bandwidth of the EUT.

RESULTS

Channel	Frequency (MHz)	Output Power (dBm)	Directional Gain (dBi)	Limit (dBm)	Margin (dB)
Low	2402	11.61	0.00	30	-18.39
Middle	2441	11.81	0.00	30	-18.19
High	2480	11.83	0.00	30	-18.18

OUTPUT POWER

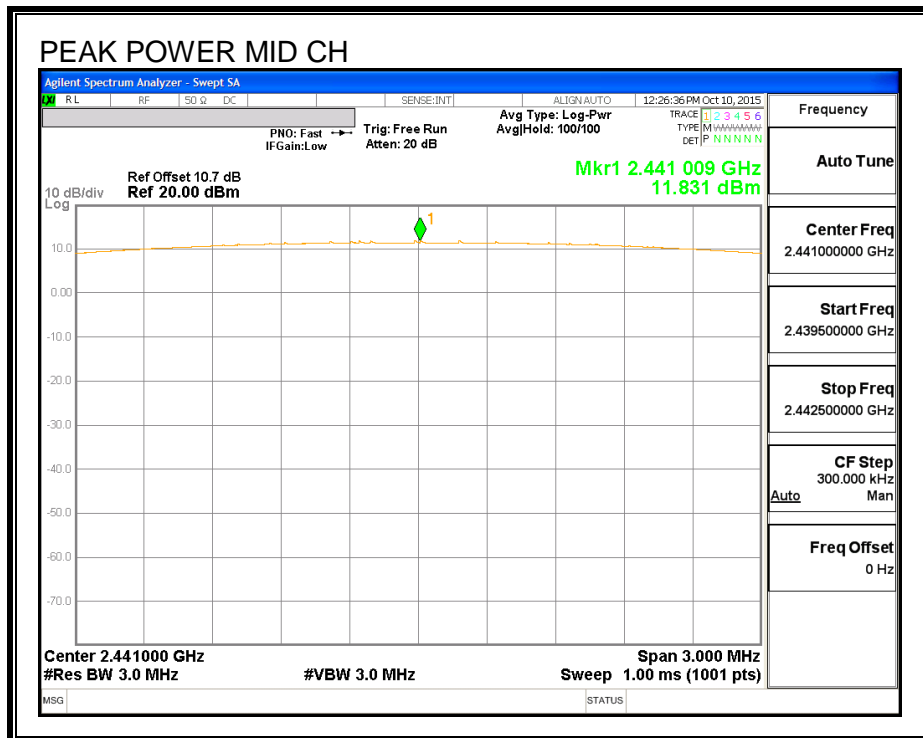
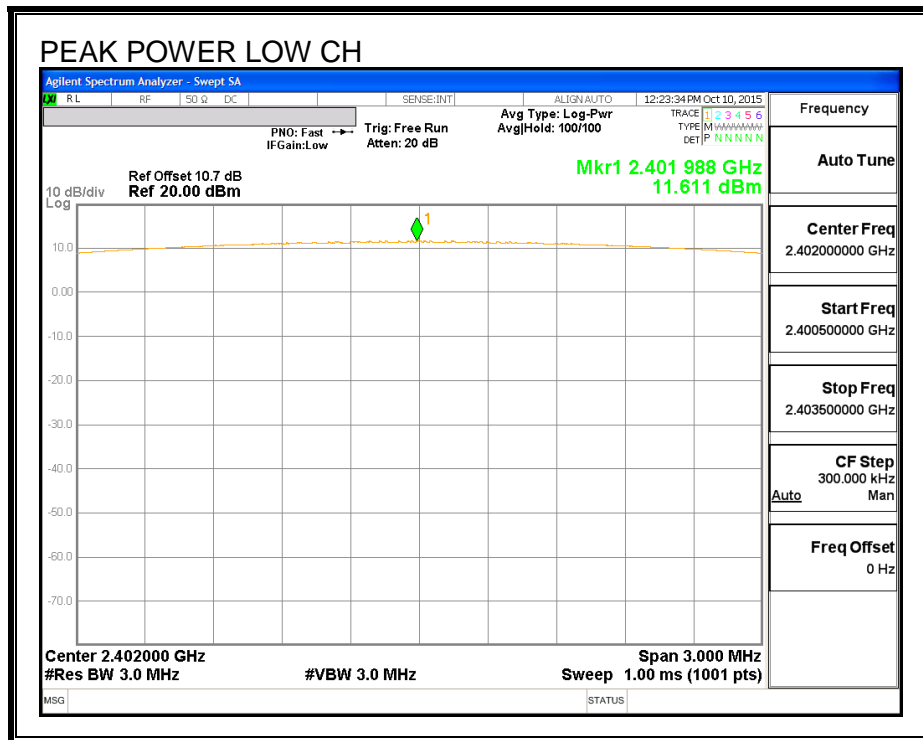

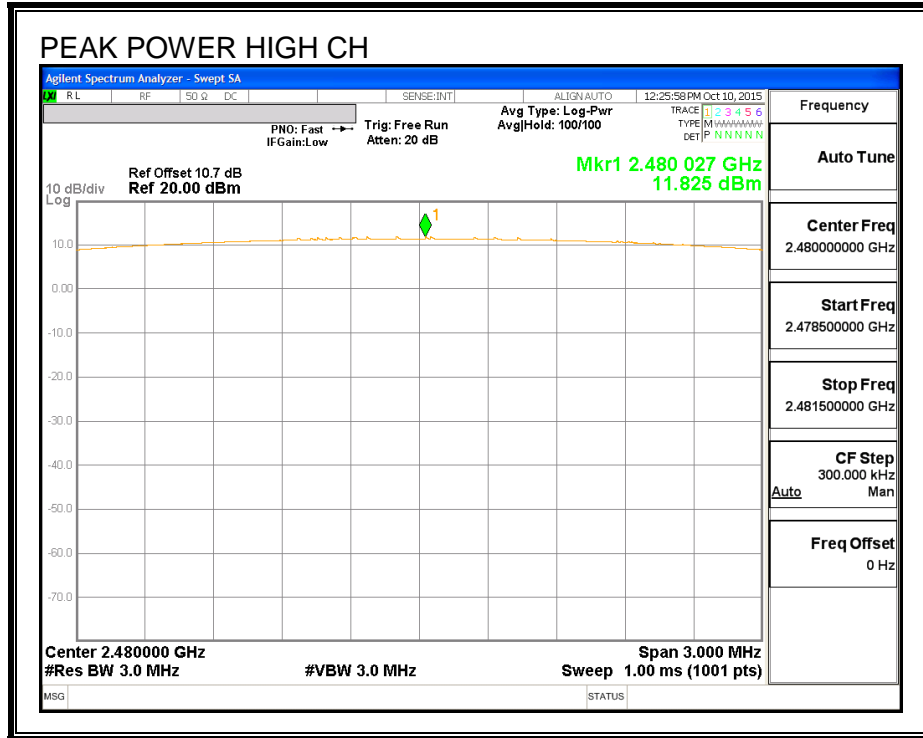

7.2.6. AVERAGE POWER

LIMIT

None; for reporting purposes only.

TEST PROCEDURE

The transmitter output is connected to a power meter.

RESULTS

The cable assembly insertion loss of 10.7 dB (including 10 dB pad and 0.7 dB cable) was entered as an offset in the power meter to allow for direct reading of power.

Channel	Frequency (MHz)	Average Power (dBm)
Low	2402	10.73
Middle	2441	10.71
High	2480	10.66

7.2.7. CONDUCTED SPURIOUS EMISSIONS

LIMITS

FCC §15.247 (d)

In any 100 kHz bandwidth outside the frequency band in which the spread spectrum or digitally modulated intentional radiator is operating, the radio frequency power that is produced by the intentional radiator shall be at least 20 dB below that in the 100 kHz bandwidth within the band that contains the highest level of the desired power, based on either an RF conducted or a radiated measurement, provided the transmitter demonstrates compliance with the peak conducted power limits. If the transmitter complies with the conducted power limits based on the use of RMS averaging over a time interval, as permitted under paragraph (b)(3) of this section, the attenuation required under this paragraph shall be 30 dB instead of 20 dB. Attenuation below the general limits specified in §15.209(a) is not required. In addition, radiated emissions which fall in the restricted bands, as defined in §15.205(a), must also comply with the radiated emission limits specified in §15.209(a) (see §15.205(c)).

IC RSS-210 A8.5

In any 100 kHz bandwidth outside the frequency band in which the spread spectrum or digitally modulated device is operating, the RF power that is produced shall be at least 20 dB below that in the 100 kHz bandwidth within the band that contains the highest level of the desired power, based on either an RF conducted or a radiated measurement, provided that the transmitter demonstrates compliance with the peak conducted power limits. If the transmitter complies with the conducted power limits based on the use of root-mean-square averaging over a time interval, as permitted under Section A8.4 (4), the attenuation required shall be 30 dB instead of 20 dB. Attenuation below the general field strength limits specified in RSS-Gen is not required.

TEST PROCEDURE

The transmitter output is connected to a spectrum analyzer. The resolution bandwidth is set to 100 kHz. The video bandwidth is set to 300 kHz.

The spectrum from 30 MHz to 26 GHz is investigated with the transmitter set to the lowest, middle, and highest channels.

The bandedges at 2.4 and 2.4835 GHz are investigated with the transmitter set to the normal hopping mode.

RESULTS

SPURIOUS EMISSIONS, LOW CHANNEL

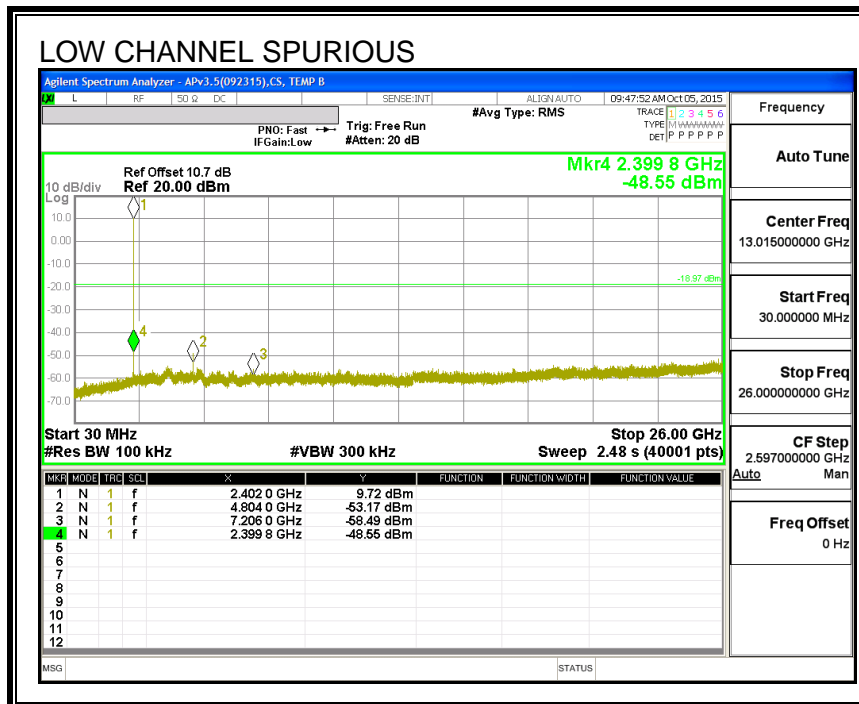
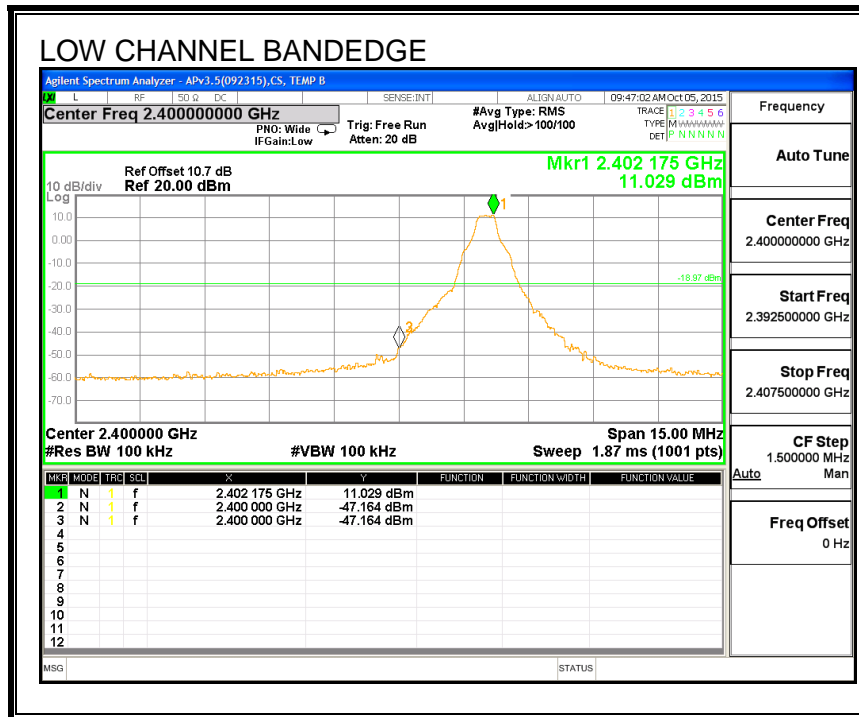

SPURIOUS EMISSIONS, MID CHANNEL

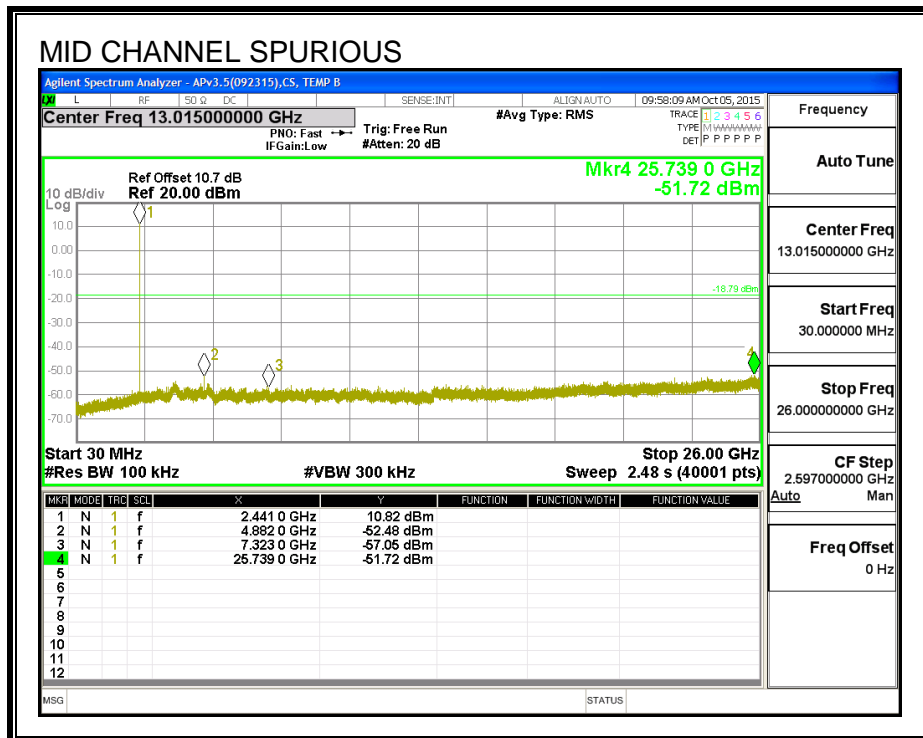
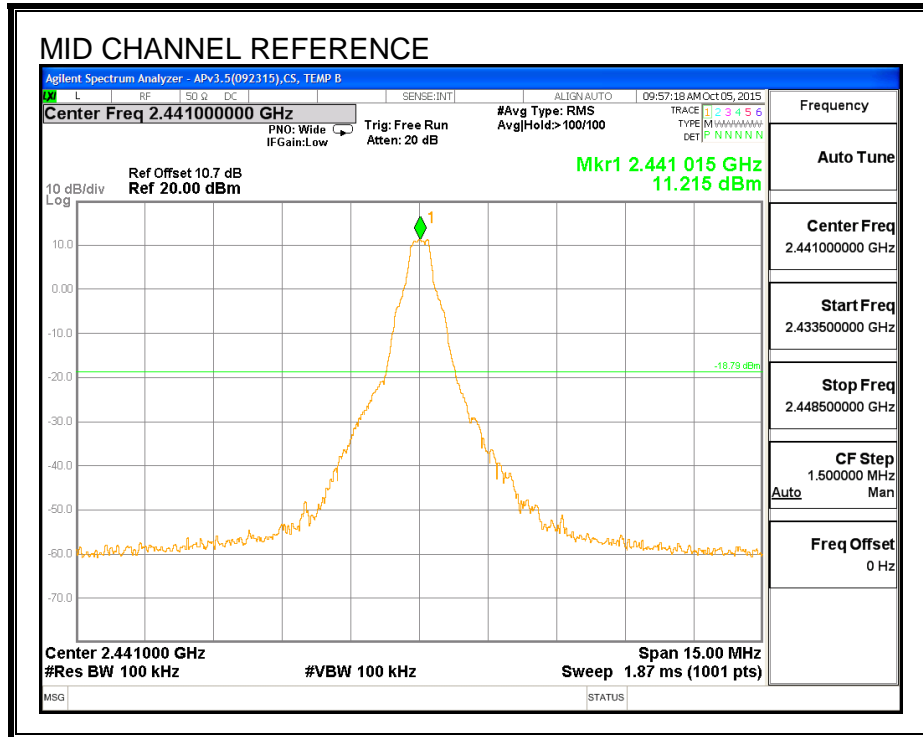

SPURIOUS EMISSIONS, HIGH CHANNEL

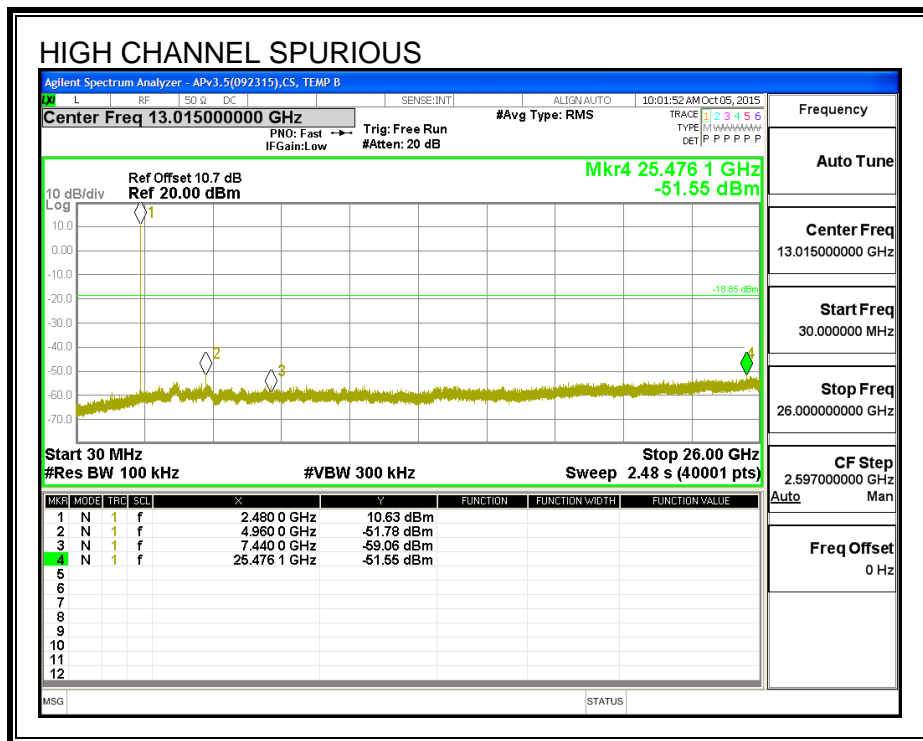
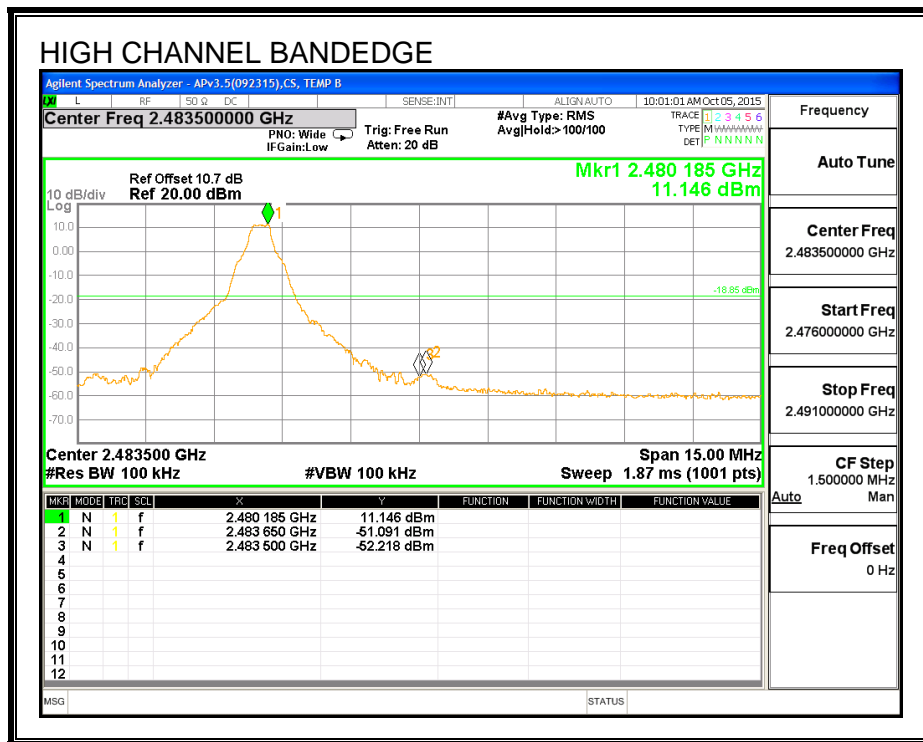

SPURIOUS BANDEGE EMISSIONS WITH HOPPING ON

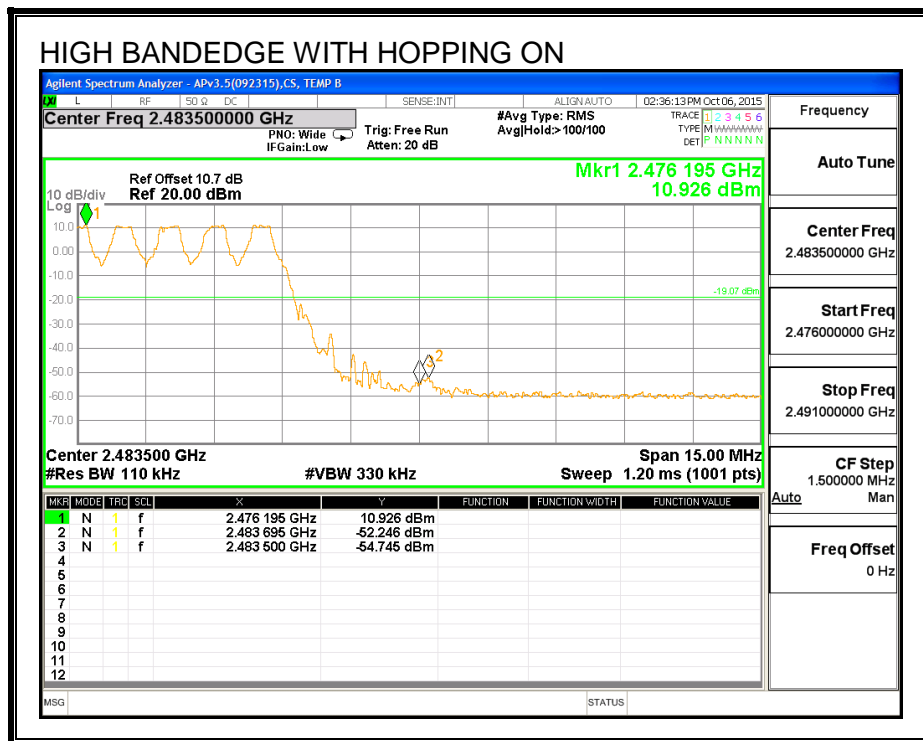
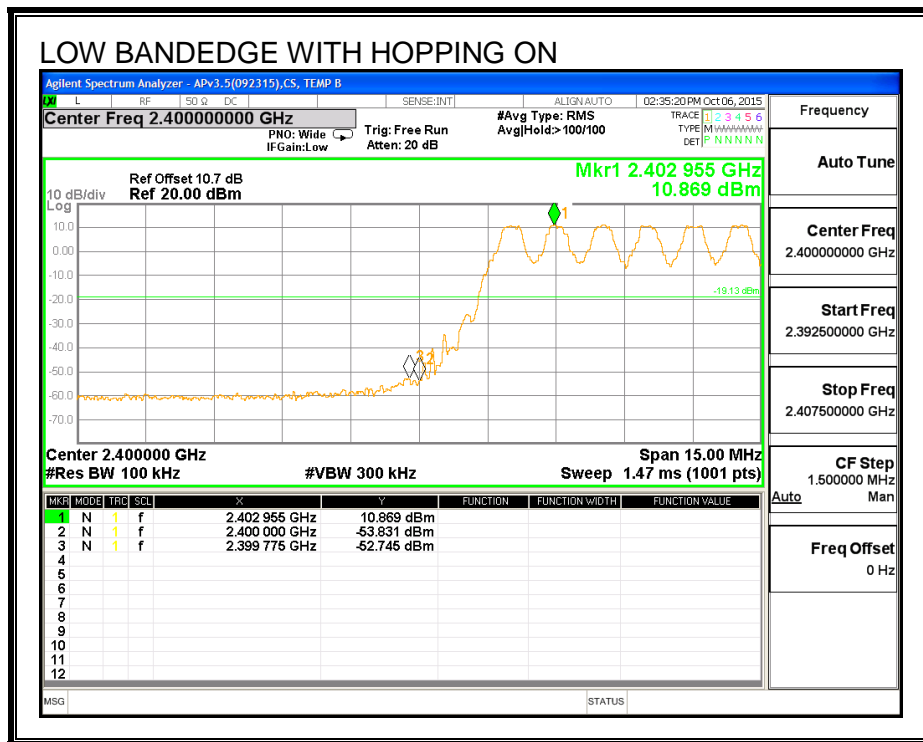

7.3. ENHANCED DATA RATE QPSK MODULATION

7.3.1. OUTPUT POWER

LIMIT

§15.247 (b) (1)

RSS-247 (5.4) (2)

Alternatively, frequency hopping systems operating in the 2400-2483.5 MHz band may have hopping channel carrier frequencies that are separated by 25 kHz or two-thirds of the 20 dB bandwidth of the hopping channel, whichever is greater, provided the systems operate with an output power no greater than 125 mW

TEST PROCEDURE

The transmitter output is connected to a wideband peak and average power meter.

RESULTS

For 75 or more hopping channels

Channel	Frequency (MHz)	Output Power (dBm)	Directional Gain (dBi)	Limit (dBm)	Margin (dB)
Low	2402	9.37	0.00	21	-11.63
Middle	2441	9.34	0.00	21	-11.66
High	2480	9.29	0.00	21	-11.71

OUTPUT POWER

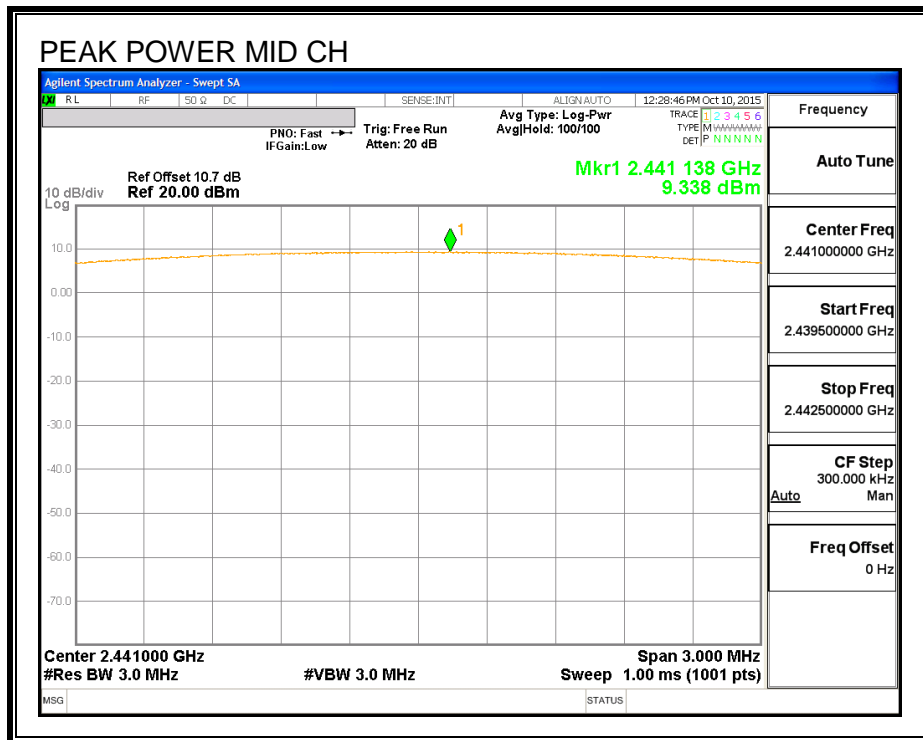
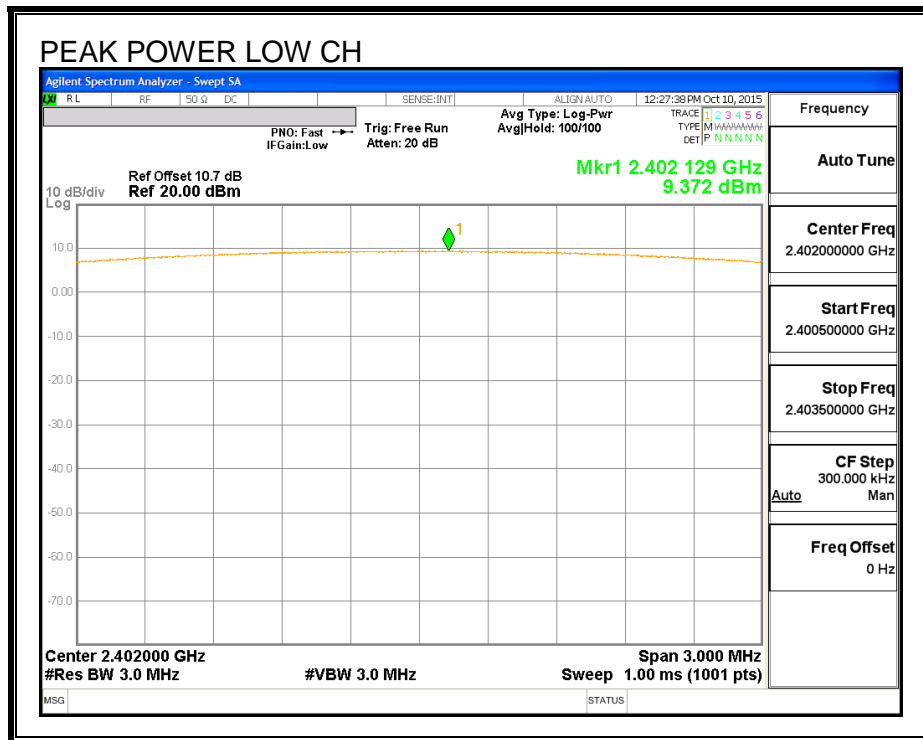

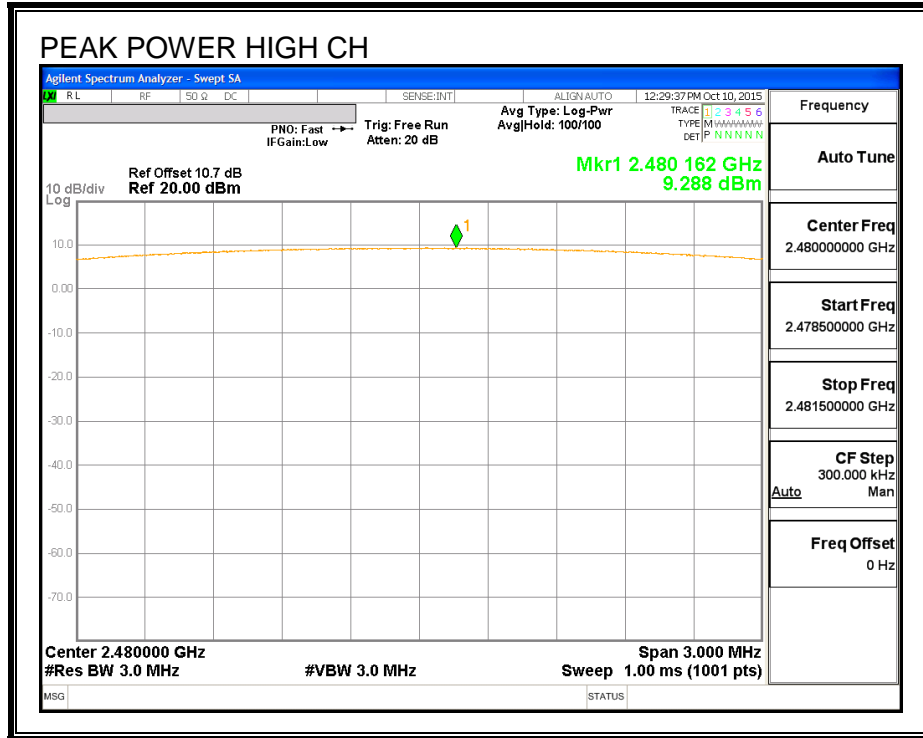

7.3.2. AVERAGE POWER

LIMIT

None; for reporting purposes only.

TEST PROCEDURE

The transmitter output is connected to a power meter.

RESULTS

The cable assembly insertion loss of 10.7 dB (including 10 dB pad and 0.7 dB cable) was entered as an offset in the power meter to allow for direct reading of power.

Channel	Frequency (MHz)	Average Power (dBm)
Low	2402	6.36
Middle	2441	6.41
High	2480	6.20

7.4. ENHANCED DATA RATE 8PSK MODULATION

7.4.1. 20 dB AND 99% BANDWIDTH

LIMIT

None; for reporting purposes only.

TEST PROCEDURE

The transmitter output is connected to a spectrum analyzer. The RBW is set to $\geq 1\%$ of the 20 dB bandwidth. The VBW is set to \geq RBW. The sweep time is coupled.

RESULTS

Channel	Frequency (MHz)	20 dB Bandwidth (MHz)	99% Bandwidth (MHz)
Low	2402	1.352	1.1927
Middle	2441	1.331	1.1953
High	2480	1.339	1.2091

20 dB AND 99% BANDWIDTH

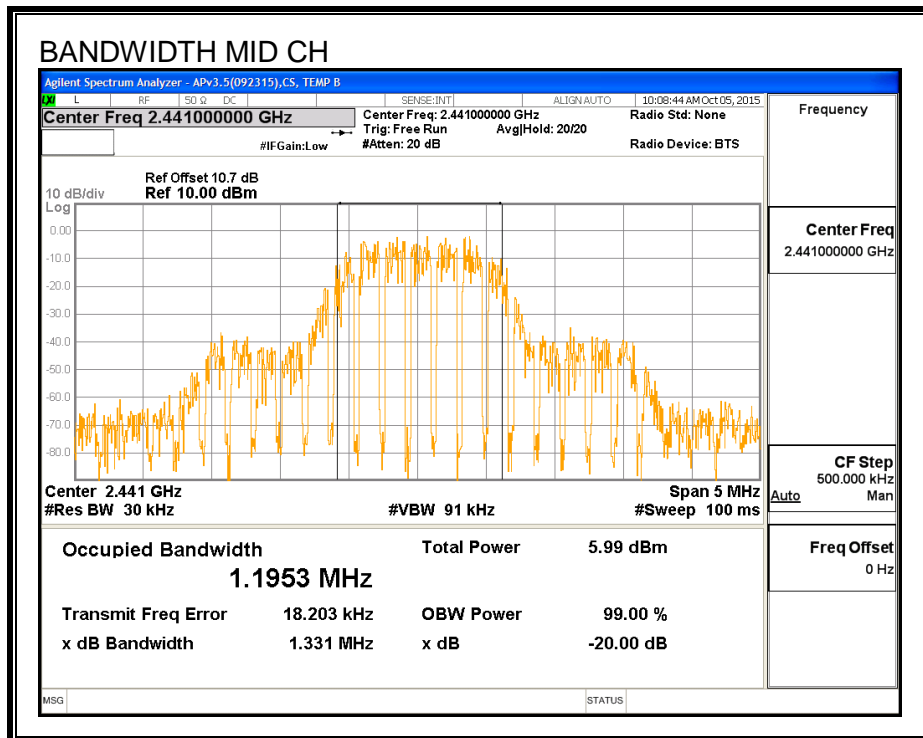
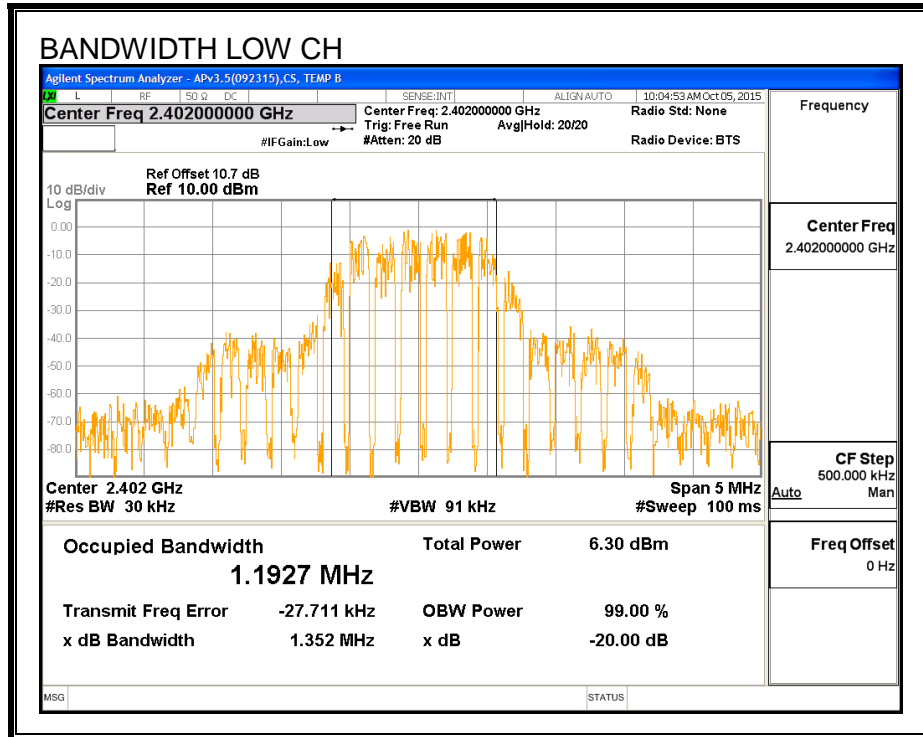

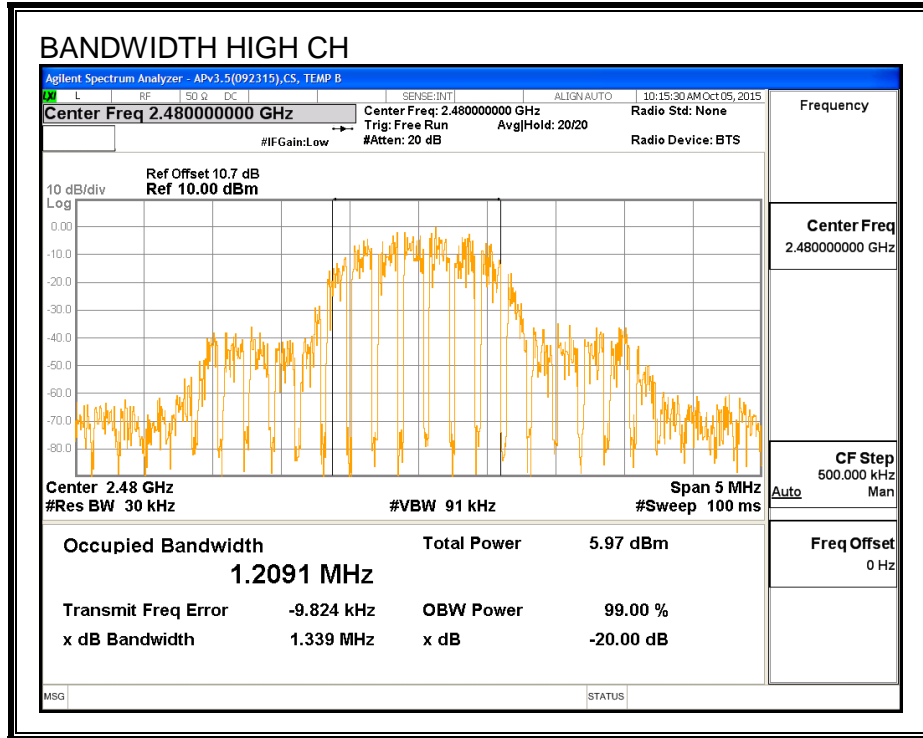

7.4.2. HOPPING FREQUENCY SEPARATION

LIMIT

FCC §15.247 (a) (1)

IC RSS-247 (5.1) (2)

Frequency hopping systems shall have hopping channel carrier frequencies separated by a minimum of 25 kHz or the 20 dB bandwidth of the hopping channel, whichever is greater.

Alternatively, frequency hopping systems operating in the 2400-2483.5 MHz band may have hopping channel carrier frequencies that are separated by 25 kHz or two-thirds of the 20 dB bandwidth of the hopping channel, whichever is greater, provided the systems operate with an output power no greater than 125 mW.

TEST PROCEDURE

The transmitter output is connected to a spectrum analyzer. The RBW is set to 300 kHz and the VBW is set to 910 kHz. The sweep time is coupled.

RESULTS

HOPPING FREQUENCY SEPARATION

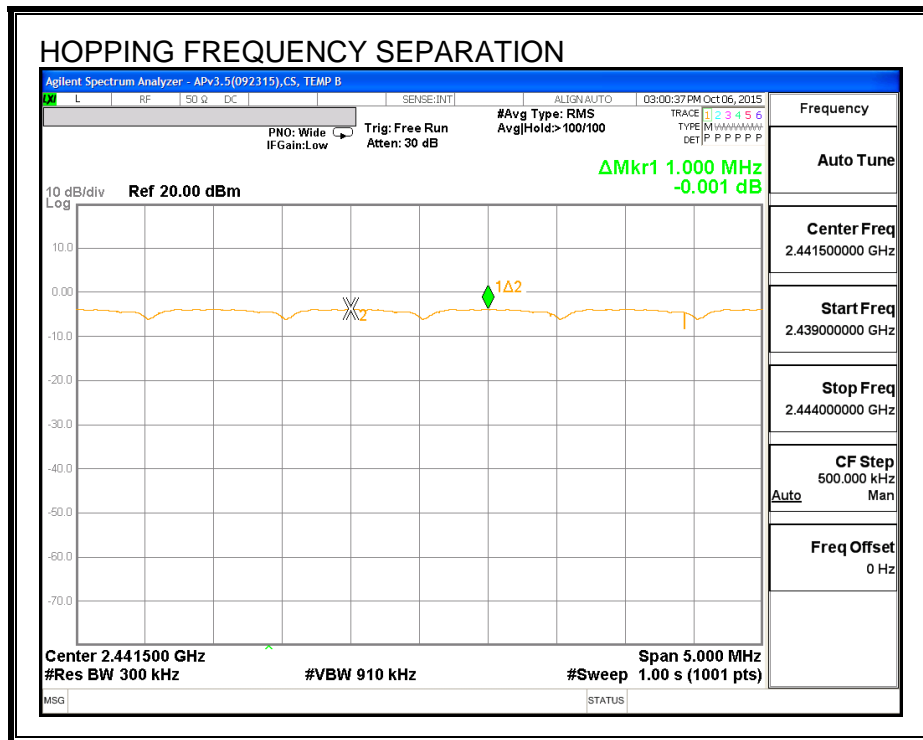

7.4.3. NUMBER OF HOPPING CHANNELS

LIMIT

FCC §15.247 (a) (1) (iii)

IC RSS-247 (5.1) (4)

Frequency hopping systems in the 2400 – 2483.5 MHz band shall use at least 15 non-overlapping channels.

TEST PROCEDURE

The transmitter output is connected to a spectrum analyzer. The span is set to cover the entire authorized band, in either a single sweep or in multiple contiguous sweeps. The RBW is set to a maximum of 1 % of the span. The analyzer is set to Max Hold.

RESULTS

Normal Mode: 79 Channels observed.

NUMBER OF HOPPING CHANNELS

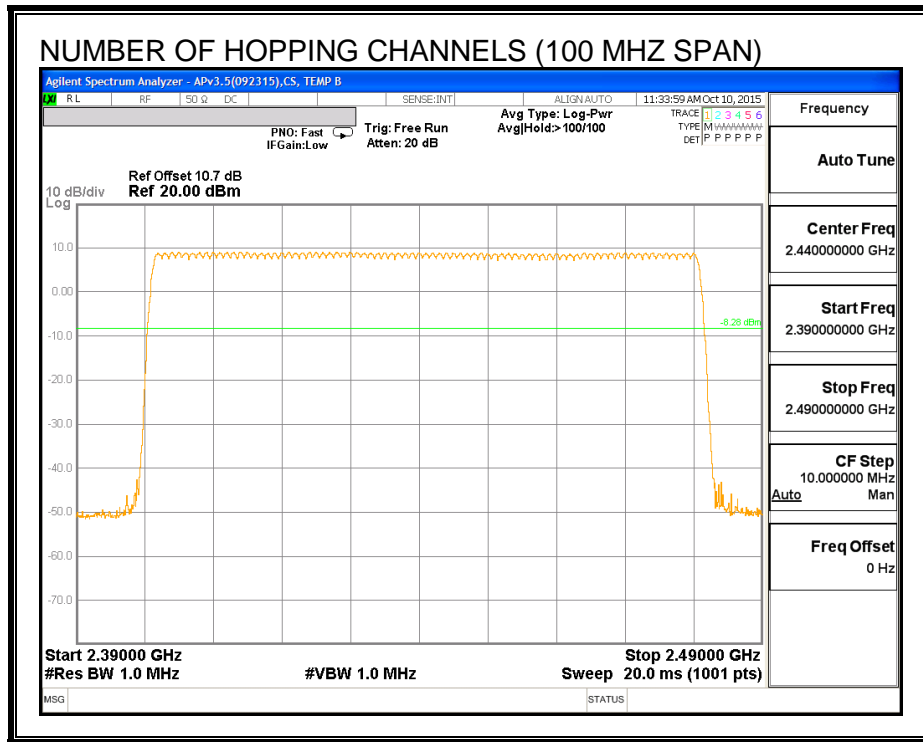

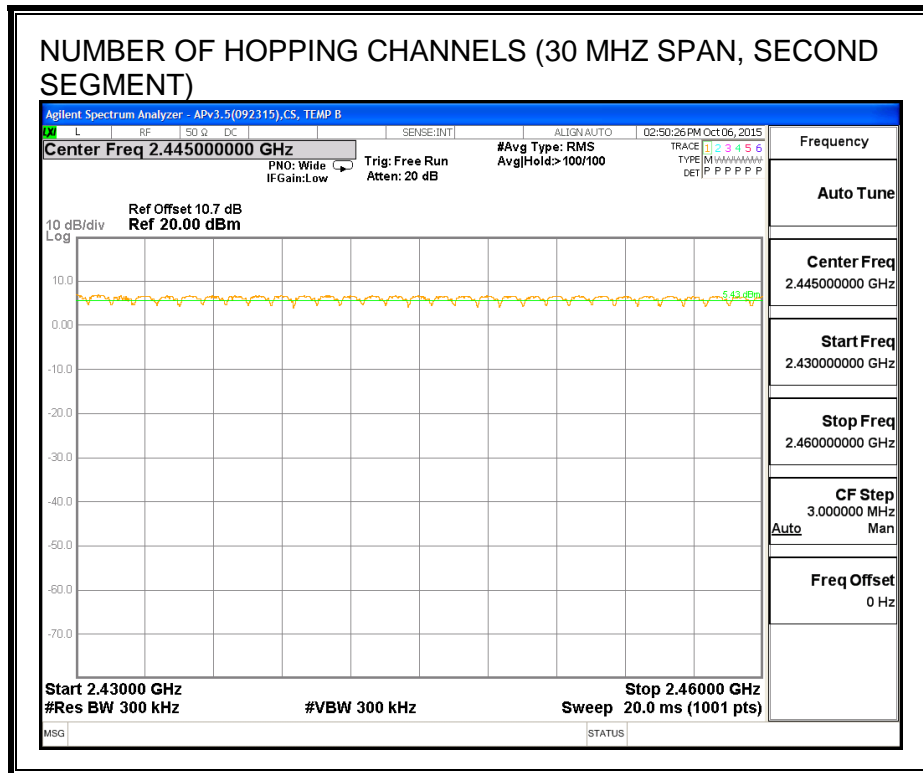
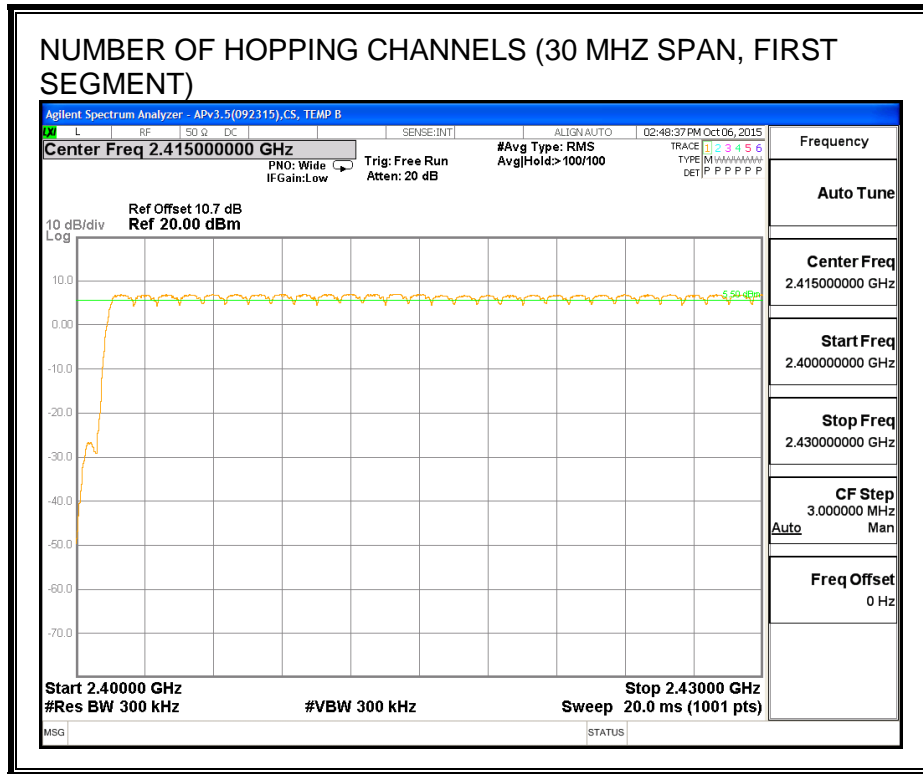

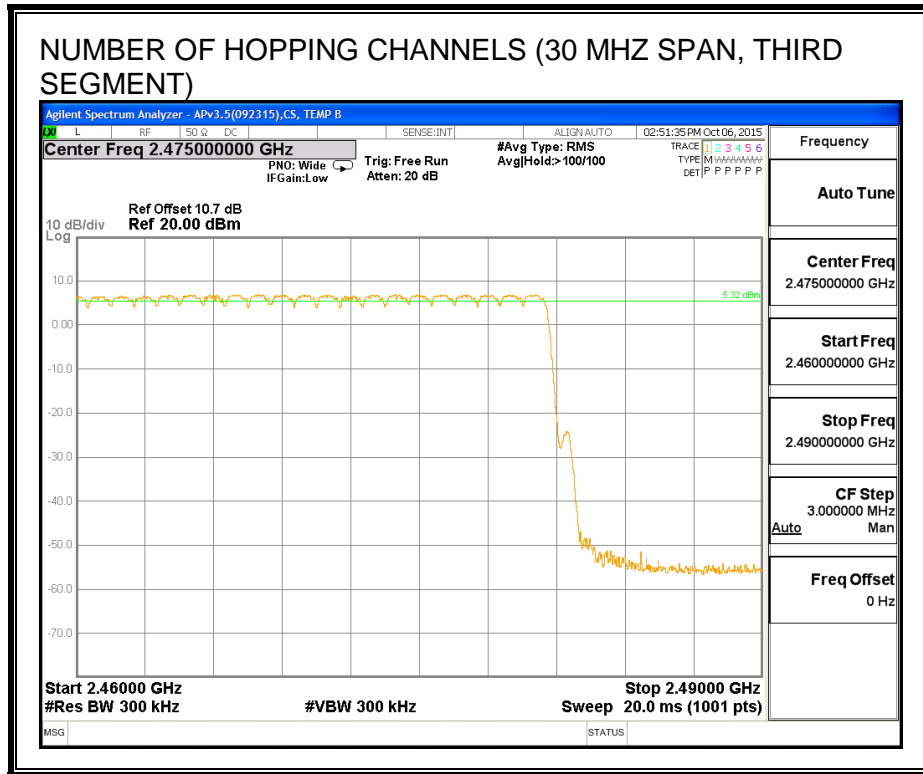

7.4.4. AVERAGE TIME OF OCCUPANCY

LIMIT

FCC §15.247 (a) (1) (iii)

IC RSS-247 (5.1) (4)

The average time of occupancy on any channel shall not be greater than 0.4 seconds within a period of 0.4 seconds multiplied by the number of hopping channels employed.

TEST PROCEDURE

The transmitter output is connected to a spectrum analyzer. The span is set to 0 Hz, centered on a single, selected hopping channel. The width of a single pulse is measured in a fast scan. The number of pulses is measured in a 3.16 second scan, to enable resolution of each occurrence.

The average time of occupancy in the specified 31.6 second period (79 channels * 0.4 s) is equal to $10 * (\# \text{ of pulses in } 3.16 \text{ s}) * \text{ pulse width}$.

RESULTS

Time Of Occupancy = $10 * xx \text{ pulses} * yy \text{ msec} = zz \text{ msec}$

8PSK (EDR) Mode

DH Packet	Pulse Width (msec)	Number of Pulses in 3.16 seconds	Average Time of (sec)	Limit (sec)	Margin (sec)
DH1	0.273	15	0.041	0.4	-0.359
DH3	0.694	13	0.090	0.4	-0.310
DH5	2.928	13	0.381	0.4	-0.019

Note: for AFH (8PSK) mode, please refer to the results of AFH (GFSK) mode; the channel selection and hopping rate are the same for both EDR and Basic Rate operation, data for Basic Rate on page 7.2.4 demonstrates compliance with channel occupancy when AFH is employed.

PULSE WIDTH - DH1



NUMBER OF PULSES IN 3.16 SECOND OBSERVATION PERIOD – DH1

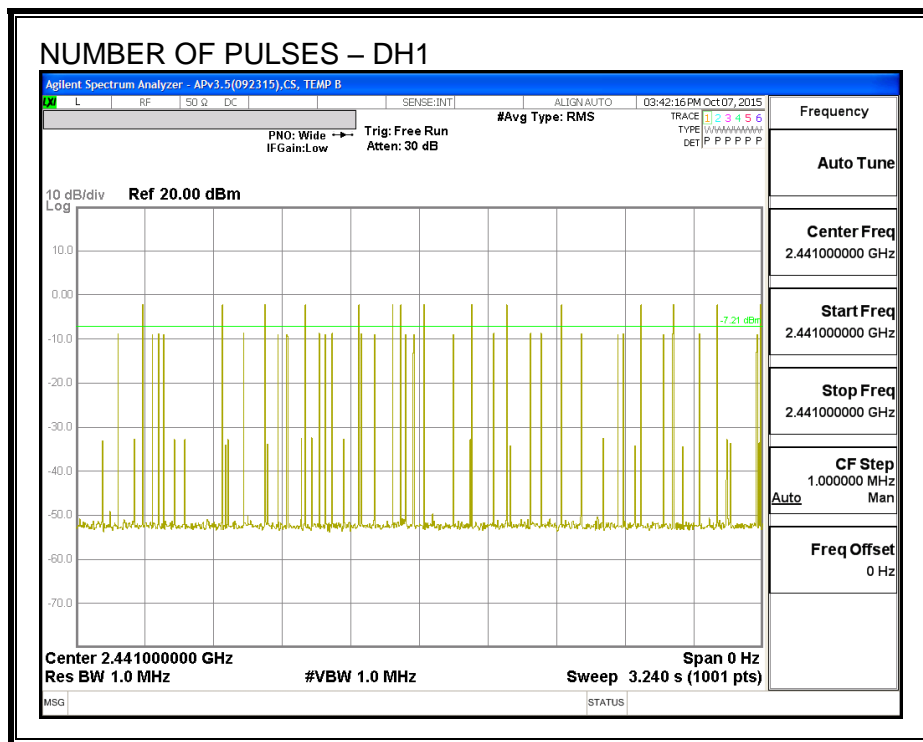

PULSE WIDTH – DH3

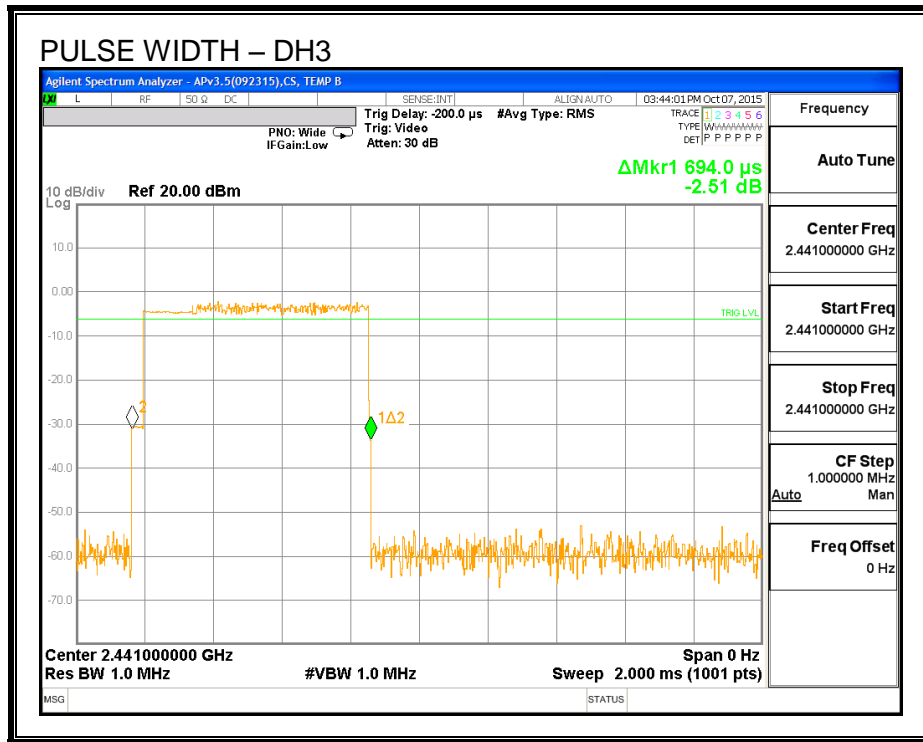

NUMBER OF PULSES IN 3.16 SECOND OBSERVATION PERIOD – DH3

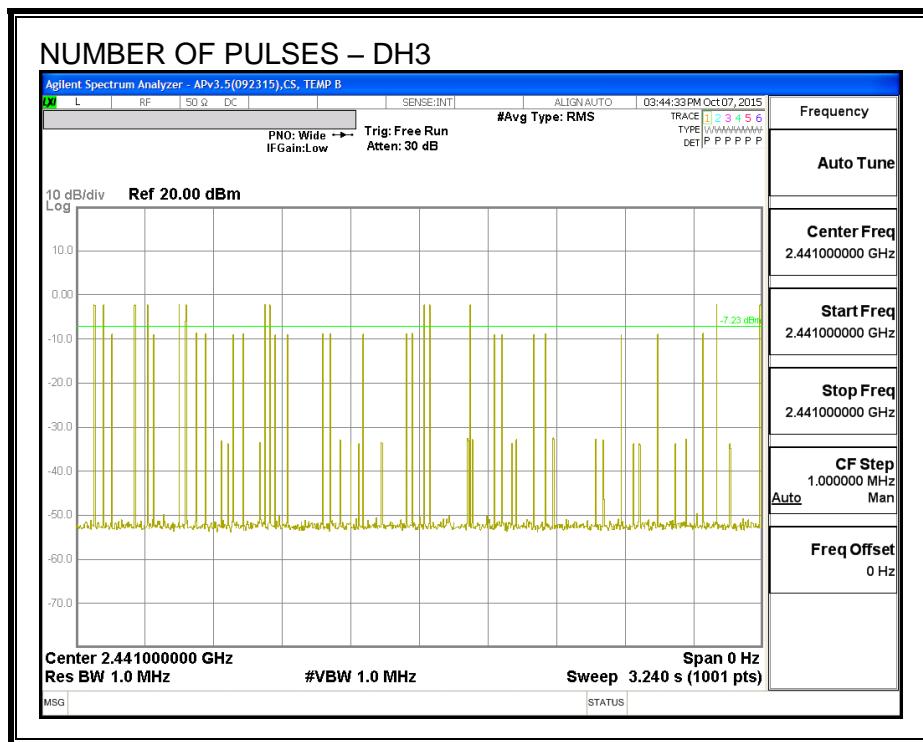

PULSE WIDTH – DH5

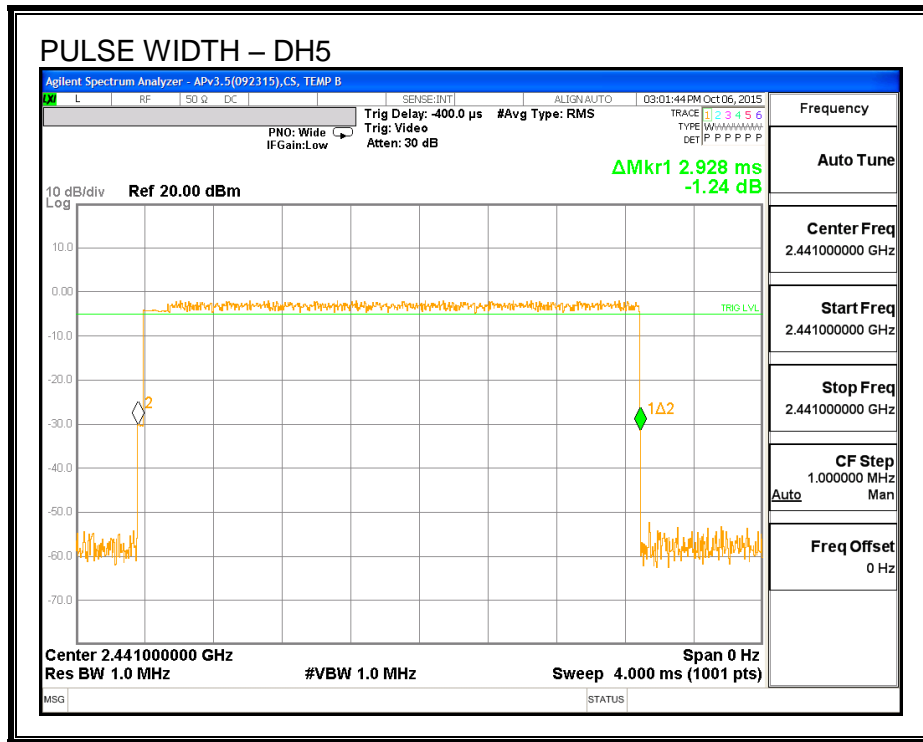

NUMBER OF PULSES IN 3.16 SECOND OBSERVATION PERIOD – DH5

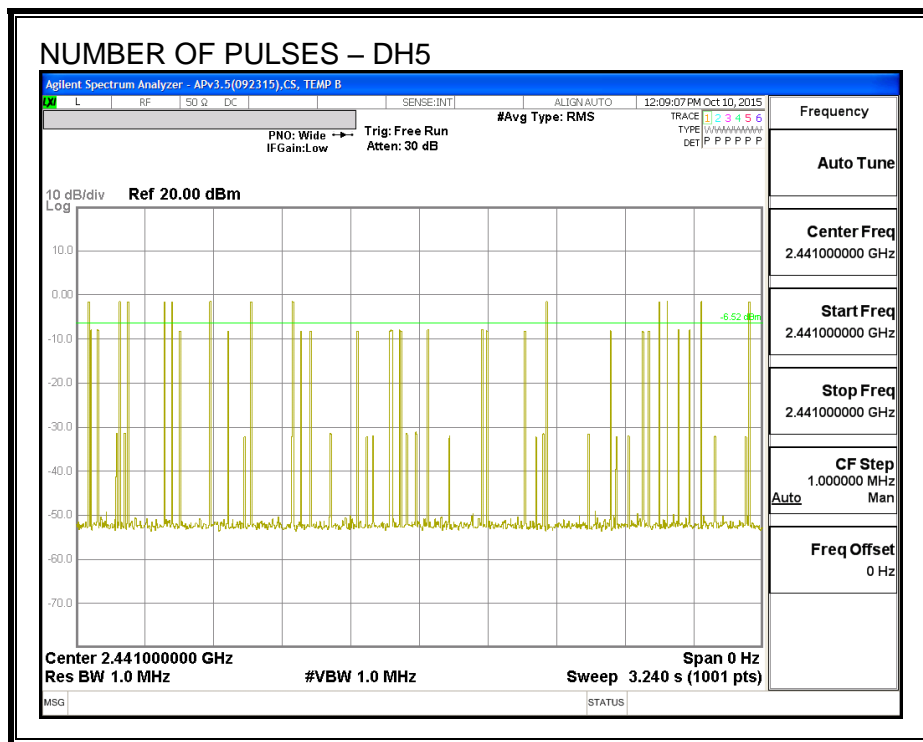

7.4.5. OUTPUT POWER

LIMIT

§15.247 (b) (1)

RSS-247 (5.4) (2)

Alternatively, frequency hopping systems operating in the 2400-2483.5 MHz band may have hopping channel carrier frequencies that are separated by 25 kHz or two-thirds of the 20 dB bandwidth of the hopping channel, whichever is greater, provided the systems operate with an output power no greater than 125 mW.

TEST PROCEDURE

The transmitter output is connected to a wideband peak and average power meter.

RESULTS

For 75 or more hopping channels

Channel	Frequency (MHz)	Output Power (dBm)	Directional Gain (dBi)	Limit (dBm)	Margin (dB)
Low	2402	9.77	0.00	21	-11.23
Middle	2441	9.72	0.00	21	-11.28
High	2480	9.65	0.00	21	-11.35

OUTPUT POWER

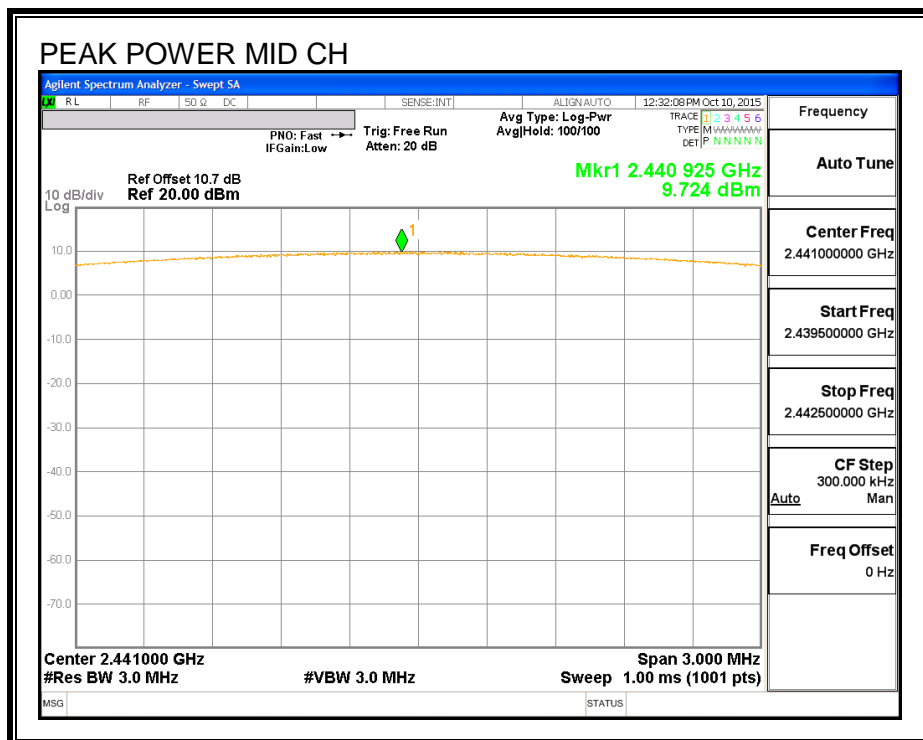
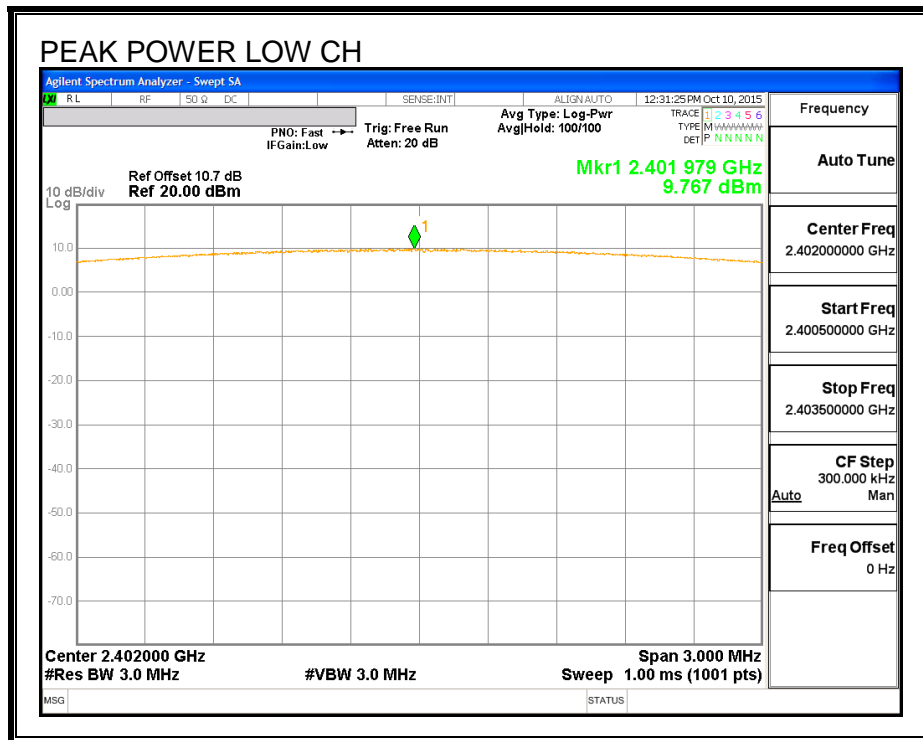

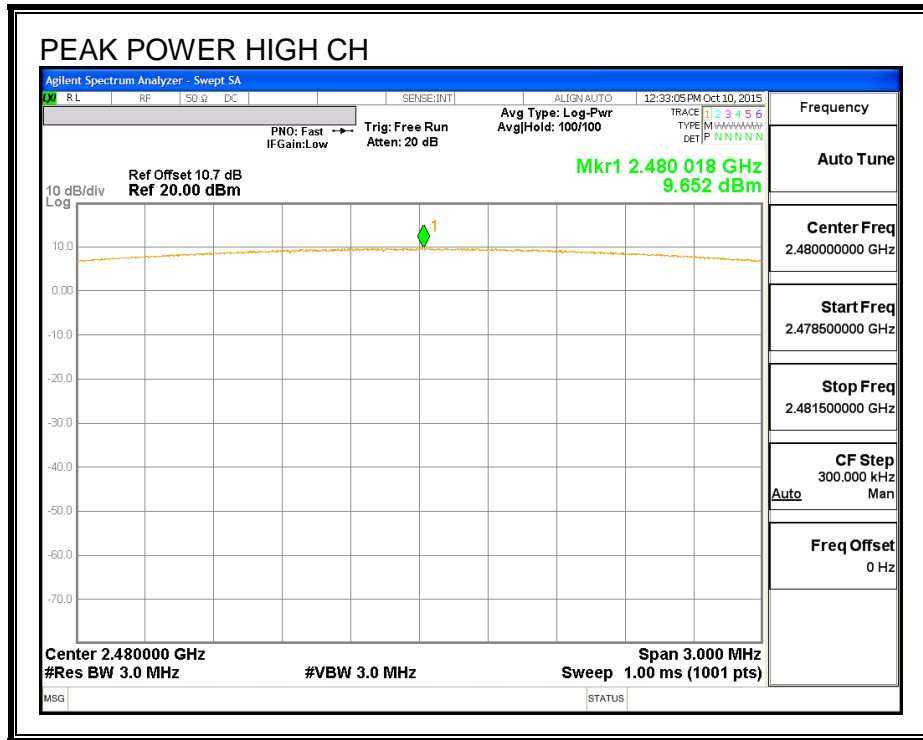

7.4.6. AVERAGE POWER

LIMIT

None; for reporting purposes only.

TEST PROCEDURE

The transmitter output is connected to a power meter.

RESULTS

The cable assembly insertion loss of 10.7 dB (including 10 dB pad and 0.7 dB cable) was entered as an offset in the power meter to allow for direct reading of power.

Channel	Frequency (MHz)	Average Power (dBm)
Low	2402	6.38
Middle	2441	6.44
High	2480	6.24

7.4.7. CONDUCTED SPURIOUS EMISSIONS

LIMITS

FCC §15.247 (d)

IC RSS-247 (5.5)

Limit = -20 dBc

TEST PROCEDURE

The transmitter output is connected to a spectrum analyzer. The resolution bandwidth is set to 100 kHz. The video bandwidth is set to 300 kHz.

The spectrum from 30 MHz to 26 GHz is investigated with the transmitter set to the lowest, middle, and highest channels.

The bandedges at 2.4 and 2.4835 GHz are investigated with the transmitter set to the normal hopping mode.

RESULTS

SPURIOUS EMISSIONS, LOW CHANNEL

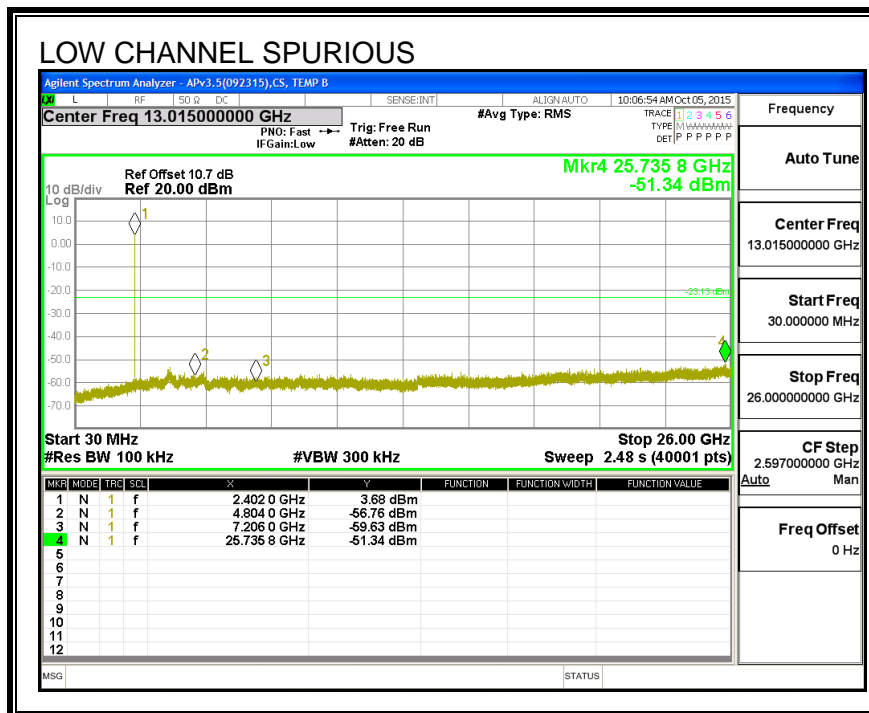
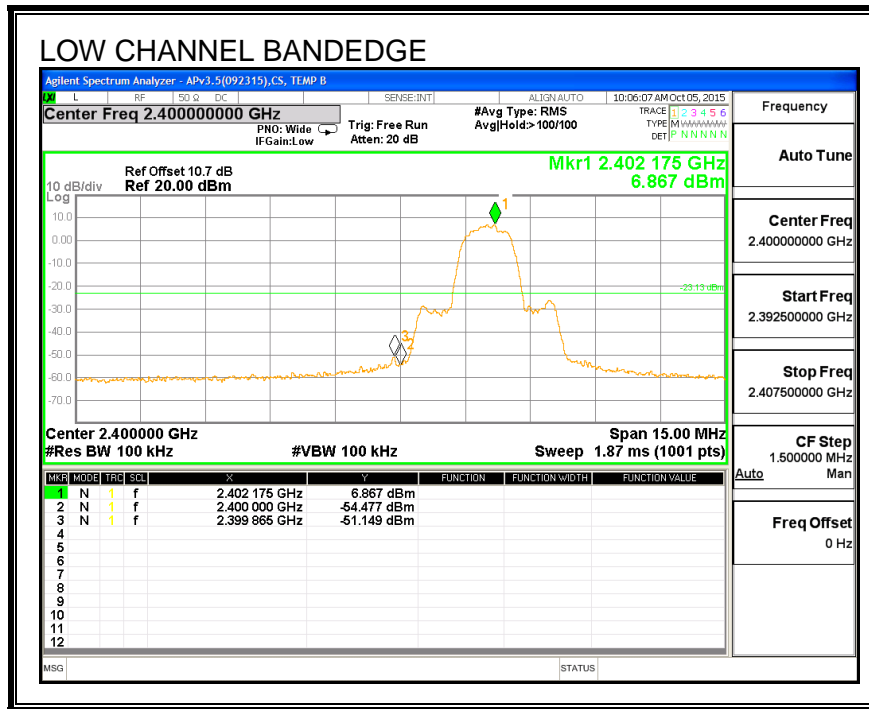

SPURIOUS EMISSIONS, MID CHANNEL

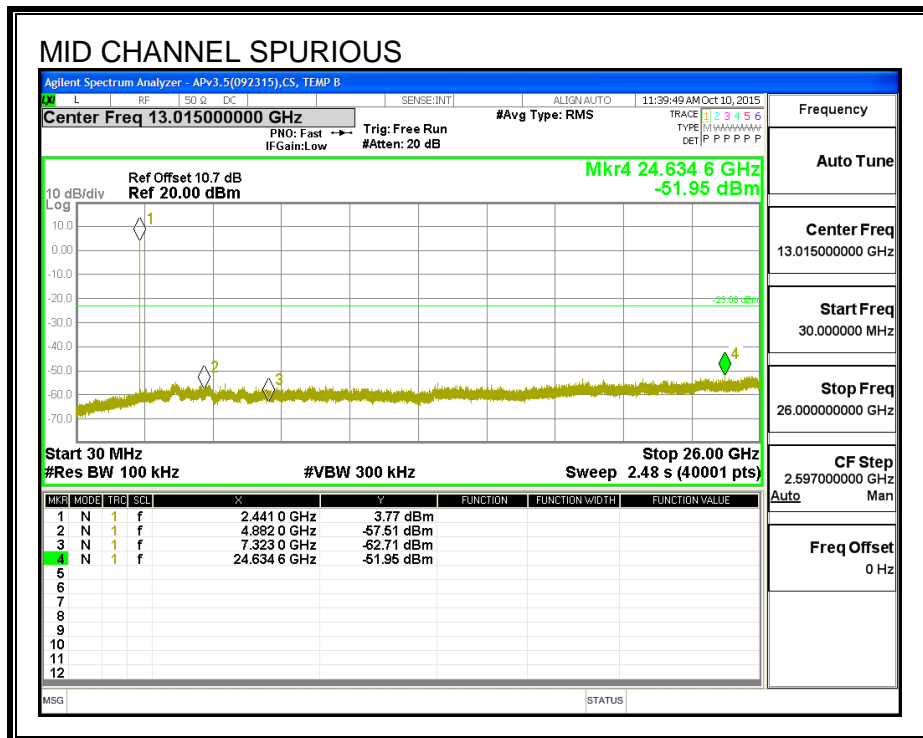
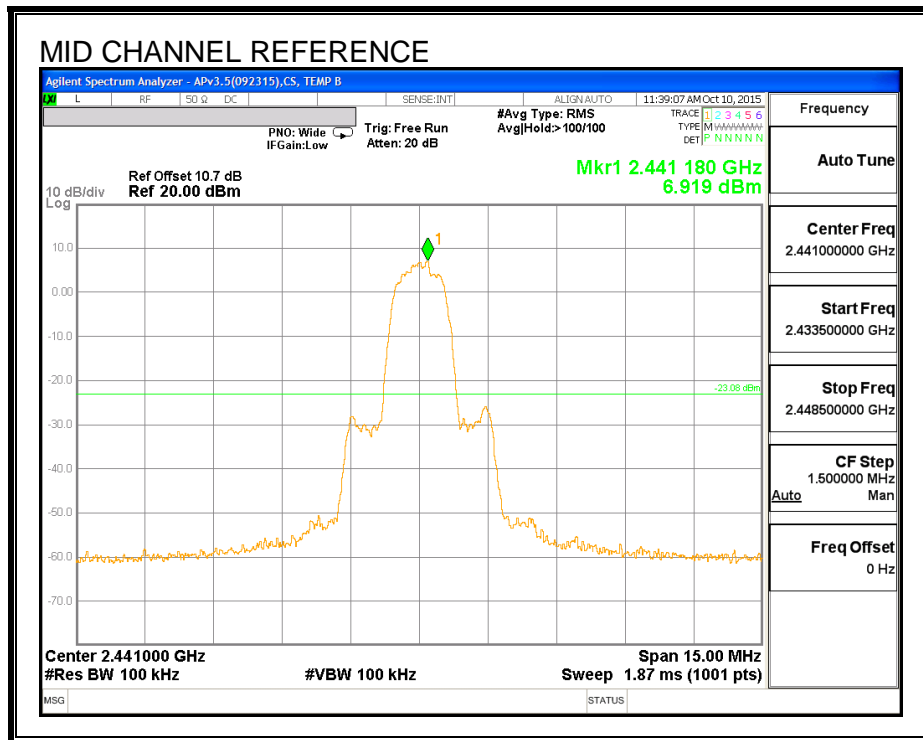

SPURIOUS EMISSIONS, HIGH CHANNEL

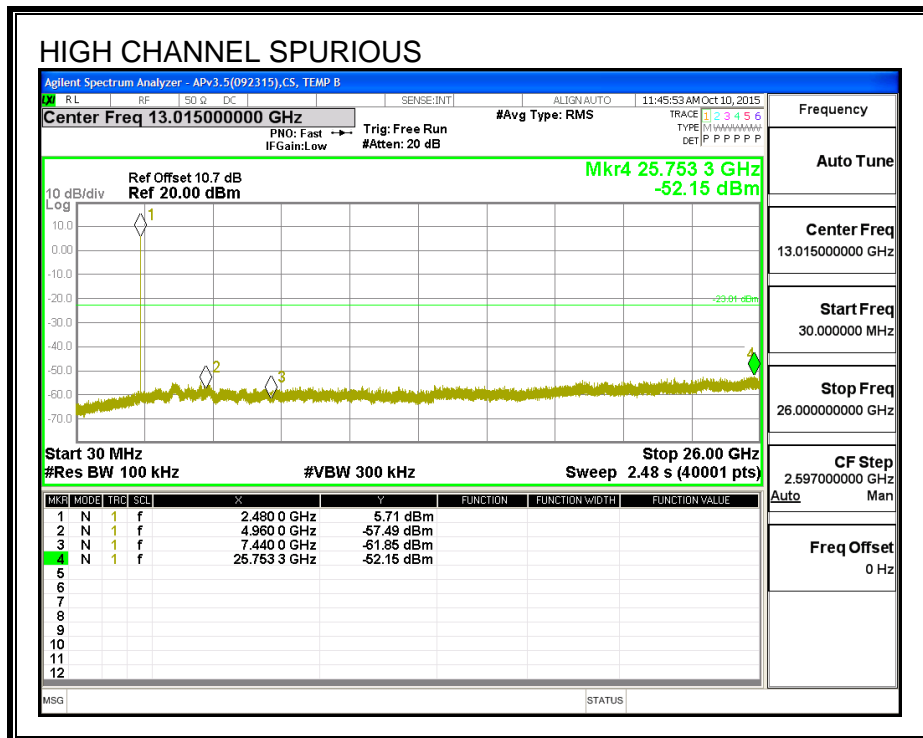
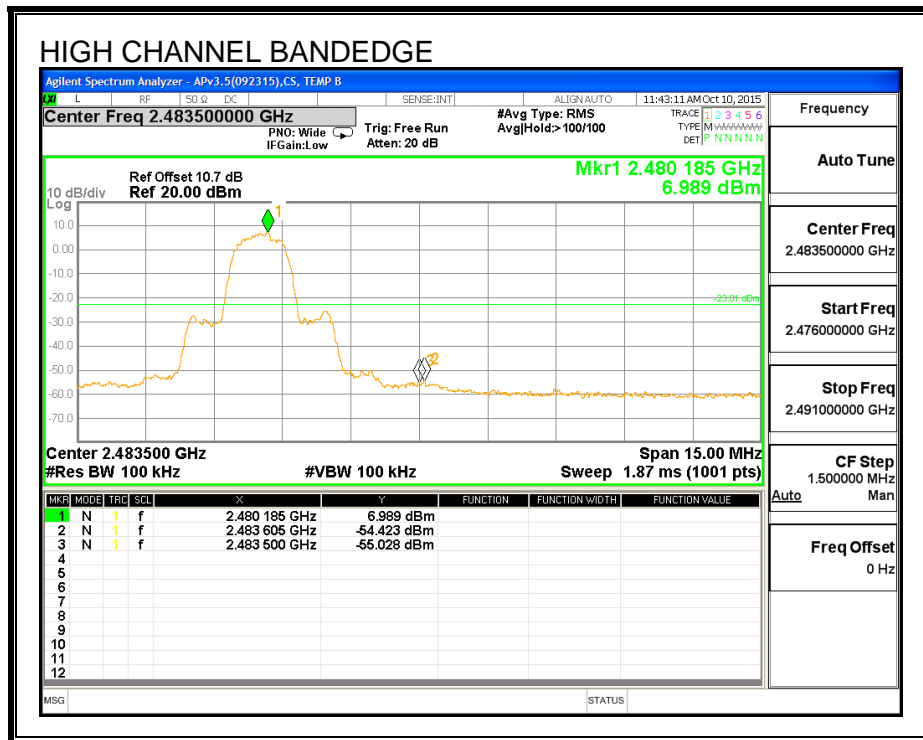

SPURIOUS BANDEGE EMISSIONS WITH HOPPING ON

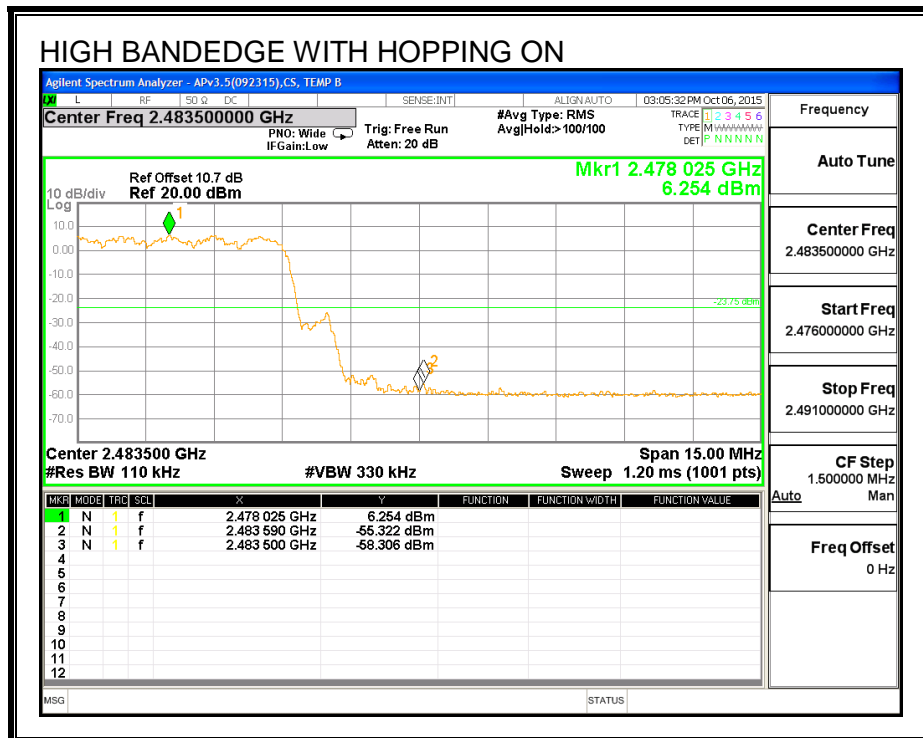
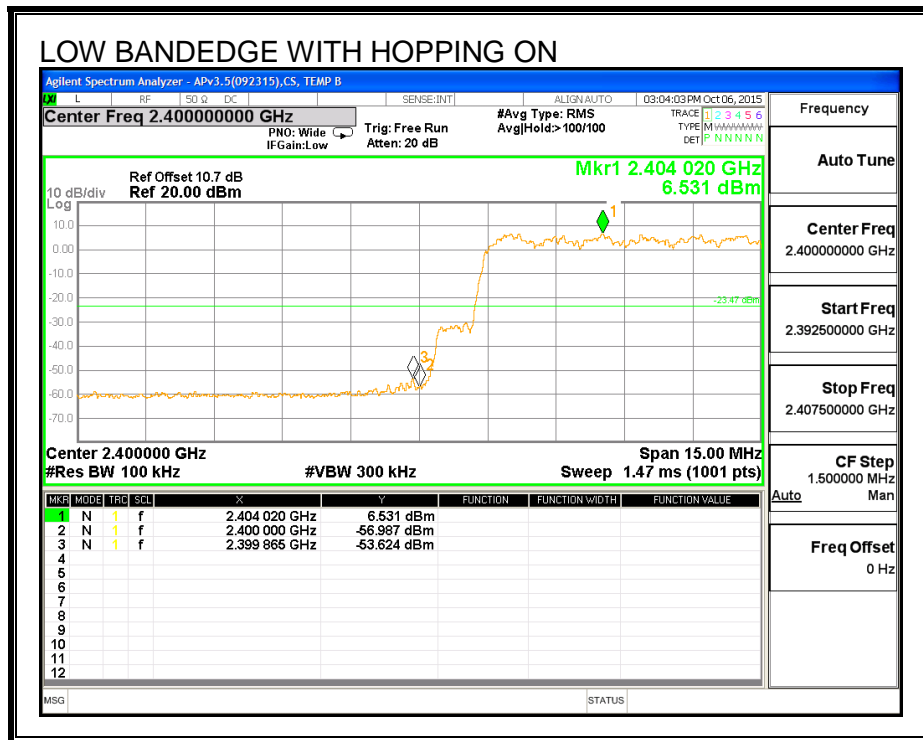

8. RADIATED TEST RESULTS

8.1. LIMITS AND PROCEDURE

LIMITS

FCC §15.205 and §15.209

IC RSS-GEN, Section 8.9 and 8.10.

Frequency Range (MHz)	Field Strength Limit (uV/m) at 3 m	Field Strength Limit (dBuV/m) at 3 m
30 - 88	100	40
88 - 216	150	43.5
216 - 960	200	46
Above 960	500	54

TEST PROCEDURE

The EUT is placed on a non-conducting table 80 cm above the ground plane for measurement below 1GHz; 1.5 m above the ground plane for measurement above 1GHz. The antenna to EUT distance is 3 meters. The EUT is configured in accordance with ANSI C63.10. The EUT is set to transmit in a continuous mode.

For measurements below 1 GHz the resolution bandwidth is set to 100 kHz for peak detection measurements or 120 kHz for quasi-peak detection measurements. Peak detection is used unless otherwise noted as quasi-peak.

For measurements above 1 GHz the resolution bandwidth is set to 1 MHz, then the video bandwidth is set to 3 MHz for peak measurements and 1 MHz resolution bandwidth with 1/T (10 Hz) video bandwidth with peak detector for average measurements.

The spectrum from 30 MHz to 26 GHz is investigated with the transmitter set to the lowest, middle, and highest channels in the 2.4 GHz band.

The frequency range of interest is monitored at a fixed antenna height and EUT azimuth. The EUT is rotated through 360 degrees to maximize emissions received. The antenna is scanned from 1 to 4 meters above the ground plane to further maximize the emission. Measurements are made with the antenna polarized in both the vertical and the horizontal positions

8.2. TX ABOVE 1 GHz BASIC DATA RATE GFSK MODULATION

RESTRICTED BANDEDGE (LOW CHANNEL)

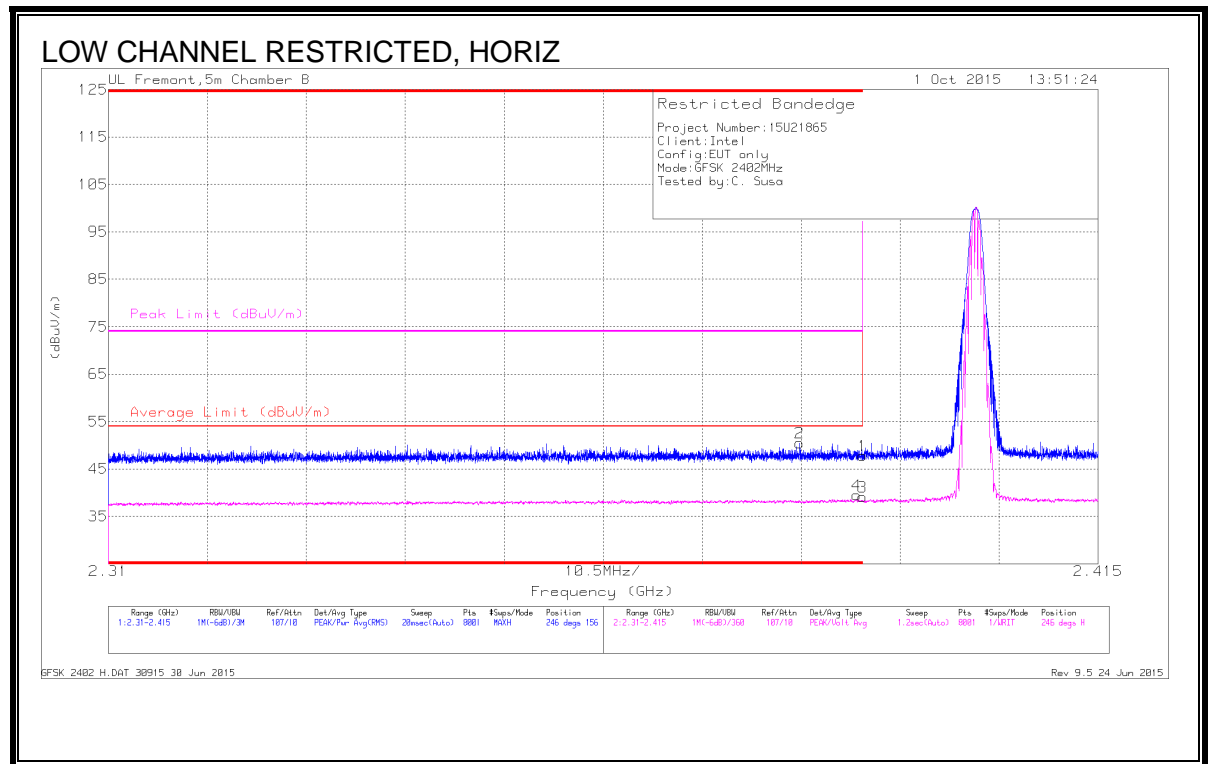

Trace Markers

Marker	Frequency (GHz)	Meter Reading (dBuV)	Det	AF T345 (dB/m)	Amp/Cbl/Fit r/Pad (dB)	DC Corr (dB)	Corrected Reading (dBuV/m)	Average Limit (dBuV/m)	Margin (dB)	Peak Limit (dBuV/m)	PK Margin (dB)	Azimuth (Degs)	Height (cm)	Polarity
1	* 2.39	39.88	Pk	32	-24.1	0	47.78	-	-	74	-26.22	246	156	H
2	* 2.383	42.58	Pk	32	-24.1	0	50.48	-	-	74	-23.52	246	156	H
3	* 2.39	29.17	VA1T	32	-24.1	1.14	38.21	54	-15.79	-	-	246	156	H
4	* 2.389	29.57	VA1T	32	-24.1	1.14	38.61	54	-15.39	-	-	246	156	H

* - indicates frequency in CFR15.205/IC7.2.2 Restricted Band

Pk - Peak detector

VA1T - FHSS: Linear Voltage Average VB=1/Ton where: Ton is transmit duration

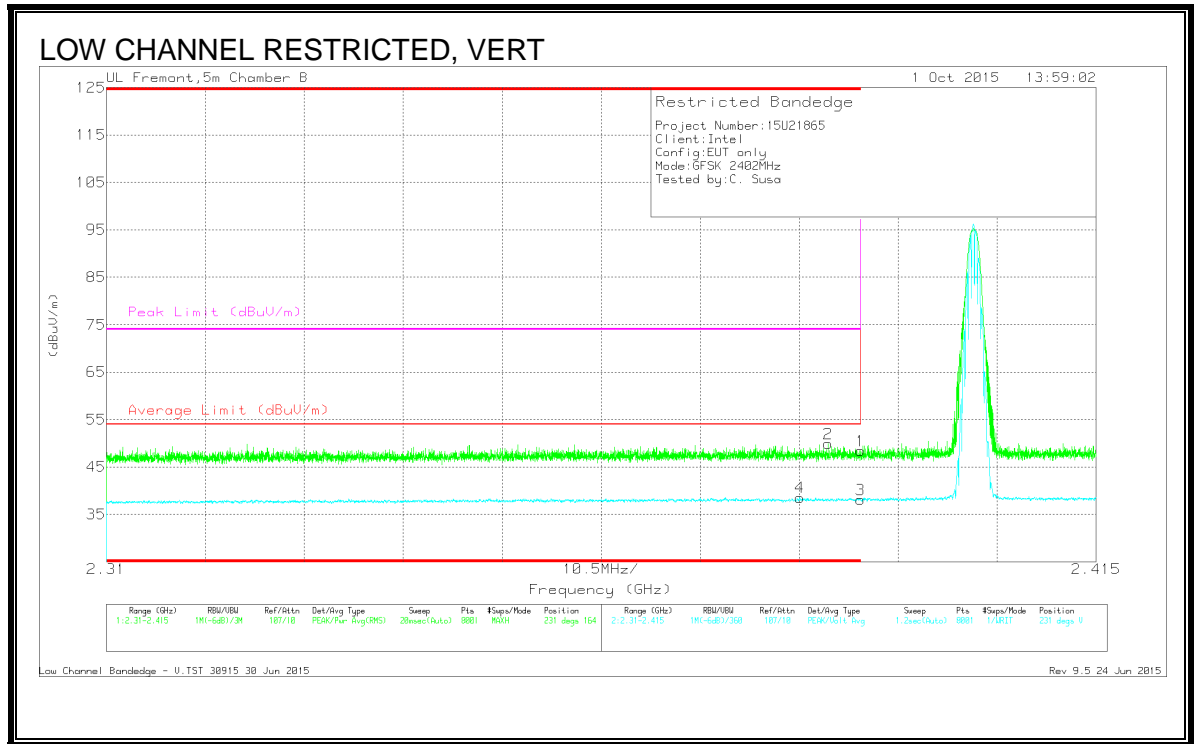

Trace Markers

Marker	Frequency (GHz)	Meter Reading (dBuV)	Det	AF T345 (dB/m)	Amp/Cbl/Fit r/Pad (dB)	DC Corr (dB)	Corrected Reading (dBuV/m)	Average Limit (dBuV/m)	Margin (dB)	Peak Limit (dBuV/m)	PK Margin (dB)	Azimuth (Degs)	Height (cm)	Polarity
1	* 2.39	40.53	Pk	32	-24.1	0	48.43	-	-	74	-25.57	231	164	V
2	* 2.387	42.06	Pk	32	-24.1	0	49.96	-	-	74	-24.04	231	164	V
3	* 2.39	29.05	VA1T	32	-24.1	1.14	38.09	54	-15.91	-	-	231	164	V
4	* 2.384	29.52	VA1T	32	-24.1	1.14	38.56	54	-15.44	-	-	231	164	V

* - indicates frequency in CFR15.205/IC7.2.2 Restricted Band

Pk - Peak detector

VA1T - FHSS: Linear Voltage Average VB=1/Ton where: Ton is transmit duration

AUTHORIZED BANDEDGE (HIGH CHANNEL)

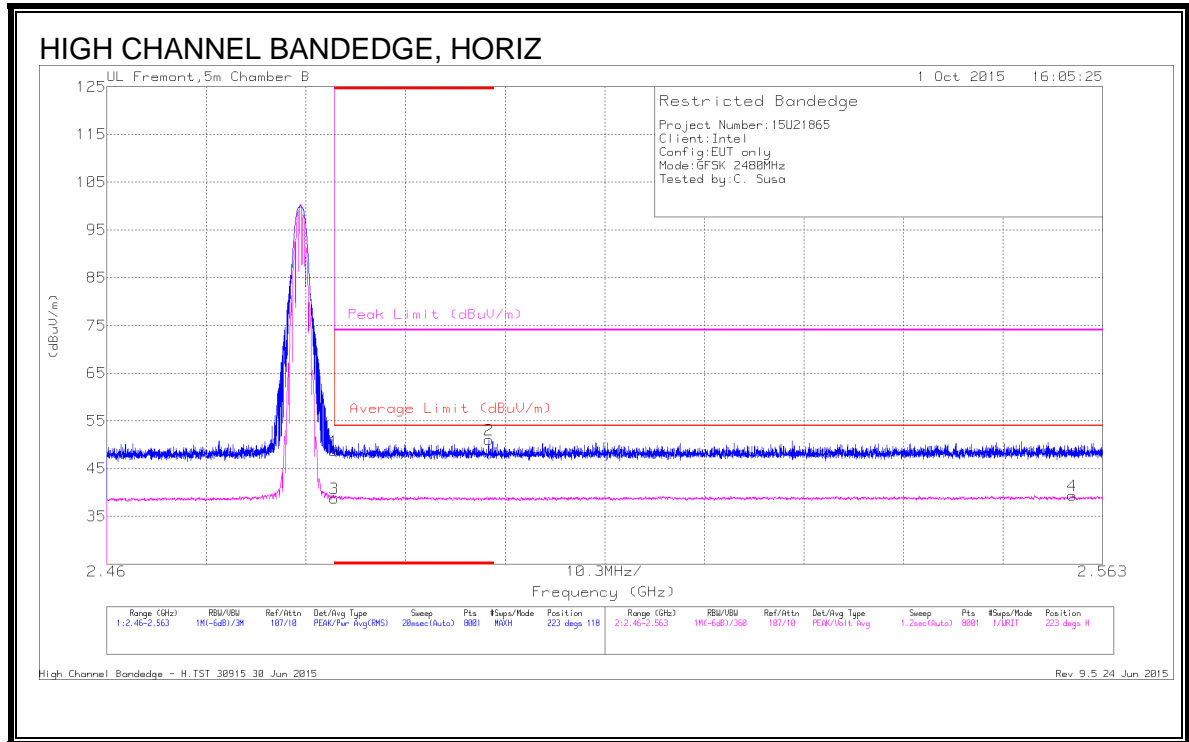

Trace Markers

Marker	Frequency (GHz)	Meter Reading (dBuV)	Det	AF T345 (dB/m)	Amp/Cbl/Fit r/Pad (dB)	DC Corr (dB)	Corrected Reading (dBuV/m)	Average Limit (dBuV/m)	Margin (dB)	Peak Limit (dBuV/m)	PK Margin (dB)	Azimuth (Degs)	Height (cm)	Polarity
1	* 2.484	40.16	Pk	32.5	-24	0	48.66	-	-	74	-25.34	223	118	H
2	* 2.499	42.51	Pk	32.5	-24	0	51.01	-	-	74	-22.99	223	118	H
3	* 2.484	29.07	VA1T	32.5	-24	1.14	38.71	54	-15.29	-	-	223	118	H
4	2.56	29.42	VA1T	32.7	-23.9	1.14	39.36	54	-14.64	-	-	223	118	H

* - indicates frequency in CFR15.205/IC7.2.2 Restricted Band

Pk - Peak detector

VA1T - FHSS: Linear Voltage Average VB=1/Ton where: Ton is transmit duration

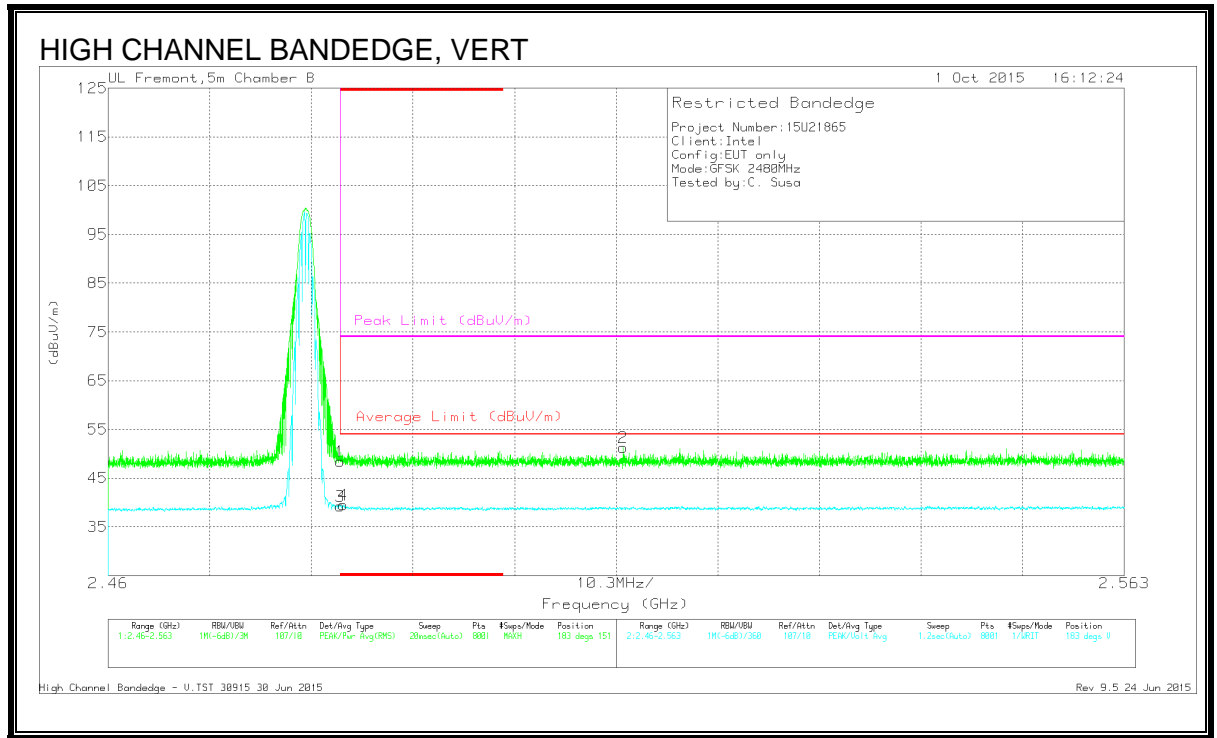

Trace Markers

Marker	Frequency (GHz)	Meter Reading (dBuV)	Det	AF T345 (dB/m)	Amp/Cbl/Filt r/Pad (dB)	DC Corr (dB)	Corrected Reading (dBuV/m)	Average Limit (dBuV/m)	Margin (dB)	Peak Limit (dBuV/m)	PK Margin (dB)	Azimuth (Degs)	Height (cm)	Polarity
1	* 2.484	39.95	Pk	32.5	-24	0	48.45	-	-	74	-25.55	183	151	V
3	* 2.484	29.57	VA1T	32.5	-24	1.14	39.21	54	-14.79	-	-	183	151	V
4	* 2.484	29.81	VA1T	32.5	-24	1.14	39.45	54	-14.55	-	-	183	151	V
2	2.512	42.7	Pk	32.6	-24	0	51.3	-	-	74	-22.7	183	151	V

* - indicates frequency in CFR15.205/IC7.2.2 Restricted Band

Pk - Peak detector

VA1T - FHSS: Linear Voltage Average VB=1/Ton where: Ton is transmit duration

HARMONICS AND SPURIOUS EMISSIONS

LOW CHANNEL

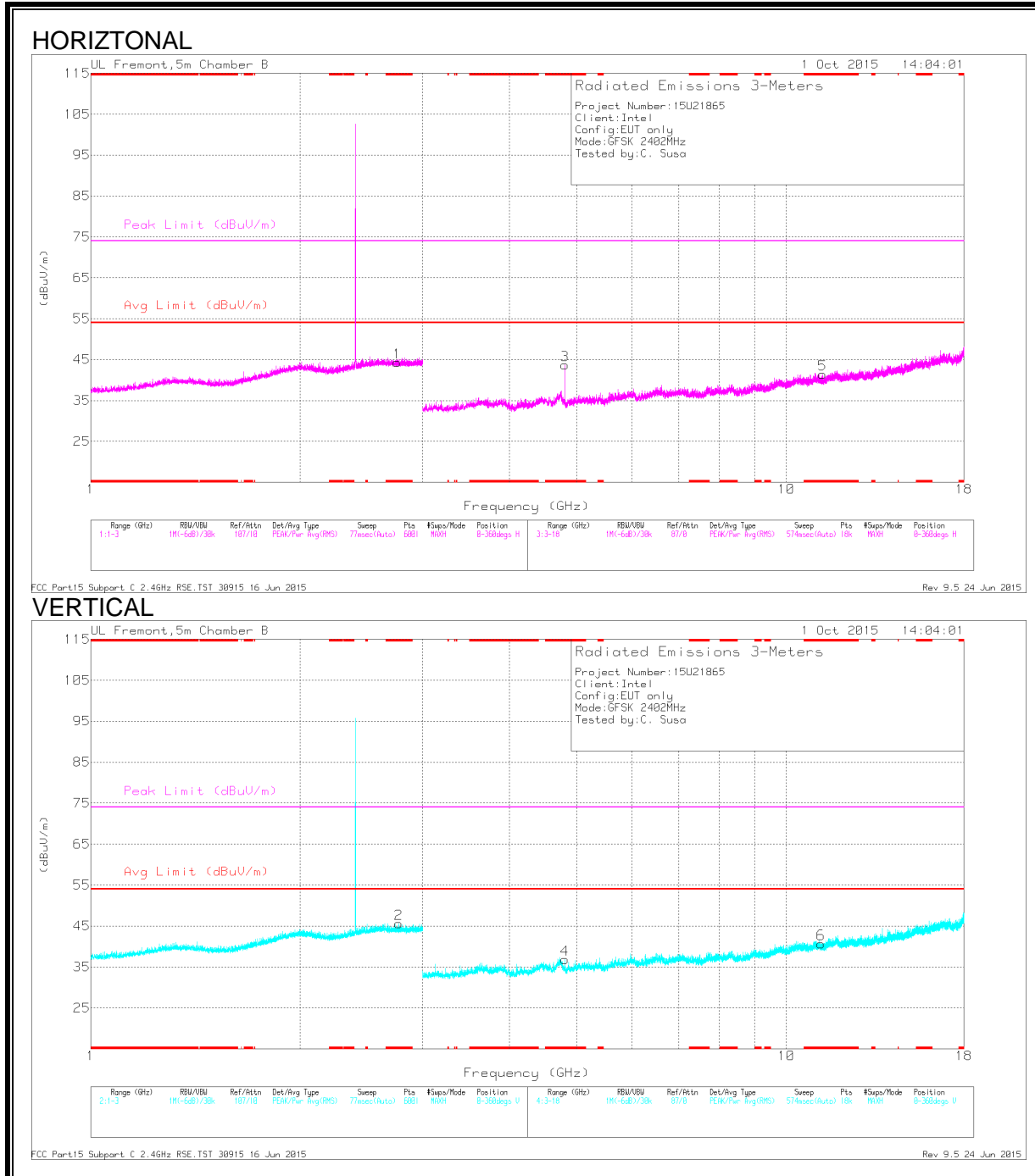

DATA

Marker	Frequency (GHz)	Meter Reading (dBuV)	Det	AF T345 (dB/m)	Amp/Cbl /Fitr/Pad (dB)	DC Corr (dB)	Corrected Reading (dBuV/m)	Avg Limit (dBuV/m)	Margin (dB)	Peak Limit (dBuV/m)	PK Margin (dB)	Azimuth (Degs)	Height (cm)	Polarity
1	* 2.755	44.1	PK2	32.6	-23.7	0	53	-	-	74	-21	360	101	H
	* 2.757	31.01	VA1T	32.6	-23.7	1.14	41.05	54	-12.95	-	-	360	102	H
2	* 2.774	43.45	PK2	32.6	-23.7	0	52.35	-	-	74	-21.65	360	200	V
	* 2.774	30.91	VA1T	32.6	-23.7	1.14	40.95	54	-13.05	-	-	360	200	V
5	* 11.282	35.97	PK2	37.9	-25.1	0	48.77	-	-	74	-25.23	360	200	H
	* 11.279	23.4	VA1T	37.9	-25.1	1.14	37.34	54	-16.66	-	-	360	200	H
3	* 4.804	45.7	PK2	34.3	-31	0	49	-	-	74	-25	213	118	H
	* 4.804	39.9	VA1T	34.3	-31	1.14	44.34	54	-9.66	-	-	213	118	H
6	* 11.223	35.93	PK2	37.8	-25.2	0	48.53	-	-	74	-25.47	360	102	V
	* 11.224	23.4	VA1T	37.8	-25.2	1.14	37.14	54	-16.86	-	-	360	102	V
4	* 4.804	42.45	PK2	34.3	-31	0	45.75	-	-	74	-28.25	256	105	V
	* 4.804	32.25	VA1T	34.3	-31	1.14	36.69	54	-17.31	-	-	256	105	V

* - indicates frequency in CFR15.205/IC7.2.2 Restricted Band

PK2 - KDB558074 Method: Maximum Peak

VA1T - FHSS: Linear Voltage Average $V_B=1/T_{on}$ where: T_{on} is transmit duration

MID CHANNEL

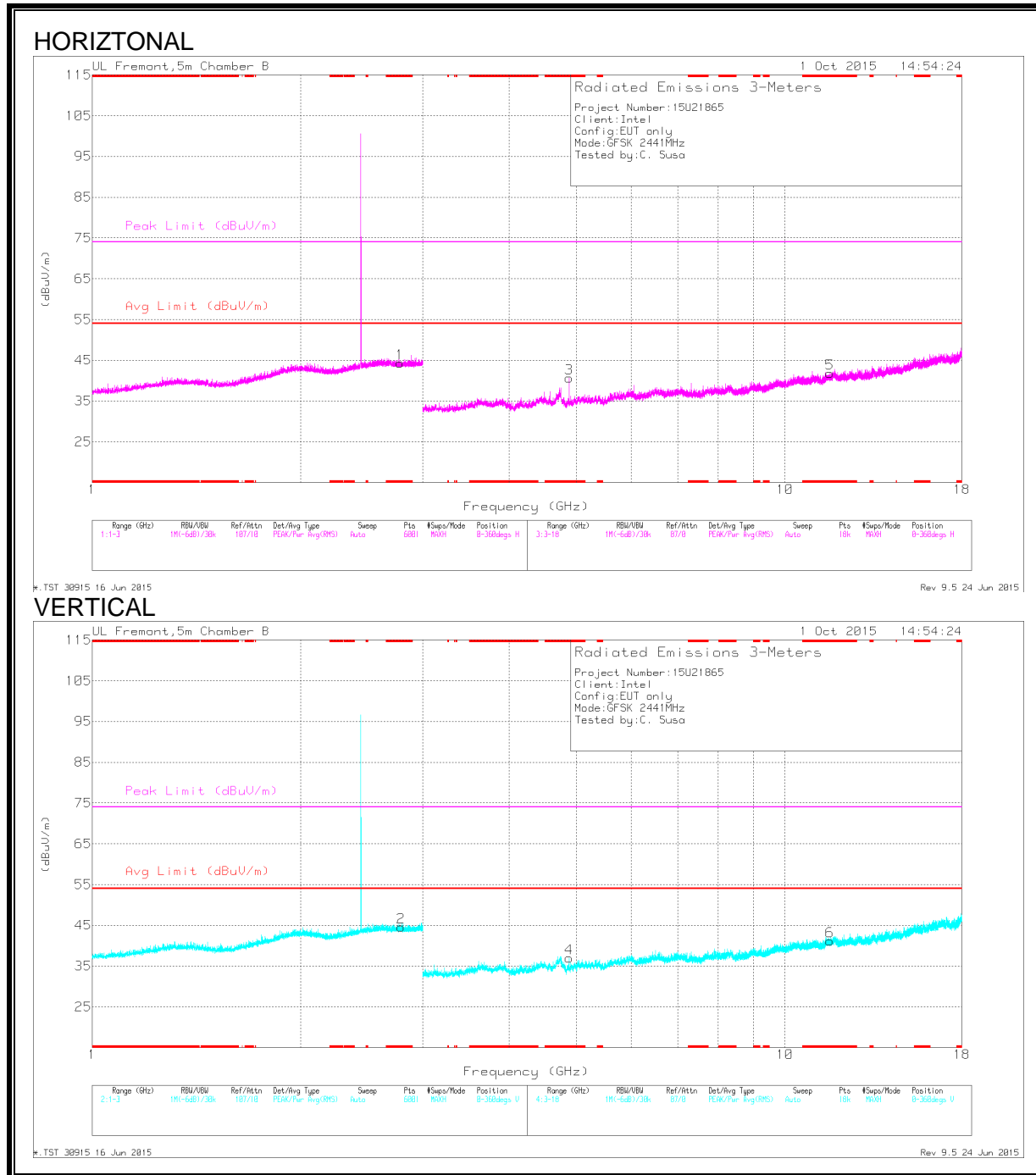

DATA

Marker	Frequency (GHz)	Meter Reading (dBuV)	Det	AF T345 (dB/m)	Amp/Cbl /Fitr/Pad (dB)	DC Corr (dB)	Corrected Reading (dBuV/m)	Avg Limit (dBuV/m)	Margin (dB)	Peak Limit (dBuV/m)	PK Margin (dB)	Azimuth (Degs)	Height (cm)	Polarity
1	* 2.782	44.28	PK2	32.6	-23.7	0	53.18	-	-	74	-20.82	360	101	H
	* 2.783	30.89	VA1T	32.6	-23.7	1.14	40.93	54	-13.07	-	-	360	101	H
2	* 2.79	43.73	PK2	32.6	-23.7	0	52.63	-	-	74	-21.37	360	101	V
	* 2.792	30.91	VA1T	32.6	-23.7	1.14	40.95	54	-13.05	-	-	360	101	V
5	* 11.609	35.88	PK2	38.4	-24.8	0	49.48	-	-	74	-24.52	360	199	H
	* 11.611	23.43	VA1T	38.4	-24.8	1.14	38.17	54	-15.83	-	-	360	199	H
3	* 4.882	44.61	PK2	34.2	-32.6	0	46.21	-	-	74	-27.79	217	236	H
	* 4.882	36.89	VA1T	34.2	-32.6	1.14	39.63	54	-14.37	-	-	217	236	H
6	* 11.61	35.87	PK2	38.4	-24.8	0	49.47	-	-	74	-24.53	360	102	V
	* 11.61	23.45	VA1T	38.4	-24.8	1.14	38.19	54	-15.81	-	-	360	102	V
4	* 4.882	41.97	PK2	34.2	-32.6	0	43.57	-	-	74	-30.43	255	103	V
	* 4.882	32.94	VA1T	34.2	-32.6	1.14	35.68	54	-18.32	-	-	255	103	V

* - indicates frequency in CFR15.205/IC7.2.2 Restricted Band

PK2 - KDB558074 Method: Maximum Peak

VA1T - FHSS: Linear Voltage Average $VB=1/Ton$ where: Ton is transmit duration

HIGH CHANNEL

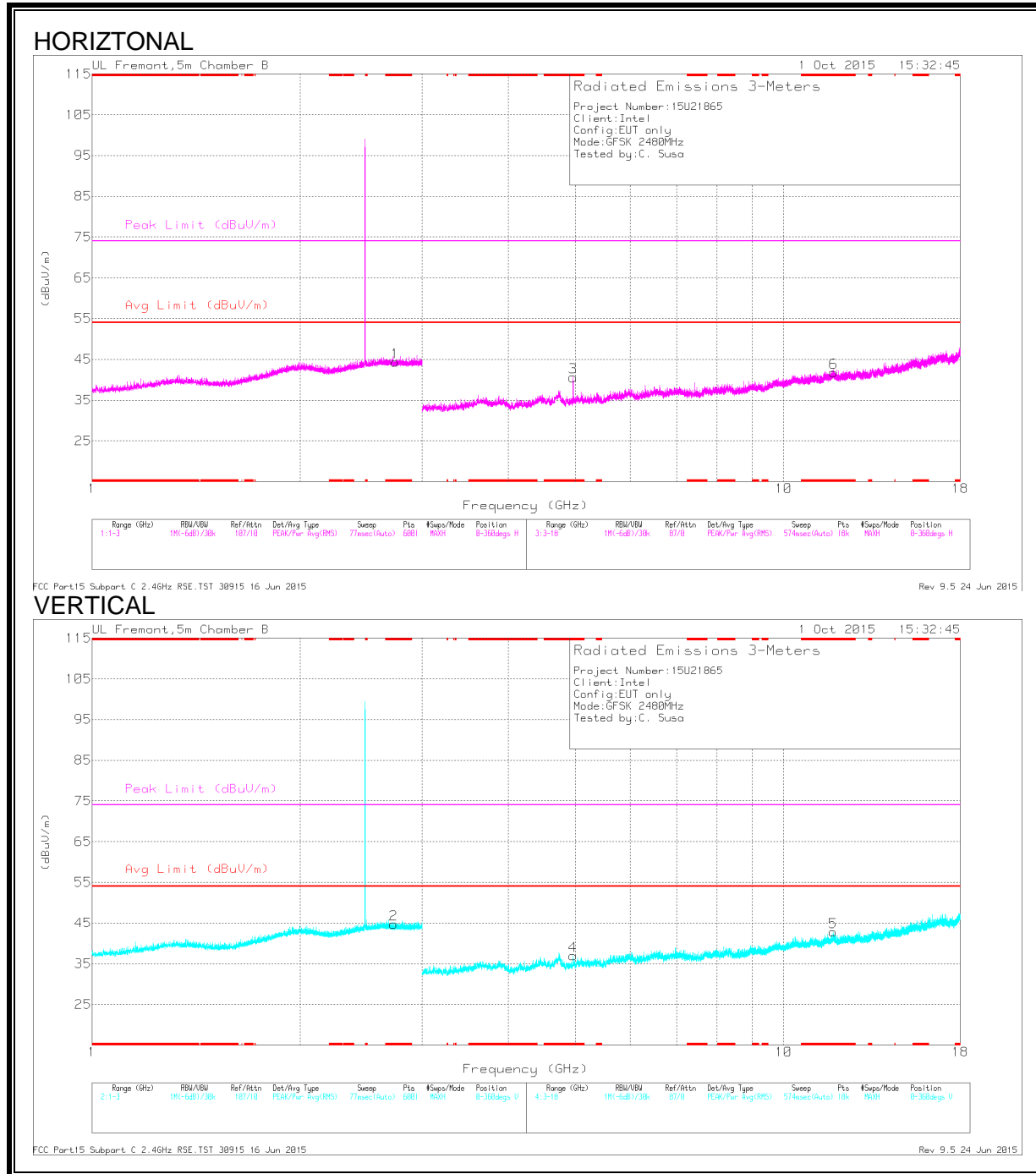

DATA

Marker	Frequency (GHz)	Meter Reading (dBuV)	Det	AF T345 (dB/m)	Amp/Cbl /Fitr/Pad (dB)	DC Corr (dB)	Corrected Reading (dBuV/m)	Avg Limit (dBuV/m)	Margin (dB)	Peak Limit (dBuV/m)	PK Margin (dB)	Azimuth (Degs)	Height (cm)	Polarity
1	* 2.743	43.53	PK2	32.6	-23.8	0	52.33	-	-	74	-21.67	359	199	H
	* 2.746	30.99	VA1T	32.6	-23.8	1.14	40.93	54	-13.07	-	-	359	199	H
2	* 2.732	43.77	PK2	32.6	-23.8	0	52.57	-	-	74	-21.43	359	102	V
	* 2.73	30.92	VA1T	32.6	-23.7	1.14	40.96	54	-13.04	-	-	359	102	V
6	* 11.813	36.03	PK2	38.6	-24.1	0	50.53	-	-	74	-23.47	359	102	H
	* 11.812	23.13	VA1T	38.6	-24.1	1.14	38.77	54	-15.23	-	-	359	102	H
3	* 4.96	43.72	PK2	34.1	-31.9	0	45.92	-	-	74	-28.08	219	274	H
	* 4.96	35.35	VA1T	34.1	-31.9	1.14	38.69	54	-15.31	-	-	219	274	H
5	* 11.78	35.71	PK2	38.6	-24.3	0	50.01	-	-	74	-23.99	359	199	V
	* 11.783	23.4	VA1T	38.6	-24.3	1.14	38.84	54	-15.16	-	-	359	199	V
4	* 4.96	43.31	PK2	34.1	-31.9	0	45.51	-	-	74	-28.49	265	101	V
	* 4.96	32.77	VA1T	34.1	-31.9	1.14	36.11	54	-17.89	-	-	265	101	V

* - indicates frequency in CFR15.205/IC7.2.2 Restricted Band

PK2 - KDB558074 Method: Maximum Peak

VA1T - FHSS: Linear Voltage Average VB=1/Ton where: Ton is transmit duration

8.3. TX ABOVE 1 GHz ENHANCED DATA RATE 8PSK MODULATION

RESTRICTED BANDEDGE (LOW CHANNEL)

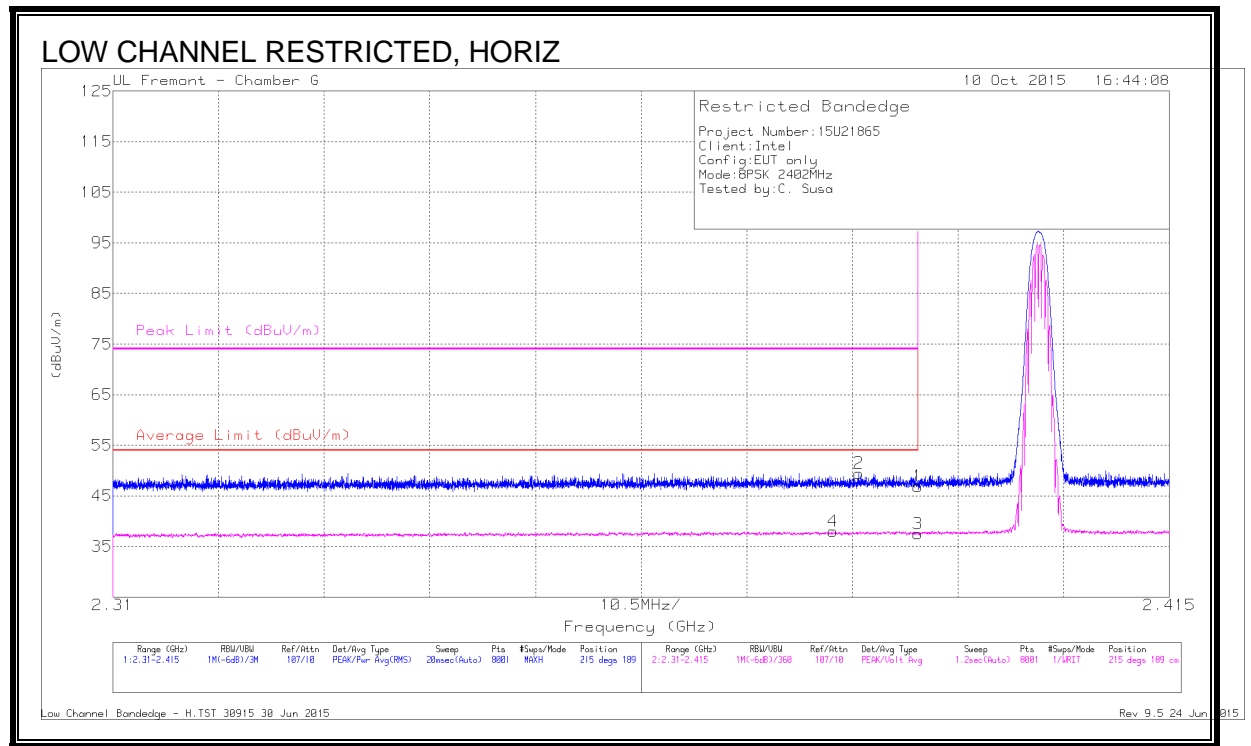

Trace Markers

Marker	Frequency (GHz)	Meter Reading (dBuV)	Det	AF T862 (dB/m)	Amp/Cbl/Fit r/Pad (dB)	DC Corr (dB)	Corrected Reading (dBuV/m)	Average Limit (dBuV/m)	Margin (dB)	Peak Limit (dBuV/m)	PK Margin (dB)	Azimuth (Degs)	Height (cm)	Polarity
4	* 2.382	29.6	VA1T	31.8	-24.5	1.13	38.03	54	-15.97	-	-	215	189	H
2	* 2.384	42.18	Pk	31.8	-24.5	0	49.48	-	-	74	-24.52	215	189	H
1	* 2.39	39.48	Pk	31.9	-24.5	0	46.88	-	-	74	-27.12	215	189	H
3	* 2.39	28.98	VA1T	31.9	-24.5	1.13	37.51	54	-16.49	-	-	215	189	H

* - indicates frequency in CFR15.205/IC7.2.2 Restricted Band

Pk - Peak detector

VA1T - FHSS: Linear Voltage Average $VB=1/Ton$ where: Ton is transmit duration

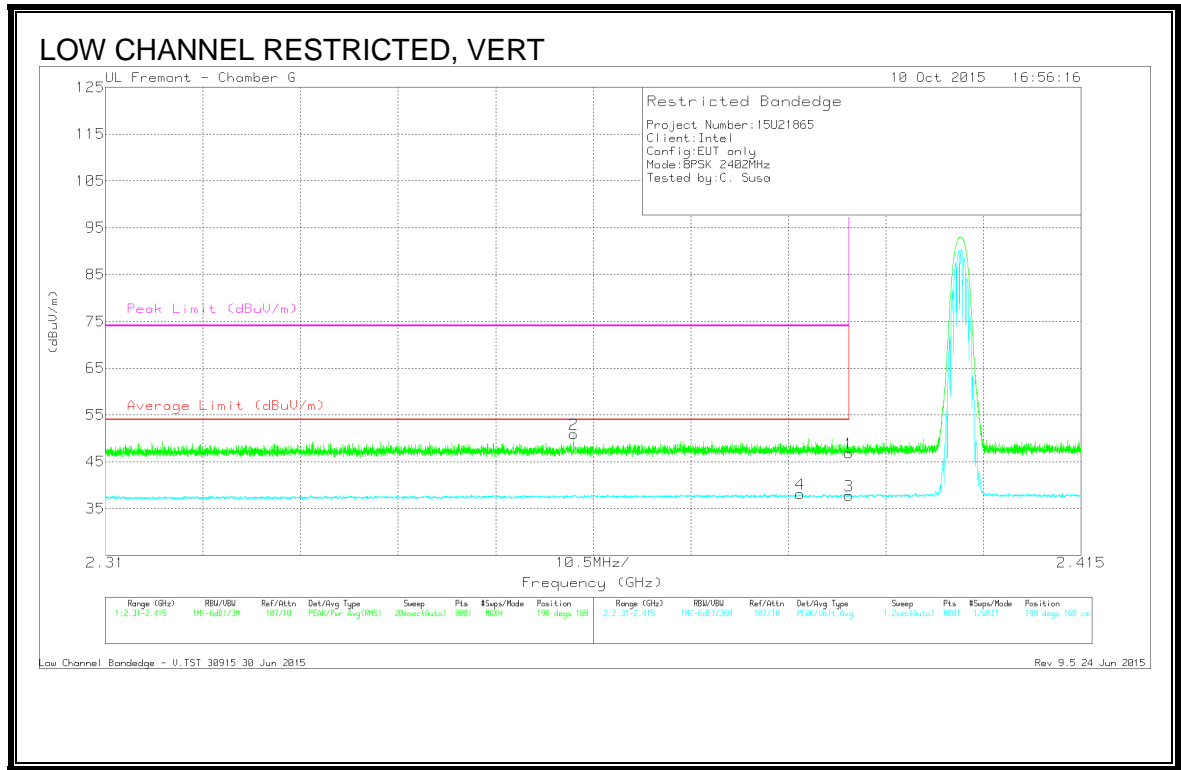

Trace Markers

Marker	Frequency (GHz)	Meter Reading (dBuV)	Det	AF T862 (dB/m)	Amp/Cbl/Fit r/Pad (dB)	DC Corr (dB)	Corrected Reading (dBuV/m)	Average Limit (dBuV/m)	Margin (dB)	Peak Limit (dBuV/m)	PK Margin (dB)	Azimuth (Degs)	Height (cm)	Polarity
2	* 2.36	43.72	Pk	31.7	-24.5	0	50.92	-	-	74	-23.08	198	168	V
4	* 2.385	29.65	VA1T	31.8	-24.5	1.13	38.08	54	-15.92	-	-	198	168	V
1	* 2.39	39.42	Pk	31.9	-24.5	0	46.82	-	-	74	-27.18	198	168	V
3	* 2.39	29.26	VA1T	31.9	-24.5	1.13	37.79	54	-16.21	-	-	198	168	V

* - indicates frequency in CFR15.205/IC7.2.2 Restricted Band

Pk - Peak detector

VA1T - FHSS: Linear Voltage Average $V_B=1/T_{on}$ where: T_{on} is transmit duration

AUTHORIZED BANDEDGE (HIGH CHANNEL)

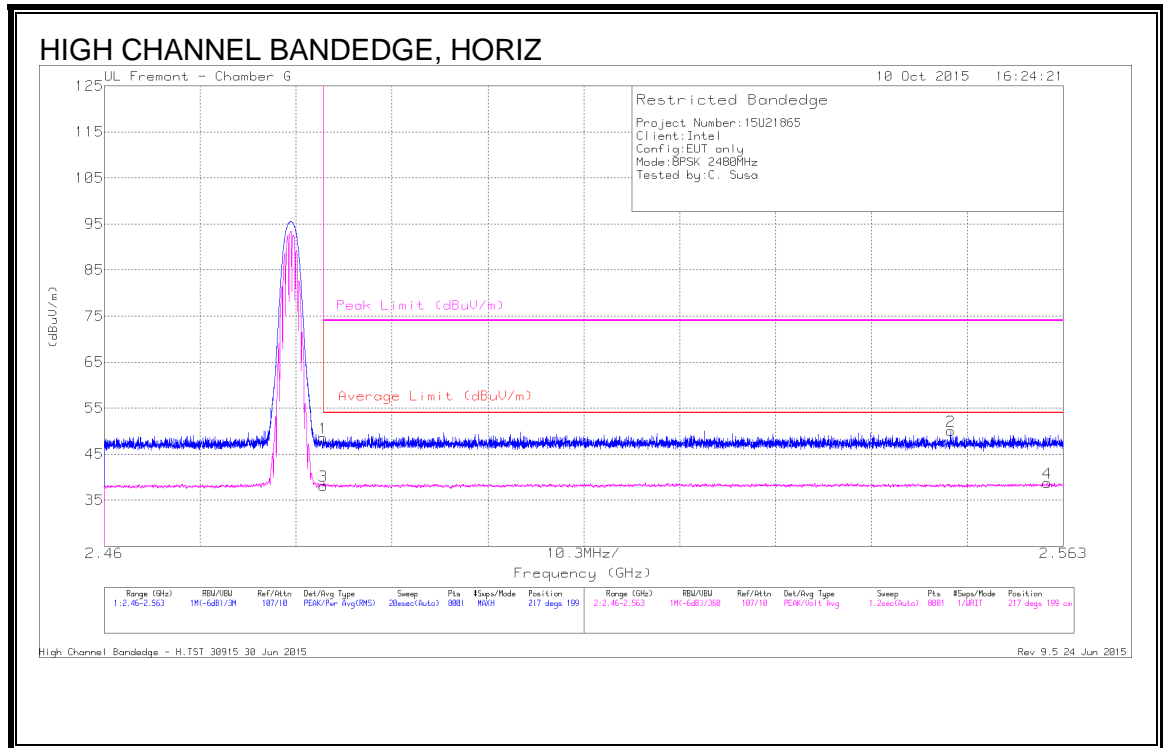

Marker	Frequency (GHz)	Meter Reading (dBuV)	Det	AF T862 (dB/m)	Amp/Cbl/FI tr/Pad (dB)	DC Corr (dB)	Corrected Reading (dBuV/m)	Average Limit (dBuV/m)	Margin (dB)	Peak Limit (dBuV/m)	PK Margin (dB)	Azimuth (Degs)	Height (cm)	Polarity
1	* 2.484	40.75	Pk	32.3	-24.5	0	48.55	-	-	74	-25.45	217	199	H
3	* 2.484	29.24	VA1T	32.3	-24.5	1.13	38.17	54	-15.83	-	-	217	199	H
2	2.551	42.19	Pk	32.4	-24.5	0	50.09	-	-	74	-23.91	217	199	H
4	2.561	29.74	VA1T	32.4	-24.5	1.13	38.77	54	-15.23	-	-	217	199	H

* - indicates frequency in CFR15.205/IC7.2.2 Restricted Band

Pk - Peak detector

VA1T - FHSS: Linear Voltage Average VB=1/Ton where: Ton is transmit duration

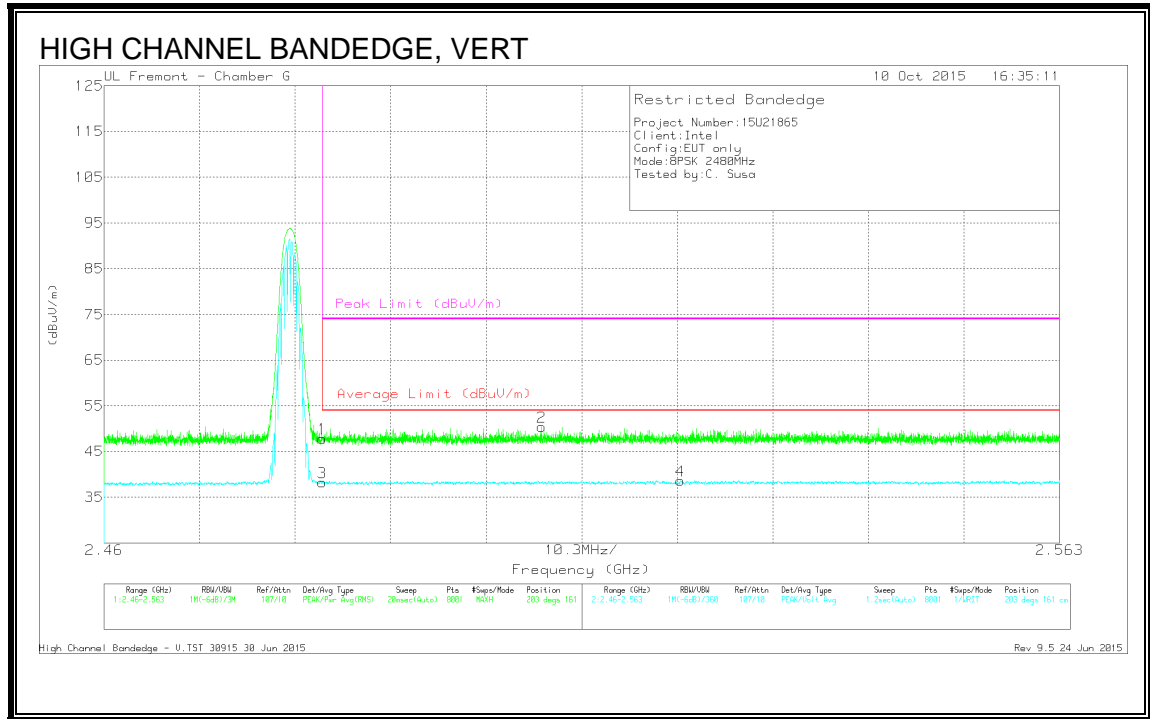

Trace Markers

Marker	Frequency (GHz)	Meter Reading (dBuV)	Det	AF T862 (dB/m)	Amp/Cb/FI tr/Pad (dB)	DC Corr (dB)	Corrected Reading (dBuV/m)	Average Limit (dBuV/m)	Margin (dB)	Peak Limit (dBuV/m)	PK Margin (dB)	Azimuth (Degs)	Height (cm)	Polarity
1	* 2.484	40.07	Pk	32.3	-24.5	0	47.87	-	-	74	-26.13	203	161	V
3	* 2.484	29.34	VA1T	32.3	-24.5	1.13	38.27	54	-15.73	-	-	203	161	V
2	2.507	42.48	Pk	32.4	-24.5	0	50.38	-	-	74	-23.62	203	161	V
4	2.522	29.63	VA1T	32.4	-24.5	1.13	38.66	54	-15.34	-	-	203	161	V

* - indicates frequency in CFR15.205/IC7.2.2 Restricted Band

Pk - Peak detector

VA1T - FHSS: Linear Voltage Average VB=1/Ton where: Ton is transmit duration

HARMONICS AND SPURIOUS EMISSIONS

LOW CHANNEL

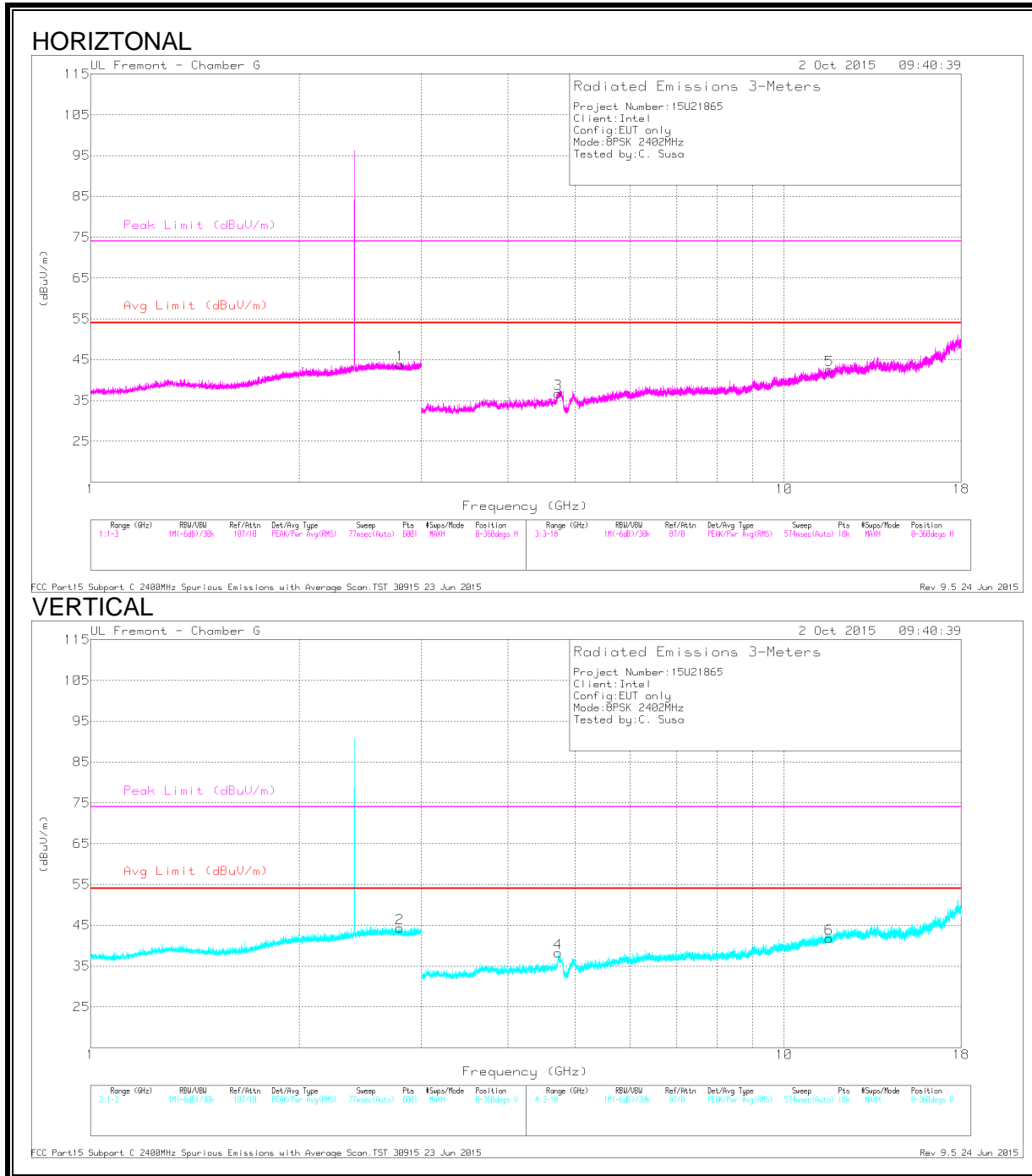

DATA

Marker	Frequency (GHz)	Meter Reading (dBuV)	Det	AF T862 (dB/m)	Amp/Cbl /Fitr/Pad (dB)	DC Corr (dB)	Corrected Reading (dBuV/m)	Avg Limit (dBuV/m)	Margin (dB)	Peak Limit (dBuV/m)	PK Margin (dB)	Azimuth (Degs)	Height (cm)	Polarity
1	* 2.796	43.51	PK2	32.3	-24.4	0	51.41	-	-	74	-22.59	0	101	H
	* 2.796	30.85	VA1T	32.3	-24.4	1.13	39.88	54	-14.12	-	-	0	101	H
2	* 2.792	43.95	PK2	32.3	-24.4	0	51.85	-	-	74	-22.15	0	201	V
	* 2.794	31.13	VA1T	32.3	-24.4	1.13	40.16	54	-13.84	-	-	0	201	V
5	* 11.632	38.22	PK2	38.3	-25.4	0	51.12	-	-	74	-22.88	0	102	H
	* 11.634	25.34	VA1T	38.3	-25.4	1.13	39.37	54	-14.63	-	-	0	102	H
4	* 4.721	43.65	PK2	33.9	-32.3	0	45.25	-	-	74	-28.75	0	201	H
	* 4.725	31.35	VA1T	33.9	-32.3	1.13	34.08	54	-19.92	-	-	0	201	H
6	* 11.617	38.14	PK2	38.3	-25.7	0	50.74	-	-	74	-23.26	0	201	V
	* 11.618	25.44	VA1T	38.3	-25.6	1.13	39.27	54	-14.73	-	-	0	201	V
3	* 4.723	44.51	PK2	33.9	-32.3	0	46.11	-	-	74	-27.89	0	201	V
	* 4.722	31.46	VA1T	33.9	-32.3	1.13	34.19	54	-19.81	-	-	0	201	V

* - indicates frequency in CFR15.205/IC7.2.2 Restricted Band

PK2 - KDB558074 Method: Maximum Peak

VA1T - FHSS: Linear Voltage Average VB=1/Ton where: Ton is transmit duration

MID CHANNEL

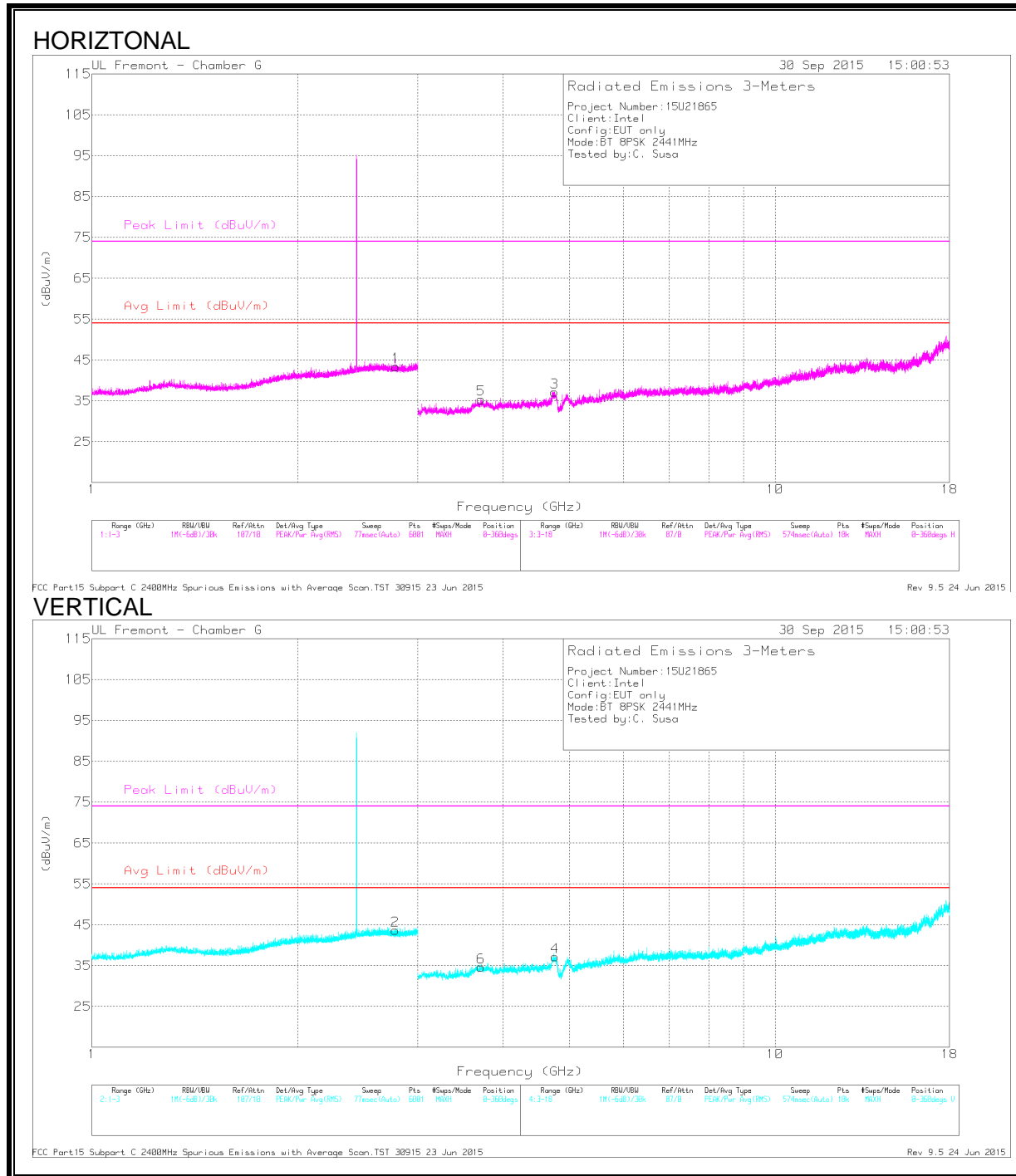

DATA

Marker	Frequency (GHz)	Meter Reading (dBuV)	Det	AF T862 (dB/m)	Amp/Cbl /Fitr/Pad (dB)	DC Corr (dB)	Corrected Reading (dBuV/m)	Avg Limit (dBuV/m)	Margin (dB)	Peak Limit (dBuV/m)	PK Margin (dB)	Azimuth (Degs)	Height (cm)	Polarity
1	* 2.785	31.21	VA1T	32.3	-24.4	1.13	40.24	54	-13.76	-	-	259	219	H
	* 2.783	44.89	PK2	32.3	-24.4	0	52.79	-	-	74	-21.21	259	219	H
2	* 2.777	44.05	PK2	32.3	-24.4	0	51.95	-	-	74	-22.05	296	159	V
	* 2.777	31.2	VA1T	32.3	-24.4	1.13	40.23	54	-13.77	-	-	296	159	V
3	* 4.761	44.13	PK2	34	-32.5	0	45.63	-	-	74	-28.37	146	321	H
	* 4.761	31.43	VA1T	34	-32.5	1.13	34.06	54	-19.94	-	-	146	321	H
5	* 3.715	41.74	PK2	33	-31.4	0	43.34	-	-	74	-30.66	97	289	H
	* 3.712	29	VA1T	33	-31.4	1.13	31.73	54	-22.27	-	-	97	289	H
4	* 4.765	43.59	PK2	34	-32.5	0	45.09	-	-	74	-28.91	316	140	V
	* 4.766	31.6	VA1T	34	-32.5	1.13	34.23	54	-19.77	-	-	316	140	V
6	* 3.714	41.74	PK2	33	-31.4	0	43.34	-	-	74	-30.66	223	179	V
	* 3.713	29.2	VA1T	33	-31.4	1.13	31.93	54	-22.07	-	-	223	179	V

HIGH CHANNEL

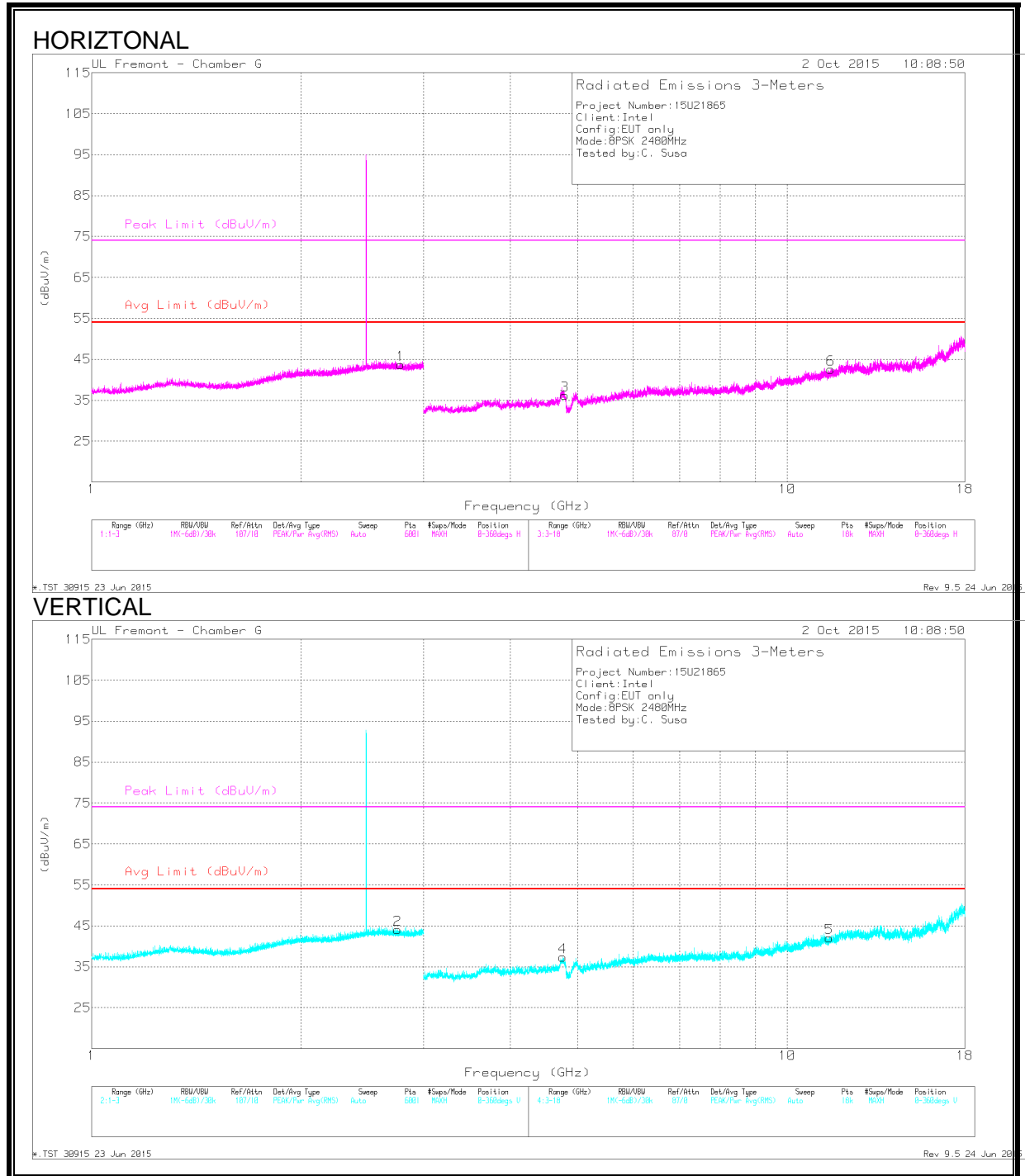

DATA

Marker	Frequency (GHz)	Meter Reading (dBuV)	Det	AF T862 (dB/m)	Amp/Cbl /Filtr/Pad (dB)	DC Corr (dB)	Corrected Reading (dBuV/m)	Avg Limit (dBuV/m)	Margin (dB)	Peak Limit (dBuV/m)	PK Margin (dB)	Azimuth (Degs)	Height (cm)	Polarity
1	* 2.782	44.56	PK2	32.3	-24.4	0	52.46	-	-	74	-21.54	0	203	H
	* 2.78	31.25	VA1T	32.3	-24.4	1.13	40.28	54	-13.72	-	-	0	203	H
2	* 2.754	43.94	PK2	32.3	-24.4	0	51.84	-	-	74	-22.16	0	101	V
	* 2.754	30.95	VA1T	32.3	-24.4	1.13	39.98	54	-14.02	-	-	0	101	V
3	* 4.787	43.57	PK2	34	-32.6	0	44.97	-	-	74	-29.03	0	101	H
	* 4.785	31.04	VA1T	34	-32.6	1.13	33.57	54	-20.43	-	-	0	101	H
6	* 11.548	37.92	PK2	38.3	-25.7	0	50.52	-	-	74	-23.48	0	202	H
	* 11.548	25.53	VA1T	38.3	-25.7	1.13	39.26	54	-14.74	-	-	0	202	H
4	* 4.759	44.2	PK2	33.9	-32.5	0	45.6	-	-	74	-28.4	0	202	V
	* 4.76	31.7	VA1T	34	-32.5	1.13	34.33	54	-19.67	-	-	0	202	V
5	* 11.488	38.39	PK2	38.2	-25.9	0	50.69	-	-	74	-23.31	0	202	V
	* 11.49	25.68	VA1T	38.2	-25.9	1.13	39.11	54	-14.89	-	-	0	202	V

* - indicates frequency in CFR15.205/IC7.2.2 Restricted Band

PK2 - KDB558074 Method: Maximum Peak

VA1T - FHSS: Linear Voltage Average VB=1/Ton where: Ton is transmit duration

8.4. WORST-CASE BELOW 1 GHz

SPURIOUS EMISSIONS 30 TO 1000 MHz (WORST-CASE CONFIGURATION)

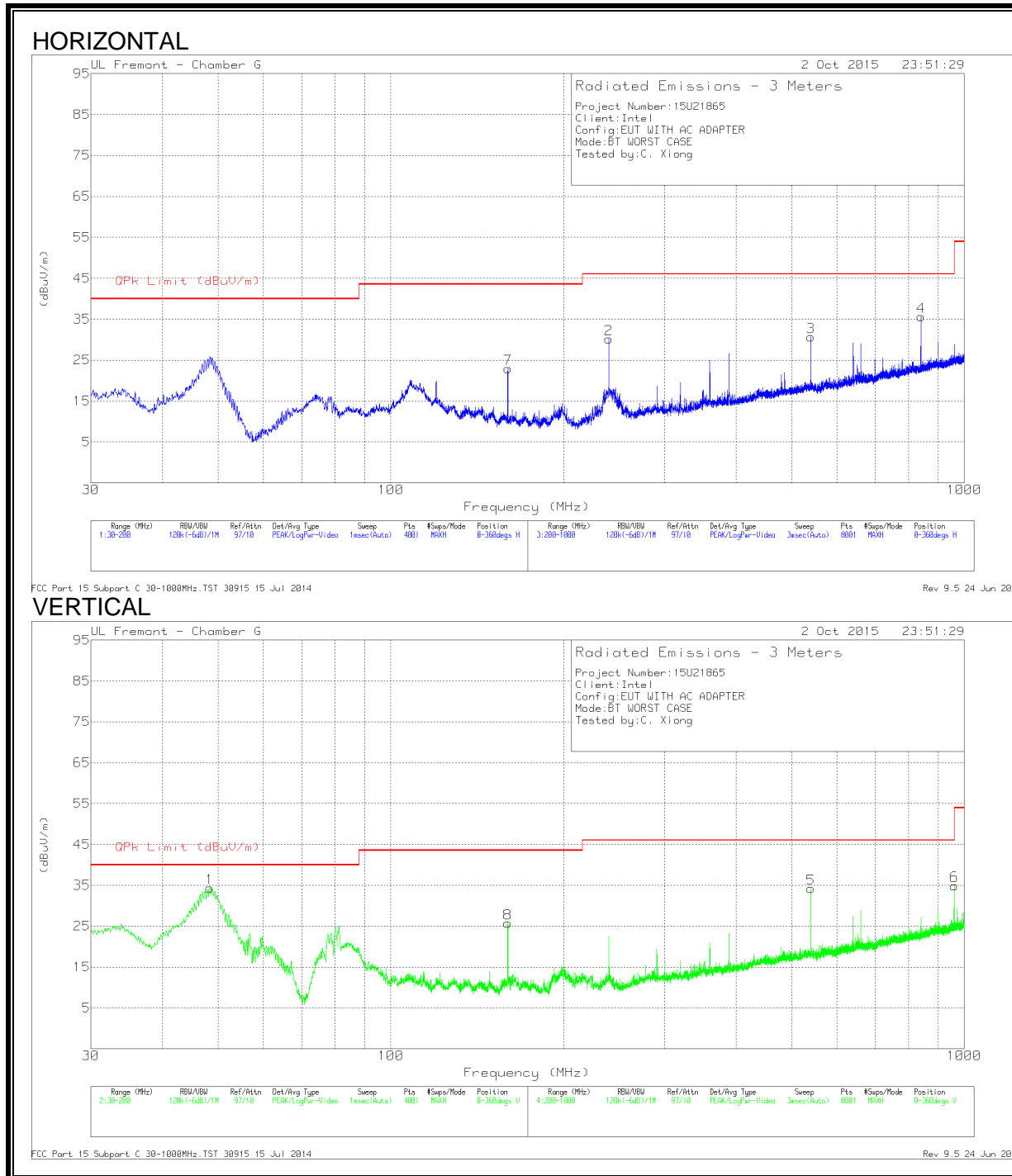

DATA

Marker	Frequency (MHz)	Meter Reading (dBuV)	Det	AF T899 (dB/m)	Amp Cbl (dB)	DC Corr (dB)	Corrected Reading (dBuV/m)	QPk Limit (dBuV/m)	Margin (dB)	Azimuth (Degs)	Height (cm)	Polarity
2	* 240	48.27	Pk	11.2	-29.3	0	30.17	46.02	-15.85	0-360	100	H
6	* 960	37.53	Pk	22.7	-25.3	0	34.93	46.02	-11.09	0-360	100	V
1	48.4025	57.07	Pk	8.3	-31	0	34.37	40	-5.63	0-360	100	V
	48.4375	54.32	Qp	8.3	-31	1.13	32.75	40	-7.25	101	103	V
8	159.965	43.54	Pk	12.1	-29.9	0	25.74	43.52	-17.78	0-360	100	V
7	160.0075	40.71	Pk	12.1	-29.9	0	22.91	43.52	-20.61	0-360	201	H
3	540	40.11	Pk	18.3	-27.7	0	30.71	46.02	-15.31	0-360	201	H
5	540	43.59	Pk	18.3	-27.7	0	34.19	46.02	-11.83	0-360	100	V
4	840	40.72	Pk	21.3	-26.4	0	35.62	46.02	-10.4	0-360	100	H

* - indicates frequency in CFR15.205/IC7.2.2 Restricted Band
 Pk - Peak detector
 Qp - Quasi-Peak detector

8.5. WORST-CASE ABOVE 18 GHz

SPURIOUS EMISSIONS 18 TO 26 GHz (WORST-CASE CONFIGURATION)

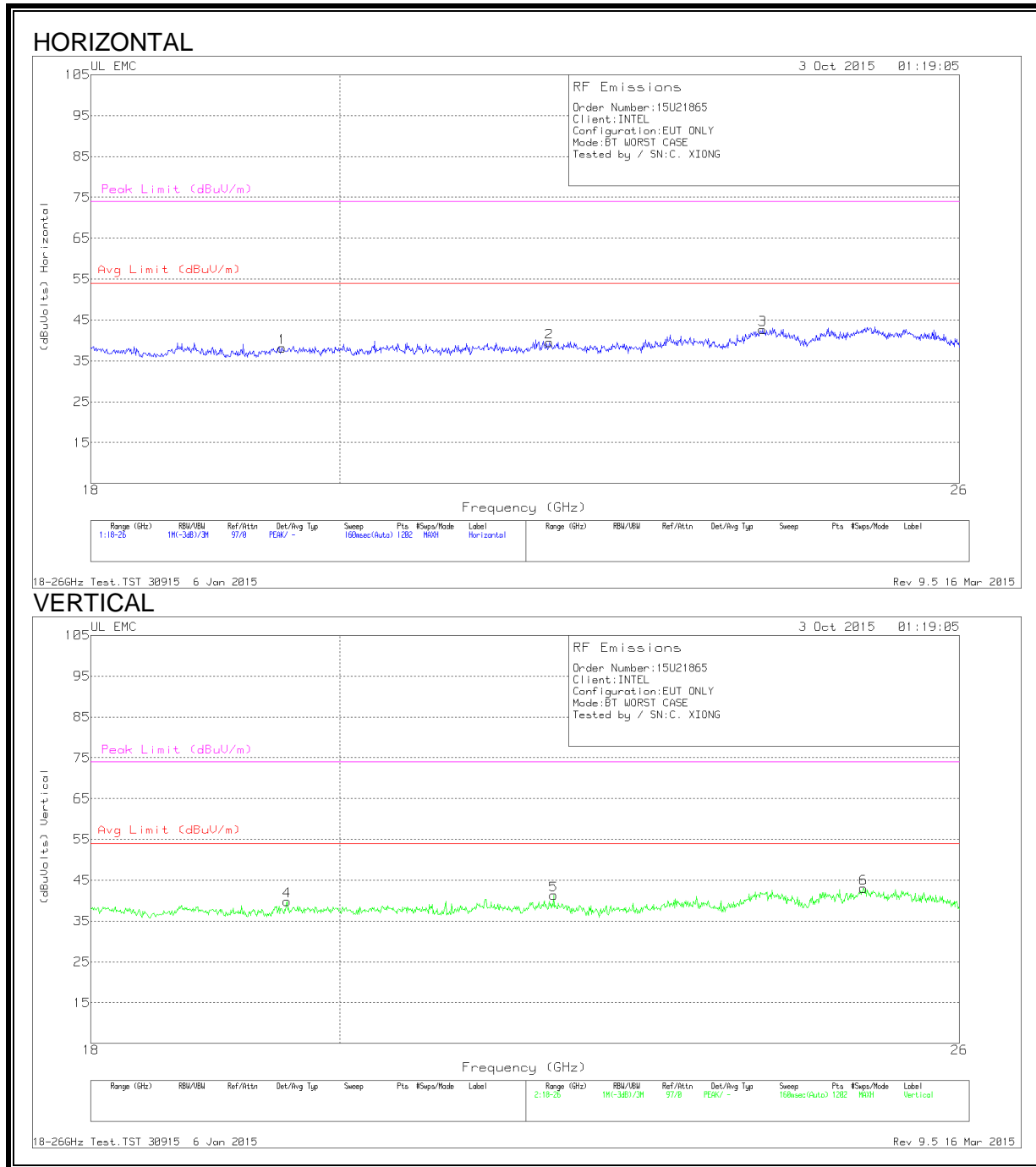

DATA

Marker	Frequency (GHz)	Meter Reading (dBuV)	Det	T89 AF (dB/m)	Amp/Cbl (dB)	Dist Corr (dB)	Corrected Reading (dBuVolts)	Avg Limit (dBuV/m)	Margin (dB)	Peak Limit (dBuV/m)	PK Margin (dB)
1	19.519	40.37	Pk	32.5	-25.2	-9.5	38.167	54	-15.833	74	-35.833
2	21.857	40.3	Pk	33.3	-24.6	-9.5	39.5	54	-14.5	74	-34.5
3	23.922	42.67	Pk	33.4	-23.9	-9.5	42.667	54	-11.333	74	-31.333
4	19.559	41.93	Pk	32.5	-25.1	-9.5	39.833	54	-14.167	74	-34.167
5	21.897	42.83	Pk	33.3	-25.3	-9.5	41.333	54	-12.667	74	-32.667
6	24.964	42.7	Pk	34.1	-24.3	-9.5	43	54	-11	74	-31

Pk - Peak detector

9. AC POWER LINE CONDUCTED EMISSIONS

LIMITS

FCC §15.207 (a)

RSS-Gen 8.8

Frequency of Emission (MHz)	Conducted Limit (dBµV)	
	Quasi-peak	Average
0.15-0.5	66 to 56 *	56 to 46 *
0.5-5	56	46
5-30	60	50

TEST PROCEDURE

The EUT is placed on a non-conducting table 40 cm from the vertical ground plane and 80 cm above the horizontal ground plane. The EUT is configured in accordance with ANSI C63.4.

The receiver is set to a resolution bandwidth of 9 kHz. Peak detection is used unless otherwise noted as quasi-peak or average.

Line conducted data is recorded for both NEUTRAL and HOT lines.

RESULTS

9.1. EUT WITH AC ADAPTER

LINE 1 RESULTS

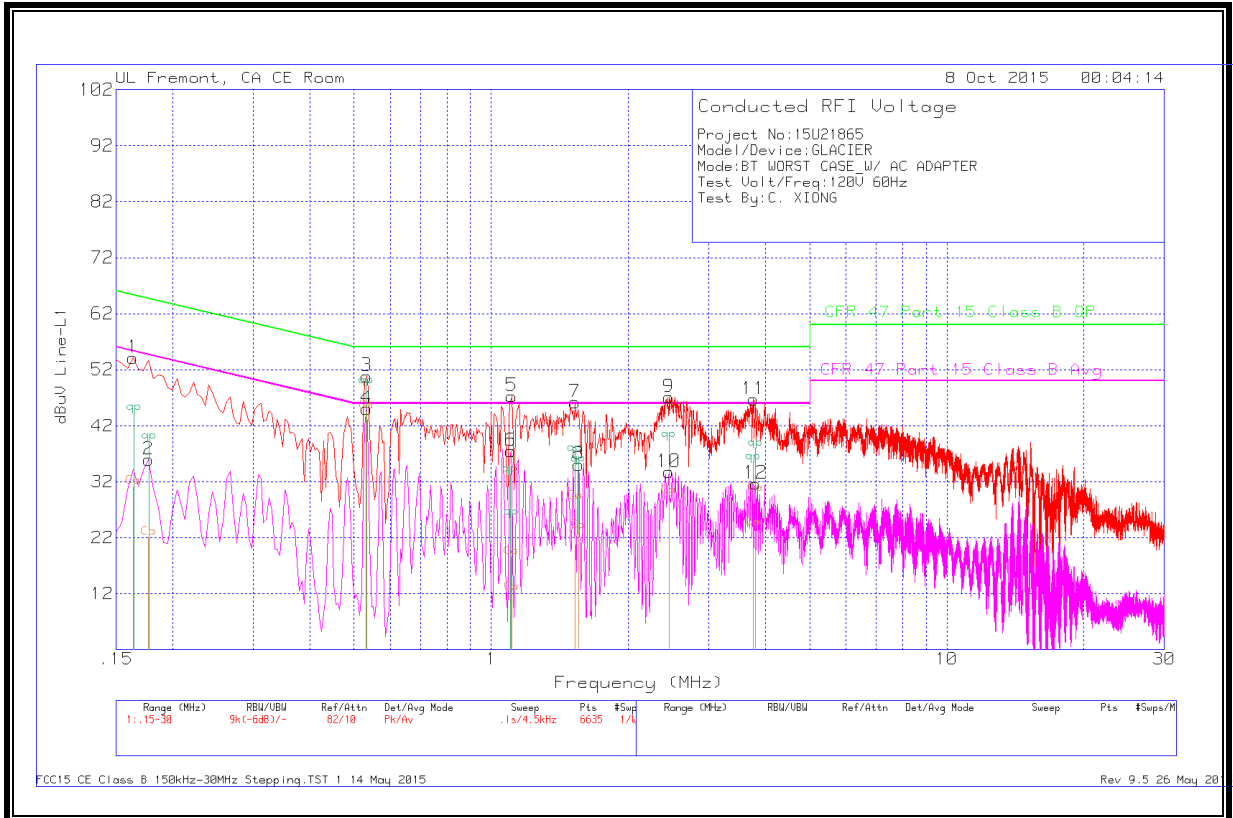

DATA

Range 1: Line-L1 .15 - 30MHz

Frequency (MHz)	Meter Reading (dBuV)	Det	T24 IL L1	LC Cables 1&3	Corrected Reading dBuV	CFR 47 Part 15 Class B QP	Margin (dB)	CFR 47 Part 15 Class B Avg	Margin (dB)
.16463	43.13	Qp	1.2	0	44.33	65.23	-20.9	-	-
.16463	29.95	Ca	1.2	0	31.15	-	-	55.23	-24.08
.17768	38.08	Qp	1.1	0	39.18	64.59	-25.41	-	-
.17768	20.95	Ca	1.1	0	22.05	-	-	54.59	-32.54
.53138	48.8	Qp	.3	0	49.1	56	-6.9	-	-
.53138	44.29	Ca	.3	0	44.59	-	-	46	-1.41
1.10918	25.43	Qp	.2	0	25.63	56	-30.37	-	-
1.10918	12.01	Ca	.2	0	12.21	-	-	46	-33.79
1.10288	33.11	Qp	.2	0	33.31	56	-22.69	-	-
1.10288	18.34	Ca	.2	0	18.54	-	-	46	-27.46
1.52813	36.72	Qp	.2	.1	37.02	56	-18.98	-	-
1.52813	28.19	Ca	.2	.1	28.49	-	-	46	-17.51
1.55378	34.78	Qp	.2	.1	35.08	56	-20.92	-	-
1.55378	22.93	Ca	.2	.1	23.23	-	-	46	-22.77
2.45468	39.17	Qp	.2	.1	39.47	56	-16.53	-	-
2.45468	29.12	Ca	.2	.1	29.42	-	-	46	-16.58
3.76238	35.17	Qp	.2	.1	35.47	56	-20.53	-	-
3.76238	23.38	Ca	.2	.1	23.68	-	-	46	-22.32
3.80468	37.67	Qp	.2	.1	37.97	56	-18.03	-	-
3.80468	29.5	Ca	.2	.1	29.8	-	-	46	-16.2

Ca - CISPR average detection
 Qp - Quasi-Peak detector

LINE 2 RESULTS

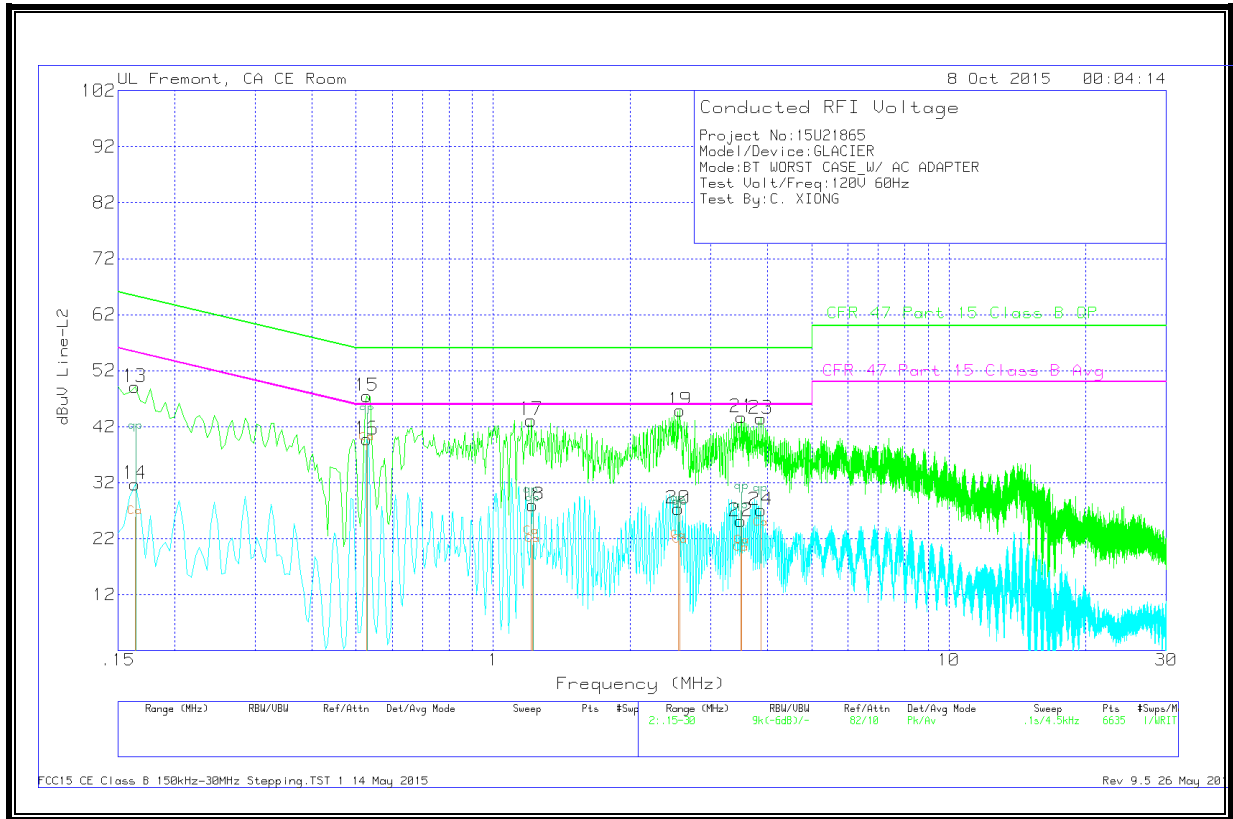

DATA

Range 2: Line-L2 .15 - 30MHz

Frequency (MHz)	Meter Reading (dBuV)	Det	T24 IL L2	LC Cables 2&3	Corrected Reading dBuV	CFR 47 Part 15 Class B QP	Margin (dB)	CFR 47 Part 15 Class B Avg	Margin (dB)
.16418	39.85	Qp	1.3	0	41.15	65.25	-24.1	-	-
.16418	24.58	Ca	1.3	0	25.88	-	-	55.25	-29.37
.52913	44.09	Qp	.3	0	44.39	56	-11.61	-	-
.52913	38.72	Ca	.3	0	39.02	-	-	46	-6.98
1.21088	29.51	Qp	.2	0	29.71	56	-26.29	-	-
1.21088	22.14	Ca	.2	0	22.34	-	-	46	-23.66
1.22213	27.92	Qp	.2	.1	28.22	56	-27.78	-	-
1.22213	20.54	Ca	.2	.1	20.84	-	-	46	-25.16
2.56988	27.23	Qp	.2	.1	27.53	56	-28.47	-	-
2.56988	20.49	Ca	.2	.1	20.79	-	-	46	-25.21
2.54738	27.87	Qp	.2	.1	28.17	56	-27.83	-	-
2.54738	21.3	Ca	.2	.1	21.6	-	-	46	-24.4
3.51218	30.03	Qp	.2	.1	30.33	56	-25.67	-	-
3.51218	20.38	Ca	.2	.1	20.68	-	-	46	-25.32
3.49868	26.66	Qp	.2	.1	26.96	56	-29.04	-	-
3.49868	19.04	Ca	.2	.1	19.34	-	-	46	-26.66
3.86588	29.67	Qp	.2	.1	29.97	56	-26.03	-	-
3.86588	23.5	Ca	.2	.1	23.8	-	-	46	-22.2

Ca - CISPR average detection
 Qp - Quasi-Peak detector

9.2. EUT WITH USB LAPTOP

LINE 1 RESULTS

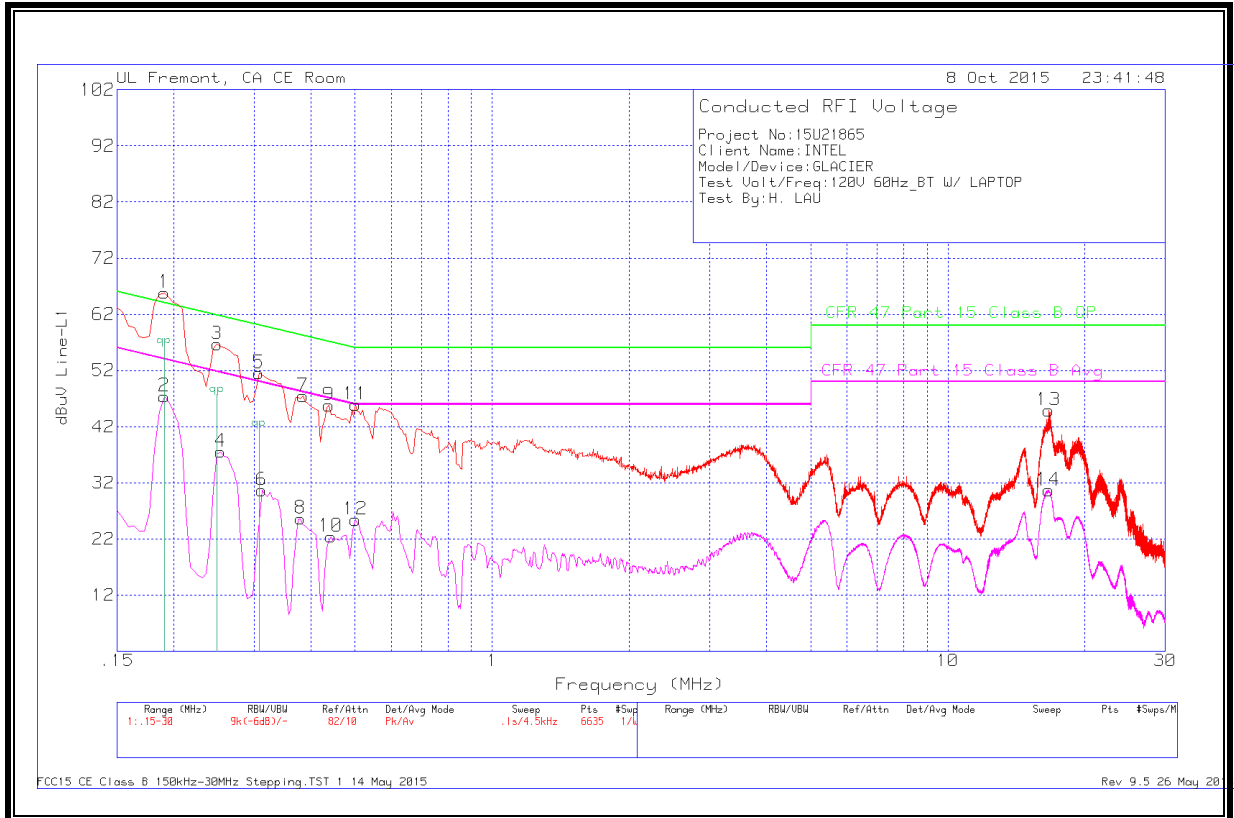

DATA

Range 1: Line-L1 .15 - 30MHz

Marker	Frequenc y (MHz)	Meter Reading (dBuV)	Det	T24 IL L1	LC Cables 1&3	Corrected Reading dBuV	CFR 47 Part 15 Class B QP	Margin (dB)	CFR 47 Part 15 Class B Avg	Margin (dB)
1	.1905	55.31	Qp	1	0	56.31	64.01	-7.7	-	-
2	.1905	46.39	Av	1	0	47.39	-	-	54.01	-6.62
3	.249	55.98	Pk	.7	0	56.68	61.79	-5.11	-	-
	.249	46.98	Qp	.7	0	47.68	61.79	-14.11	-	-
4	.2535	36.85	Av	.7	0	37.55	-	-	51.64	-14.09
5	.3075	51.02	Pk	.5	0	51.52	60.04	-8.52	-	-
	.3075	41.18	Qp	.5	0	41.68	60.04	-18.36	-	-
6	.312	30.17	Av	.5	0	30.67	-	-	49.92	-19.25
7	.384	47.07	Pk	.4	0	47.47	58.19	-10.72	-	-
8	.3795	25.24	Av	.4	0	25.64	-	-	48.29	-22.65
9	.438	45.41	Pk	.4	0	45.81	57.1	-11.29	-	-
10	.4425	22.04	Av	.4	0	22.44	-	-	47.01	-24.57
11	.501	45.62	Pk	.3	0	45.92	56	-10.08	-	-
12	.501	25.16	Av	.3	0	25.46	-	-	46	-20.54
13	16.656	44.41	Pk	.3	.2	44.91	60	-15.09	-	-
14	16.6335	30.16	Av	.3	.2	30.66	-	-	50	-19.34

Pk - Peak detector
 Av - Average detection
 Qp - Quasi-Peak detector

LINE 2 RESULTS

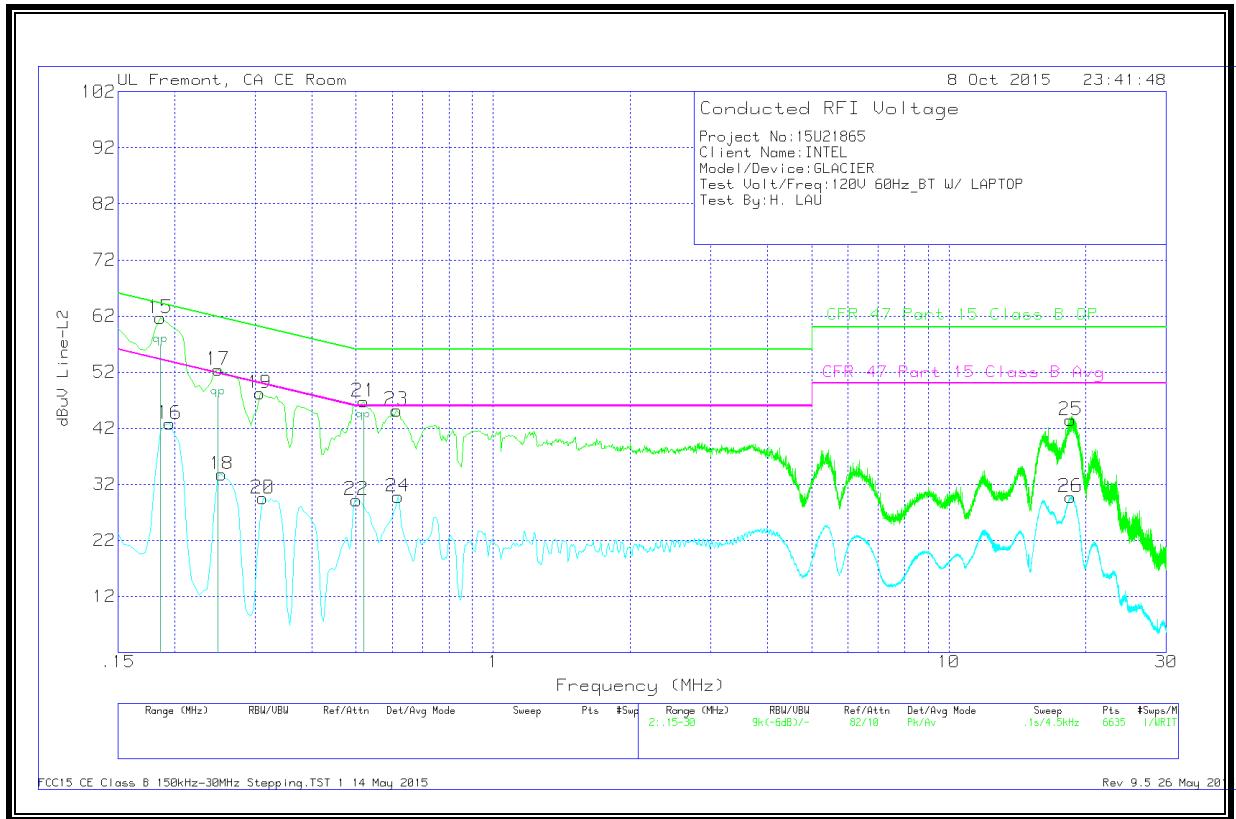

DATA

Range 2: Line-L2 .15 - 30MHz

Marker	Frequency (MHz)	Meter Reading (dBuV)	Det	T24 IL L2	LC Cables 2&3	Corrected Reading dBuV	CFR 47 Part 15 Class B QP	Margin (dB)	CFR 47 Part 15 Class B Avg	Margin (dB)
15	.186	60.55	Pk	1.1	0	61.65	64.21	-2.56	-	-
	.186	55.76	Qp	1.1	0	56.86	64.21	-7.35	-	-
16	.195	41.81	Av	1	0	42.81	-	-	53.82	-11.01
17	.249	51.71	Pk	.7	0	52.41	61.79	-9.38	-	-
	.249	46.88	Qp	.7	0	47.58	61.79	-14.21	-	-
18	.2535	33.06	Av	.7	0	33.76	-	-	51.64	-17.88
19	.3075	47.64	Pk	.6	0	48.24	60.04	-11.8	-	-
20	.312	28.91	Av	.6	0	29.51	-	-	49.92	-20.41
21	.519	46.37	Pk	.4	0	46.77	56	-9.23	-	-
	.519	43.08	Qp	.4	0	43.48	56	-12.52	-	-
22	.501	28.8	Av	.4	0	29.2	-	-	46	-16.8
23	.6135	44.91	Pk	.3	0	45.21	56	-10.79	-	-
24	.618	29.5	Av	.3	0	29.8	-	-	46	-16.2
25	18.519	42.95	Pk	.3	.2	43.45	60	-16.55	-	-
26	18.4965	29.24	Av	.3	.2	29.74	-	-	50	-20.26

Pk - Peak detector
 Av - Average detection
 Qp - Quasi-Peak detector