



**FCC 47 CFR PART 15 SUBPART C
INDUSTRY CANADA RSS-247 ISSUE 1**

**BLUETOOTH LOW ENERGY
CERTIFICATION TEST REPORT**

FOR

SMART WATCH with 802.11b/g/n, Bluetooth and BLE

MODEL NUMBER: SAR8A80

FCC ID: 2AB8ZND11

IC: 1000X-ND11

REPORT NUMBER: 15U21865-E2V1

ISSUE DATE: OCTOBER 12, 2015

Prepared for
**INTEL CORPORATION
2200 MISSION COLLEGE BOULEVARD,
SANTA CLARA, CA 95052, U.S.A**

Prepared by
**UL VERIFICATION SERVICES INC.
47173 BENICIA STREET
FREMONT, CA 94538, U.S.A.
TEL: (510) 771-1000
FAX: (510) 661-0888**



NVLAP LAB CODE 200065-0

Revision History

<u>Rev.</u>	<u>Issue Date</u>	<u>Revisions</u>	<u>Revised By</u>
V1	10/12/2015	Initial Issue	C. Pang

TABLE OF CONTENTS

1. ATTESTATION OF TEST RESULTS	5
2. TEST METHODOLOGY	6
3. FACILITIES AND ACCREDITATION	6
4. CALIBRATION AND UNCERTAINTY	6
4.1. <i>MEASURING INSTRUMENT CALIBRATION</i>	<i>6</i>
4.2. <i>SAMPLE CALCULATION</i>	<i>6</i>
4.3. <i>MEASUREMENT UNCERTAINTY.....</i>	<i>7</i>
5. EQUIPMENT UNDER TEST	8
5.1. <i>DESCRIPTION OF EUT</i>	<i>8</i>
5.2. <i>MAXIMUM OUTPUT POWER.....</i>	<i>8</i>
5.3. <i>DESCRIPTION OF AVAILABLE ANTENNAS</i>	<i>8</i>
5.4. <i>SOFTWARE AND FIRMWARE.....</i>	<i>8</i>
5.5. <i>WORST-CASE CONFIGURATION AND MODE.....</i>	<i>9</i>
5.6. <i>DESCRIPTION OF TEST SETUP.....</i>	<i>10</i>
6. TEST AND MEASUREMENT EQUIPMENT	15
7. ANTENNA PORT TEST RESULTS	16
7.1. <i>MEASUREMENT METHODS</i>	<i>16</i>
7.2. <i>ON TIME, DUTY CYCLE</i>	<i>17</i>
7.3. <i>6 dB BANDWIDTH.....</i>	<i>18</i>
7.4. <i>99% BANDWIDTH.....</i>	<i>21</i>
7.5. <i>OUTPUT POWER.....</i>	<i>24</i>
7.6. <i>AVERAGE POWER.....</i>	<i>27</i>
7.7. <i>POWER SPECTRAL DENSITY.....</i>	<i>28</i>
7.8. <i>CONDUCTED SPURIOUS EMISSIONS.....</i>	<i>31</i>
8. RADIATED TEST RESULTS.....	35
8.1. <i>LIMITS AND PROCEDURE.....</i>	<i>35</i>
8.2. <i>TRANSMITTER ABOVE 1 GHz.....</i>	<i>36</i>
8.3. <i>WORST-CASE BELOW 1 GHz.....</i>	<i>46</i>
8.4. <i>WORST-CASE ABOVE 18 GHz</i>	<i>48</i>
9. AC POWER LINE CONDUCTED EMISSIONS	50
9.1. <i>EUT WITH AC ADAPTER.....</i>	<i>51</i>

9.2. EUT WITH USB LAPTOP55

10. SETUP PHOTOS58

1. ATTESTATION OF TEST RESULTS

COMPANY NAME: INTEL CORPORATION
2200 MISSION COLLEGE BOULEVARD
SANTA CLARA, CA 95052, U.S.A.

EUT DESCRIPTION: SMART WATCH with 802.11b/g/n, Bluetooth and BLE

MODEL: SAR8A80

SERIAL NUMBER: GLDPD1FZ535008P(Conducted);
GLDPD1FZ535009V(Radiated)

DATE TESTED: September 30th – October 10th 2015

APPLICABLE STANDARDS	
STANDARD	TEST RESULTS
CFR 47 Part 15 Subpart C	Pass
INDUSTRY CANADA RSS-247 Issue 1	Pass
INDUSTRY CANADA RSS-GEN Issue 4	Pass

UL Verification Services Inc. tested the above equipment in accordance with the requirements set forth in the above standards. All indications of Pass/Fail in this report are opinions expressed by UL Verification Services Inc. based on interpretations and/or observations of test results. Measurement Uncertainties were not taken into account and are published for informational purposes only. The test results show that the equipment tested is capable of demonstrating compliance with the requirements as documented in this report.

Note: The results documented in this report apply only to the tested sample, under the conditions and modes of operation as described herein. This document may not be altered or revised in any way unless done so by UL Verification Services Inc. and all revisions are duly noted in the revisions section. Any alteration of this document not carried out by UL Verification Services Inc. will constitute fraud and shall nullify the document. This report must not be used by the client to claim product certification, approval, or endorsement by NVLAP, NIST, any agency of the Federal Government, or any agency of any government.

Approved & Released For
UL Verification Services Inc. By:

Tested By:



CHIN PANG
EMC SUPERVISOR
UL Verification Services Inc.

CLIFFORD SUSAS
EMC ENGINEER
UL Verification Services Inc.

2. TEST METHODOLOGY

The tests documented in this report were performed in accordance with FCC CFR 47 Part 2, FCC CFR 47 Part 15, ANSI C63.10-2013, RSS-GEN Issue 4, RSS-247 Issue 1.

3. FACILITIES AND ACCREDITATION

The test sites and measurement facilities used to collect data are located at 47173 and 47266 Benicia Street, Fremont, California, USA. Line conducted emissions are measured only at the 47173 address. The following table identifies which facilities were utilized for radiated emission measurements documented in this report. Specific facilities are also identified in the test results sections.

47173 Benicia Street	47266 Benicia Street
<input type="checkbox"/> Chamber A	<input type="checkbox"/> Chamber D
<input checked="" type="checkbox"/> Chamber B	<input type="checkbox"/> Chamber E
<input type="checkbox"/> Chamber C	<input type="checkbox"/> Chamber F
	<input checked="" type="checkbox"/> Chamber G
	<input type="checkbox"/> Chamber H

The above test sites and facilities are covered under FCC Test Firm Registration # 208313. Chambers A through H are covered under Industry Canada company address code 2324B with site numbers 2324B -1 through 2324B-8, respectively.

UL Verification Services Inc. is accredited by NVLAP, Laboratory Code 200065-0. The full scope of accreditation can be viewed at <http://ts.nist.gov/standards/scopes/2000650.htm>.

4. CALIBRATION AND UNCERTAINTY

4.1. MEASURING INSTRUMENT CALIBRATION

The measuring equipment utilized to perform the tests documented in this report has been calibrated in accordance with the manufacturer's recommendations, and is traceable to recognized national standards.

4.2. SAMPLE CALCULATION

Where relevant, the following sample calculation is provided:

$$\begin{aligned} \text{Field Strength (dBuV/m)} &= \text{Measured Voltage (dBuV)} + \text{Antenna Factor (dB/m)} + \\ &\text{Cable Loss (dB)} - \text{Preamp Gain (dB)} \\ 36.5 \text{ dBuV} + 18.7 \text{ dB/m} + 0.6 \text{ dB} - 26.9 \text{ dB} &= 28.9 \text{ dBuV/m} \end{aligned}$$

4.3. MEASUREMENT UNCERTAINTY

Where relevant, the following measurement uncertainty levels have been estimated for tests performed on the apparatus:

PARAMETER	UNCERTAINTY
Conducted Disturbance, 0.15 to 30 MHz	± 3.52 dB
Radiated Disturbance, 30 to 1000 MHz	± 4.94 dB
Radiated Disturbance, 1 to 6 GHz	± 3.86 dB
Radiated Disturbance, 6 to 18 GHz	± 4.23 dB
Radiated Disturbance, 18 to 26 GHz	± 5.30 dB
Radiated Disturbance, 26 to 40 GHz	± 5.23 dB

Uncertainty figures are valid to a confidence level of 95%.

5. EQUIPMENT UNDER TEST

5.1. DESCRIPTION OF EUT

The EUT is a smart watch with SMART WATCH with 802.11b/g/n, Bluetooth and BLE

5.2. MAXIMUM OUTPUT POWER

The transmitter has a maximum peak conducted output power as follows:

Frequency Range (MHz)	Mode	Output Power (dBm)	Output Power (mW)
2402 - 2480	BLE	10.56	11.38

5.3. DESCRIPTION OF AVAILABLE ANTENNAS

The radio utilizes an trace antenna, with a maximum gain of 0 dBi.

5.4. SOFTWARE AND FIRMWARE

The firmware installed in the EUT during testing was DVT Eng. Build.

5.5. WORST-CASE CONFIGURATION AND MODE

Radiated emission and power line conducted emission were performed with the EUT set to transmit at the channel with highest output power as worst-case scenario.

The fundamental of the EUT was investigated in three orthogonal orientations X, Y and Z, it was determined that Z orientation was worst-case orientation; therefore, all final radiated testing was performed with the EUT in Z orientation.

Based on the baseline scan, the worst-case data rates were:

BLE: 1 Mbps.

5.6. DESCRIPTION OF TEST SETUP

SUPPORT EQUIPMENT

Support Equipment List				
Description	Manufacturer	Model	Serial Number	FCC ID
Laptop	Lenovo	Yoga 2 11	YB04282152	N/A
AC adapter	Lenovo	ADLX45NCC3A	11S45N0297Z1ZSH443G0XE	N/A

I/O CABLES

I/O Cable List						
Cable No	Port	# of identical ports	Connector Type	Cable Type	Cable Length (m)	Remarks
1	AC	1	3-Prong	Un-Shielded	1.8	N/A
2	DC	1	DC	Un-Shielded	1	N/A
3	USB	1	USB	Un-Shielded	0.9	Laptop to EUT
4	Antenna	1	SMA	Shielded	0.3	EUT to spectrum Analyzer
5	AC/DC	1	USB Micro	Un-Shielded	0.9	

TEST SETUP

Test software exercised the radio card.

SETUP DIAGRAM FOR CONDUCTED TESTS

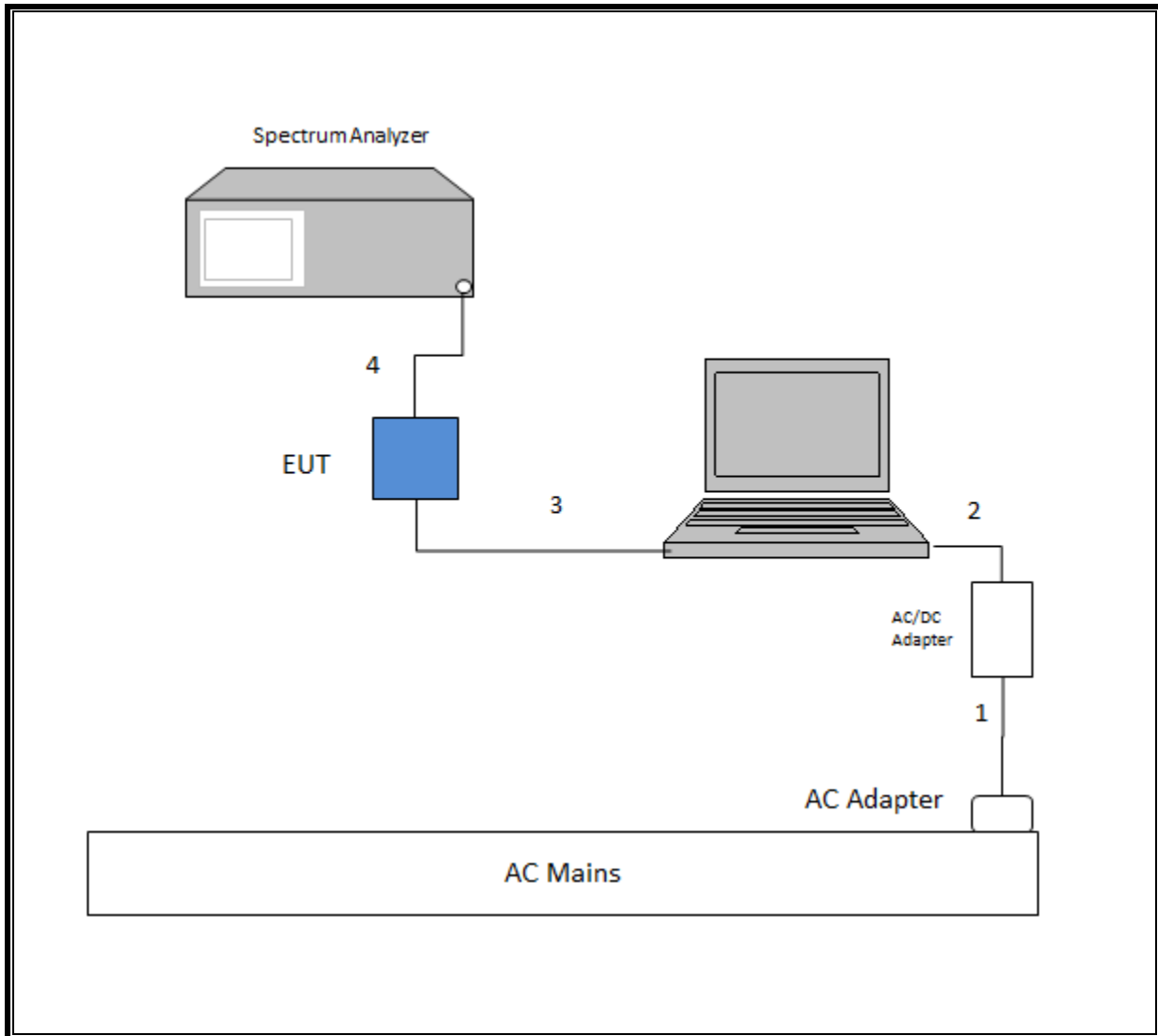

SETUP DIAGRAM FOR RADIATED TESTS

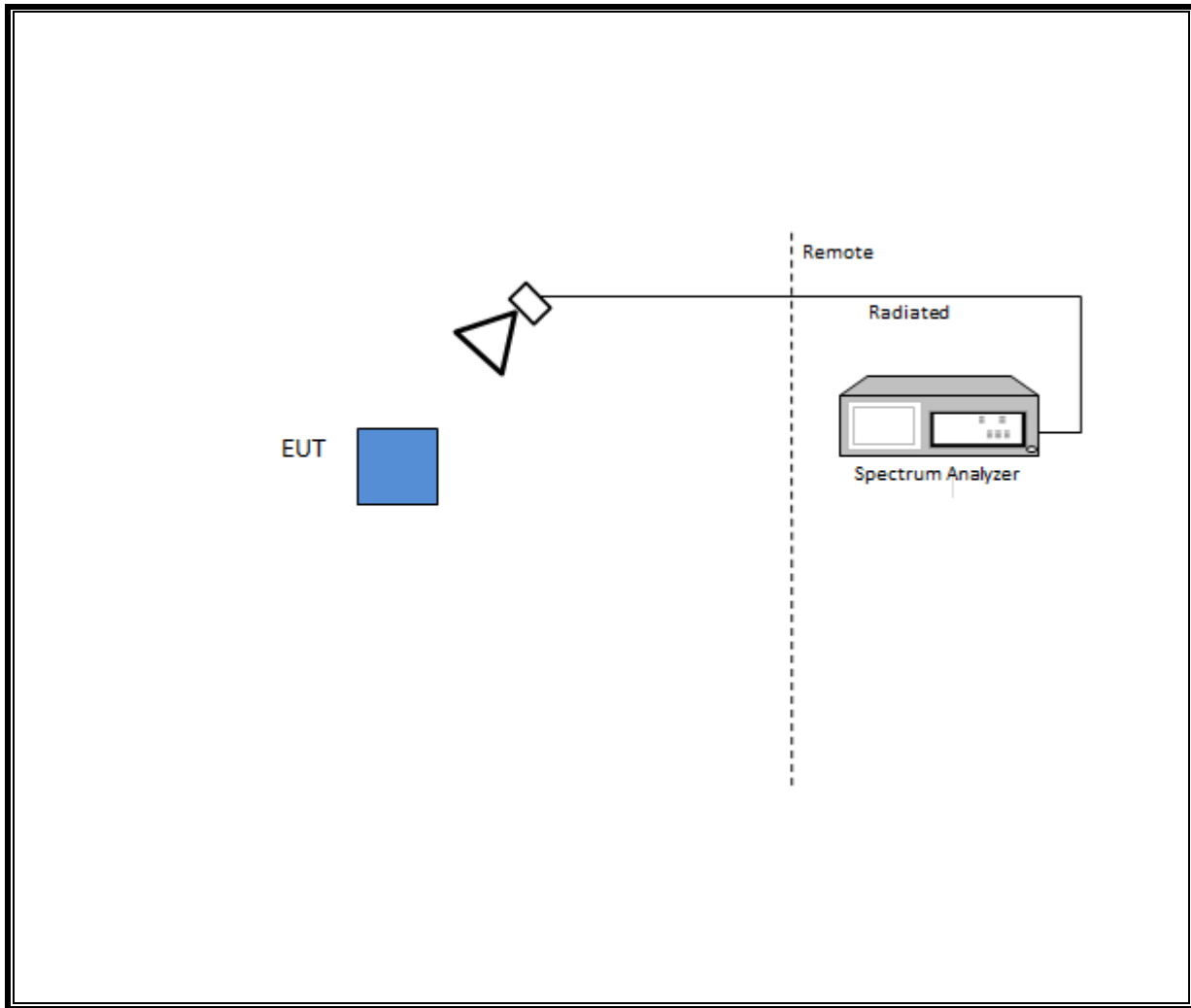

SETUP DIAGRAM 1 FOR LINE CONDUCTED TEST

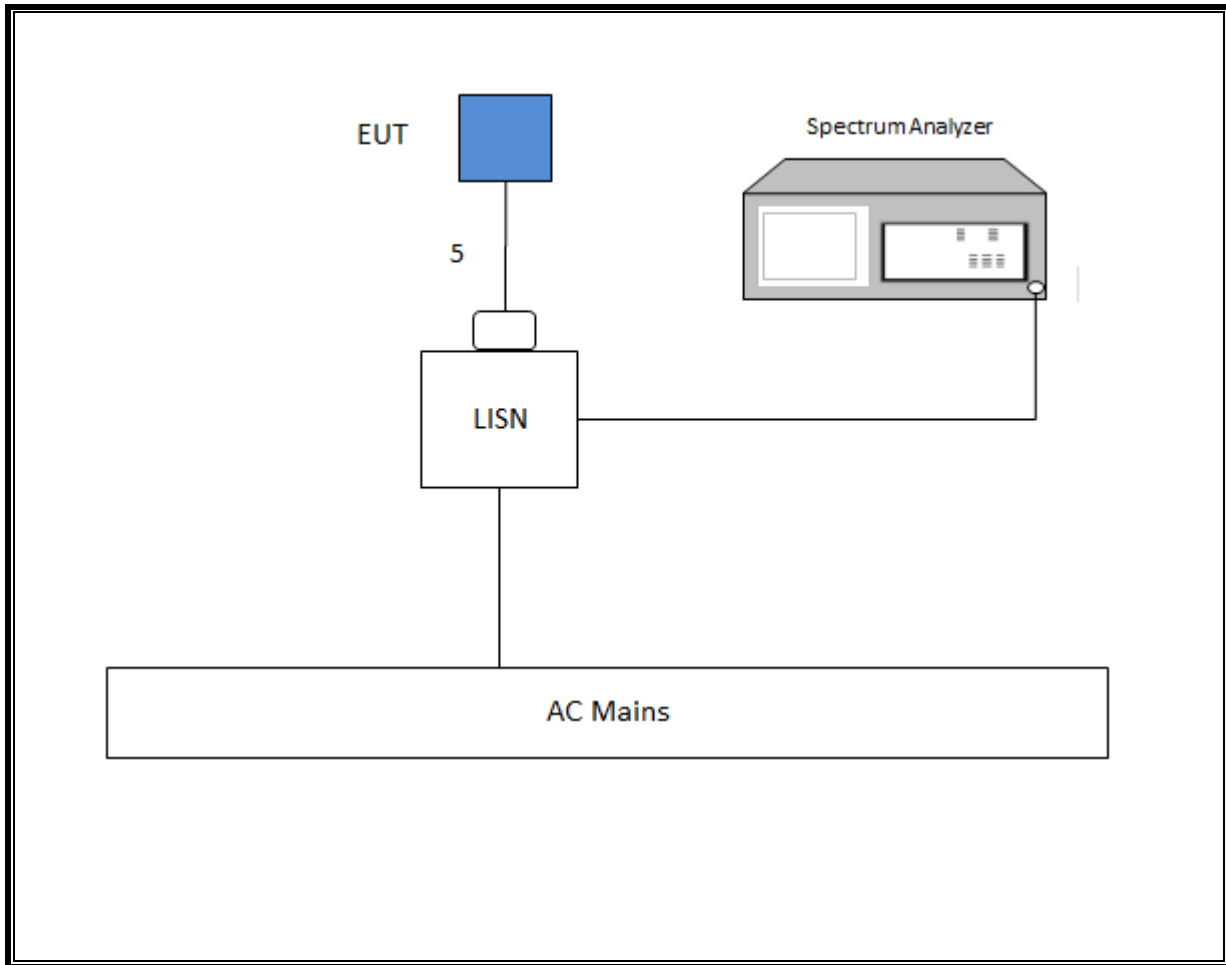

SETUP DIAGRAM 2 FOR LINE CONDUCTED TEST

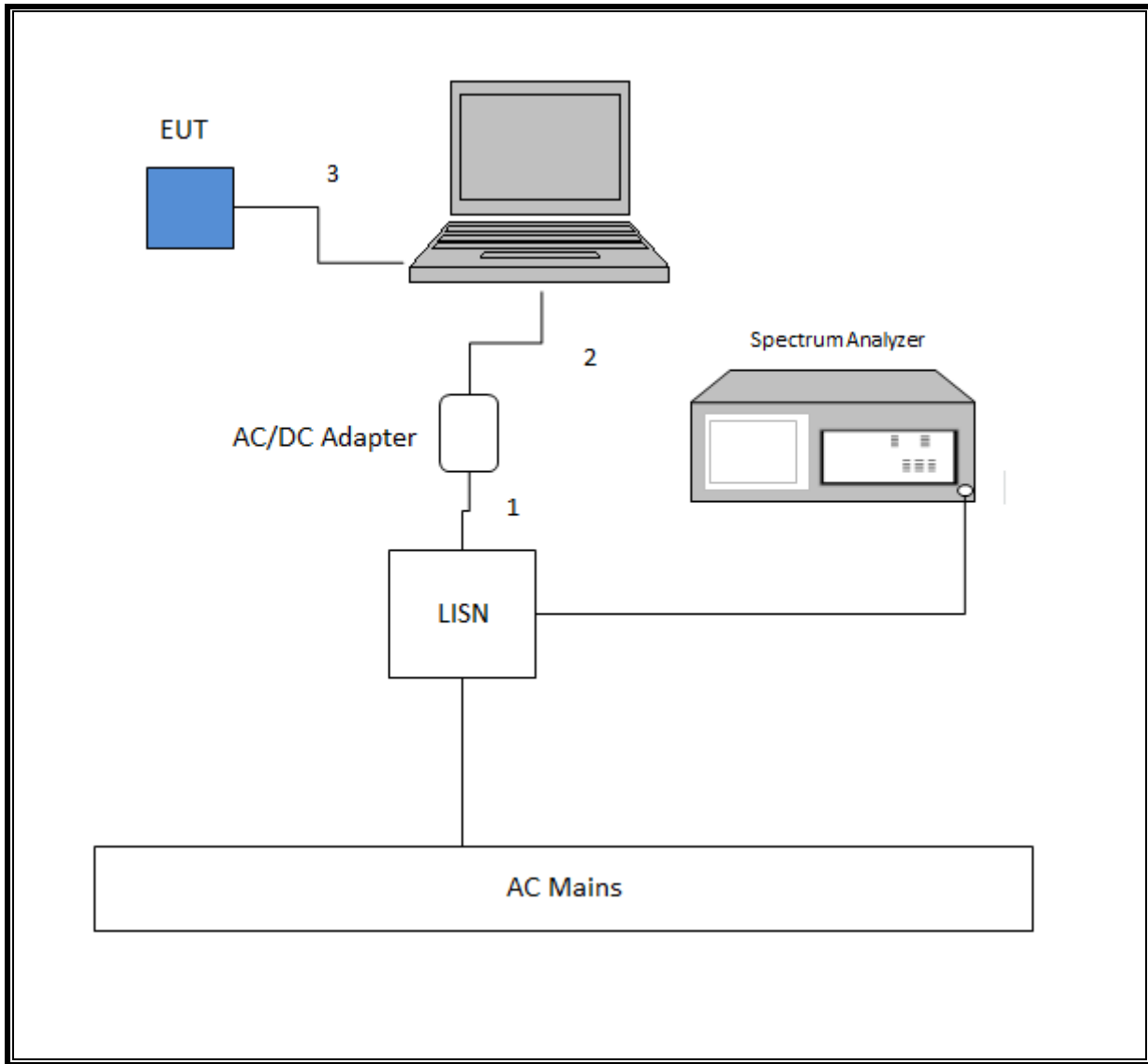

6. TEST AND MEASUREMENT EQUIPMENT

The following test and measurement equipment was utilized for the tests documented in this report:

Test Equipment List					
Description	Manufacturer	Model	T No.	Cal Date	Cal Due
Radiated Software	UL	UL EMC	Ver 9.5		
Conducted Software	UL	UL EMC	Ver 3.5		
Spectrum Analyzer, PSA, 3Hz to 44GHz	Keysight	N9030A	907	05/15/15	01/07/16
Antenna, Horn, 1-18GHz	ETS Lindgren	3117	345	03/03/15	03/03/16
Antenna, Broadband Hybrid, 30 to 2000MHz	Sunol Sciences	JB1	899	4/30/2015	4/30/2016
Amplifier, 1-18GHz	Miteq	AFS42-00101800-25-S-42	493	01/16/15	01/16/16
Filter, HPF 3.0GHz	Micro-Tronics	HPM17543	485	01/16/15	01/16/16
Spectrum Analyzer, PSA, 3Hz to 44GHz	Keysight	N9030A	342	06/29/15	06/29/16
Spectrum Analyzer, PSA, 3Hz to 44GHz	Keysight	N9030A	905	6/16/2015	5/26/2016
Amplifier, 10kHz to 1GHz	Sonoma	310N	834	6/8/2015	6/8/2016
Power Meter	Keysight	N1911A	1244	07/02/15	07/02/16
Power Sensor	Keysight	N1921A	1228	07/06/15	07/06/16
EMI Test Receiver 9Khz-7GHz	Rohde & Schwarz	ESC17	100935	08/07/15	08/07/16
LISN for Conducted Emissions CISPR-16	FCC	50/250-25-2	114	01/16/15	01/16/16

7. ANTENNA PORT TEST RESULTS

7.1. MEASUREMENT METHODS

6 dB BW: KDB 558074 D01 v03r03, Section 8.1.

Output Power: KDB 558074 D01 v03r01, Section 9.1.2.

Power Spectral Density: KDB 558074 D01 v03r01, Section 10.2.

Out-of-band emissions in non-restricted bands: KDB 558074 D01 v03r01, Section 11.0.

Out-of-band emissions in restricted bands: KDB 558074 D01 v03r01, Section 12.1.

Band-edge: KDB 558074 D01 v03r03, Section 12.1

7.2. ON TIME, DUTY CYCLE

None; for reporting purposes only.

PROCEDURE

KDB 558074 Zero-Span Spectrum Analyzer Method.

ON TIME AND DUTY CYCLE RESULTS

Mode	ON Time B (msec)	Period (msec)	Duty Cycle x (linear)	Duty Cycle (%)	Duty Cycle Correction Factor (dB)	1/B Minimum VBW (kHz)
BLE	0.389	0.626	0.622	62.19%	2.06	2.571

DUTY CYCLE PLOTS

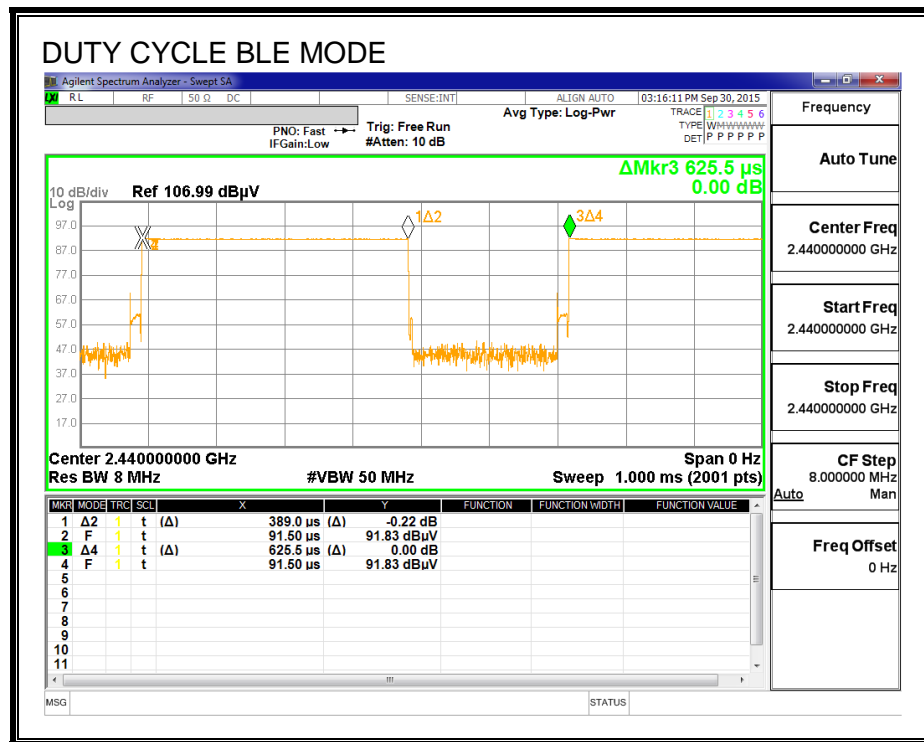

7.3. 6 dB BANDWIDTH

LIMITS

FCC §15.247 (a) (2)

IC RSS-247 (5.2) (1)

The minimum 6 dB bandwidth shall be at least 500 kHz.

RESULTS

Channel	Frequency (MHz)	6 dB Bandwidth (MHz)	Minimum Limit (MHz)
Low	2402	0.738	0.5
Middle	2440	0.690	0.5
High	2480	0.702	0.5

6 dB BANDWIDTH

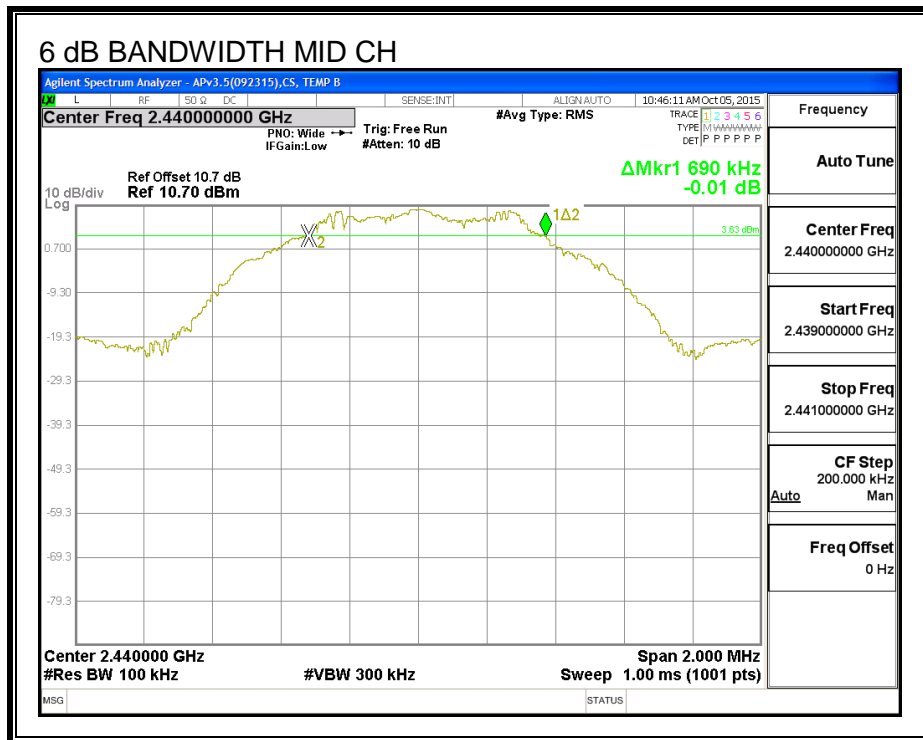
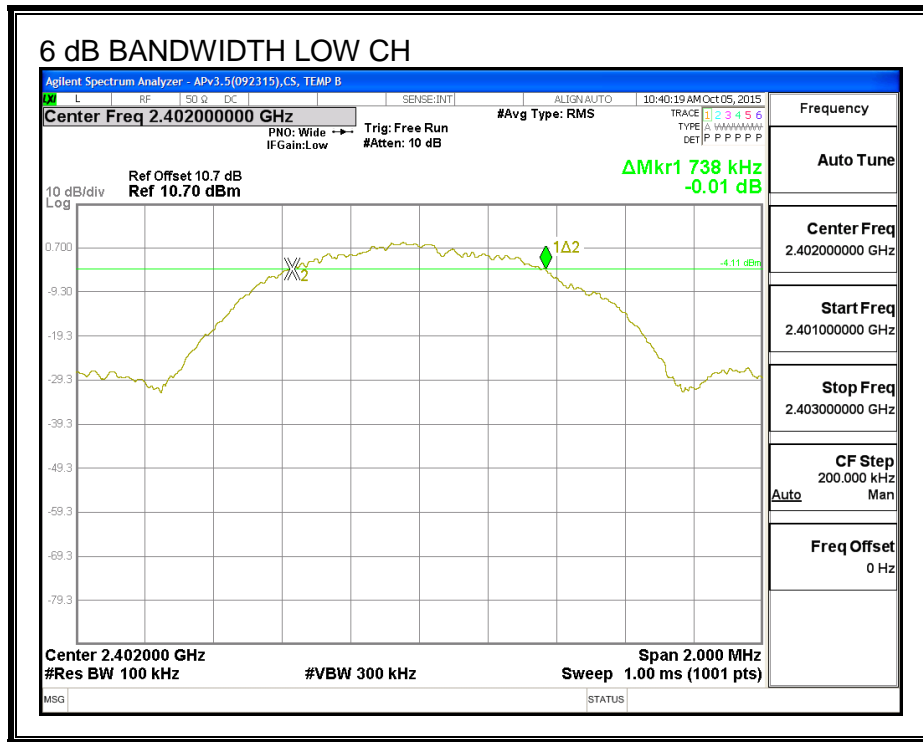

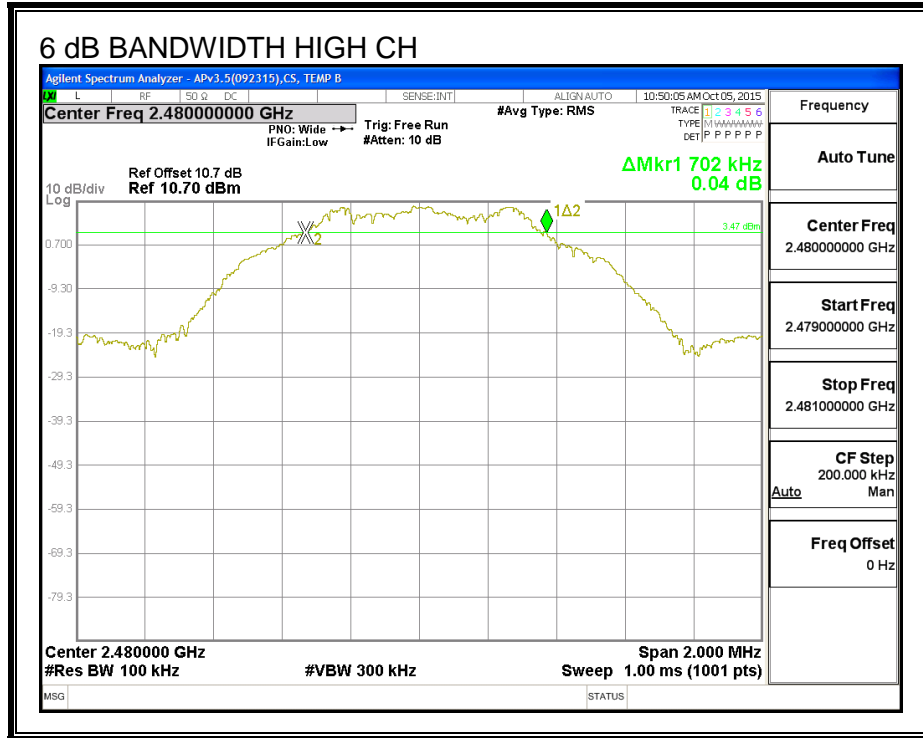

7.4. 99% BANDWIDTH

LIMITS

None; for reporting purposes only.

TEST PROCEDURE

The transmitter output is connected to the spectrum analyzer. The RBW is set to 1% to 3% of the 99 % bandwidth and to 1% of the span. The VBW is set to 3 times the RBW. The sweep time is coupled. The spectrum analyzer internal 99% bandwidth function is utilized.

RESULTS

Channel	Frequency (MHz)	99% Bandwidth (MHz)
Low	2402	1.0532
Middle	2440	1.0578
High	2480	1.0547

99% BANDWIDTH

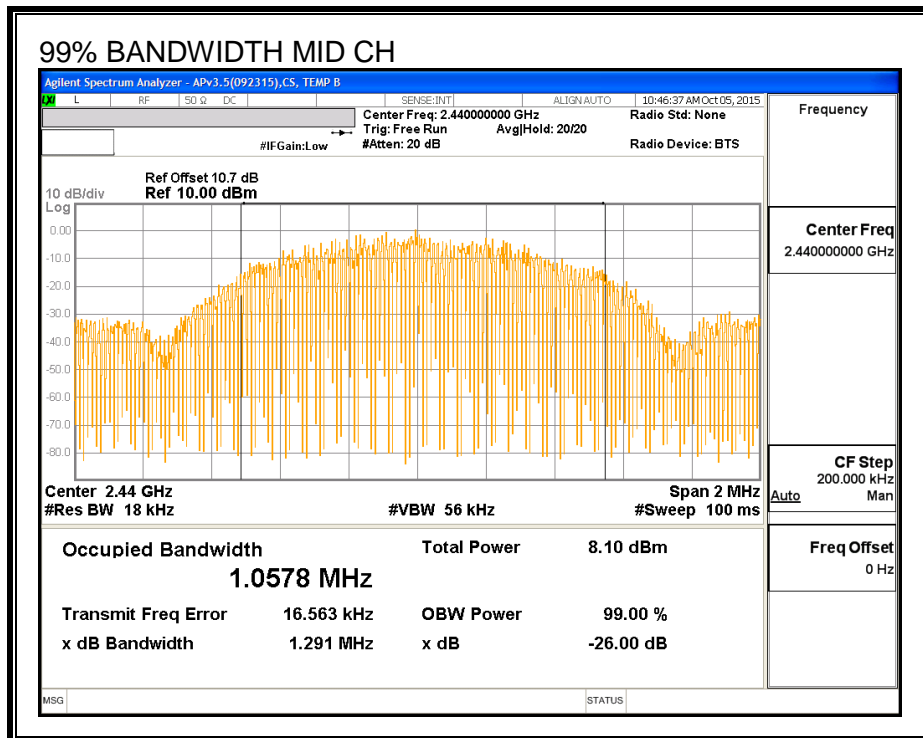
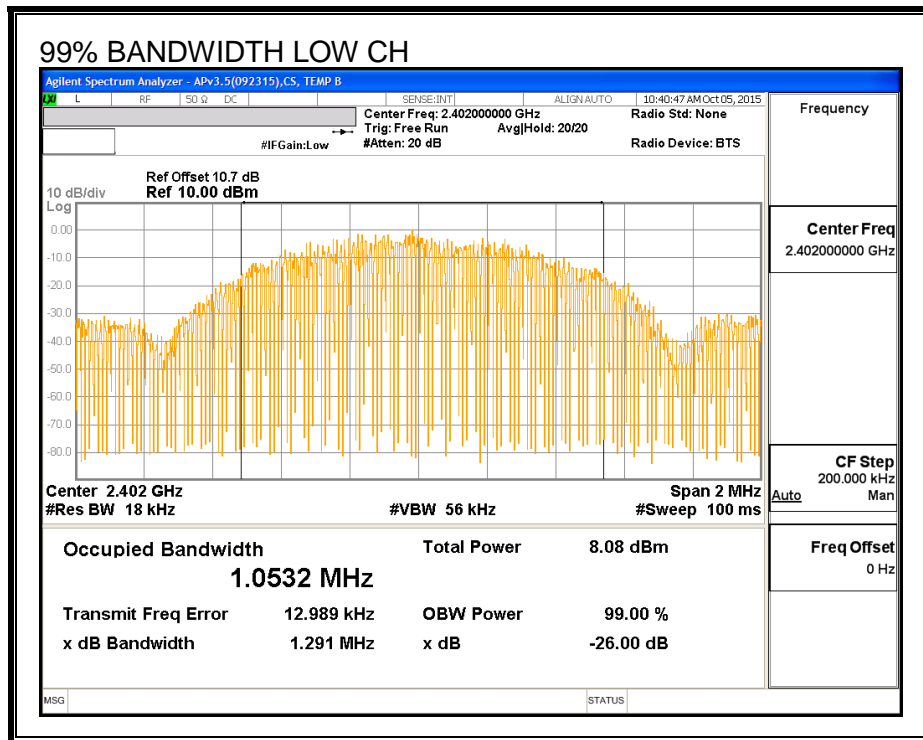

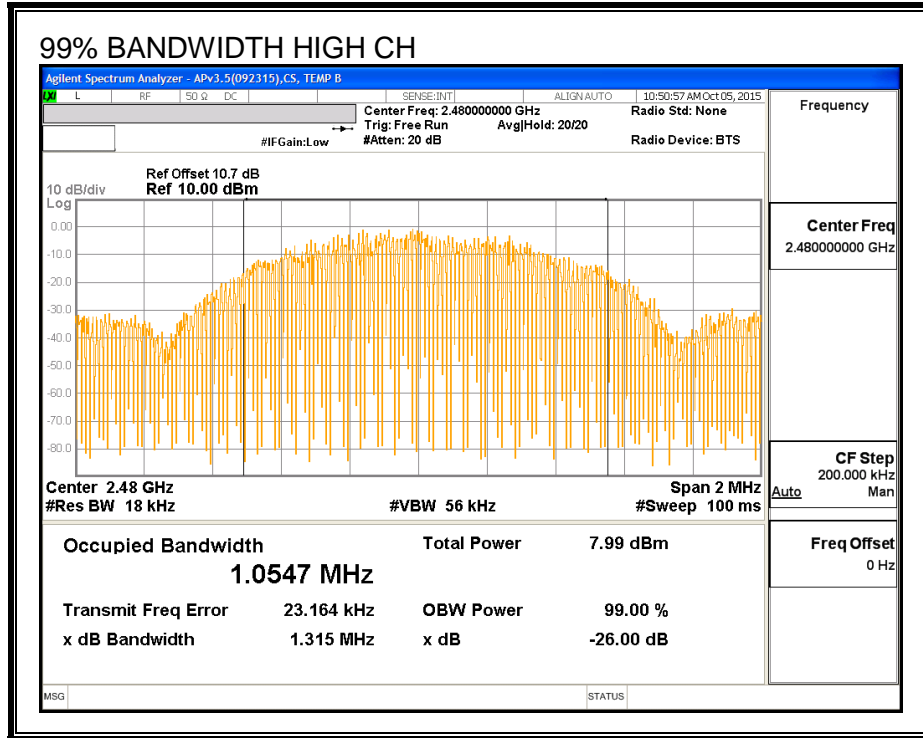

7.5. OUTPUT POWER

LIMITS

FCC §15.247 (b)

IC RSS-247 (5.4) (4)

The maximum antenna gain is less than or equal to 6 dBi, therefore the limit is 30 dBm.

RESULTS

Channel	Frequency (MHz)	Peak Power Reading (dBm)	Limit (dBm)	Margin (dB)
Low	2402	10.45	30	-19.550
Middle	2440	10.56	30	-19.440
High	2480	10.52	30	-19.480

OUTPUT POWER

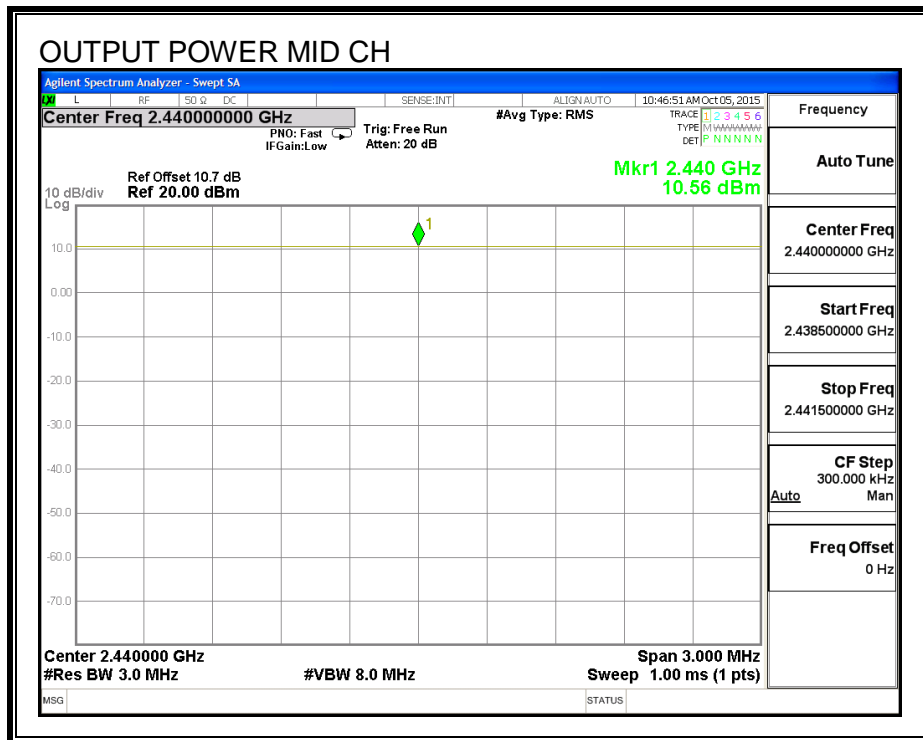
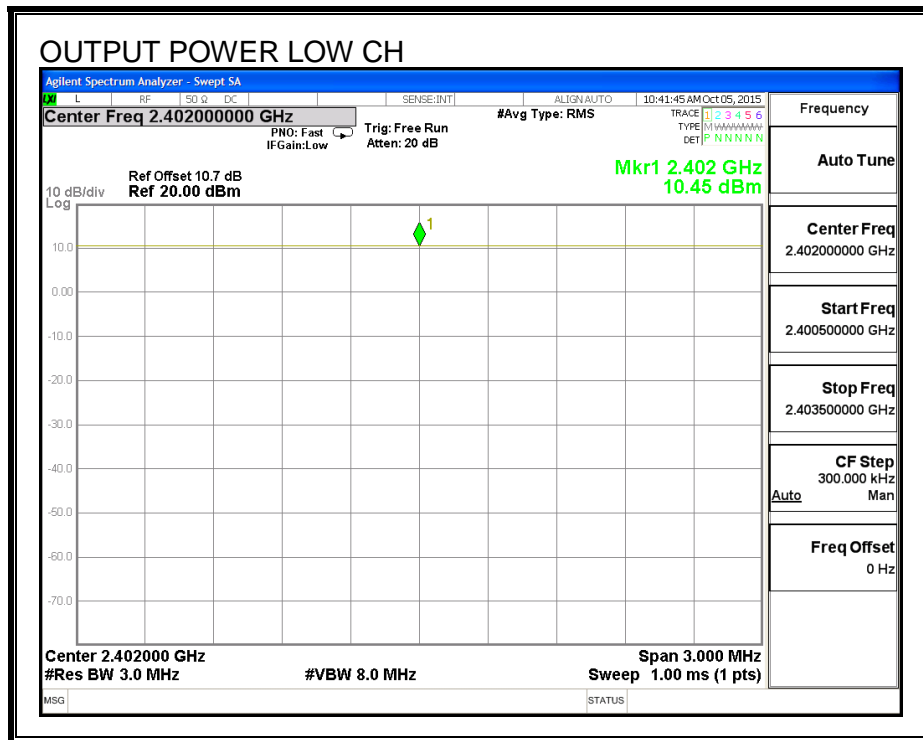

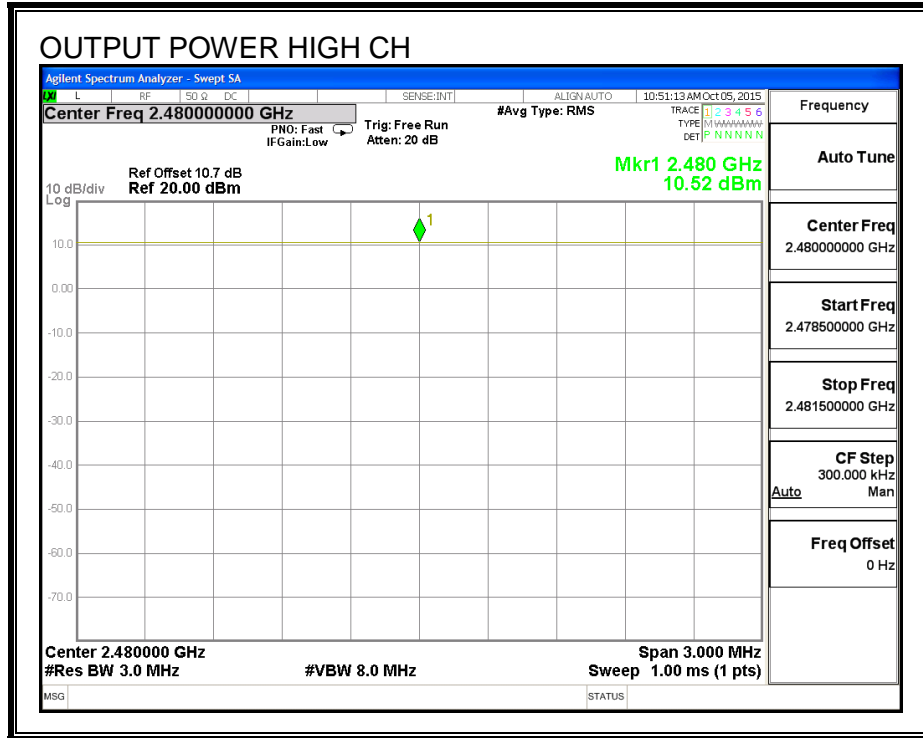

7.6. AVERAGE POWER

LIMITS

None; for reporting purposes only.

RESULTS

The cable assembly insertion loss of 10.7 dB (including 10 dB pad and 0.7 dB cable) was entered as an offset in the power meter to allow for direct reading of power.

Channel	Frequency (MHz)	AV power (dBm)
Low	2402	9.70
Middle	2440	9.65
High	2480	9.52

7.7. POWER SPECTRAL DENSITY

LIMITS

FCC §15.247 (e)

IC RSS-247 (5.2) (2)

The power spectral density conducted from the transmitter to the antenna shall not be greater than 8 dBm in any 3 kHz band during any time interval of continuous transmission.

RESULTS

Channel	Frequency (MHz)	PSD (dBm)	Limit (dBm)	Margin (dB)
Low	2402	7.89	8	-0.11
Middle	2440	7.93	8	-0.07
High	2480	7.81	8	-0.19

POWER SPECTRAL DENSITY

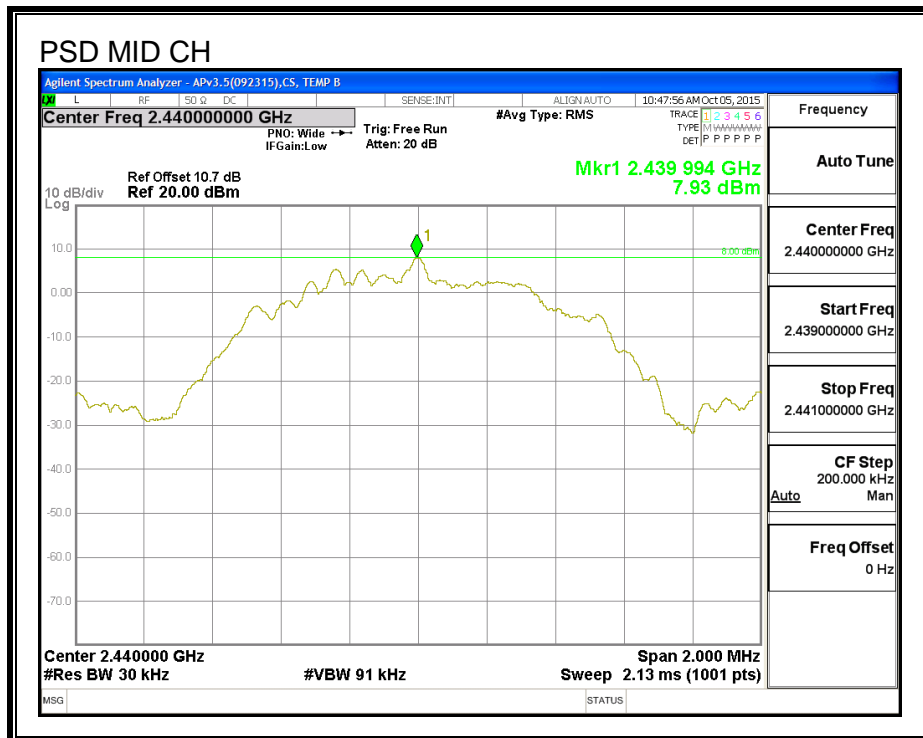
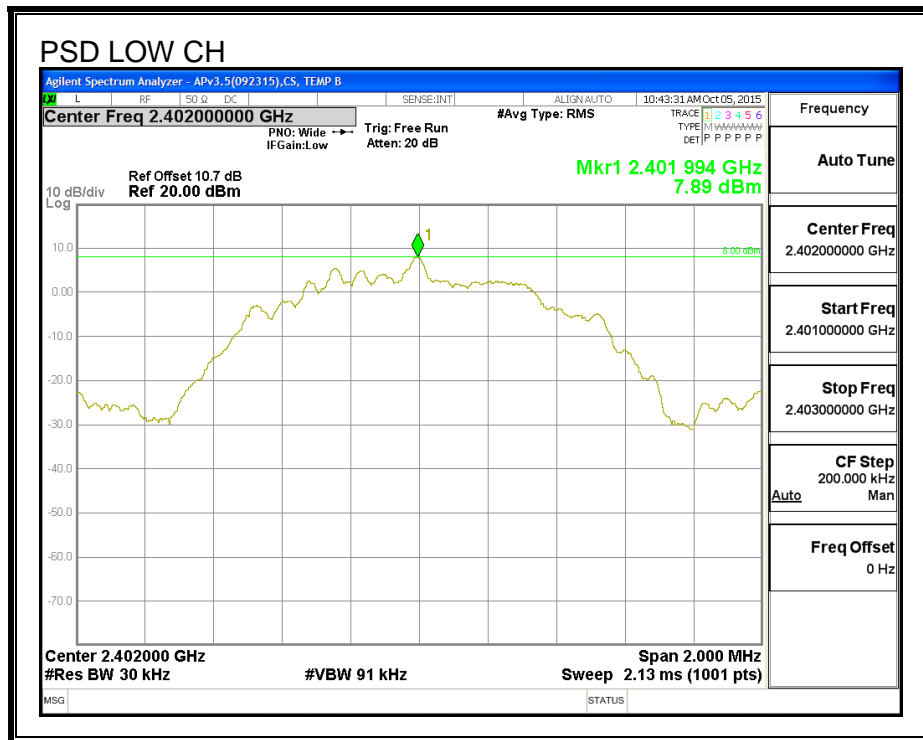

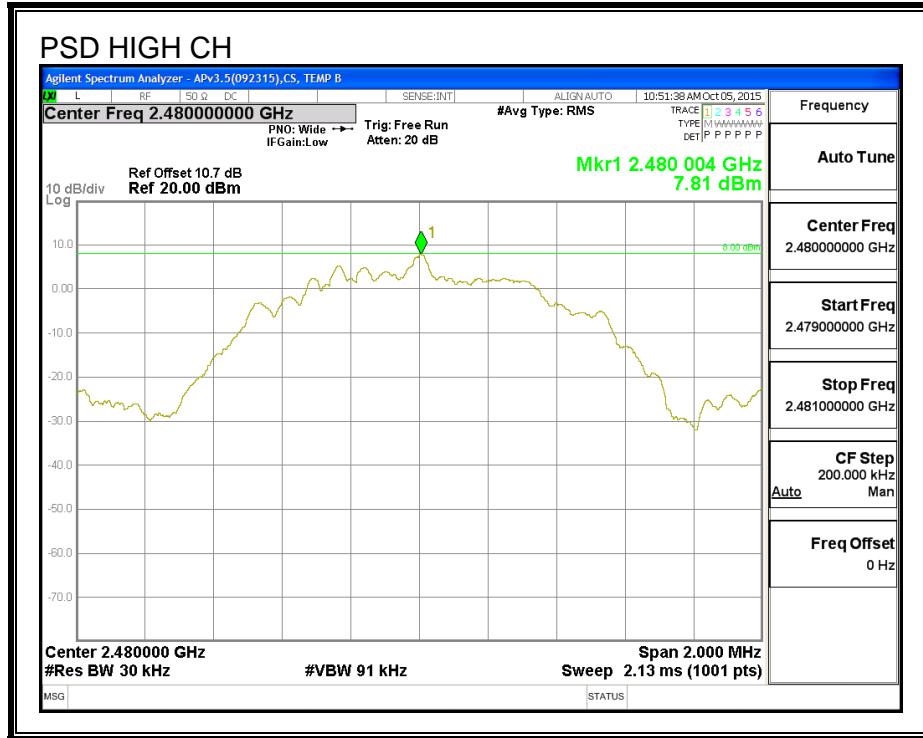

7.8. CONDUCTED SPURIOUS EMISSIONS

LIMITS

FCC §15.247 (d)

IC RSS-247 (5.5)

Output power was measured based on the use of a peak measurement, therefore the required attenuation is 20 dB.

RESULTS

SPURIOUS EMISSIONS, LOW CHANNEL

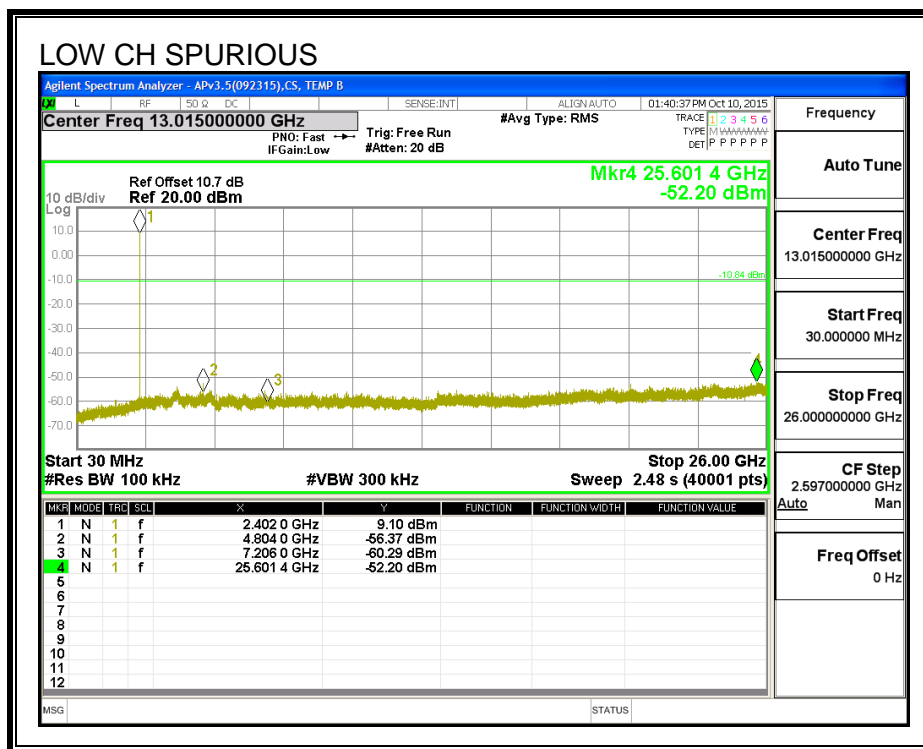
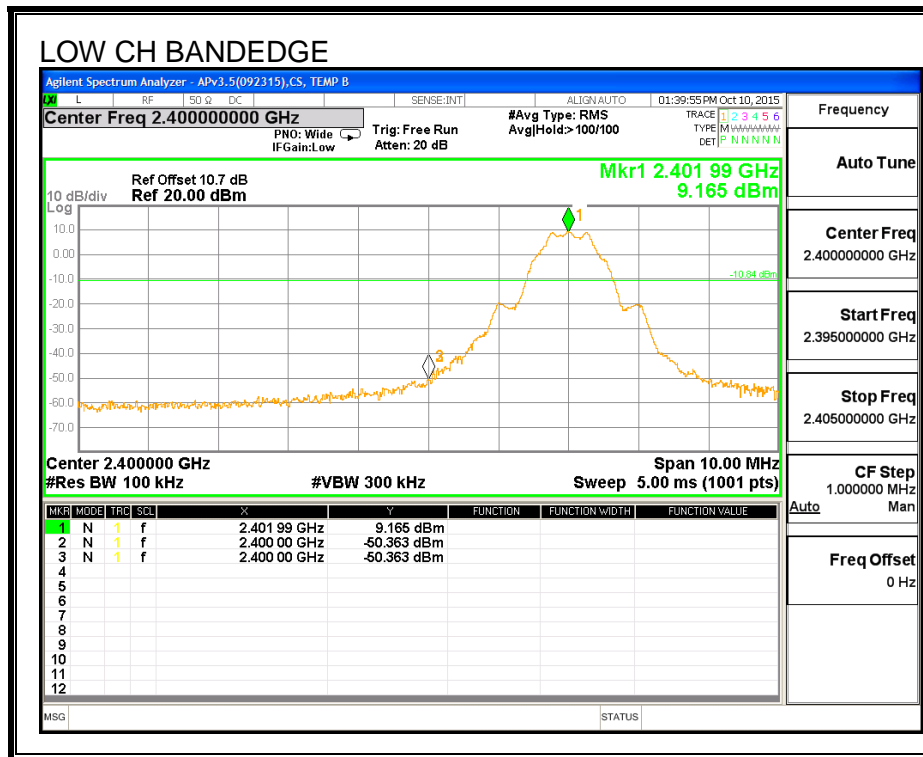

SPURIOUS EMISSIONS, MID CHANNEL

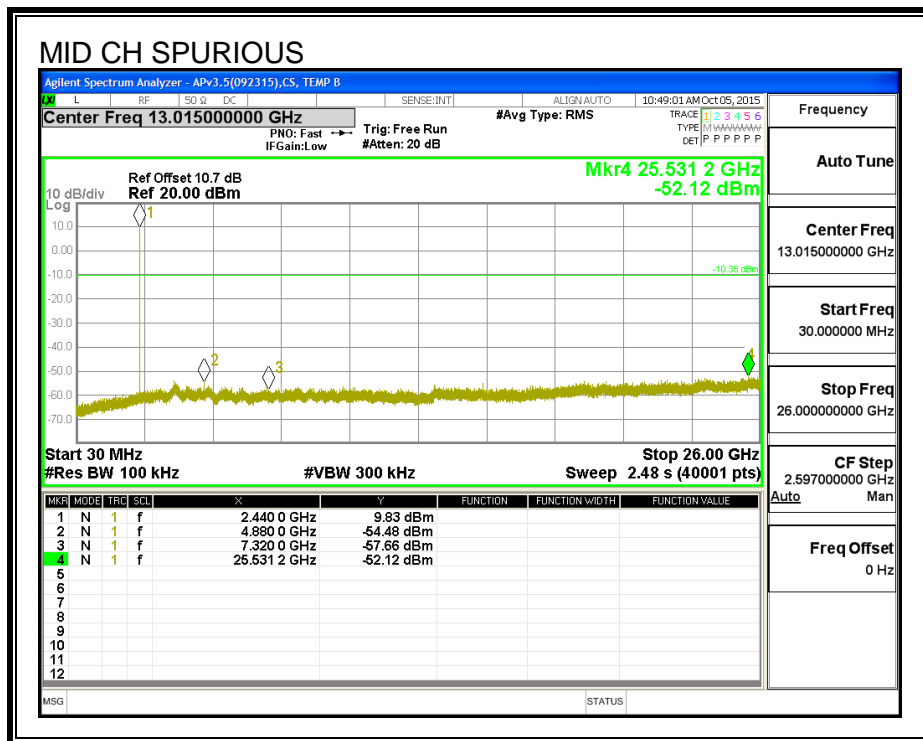
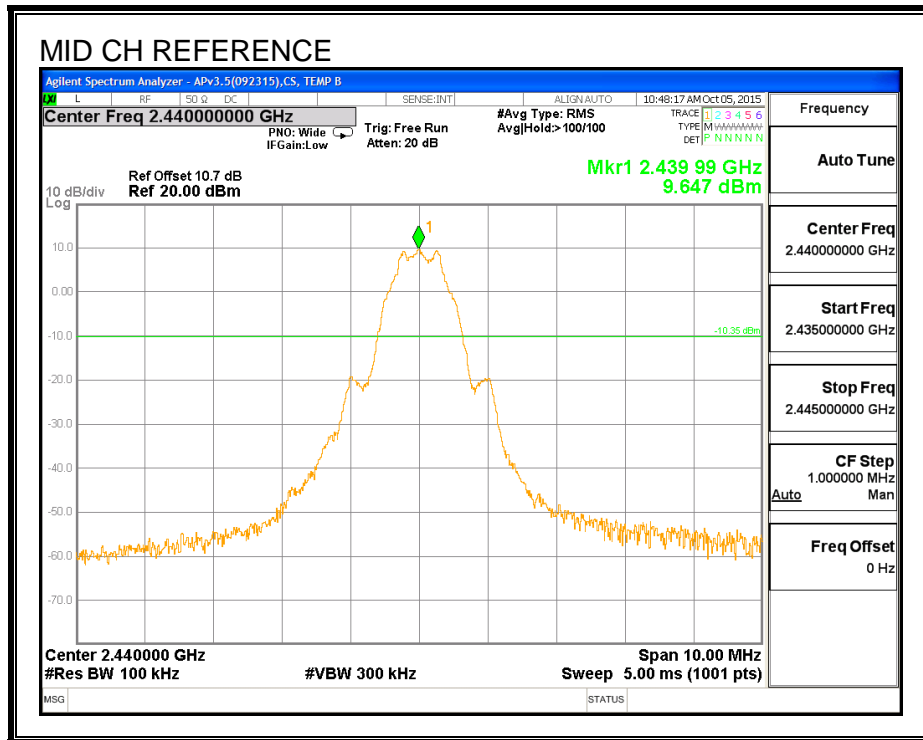

SPURIOUS EMISSIONS, HIGH CHANNEL

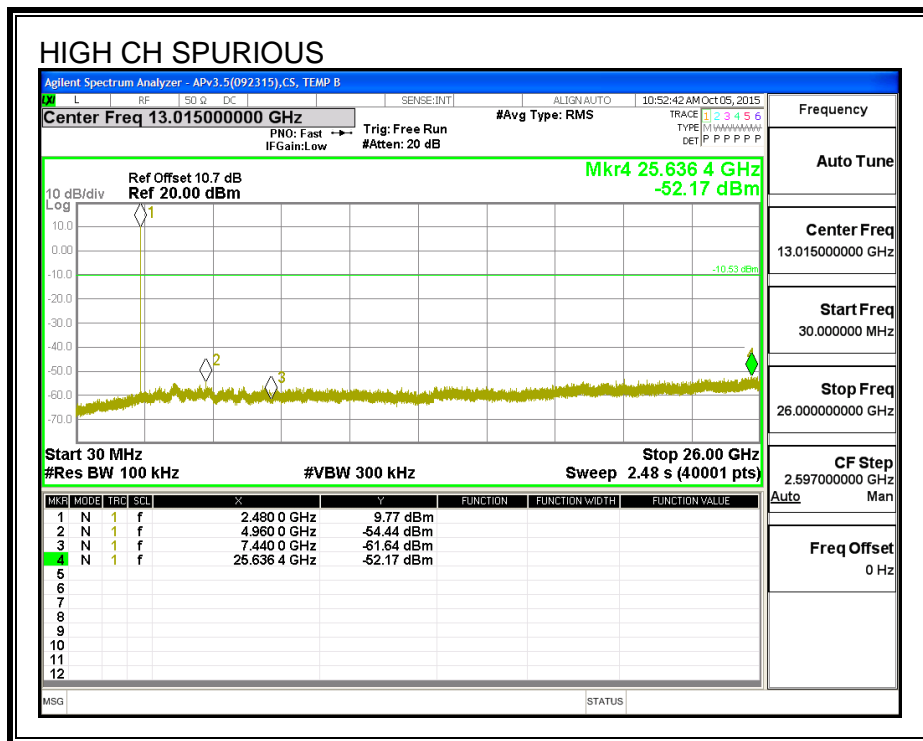
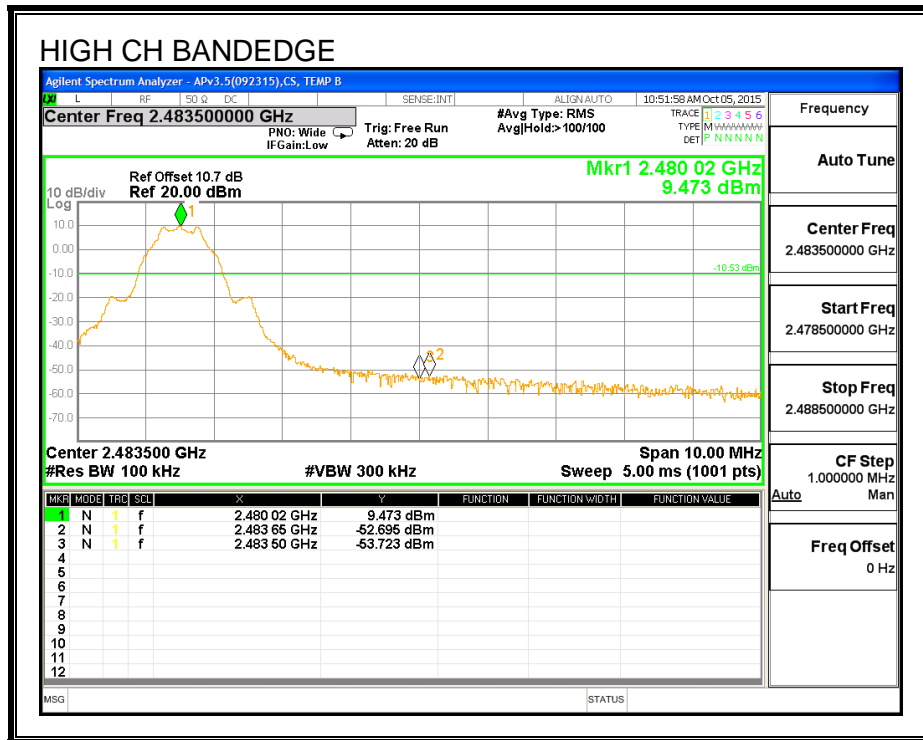

8. RADIATED TEST RESULTS

8.1. LIMITS AND PROCEDURE

LIMITS

FCC §15.205 and §15.209

IC RSS-GEN, Section 8.9 and 8.10

Frequency Range (MHz)	Field Strength Limit (uV/m) at 3 m	Field Strength Limit (dBuV/m) at 3 m
30 - 88	100	40
88 - 216	150	43.5
216 - 960	200	46
Above 960	500	54

TEST PROCEDURE

The EUT is placed on a non-conducting table 80 cm above the ground plane for measurement below 1GHz; 1.5 m above the ground plane for measurement above 1GHz. The antenna to EUT distance is 3 meters. The EUT is configured in accordance with ANSI C63.10. The EUT is set to transmit in a continuous mode..

For measurements below 1 GHz the resolution bandwidth is set to 100 kHz for peak detection measurements or 120 kHz for quasi-peak detection measurements. Peak detection is used unless otherwise noted as quasi-peak.

For measurements above 1 GHz the resolution bandwidth is set to 1 MHz, then the video bandwidth is set to 3 MHz for peak measurements and 1 MHz resolution bandwidth with 3MHz video bandwidth with average detector for average measurements.

The spectrum from 30 MHz to 26 GHz is investigated with the transmitter set to the lowest, middle, and highest channels in the 2.4 GHz band.

The frequency range of interest is monitored at a fixed antenna height and EUT azimuth. The EUT is rotated through 360 degrees to maximize emissions received. The antenna is scanned from 1 to 4 meters above the ground plane to further maximize the emission. Measurements are made with the antenna polarized in both the vertical and the horizontal positions

8.2. TRANSMITTER ABOVE 1 GHz

RESTRICTED BANDEDGE (LOW CHANNEL)

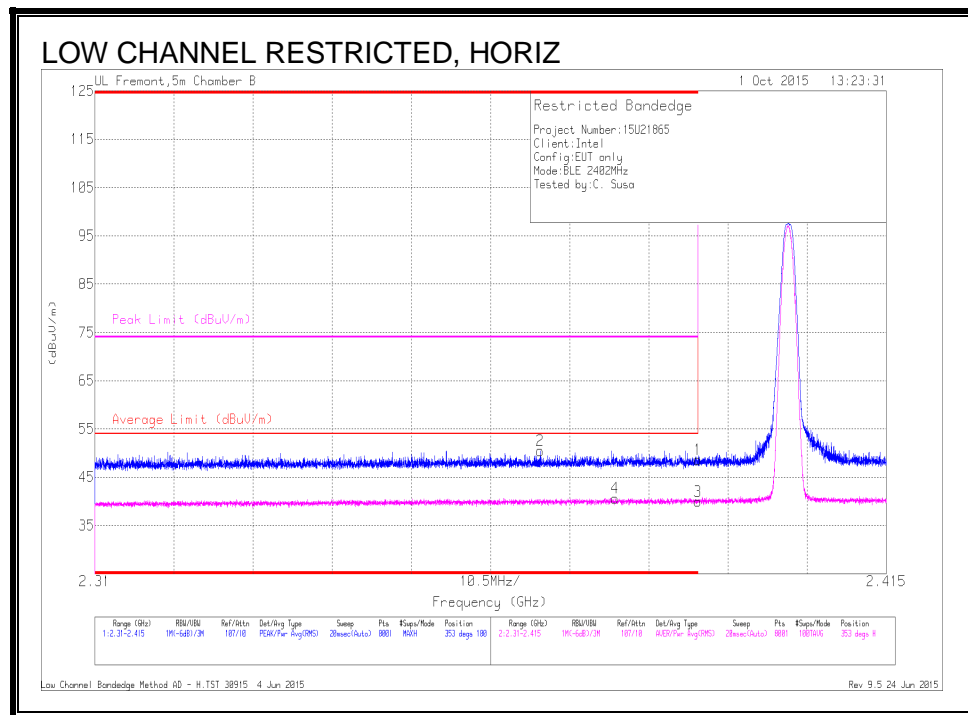

Trace Markers

Marker	Frequency (GHz)	Meter Reading (dBuV)	Det	AF T345 (dB/m)	Amp/Cbl/Filtr/Pad (dB)	DC Corr (dB)	Corrected Reading (dBuV/m)	Average Limit (dBuV/m)	Margin (dB)	Peak Limit (dBuV/m)	PK Margin (dB)	Azimuth (Degs)	Height (cm)	Polarity
1	* 2.39	40.72	Pk	32	-24.1	0	48.62	-	-	74	-25.38	353	180	H
2	* 2.369	42.78	Pk	31.9	-24.2	0	50.48	-	-	74	-23.52	353	180	H
3	* 2.39	30	RMS	32	-24.1	2.06	39.96	54	-14.04	-	-	353	180	H
4	* 2.379	30.81	RMS	31.9	-24.1	2.06	40.67	54	-13.33	-	-	353	180	H

* - indicates frequency in CFR15.205/IC7.2.2 Restricted Band

Pk - Peak detector

RMS - RMS detection

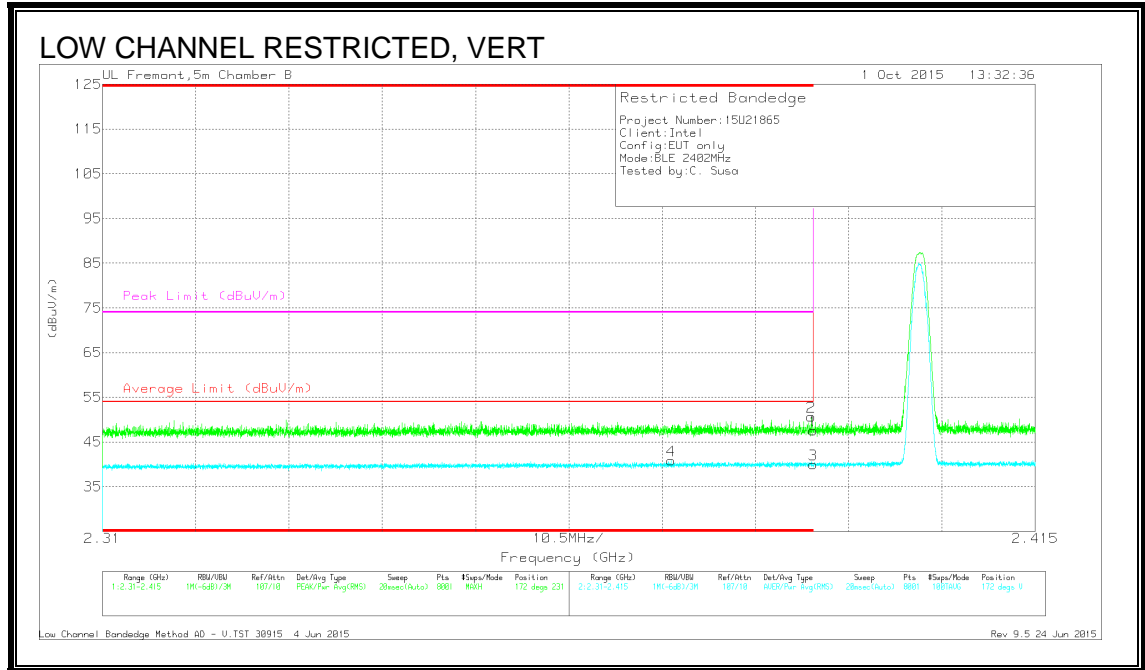

Trace Markers

Marker	Frequency (GHz)	Meter Reading (dBuV)	Det	AF T345 (dB/m)	Amp/Cbl/FI tr/Pad (dB)	DC Corr (dB)	Corrected Reading (dBuV/m)	Average Limit (dBuV/m)	Margin (dB)	Peak Limit (dBuV/m)	PK Margin (dB)	Azimuth (Degs)	Height (cm)	Polarity
1	* 2.39	39.64	Pk	32	-24.1	0	47.54	-	-	74	-26.46	172	231	V
2	* 2.39	42.82	Pk	32	-24.1	0	50.72	-	-	74	-23.28	172	231	V
3	* 2.39	30	RMS	32	-24.1	2.06	39.96	54	-14.04	-	-	172	231	V
4	* 2.374	30.94	RMS	31.9	-24.1	2.06	40.8	54	-13.2	-	-	172	231	V

* - indicates frequency in CFR15.205/IC7.2.2 Restricted Band
 Pk - Peak detector
 RMS - RMS detection

AUTHORIZED BANDEDGE (HIGH CHANNEL)

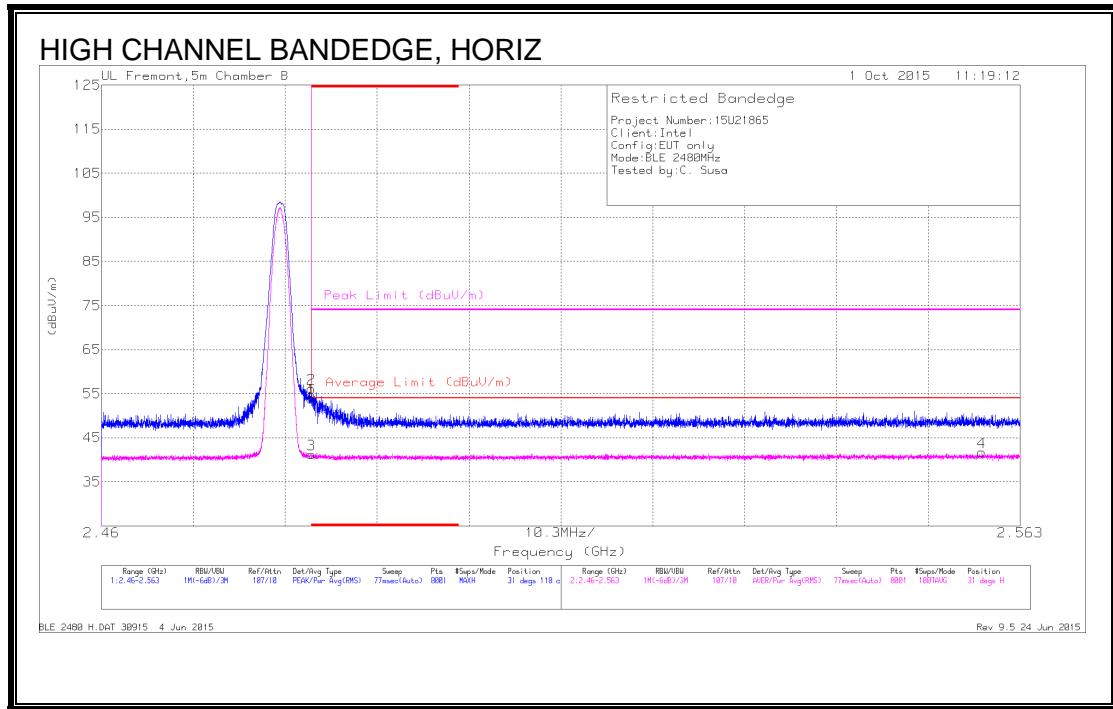

Trace Markers

Marker	Frequenc y (GHz)	Meter Reading (dBuV)	Det	AF T345 (dB/m)	Amp/Cb/FI tr/Pad (dB)	DC Corr (dB)	Corrected Reading (dBuV/m)	Average Limit (dBuV/m)	Margin (dB)	Peak Limit (dBuV/m)	PK Margin (dB)	Azimuth (Degs)	Height (cm)	Polarity
1	* 2.484	45.38	Pk	32.5	-24	0	53.88	-	-	74	-20.12	31	118	H
2	* 2.484	47.59	Pk	32.5	-24	0	56.09	-	-	74	-17.91	31	118	H
3	* 2.484	30.63	RMS	32.5	-24	2.06	41.19	54	-12.81	-	-	31	118	H
4	2.559	30.82	RMS	32.7	-23.9	2.06	41.68	54	-12.32	-	-	31	118	H

* - indicates frequency in CFR15.205/IC7.2.2 Restricted Band
 Pk - Peak detector
 RMS - RMS detection

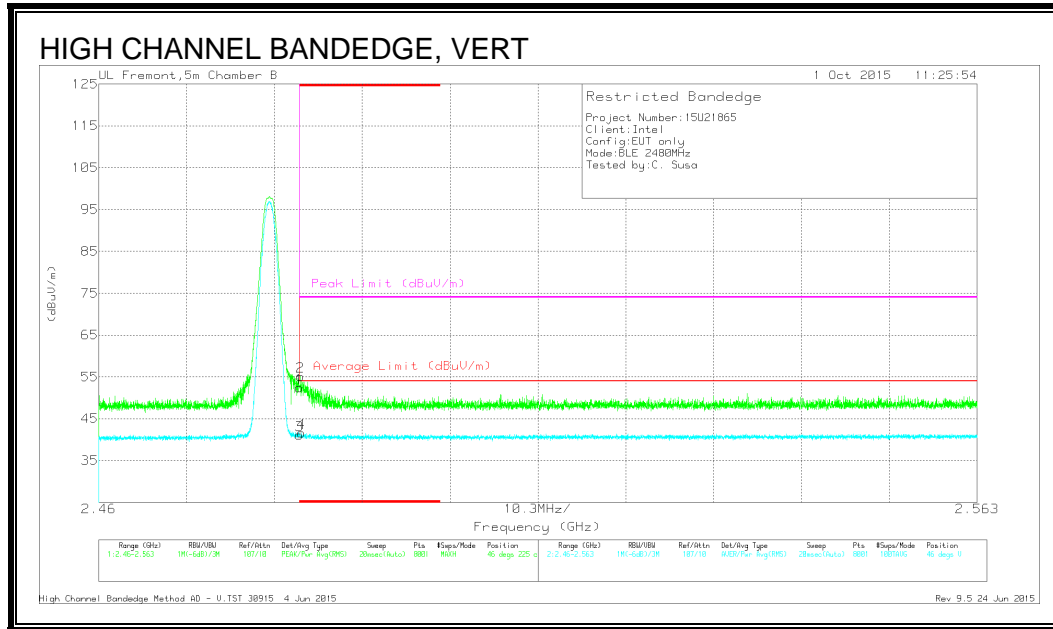

Trace Markers

Marker	Frequency (GHz)	Meter Reading (dBuV)	Det	AF T345 (dB/m)	Amp/Cb/Filtr/Pad (dB)	DC Corr (dB)	Corrected Reading (dBuV/m)	Average Limit (dBuV/m)	Margin (dB)	Peak Limit (dBuV/m)	PK Margin (dB)	Azimuth (Degs)	Height (cm)	Polarity
1	* 2.484	43.87	Pk	32.5	-24	0	52.37	-	-	74	-21.63	46	225	V
2	* 2.484	46.67	Pk	32.5	-24	0	55.17	-	-	74	-18.83	46	225	V
3	* 2.484	30.5	RMS	32.5	-24	2.06	41.06	54	-12.94	-	-	46	225	V
4	* 2.484	31.03	RMS	32.5	-24	2.06	41.59	54	-12.41	-	-	46	225	V

* - indicates frequency in CFR15.205/IC7.2.2 Restricted Band

Pk - Peak detector

RMS - RMS detection

HARMONICS AND SPURIOUS EMISSIONS

LOW CHANNEL

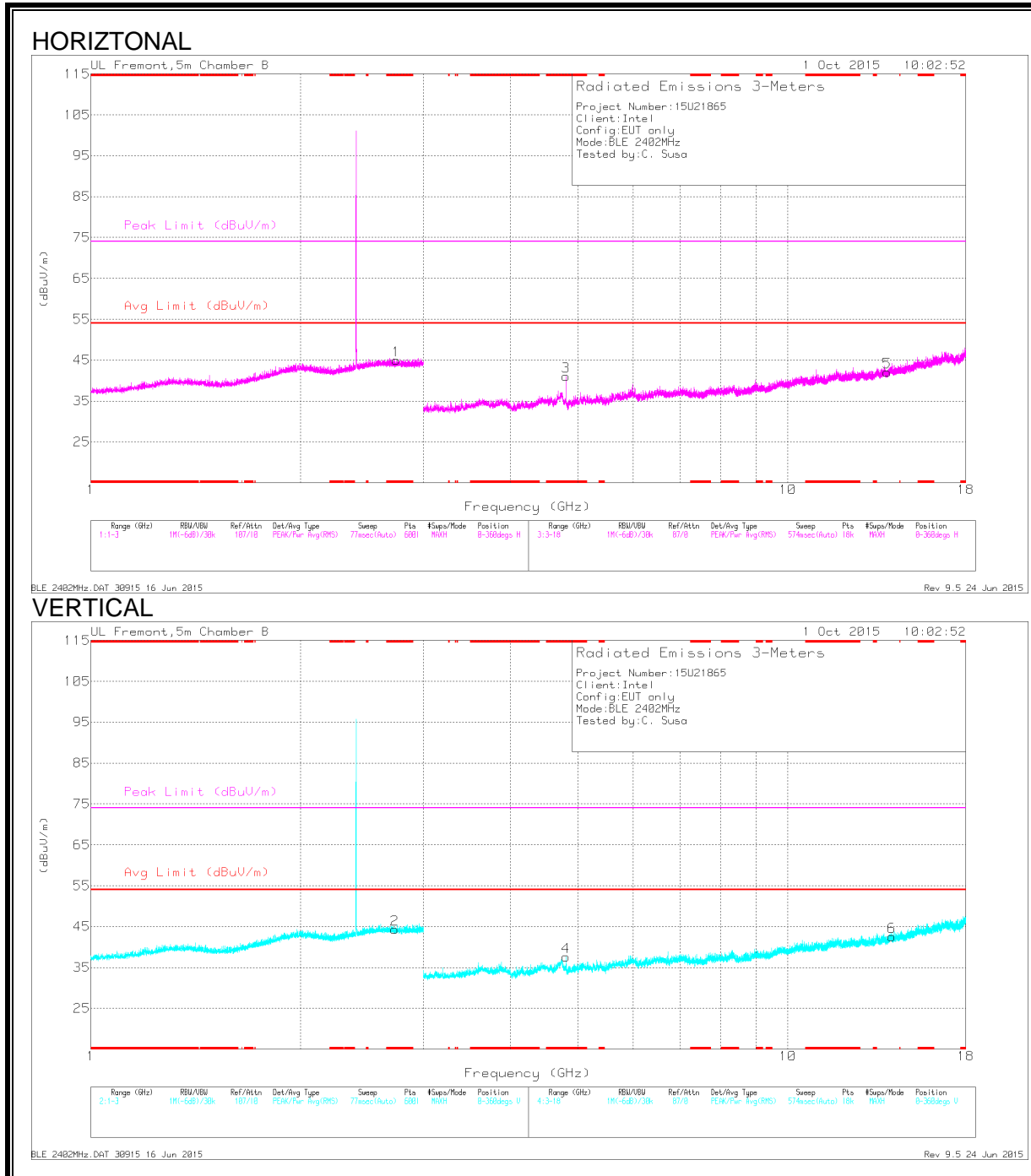

DATA

Markers	Frequency (GHz)	Meter Reading (dBuV)	Det	AF T345 (dB/m)	Amp/Cbl /Filtr/Pad (dB)	DC Corr (dB)	Corrected Reading (dBuV/m)	Avg Limit (dBuV/m)	Margin (dB)	Peak Limit (dBuV/m)	PK Margin (dB)	Azimuth (Degs)	Height (cm)	Polarit y
1	* 2.743	44.51	PK2	32.6	-23.8	0	53.31	-	-	74	-20.69	360	103	H
	* 2.741	32.25	MAv1	32.6	-23.8	2.06	43.11	54	-10.89	-	-	360	103	H
2	* 2.729	43.55	PK2	32.6	-23.7	0	52.45	-	-	74	-21.55	360	103	V
	* 2.73	32.24	MAv1	32.6	-23.7	2.06	43.2	54	-10.8	-	-	360	103	V
3	* 4.804	44.98	PK2	34.3	-31	0	48.28	-	-	74	-25.72	42	115	H
	* 4.804	36.57	MAv1	34.3	-31	2.06	41.93	54	-12.07	-	-	42	115	H
4	* 4.804	41.86	PK2	34.3	-31	0	45.16	-	-	74	-28.84	310	114	V
	* 4.804	30.87	MAv1	34.3	-31	2.06	36.23	54	-17.77	-	-	310	114	V
5	13.875	35.11	PK2	38.9	-23.9	0	50.11	-	-	-	-	360	200	H
6	14.095	35.89	PK2	39.1	-23.6	0	51.39	-	-	-	-	360	200	V

* - indicates frequency in CFR15.205/IC7.2.2 Restricted Band

PK2 - KDB558074 Method: Maximum Peak

MAv1 - KDB558074 Option 1 Maximum RMS Average

MID CHANNEL

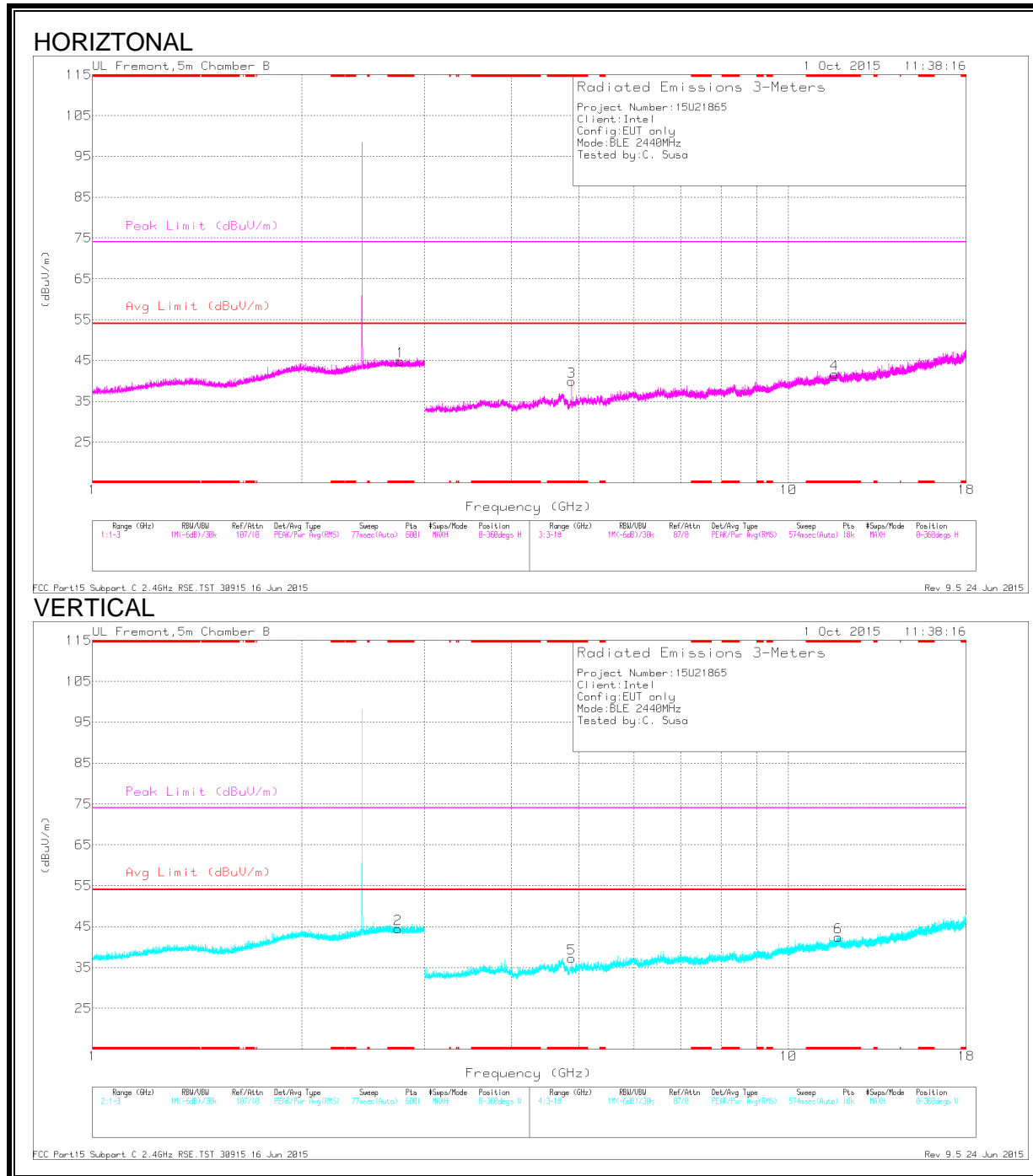

DATA

Marker	Frequency (GHz)	Meter Reading (dBuV)	Det	AF T345 (dB/m)	Amp/Cbl /Fitr/Pad (dB)	DC Corr (dB)	Corrected Reading (dBuV/m)	Avg Limit (dBuV/m)	Margin (dB)	Peak Limit (dBuV/m)	PK Margin (dB)	Azimuth (Degs)	Height (cm)	Polarity
1	* 2.771	43.98	PK2	32.6	-23.7	0	52.88	-	-	74	-21.12	1	198	H
	* 2.771	32.11	MAv1	32.6	-23.7	2.06	43.07	54	-10.93	-	-	1	198	H
2	* 2.748	43.94	PK2	32.6	-23.8	0	52.74	-	-	74	-21.26	360	199	V
	* 2.748	32.17	MAv1	32.6	-23.8	2.06	43.03	54	-10.97	-	-	360	199	V
4	* 11.651	36.31	PK2	38.5	-24.9	0	49.91	-	-	74	-24.09	360	199	H
	* 11.654	24.97	MAv1	38.5	-24.9	2.06	40.63	54	-13.37	-	-	360	199	H
3	* 4.879	44.33	PK2	34.2	-32.5	0	46.03	-	-	74	-27.97	41	220	H
	* 4.88	35.15	MAv1	34.2	-32.5	2.06	38.91	54	-15.09	-	-	41	220	H
6	* 11.781	35.55	PK2	38.6	-24.3	0	49.85	-	-	74	-24.15	360	199	V
	* 11.778	24.72	MAv1	38.6	-24.3	2.06	41.08	54	-12.92	-	-	360	199	V
5	* 4.88	42.02	PK2	34.2	-32.5	0	43.72	-	-	74	-30.28	95	109	V
	* 4.88	31.85	MAv1	34.2	-32.5	2.06	35.61	54	-18.39	-	-	95	109	V

* - indicates frequency in CFR15.205/IC7.2.2 Restricted Band

PK2 - KDB558074 Method: Maximum Peak

MAv1 - KDB558074 Option 1 Maximum RMS Average

HIGH CHANNEL

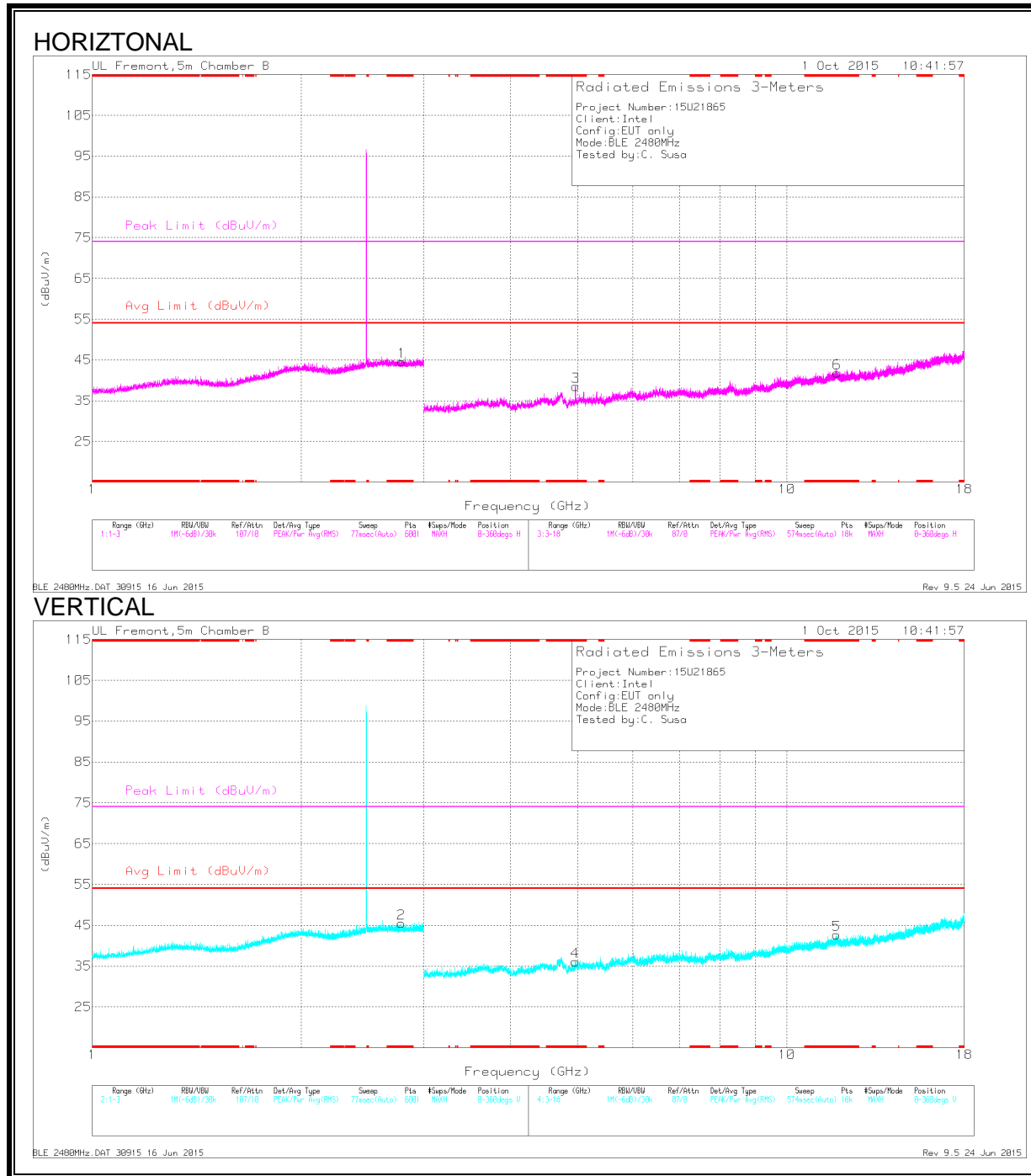

DATA

Marker	Frequency (GHz)	Meter Reading (dBuV)	Det	AF T345 (dB/m)	Amp/Cb I/Fitr/Pad (dB)	DC Corr (dB)	Corrected Reading (dBuV/m)	Avg Limit (dBuV/m)	Margin (dB)	Peak Limit (dBuV/m)	PK Margin (dB)	Azimuth (Degs)	Height (cm)	Polarity
1	* 2.792	43.92	PK2	32.6	-23.7	0	52.82	-	-	74	-21.18	360	199	H
	* 2.791	32.13	MAv1	32.6	-23.7	2.06	43.09	54	-10.91	-	-	360	199	H
2	* 2.786	43.78	PK2	32.6	-23.7	0	52.68	-	-	74	-21.32	360	102	V
	* 2.788	32.09	MAv1	32.6	-23.7	2.06	43.05	54	-10.95	-	-	360	102	V
6	* 11.809	35.48	PK2	38.6	-24.1	0	49.98	-	-	74	-24.02	360	102	H
	* 11.808	24.75	MAv1	38.6	-24.1	2.06	41.31	54	-12.69	-	-	360	102	H
3	* 4.96	44.59	PK2	34.1	-31.9	0	46.79	-	-	74	-27.21	54	284	H
	* 4.96	34.2	MAv1	34.1	-31.9	2.06	38.46	54	-15.54	-	-	54	284	H
5	* 11.792	35.92	PK2	38.6	-24.3	0	50.22	-	-	74	-23.78	360	200	V
	* 11.795	24.69	MAv1	38.6	-24.3	2.06	41.05	54	-12.95	-	-	360	200	V
4	* 4.961	42.35	PK2	34.1	-31.9	0	44.55	-	-	74	-29.45	76	117	V
	* 4.96	31.36	MAv1	34.1	-31.9	2.06	35.62	54	-18.38	-	-	76	117	V

* - indicates frequency in CFR15.205/IC7.2.2 Restricted Band

PK2 - KDB558074 Method: Maximum Peak

MAv1 - KDB558074 Option 1 Maximum RMS Average

8.3. WORST-CASE BELOW 1 GHz

SPURIOUS EMISSIONS 30 TO 1000 MHz (WORST-CASE CONFIGURATION)

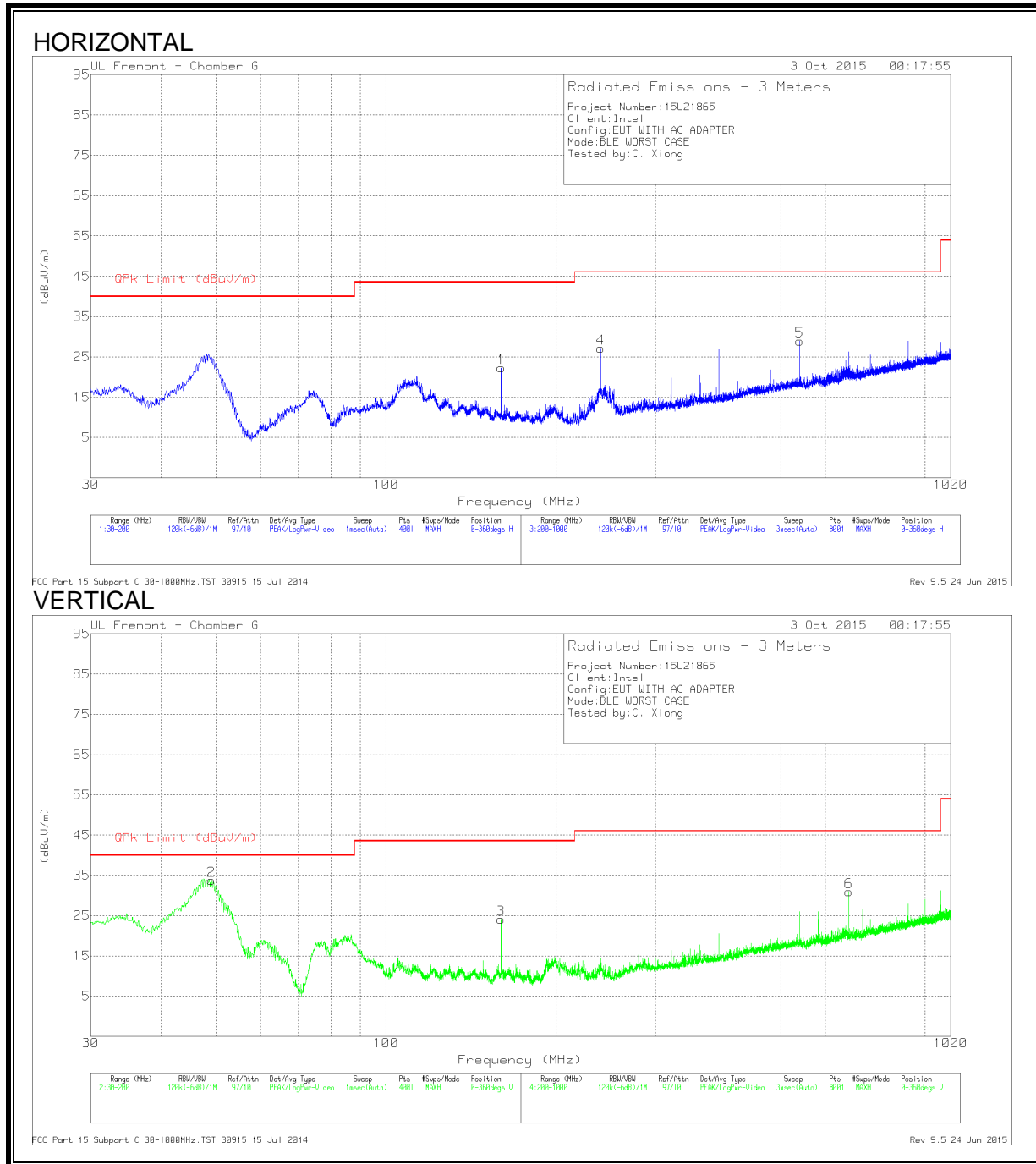

DATA

Marker	Frequency (MHz)	Meter Reading (dBuV)	Det	AF T899 (dB/m)	Amp Cbl (dB)	DC Corr (dB)	Corrected Reading (dBuV/m)	QPk Limit (dBuV/m)	Margin (dB)	Azimuth (Degs)	Height (cm)	Polarity
4	* 240	45.19	Pk	11.2	-29.3	0	27.09	46.02	-18.93	0-360	100	H
2	49.0825	56.76	Pk	8	-31	0	33.76	40	-6.24	0-360	100	V
3	159.9225	41.84	Pk	12.1	-29.9	0	24.04	43.52	-19.48	0-360	100	V
1	159.965	40.16	Pk	12.1	-29.9	0	22.36	43.52	-21.16	0-360	201	H
5	540	38.36	Pk	18.3	-27.7	0	28.96	46.02	-17.06	0-360	201	H
6	660	38.88	Pk	19.4	-27.3	0	30.98	46.02	-15.04	0-360	100	V

* - indicates frequency in CFR15.205/IC7.2.2 Restricted Band
 Pk - Peak detector

8.4. WORST-CASE ABOVE 18 GHz

SPURIOUS EMISSIONS 18 TO 26 GHz (WORST-CASE CONFIGURATION)

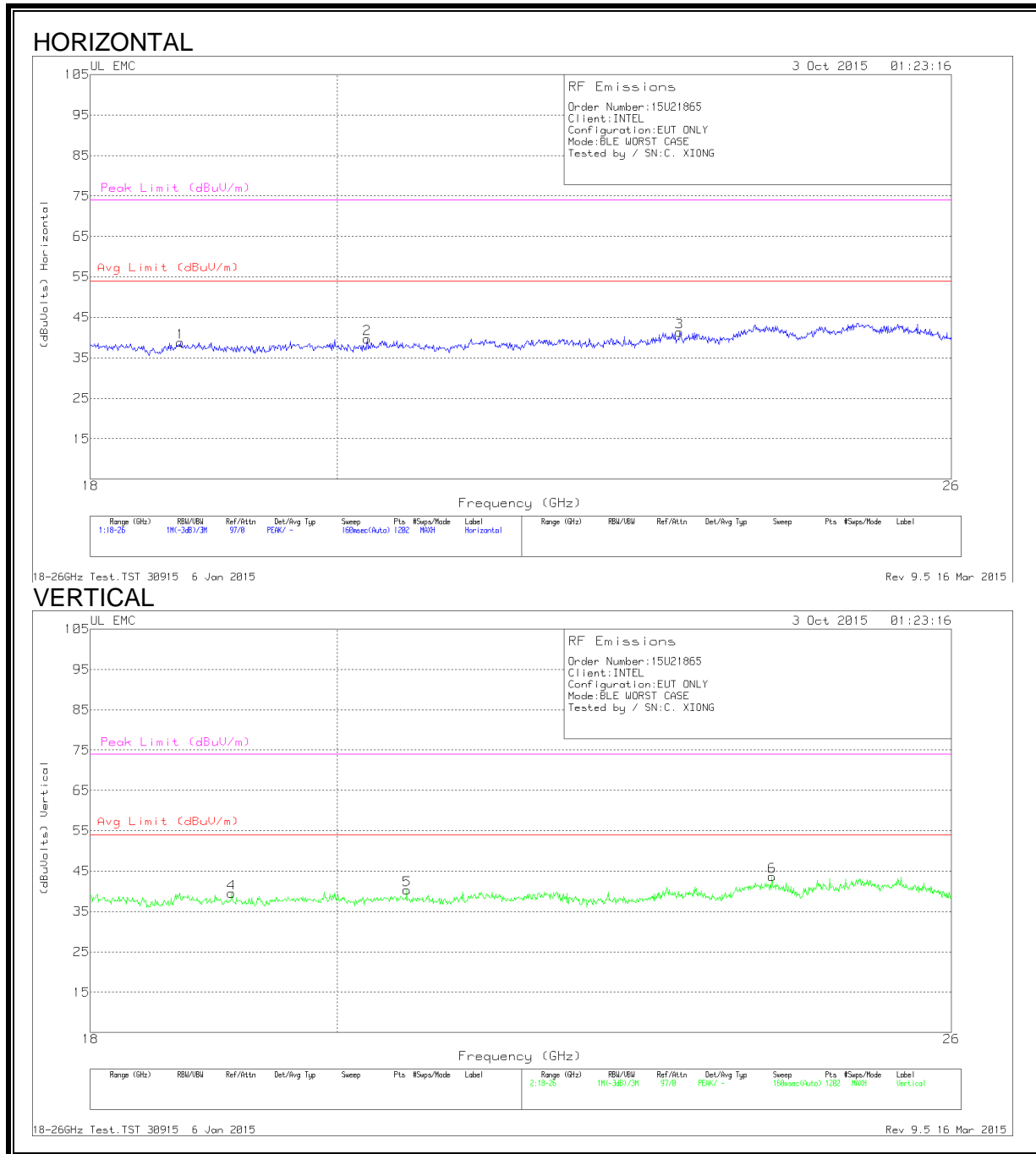

DATA

Marker	Frequency (GHz)	Meter Reading (dBUV)	Det	T89 AF (dB/m)	Amp/Cbl (dB)	Dist Corr (dB)	Corrected Reading (dBUVolts)	Avg Limit (dBUV/m)	Margin (dB)	Peak Limit (dBUV/m)	PK Margin (dB)
1	18.706	40.23	Pk	32.5	-24.4	-9.5	38.833	54	-15.167	74	-35.167
2	20.258	41.87	Pk	32.5	-25.2	-9.5	39.667	54	-14.333	74	-34.333
3	23.149	42.33	Pk	33.5	-25	-9.5	41.333	54	-12.667	74	-32.667
4	19.119	41.3	Pk	32.2	-24.5	-9.5	39.5	54	-14.5	74	-34.5
5	20.604	42.63	Pk	32.7	-25.5	-9.5	40.333	54	-13.667	74	-33.667
6	24.082	44.17	Pk	33.3	-24.3	-9.5	43.667	54	-10.333	74	-30.333

Pk - Peak detector

9. AC POWER LINE CONDUCTED EMISSIONS

LIMITS

FCC §15.207 (a)

RSS-Gen 8.8

Frequency of Emission (MHz)	Conducted Limit (dBµV)	
	Quasi-peak	Average
0.15-0.5	66 to 56 *	56 to 46 *
0.5-5	56	46
5-30	60	50

TEST PROCEDURE

C63.10

RESULTS

9.1. EUT WITH AC ADAPTER

LINE 1 RESULTS

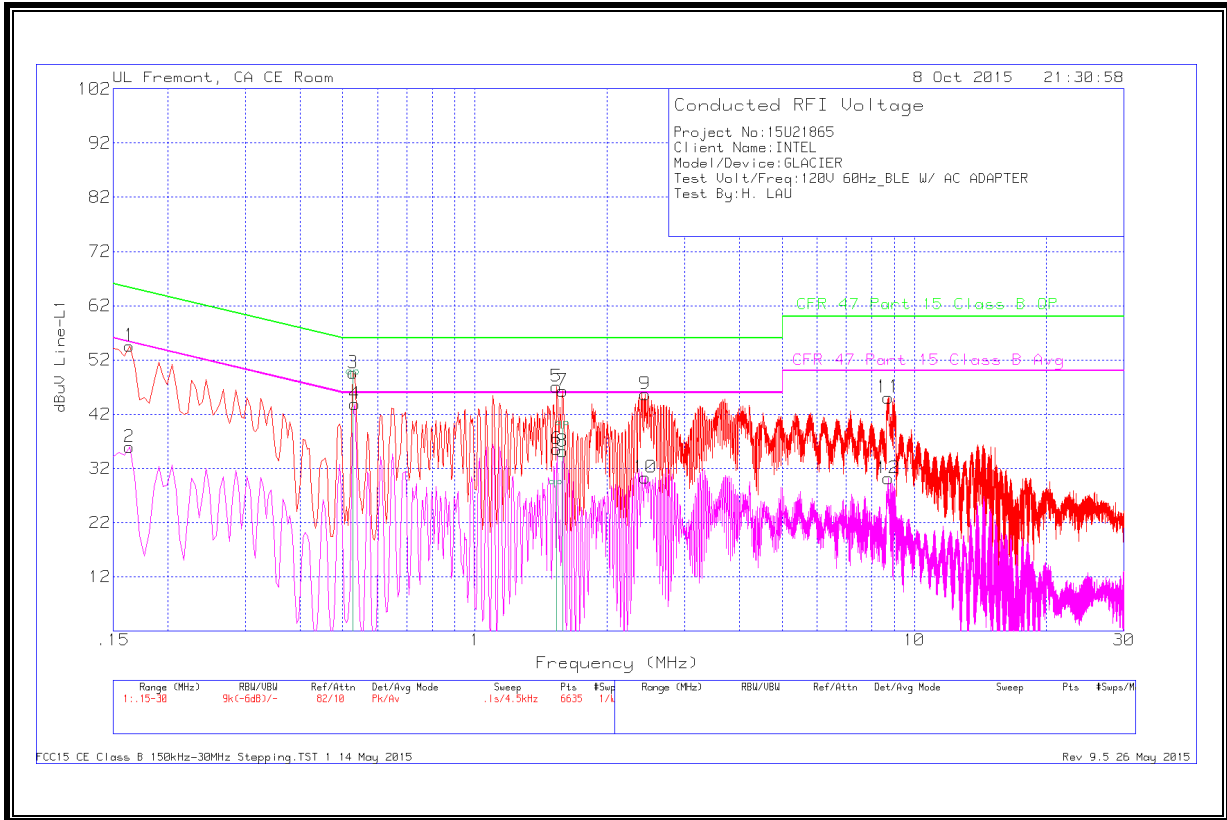

DATA

Range 1: Line-L1 .15 - 30MHz

Marker	Frequency (MHz)	Meter Reading (dBuV)	Det	T24 IL L1	LC Cables 1&3	Corrected Reading dBuV	CFR 47 Part 15 Class B QP	Margin (dB)	CFR 47 Part 15 Class B Avg	Margin (dB)
1	.1635	53.37	Pk	1.2	0	54.57	65.28	-10.71	-	-
2	.1635	34.74	Av	1.2	0	35.94	-	-	55.28	-19.34
3	.528	49.3	Pk	.3	0	49.6	56	-6.4	-	-
	.528	48.49	Qp	.3	0	48.79	56	-7.21	-	-
4	.5325	43.57	Av	.3	0	43.87	-	-	46	-2.13
	.528	44.24	Ca	.3	0	44.54	-	-	46	-1.46
5	1.5315	46.77	Pk	.2	.1	47.07	56	-8.93	-	-
	1.5315	28.21	Qp	.2	.1	28.51	56	-27.49	-	-
6	1.536	35.25	Av	.2	.1	35.55	-	-	46	-10.45
	1.5315	13.68	Ca	.2	.1	13.98	-	-	46	-32.02
7	1.5855	46	Pk	.2	.1	46.3	56	-9.7	-	-
	1.5855	39.09	Qp	.2	.1	39.39	56	-16.61	-	-
8	1.5855	34.84	Av	.2	.1	35.14	-	-	46	-10.86
	1.5855	33.29	Ca	.2	.1	33.59	-	-	46	-12.41
9	2.4405	45.41	Pk	.2	.1	45.71	56	-10.29	-	-
10	2.4405	30.03	Av	.2	.1	30.33	-	-	46	-15.67
11	8.7315	44.77	Pk	.2	.1	45.07	60	-14.93	-	-
12	8.7315	29.86	Av	.2	.1	30.16	-	-	50	-19.84

Pk - Peak detector
 Av - Average detection
 Qp - Quasi-Peak detector
 Ca - CISPR average detection

LINE 2 RESULTS

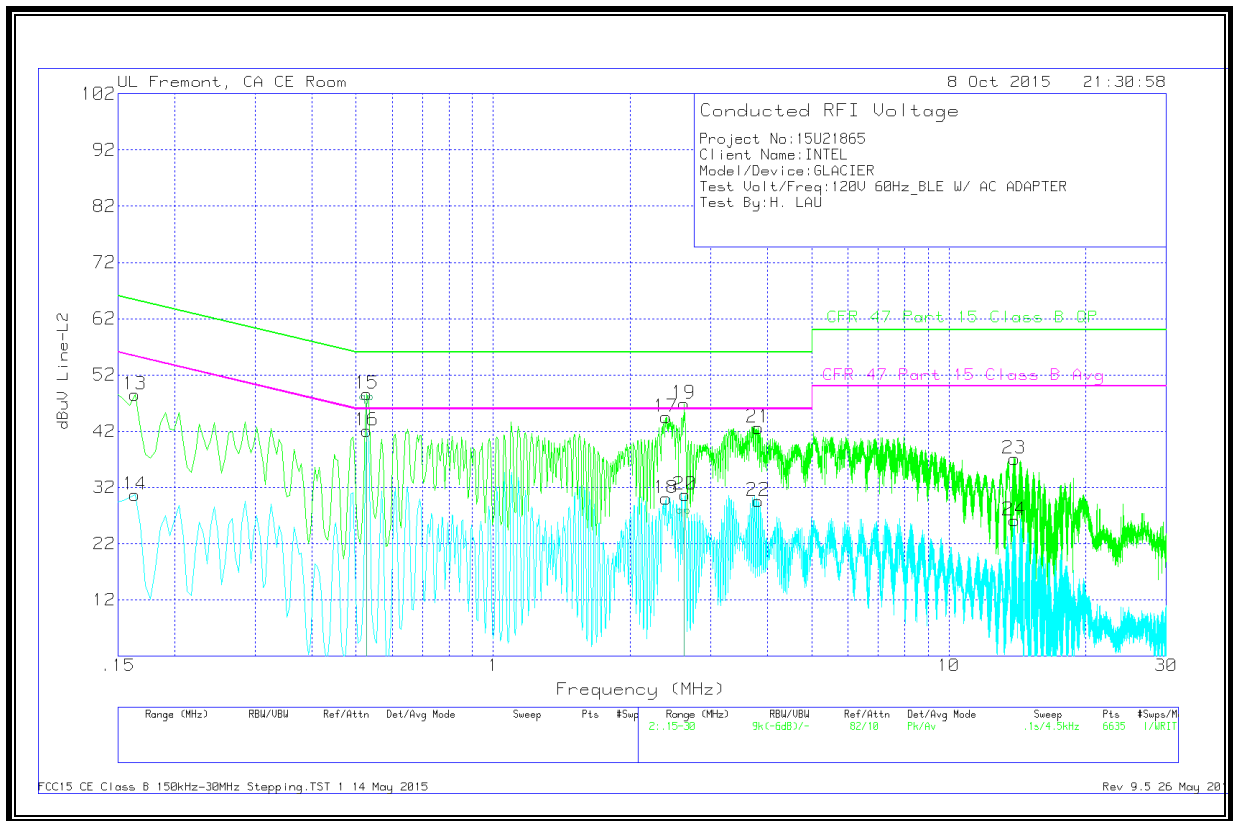

DATA

Range 2: Line-L2 .15 - 30MHz

Marker	Frequency (MHz)	Meter Reading (dBUV)	Det	T24 IL L2	LC Cables 2&3	Corrected Reading dBUV	CFR 47 Part 15 Class B QP	Margin (dB)	CFR 47 Part 15 Class B Avg	Margin (dB)
13	.1635	47.22	Pk	1.3	0	48.52	65.28	-16.76	-	-
14	.1635	29.38	Av	1.3	0	30.68	-	-	55.28	-24.6
15	.528	48.35	Pk	.3	0	48.65	56	-7.35	-	-
	.528	46.72	Qp	.3	0	47.02	56	-8.98	-	-
16	.528	41.81	Av	.3	0	42.11	-	-	46	-3.89
	.528	42.12	Ca	.3	0	42.42	-	-	46	-3.58
17	2.3955	44.21	Pk	.2	.1	44.51	56	-11.49	-	-
18	2.3955	29.78	Av	.2	.1	30.08	-	-	46	-15.92
19	2.6205	46.59	Pk	.2	.1	46.89	56	-9.11	-	-
	2.6205	26.51	Qp	.2	.1	26.81	56	-29.19	-	-
20	2.6385	30.39	Av	.2	.1	30.69	-	-	46	-15.31
	2.6205	10.82	Ca	.2	.1	11.12	-	-	46	-34.88
21	3.8175	42.34	Pk	.2	.1	42.64	56	-13.36	-	-
22	3.8175	29.29	Av	.2	.1	29.59	-	-	46	-16.41
23	13.9245	36.71	Pk	.2	.2	37.11	60	-22.89	-	-
24	13.92	25.75	Av	.2	.2	26.15	-	-	50	-23.85

Pk - Peak detector
 Av - Average detection
 Qp - Quasi-Peak detector
 Ca - CISPR average detection

9.2. EUT WITH USB LAPTOP

LINE 1 RESULTS

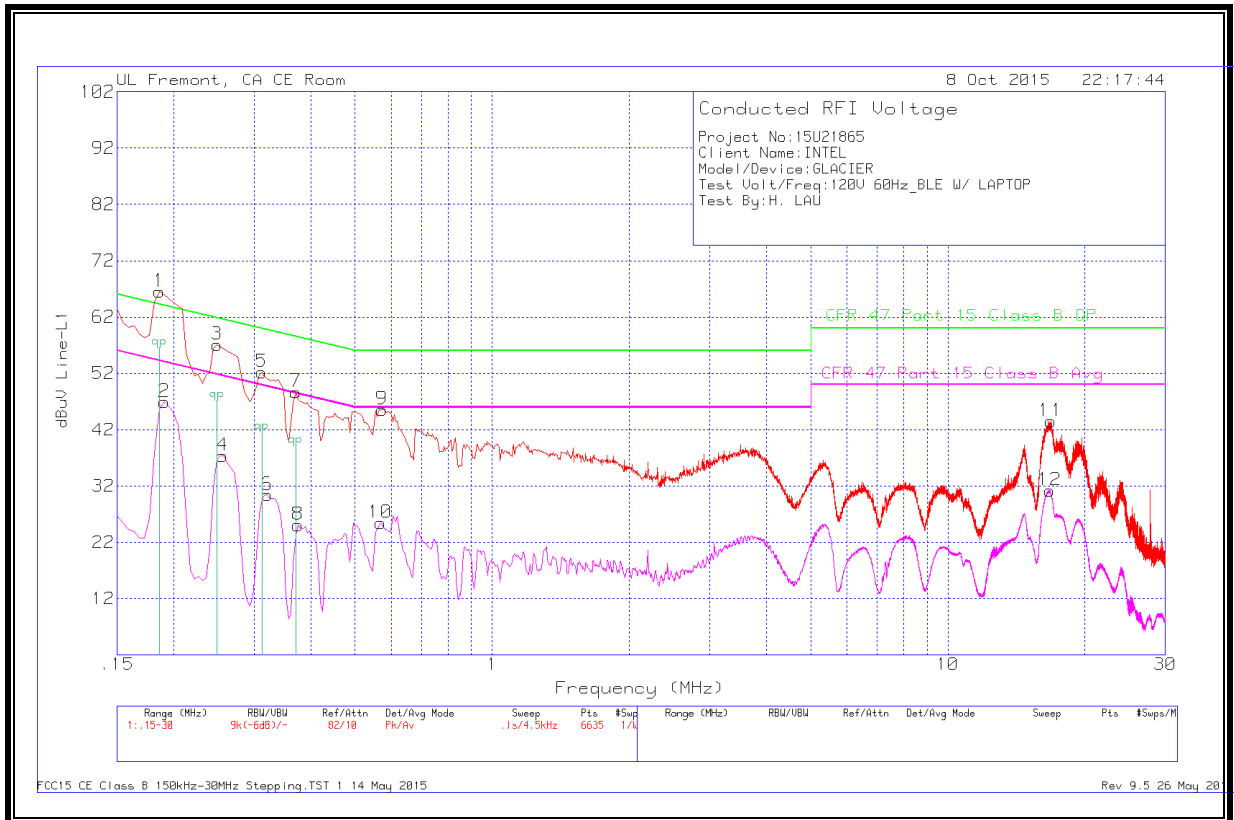

DATA

LINE 2 RESULTS

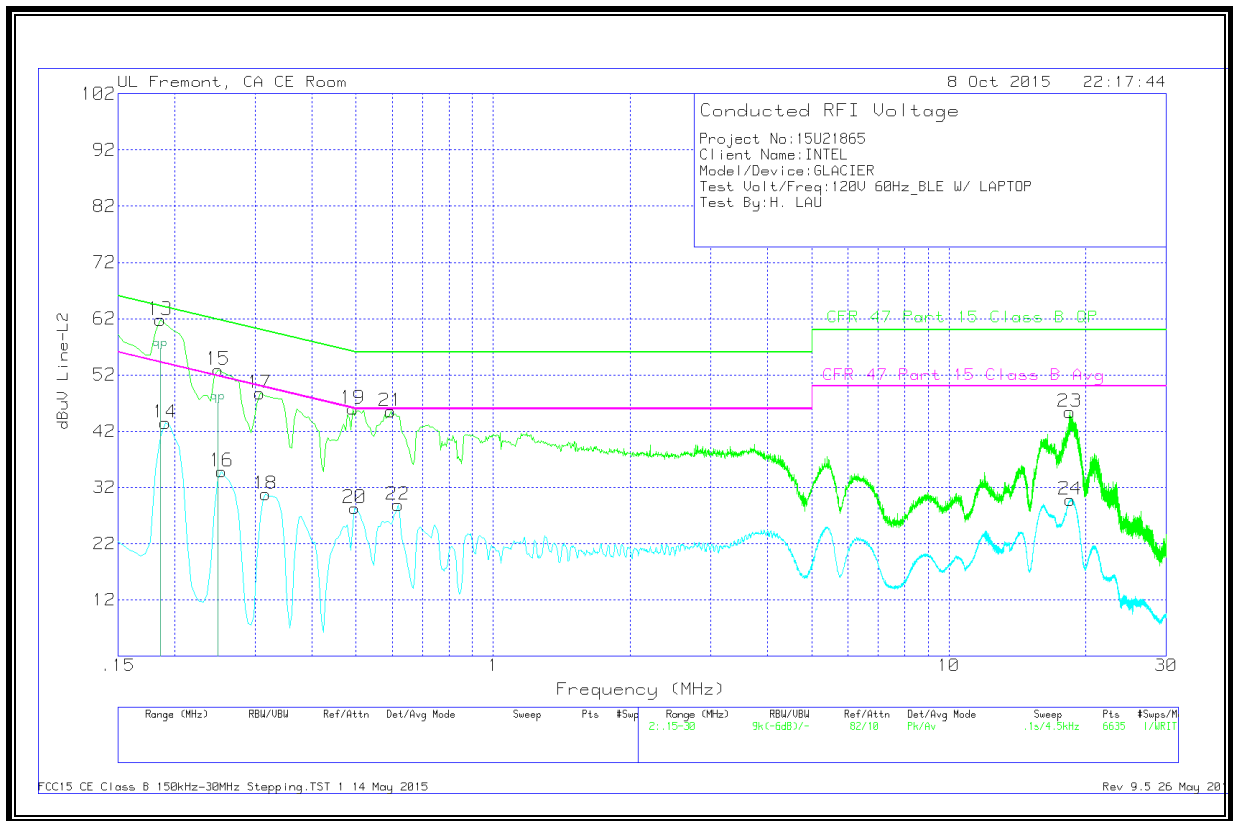

DATA

Range 1: Line-L1 .15 - 30MHz

Marker	Frequenc y (MHz)	Meter Reading (dBuV)	Det	T24 IL L1	LC Cables 1&3	Corrected Reading dBuV	CFR 47 Part 15 Class B QP	Margin (dB)	CFR 47 Part 15 Class B Avg	Margin (dB)
1	.186	55.62	Qp	1	0	56.62	64.21	-7.59	-	-
2	.1905	45.91	Av	1	0	46.91	-	-	54.01	-7.1
	.186	40.34	Ca	1	0	41.34	-	-	54.21	-12.87
3	.249	56.4	Pk	.7	0	57.1	61.79	-4.69	-	-
	.249	46.52	Qp	.7	0	47.22	61.79	-14.57	-	-
4	.25575	36.65	Av	.7	0	37.35	-	-	51.57	-14.22
	.249	33.51	Ca	.7	0	34.21	-	-	51.79	-17.58
5	.312	51.73	Pk	.5	0	52.23	59.92	-7.69	-	-
	.312	41.09	Qp	.5	0	41.59	59.92	-18.33	-	-
6	.321	29.9	Av	.5	0	30.4	-	-	49.68	-19.28
	.312	24.8	Ca	.5	0	25.3	-	-	49.92	-24.62
7	.3705	48.27	Pk	.4	0	48.67	58.49	-9.82	-	-
	.3705	38.8	Qp	.4	0	39.2	58.49	-19.29	-	-
8	.375	24.69	Av	.4	0	25.09	-	-	48.39	-23.3
	.3705	24.8	Ca	.4	0	25.2	-	-	48.49	-23.29
9	.573	45.28	Pk	.3	0	45.58	56	-10.42	-	-
10	.5685	25.16	Av	.3	0	25.46	-	-	46	-20.54
11	16.818	42.98	Pk	.3	.2	43.48	60	-16.52	-	-
12	16.7415	30.68	Av	.3	.2	31.18	-	-	50	-18.82

Pk - Peak detector
 Av - Average detection
 Qp - Quasi-Peak detector
 Ca - CISPR average detection