



**FCC 47 CFR PART 15 SUBPART C
INDUSTRY CANADA RSS-247 ISSUE 1**

CERTIFICATION TEST REPORT

FOR

SMART WATCH WITH 802.11B/G/N, BLUETOOTH AND BLE

MODEL NUMBER: DW1

FCC ID: 2AB8ZND10

IC: 1000X-ND10

REPORT NUMBER: 15U21900-E3V1

ISSUE DATE: OCTOBER 19, 2015

Prepared for
**INTEL CORPORATION
2200 MISSION COLLEGE BOULEVARD,
SANTA CLARA, CA 95052, U.S.A**

Prepared by
**UL VERIFICATION SERVICES INC.
47173 BENICIA STREET
FREMONT, CA 94538, U.S.A.
TEL: (510) 771-1000
FAX: (510) 661-0888**



NVLAP LAB CODE 200065-0

Revision History

<u>Rev.</u>	<u>Issue Date</u>	<u>Revisions</u>	<u>Revised By</u>
V1	10/19/2015	Initial Issue	C. Pang
V2	10/22/2015	Updated antenna gains in section 5.3, 8.2.3, 8.3.3, 8.4.3	C. Susa

TABLE OF CONTENTS

1. ATTESTATION OF TEST RESULTS	5
2. TEST METHODOLOGY	6
3. FACILITIES AND ACCREDITATION	6
4. CALIBRATION AND UNCERTAINTY	6
4.1. <i>MEASURING INSTRUMENT CALIBRATION</i>	<i>6</i>
4.2. <i>SAMPLE CALCULATION</i>	<i>6</i>
4.3. <i>MEASUREMENT UNCERTAINTY.....</i>	<i>7</i>
5. EQUIPMENT UNDER TEST	8
5.1. <i>DESCRIPTION OF EUT</i>	<i>8</i>
5.2. <i>MAXIMUM OUTPUT POWER.....</i>	<i>8</i>
5.3. <i>DESCRIPTION OF AVAILABLE ANTENNAS</i>	<i>8</i>
5.4. <i>SOFTWARE AND FIRMWARE.....</i>	<i>8</i>
5.5. <i>WORST-CASE CONFIGURATION AND MODE.....</i>	<i>8</i>
5.6. <i>DESCRIPTION OF TEST SETUP.....</i>	<i>9</i>
6. TEST AND MEASUREMENT EQUIPMENT	14
7. MEASUREMENT METHODS	15
8. ANTENNA PORT TEST RESULTS	16
8.1. <i>ON TIME AND DUTY CYCLE.....</i>	<i>16</i>
8.2. <i>802.11b MODE IN THE 2.4 GHz BAND.....</i>	<i>19</i>
8.2.1. <i>6 dB BANDWIDTH.....</i>	<i>19</i>
8.2.2. <i>99% BANDWIDTH.....</i>	<i>22</i>
8.2.3. <i>OUTPUT POWER</i>	<i>25</i>
8.2.4. <i>POWER SPECTRAL DENSITY</i>	<i>27</i>
8.2.5. <i>OUT-OF-BAND EMISSIONS</i>	<i>30</i>
8.3. <i>802.11g MODE IN THE 2.4 GHz BAND.....</i>	<i>36</i>
8.3.1. <i>6 dB BANDWIDTH.....</i>	<i>36</i>
8.3.2. <i>99% BANDWIDTH.....</i>	<i>40</i>
8.3.3. <i>OUTPUT POWER</i>	<i>44</i>
8.3.4. <i>POWER SPECTRAL DENSITY</i>	<i>45</i>
8.3.5. <i>OUT-OF-BAND EMISSIONS</i>	<i>49</i>
8.4. <i>802.11n HT20 MODE IN THE 2.4 GHz BAND</i>	<i>56</i>
8.4.1. <i>6 dB BANDWIDTH.....</i>	<i>56</i>
8.4.2. <i>99% BANDWIDTH.....</i>	<i>60</i>
8.4.3. <i>OUTPUT POWER</i>	<i>64</i>
8.4.4. <i>POWER SPECTRAL DENSITY</i>	<i>65</i>
8.4.5. <i>OUT-OF-BAND EMISSIONS</i>	<i>69</i>

9. RADIATED TEST RESULTS.....76

9.1. *LIMITS AND PROCEDURE.....76*

9.2. *TRANSMITTER ABOVE 1 GHz.....77*

9.2.1. TX ABOVE 1 GHz 802.11b MODE IN THE 2.4 GHz BAND77

9.2.2. TX ABOVE 1 GHz 802.11g MODE IN THE 2.4 GHz BAND91

9.2.3. TX ABOVE 1 GHz 802.11n HT20 MODE IN THE 2.4 GHz BAND.....109

9.3. *WORST-CASE BELOW 1 GHz.....127*

10. AC POWER LINE CONDUCTED EMISSIONS129

10.1. *EUT WITH AC ADAPTER.....130*

10.2. *EUT WITH USB LAPTOP.....133*

11. SETUP PHOTOS135

1. ATTESTATION OF TEST RESULTS

COMPANY NAME: INTEL CORPORATION
2200 MISSION COLLEGE BOULEVARD
SANTA CLARA, CA 95052, U.S.A.

EUT DESCRIPTION: SMART WATCH with 802.11b/g/n, Bluetooth and BLE

MODEL: DW1

SERIAL NUMBER: TIDPC3FZ52800CH (Radiated); TIDPC1FZ536009X (Conducted)

DATE TESTED: OCTOBER 15 – 19, 2015

APPLICABLE STANDARDS	
STANDARD	TEST RESULTS
CFR 47 Part 15 Subpart C	Pass
INDUSTRY CANADA RSS-247 Issue 1	Pass
INDUSTRY CANADA RSS-GEN Issue 4	Pass

UL Verification Services Inc. tested the above equipment in accordance with the requirements set forth in the above standards. All indications of Pass/Fail in this report are opinions expressed by UL Verification Services Inc. based on interpretations and/or observations of test results. Measurement Uncertainties were not taken into account and are published for informational purposes only. The test results show that the equipment tested is capable of demonstrating compliance with the requirements as documented in this report.

Note: The results documented in this report apply only to the tested sample, under the conditions and modes of operation as described herein. This document may not be altered or revised in any way unless done so by UL Verification Services Inc. and all revisions are duly noted in the revisions section. Any alteration of this document not carried out by UL Verification Services Inc. will constitute fraud and shall nullify the document. This report must not be used by the client to claim product certification, approval, or endorsement by NVLAP, NIST, any agency of the Federal Government, or any agency of any government.

Approved & Released For
UL Verification Services Inc. By:



CHIN PANG
EMC SUPERVISOR
UL VERIFICATION SERVICES INC.

Tested By:

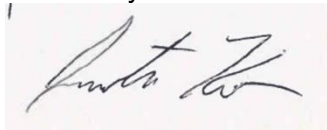

JUSTIN KO
EMC ENGINEER
UL VERIFICATION SERVICES INC.

2. TEST METHODOLOGY

The tests documented in this report were performed in accordance with FCC CFR 47 Part 2, FCC CFR 47 Part 15, ANSI C63.10-2013, RSS-GEN Issue 4 and RSS-247 Issue 1.

3. FACILITIES AND ACCREDITATION

The test sites and measurement facilities used to collect data are located at 47173 and 47266 Benicia Street, Fremont, California, USA. Line conducted emissions are measured only at the 47173 address. The following table identifies which facilities were utilized for radiated emission measurements documented in this report. Specific facilities are also identified in the test results sections.

47173 Benicia Street	47266 Benicia Street
<input type="checkbox"/> Chamber A(IC: 2324B-1)	<input checked="" type="checkbox"/> Chamber D(IC: 2324B-4)
<input type="checkbox"/> Chamber B(IC: 2324B-2)	<input type="checkbox"/> Chamber E(IC: 2324B-5)
<input checked="" type="checkbox"/> Chamber C(IC: 2324B-3)	<input type="checkbox"/> Chamber F(IC: 2324B-6)
	<input type="checkbox"/> Chamber G(IC: 2324B-7)
	<input type="checkbox"/> Chamber H(IC: 2324B-8)

The above test sites and facilities are covered under FCC Test Firm Registration # 208313. Chambers A through H are covered under Industry Canada company address code 2324B with site numbers 2324B -1 through 2324B-8, respectively.

UL Verification Services Inc. is accredited by NVLAP, Laboratory Code 200065-0. The full scope of accreditation can be viewed at <http://ts.nist.gov/standards/scopes/2000650.htm>.

4. CALIBRATION AND UNCERTAINTY

4.1. MEASURING INSTRUMENT CALIBRATION

The measuring equipment utilized to perform the tests documented in this report has been calibrated in accordance with the manufacturer's recommendations, and is traceable to recognized national standards.

4.2. SAMPLE CALCULATION

Where relevant, the following sample calculation is provided:

$$\begin{aligned} \text{Field Strength (dBuV/m)} &= \text{Measured Voltage (dBuV)} + \text{Antenna Factor (dB/m)} + \\ &\text{Cable Loss (dB)} - \text{Preamp Gain (dB)} \\ 36.5 \text{ dBuV} + 18.7 \text{ dB/m} + 0.6 \text{ dB} - 26.9 \text{ dB} &= 28.9 \text{ dBuV/m} \end{aligned}$$

4.3. MEASUREMENT UNCERTAINTY

Where relevant, the following measurement uncertainty levels have been estimated for tests performed on the apparatus:

PARAMETER	UNCERTAINTY
Conducted Disturbance, 0.15 to 30 MHz	± 3.52 dB
Radiated Disturbance, 30 to 1000 MHz	± 4.94 dB
Radiated Disturbance, 1 to 6 GHz	± 3.86 dB
Radiated Disturbance, 6 to 18 GHz	± 4.23 dB
Radiated Disturbance, 18 to 26 GHz	± 5.30 dB
Radiated Disturbance, 26 to 40 GHz	± 5.23 dB

Uncertainty figures are valid to a confidence level of 95%.

5. EQUIPMENT UNDER TEST

5.1. DESCRIPTION OF EUT

The EUT is a smart watch with SMART WATCH with 802.11b/g/n, Bluetooth and BLE

5.2. MAXIMUM OUTPUT POWER

The transmitter has a maximum conducted output power as follows:

Frequency Range (MHz)	Mode	Output Power (dBm)	Output Power (mW)
2412 - 2472	802.11b	15.70	37.15
2412 - 2472	802.11g	16.51	44.77
2412 - 2472	802.11n HT20	16.42	43.85

5.3. DESCRIPTION OF AVAILABLE ANTENNAS

The radio utilizes a trace antenna, with a maximum gain of -0.84 dBi.

5.4. SOFTWARE AND FIRMWARE

The firmware installed in the EUT during testing was DVT Eng. Build.

5.5. WORST-CASE CONFIGURATION AND MODE

Radiated emission and power line conducted emission were performed with the EUT set to transmit at the channel with highest output power as worst-case scenario.

The fundamental of the EUT was investigated in three orthogonal orientations X, Y and Z, it was determined that Z orientation was worst-case orientation; therefore, all final radiated testing was performed with the EUT in Z orientation.

Worst-case data rates as provided by the client were:

802.11b mode: 1 Mbps
802.11g mode: 6 Mbps
802.11n HT20mode: MCS0

5.6. DESCRIPTION OF TEST SETUP

SUPPORT EQUIPMENT

Support Equipment List				
Description	Manufacturer	Model	Serial Number	FCC ID
Laptop	Lenovo	Yoga 2 11	YB04282152	N/A
AC adapter	Lenovo	ADLX45NCC3A	11S45N0297Z1ZSH443G0XE	N/A

I/O CABLES

I/O Cable List						
Cable No	Port	# of identical ports	Connector Type	Cable Type	Cable Length (m)	Remarks
1	AC	1	3-Prong	Un-Shielded	1.8	N/A
2	DC	1	DC	Un-Shielded	1	N/A
3	USB	1	USB	Un-Shielded	0.9	Laptop to EUT
4	Antenna	1	SMA	Shielded	0.3	EUT to spectrum Analyzer
5	AC/DC	1	USB Micro	Un-Shielded	0.9	

TEST SETUP

Test software exercised the radio card.

SETUP DIAGRAM FOR CONDUCTED TESTS

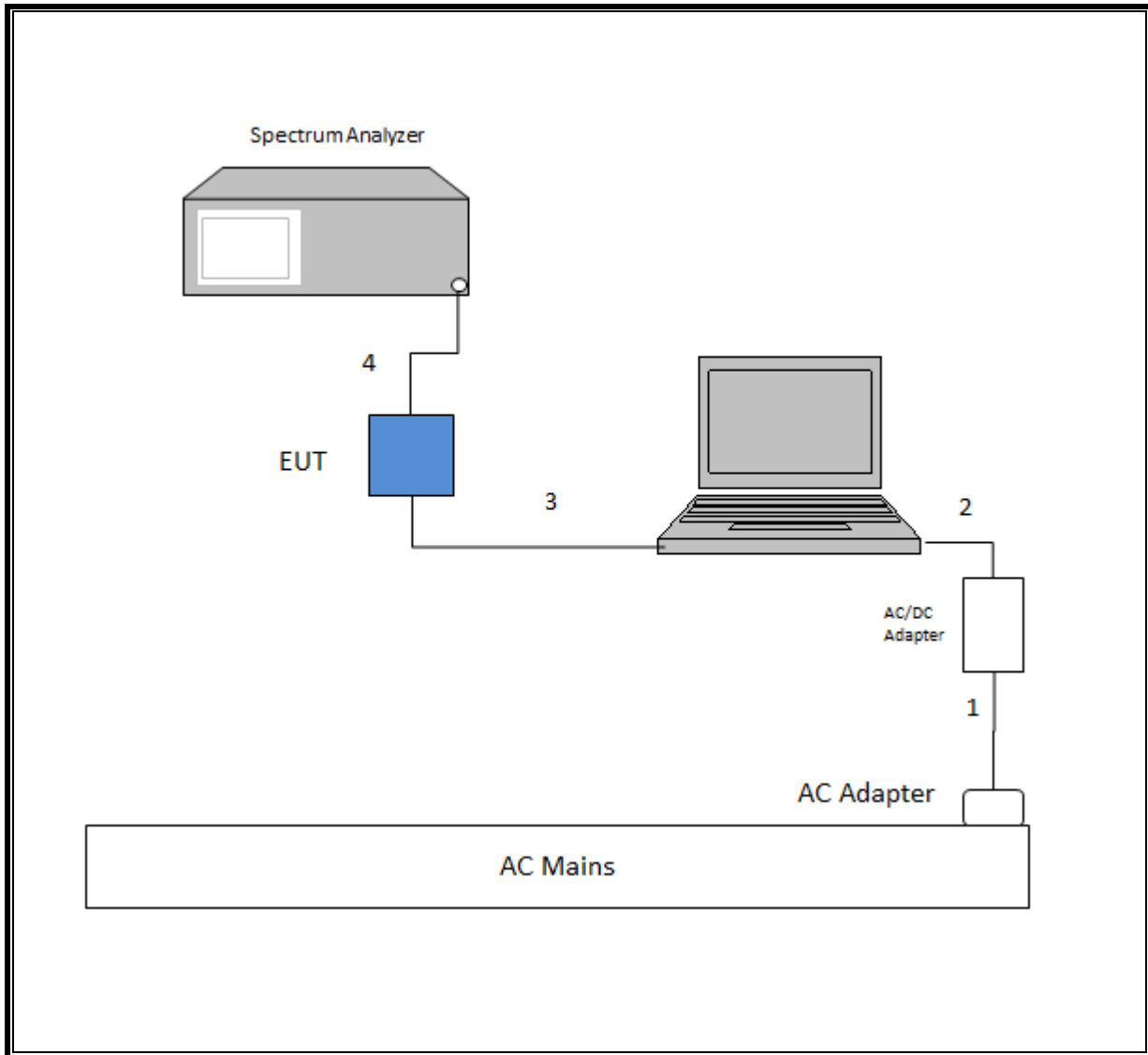

SETUP DIAGRAM FOR RADIATED TESTS

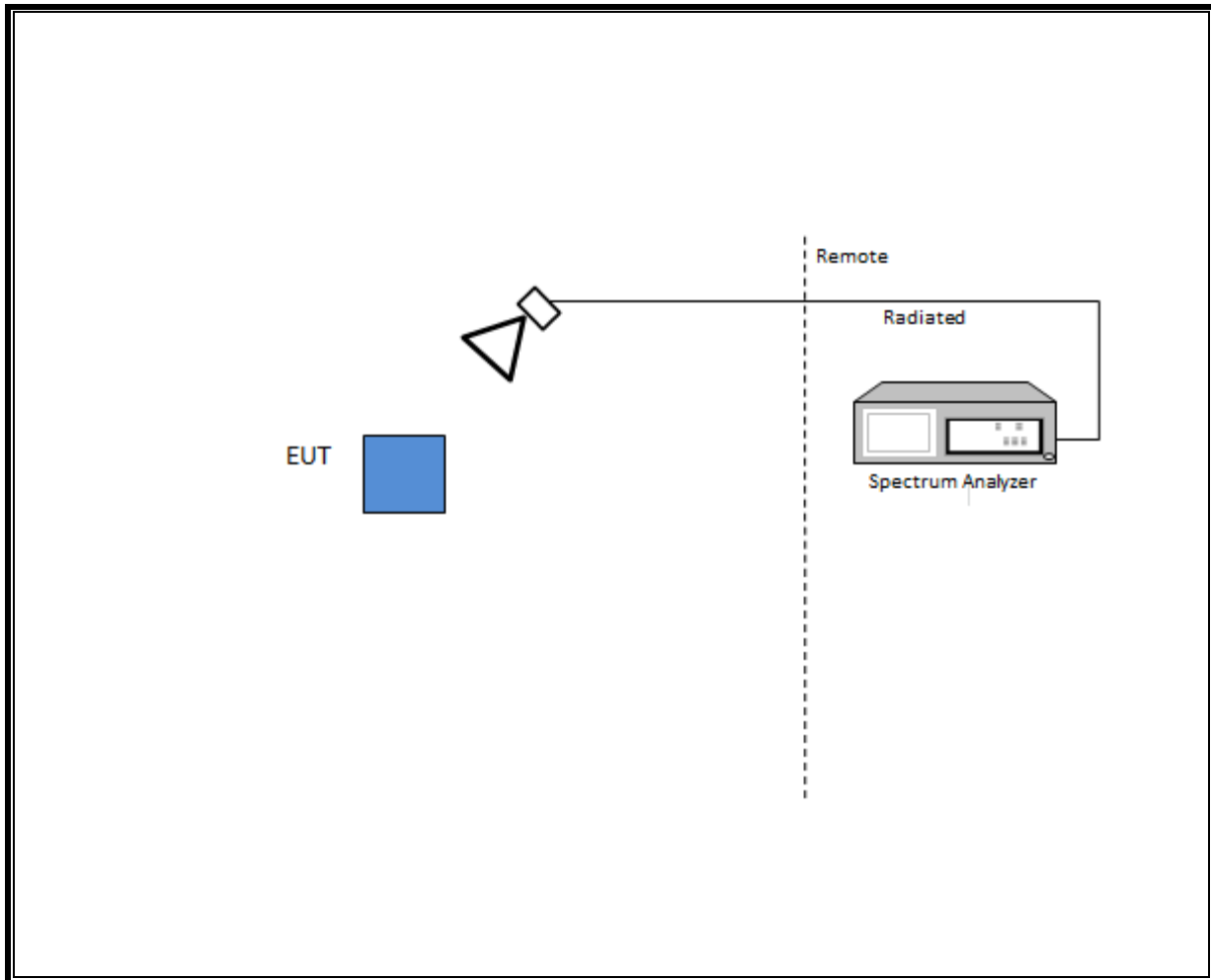

SETUP DIAGRAM 1 FOR LINE CONDUCTED TEST

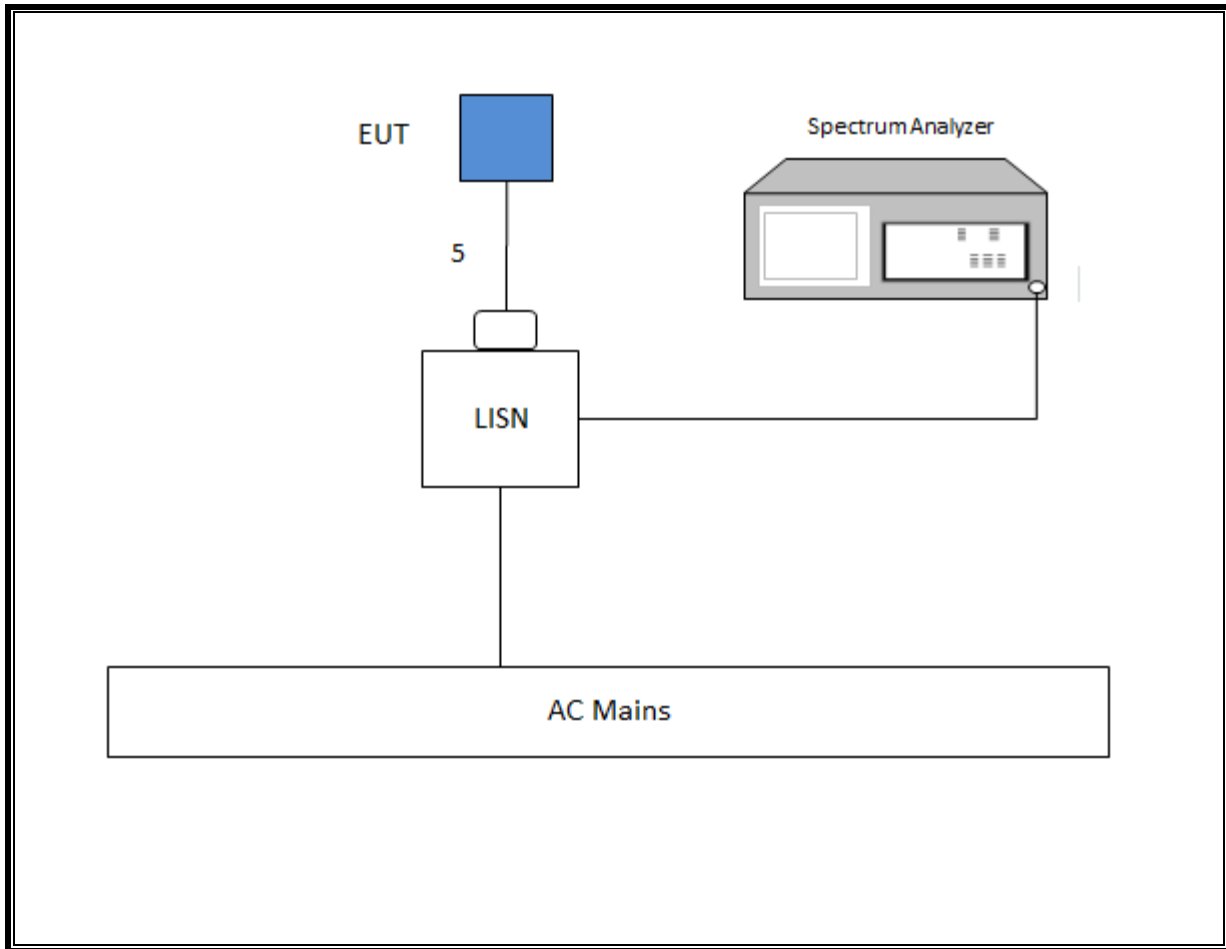

SETUP DIAGRAM 2 FOR LINE CONDUCTED TEST

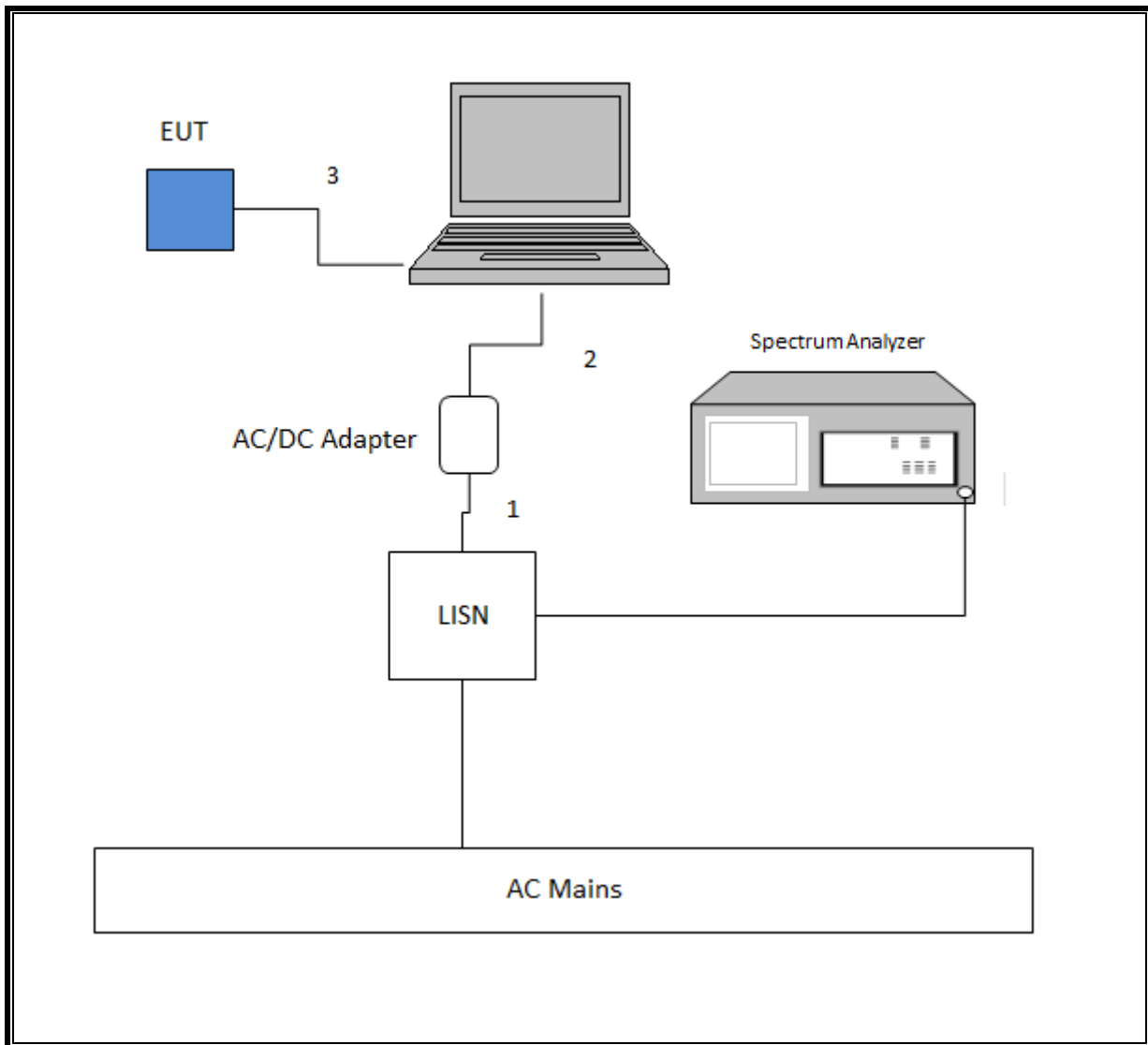

6. TEST AND MEASUREMENT EQUIPMENT

The following test and measurement equipment was utilized for the tests documented in this report:

Test Equipment List					
Description	Manufacturer	Model	T No.	Cal Date	Cal Due
Radiated Software	UL	UL EMC	Ver 9.5, June 24, 2015		
Conducted Software	UL	UL EMC	Ver 3.5		
Spectrum Analyzer, PXA, 3Hz to 44GHz	Keysight	N9030A	342	06/29/15	06/29/16
Spectrum Analyzer, PXA, 3Hz to 44GHz	Keysight	N9030A	905	06/16/15	05/26/16
Antenna, Horn 1-18GHz	ETS Lindgren	3117	862	04/10/15	04/10/16
Antenna, Broadband Hybrid, 30 to 2000MHz	Sunol Sciences	JB3	899	04/30/15	04/30/16
Filter, HPF, 3.0GHz	Micro-Tronics	HPM17543	898	04/25/15	04/25/16
Amplifier, 1-18GHz	Miteq	AFS42-00101800-25-S-42	491	04/25/15	04/25/16
Amplifier, 10kHz to 1GHz, 32dB	Sonoma	310N	834	06/08/15	06/08/16
Power Meter	Keysight	N1911A	1244	07/02/15	07/02/16
Power Sensor	Keysight	N1921A	1228	07/06/15	07/06/16
EMI Test Receiver 9KHz-7GHz	Rohde & Schwarz	ESCI7	212	08/07/15	08/07/16
LISN for Conducted Emission	FCC	50/250-25-2	114	01/16/15	01/16/16
Spectrum Analyzer, PXA, 3Hz to 44GHz	Keysight	N9030A	123	10/28/14	10/28/15

7. MEASUREMENT METHODS

6 dB BW: KDB 558074 D01 v03r03, Section 8.1.

Output Power: KDB 558074 D01 v03r03, Section 9.2.3.1.

Power Spectral Density: KDB 558074 D01 v03r03, Section 10.2.

Out-of-band emissions in non-restricted bands: KDB 558074 D01 v03r03, Section 11.0.

Out-of-band emissions in restricted bands: KDB 558074 D01 v03r03, Section 12.1.

Band-edge: KDB 558074 D01 v03r03, Section 12.1

8. ANTENNA PORT TEST RESULTS

8.1. ON TIME AND DUTY CYCLE

LIMITS

None; for reporting purposes only.

PROCEDURE

KDB 558074 Zero-Span Spectrum Analyzer Method.

ON TIME AND DUTY CYCLE RESULTS

Mode	ON Time B (msec)	Period (msec)	Duty Cycle x (linear)	Duty Cycle (%)	Duty Cycle Correction Factor (dB)	1/B Minimum VBW (kHz)
2.4GHz Band						
802.11b	8.624	8.717	0.989	98.93%	0.00	0.010
802.11g	1.425	1.529	0.932	93.20%	0.31	0.702
802.11n HT20	1.336	1.439	0.928	92.84%	0.32	0.749

DUTY CYCLE PLOTS

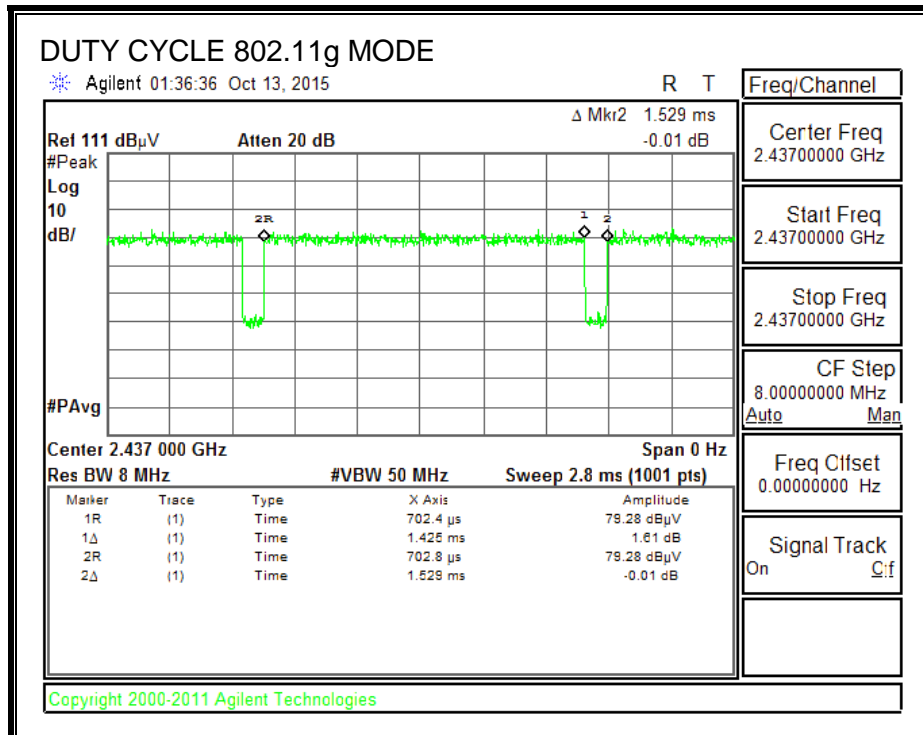
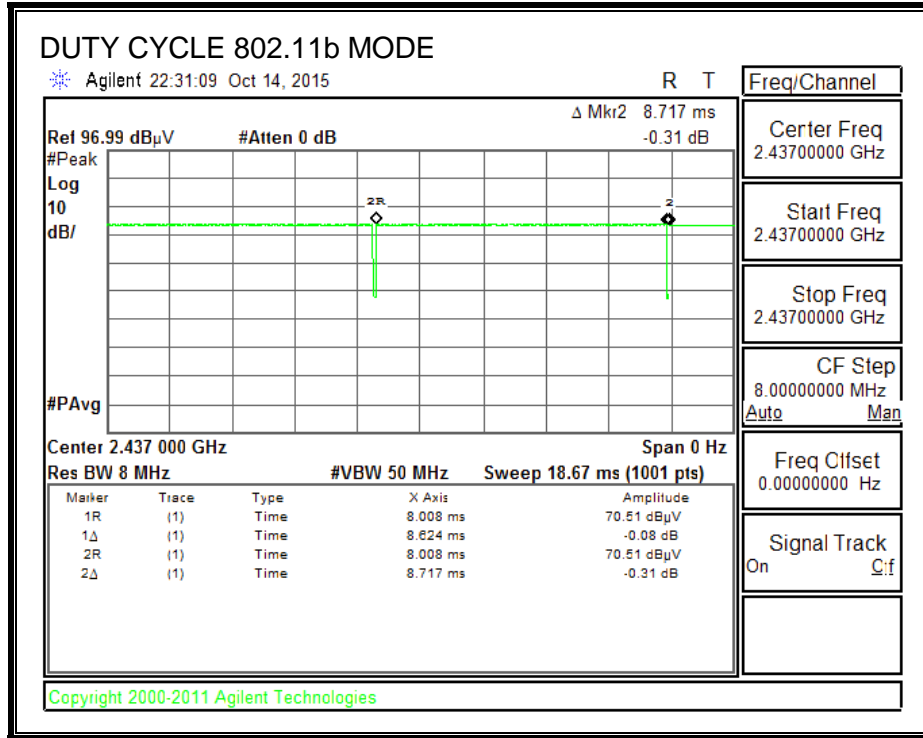

8.2. 802.11b MODE IN THE 2.4 GHz BAND

8.2.1. 6 dB BANDWIDTH

LIMITS

FCC §15.247 (a) (2)

IC RSS-247 (5.2) (1)

The minimum 6 dB bandwidth shall be at least 500 kHz.

RESULTS

Channel	Frequency (MHz)	6 dB Bandwidth (MHz)	Minimum Limit (MHz)
Low	2412	9.044	0.5
Mid	2437	8.580	0.5
High	2462	9.030	0.5
13	2472	8.541	0.5

6 dB BANDWIDTH

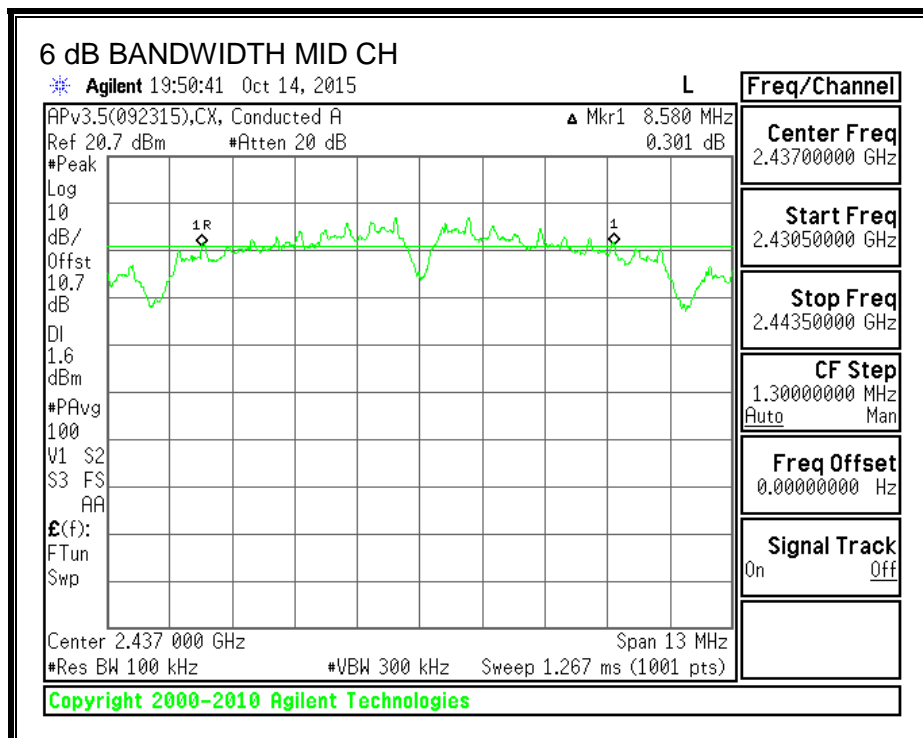
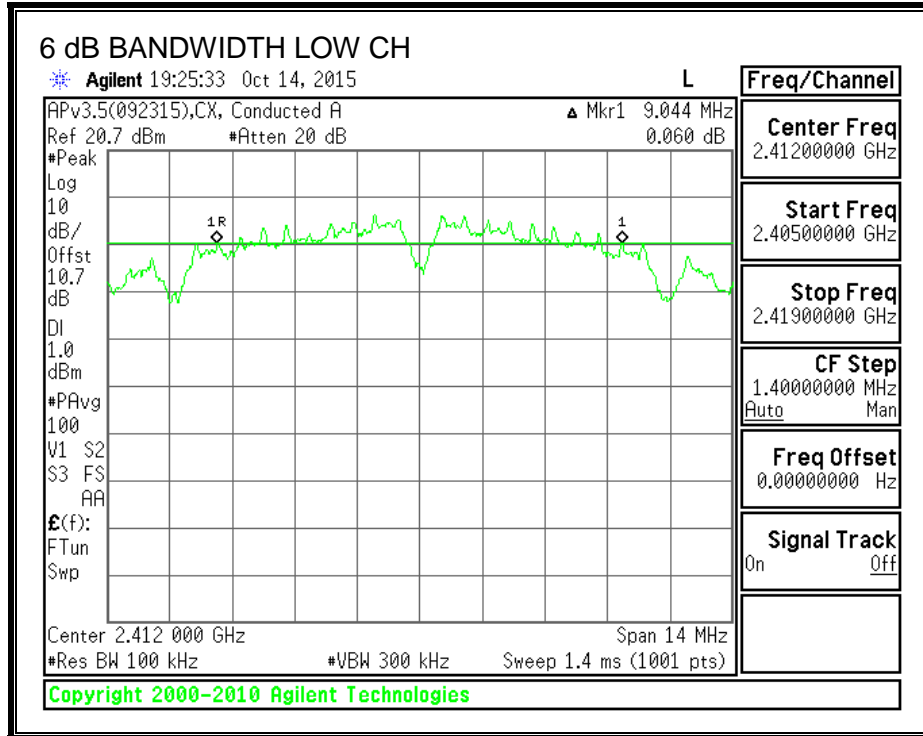

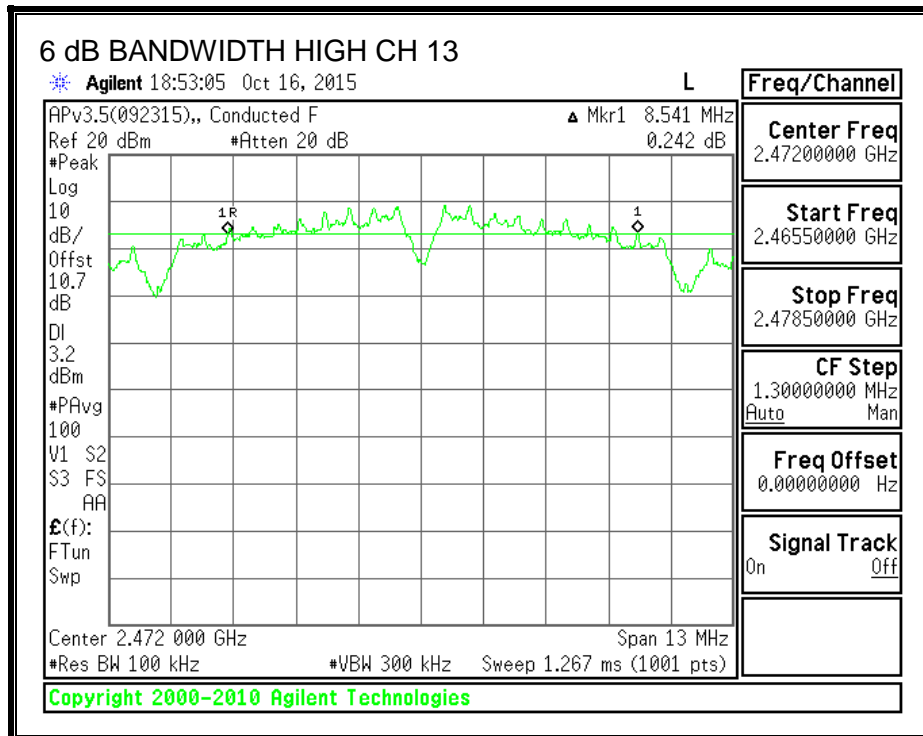
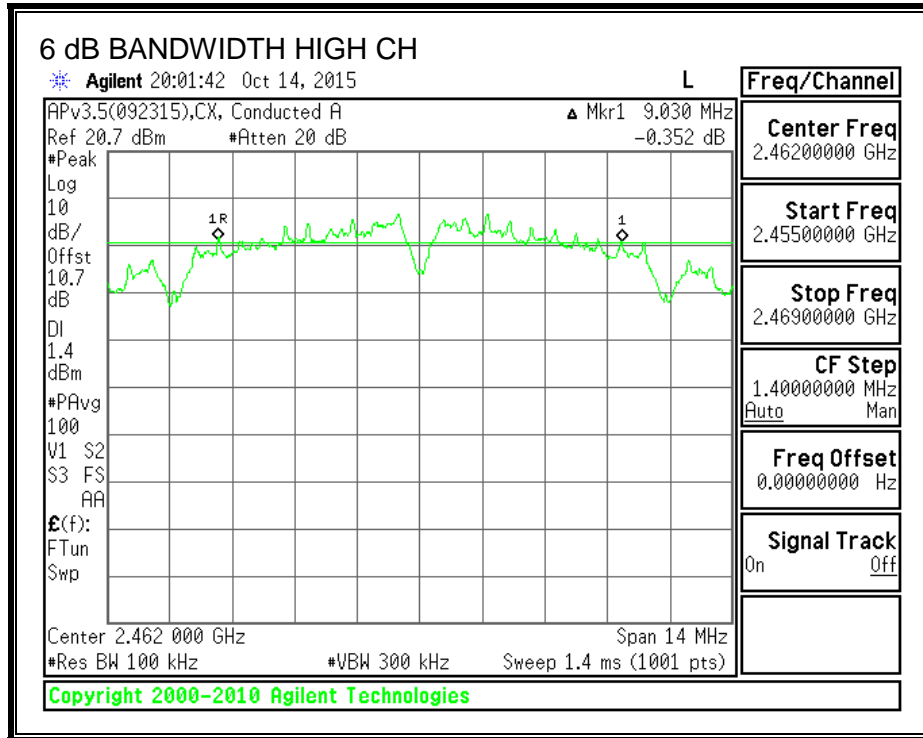

8.2.2. 99% BANDWIDTH

LIMITS

None; for reporting purposes only.

RESULTS

Channel	Frequency (MHz)	99% Bandwidth (MHz)
Low	2412	13.920
Mid	2437	13.944
High	2462	13.882
13	2472	13.909

99% BANDWIDTH

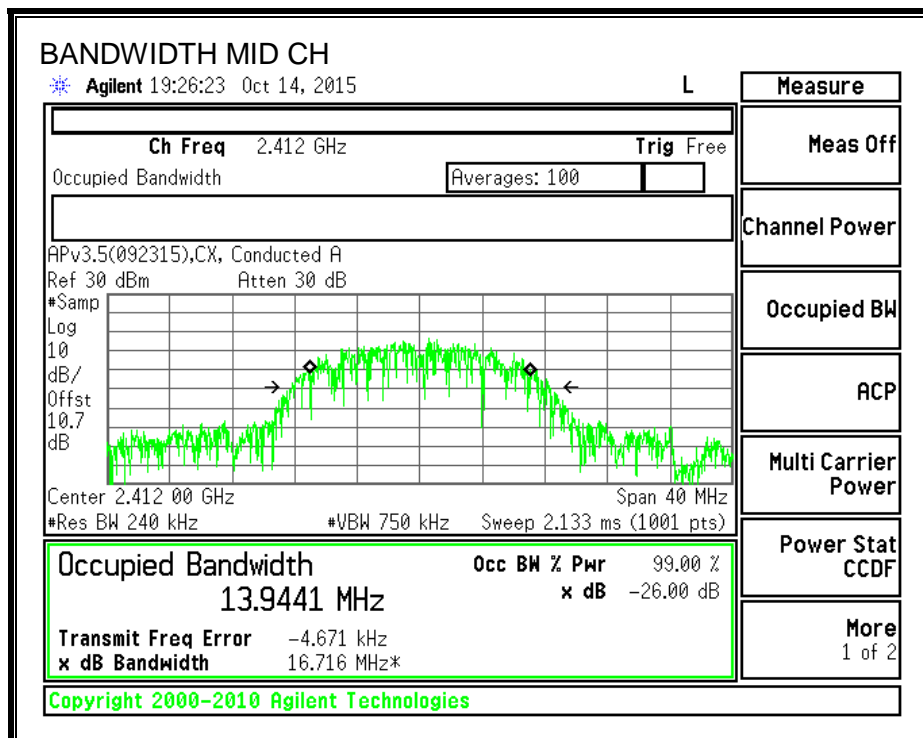
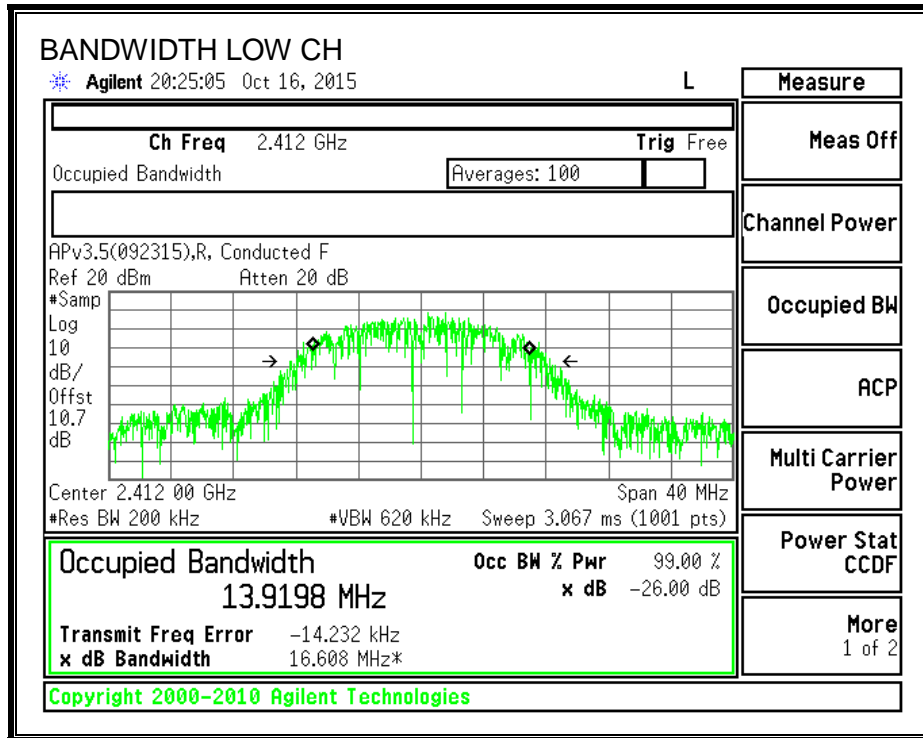

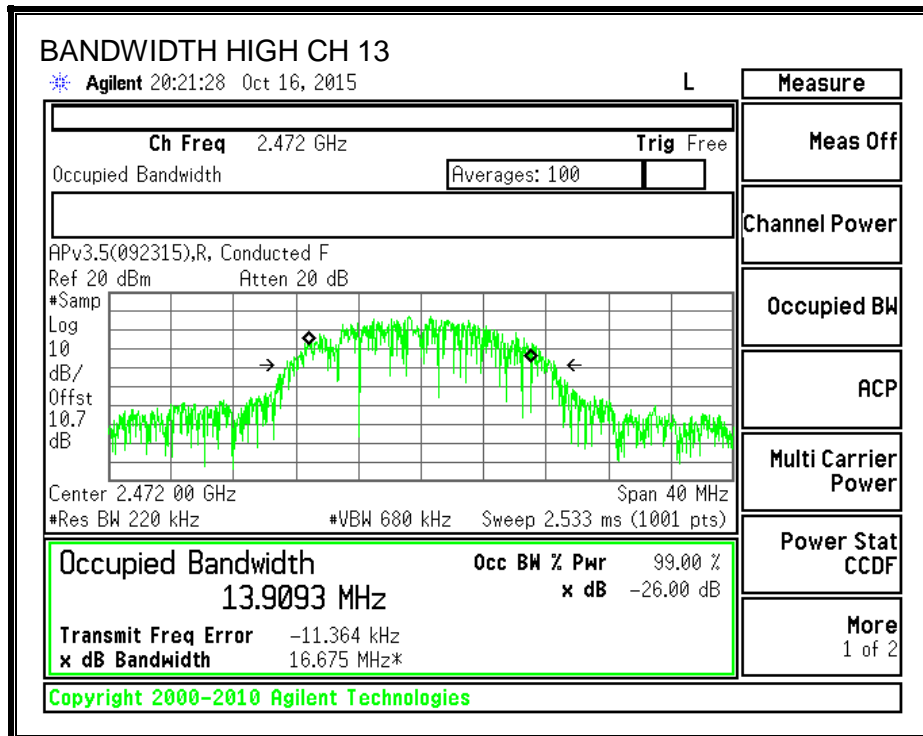
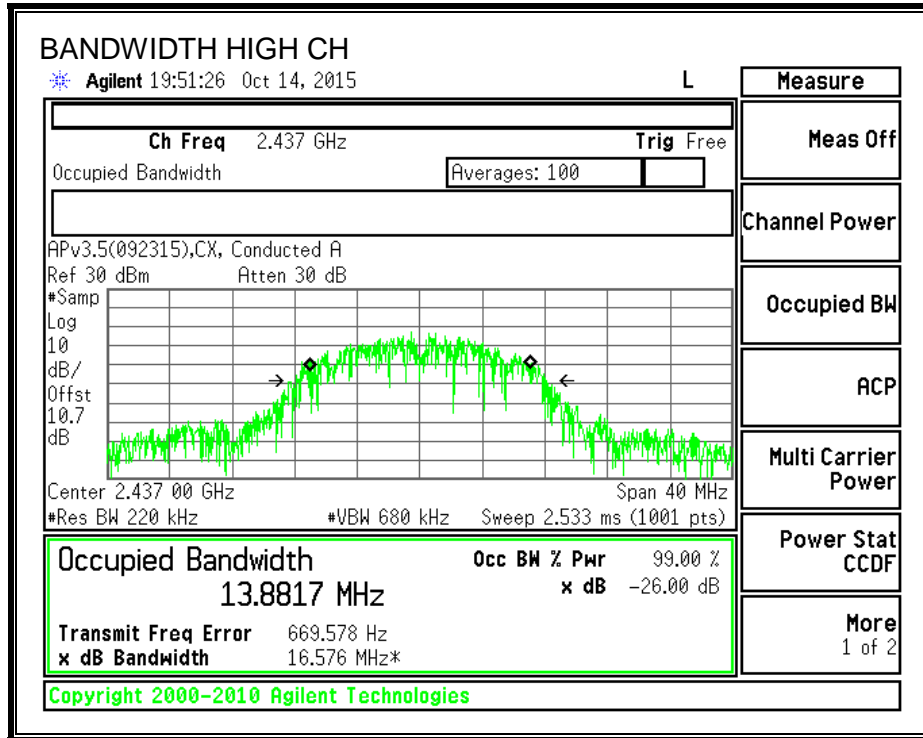

8.2.3. OUTPUT POWER

LIMITS

FCC §15.247

IC RSS-247 (5.4) (4)

For systems using digital modulation in the 902–928 MHz, 2400–2483.5 MHz, and 5725–5850 MHz bands: 1 Watt, based on the use of antennas with directional gains that do not exceed 6 dBi. If transmitting antennas of directional gain greater than 6 dBi are used, the conducted output power from the intentional radiator shall be reduced by the amount in dB that the directional gain of the antenna exceeds 6 dBi.

DIRECTIONAL ANTENNA GAIN

There is only one transmitter output therefore the directional gain is equal to the antenna gain.

RESULTS

Limits

Channel	Frequency (MHz)	Directional Gain (dBi)	FCC Power Limit (dBm)	IC Power Limit (dBm)	IC EIRP Limit (dBm)	Max Power (dBm)
Low	2412	-0.84	30.00	30	36	30.00
Mid	2437	-0.84	30.00	30	36	30.00
High	2462	-0.84	30.00	30	36	30.00
13	2472	-0.84	30.00	30	36	30.00

Duty Cycle CF (dB)	0.00	Included in Calculations of Corr'd Power
---------------------------	------	---

Results

Channel	Frequency (MHz)	Meas Power (dBm)	Total Corr'd Power (dBm)	Power Limit (dBm)	Margin (dB)
Low	2412	15.70	15.70	30.00	-14.30
Mid	2437	15.60	15.60	30.00	-14.40
High	2462	15.60	15.60	30.00	-14.40
13	2472	15.60	15.60	30.00	-14.40

8.2.4. POWER SPECTRAL DENSITY

LIMITS

FCC §15.247

IC RSS-247 (5.2) (2)

For digitally modulated systems, the power spectral density conducted from the intentional radiator to the antenna shall not be greater than 8 dBm in any 3 KHz band during any time interval of continuous transmissions.

RESULTS

Duty Cycle CF (dB)	0.00	Included in Calculations of Corr'd PSD
---------------------------	------	---

PSD Results

Channel	Frequency (MHz)	Meas PSD (dBm)	Total Corr'd PSD (dBm)	Limit (dBm)	Margin (dB)
Low	2412	-5.78	-5.78	8.0	-13.8
Mid	2437	-5.77	-5.77	8.0	-13.8
High	2462	-5.77	-5.77	8.0	-13.8
13	2472	-4.18	-4.18	8.0	-12.2

PSD

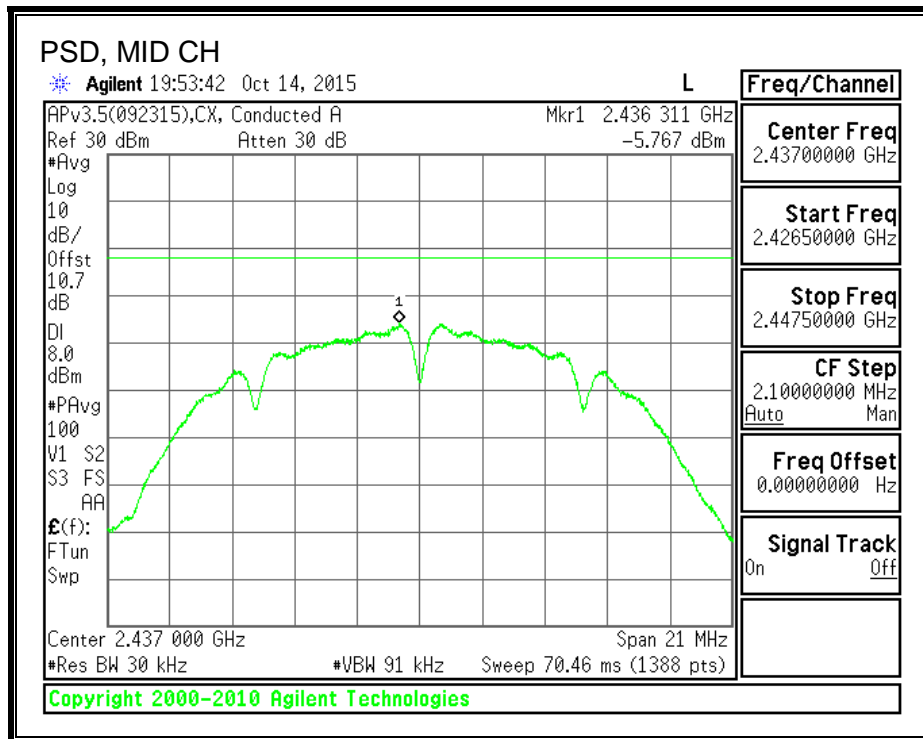
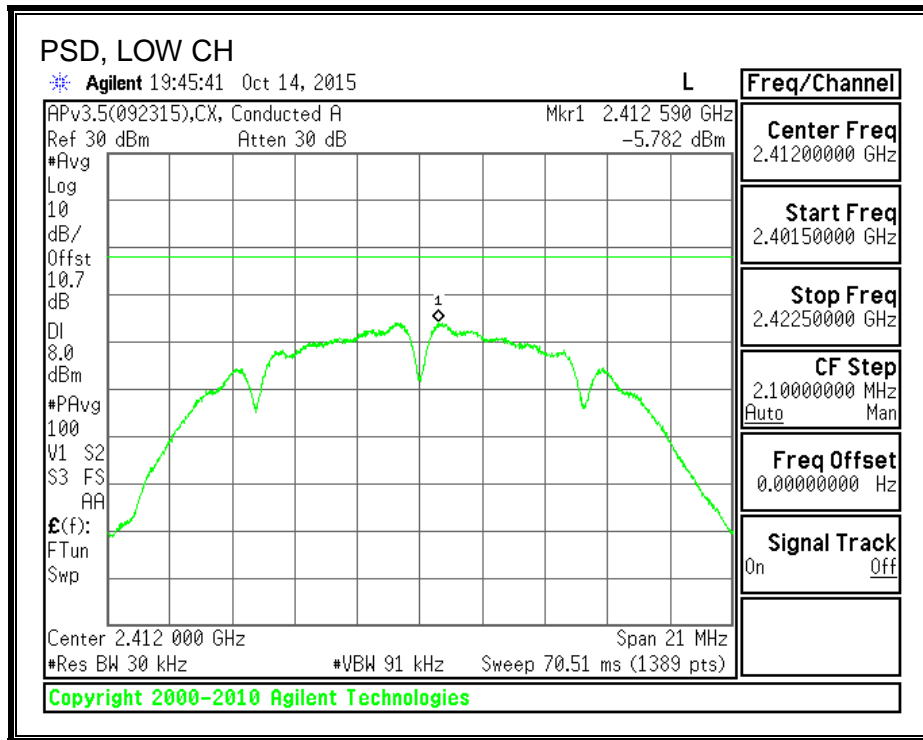

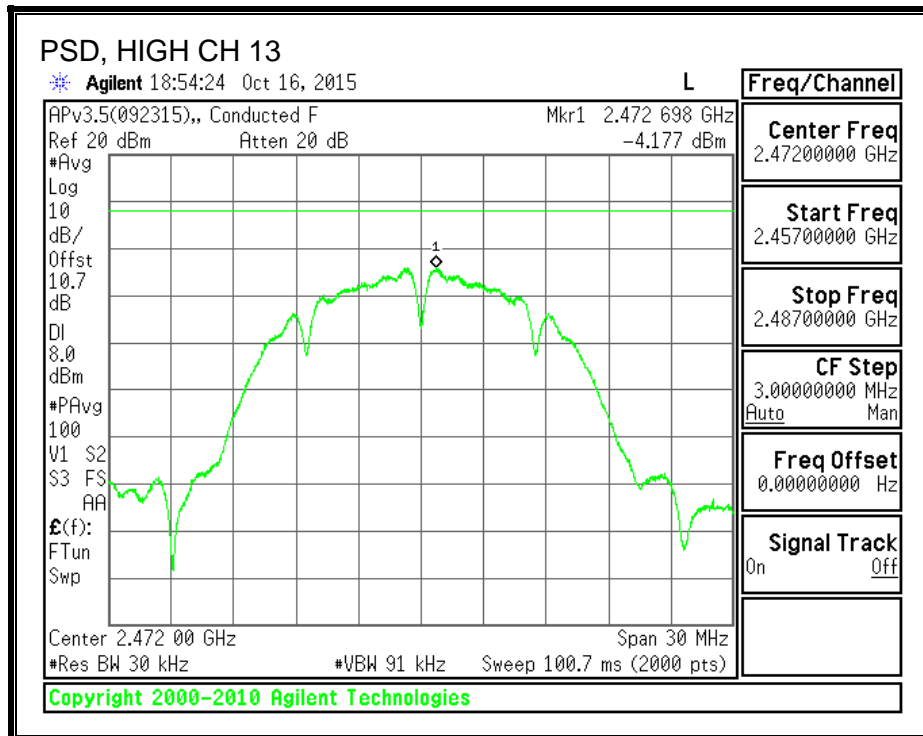
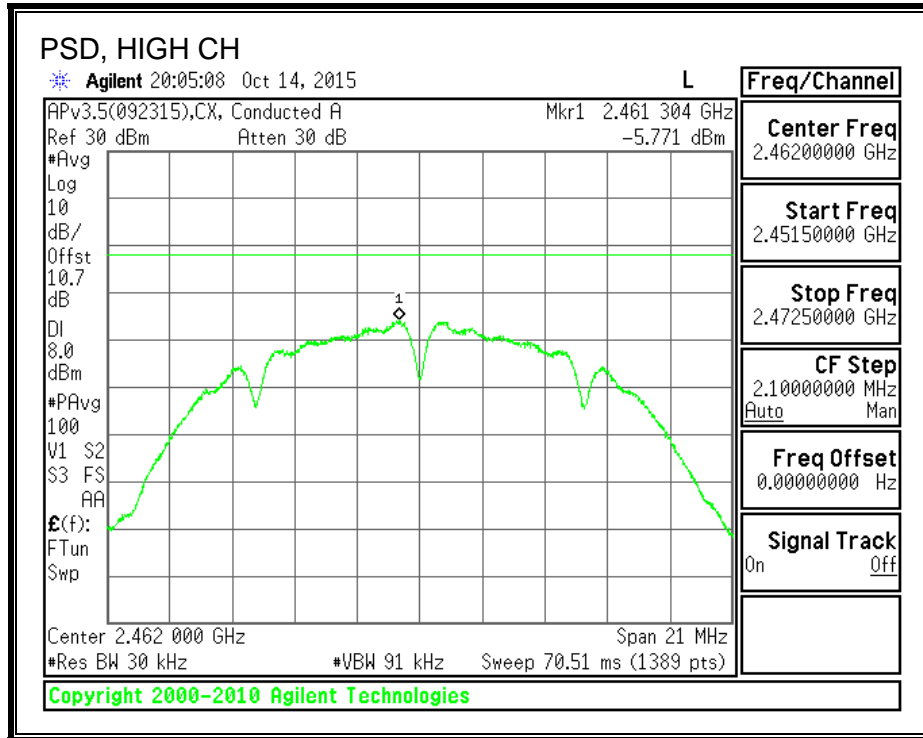

8.2.5. OUT-OF-BAND EMISSIONS

LIMITS

FCC §15.247 (d)

IC RSS-247 (5.5)

In any 100 kHz bandwidth outside the frequency band in which the spread spectrum or digitally modulated intentional radiator is operating, the radio frequency power that is produced by the intentional radiator shall be at least 20 dB below that in the 100 kHz bandwidth within the band that contains the highest level of the desired power, based on either an RF conducted or a radiated measurement, provided the transmitter demonstrates compliance with the peak conducted power limits. If the transmitter complies with the conducted power limits based on the use of RMS averaging over a time interval, as permitted under paragraph (b)(3) of this section, the attenuation required under this paragraph shall be 30 dB instead of 20 dB. Attenuation below the general limits specified in §15.209(a) is not required.

RESULTS

IN-BAND REFERENCE LEVEL

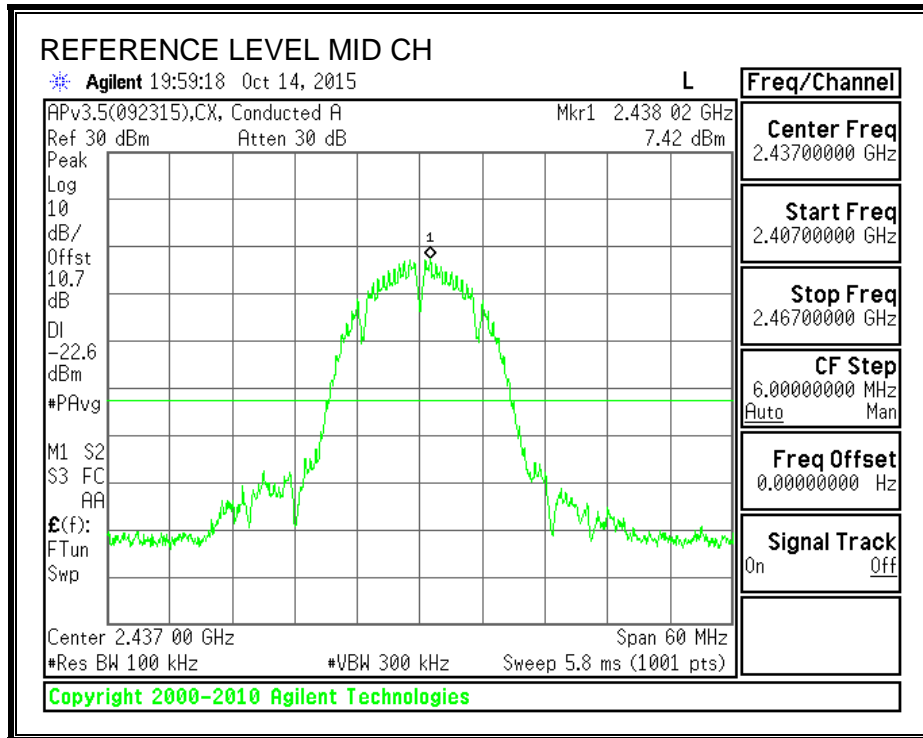

LOW CHANNEL BANDEDGE

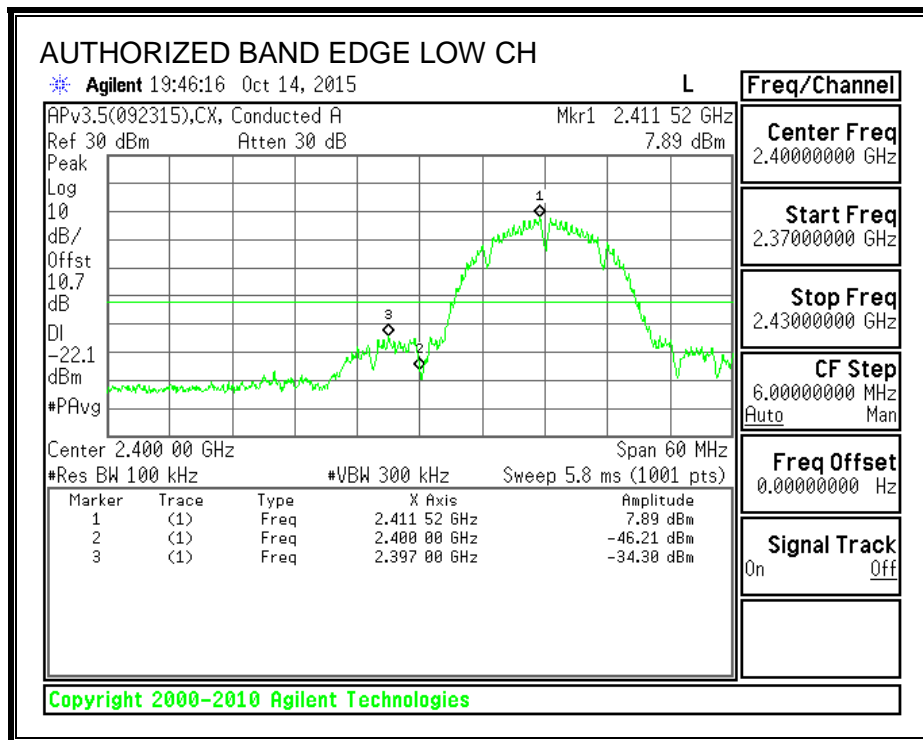

HIGH CHANNEL BANDEDGE

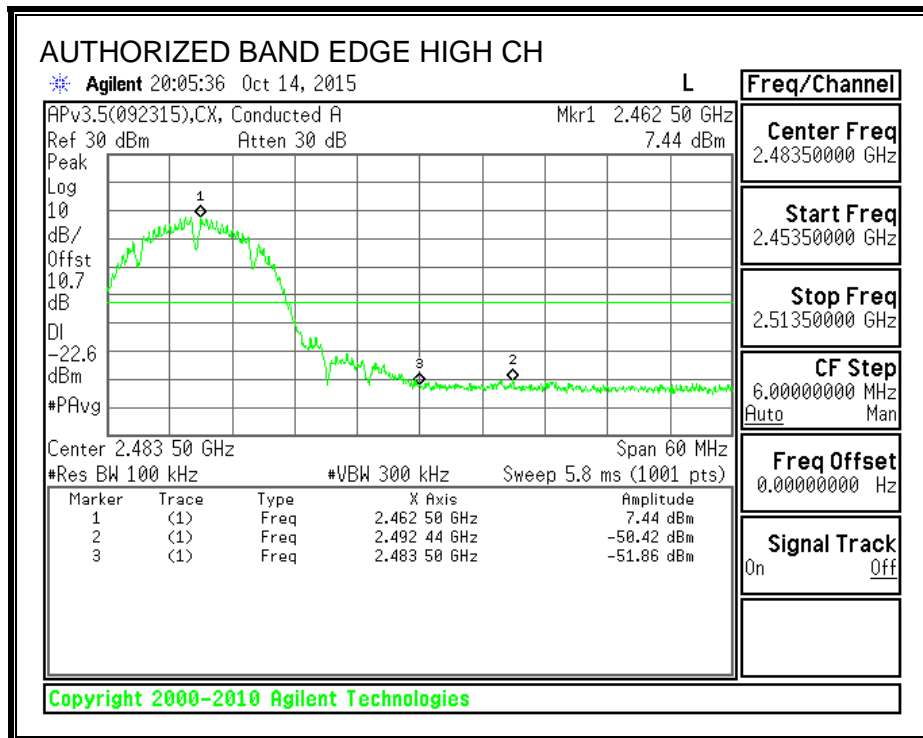

CHANNEL 13 BANDEDGE

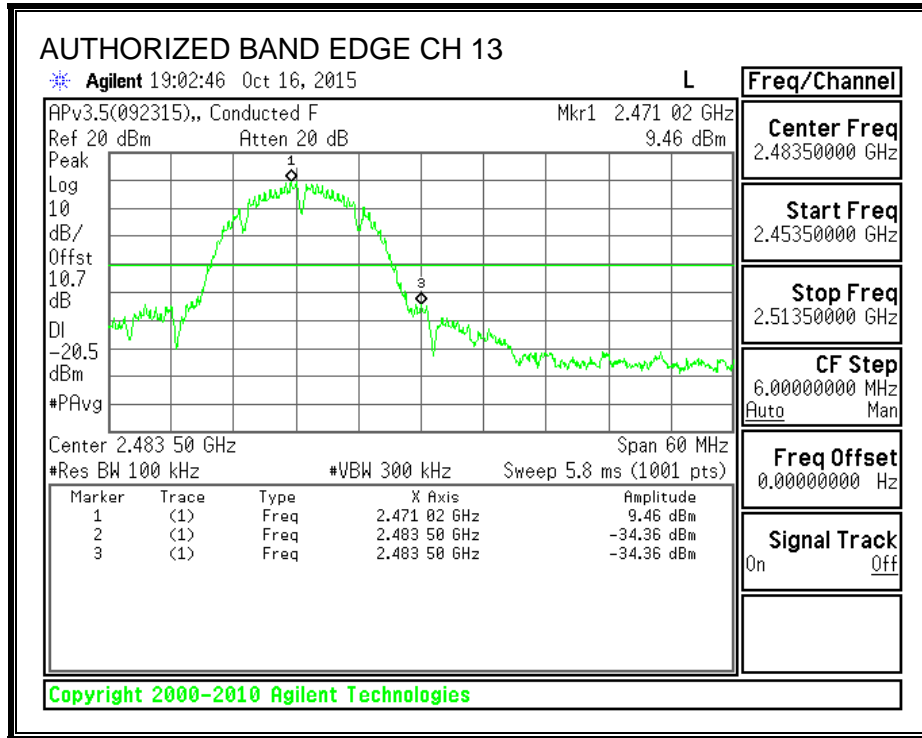

OUT-OF-BAND EMISSIONS

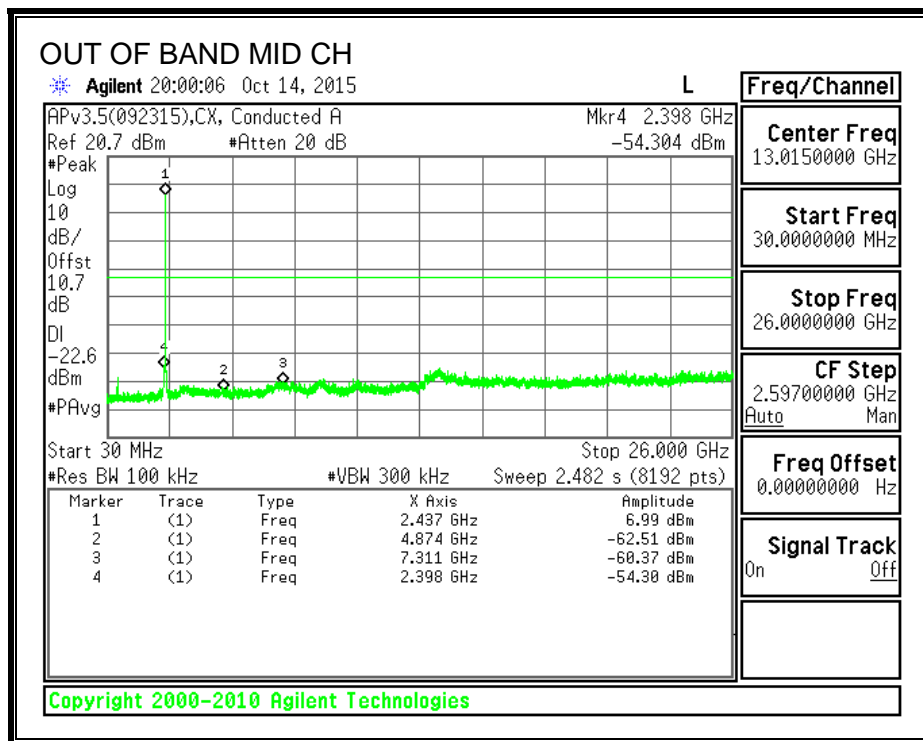
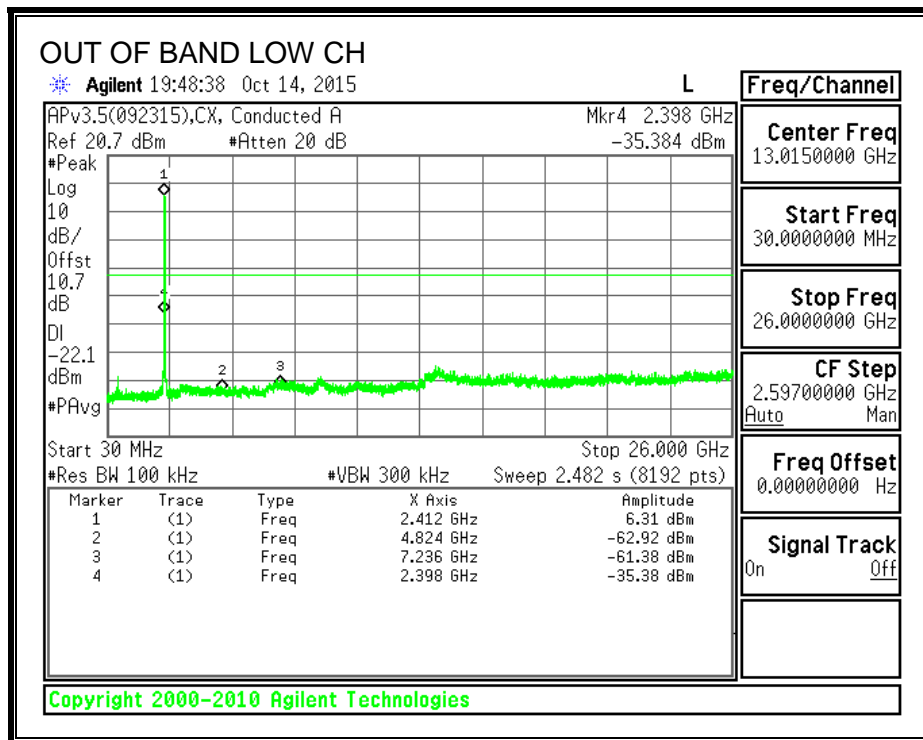

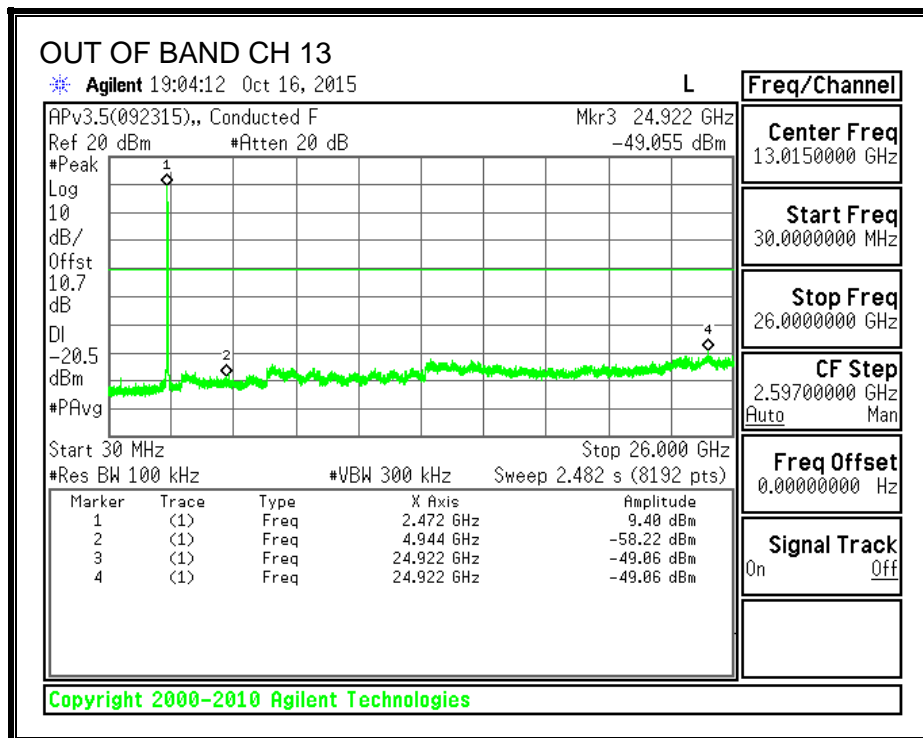
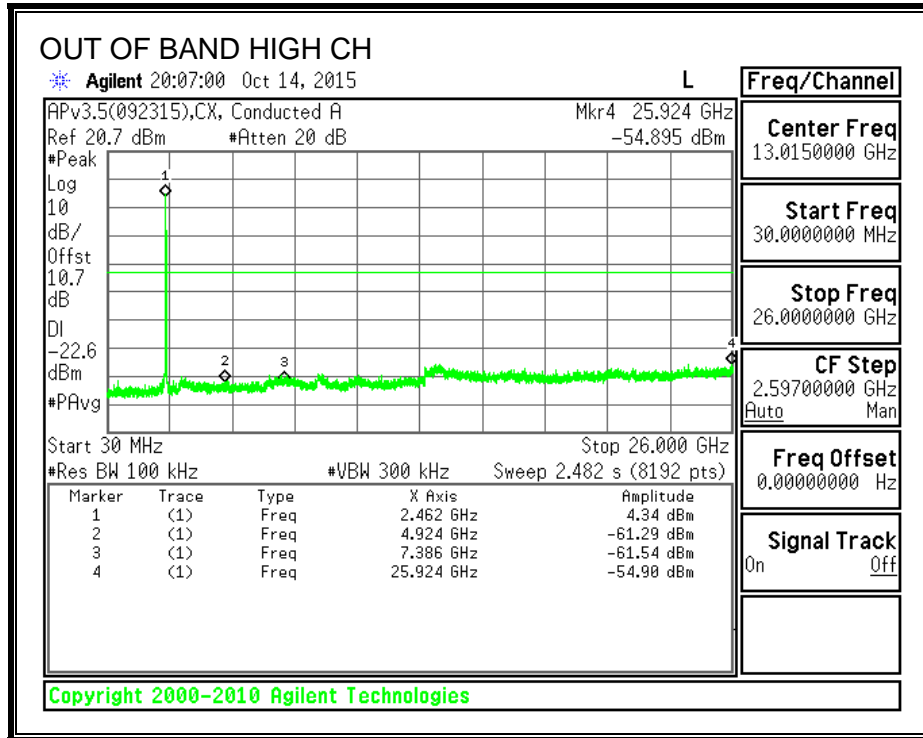

8.3. 802.11g MODE IN THE 2.4 GHz BAND

8.3.1. 6 dB BANDWIDTH

LIMITS

FCC §15.247 (a) (2)

IC RSS-247 (5.2) (1)

The minimum 6 dB bandwidth shall be at least 500 kHz.

RESULTS

Channel	Frequency (MHz)	6 dB Bandwidth (MHz)	Minimum Limit (MHz)
Low	2412	15.134	0.5
Mid	2437	14.476	0.5
High	2462	15.120	0.5
12	2467	15.065	0.5
13	2472	14.454	0.5

6 dB BANDWIDTH

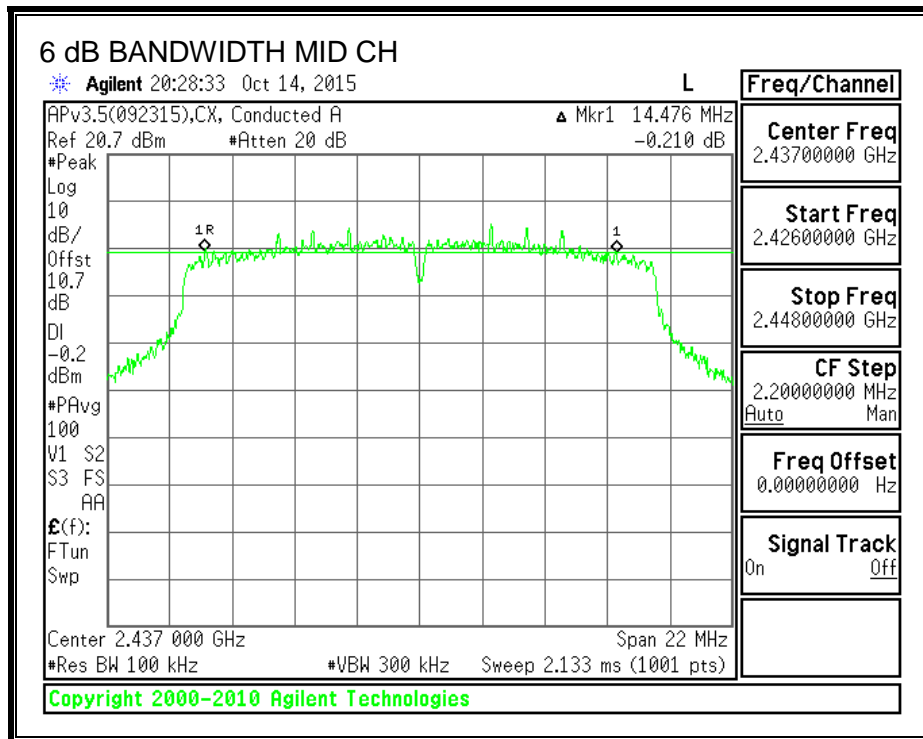
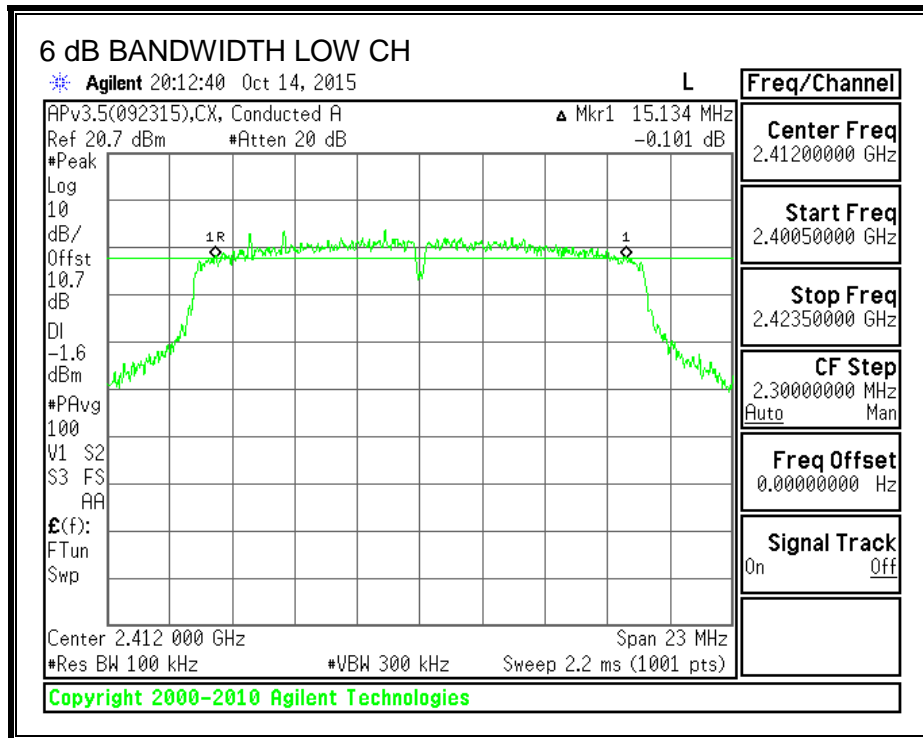

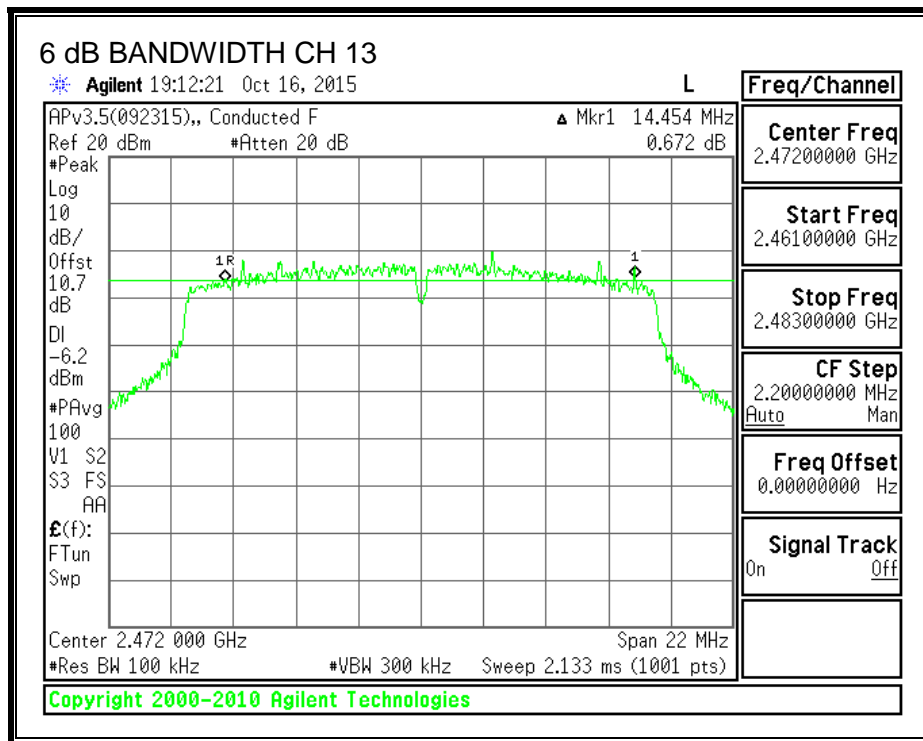

8.3.2. 99% BANDWIDTH

LIMITS

None; for reporting purposes only.

RESULTS

Channel	Frequency (MHz)	99% Bandwidth (MHz)
Low	2412	16.028
Mid	2437	16.184
High	2462	16.132
12	2467	16.071
13	2472	16.089

99% BANDWIDTH

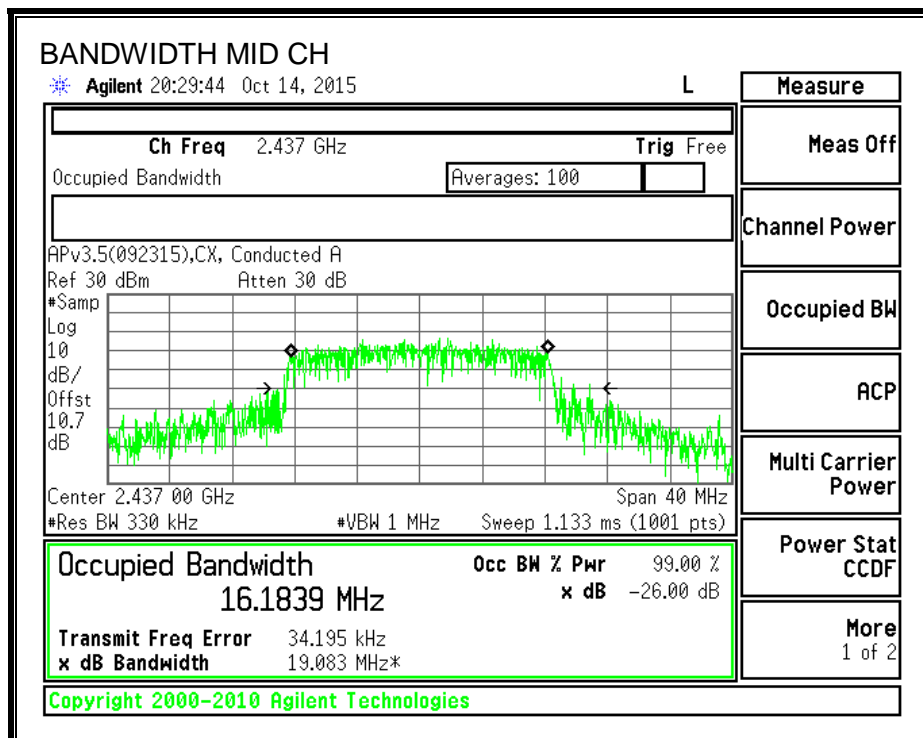
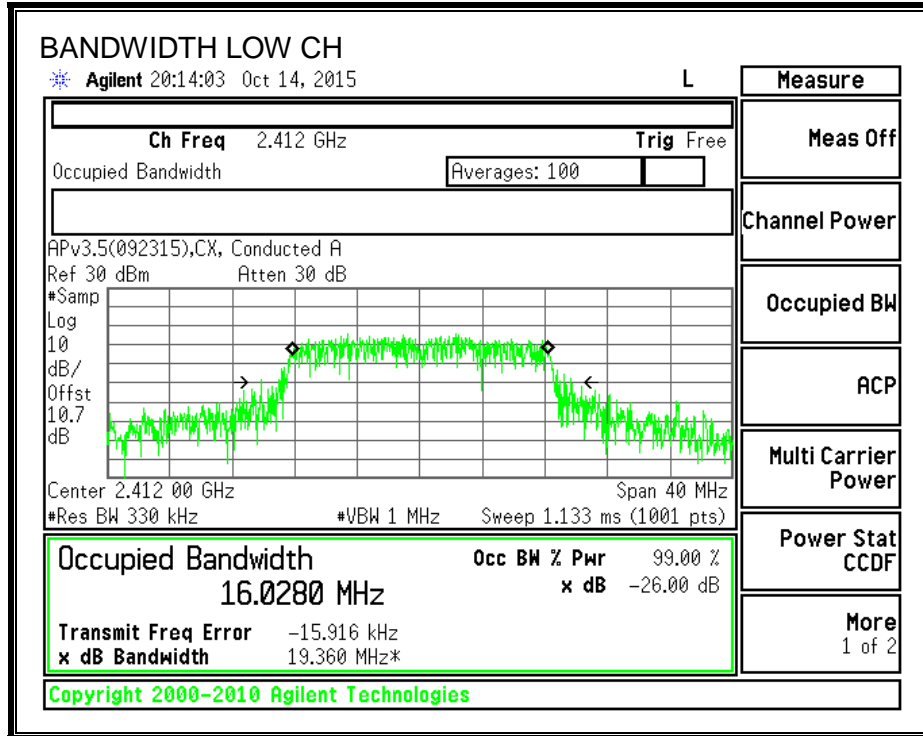

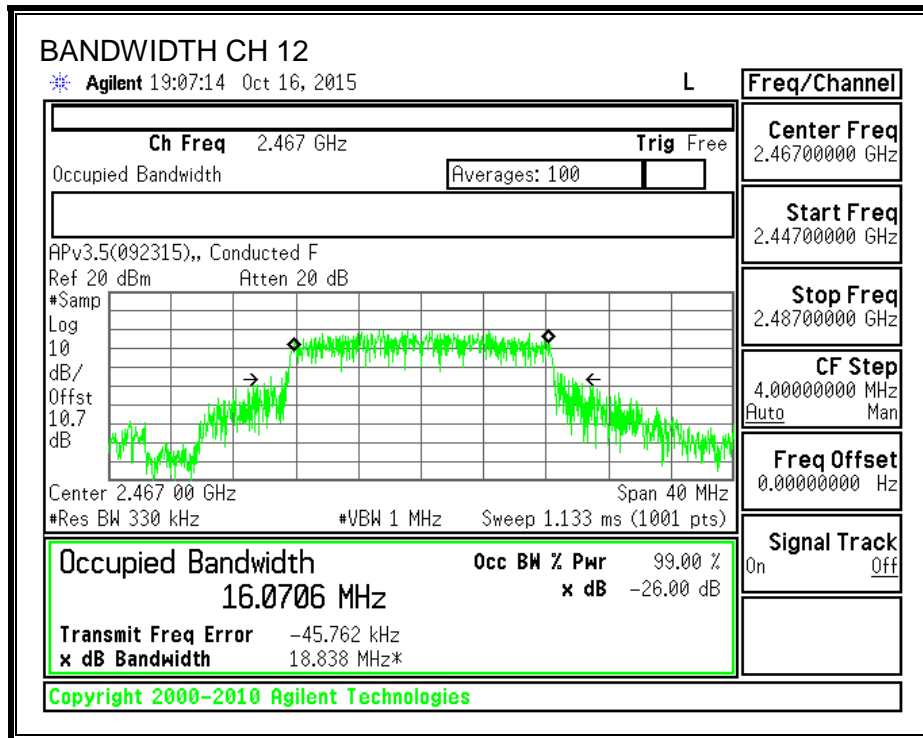
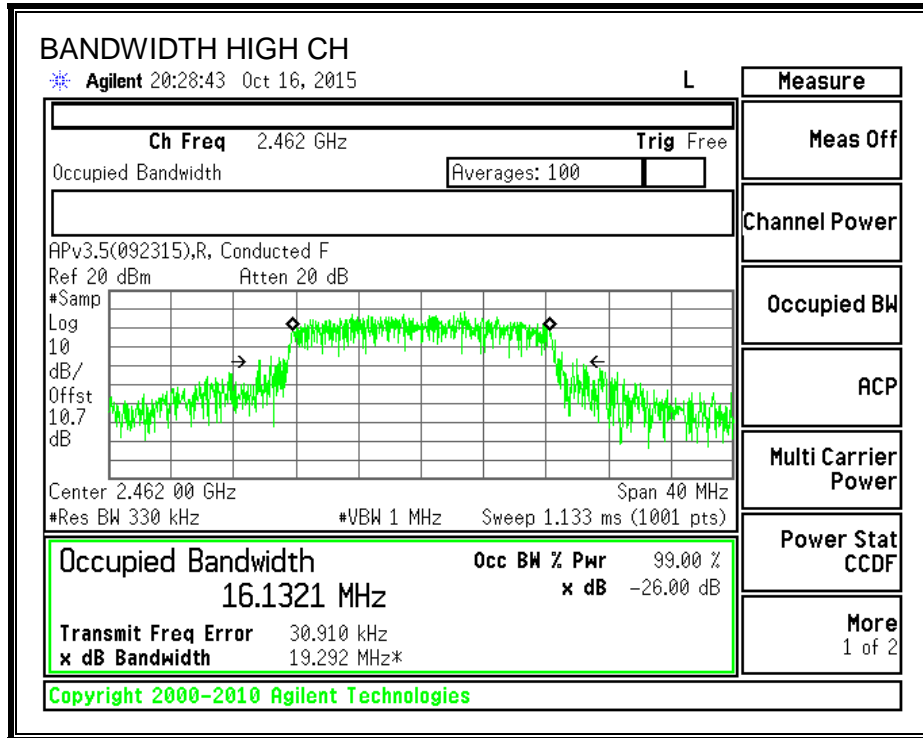

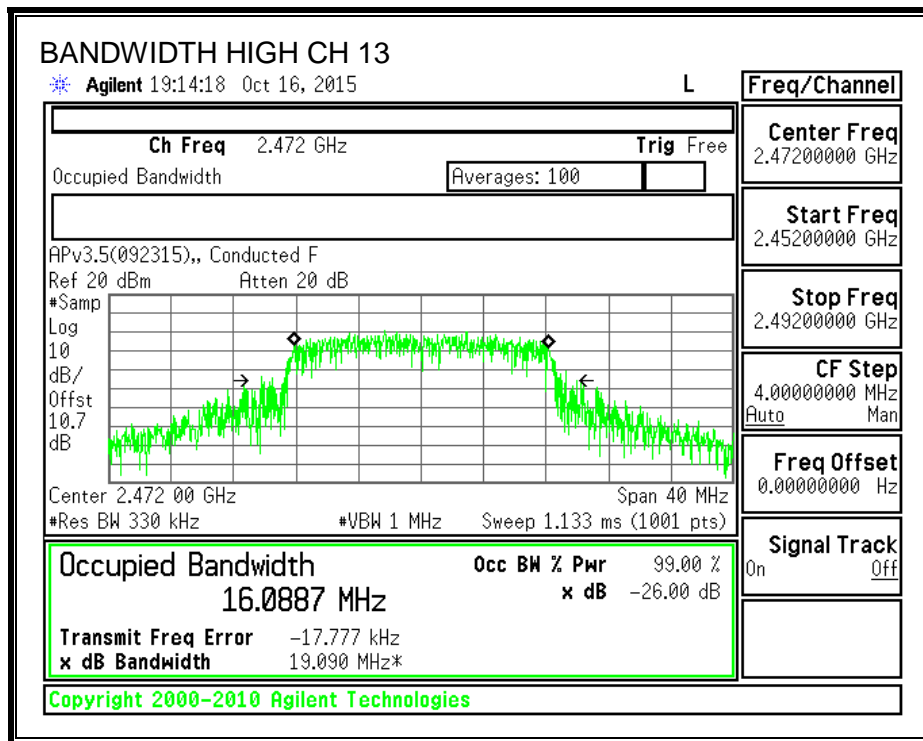

8.3.3. OUTPUT POWER

LIMITS

FCC §15.247

IC RSS-247 (5.4) (4)

For systems using digital modulation in the 2400–2483.5 MHz, and 5725–5850 MHz bands: 1 Watt, based on the use of antennas with directional gains that do not exceed 6 dBi. If transmitting antennas of directional gain greater than 6 dBi are used, the conducted output power from the intentional radiator shall be reduced by the amount in dB that the directional gain of the antenna exceeds 6 dBi.

DIRECTIONAL ANTENNA GAIN

There is only one transmitter output therefore the directional gain is equal to the antenna gain.

RESULTS

Limits

Channel	Frequency (MHz)	Directional Gain (dBi)	FCC Power Limit (dBm)	IC Power Limit (dBm)	IC EIRP Limit (dBm)	Max Power (dBm)
Low	2412	-0.84	30.00	30	36	30.00
Mid	2437	-0.84	30.00	30	36	30.00
High	2462	-0.84	30.00	30	36	30.00
12	2467	-0.84	30.00	30	36	30.00
13	2472	-0.84	30.00	30	36	30.00

Duty Cycle CF (dB)	0.31	Included in Calculations of Corr'd Power
--------------------	------	--

Results

Channel	Frequency (MHz)	Meas Power (dBm)	Total Corr'd Power (dBm)	Power Limit (dBm)	Margin (dB)
Low	2412	16.20	16.51	30.00	-13.49
Mid	2437	16.20	16.51	30.00	-13.49
High	2462	16.20	16.51	30.00	-13.49
12	2467	8.60	8.91	30.00	-21.09
13	2472	8.60	8.91	30.00	-21.09

8.3.4. POWER SPECTRAL DENSITY

LIMITS

FCC §15.247

IC RSS-247 (5.2) (2)

For digitally modulated systems, the power spectral density conducted from the intentional radiator to the antenna shall not be greater than 8 dBm in any 3 KHz band during any time interval of continuous transmissions

RESULTS

Duty Cycle CF (dB)	0.31	Included in Calculations of Corr'd PSD
---------------------------	------	---

PSD Results

Channel	Frequency (MHz)	Meas PSD (dBm)	Total Corr'd PSD (dBm)	Limit (dBm)	Margin (dB)
Low	2412	-8.15	-7.84	8.0	-15.8
Mid	2437	-7.75	-7.44	8.0	-15.4
High	2462	-7.85	-7.54	8.0	-15.5
12	2467	-13.51	-13.20	8.0	-21.2
13	2472	-13.60	-13.29	8.0	-21.3

PSD

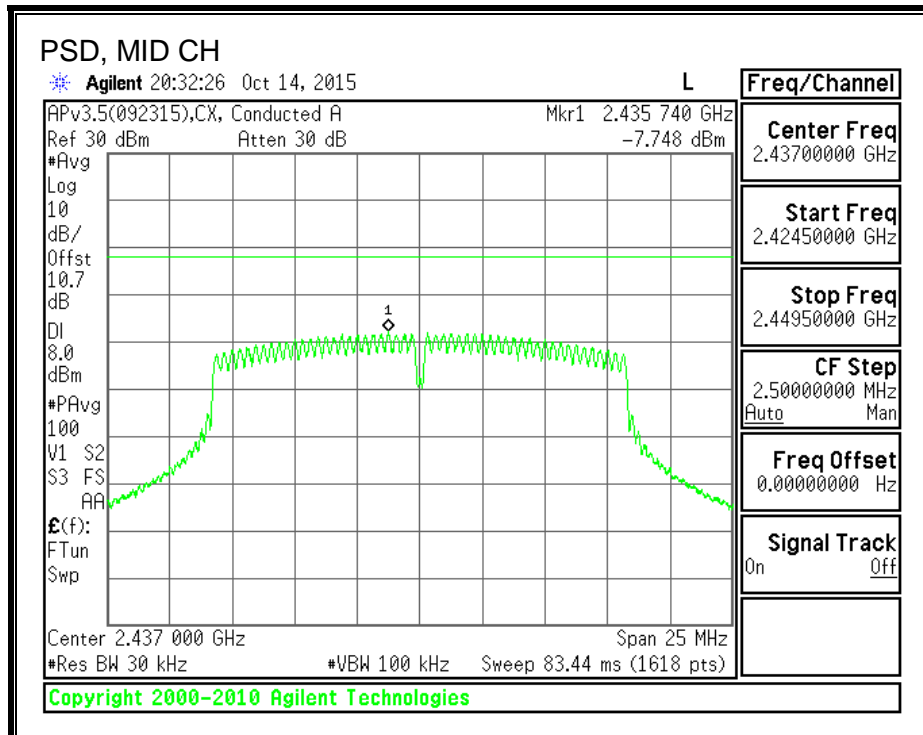
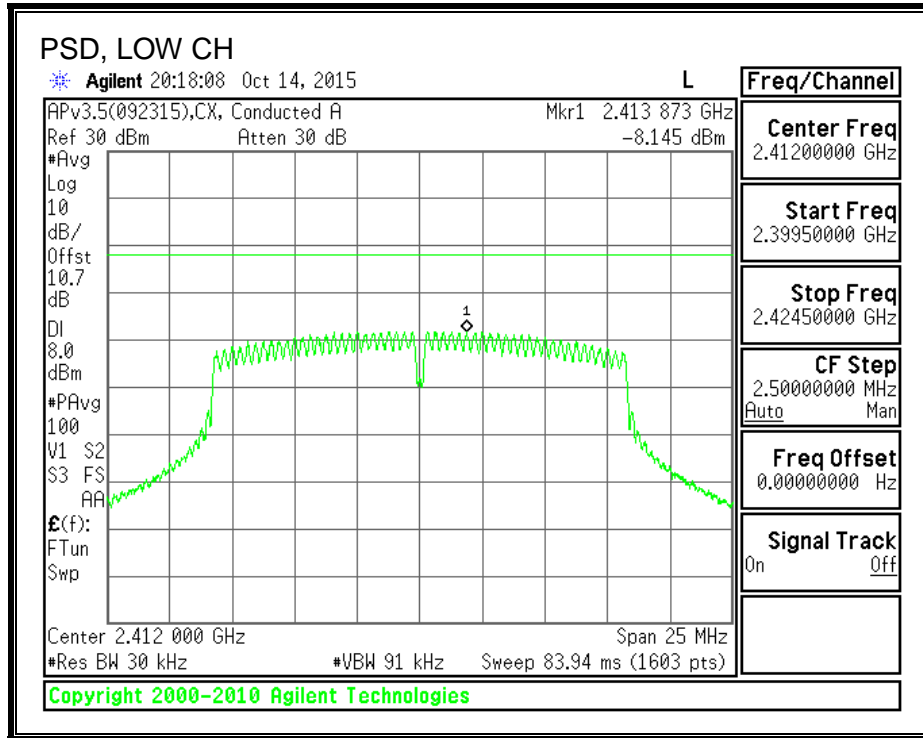

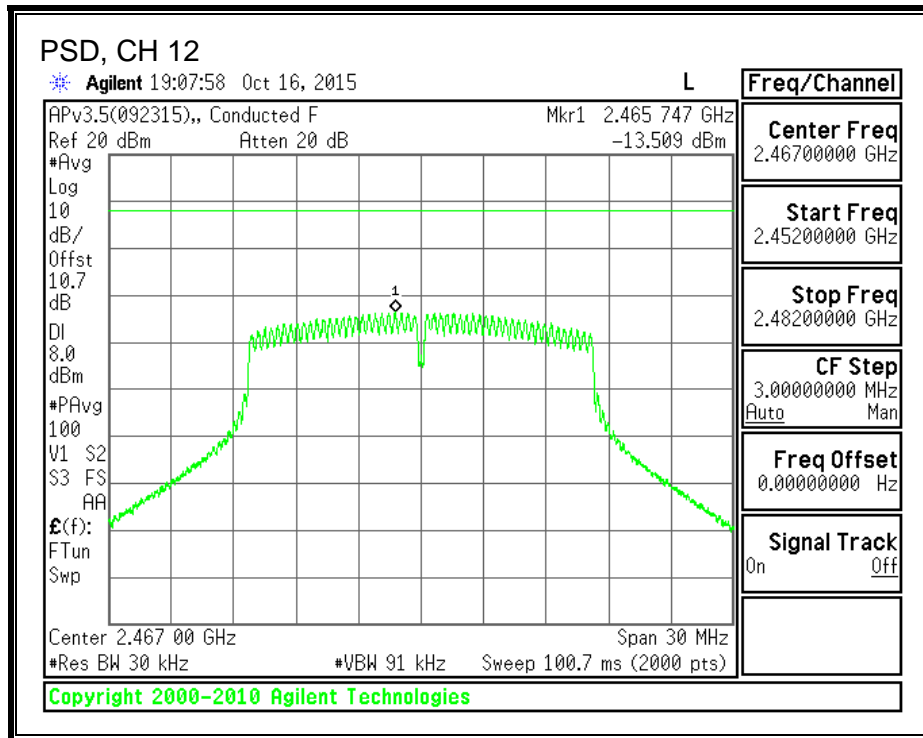
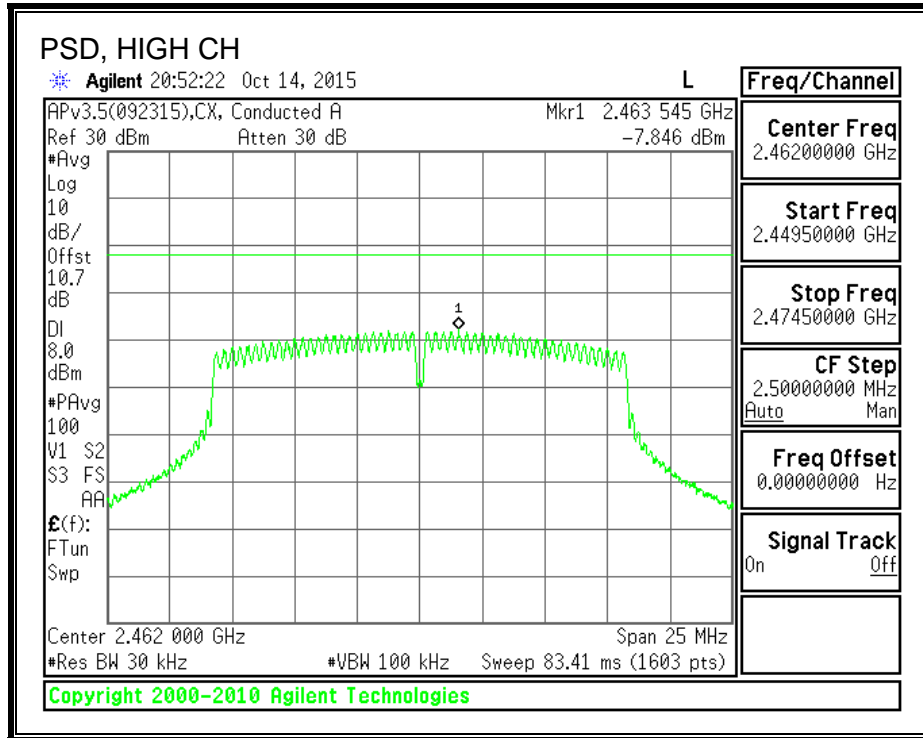

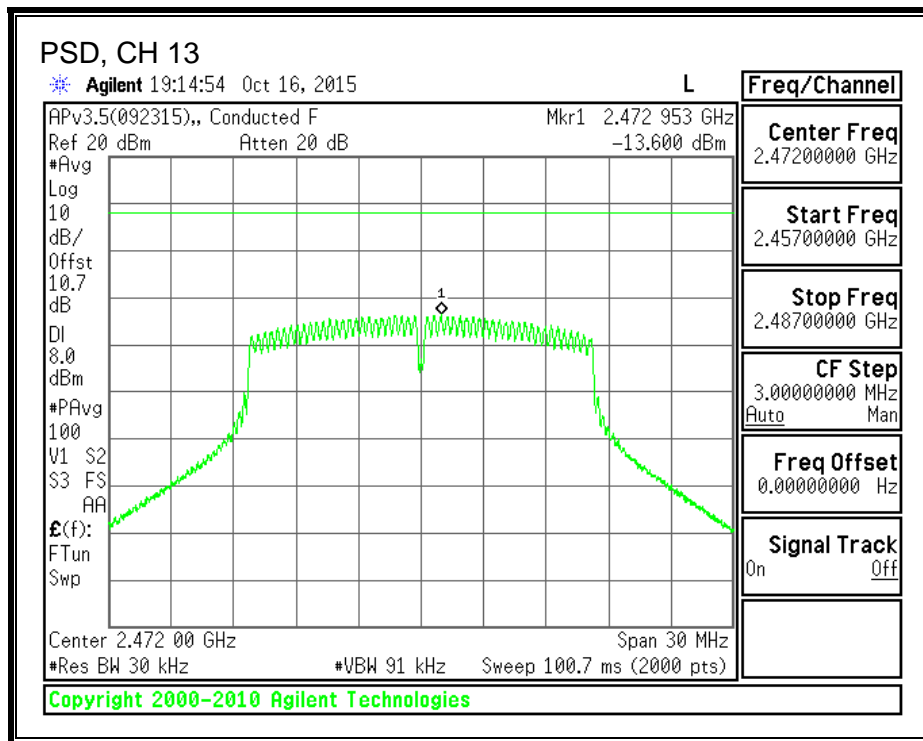

8.3.5. OUT-OF-BAND EMISSIONS

LIMITS

FCC §15.247 (d)

IC RSS-247 (5.5)

In any 100 kHz bandwidth outside the frequency band in which the spread spectrum or digitally modulated intentional radiator is operating, the radio frequency power that is produced by the intentional radiator shall be at least 20 dB below that in the 100 kHz bandwidth within the band that contains the highest level of the desired power, based on either an RF conducted or a radiated measurement, provided the transmitter demonstrates compliance with the peak conducted power limits. If the transmitter complies with the conducted power limits based on the use of RMS averaging over a time interval, as permitted under paragraph (b)(3) of this section, the attenuation required under this paragraph shall be 30 dB instead of 20 dB. Attenuation below the general limits specified in §15.209(a) is not required.

RESULTS

IN-BAND REFERENCE LEVEL

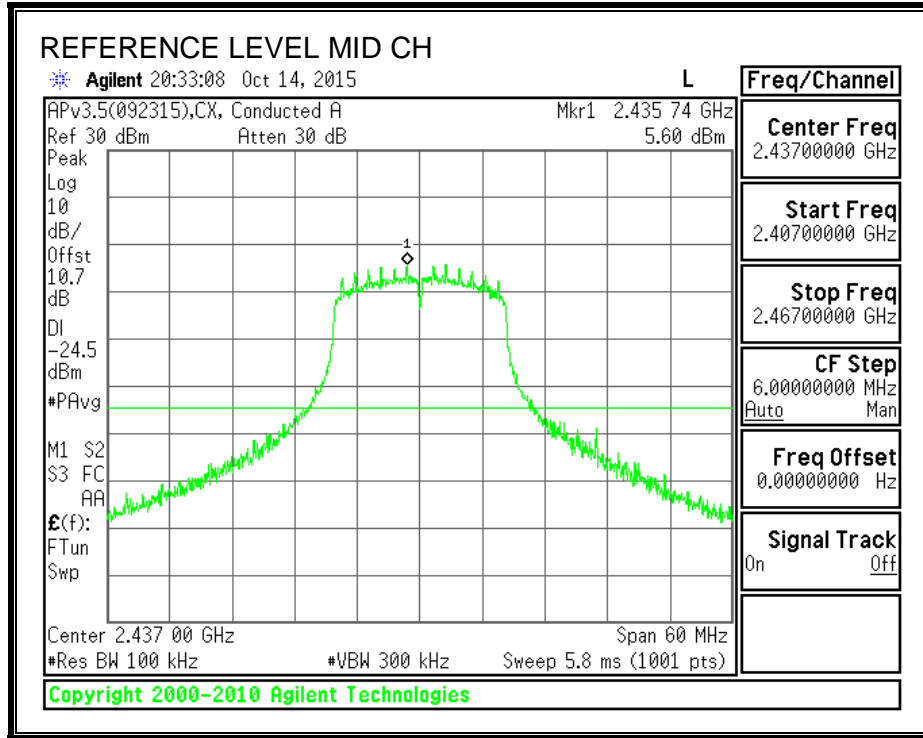

LOW CHANNEL BANDEGE

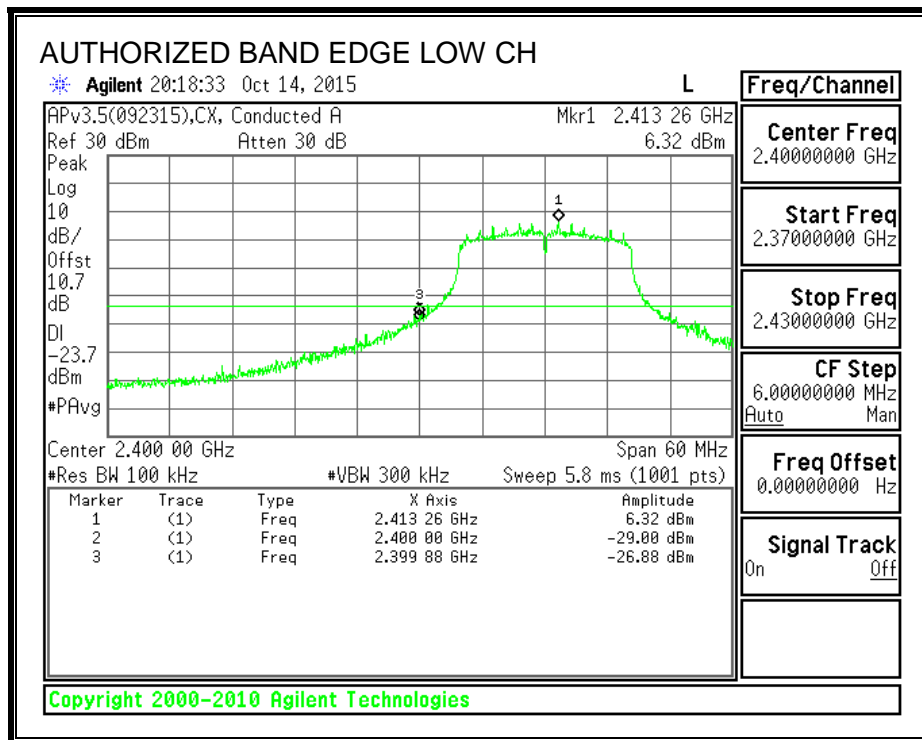

HIGH CHANNEL BANDEGE

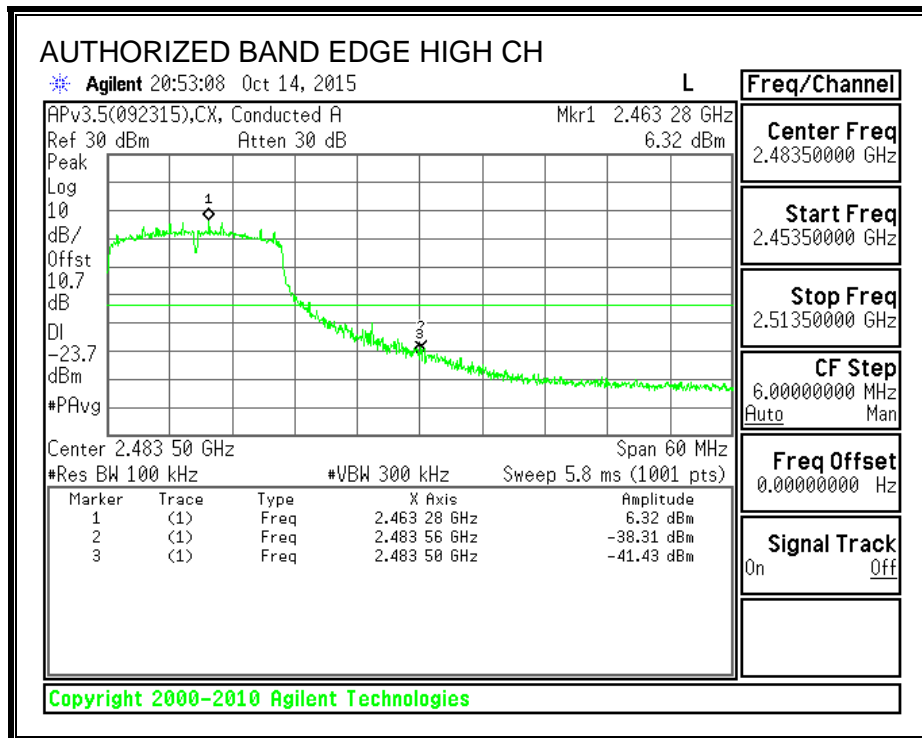

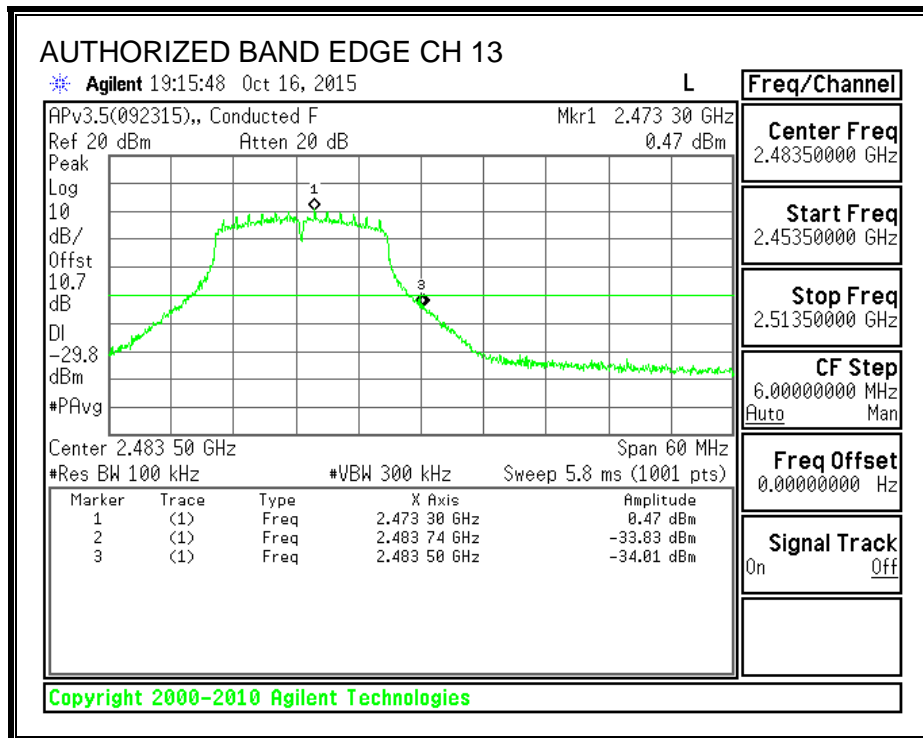
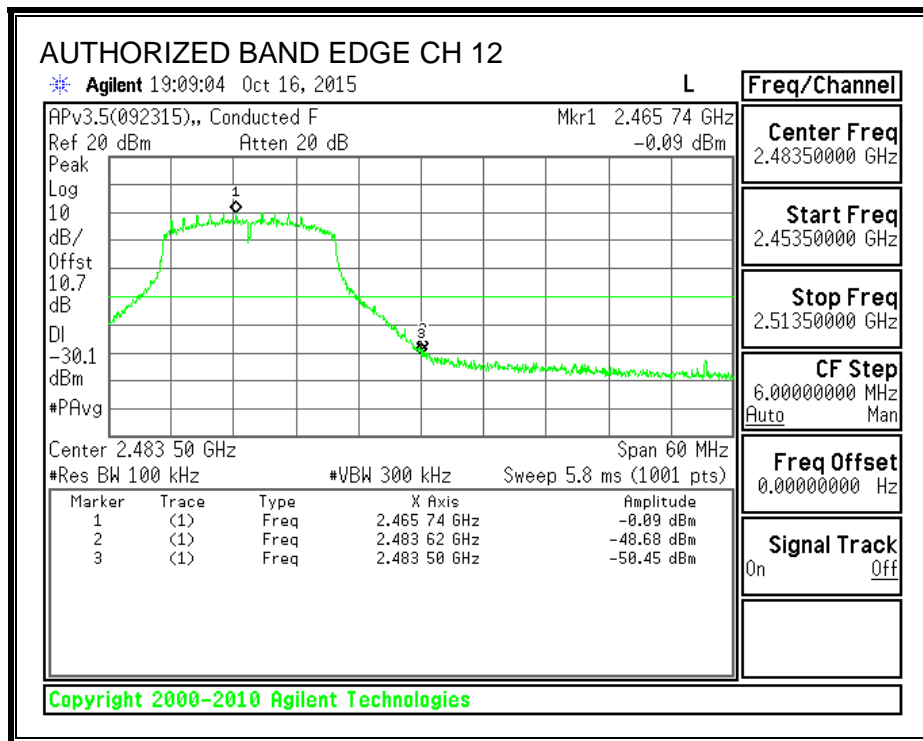

OUT-OF-BAND EMISSIONS

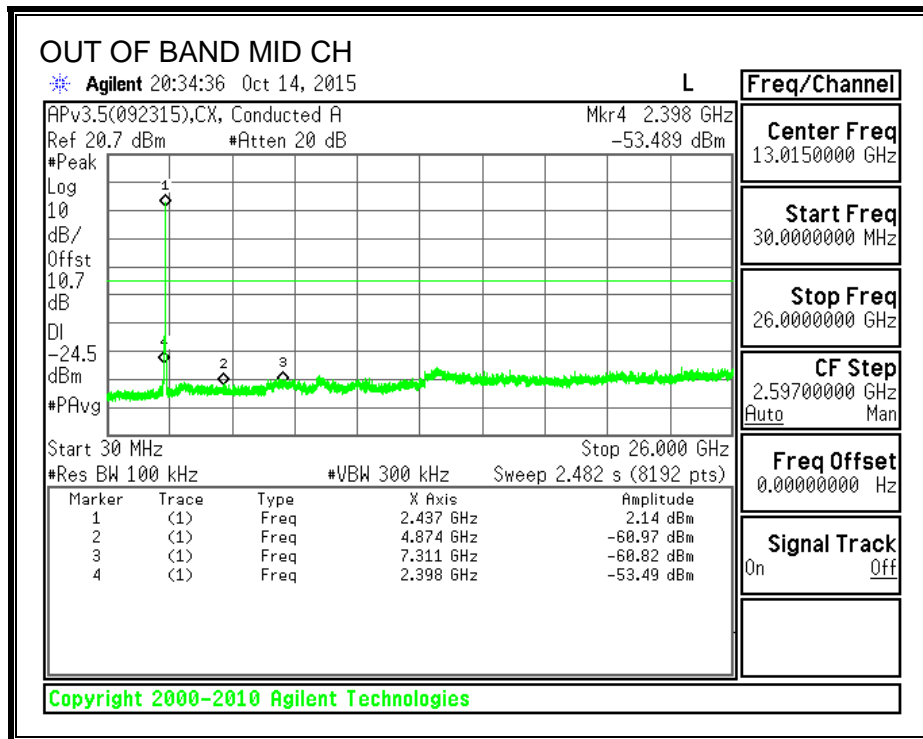
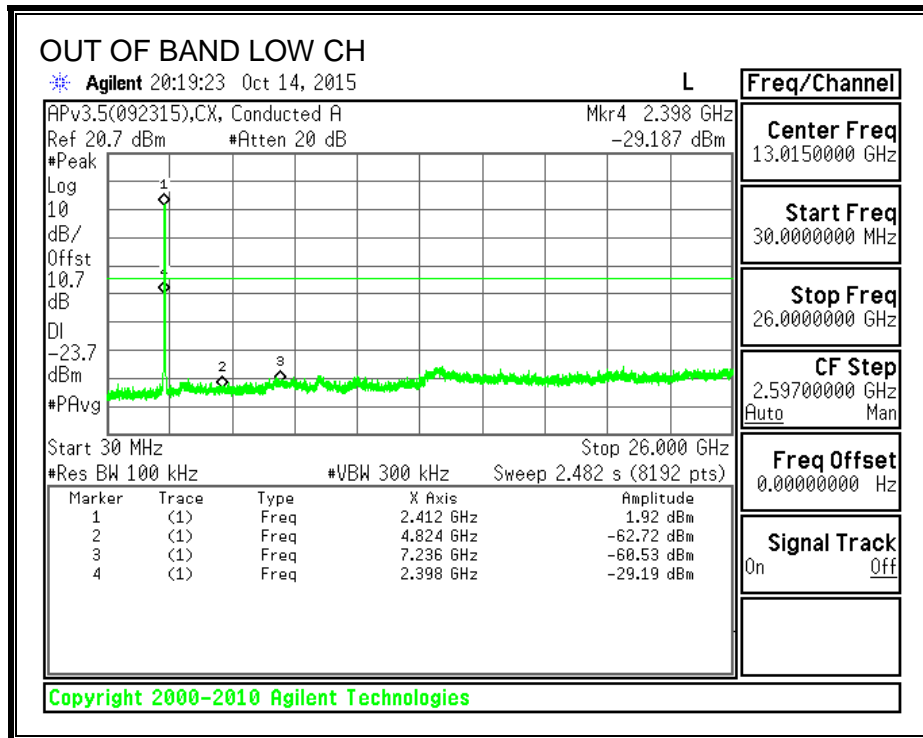

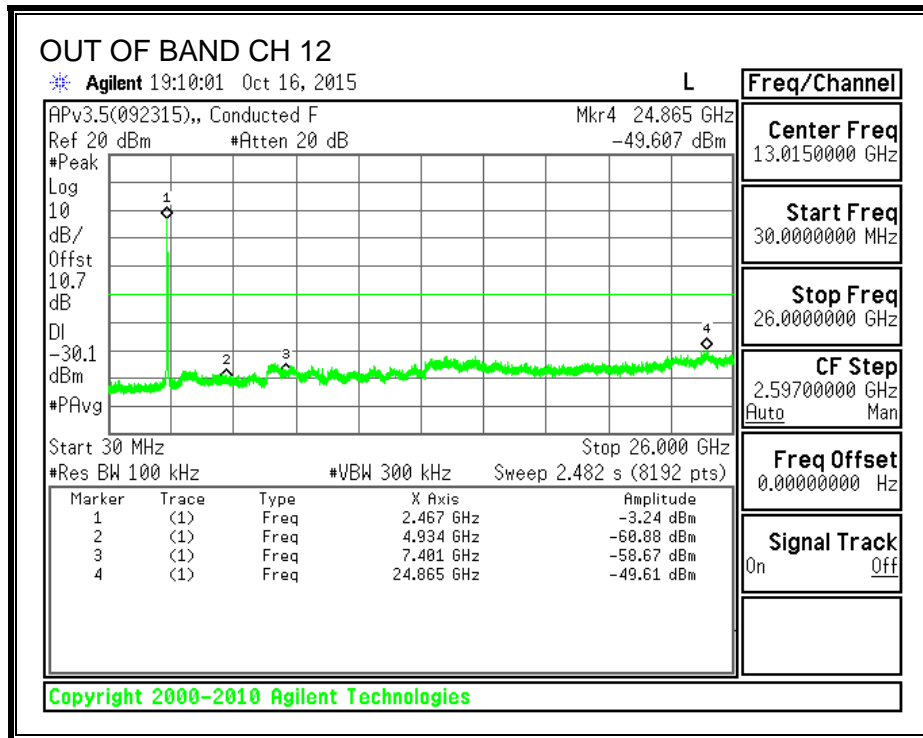
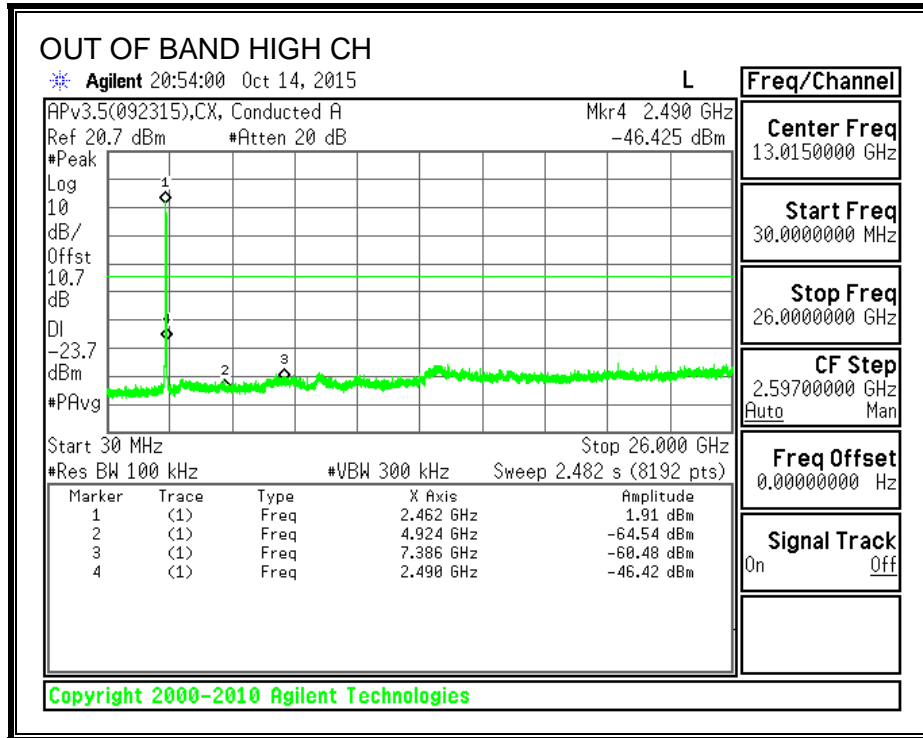

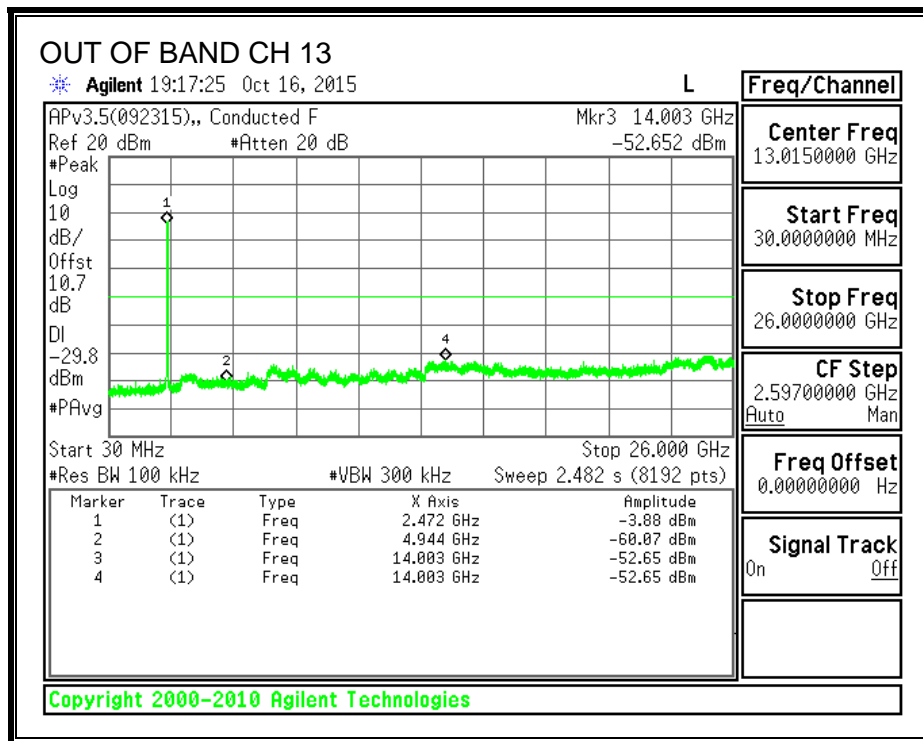

8.4. 802.11n HT20 MODE IN THE 2.4 GHz BAND

8.4.1. 6 dB BANDWIDTH

LIMITS

I FCC §15.247 (a) (2)

C RSS-247 (5.2) (1)

The minimum 6 dB bandwidth shall be at least 500 kHz.

RESULTS

Channel	Frequency (MHz)	6 dB Bandwidth (MHz)	Minimum Limit (MHz)
Low	2412	15.134	0.5
Mid	2437	15.111	0.5
High	2462	15.111	0.5
12	2467	15.019	0.5
13	2472	15.111	0.5

6 dB BANDWIDTH

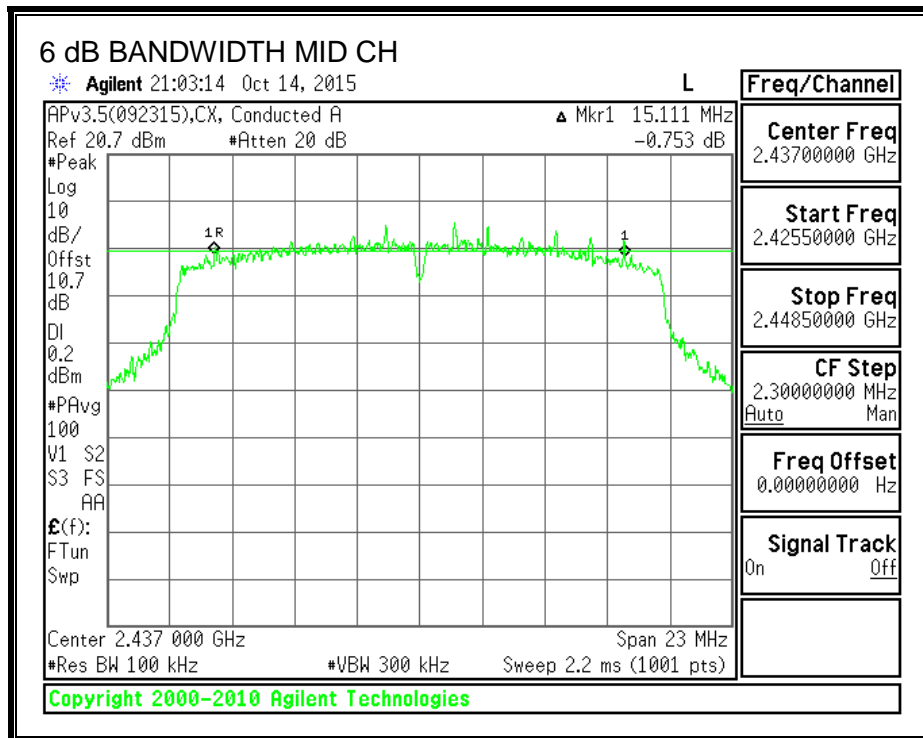
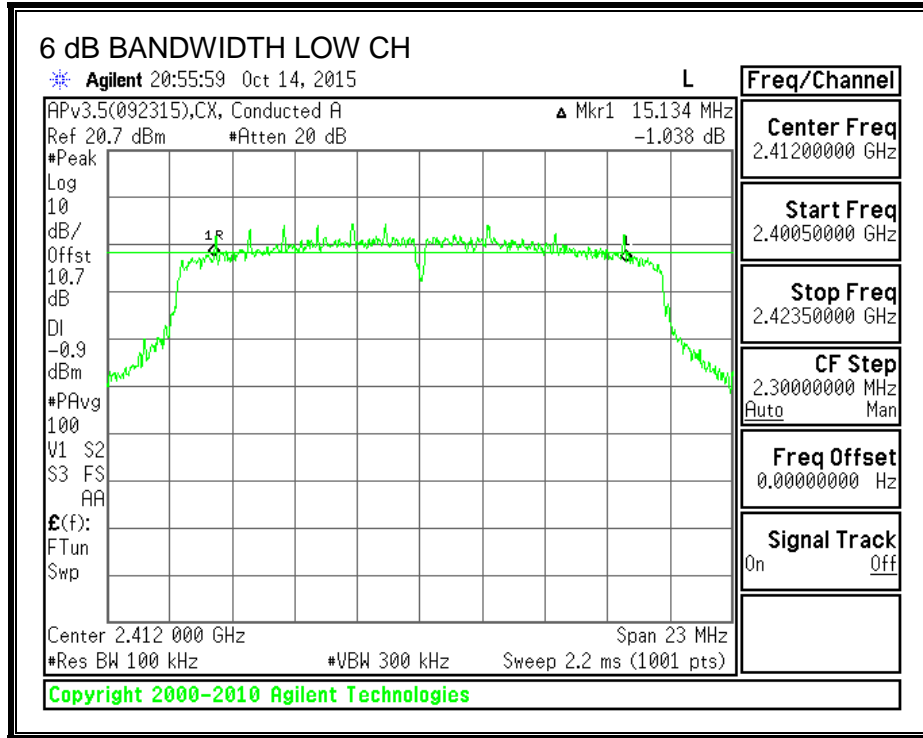

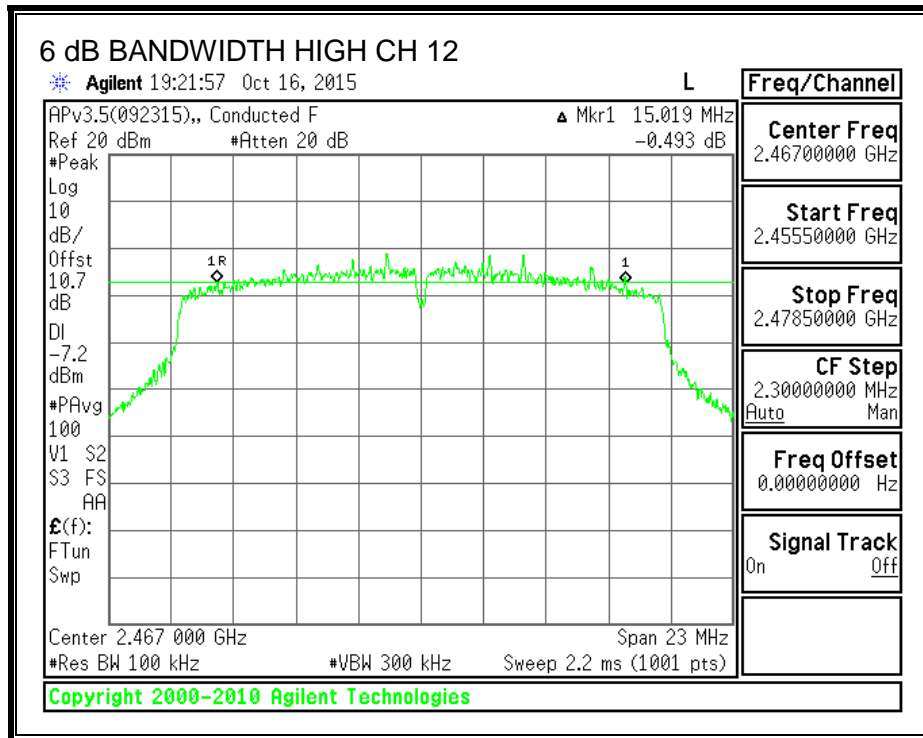
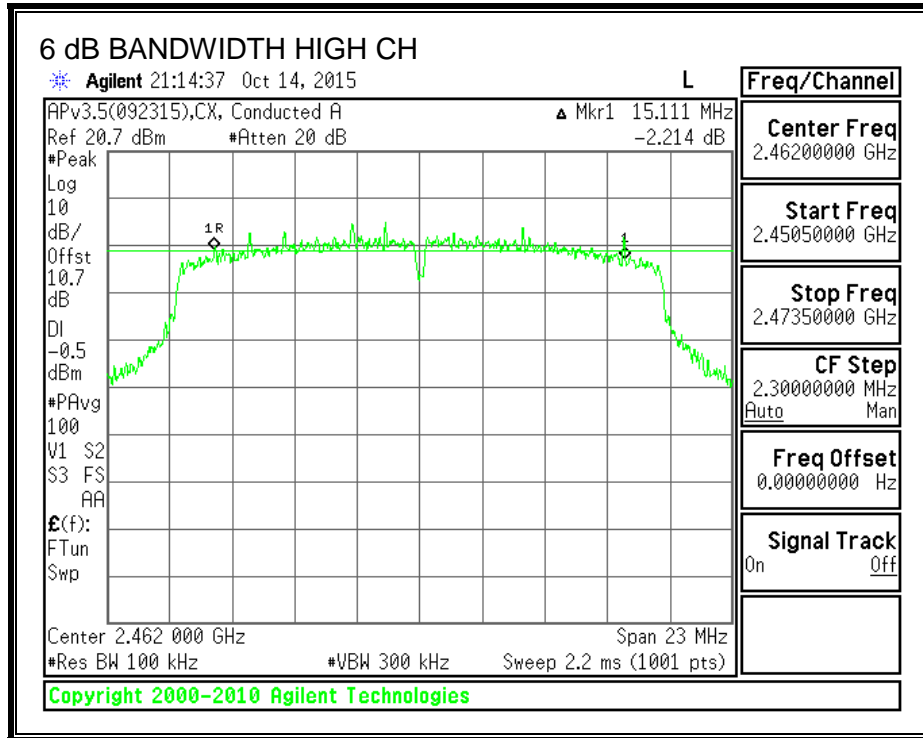

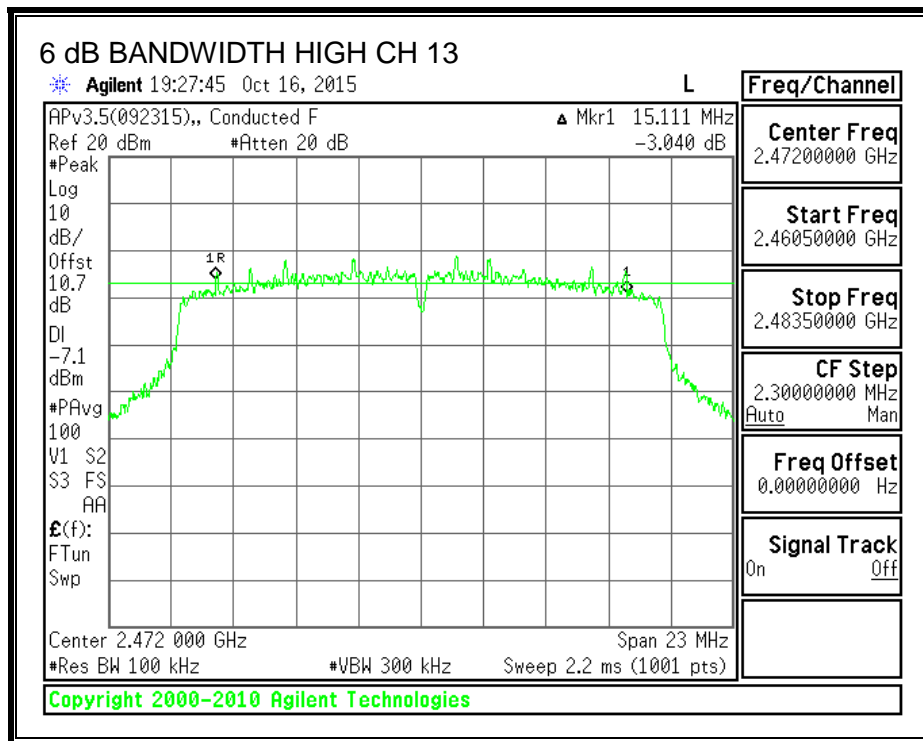

8.4.2. 99% BANDWIDTH

LIMITS

None; for reporting purposes only.

RESULTS

Channel	Frequency (MHz)	99% Bandwidth (MHz)
Low	2412	17.169
Mid	2437	17.009
High	2462	17.198
12	2467	16.949
13	2472	17.286

99% BANDWIDTH

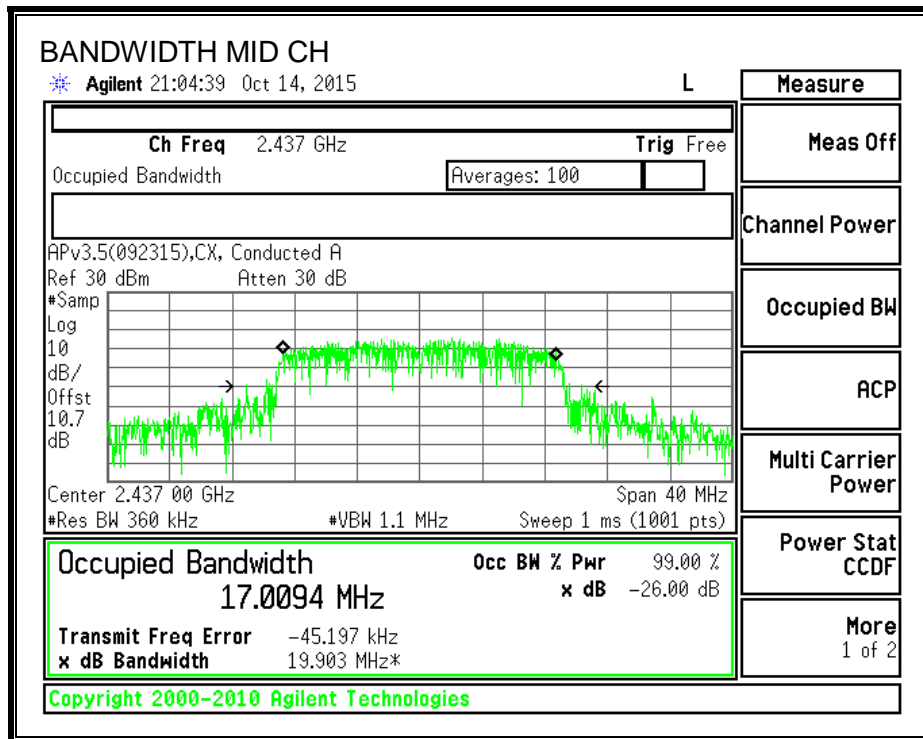
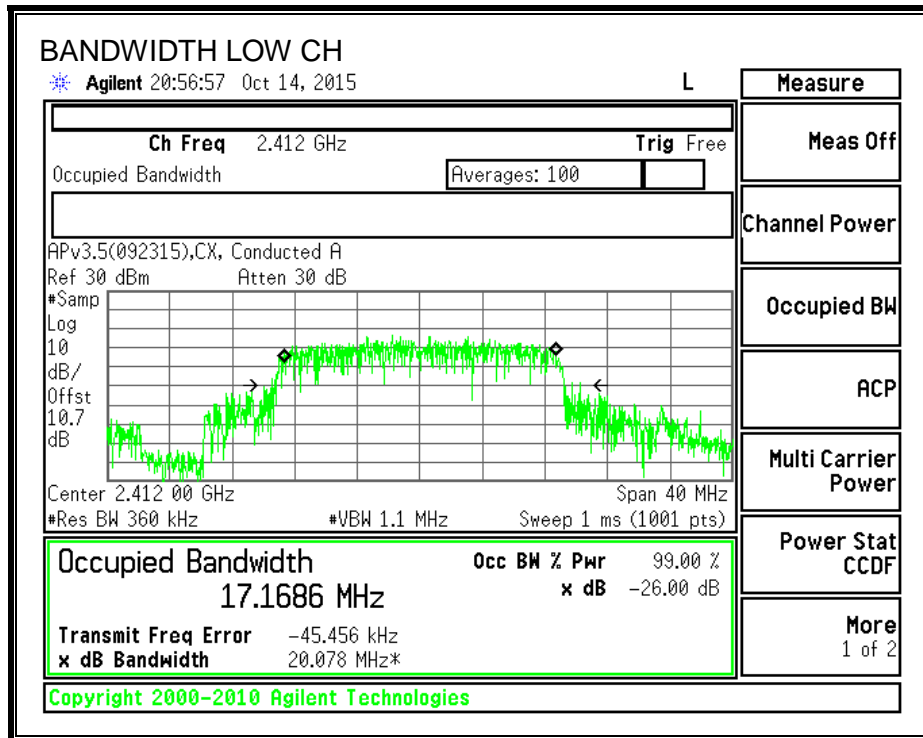

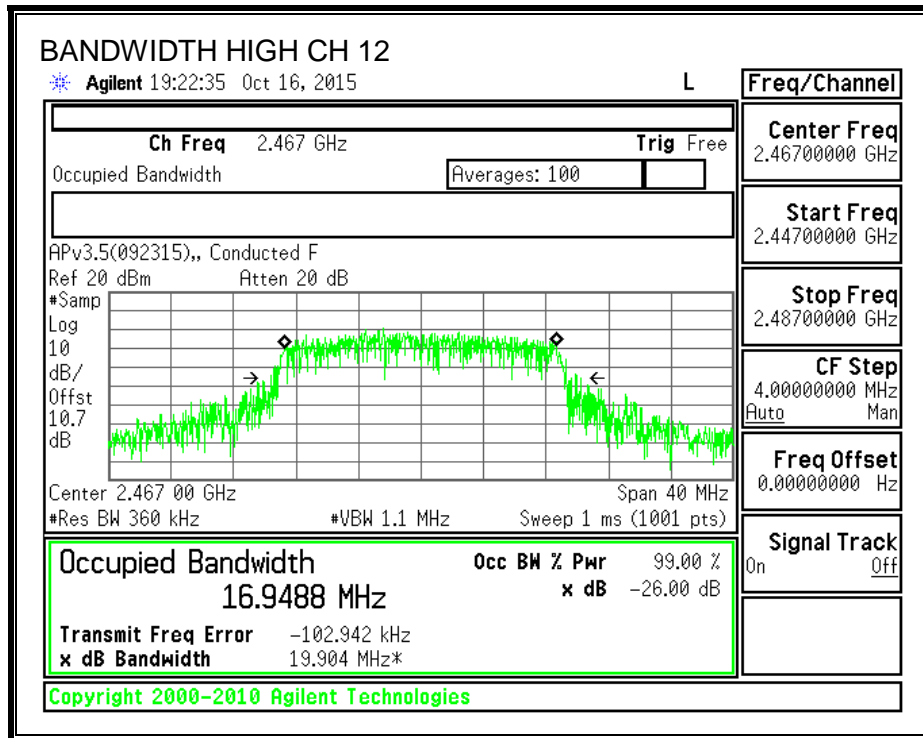
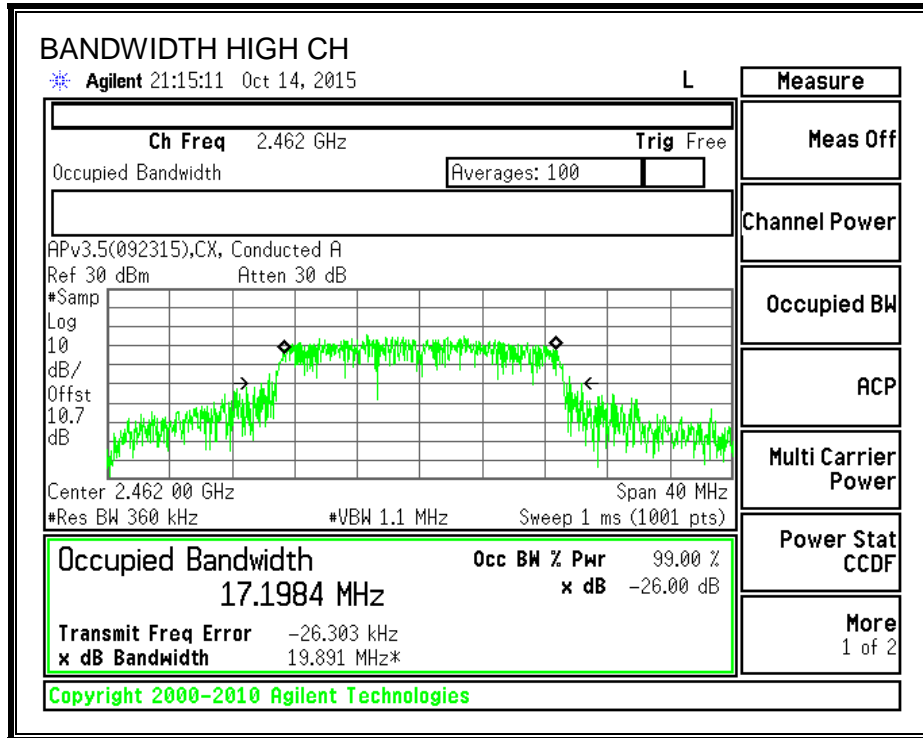

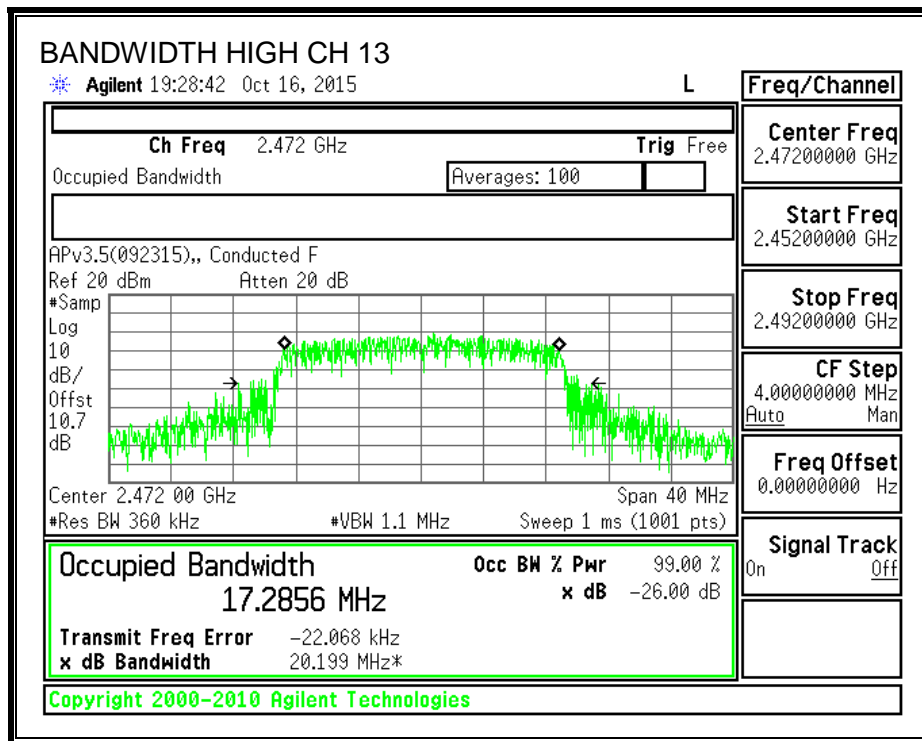

8.4.3. OUTPUT POWER

LIMITS

FCC §15.247

IC RSS-247 (5.4) (4)

For systems using digital modulation in the 902–928 MHz, 2400–2483.5 MHz, and 5725–5850 MHz bands: 1 Watt, based on the use of antennas with directional gains that do not exceed 6 dBi. If transmitting antennas of directional gain greater than 6 dBi are used, the conducted output power from the intentional radiator shall be reduced by the amount in dB that the directional gain of the antenna exceeds 6 dBi.

DIRECTIONAL ANTENNA GAIN

There is only one transmitter output therefore the directional gain is equal to the antenna gain.

RESULTS

Limits

Channel	Frequency (MHz)	Directional Gain (dBi)	FCC Power Limit (dBm)	IC Power Limit (dBm)	IC EIRP Limit (dBm)	Max Power (dBm)
Low	2412	-0.84	30.00	30	36	30.00
Mid	2437	-0.84	30.00	30	36	30.00
High	2462	-0.84	30.00	30	36	30.00
12	2467	-0.84	30.00	30	36	30.00
13	2472	-0.84	30.00	30	36	30.00

Duty Cycle CF (dB)	0.32	Included in Calculations of Corr'd Power
--------------------	------	--

Results

Channel	Frequency (MHz)	Meas Power (dBm)	Total Corr'd Power (dBm)	Power Limit (dBm)	Margin (dB)
Low	2412	16.10	16.42	30.00	-13.58
Mid	2437	16.00	16.32	30.00	-13.68
High	2462	16.10	16.42	30.00	-13.58
12	2467	7.40	7.72	30.00	-22.28
13	2472	7.40	7.72	30.00	-22.28

8.4.4. POWER SPECTRAL DENSITY

LIMITS

FCC §15.247

IC RSS-247 (5.2) (2)

For digitally modulated systems, the power spectral density conducted from the intentional radiator to the antenna shall not be greater than 8 dBm in any 3 KHz band during any time interval of continuous transmissions.

RESULTS

Duty Cycle CF (dB)	0.32	Included in Calculations of Corr'd PSD
---------------------------	------	---

PSD Results

Channel	Frequency (MHz)	Meas PSD (dBm)	Total Corr'd PSD (dBm)	Limit (dBm)	Margin (dB)
Low	2412	-7.93	-7.61	8.0	-15.6
Mid	2437	-8.11	-7.79	8.0	-15.8
High	2462	-7.95	-7.63	8.0	-15.6
12	2467	-14.35	-14.03	8.0	-22.0
13	2472	-14.05	-13.73	8.0	-21.7

PSD

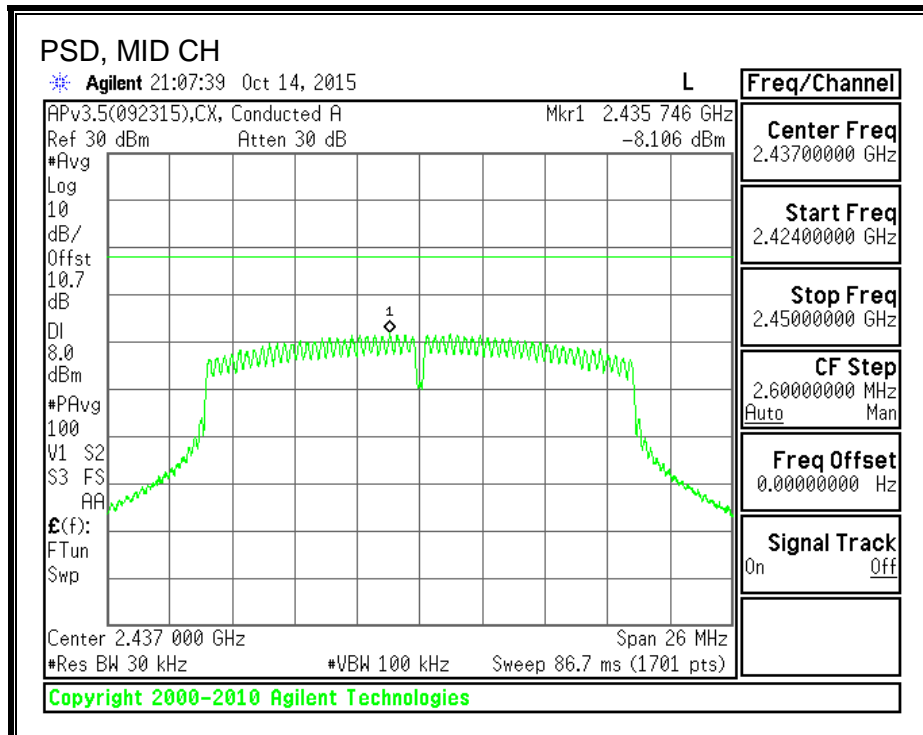
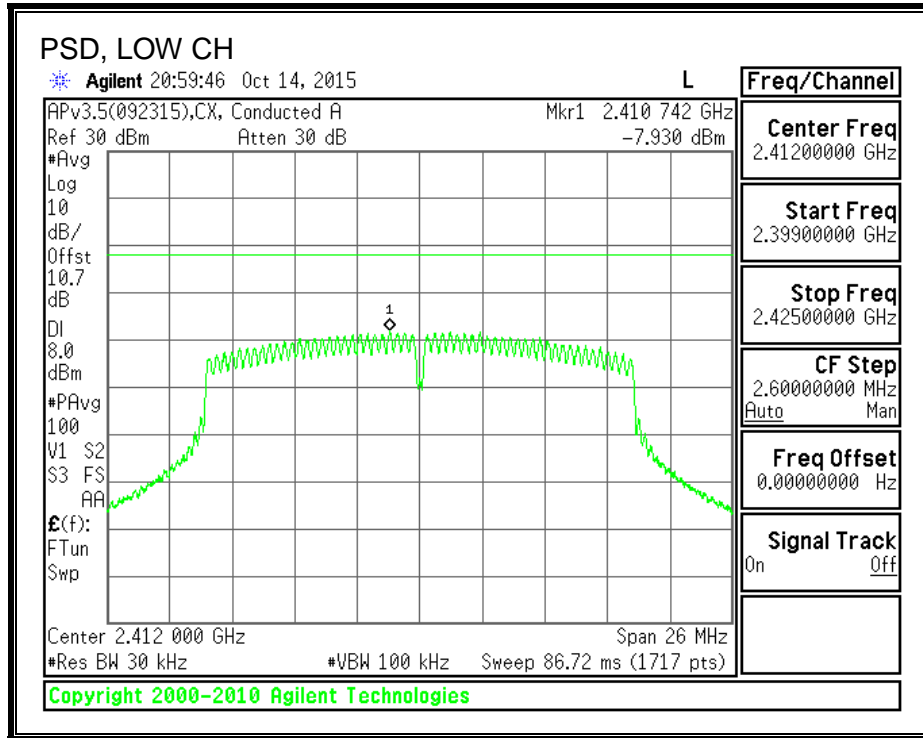

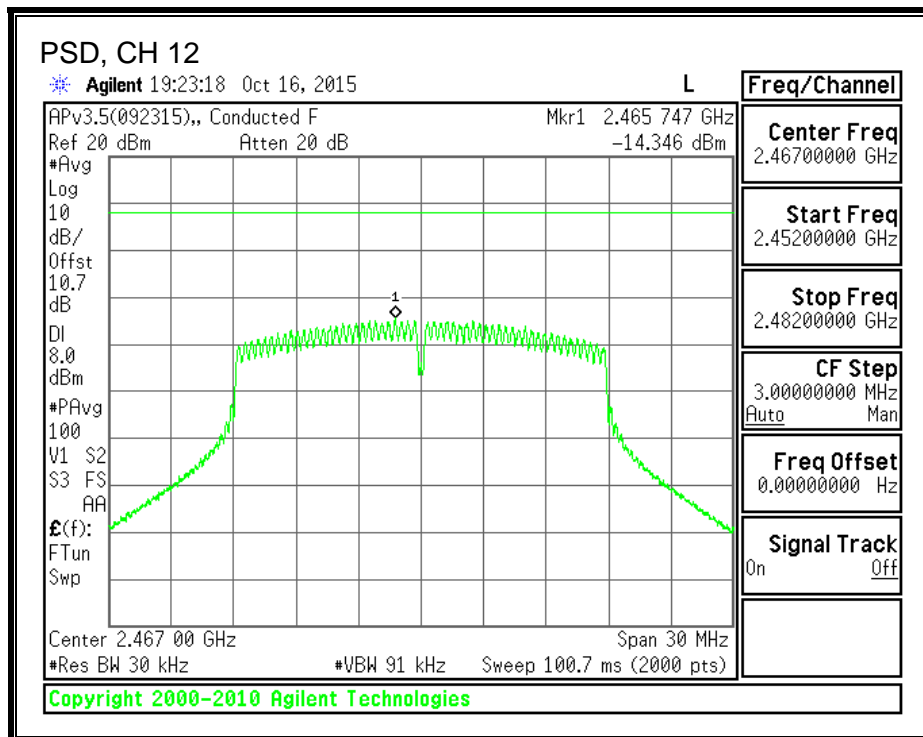
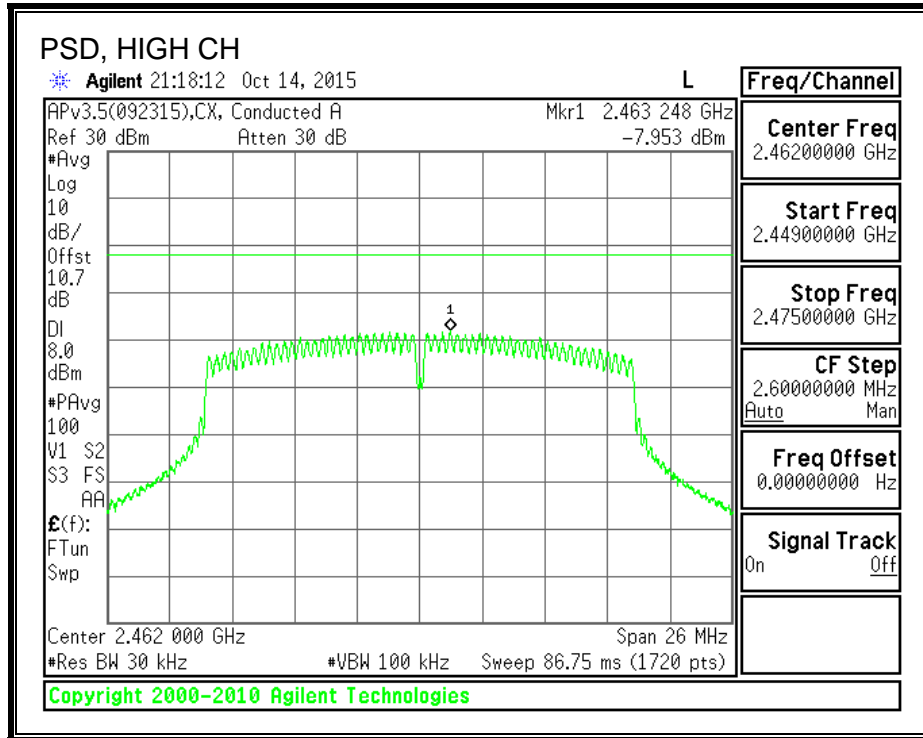

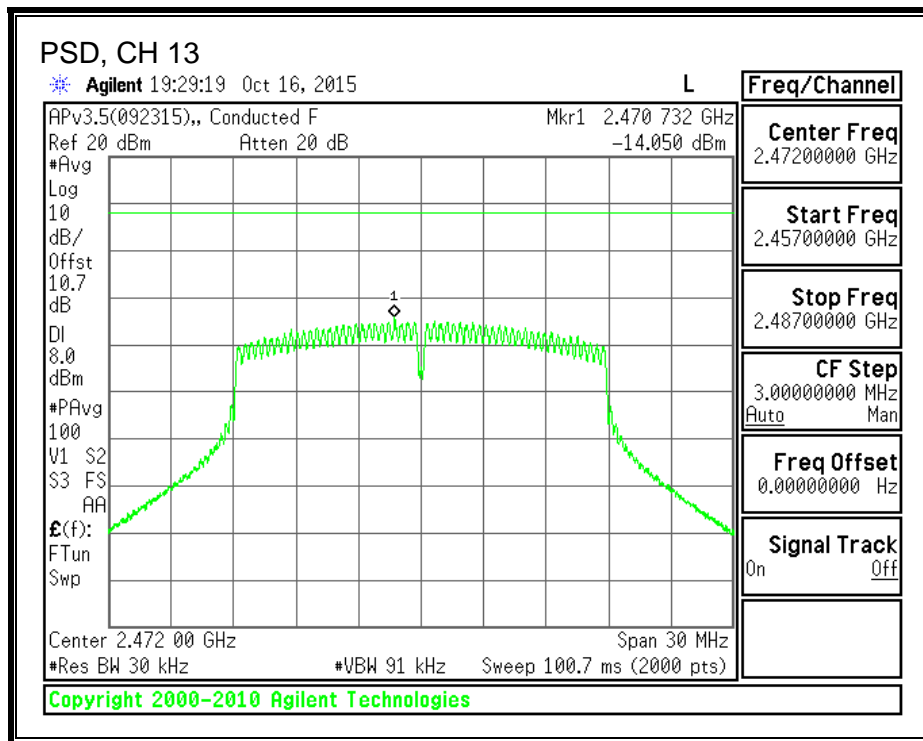

8.4.5. OUT-OF-BAND EMISSIONS

LIMITS

FCC §15.247 (d)

IC RSS-247 (5.5)

In any 100 kHz bandwidth outside the frequency band in which the spread spectrum or digitally modulated intentional radiator is operating, the radio frequency power that is produced by the intentional radiator shall be at least 20 dB below that in the 100 kHz bandwidth within the band that contains the highest level of the desired power, based on either an RF conducted or a radiated measurement, provided the transmitter demonstrates compliance with the peak conducted power limits. If the transmitter complies with the conducted power limits based on the use of RMS averaging over a time interval, as permitted under paragraph (b)(3) of this section, the attenuation required under this paragraph shall be 30 dB instead of 20 dB. Attenuation below the general limits specified in §15.209(a) is not required

RESULTS

IN-BAND REFERENCE LEVEL

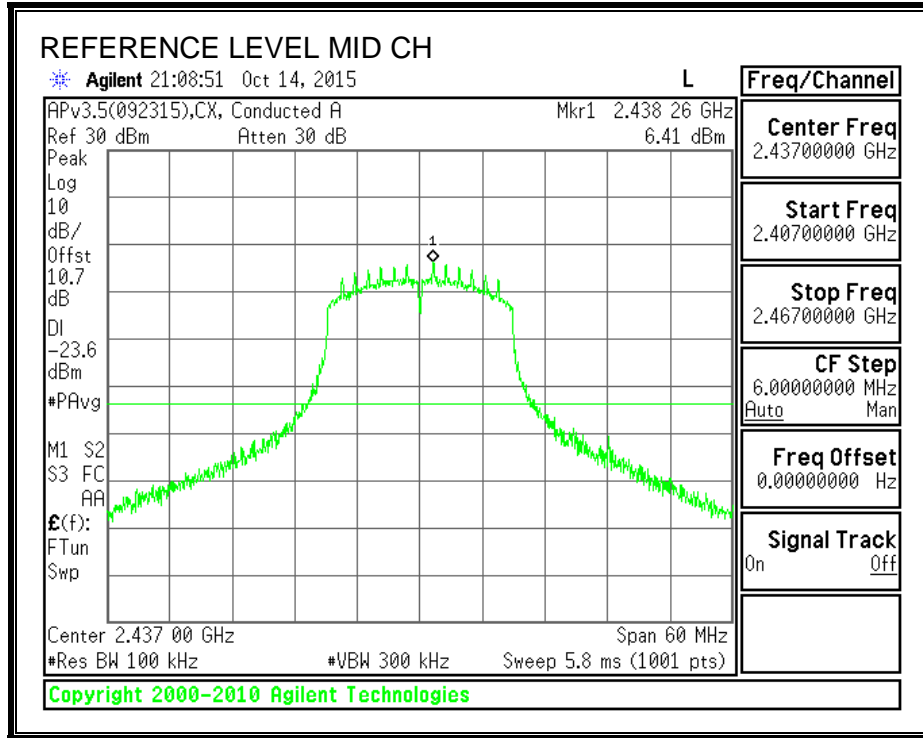

LOW CHANNEL BANDEGE

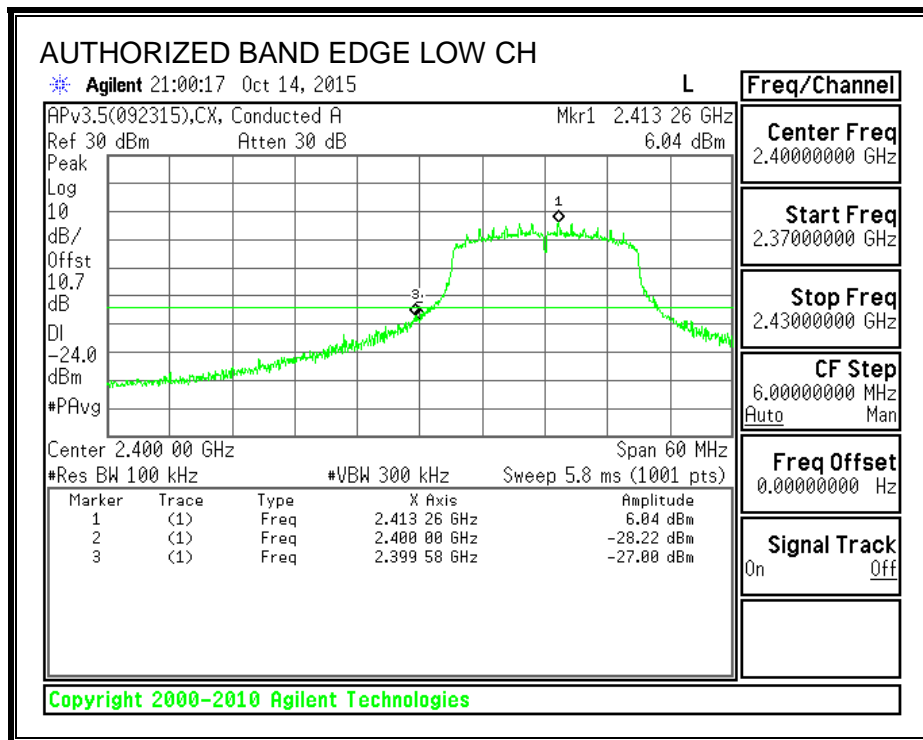

HIGH CHANNEL BANDEGE

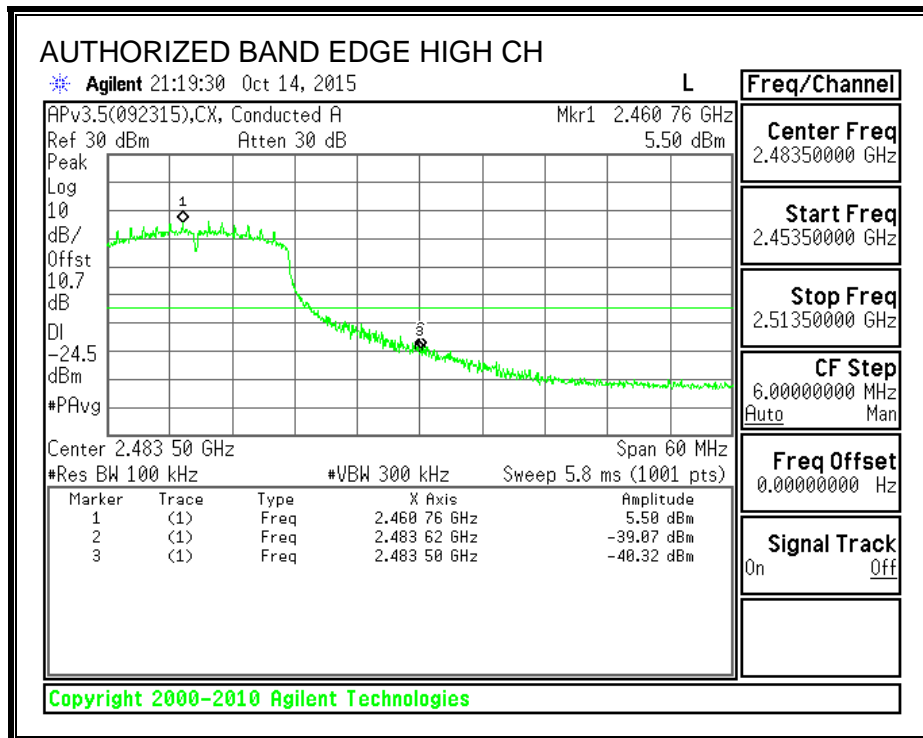

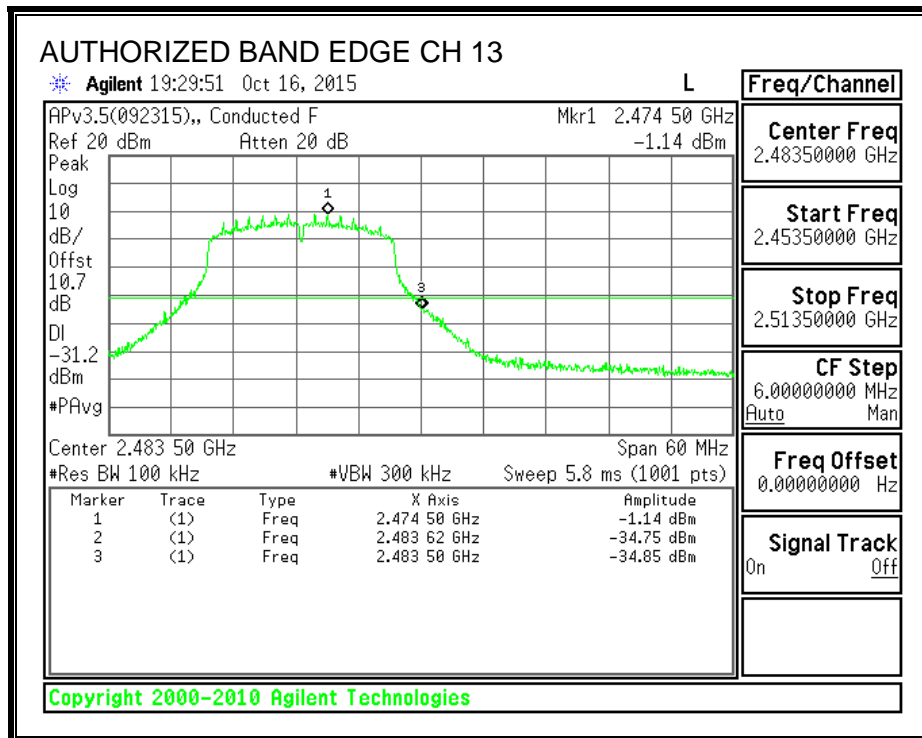
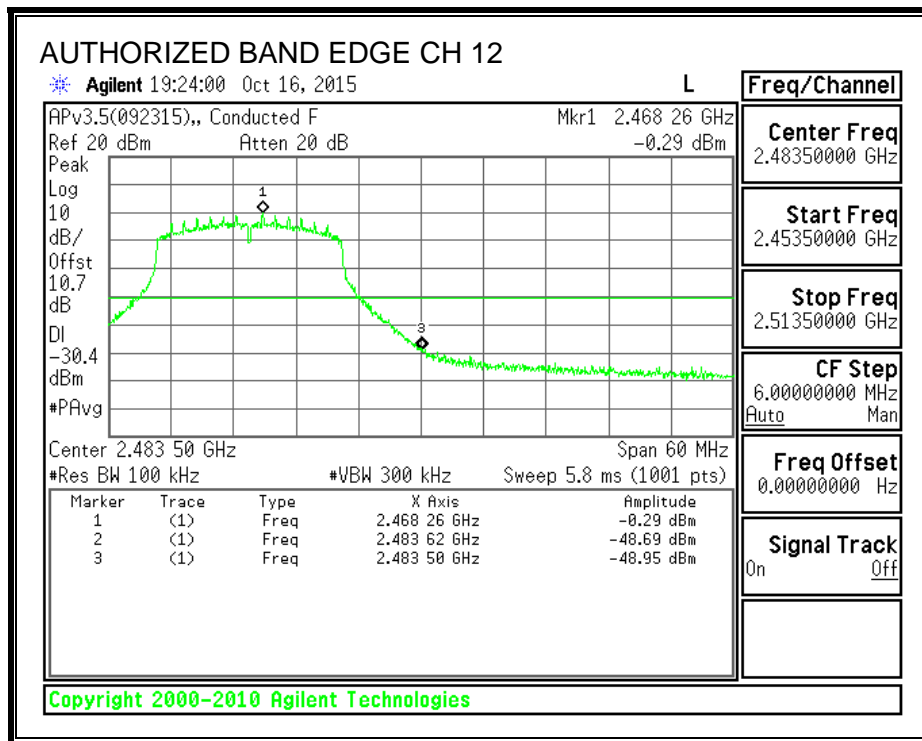

OUT-OF-BAND EMISSIONS

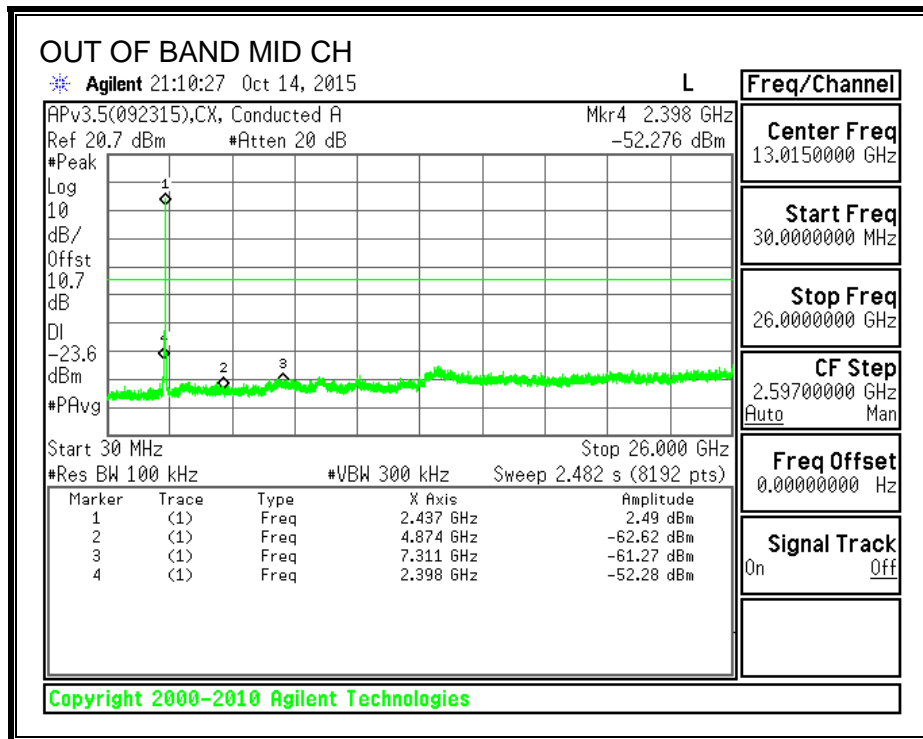
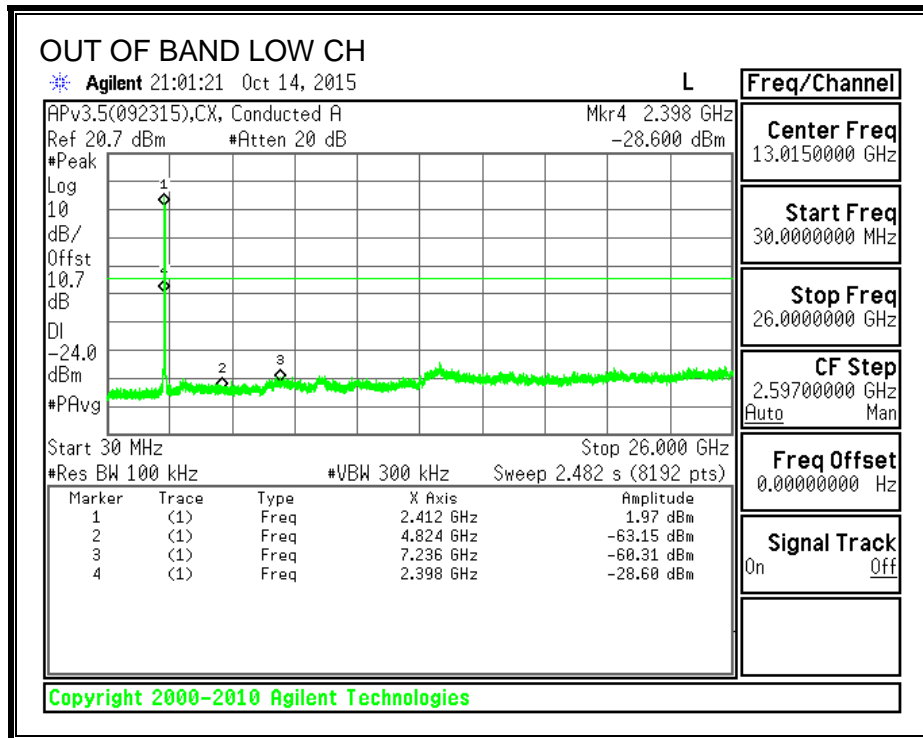

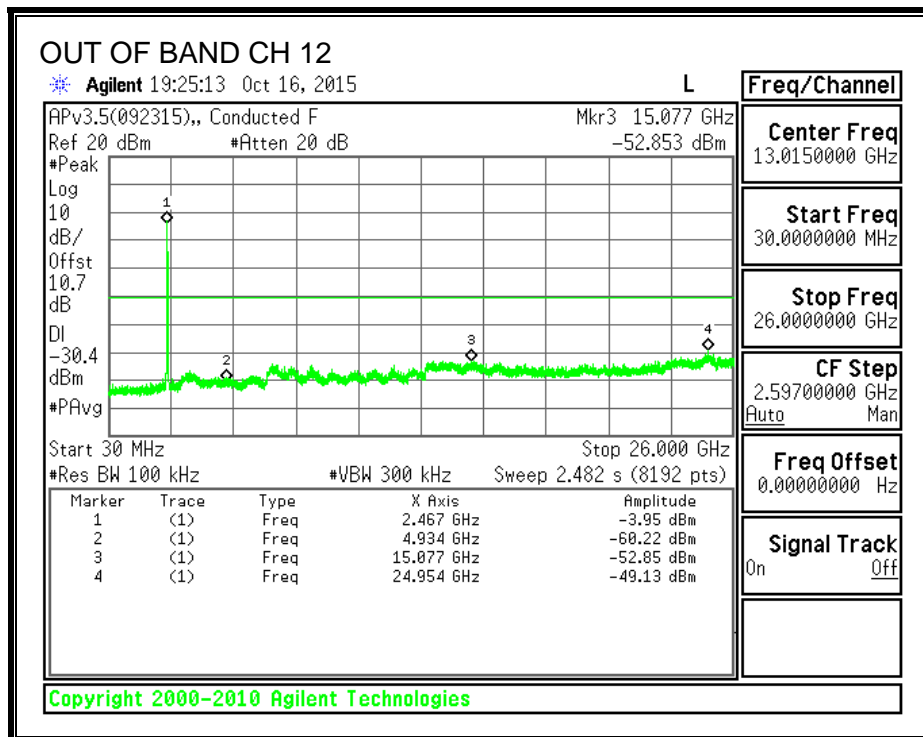
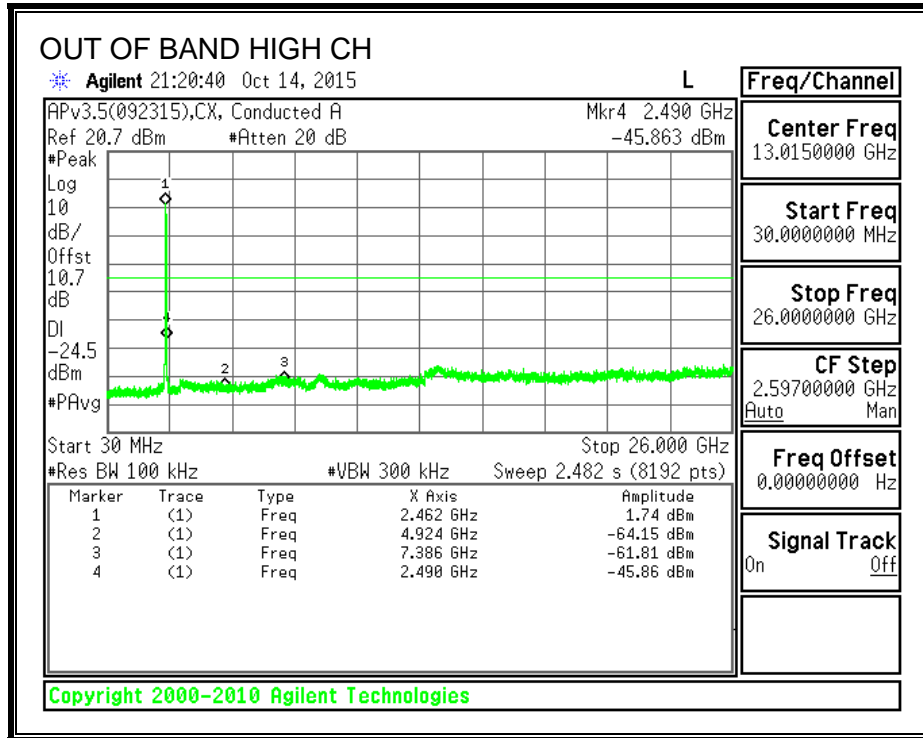

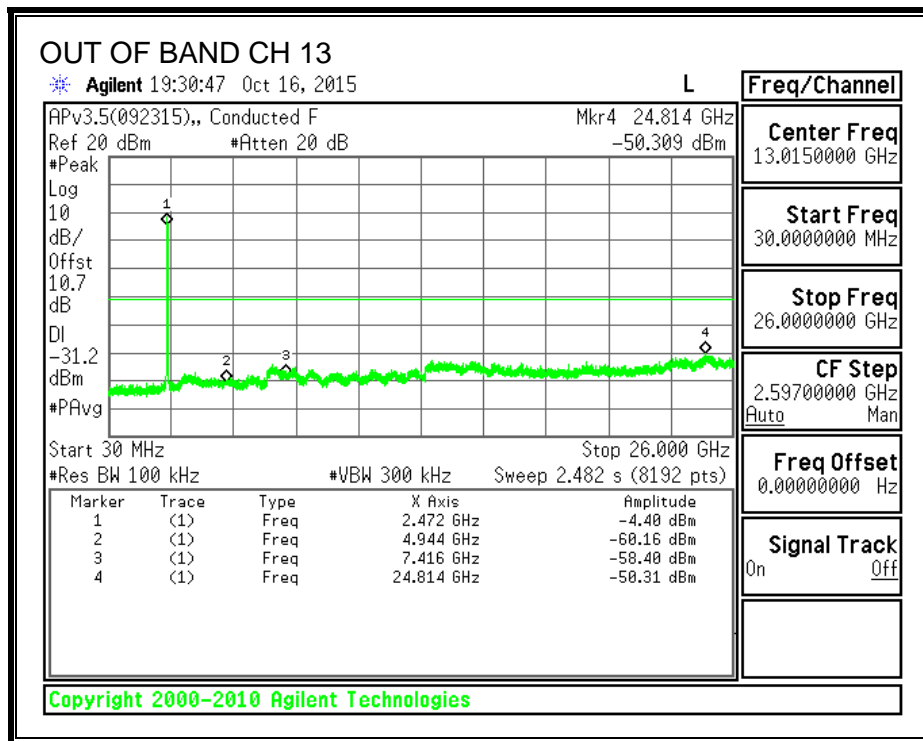

9. RADIATED TEST RESULTS

9.1. LIMITS AND PROCEDURE

LIMITS

FCC §15.205 and §15.209

IC RSS-GEN, Section 8.9 and 8.10.

Frequency Range (MHz)	Field Strength Limit (uV/m) at 3 m	Field Strength Limit (dBuV/m) at 3 m
30 - 88	100	40
88 - 216	150	43.5
216 - 960	200	46
Above 960	500	54

TEST PROCEDURE

The EUT is placed on a non-conducting table 80 cm above the ground plane for measurement below 1GHz; 1.5 m above the ground plane for measurement above 1GHz. The antenna to EUT distance is 3 meters. The EUT is configured in accordance with ANSI C63.10. The EUT is set to transmit in a continuous mode.

For measurements below 1 GHz the resolution bandwidth is set to 100 kHz for peak detection measurements or 120 kHz for quasi-peak detection measurements. Peak detection is used unless otherwise noted as quasi-peak.

For measurements above 1 GHz the resolution bandwidth is set to 1 MHz, the video bandwidth is set to 3 MHz for peak measurements and as applicable for average measurements.

For 2.4 GHz band, the spectrum from 30 MHz to 26 GHz is investigated with the transmitter set to the lowest, middle, and highest channels in the 2.4 GHz band.

The frequency range of interest is monitored at a fixed antenna height and EUT azimuth. The EUT is rotated through 360 degrees to maximize emissions received. The antenna is scanned from 1 to 4 meters above the ground plane to further maximize the emission. Measurements are made with the antenna polarized in both the vertical and the horizontal positions

9.2. TRANSMITTER ABOVE 1 GHz

9.2.1. TX ABOVE 1 GHz 802.11b MODE IN THE 2.4 GHz BAND

RESTRICTED BANDEDGE (LOW CHANNEL)

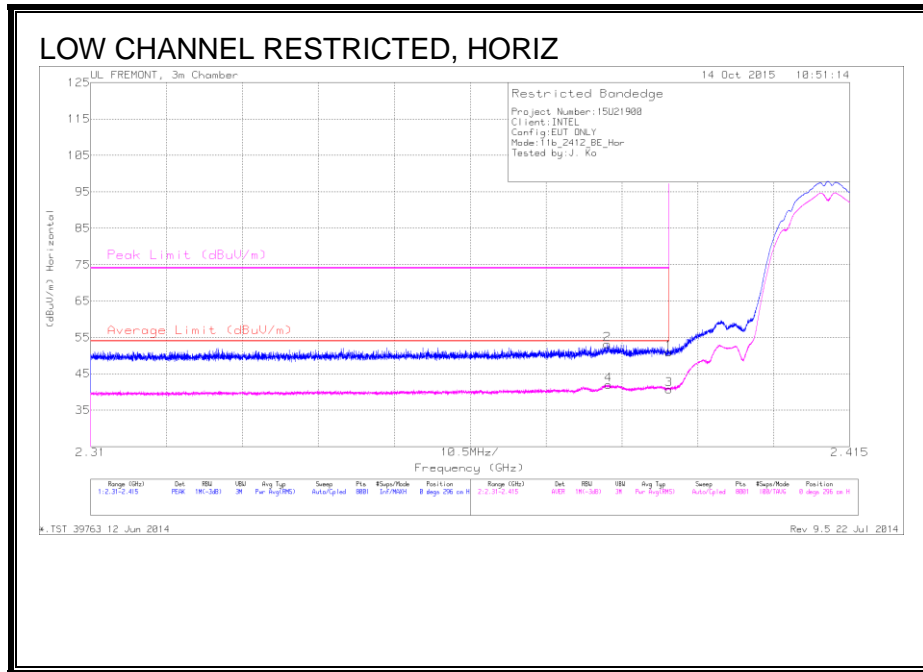

Marker	Frequency (GHz)	Meter Reading (dBuV)	Det	AF T119 (dB/m)	Amp/Cbl/Ftr/Pad (dB)	Corrected Reading (dBuV/m)	Average Limit (dBuV/m)	Margin (dB)	Peak Limit (dBuV/m)	PK Margin (dB)	Azimuth (Degs)	Height (cm)	Polarity
2	2.381	43.58	PK	32	-22.4	53.18	-	-	74	-20.82	0	296	H
4	2.382	32.37	RMS	32	-22.4	41.97	54	-12.03	-	-	0	296	H
1	2.39	41.31	PK	32	-22.4	50.91	-	-	74	-23.09	0	296	H
3	2.39	31.12	RMS	32	-22.4	40.72	54	-13.28	-	-	0	296	H

PK - Peak detector

RMS - RMS detection

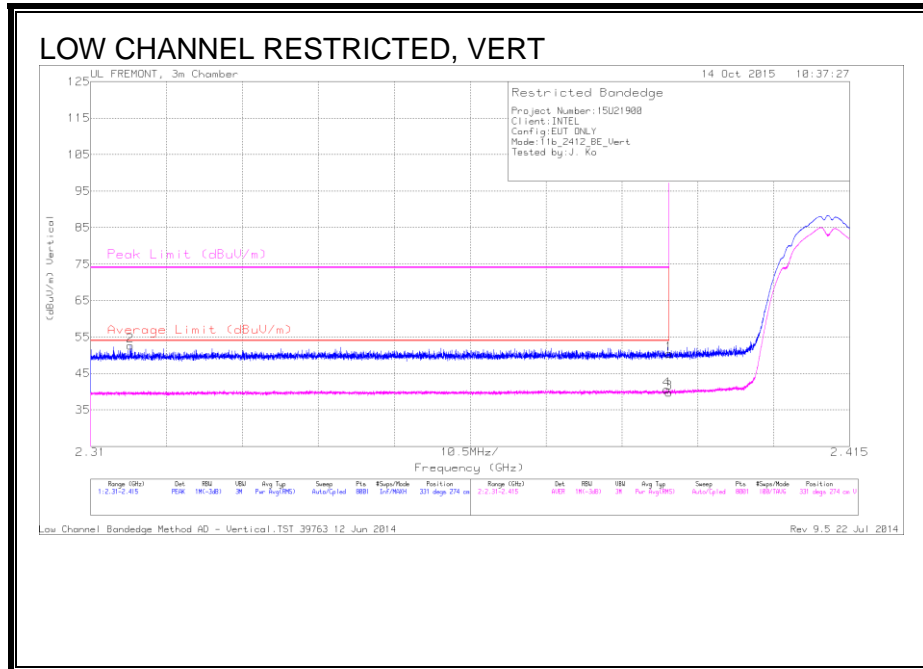

Trace Markers

Marker	Frequency (GHz)	Meter Reading (dBuV)	Det	AF T119 (dB/m)	Amp/Cb/Fitter/Pad (dB)	DC Corr (dB)	Corrected Reading (dBuV/m)	Average Limit (dBuV/m)	Margin (dB)	Peak Limit (dBuV/m)	PK Margin (dB)	Azimuth (Degs)	Height (cm)	Polarity
2	2.316	43.3	PK	31.7	-22.4	0	52.6	-	-	74	-21.4	331	274	V
1	2.39	40.86	PK	32	-22.4	0	50.46	-	-	74	-23.54	331	274	V
3	2.39	30.14	RMS	32	-22.4	0	39.74	54	-14.26	-	-	331	274	V
4	2.39	30.96	RMS	32	-22.4	0	40.56	54	-13.44	-	-	331	274	V

PK - Peak detector

RMS - RMS detection

AUTHORIZED BANDEDGE (HIGH CHANNEL)

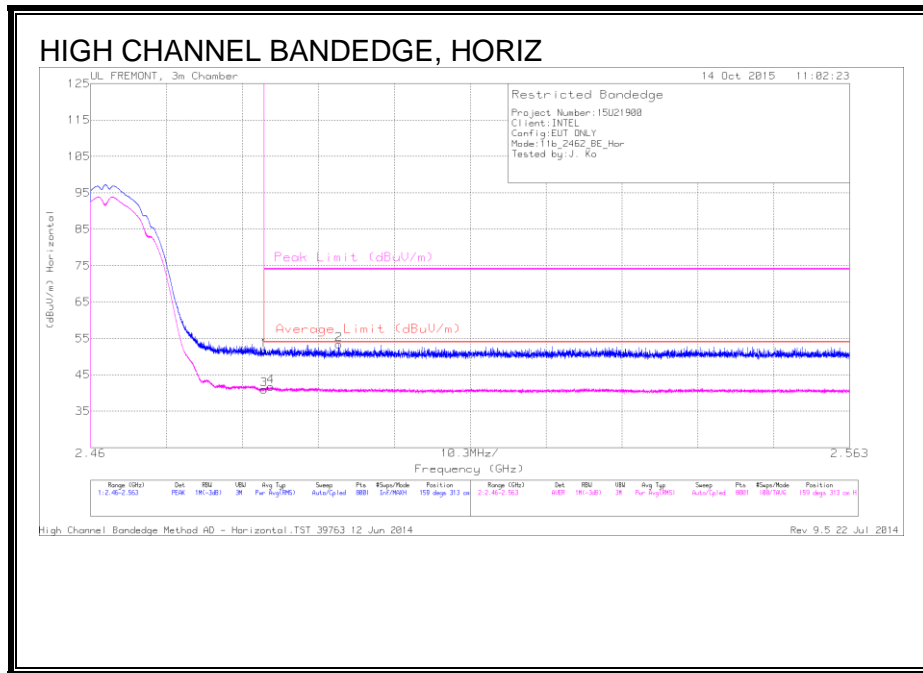

Marker	Frequency (GHz)	Meter Reading (dBuV)	Det	AF T119 (dB/m)	Amp/Cbl/ Filtr/Pad (dB)	Corrected Reading (dBuV/m)	Average Limit (dBuV/m)	Margin (dB)	Peak Limit (dBuV/m)	PK Margin (dB)	Azimuth (Degs)	Height (cm)	Polarity
1	2.484	41.44	PK	32.3	-22.1	51.64	-	-	74	-22.36	159	313	H
3	2.484	30.78	RMS	32.3	-22.1	40.98	54	-13.02	-	-	159	313	H
4	2.484	31.58	RMS	32.3	-22.1	41.78	54	-12.22	-	-	159	313	H
2	2.494	43.24	PK	32.3	-22.1	53.44	-	-	74	-20.56	159	313	H

PK - Peak detector

RMS - RMS detection

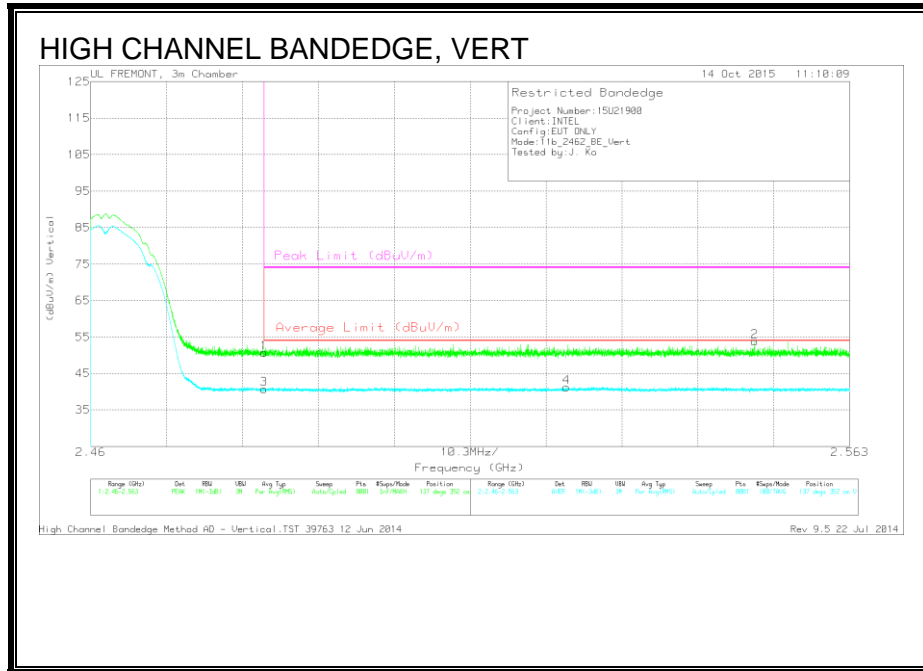

Marker	Frequency (GHz)	Meter Reading (dBuV)	Det	AF T119 (dB/m)	Amp/Cb/Filter/Pad (dB)	DC Corr (dB)	Corrected Reading (dBuV/m)	Average Limit (dBuV/m)	Margin (dB)	Peak Limit (dBuV/m)	PK Margin (dB)	Azimuth (Degs)	Height (cm)	Polarity
1	2.484	40.47	PK	32.3	-22.1	0	50.67	-	-	74	-23.33	137	352	V
3	2.484	30.58	RMS	32.3	-22.1	0	40.78	54	-13.22	-	-	137	352	V
4	2.525	30.87	RMS	32.4	-22	0	41.27	54	-12.73	-	-	137	352	V
2	2.55	43.39	PK	32.4	-22	0	53.79	-	-	74	-20.21	137	352	V

PK - Peak detector

RMS - RMS detection

AUTHORIZED BANDEDGE (CHANNEL 13)

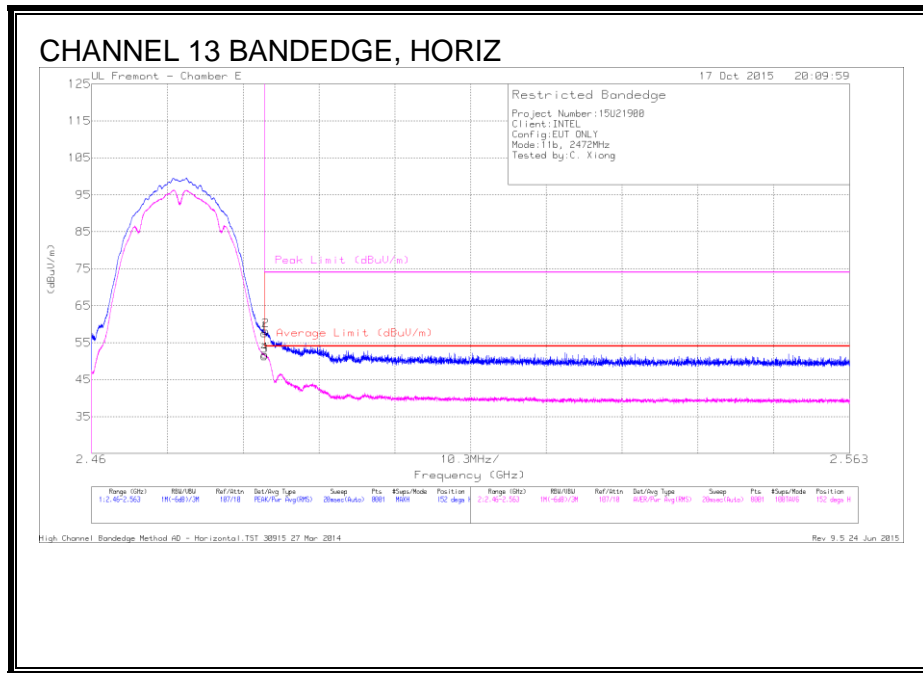

Marker	Frequency (GHz)	Meter Reading (dBuV)	Det	AF T346 (dB/m)	Amp/Cb/Fit r/Pad (dB)	DC Corr (dB)	Corrected Reading (dBuV/m)	Average Limit (dBuV/m)	Margin (dB)	Peak Limit (dBuV/m)	PK Margin (dB)	Azimuth (Degs)	Height (cm)	Polarity
1	* 2.484	48.21	Pk	32.2	-22.9	0	57.51	-	-	74	-16.49	152	141	H
2	* 2.484	48.9	Pk	32.2	-22.9	0	58.2	-	-	74	-15.8	152	141	H
3	* 2.484	42.09	RMS	32.2	-22.9	0	51.39	54	-2.61	-	-	152	141	H
4	* 2.484	42.46	RMS	32.2	-22.9	0	51.76	54	-2.24	-	-	152	141	H

* - indicates frequency in CFR15.205/IC7.2.2 Restricted Band

Pk - Peak detector

RMS - RMS detection

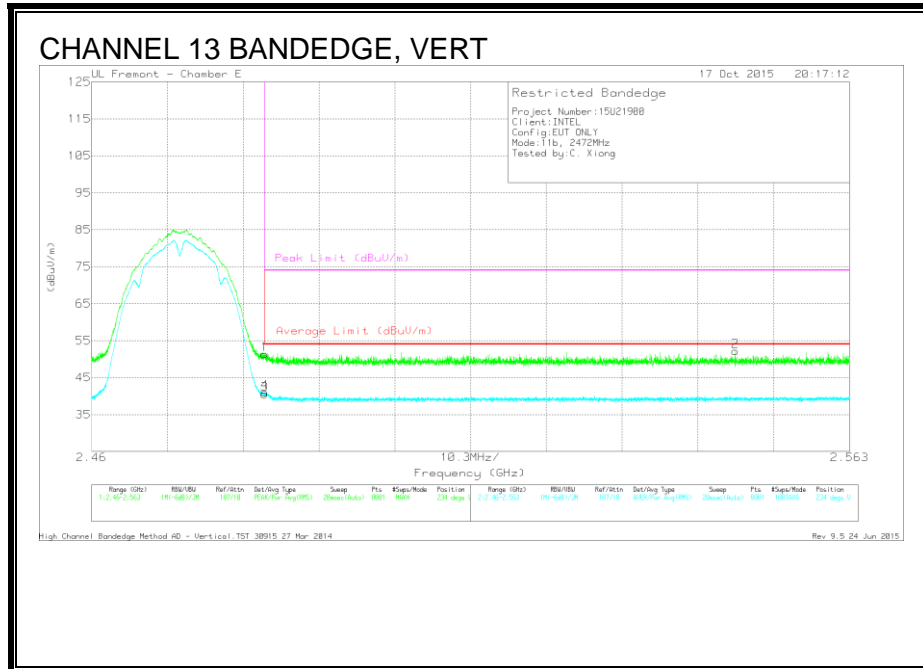

Marker	Frequency (GHz)	Meter Reading (dBuV)	Det	AF T346 (dB/m)	Amp/Cbl/Ftr/Pad (dB)	Corrected Reading (dBuV/m)	Average Limit (dBuV/m)	Margin (dB)	Peak Limit (dBuV/m)	PK Margin (dB)	Azimuth (Degs)	Height (cm)	Polarity
1	* 2.484	41.97	Pk	32.2	-22.9	51.27	-	-	74	-22.73	234	356	V
3	* 2.484	31.25	RMS	32.2	-22.9	40.55	54	-13.45	-	-	234	356	V
4	* 2.484	31.7	RMS	32.2	-22.9	41	54	-13	-	-	234	356	V
2	2.547	42.68	Pk	32.3	-22.8	52.18	-	-	74	-21.82	234	356	V

* - indicates frequency in CFR15.205/IC7.2.2 Restricted Band

Pk - Peak detector

RMS - RMS detection

HARMONICS AND SPURIOUS EMISSIONS

LOW CHANNEL

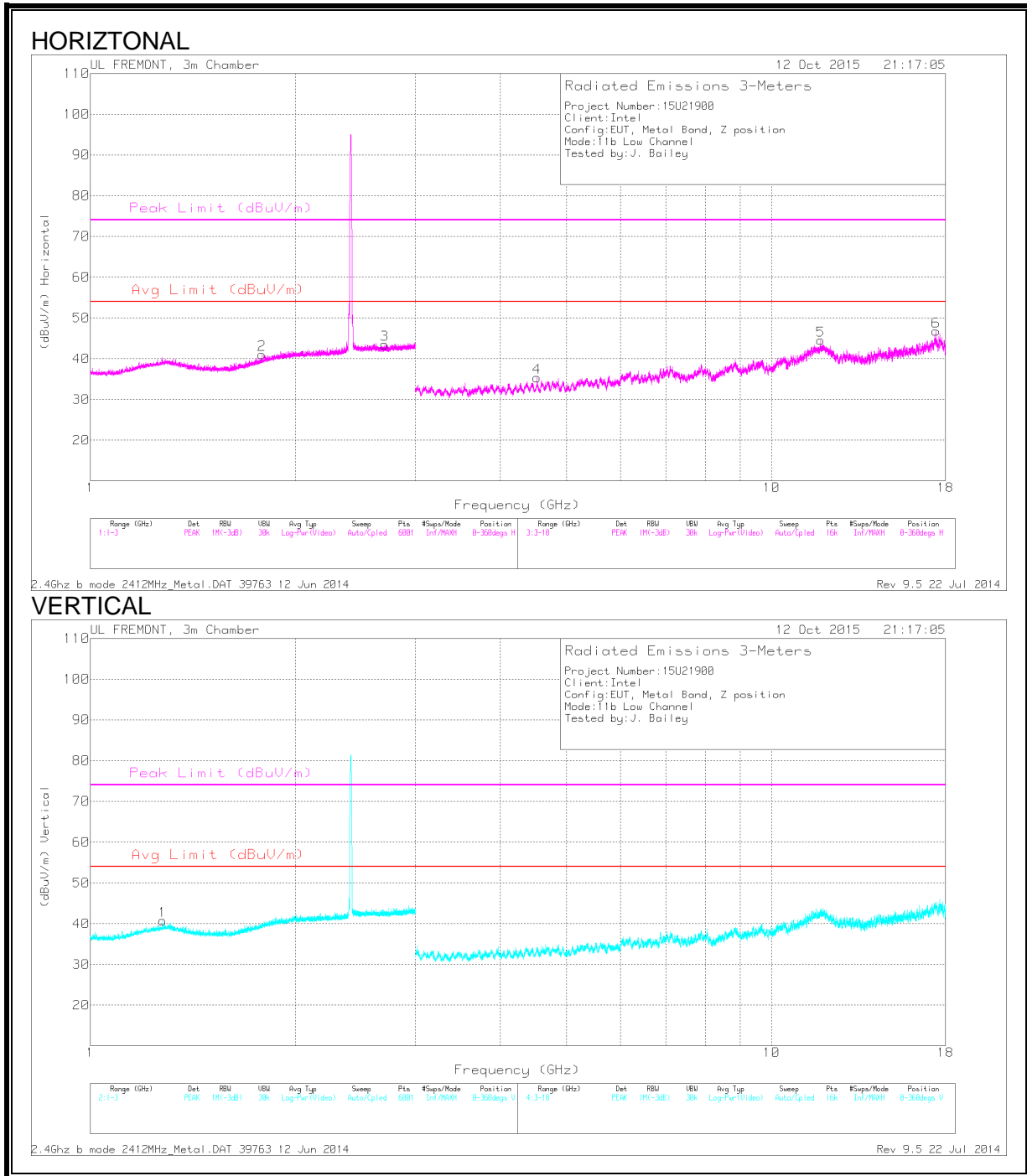

Note: Emission was scanned up to 26GHz; No emissions were detected above the noise floor which was at least 20dB below the specification limit.

DATA

Marker	Frequency (GHz)	Meter Reading (dBuV)	Det	AF T119 (dB/m)	Amp/Cbl/Filtr/Pad (dB)	DC Corr (dB)	Corrected Reading (dBuV/m)	Avg Limit (dBuV/m)	Margin (dB)	Peak Limit (dBuV/m)	PK Margin (dB)	Azimuth (Degs)	Height (cm)	Polarity
1	1.275	31.32	MAv1	29.6	-23.1	0	37.82	54	-16.18	-	-	229	200	V
	1.277	42.65	PK2	29.7	-23.1	0	49.25	-	-	74	-24.75	229	200	V
2	1.785	30.96	MAv1	30	-22.7	0	38.26	54	-15.74	-	-	229	151	H
	1.788	42.31	PK2	30.1	-22.7	0	49.71	-	-	74	-24.29	229	151	H
3	2.703	42.5	PK2	32.3	-22	0	52.8	-	-	74	-21.2	229	177	H
	2.705	30.86	MAv1	32.3	-22.1	0	41.06	54	-12.94	-	-	229	177	H
4	4.524	40.46	PK2	33.8	-30.7	0	43.56	-	-	74	-30.44	229	205	H
	4.525	29.5	MAv1	33.8	-30.7	0	32.6	54	-21.4	-	-	229	205	H
5	11.797	25.77	MAv1	39	-22.4	0	42.37	54	-11.63	-	-	229	200	H
	11.798	36.84	PK2	39	-22.4	0	53.44	-	-	74	-20.56	229	200	H
6	17.43	36.3	PK2	41.4	-21.9	0	55.8	-	-	74	-18.2	229	175	H
	17.43	24.85	MAv1	41.4	-21.9	0	44.35	54	-9.65	-	-	229	175	H

PK2 - KDB558074 Method: Maximum Peak

MAv1 - KDB558074 Option 1 Maximum RMS Average

MID CHANNEL

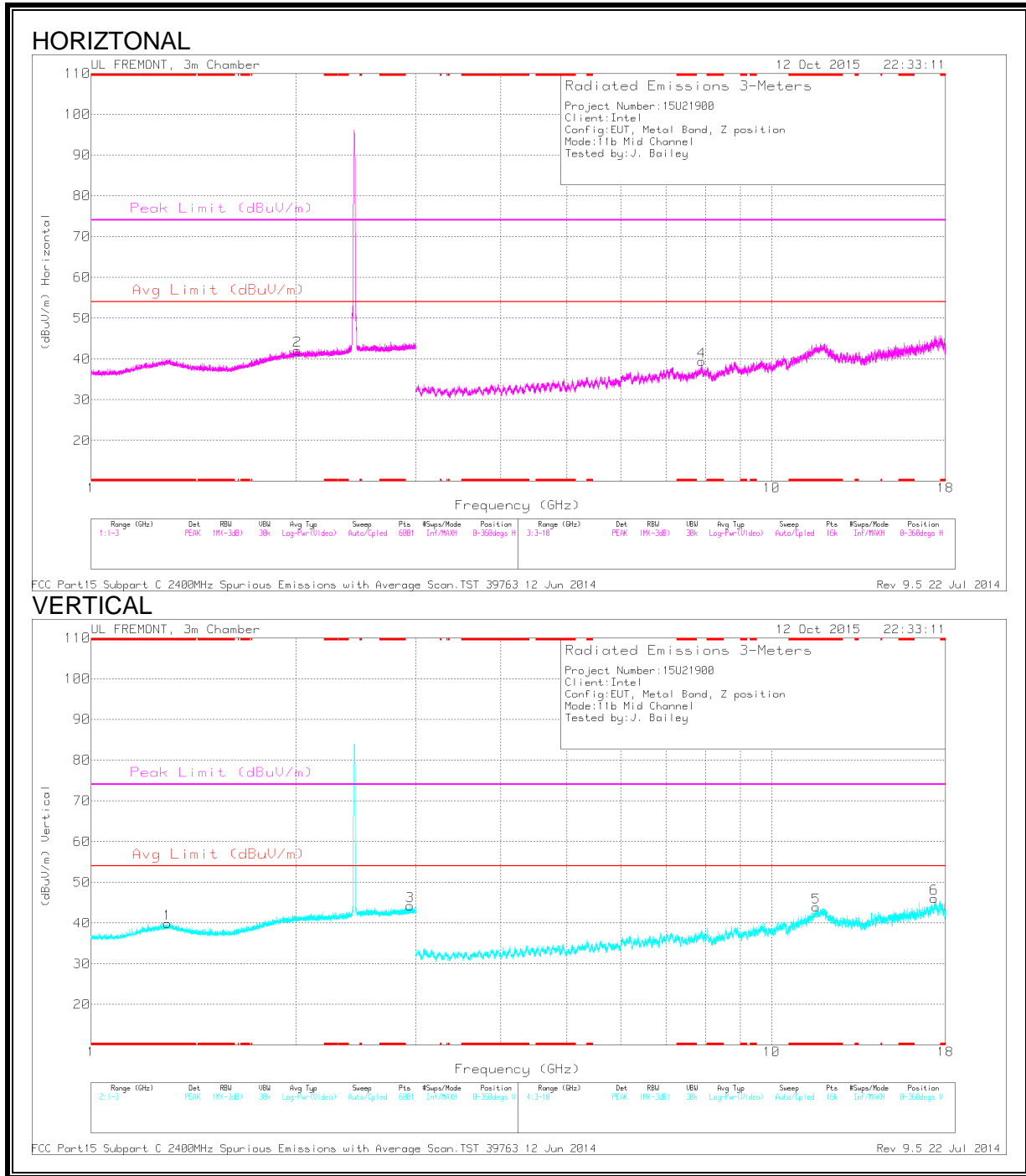

Note: Emission was scanned up to 26GHz; No emissions were detected above the noise floor which was at least 20dB below the specification limit.

DATA

Marker	Frequency (GHz)	Meter Reading (dBuV)	Det	AF T119 (dB/m)	Amp/Cbl/Filtr/Pad (dB)	DC Corr (dB)	Corrected Reading (dBuV/m)	Avg Limit (dBuV/m)	Margin (dB)	Peak Limit (dBuV/m)	PK Margin (dB)	Azimuth (Degs)	Height (cm)	Polarity
1	* 1.299	42.47	PK2	29.9	-23.2	0	49.17	-	-	74	-24.83	158	171	V
	* 1.301	30.54	MAv1	29.9	-23.2	0	37.24	54	-16.76	-	-	158	171	V
5	* 11.623	36.46	PK2	38.7	-22.3	0	52.86	-	-	74	-21.14	58	318	V
	* 11.622	24.55	MAv1	38.7	-22.3	0	40.95	54	-13.05	-	-	58	318	V
2	2.011	42.2	PK2	31.5	-22.5	0	51.2	-	-	74	-24.83	58	172	H
	2.011	30.85	MAv1	31.5	-22.5	0	39.85	54	-14.15	-	-	58	172	H
3	2.941	42.47	PK2	32.6	-21.9	0	53.17	-	-	74	-20.83	58	204	V
	2.943	30.62	MAv1	32.6	-21.9	0	41.32	54	-12.68	-	-	58	2040	V
4	7.888	37.88	PK2	35.8	-26	0	47.68	-	-	74	-26.32	58	165	H
	7.892	26.36	MAv1	35.8	-26	0	36.16	54	-17.84	-	-	58	165	H
6	17.337	36.54	PK2	41.4	-22.8	0	55.14	-	-	74	-18.86	58	175	V
	17.337	25.24	MAv1	41.4	-22.8	0	43.84	54	-10.16	-	-	58	175	V

* - indicates frequency in CFR15.205/IC7.2.2 Restricted Band

PK2 - KDB558074 Method: Maximum Peak

MAv1 - KDB558074 Option 1 Maximum RMS Average

HIGH CHANNEL

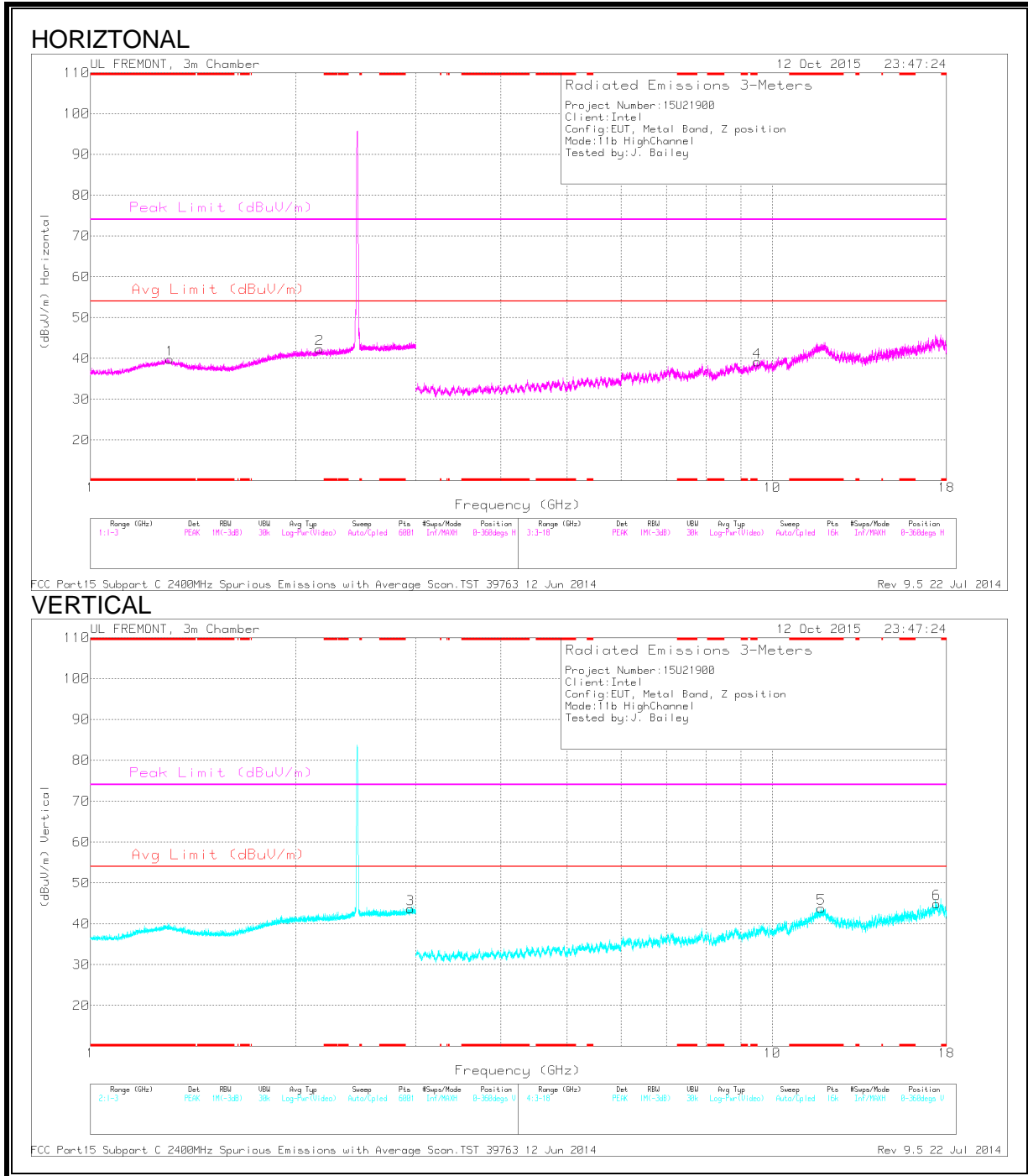

Note: Emission was scanned up to 26GHz; No emissions were detected above the noise floor which was at least 20dB below the specification limit.

DATA

Marker	Frequenc y (GHz)	Meter Reading (dBuV)	Det	AF T119 (dB/m)	Amp/Cbl/ Filtr/Pad (dB)	DC Corr (dB)	Corrected Reading (dBuV/m)	Avg Limit (dBuV/m)	Margin (dB)	Peak Limit (dBuV/m)	PK Margin (dB)	Azimuth (Degs)	Height (cm)	Polarity
1	* 1.296	42.65	PK2	29.9	-23.2	0	49.35	-	-	74	-24.65	342	153	H
	* 1.296	30.52	MAv1	29.8	-23.2	0	37.12	54	-16.88	-	-	342	153	H
5	* 11.794	37.96	PK2	39	-22.4	0	54.56	-	-	74	-19.44	3	230	V
	* 11.794	25.1	MAv1	39	-22.4	0	41.7	54	-12.3	-	-	3	230	V
2	2.168	30.5	MAv1	31.4	-22.2	0	39.7	54	-14.3	-	-	3	200	H
	2.169	42.29	PK2	31.4	-22.2	0	51.49	-	-	74	-22.51	3	200	H
3	2.945	42.21	PK2	32.7	-21.9	0	53.01	-	-	74	-20.99	3	165	V
	2.946	30.61	MAv1	32.7	-21.9	0	41.41	54	-12.59	-	-	3	165	V
4	9.504	24.88	MAv1	36.6	-24.8	0	36.68	54	-17.32	-	-	3	200	H
	9.505	36.12	PK2	36.6	-24.8	0	47.92	-	-	74	-26.08	3	200	H
6	17.425	35.52	PK2	41.4	-21.8	0	55.12	-	-	74	-18.88	3	155	V
	17.426	24.1	MAv1	41.4	-21.8	0	43.7	54	-10.3	-	-	3	155	V

* - indicates frequency in CFR15.205/IC7.2.2 Restricted Band

PK2 - KDB558074 Method: Maximum Peak

MAv1 - KDB558074 Option 1 Maximum RMS Average

CHANNEL 13

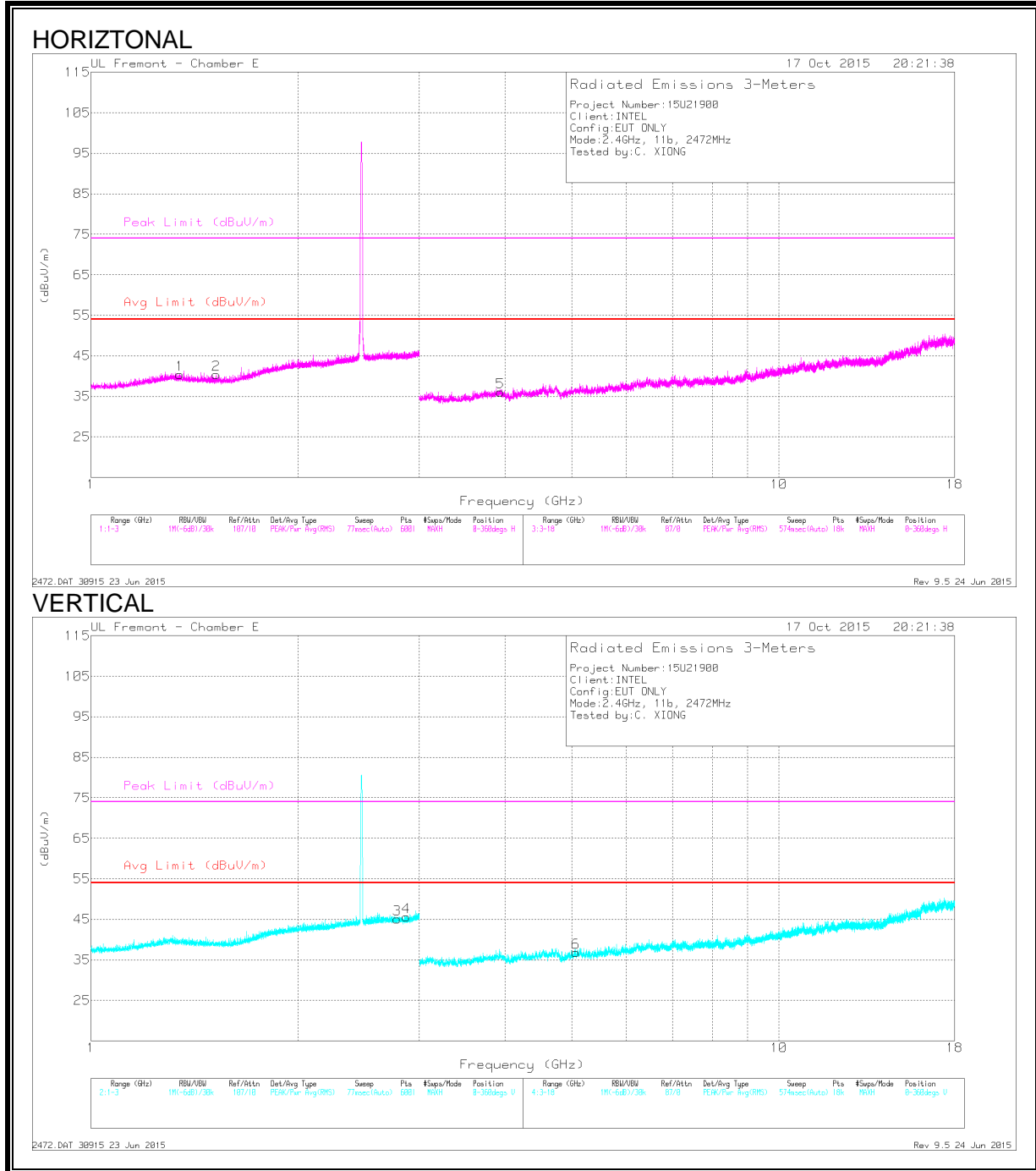

Note: Emission was scanned up to 26GHz; No emissions were detected above the noise floor which was at least 20dB below the specification limit.

DATA

Marker	Frequency (GHz)	Meter Reading (dBuV)	Det	AF T346 (dB/m)	Amp/Cbl/ Fitr/Pad (dB)	Corrected Reading (dBuV/m)	Avg Limit (dBuV/m)	Margin (dB)	Peak Limit (dBuV/m)	PK Margin (dB)	Azimuth (Degs)	Height (cm)	Polarity
1	* 1.346	45.02	PK2	28.8	-25.6	48.22	-	-	74	-25.78	360	168	H
	* 1.347	33.49	MAv1	28.8	-25.6	36.69	54	-17.31	-	-	360	168	H
2	* 1.52	45.59	PK2	28.2	-25.1	48.69	-	-	74	-25.31	360	155	H
	* 1.519	33.24	MAv1	28.2	-25.1	36.34	54	-17.66	-	-	360	155	H
3	* 2.788	43.37	PK2	32.4	-22.4	53.37	-	-	74	-20.63	360	205	V
	* 2.787	31.85	MAv1	32.4	-22.4	41.85	54	-12.15	-	-	360	205	V
4	* 2.875	44.18	PK2	32.5	-22.3	54.38	-	-	74	-19.62	360	176	V
	* 2.875	31.76	MAv1	32.5	-22.3	41.96	54	-12.04	-	-	360	176	V
5	* 3.94	41.66	PK2	33.5	-29.6	45.56	-	-	74	-28.44	360	212	H
	* 3.94	29.9	MAv1	33.5	-29.6	33.8	54	-20.2	-	-	360	212	H
6	* 5.07	41.13	PK2	34.2	-29.8	45.53	-	-	74	-28.47	360	230	V
	* 5.07	29.63	MAv1	34.2	-29.8	34.03	54	-19.97	-	-	360	230	V

* - indicates frequency in CFR15.205/IC7.2.2 Restricted Band

PK2 - KDB558074 Method: Maximum Peak

MAv1 - KDB558074 Option 1 Maximum RMS Average

9.2.2. TX ABOVE 1 GHz 802.11g MODE IN THE 2.4 GHz BAND

RESTRICTED BANDEDGE (LOW CHANNEL)

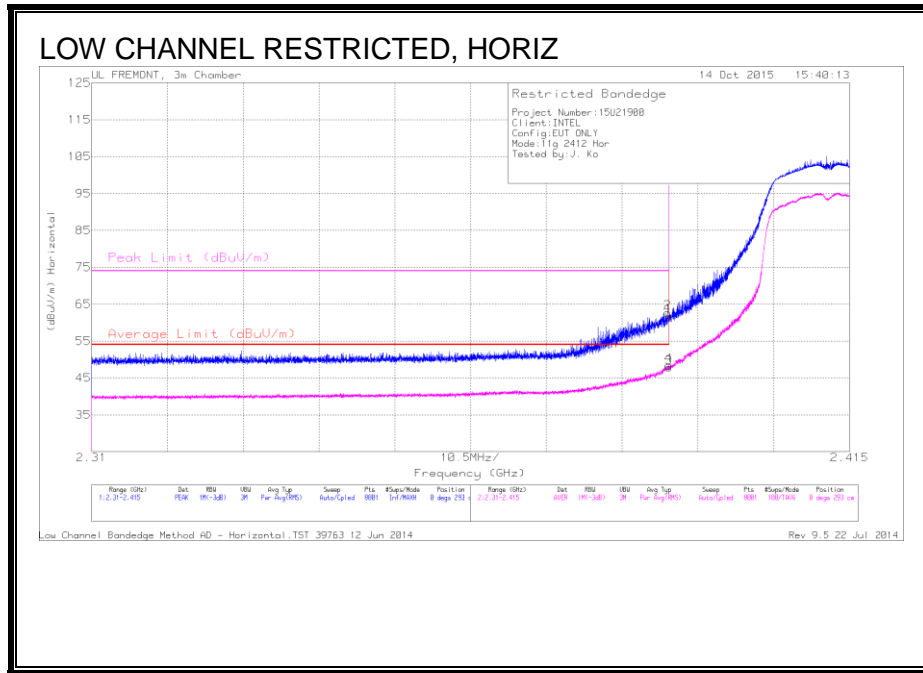

Marker	Frequency (GHz)	Meter Reading (dBuV)	Det	AF T119 (dB/m)	Amp/Cbl/Fit r/Pad (dB)	DC Corr (dB)	Corrected Reading (dBuV/m)	Average Limit (dBuV/m)	Margin (dB)	Peak Limit (dBuV/m)	PK Margin (dB)	Azimuth (Degs)	Height (cm)	Polarity
1	2.39	52.08	PK	32	-22.4	0	61.68	-	-	74	-12.32	0	293	H
2	2.39	53.11	PK	32	-22.4	0	62.71	-	-	74	-11.29	0	293	H
3	2.39	37.94	RMS	32	-22.4	.31	47.85	54	-6.15	-	-	0	293	H
4	2.39	38.43	RMS	32	-22.4	.31	48.34	54	-5.66	-	-	0	293	H

PK - Peak detector

RMS - RMS detection

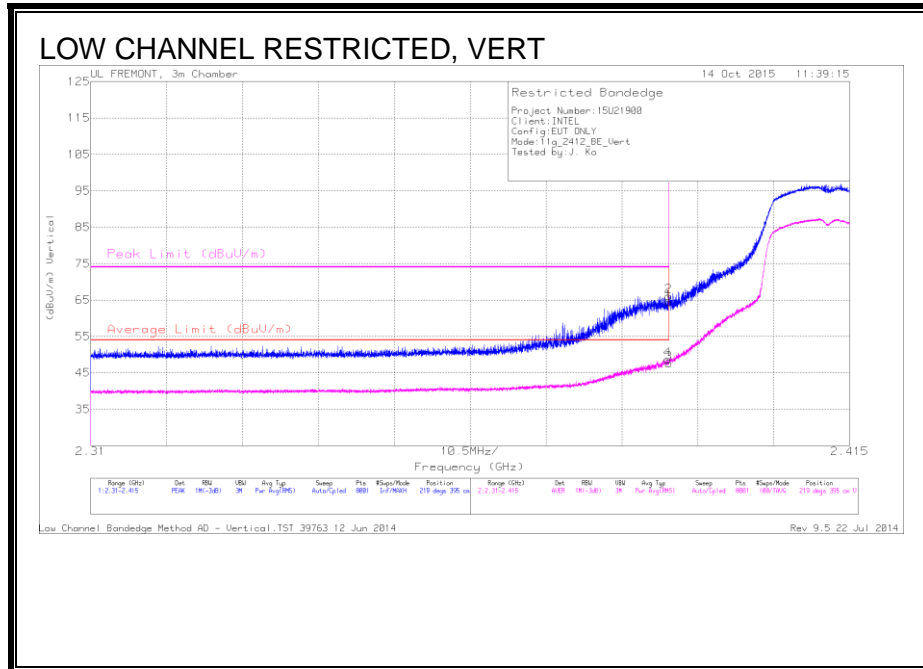

Marker	Frequency (GHz)	Meter Reading (dBuV)	Det	AF T119 (dB/m)	Amp/Cb/Filter/Pad (dB)	DC Corr (dB)	Corrected Reading (dBuV/m)	Average Limit (dBuV/m)	Margin (dB)	Peak Limit (dBuV/m)	PK Margin (dB)	Azimuth (Degs)	Height (cm)	Polarity
1	2.39	54.88	PK	32	-22.4	0	64.48	-	-	74	-9.52	219	395	V
2	2.39	56.5	PK	32	-22.4	0	66.1	-	-	74	-7.9	219	395	V
3	2.39	37.65	RMS	32	-22.4	.31	47.56	54	-6.44	-	-	219	395	V
4	2.39	38.77	RMS	32	-22.4	.31	48.68	54	-5.32	-	-	219	395	V

PK - Peak detector

RMS - RMS detection

AUTHORIZED BANDEDGE (HIGH CHANNEL)

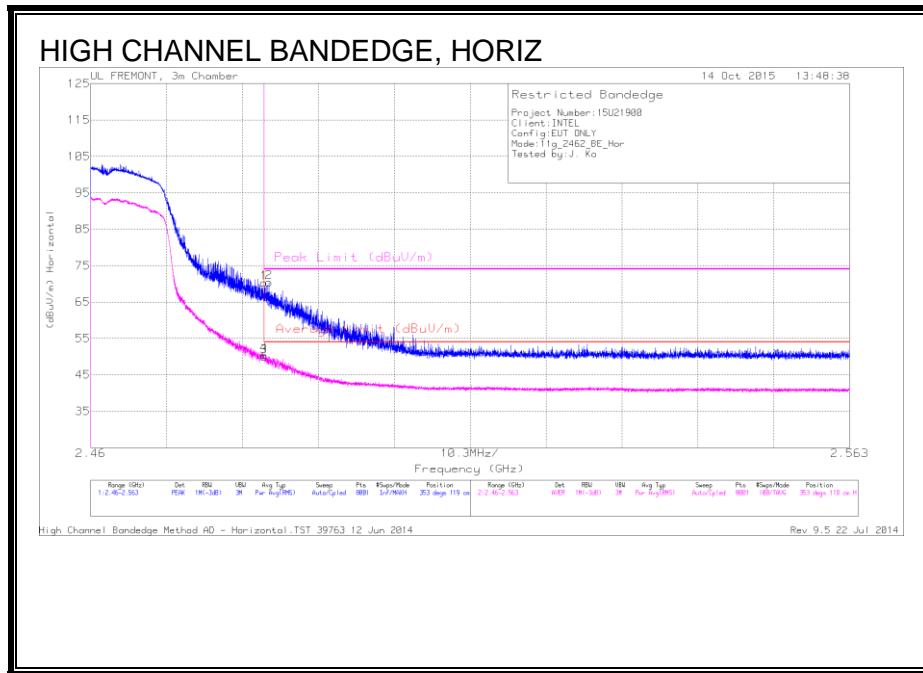

Marker	Frequency (GHz)	Meter Reading (dBuV)	Det	AF T119 (dB/m)	Amp/Cb/Fitter/Pad (dB)	DC Corr (dB)	Corrected Reading (dBuV/m)	Average Limit (dBuV/m)	Margin (dB)	Peak Limit (dBuV/m)	PK Margin (dB)	Azimuth (Degs)	Height (cm)	Polarity
1	2.484	60.12	PK	32.3	-22.1	0	70.32	-	-	74	-3.68	353	119	H
2	2.484	60.23	PK	32.3	-22.1	0	70.43	-	-	74	-3.57	353	119	H
3	2.484	39.53	RMS	32.3	-22.1	.31	50.04	54	-3.96	-	-	353	119	H
4	2.484	39.94	RMS	32.3	-22.1	.31	50.45	54	-3.55	-	-	353	119	H

PK - Peak detector

RMS - RMS detection

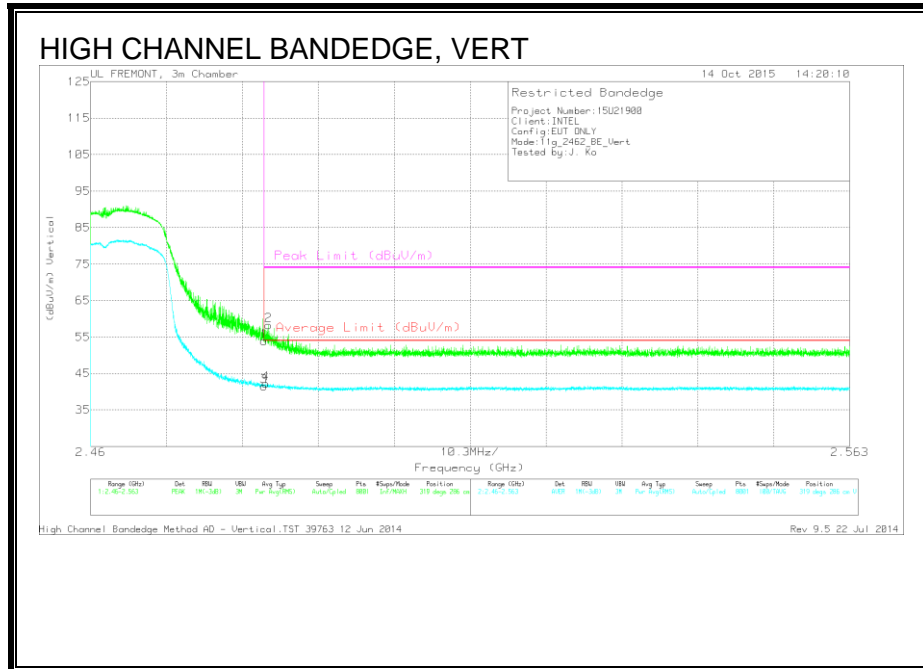

Marker	Frequency (GHz)	Meter Reading (dBuV)	Det	AF T119 (dB/m)	Amp/Cb/Filter/Pad (dB)	DC Corr (dB)	Corrected Reading (dBuV/m)	Average Limit (dBuV/m)	Margin (dB)	Peak Limit (dBuV/m)	PK Margin (dB)	Azimuth (Degs)	Height (cm)	Polarity
1	2.484	43.67	PK	32.3	-22.1	0	53.87	-	-	74	-20.13	319	286	V
2	2.484	48.09	PK	32.3	-22.1	0	58.29	-	-	74	-15.71	319	286	V
3	2.484	30.95	RMS	32.3	-22.1	.31	41.46	54	-12.54	-	-	319	286	V
4	2.484	31.68	RMS	32.3	-22.1	.31	42.19	54	-11.81	-	-	319	286	V

PK - Peak detector

RMS - RMS detection

AUTHORIZED BANDEDGE (CHANNEL 12)

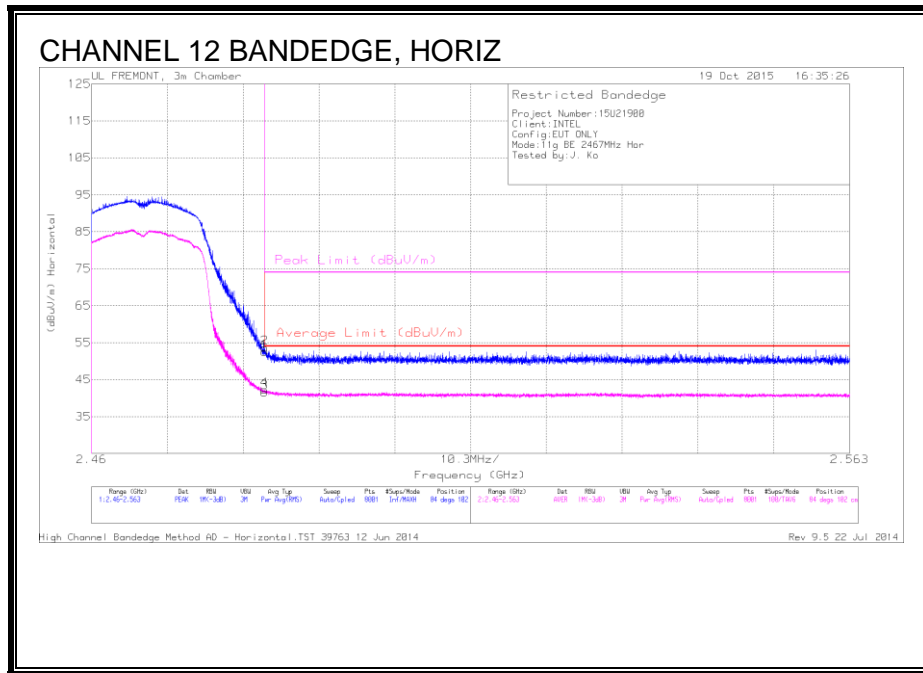

Marker	Frequency (GHz)	Meter Reading (dBuV)	Det	AF T119 (dB/m)	Amp/Cb/Fitter/Pad (dB)	DC Corr (dB)	Corrected Reading (dBuV/m)	Average Limit (dBuV/m)	Margin (dB)	Peak Limit (dBuV/m)	PK Margin (dB)	Azimuth (Degs)	Height (cm)	Polarity
1	2.484	42.3	PK	32.3	-22.1	0	52.5	-	-	74	-21.5	84	102	H
2	2.484	43.42	PK	32.3	-22.1	0	53.62	-	-	74	-20.38	84	102	H
3	2.484	31.06	RMS	32.3	-22.1	.31	41.57	54	-12.43	-	-	84	102	H
4	2.484	31.74	RMS	32.3	-22.1	.31	42.25	54	-11.75	-	-	84	102	H

PK - Peak detector

RMS - RMS detection

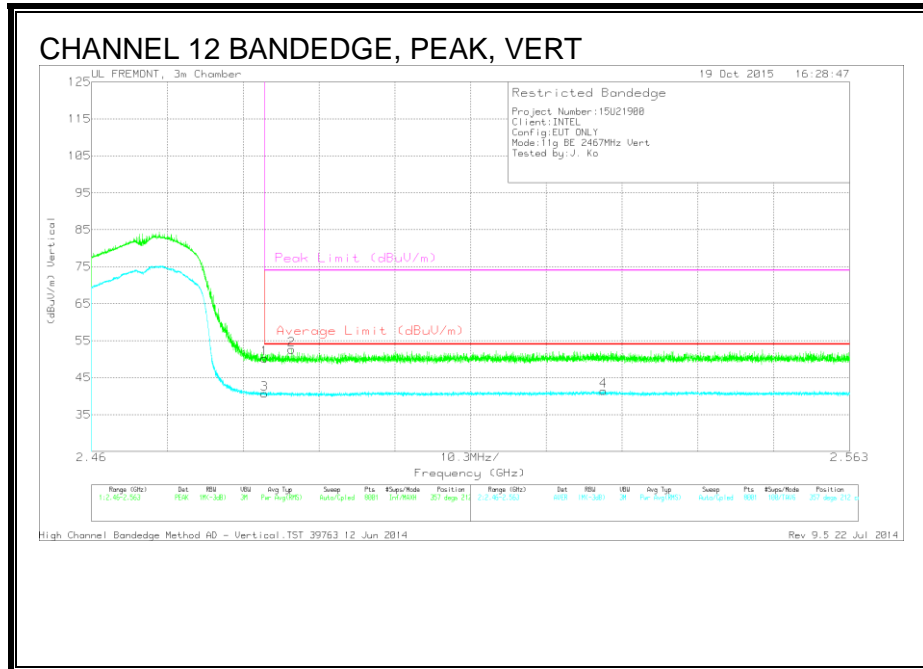

Marker	Frequency (GHz)	Meter Reading (dBuV)	Det	AF T119 (dB/m)	Amp/Cb/Fitter/Pad (dB)	DC Corr (dB)	Corrected Reading (dBuV/m)	Average Limit (dBuV/m)	Margin (dB)	Peak Limit (dBuV/m)	PK Margin (dB)	Azimuth (Degs)	Height (cm)	Polarity
1	2.484	40.03	PK	32.3	-22.1	0	50.23	-	-	74	-23.77	357	212	V
3	2.484	30.14	RMS	32.3	-22.1	.31	40.65	54	-13.35	-	-	357	212	V
2	2.487	42.51	PK	32.3	-22.2	0	52.61	-	-	74	-21.39	357	212	V
4	2.53	30.74	RMS	32.4	-22	.31	41.45	54	-12.55	-	-	357	212	V

PK - Peak detector

RMS - RMS detection

AUTHORIZED BANDEDGE (CHANNEL 13)

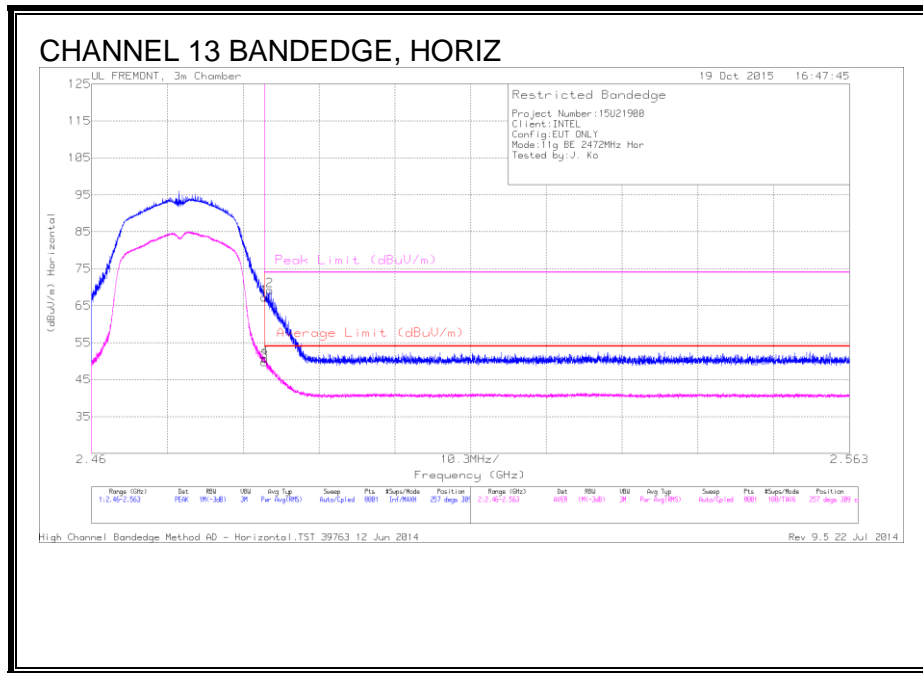

Marker	Frequency (GHz)	Meter Reading (dBuV)	Det	AF T119 (dB/m)	Amp/Cb/Fit r/Pad (dB)	DC Corr (dB)	Corrected Reading (dBuV/m)	Average Limit (dBuV/m)	Margin (dB)	Peak Limit (dBuV/m)	PK Margin (dB)	Azimuth (Degs)	Height (cm)	Polarity
1	2.484	57.07	PK	32.3	-22.1	0	67.27	-	-	74	-6.73	257	309	H
2	2.484	58.96	PK	32.3	-22.1	0	69.16	-	-	74	-4.84	257	309	H
3	2.484	39.27	RMS	32.3	-22.1	.31	49.78	54	-4.22	-	-	257	309	H
4	2.484	40.19	RMS	32.3	-22.1	.31	50.7	54	-3.3	-	-	257	309	H

PK - Peak detector

RMS - RMS detection

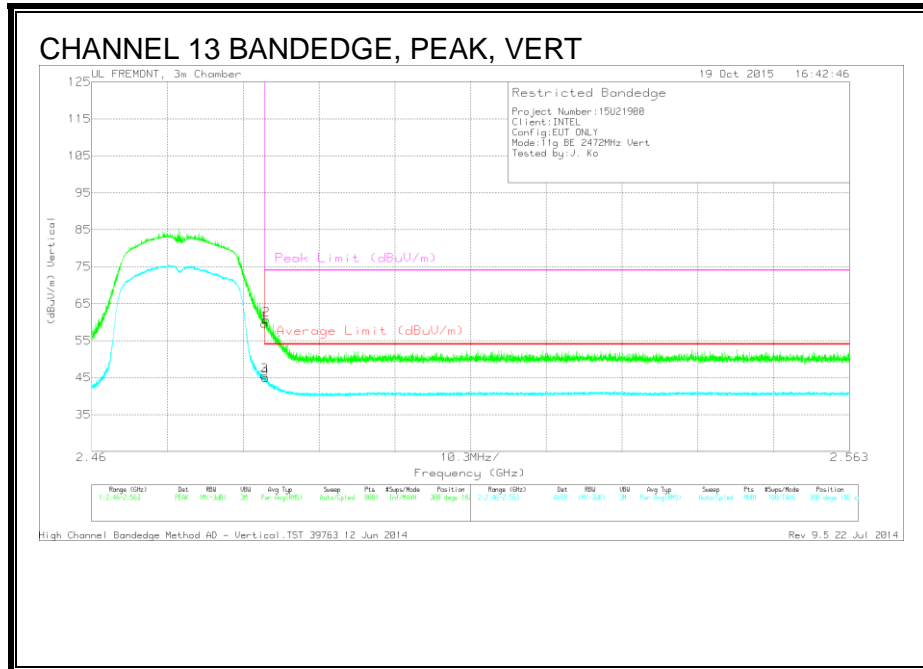

Marker	Frequency (GHz)	Meter Reading (dBuV)	Det	AF T119 (dB/m)	Amp/Cb/Fitter/Pad (dB)	DC Corr (dB)	Corrected Reading (dBuV/m)	Average Limit (dBuV/m)	Margin (dB)	Peak Limit (dBuV/m)	PK Margin (dB)	Azimuth (Degs)	Height (cm)	Polarity
1	2.484	49.46	PK	32.3	-22.1	0	59.66	-	-	74	-14.34	300	182	V
2	2.484	50.53	PK	32.3	-22.1	0	60.73	-	-	74	-13.27	300	182	V
3	2.484	35.03	RMS	32.3	-22.1	.31	45.54	54	-8.46	-	-	300	182	V
4	2.484	34.45	RMS	32.3	-22.1	.31	44.96	54	-9.04	-	-	300	182	V

PK - Peak detector

RMS - RMS detection

HARMONICS AND SPURIOUS EMISSIONS

LOW CHANNEL

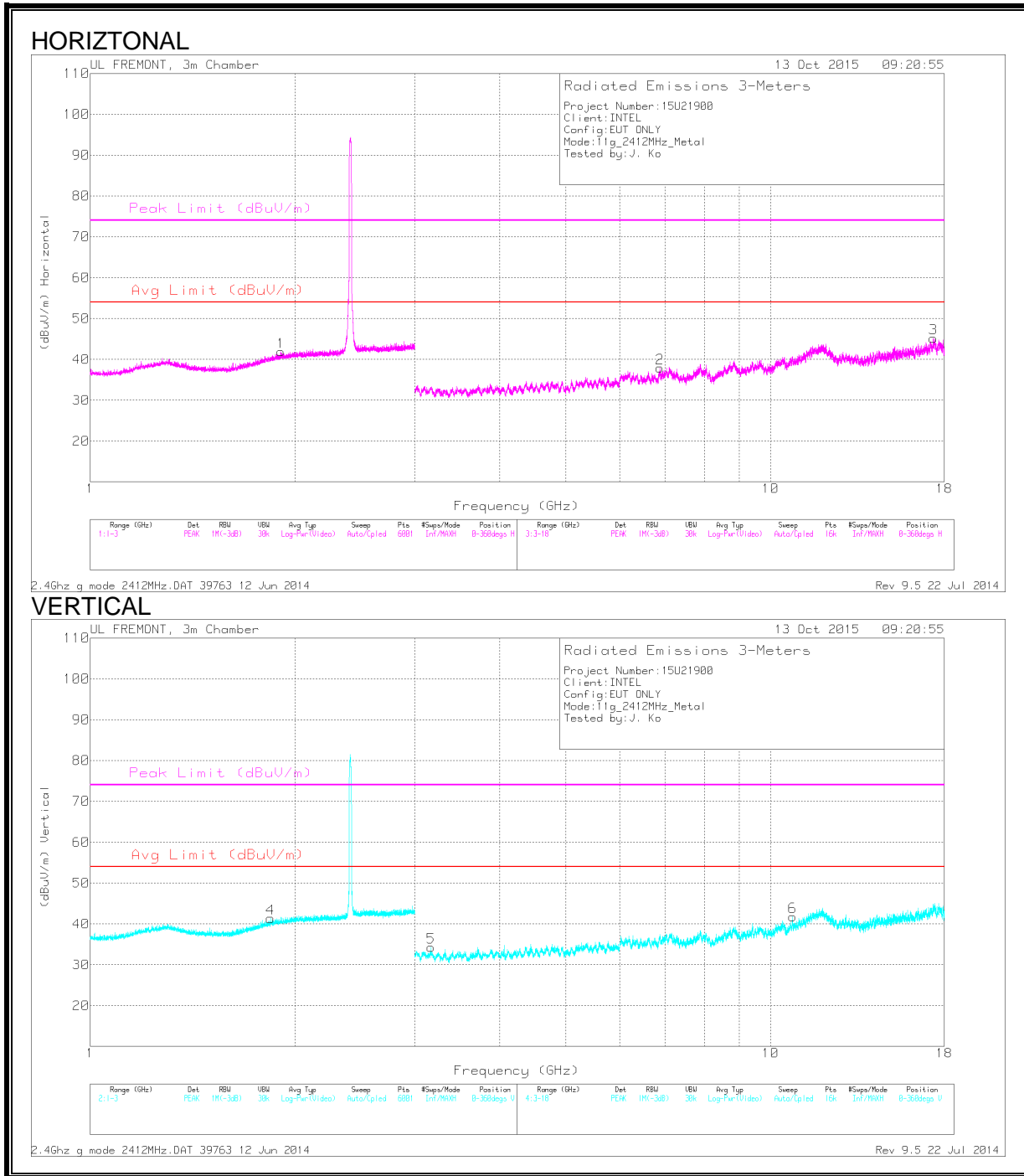

Note: Emission was scanned up to 26GHz; No emissions were detected above the noise floor which was at least 20dB below the specification limit.

DATA

Marker	Frequenc y (GHz)	Meter Reading (dBuV)	Det	AF T119 (dB/m)	Amp/Cbl/ Fitr/Pad (dB)	DC Corr (dB)	Corrected Reading (dBuV/m)	Avg Limit (dBuV/m)	Margin (dB)	Peak Limit (dBuV/m)	PK Margin (dB)	Azimuth (Degs)	Height (cm)	Polarity
4	1.839	30.78	MAv1	30.6	-22.6	.31	39.09	54	-14.91	-	-	1	205	V
	1.842	42.06	PK2	30.6	-22.6	0	50.06	-	-	74	-23.94	1	205	V
1	1.907	30.78	MAv1	31.1	-22.5	.31	39.69	54	-14.31	-	-	1	210	H
	1.908	42.72	PK2	31.1	-22.5	0	51.32	-	-	74	-22.68	1	210	H
5	3.169	41.31	PK2	32.7	-30.4	0	43.61	-	-	74	-30.39	1	160	V
	3.169	29.46	MAv1	32.7	-30.3	.31	32.17	54	-21.83	-	-	1	160	V
2	6.871	33.01	PK2	35.6	-27.3	0	41.31	-	-	74	-32.69	1	200	H
	6.871	27.48	MAv1	35.6	-27.3	.31	36.09	54	-17.91	-	-	1	200	H
6	10.771	24.51	MAv1	37.9	-23.1	.31	39.62	54	-14.38	-	-	0	183	V
	10.772	35.68	PK2	37.9	-23.2	0	50.38	-	-	74	-23.62	0	183	V
3	17.343	24.7	MAv1	41.4	-22.7	.31	43.71	54	-10.29	-	-	1	206	H
	17.346	36.69	PK2	41.4	-22.5	0	55.59	-	-	74	-18.41	1	206	H

PK - Peak detector

PK2 - KDB558074 Method: Maximum Peak

MAv1 - KDB558074 Option 1 Maximum RMS Average

MID CHANNEL

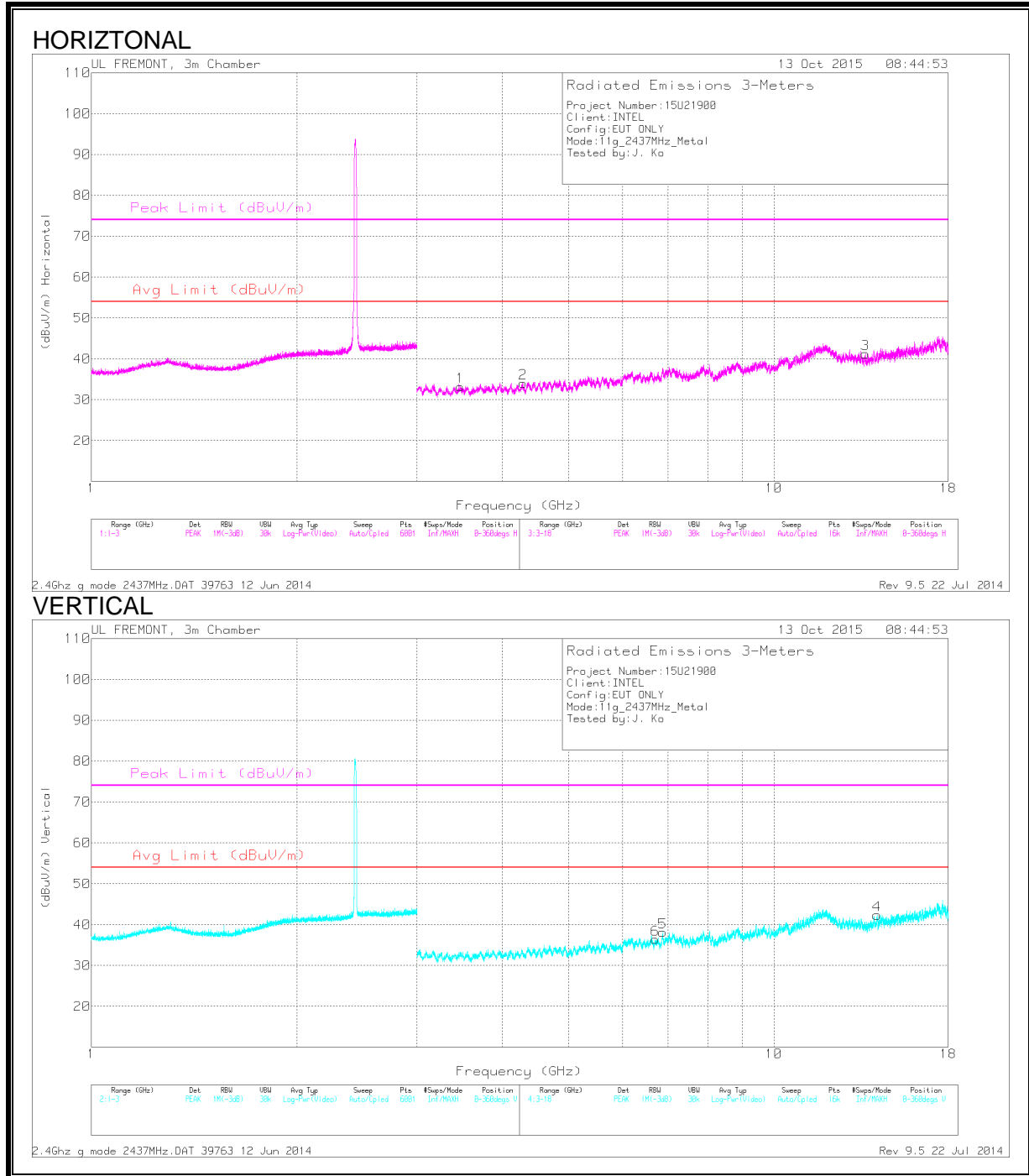

Note: Emission was scanned up to 26GHz; No emissions were detected above the noise floor which was at least 20dB below the specification limit.

DATA

Marker	Frequency (GHz)	Meter Reading (dBuV)	Det	AF T119 (dB/m)	Amp/Cbl/Filtr/Pad (dB)	DC Corr (dB)	Corrected Reading (dBuV/m)	Avg Limit (dBuV/m)	Margin (dB)	Peak Limit (dBuV/m)	PK Margin (dB)	Azimuth (Degs)	Height (cm)	Polarity
1	3.47	40.59	PK2	32.8	-30.5	0	42.89	-	-	74	-31.11	1	165	H
	3.473	29.15	MAv1	32.8	-30.5	.31	31.76	54	-22.24	-	-	1	165	H
2	4.289	28.75	MAv1	33.5	-30.5	.31	32.06	54	-21.94	-	-	1	221	H
	4.29	40.18	PK2	33.5	-30.5	0	43.18	-	-	74	-30.82	1	221	H
6	6.701	40.82	PK2	35.6	-29.2	0	47.22	-	-	74	-49.02	1	200	V
	6.701	28.57	MAv1	35.6	-29.2	.31	35.28	54	-18.72	-	-	1	200	V
5	6.869	27.39	MAv1	35.6	-27.3	.31	36	54	-18.00	-	-	1	164	V
	6.873	38.96	PK2	35.6	-27.2	0	47.36	-	-	74	-26.64	1	164	V
3	13.608	37.32	PK2	38.7	-26.5	0	49.52	-	-	74	-24.48	1	200	H
	13.609	25.84	MAv1	38.7	-26.5	.31	38.35	54	-15.65	-	-	1	200	H
4	14.156	27.23	MAv1	39	-25.9	.31	40.64	54	-13.36	-	-	1	221	V
	14.157	38.42	PK2	39.1	-25.9	0	51.62	-	-	74	-22.38	1	221	V

PK - Peak detector

PK2 - KDB558074 Method: Maximum Peak

MAv1 - KDB558074 Option 1 Maximum RMS Average

HIGH CHANNEL

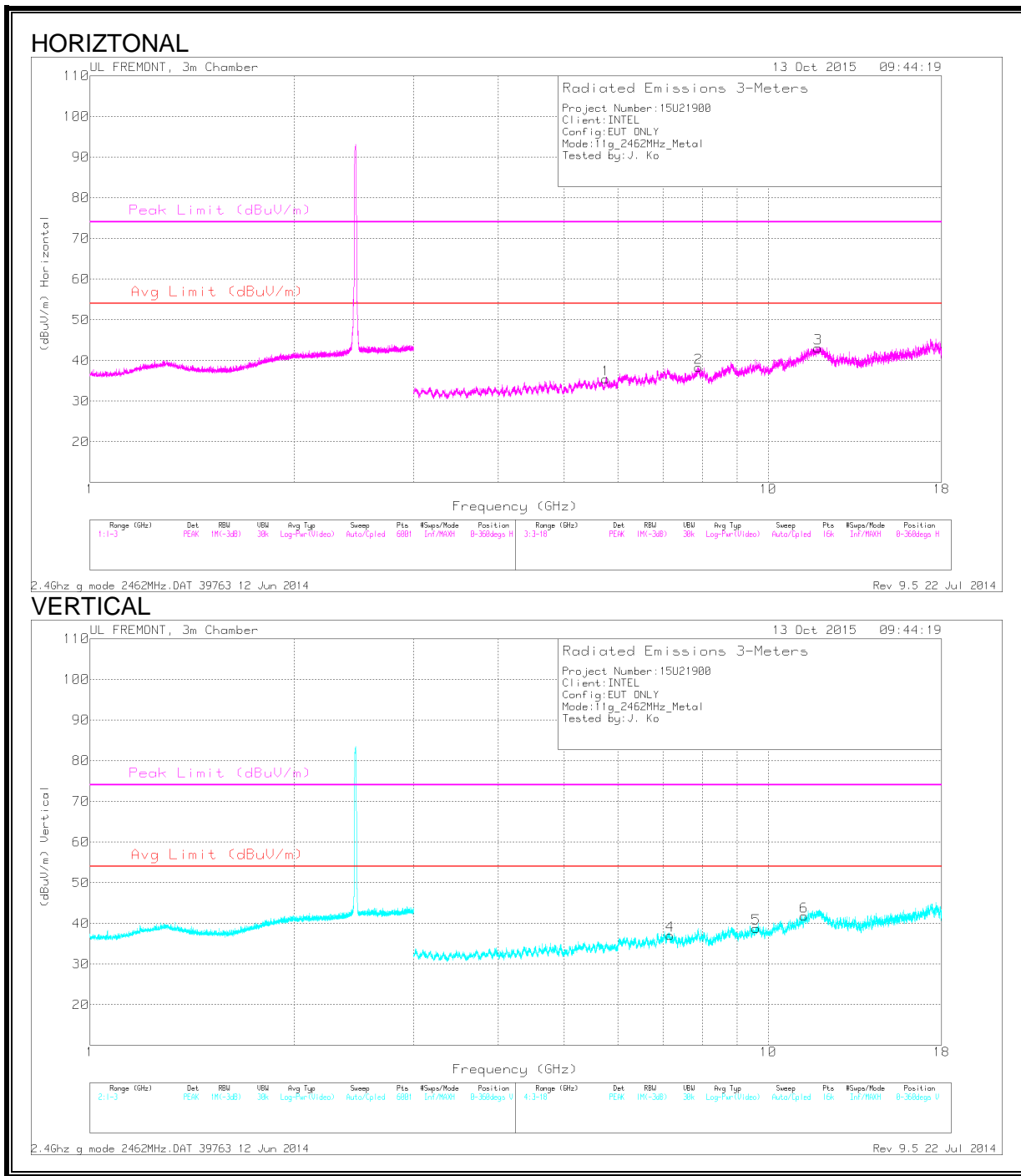

Note: Emission was scanned up to 26GHz; No emissions were detected above the noise floor which was at least 20dB below the specification limit.

DATA

Marker	Frequency (GHz)	Meter Reading (dBuV)	Det	AF T119 (dB/m)	Amp/Cbl/Filtr/Pad (dB)	DC Corr (dB)	Corrected Reading (dBuV/m)	Avg Limit (dBuV/m)	Margin (dB)	Peak Limit (dBuV/m)	PK Margin (dB)	Azimuth (Degs)	Height (cm)	Polarity
1	5.753	28.64	MAv1	34.8	-29.7	.31	34.05	54	-19.95	-	-	1	178	H
	5.754	39.78	PK2	34.8	-29.7	0	44.88	-	-	74	-29.12	1	178	H
4	7.162	37.5	PK2	35.6	-27	0	46.1	-	-	74	-27.9	1	200	V
	7.164	26.09	MAv1	35.6	-27.1	.31	34.9	54	-19.1	-	-	1	200	V
2	7.889	37.16	PK2	35.8	-26	0	46.96	-	-	74	-27.04	1	158	H
	7.889	26.23	MAv1	35.8	-26	.31	36.34	54	-17.66	-	-	1	158	H
5	9.594	35.7	PK2	36.7	-24.4	0	48	-	-	74	-26.00	1	216	V
	9.595	24.24	MAv1	36.7	-24.4	.31	36.85	54	-17.15	-	-	1	216	V
6	11.289	36.36	PK2	38	-22.4	0	51.96	-	-	74	-22.04	1	200	V
	11.29	24.4	MAv1	38	-22.4	.31	40.31	54	-13.69	-	-	1	200	V
3	11.833	36.49	PK2	39	-22.9	0	52.59	-	-	74	-21.41	1	233	H
	11.833	25.12	MAv1	39	-22.9	.31	41.53	54	-12.47	-	-	1	233	H

PK - Peak detector

PK2 - KDB558074 Method: Maximum Peak

MAv1 - KDB558074 Option 1 Maximum RMS Average

CHANNEL 12

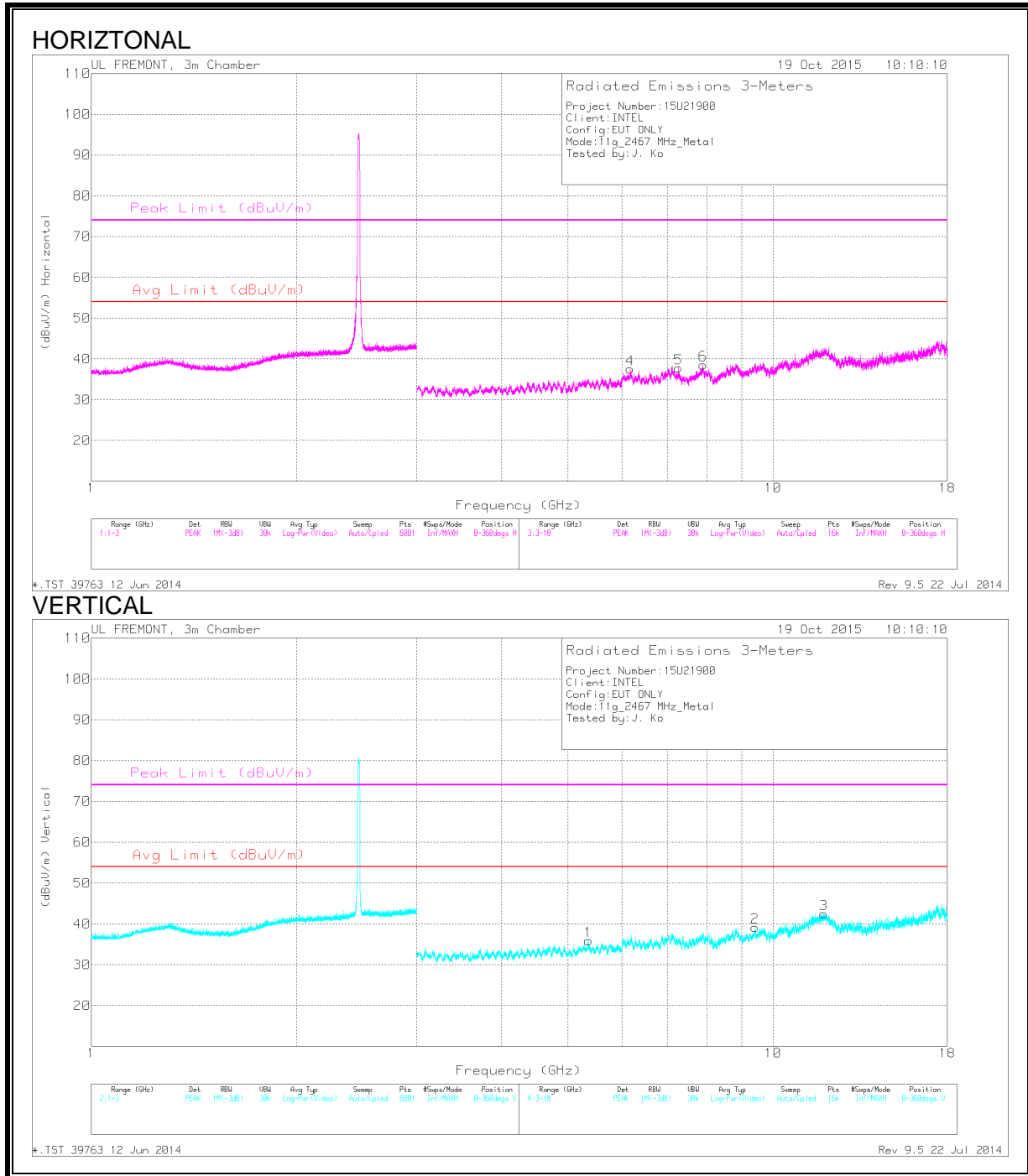

Note: Emission was scanned up to 26GHz; No emissions were detected above the noise floor which was at least 20dB below the specification limit.

DATA

Marker	Frequency (GHz)	Meter Reading (dBuV)	Det	AF T119 (dB/m)	Amp/Cbl/Filtr/Pad (dB)	DC Corr (dB)	Corrected Reading (dBuV/m)	Avg Limit (dBuV/m)	Margin (dB)	Peak Limit (dBuV/m)	PK Margin (dB)	Azimuth (Degs)	Height (cm)	Polarity
1	5.362	40.27	PK2	34.5	-29.3	0	45.47	-	-	74	-28.53	0	156	V
	5.363	28.28	MAv1	34.5	-29.3	.31	33.79	54	-20.21	-	-	0	156	V
4	6.169	27.69	MAv1	35.3	-29.1	.31	34.2	54	-19.8	-	-	0	186	H
	6.17	39.11	PK2	35.3	-29.1	0	45.31	-	-	74	-28.69	0	186	H
6	7.264	27.12	MAv1	35.6	-28.4	.31	34.63	54	-19.37	-	-	0	200	H
	7.265	38.34	PK2	35.6	-28.4	0	45.54	-	-	74	-28.46	0	200	H
6	7.89	37.72	PK2	35.8	-26	0	47.52	-	-	74	-26.48	0	195	H
	7.89	25.69	MAv1	35.8	-26	.31	35.8	54	-18.2	-	-	0	195	H
2	9.408	36.12	PK2	36.4	-24.1	0	48.42	-	-	74	-25.58	0	203	V
	9.409	24.43	MAv1	36.4	-24.1	.31	37.04	54	-16.96	-	-	0	203	V
3	11.873	36.25	PK2	39.1	-22.6	0	52.75	-	-	74	-21.25	0	175	V
	11.874	23.87	MAv1	39.1	-22.6	.31	40.68	54	-13.32	-	-	0	175	V

PK2 - KDB558074 Method: Maximum Peak

MAv1 - KDB558074 Option 1 Maximum RMS Average

CHANNEL 13

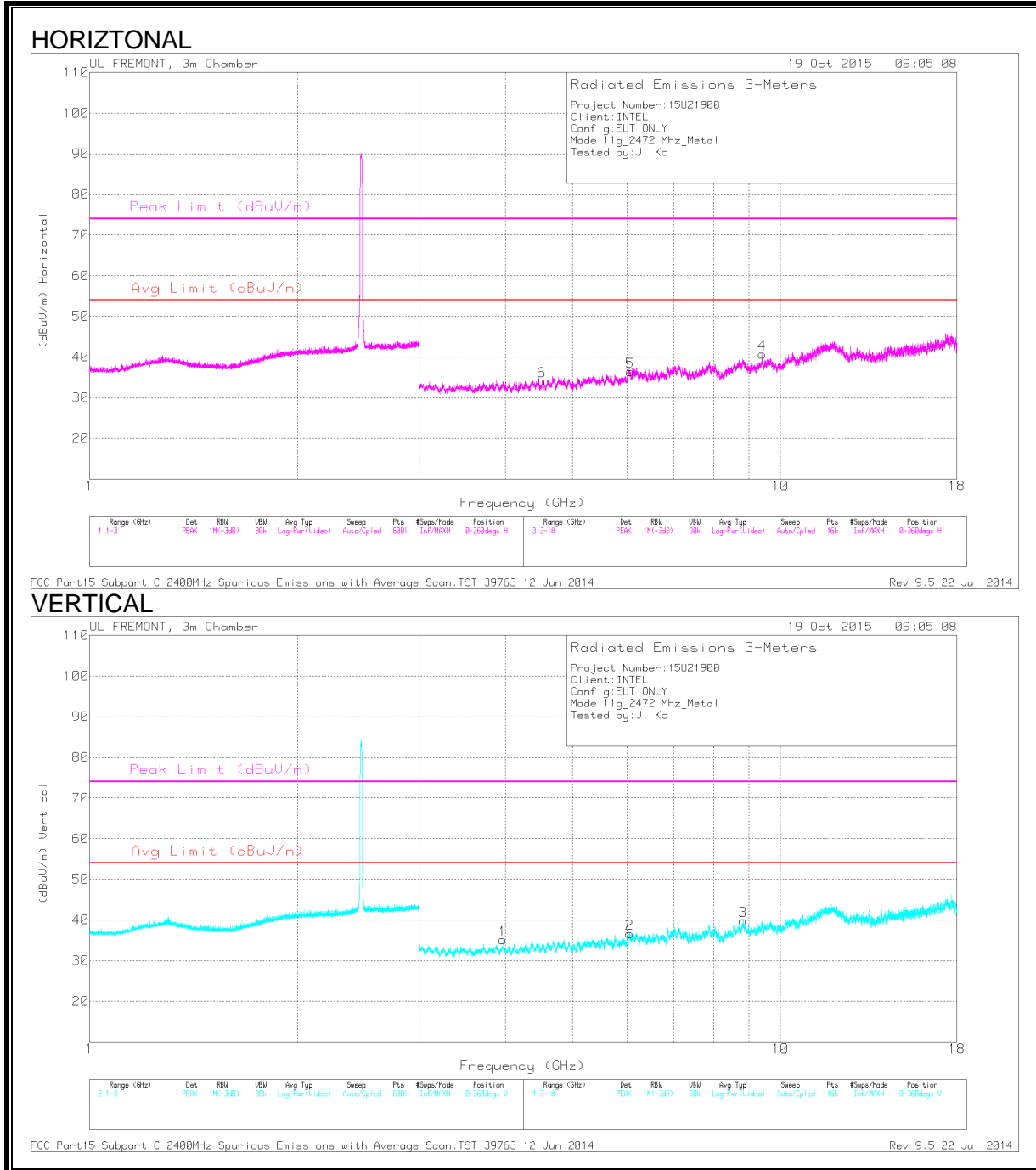

DATA

Marker	Frequency (GHz)	Meter Reading (dBuV)	Det	AF T119 (dB/m)	Amp/Cbl/Filtr/Pad (dB)	DC Corr (dB)	Corrected Reading (dBuV/m)	Avg Limit (dBuV/m)	Margin (dB)	Peak Limit (dBuV/m)	PK Margin (dB)	Azimuth (Degs)	Height (cm)	Polarity
1	3.962	41.61	PK2	33.2	-30.4	0	44.41	-	-	74	-29.59	360	166	V
	3.964	29.38	MAv1	33.2	-30.4	.31	32.49	54	-21.51	-	-	360	166	V
6	4.517	29.29	MAv1	33.8	-30.8	.31	32.6	54	-21.4	-	-	360	178	H
	4.52	40.34	PK2	33.8	-30.8	0	43.34	-	-	74	-30.66	360	178	H
5	6.051	38.48	PK2	35.2	-28.5	0	45.18	-	-	74	-28.82	360	200	V
	6.06	27.08	MAv1	35.2	-28.3	.31	34.29	54	-19.71	-	-	360	200	H
3	8.838	36.9	PK2	35.9	-25	0	47.8	-	-	74	-26.2	360	200	V
	8.839	24.84	MAv1	35.9	-25	.31	36.05	54	-17.95	-	-	360	200	V
4	9.406	24.99	MAv1	36.4	-24	.31	37.7	54	-16.3	-	-	360	167	H
	9.408	37.41	PK2	36.4	-24.1	0	49.71	-	-	74	-24.29	360	167	H

PK2 - KDB558074 Method: Maximum Peak

MAv1 - KDB558074 Option 1 Maximum RMS Average

9.2.3. TX ABOVE 1 GHz 802.11n HT20 MODE IN THE 2.4 GHz BAND

RESTRICTED BANDEDGE (LOW CHANNEL)

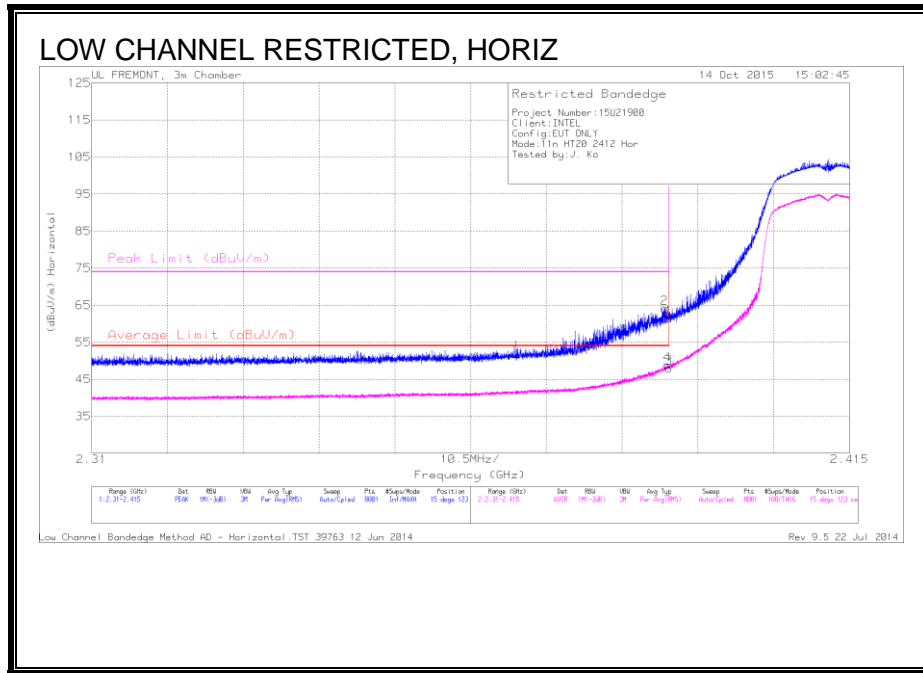

Marker	Frequency (GHz)	Meter Reading (dBuV)	Det	AF T119 (dB/m)	Amp/Cb/Fitter/Pad (dB)	DC Corr (dB)	Corrected Reading (dBuV/m)	Average Limit (dBuV/m)	Margin (dB)	Peak Limit (dBuV/m)	PK Margin (dB)	Azimuth (Degs)	Height (cm)	Polarity
2	2.389	54.61	PK	32	-22.4	0	64.21	-	-	74	-9.79	15	123	H
1	2.39	51.88	PK	32	-22.4	0	61.48	-	-	74	-12.52	15	123	H
3	2.39	38.13	RMS	32	-22.4	.32	48.05	54	-5.95	-	-	15	123	H
4	2.39	38.99	RMS	32	-22.4	.32	48.91	54	-5.09	-	-	15	123	H

PK - Peak detector

RMS - RMS detection

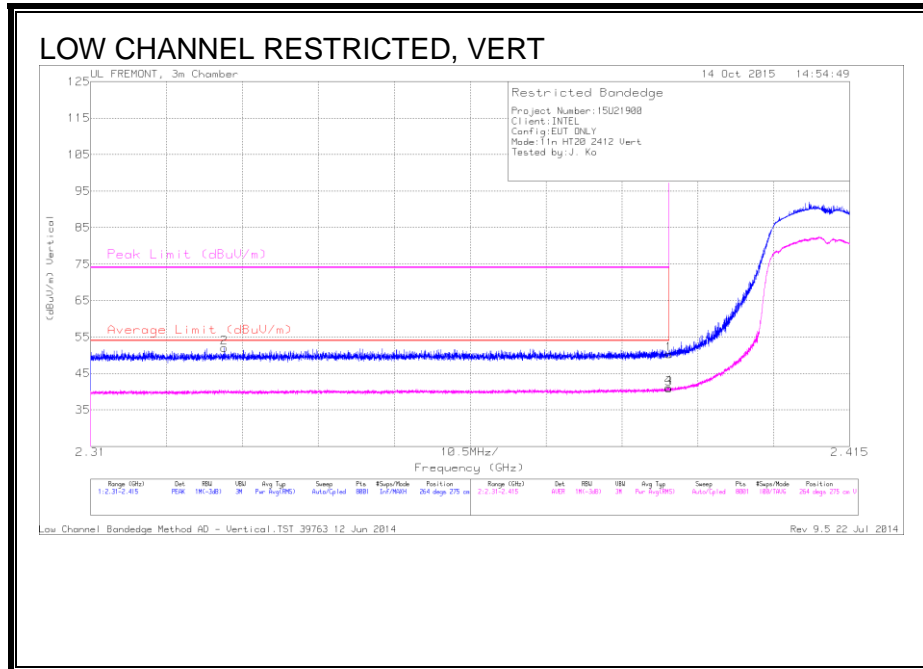

Marker	Frequency (GHz)	Meter Reading (dBuV)	Det	AF T119 (dB/m)	Amp/Cb/Fitter/Pad (dB)	DC Corr (dB)	Corrected Reading (dBuV/m)	Average Limit (dBuV/m)	Margin (dB)	Peak Limit (dBuV/m)	PK Margin (dB)	Azimuth (Degs)	Height (cm)	Polarity
2	2.328	42.75	PK	31.7	-22.4	0	52.05	-	-	74	-21.95	264	275	V
1	2.39	40.71	PK	32	-22.4	0	50.31	-	-	74	-23.69	264	275	V
3	2.39	30.92	RMS	32	-22.4	.32	40.84	54	-13.16	-	-	264	275	V
4	2.39	31.13	RMS	32	-22.4	.32	41.05	54	-12.95	-	-	264	275	V

PK - Peak detector

RMS - RMS detection

AUTHORIZED BANDEDGE (HIGH CHANNEL)

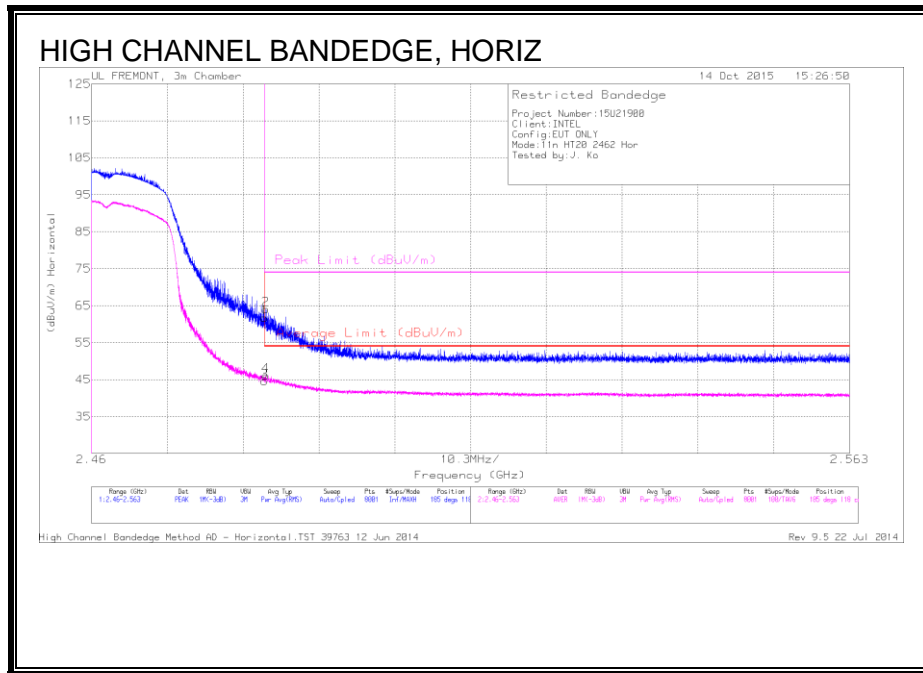

Marker	Frequency (GHz)	Meter Reading (dBuV)	Det	AF T119 (dB/m)	Amp/Cb/Filter/Pad (dB)	DC Corr (dB)	Corrected Reading (dBuV/m)	Average Limit (dBuV/m)	Margin (dB)	Peak Limit (dBuV/m)	PK Margin (dB)	Azimuth (Degs)	Height (cm)	Polarity
1	2.484	51.53	PK	32.3	-22.1	0	61.73	-	-	74	-12.27	185	118	H
2	2.484	53.84	PK	32.3	-22.1	0	64.04	-	-	74	-9.96	185	118	H
3	2.484	34.03	RMS	32.3	-22.1	.32	44.55	54	-9.45	-	-	185	118	H
4	2.484	35.56	RMS	32.3	-22.1	.32	46.08	54	-7.92	-	-	185	118	H

PK - Peak detector

RMS - RMS detection

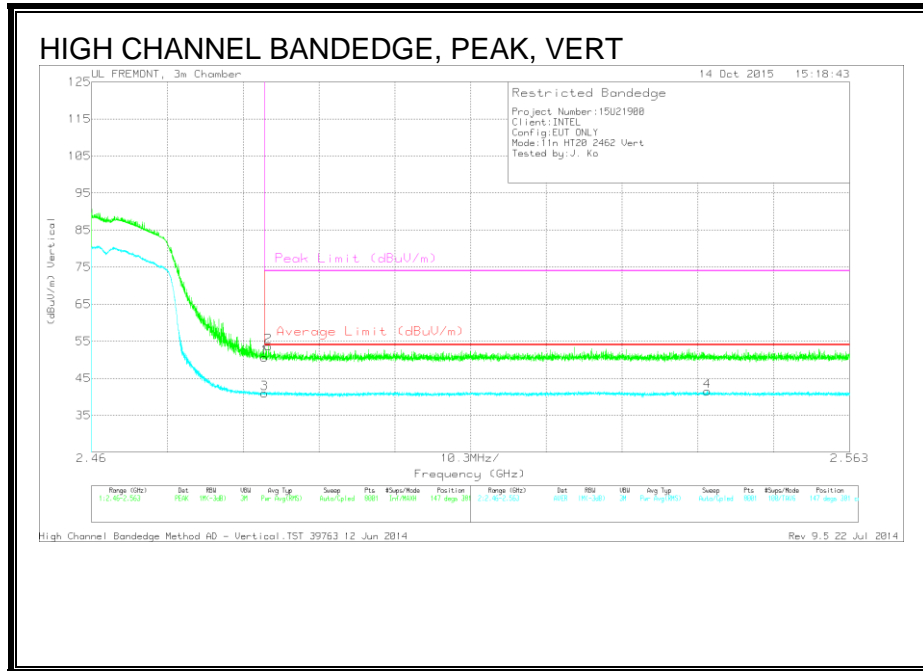

Marker	Frequency (GHz)	Meter Reading (dBuV)	Det	AF T119 (dB/m)	Amp/Cb/Fit r/Pad (dB)	DC Corr (dB)	Corrected Reading (dBuV/m)	Average Limit (dBuV/m)	Margin (dB)	Peak Limit (dBuV/m)	PK Margin (dB)	Azimuth (Degs)	Height (cm)	Polarity
1	2.484	40.43	PK	32.3	-22.1	0	50.63	-	-	74	-23.37	147	381	V
2	2.484	43.47	PK	32.3	-22.1	0	53.67	-	-	74	-20.33	147	381	V
3	2.484	30.45	RMS	32.3	-22.1	.32	40.97	54	-13.03	-	-	147	381	V
4	2.544	30.7	RMS	32.4	-21.9	.32	41.52	54	-12.48	-	-	147	381	V

PK - Peak detector

RMS - RMS detection

AUTHORIZED BANDEDGE (CHANNEL 12)

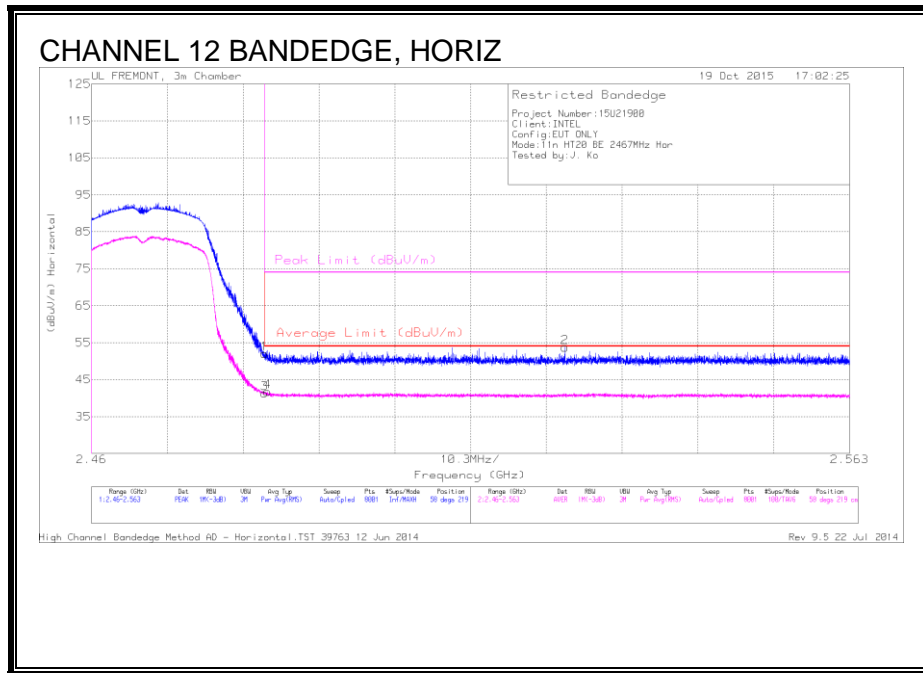

Marker	Frequency (GHz)	Meter Reading (dBuV)	Det	AF T119 (dB/m)	Amp/Cb/Fitter/Pad (dB)	DC Corr (dB)	Corrected Reading (dBuV/m)	Average Limit (dBuV/m)	Margin (dB)	Peak Limit (dBuV/m)	PK Margin (dB)	Azimuth (Degs)	Height (cm)	Polarity
1	2.484	41.8	PK	32.3	-22.1	0	52	-	-	74	-22	58	219	H
3	2.484	30.74	RMS	32.3	-22.1	.32	41.26	54	-12.74	-	-	58	219	H
4	2.484	31.21	RMS	32.3	-22.1	.32	41.73	54	-12.27	-	-	58	219	H
2	2.524	43.31	PK	32.4	-22	0	53.71	-	-	74	-20.29	58	219	H

PK - Peak detector

RMS - RMS detection

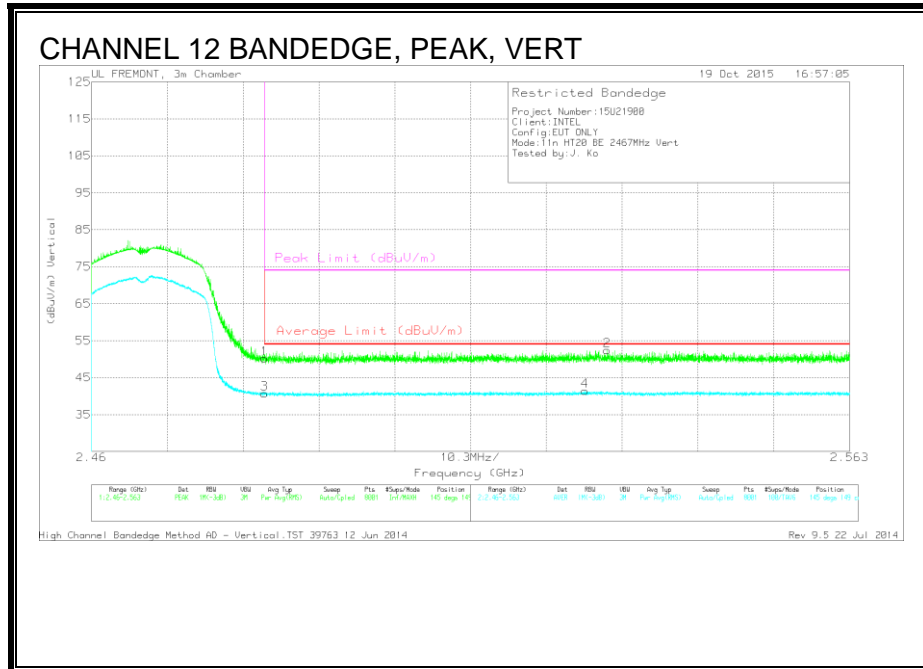

Marker	Frequency (GHz)	Meter Reading (dBuV)	Det	AF T119 (dB/m)	Amp/Cb/Fit r/Pad (dB)	DC Corr (dB)	Corrected Reading (dBuV/m)	Average Limit (dBuV/m)	Margin (dB)	Peak Limit (dBuV/m)	PK Margin (dB)	Azimuth (Degs)	Height (cm)	Polarity
1	2.484	39.98	PK	32.3	-22.1	0	50.18	-	-	74	-23.82	145	149	V
3	2.484	30.2	RMS	32.3	-22.1	.32	40.72	54	-13.28	-	-	145	149	V
4	2.527	30.71	RMS	32.4	-22	.32	41.43	54	-12.57	-	-	145	149	V
2	2.53	42	PK	32.4	-22	0	52.4	-	-	74	-21.6	145	149	V

PK - Peak detector

RMS - RMS detection

AUTHORIZED BANDEDGE (CHANNEL 13)

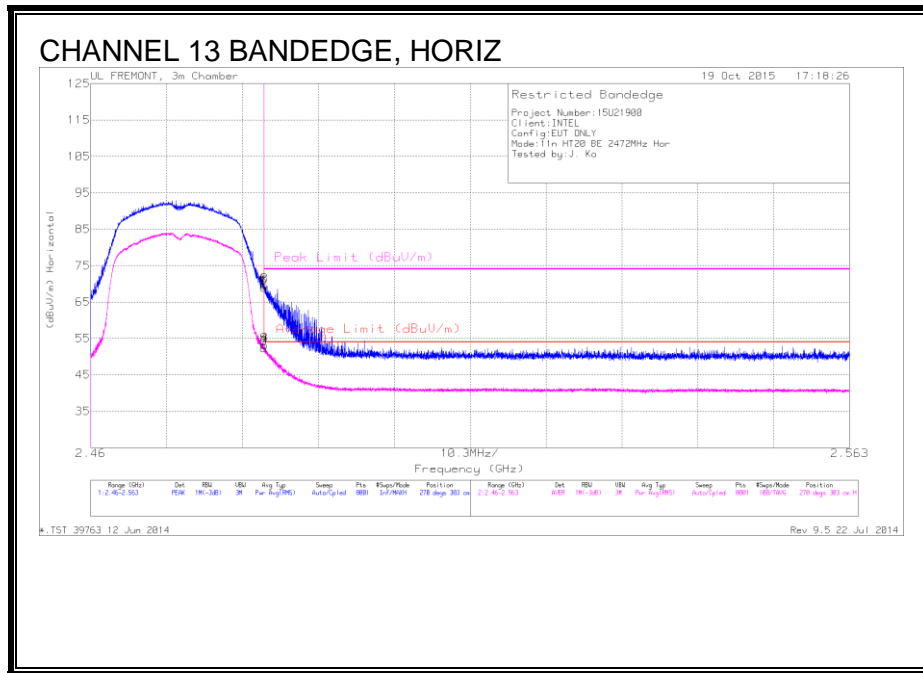

Marker	Frequency (GHz)	Meter Reading (dBuV)	Det	AF T119 (dB/m)	Amp/Cb/Fit r/Pad (dB)	DC Corr (dB)	Corrected Reading (dBuV/m)	Average Limit (dBuV/m)	Margin (dB)	Peak Limit (dBuV/m)	PK Margin (dB)	Azimuth (Degs)	Height (cm)	Polarity
1	2.484	58.77	PK	32.3	-22.1	0	68.97	-	-	74	-5.03	270	303	H
2	2.484	59.32	PK	32.3	-22.1	0	69.52	-	-	74	-4.48	270	303	H
3	2.484	41.72	RMS	32.3	-22.1	.32	52.24	54	-1.76	-	-	270	303	H
4	2.484	42.68	RMS	32.3	-22.1	.32	53.2	54	-.8	-	-	270	303	H

PK - Peak detector

RMS - RMS detection

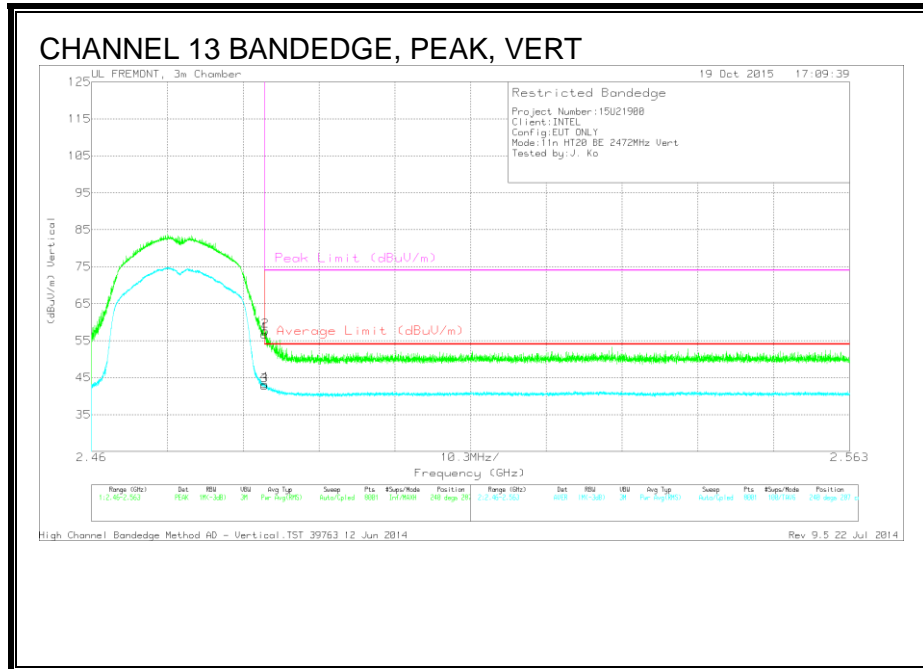

Marker	Frequency (GHz)	Meter Reading (dBuV)	Det	AF T119 (dB/m)	Amp/Cb/Fitter/Pad (dB)	DC Corr (dB)	Corrected Reading (dBuV/m)	Average Limit (dBuV/m)	Margin (dB)	Peak Limit (dBuV/m)	PK Margin (dB)	Azimuth (Degs)	Height (cm)	Polarity
1	2.484	46.56	PK	32.3	-22.1	0	56.76	-	-	74	-17.24	240	287	V
2	2.484	47.42	PK	32.3	-22.1	0	57.62	-	-	74	-16.38	240	287	V
3	2.484	32.3	RMS	32.3	-22.1	.32	42.82	54	-11.18	-	-	240	287	V
4	2.484	32.72	RMS	32.3	-22.1	.32	43.24	54	-10.76	-	-	240	287	V

PK - Peak detector

RMS - RMS detection

HARMONICS AND SPURIOUS EMISSIONS

LOW CHANNEL

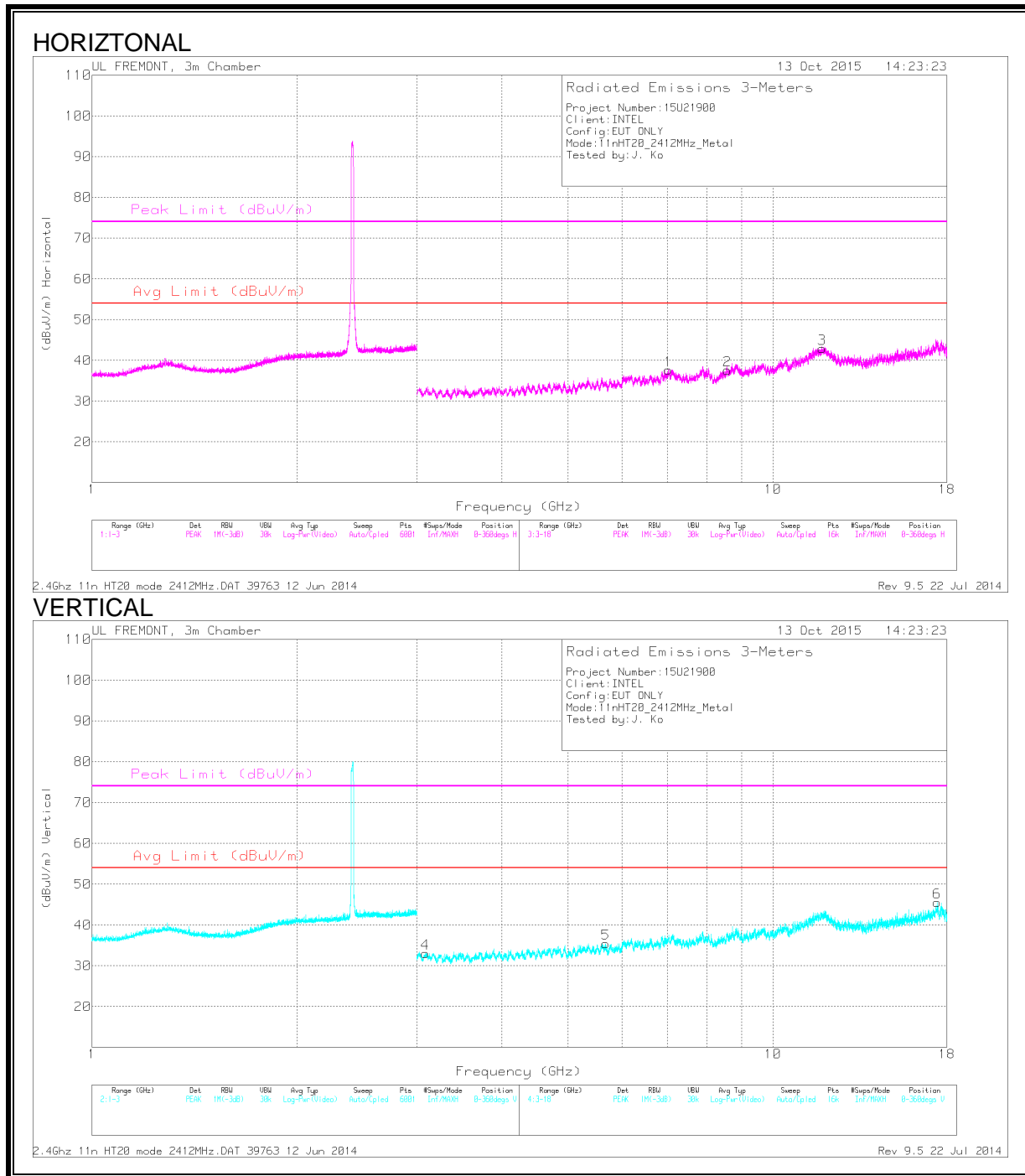

Note: Emission was scanned up to 26GHz; No emissions were detected above the noise floor which was at least 20dB below the specification limit.

DATA

Marker	Frequency (GHz)	Meter Reading (dBuV)	Det	AF T119 (dB/m)	Amp/Cbl/Filtr/Pad (dB)	DC Corr (dB)	Corrected Reading (dBuV/m)	Avg Limit (dBuV/m)	Margin (dB)	Peak Limit (dBuV/m)	PK Margin (dB)	Azimuth (Degs)	Height (cm)	Polarity
4	3.088	40.72	PK2	32.8	-30.9	0	42.62	-	-	74	-31.38	1	200	V
	3.089	29.4	MAv1	32.8	-30.9	.32	31.62	54	-22.38	-	-	1	200	V
5	5.684	40.4	PK2	34.7	-29.5	0	45.6	-	-	74	-28.4	1	200	V
	5.685	28.59	MAv1	34.7	-29.5	.32	34.11	54	-19.89	-	-	1	200	V
1	7.016	39.05	PK2	35.6	-28.2	0	46.45	-	-	74	-27.55	1	175	H
	7.018	27.48	MAv1	35.6	-28.1	.32	35.3	54	-18.7	-	-	1	175	H
2	8.575	26.08	MAv1	35.8	-26.1	.32	36.1	54	-17.9	-	-	1	167	H
	8.578	37.67	PK2	35.8	-26.1	0	47.37	-	-	74	-26.63	1	167	H
3	11.798	25.2	MAv1	39	-22.4	.32	42.12	54	-11.88	-	-	1	200	H
	11.8	36.84	PK2	39	-22.4	0	53.44	-	-	74	-20.56	1	200	H
6	17.409	35.83	PK2	41.4	-21.9	0	55.33	-	-	74	-18.67	1	205	V
	17.41	23.57	MAv1	41.4	-21.8	.32	43.49	54	-10.51	-	-	1	205	V

PK - Peak detector

PK2 - KDB558074 Method: Maximum Peak

MAv1 - KDB558074 Option 1 Maximum RMS Average

MID CHANNEL

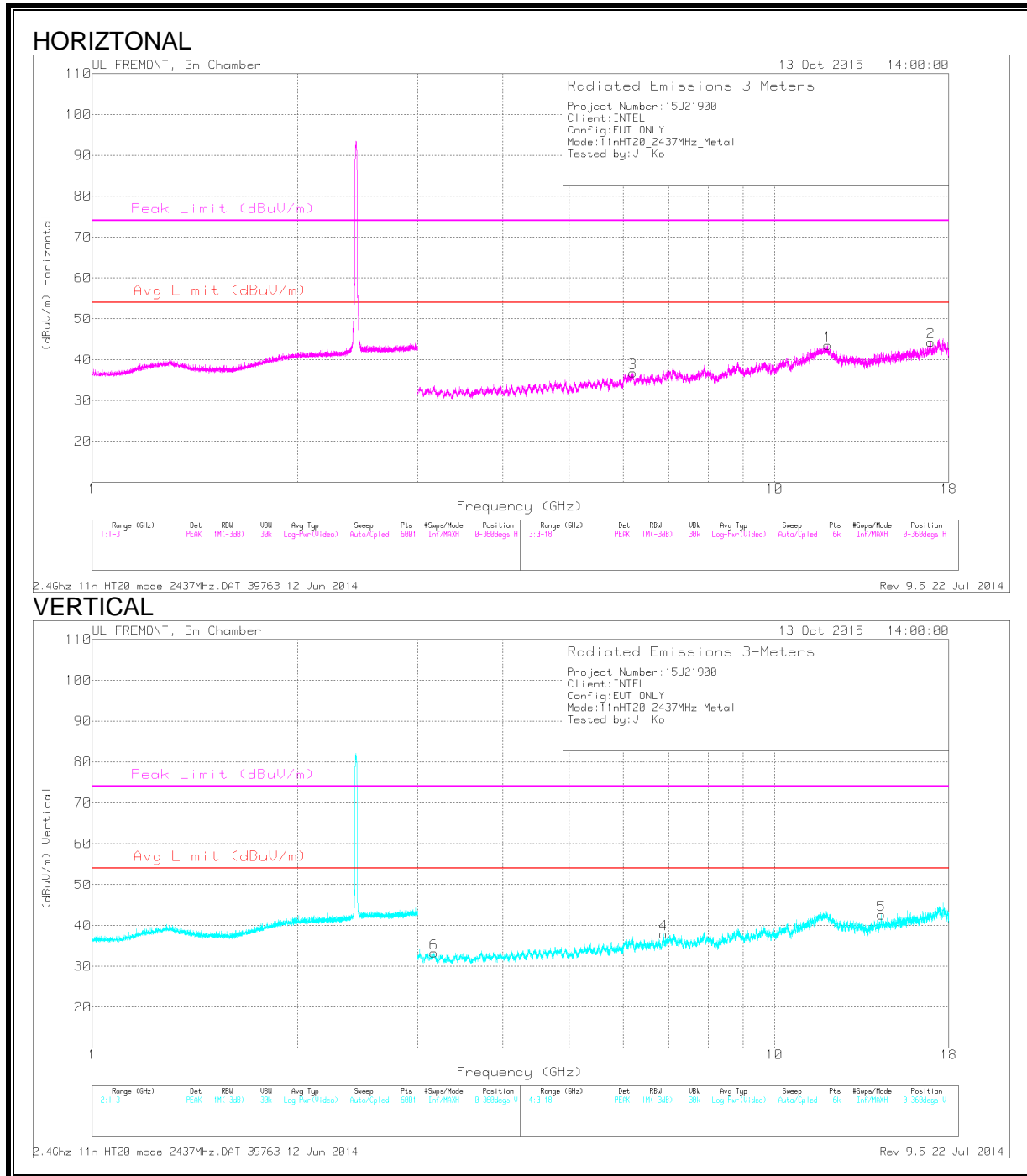

Note: Emission was scanned up to 26GHz; No emissions were detected above the noise floor which was at least 20dB below the specification limit.

DATA

Marker	Frequency (GHz)	Meter Reading (dBuV)	Det	AF T119 (dB/m)	Amp/Cbl/Filtr/Pad (dB)	DC Corr (dB)	Corrected Reading (dBuV/m)	Avg Limit (dBuV/m)	Margin (dB)	Peak Limit (dBuV/m)	PK Margin (dB)	Azimuth (Degs)	Height (cm)	Polarity
6	3.167	29.48	MAv1	32.7	-30.4	.32	32.1	54	-21.90	-	-	1	175	V
	3.169	40.87	PK2	32.7	-30.4	0	43.17	-	-	74	-30.83	1	175	V
3	6.199	28.37	MAv1	35.3	-29.3	.32	34.69	54	-19.31	-	-	1	205	H
	6.201	39.65	PK2	35.3	-29.2	0	45.75	-	-	74	-28.25	1	205	H
4	6.873	27.23	MAv1	35.6	-27.2	.32	35.95	54	-18.05	-	-	1	178	V
	6.875	39.15	PK2	35.6	-27.2	0	47.55	-	-	74	-26.45	1	178	V
1	11.964	25.16	MAv1	39.1	-22.8	.32	41.78	54	-12.22	-	-	1	155	H
	11.964	36.37	PK2	39.1	-22.8	0	52.67	-	-	74	-21.33	1	155	H
5	14.333	26.49	MAv1	39.4	-25.4	.32	40.81	54	-13.19	-	-	1	210	V
	14.334	38.14	PK2	39.4	-25.4	0	52.14	-	-	74	-21.86	1	210	V
2	16.935	23.42	MAv1	41.2	-22.3	.32	42.64	54	-11.36	-	-	1	202	H
	16.936	35.31	PK2	41.2	-22.4	0	54.11	-	-	74	-19.89	1	202	H

PK - Peak detector

PK2 - KDB558074 Method: Maximum Peak

MAv1 - KDB558074 Option 1 Maximum RMS Average

HIGH CHANNEL

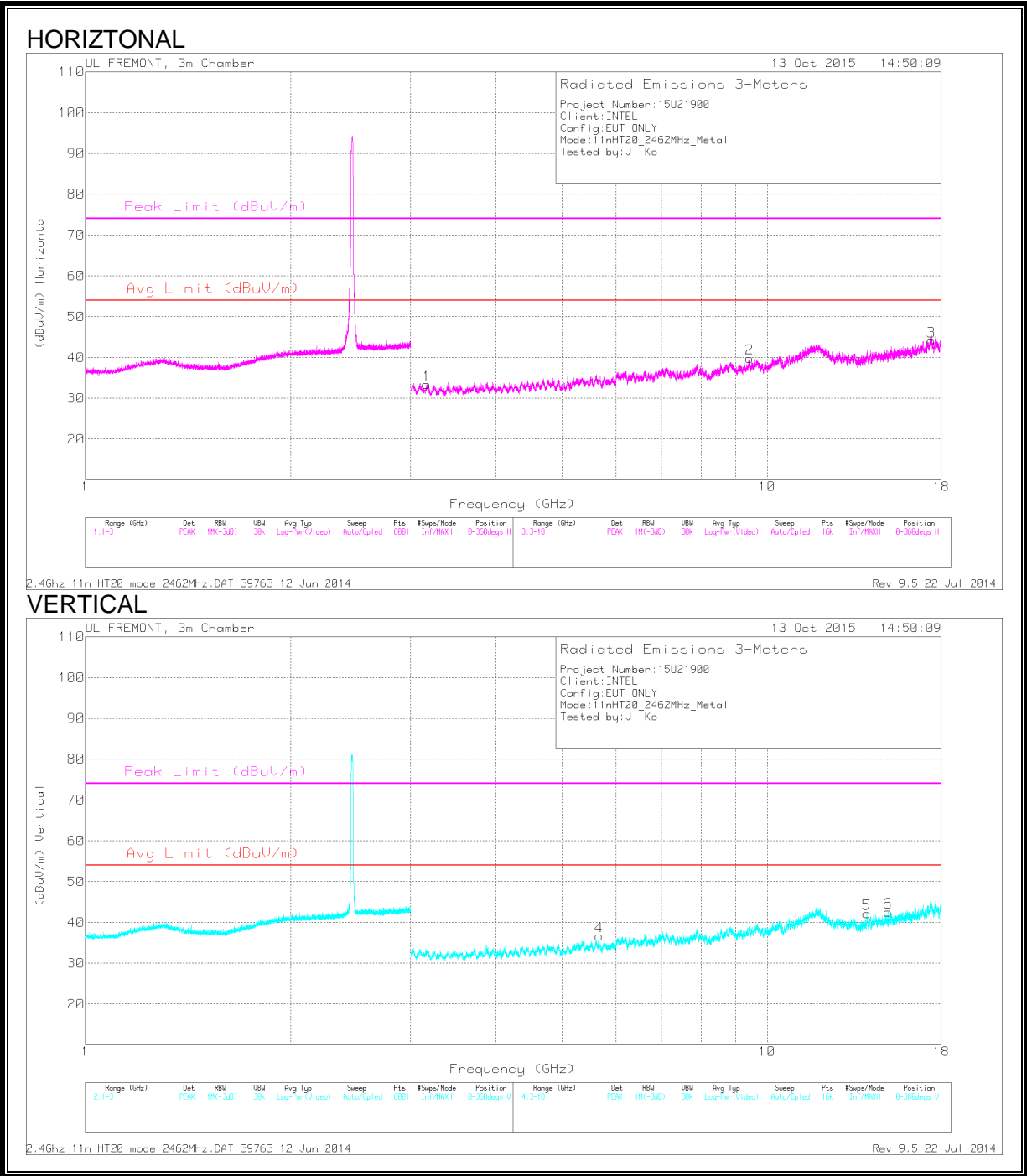

Note: Emission was scanned up to 26GHz; No emissions were detected above the noise floor which was at least 20dB below the specification limit.

DATA

Marker	Frequency (GHz)	Meter Reading (dBuV)	Det	AF T119 (dB/m)	Amp/Cbl/Filtr/Pad (dB)	DC Corr (dB)	Corrected Reading (dBuV/m)	Avg Limit (dBuV/m)	Margin (dB)	Peak Limit (dBuV/m)	PK Margin (dB)	Azimuth (Degs)	Height (cm)	Polarity
1	3.166	40.76	PK2	32.7	-30.4	0	43.06	-	-	74	-30.94	1	200	H
	3.167	29.35	MAv1	32.7	-30.4	.32	31.97	54	-22.03	-	-	1	200	H
4	5.668	28.06	MAv1	34.7	-29.2	.32	33.88	54	-20.12	-	-	1	166	V
	5.67	39.96	PK2	34.7	-29.2	0	45.46	-	-	74	-28.54	1	166	V
2	9.415	24.79	MAv1	36.4	-24.3	.32	37.21	54	-16.79	-	-	1	200	H
	9.416	36.53	PK2	36.4	-24.3	0	48.63	-	-	74	-25.37	1	200	H
5	14.336	38.51	PK2	39.4	-25.4	0	52.51	-	-	74	-21.49	1	167	V
	14.336	26.51	MAv1	39.4	-25.4	.32	40.83	54	-13.17	-	-	1	167	V
6	15.047	37.81	PK2	39.8	-25.3	0	52.31	-	-	74	-21.69	1	178	V
	15.048	25.94	MAv1	39.8	-25.4	.32	40.66	54	-13.34	-	-	1	178	V
3	17.4	35.17	PK2	41.4	-22.4	0	54.17	-	-	74	-19.83	1	175	H
	17.4	23.61	MAv1	41.4	-22.4	.32	42.93	54	-11.07	-	-	1	175	H

PK - Peak detector

PK2 - KDB558074 Method: Maximum Peak

MAv1 - KDB558074 Option 1 Maximum RMS Average

CHANNEL 12

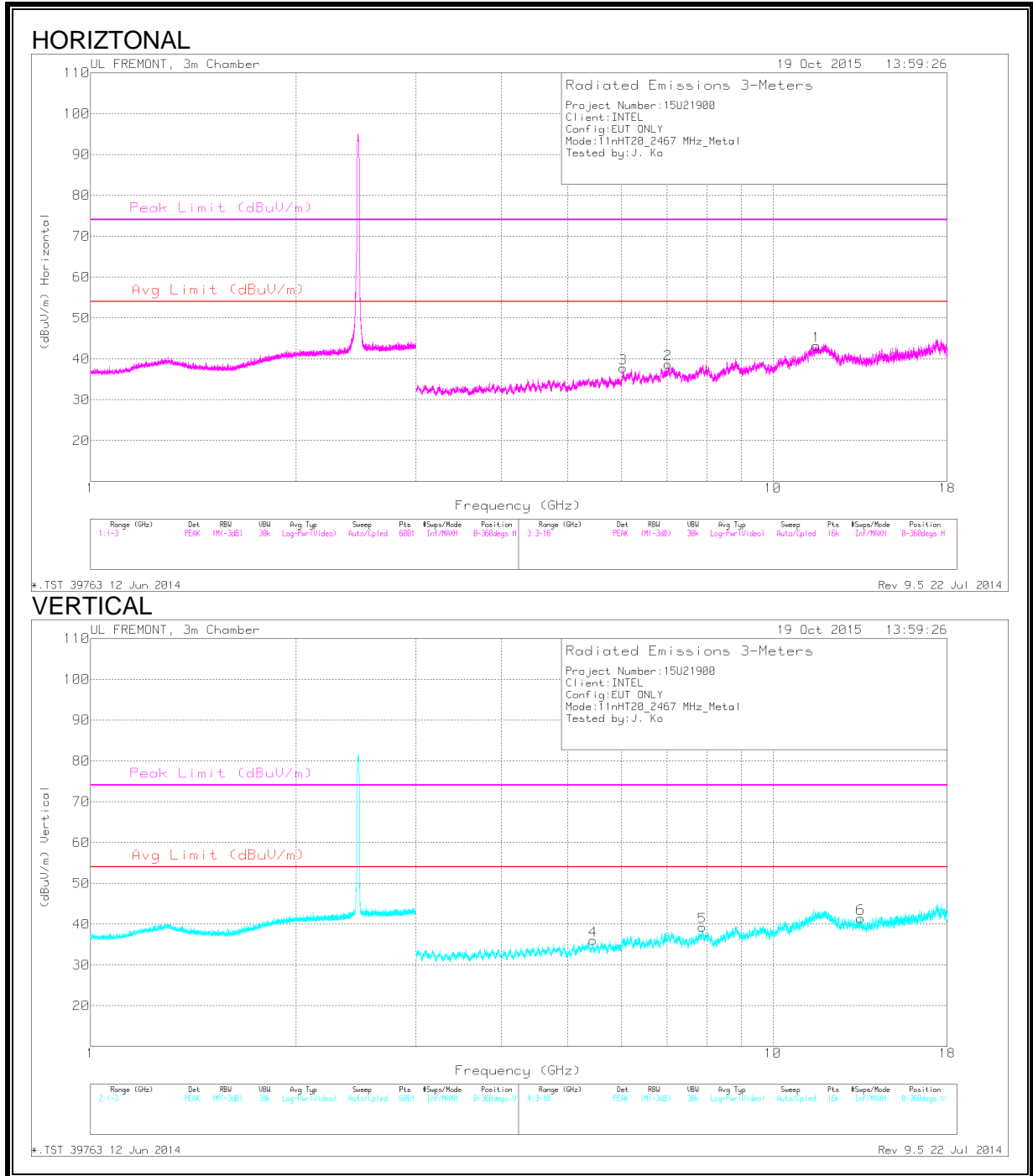

Note: Emission was scanned up to 26GHz; No emissions were detected above the noise floor which was at least 20dB below the specification limit.

DATA

Marker	Frequency (GHz)	Meter Reading (dBuV)	Det	AF T119 (dB/m)	Amp/Cbl/Filtr/Pad (dB)	DC Corr (dB)	Corrected Reading (dBuV/m)	Avg Limit (dBuV/m)	Margin (dB)	Peak Limit (dBuV/m)	PK Margin (dB)	Azimuth (Degs)	Height (cm)	Polarity
4	5.449	28.66	MAv1	34.6	-30.3	.32	33.28	54	-20.72	-	-	0	177	V
	5.45	40.47	PK2	34.6	-30.3	0	44.77	-	-	74	-29.23	0	177	V
3	6.035	40.14	PK2	35.2	-28.9	0	46.44	-	-	74	-27.56	0	200	H
	6.036	28.34	MAv1	35.2	-28.9	.32	34.96	54	-19.04	-	-	0	200	H
2	7.017	39.06	PK2	35.6	-28.1	0	46.56	-	-	74	-27.44	0	200	H
	7.017	27.59	MAv1	35.6	-28.1	.32	35.41	54	-18.59	-	-	0	200	H
5	7.882	37.78	PK2	35.8	-26.1	0	47.48	-	-	74	-26.52	0	202	V
	7.882	26.47	MAv1	35.8	-26.1	.32	36.49	54	-17.51	-	-	0	202	V
1	11.573	35.69	PK2	38.6	-22.1	0	52.19	-	-	74	-21.81	0	166	H
	11.576	24.31	MAv1	38.6	-22.1	.32	41.13	54	-12.87	-	-	0	166	H
6	13.443	26.12	MAv1	38.9	-26	.32	39.34	54	-14.66	-	-	0	205	V
	13.445	37.4	PK2	38.9	-26.1	0	50.2	-	-	74	-23.8	0	205	V

PK2 - KDB558074 Method: Maximum Peak

MAv1 - KDB558074 Option 1 Maximum RMS Average

CHANNEL 13

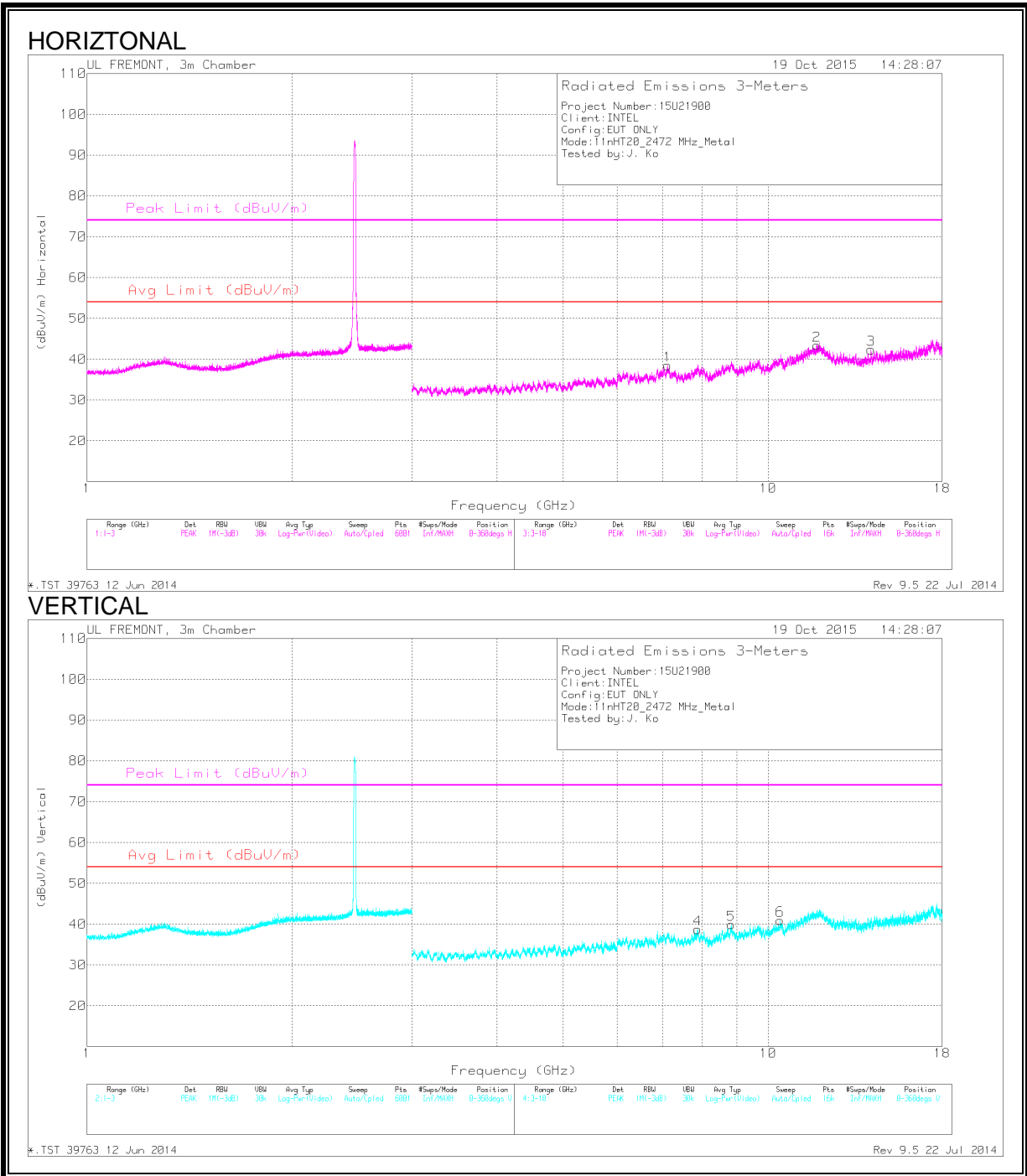

Note: Emission was scanned up to 26GHz; No emissions were detected above the noise floor which was at least 20dB below the specification limit.

DATA

Marker	Frequency (GHz)	Meter Reading (dBuV)	Det	AF T119 (dB/m)	Amp/Cbl/Filtr/Pad (dB)	DC Corr (dB)	Corrected Reading (dBuV/m)	Avg Limit (dBuV/m)	Margin (dB)	Peak Limit (dBuV/m)	PK Margin (dB)	Azimuth (Degs)	Height (cm)	Polarity
1	7.117	38.11	PK2	35.6	-27.4	0	46.31	-	-	74	-27.69	360	165	H
	7.117	27.11	MAv1	35.6	-27.4	.32	35.63	54	-18.37	-	-	360	165	H
4	7.883	37.86	PK2	35.8	-26	0	47.66	-	-	74	-26.34	360	211	V
	7.883	26.16	MAv1	35.8	-26	.32	36.28	54	-17.72	-	-	360	211	V
5	8.818	25.86	MAv1	35.9	-25.3	.32	36.78	54	-17.22	-	-	360	200	V
	8.821	37.01	PK2	35.9	-25.3	0	47.61	-	-	74	-26.39	360	200	V
6	10.418	35.87	PK2	37.3	-23.4	0	49.77	-	-	74	-24.23	360	205	V
	10.419	23.94	MAv1	37.3	-23.4	.32	38.16	54	-15.84	-	-	360	205	V
2	11.786	24.89	MAv1	39	-22.3	.32	41.91	54	-12.09	-	-	360	200	H
	11.787	37.23	PK2	39	-22.4	0	53.83	-	-	74	-20.17	360	200	H
3	14.152	37.97	PK2	39	-26.1	0	50.87	-	-	74	-23.13	360	221	H
	14.152	26.62	MAv1	39	-26.1	.32	39.84	54	-14.16	-	-	360	221	H

PK2 - KDB558074 Method: Maximum Peak

MAv1 - KDB558074 Option 1 Maximum RMS Average

9.3. WORST-CASE BELOW 1 GHz

SPURIOUS EMISSIONS 30 TO 1000 MHz (WORST-CASE CONFIGURATION)

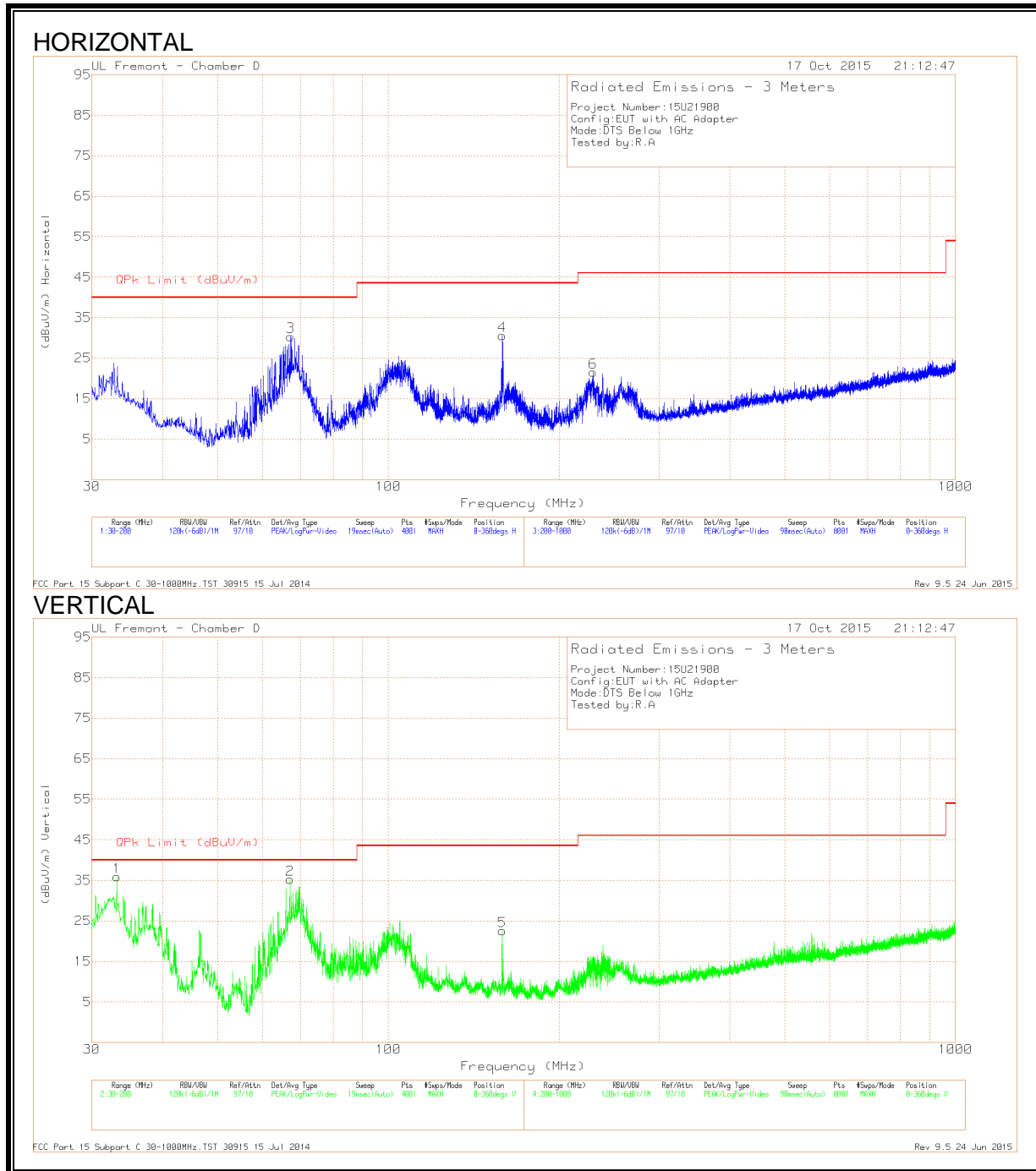

DATA

Marker	Frequency (MHz)	Meter Reading (dBuV)	Det	AF T407 (dB/m)	Amp/Cbl (dB)	Corrected Reading (dBuV/m)	QPk Limit (dBuV/m)	Margin (dB)	Azimuth (Degs)	Height (cm)	Polarity
1	33.1875	48.33	Pk	19.4	-31.8	35.93	40	-4.07	0-360	100	V
2	67.1025	58.69	Pk	8.1	-31.6	35.19	40	-4.81	0-360	100	V
3	67.2725	53.86	Pk	8.1	-31.6	30.36	40	-9.64	0-360	201	H
5	158.7963	41.48	Pk	12.1	-31	22.58	43.52	-20.94	0-360	100	V
4	158.9025	49.41	Pk	12.1	-31	30.51	43.52	-13.01	0-360	100	H
6	229.5	41.25	Pk	11	-30.7	21.55	46.02	-24.47	0-360	100	H

Pk - Peak detector

Radiated Emissions

Frequency (MHz)	Meter Reading (dBuV)	Det	AF T407 (dB/m)	Amp/Cbl (dB)	Corrected Reading (dBuV/m)	QPk Limit (dBuV/m)	Margin (dB)	Azimuth (Degs)	Height (cm)	Polarity
32.7243	43.6	Qp	19.7	-31.8	31.5	40	-8.5	174	100	V

Qp - Quasi-Peak detector

10. AC POWER LINE CONDUCTED EMISSIONS

LIMITS

FCC §15.207 (a)

RSS-Gen 8.8

TEST PROCEDURE

The EUT is placed on a non-conducting table 40 cm from the vertical ground plane and 80 cm above the horizontal ground plane. The EUT is configured in accordance with ANSI C63.10.

The receiver is set to a resolution bandwidth of 9 kHz. Peak detection is used unless otherwise noted as quasi-peak or average.

Line conducted data is recorded for both NEUTRAL and HOT lines.

RESULTS

10.1. EUT WITH AC ADAPTER

LINE 1 RESULTS

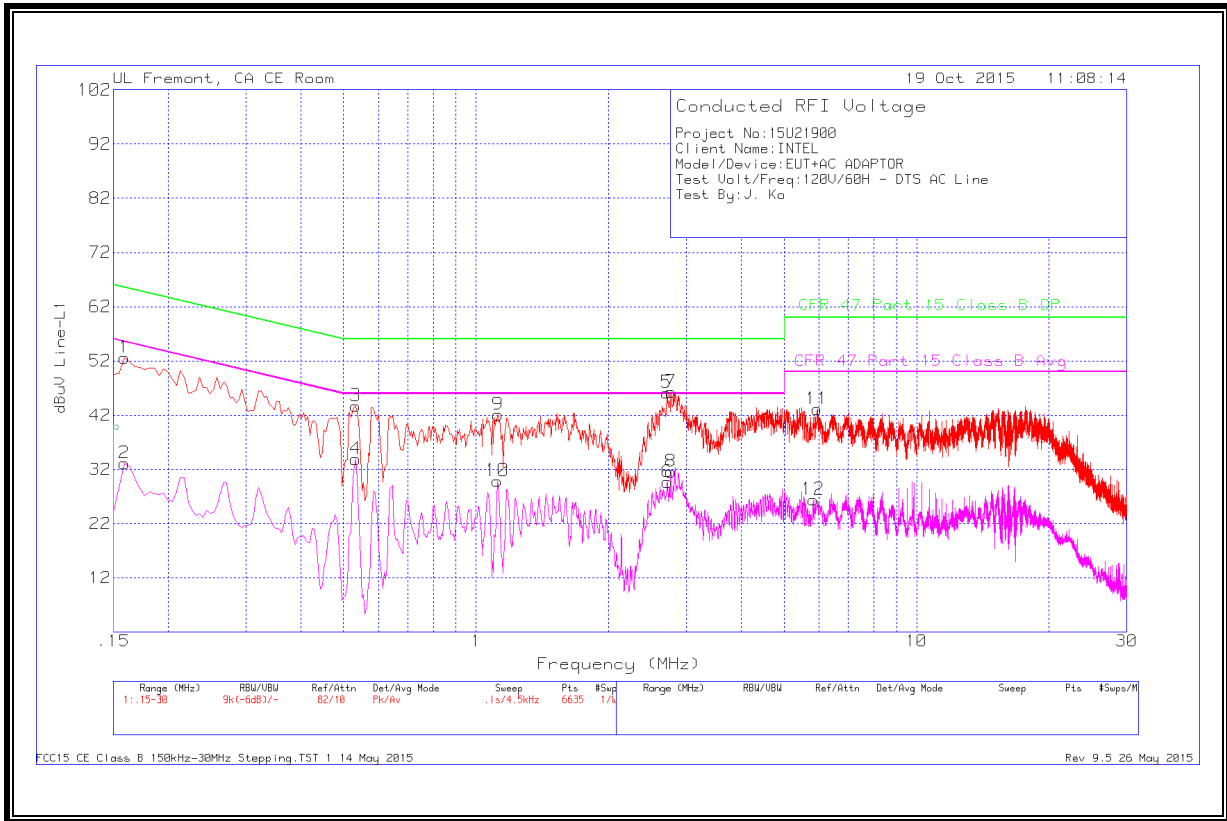

DATA

Range 1: Line-L1 .15 - 30MHz

Marker	Frequency (MHz)	Meter Reading (dBuV)	Det	T24 IL L1	LC Cables 1&3	Corrected Reading dBuV	CFR 47 Part 15 Class B QP	Margin (dB)	CFR 47 Part 15 Class B Avg	Margin (dB)
1	.159	51.31	Pk	1.3	0	52.61	65.52	-12.91		
2	.159	31.81	Av	1.3	0	33.11	-	-	55.52	-22.41
3	.5325	43.39	Pk	.3	0	43.69	56	-12.31		
4	.5325	33.59	Av	.3	0	33.89	-	-	46	-12.11
5	2.706	45.83	Pk	.2	.1	46.13	56	-9.87		
6	2.7195	29.35	Av	.2	.1	29.65	-	-	46	-16.35
7	2.7735	46	Pk	.2	.1	46.3	56	-9.7		
8	2.769	31.27	Av	.2	.1	31.57	-	-	46	-14.43
9	1.122	41.91	Pk	.2	0	42.11	56	-13.89		
10	1.1175	29.66	Av	.2	0	29.86	-	-	46	-16.14
11	5.9505	42.81	Pk	.2	.1	43.11	60	-16.89		
12	5.8245	26.11	Av	.2	.1	26.41	-	-	50	-23.59

Pk - Peak detector

Av - Average detection

Range 1: Line-L1 .15 - 30MHz

Frequency (MHz)	Meter Reading (dBuV)	Det	T24 IL L1	LC Cables 1&3	Corrected Reading dBuV	CFR 47 Part 15 Class B QP	Margin (dB)	CFR 47 Part 15 Class B Avg	Margin (dB)
.15	20.11	Ca	1.4	0	21.51	-	-	56	-34.49

Ca - CISPR average detection

Quasi-Peak Emissions

Range 1: Line-L1 .15 - 30MHz

Frequency (MHz)	Meter Reading (dBuV)	Det	T24 IL L1	LC Cables 1&3	Corrected Reading dBuV	CFR 47 Part 15 Class B QP	Margin (dB)	CFR 47 Part 15 Class B Avg	Margin (dB)
.15	37.37	Qp	1.4	0	38.77	66	-27.23	-	-

Qp - Quasi-Peak detector

LINE 2 RESULTS

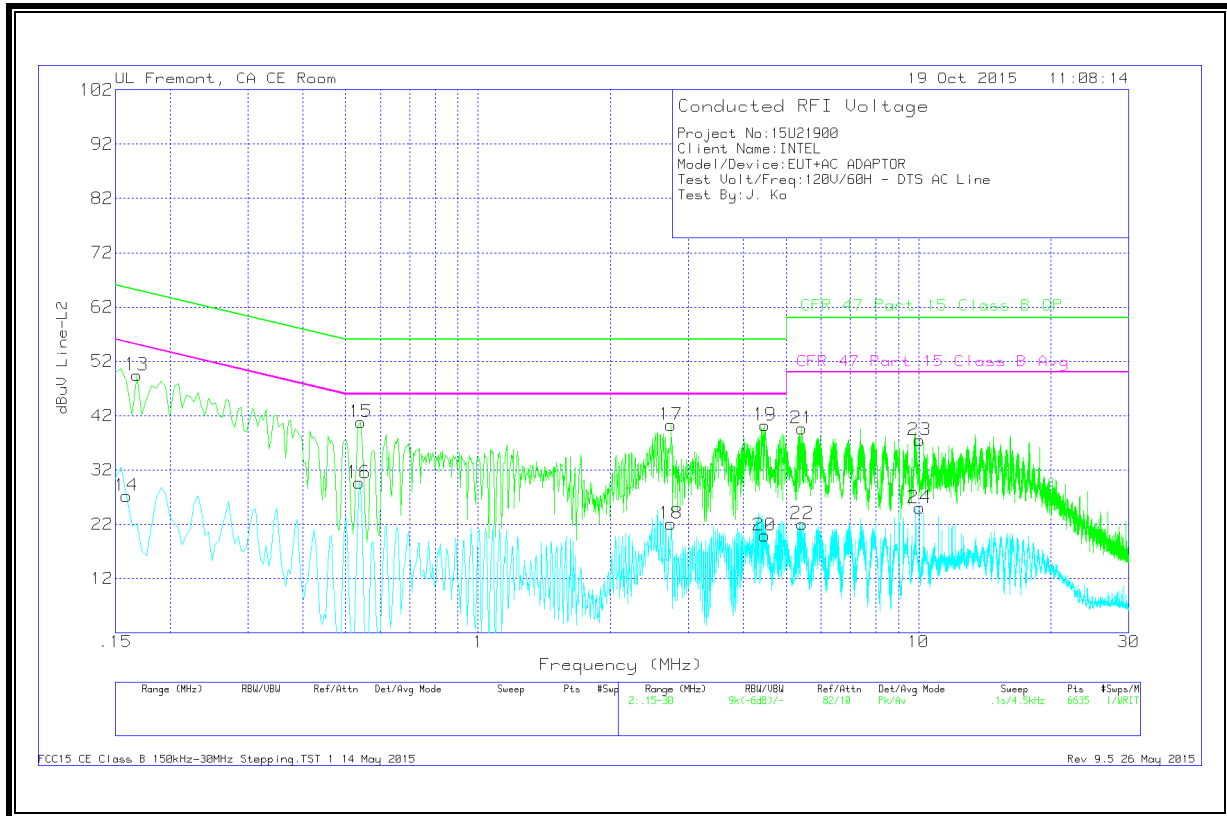

DATA

Range 2: Line-L2 .15 - 30MHz

Marker	Frequency (MHz)	Meter Reading (dBuV)	Det	T24 IL L2	LC Cables 2&3	Corrected Reading dBuV	CFR 47 Part 15 Class B QP	Margin (dB)	CFR 47 Part 15 Class B Avg	Margin (dB)
13	.168	48.15	Pk	1.3	0	49.45	65.06	-15.61		
14	.159	25.84	Av	1.4	0	27.24	-	-	55.52	-28.28
15	.5415	40.52	Pk	.3	0	40.82	56	-15.18		
16	.537	29.33	Av	.3	0	29.63	-	-	46	-16.37
17	2.742	40.03	Pk	.2	.1	40.33	56	-15.67		
18	2.742	21.8	Av	.2	.1	22.1	-	-	46	-23.9
19	4.479	39.93	Pk	.2	.1	40.23	56	-15.77		
20	4.47	19.65	Av	.2	.1	19.95	-	-	46	-26.05
21	5.433	39.34	Pk	.2	.1	39.64	60	-20.36		
22	5.442	21.75	Av	.2	.1	22.05	-	-	50	-27.95
23	10.0545	37.08	Pk	.2	.2	37.48	60	-22.52		
24	10.0545	24.62	Av	.2	.2	25.02	-	-	50	-24.98

Pk - Peak detector

Av - Average detection

10.2. EUT WITH USB LAPTOP

LINE 1 RESULTS

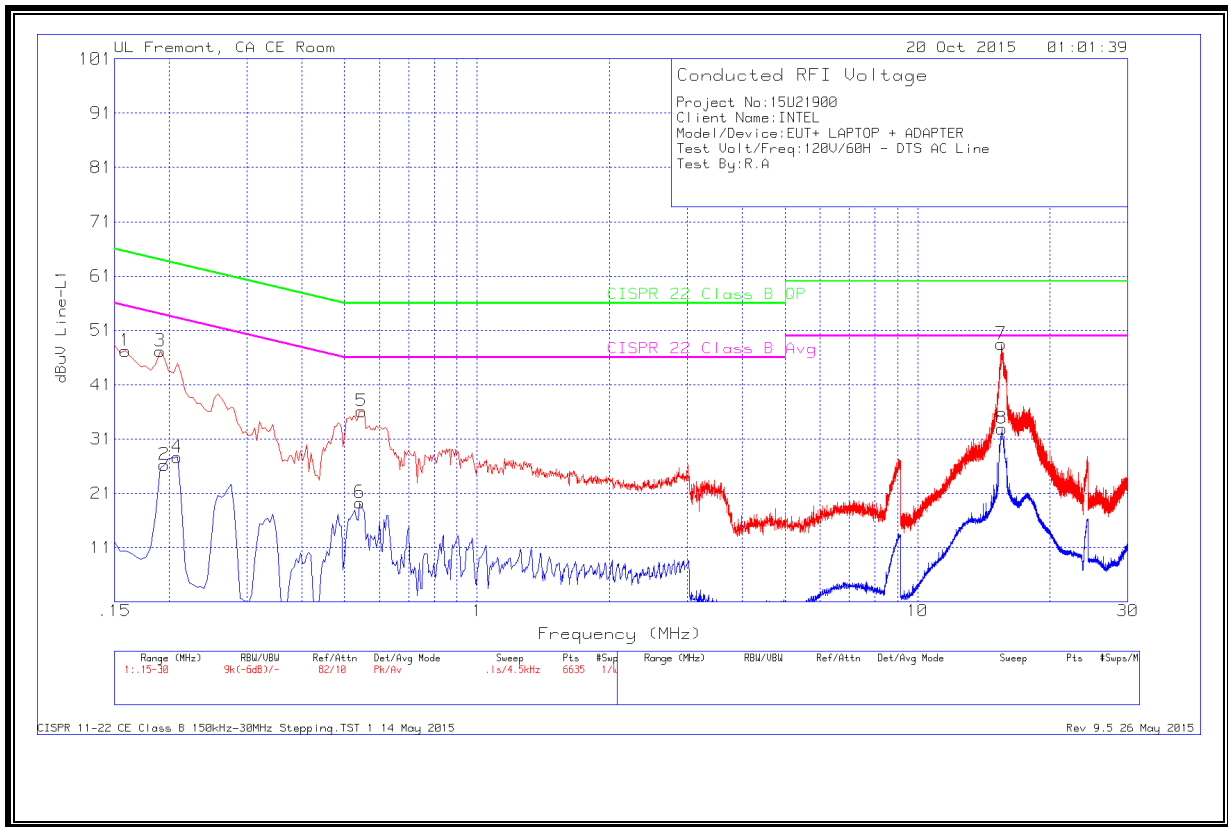

DATA

Range 1: Line-L1 .15 - 30MHz

Marker	Frequency (MHz)	Meter Reading (dBuV)	Det	T24 IL L1	LC Cables 1&3	Corrected Reading dBuV	CISPR 22 Class B QP	Margin (dB)	CISPR 22 Class B Avg	Margin (dB)
1	.159	45.92	Pk	1.3	0	47.22	65.52	-18.3		
2	.195	25.26	Av	1	0	26.26	-	-	53.82	-27.56
3	.1905	46.18	Pk	1	0	47.18	64.01	-16.83		
4	.2085	26.7	Av	.9	0	27.6	-	-	53.26	-25.66
5	.546	35.8	Pk	.3	0	36.1	56	-19.9		
6	.5415	18.94	Av	.3	0	19.24	-	-	46	-26.76
7	15.486	47.98	Pk	.3	.2	48.48	60	-11.52		
8	15.5355	32.42	Av	.3	.2	32.92	-	-	50	-17.08

Pk - Peak detector

Av - Average detection

LINE 2 RESULTS

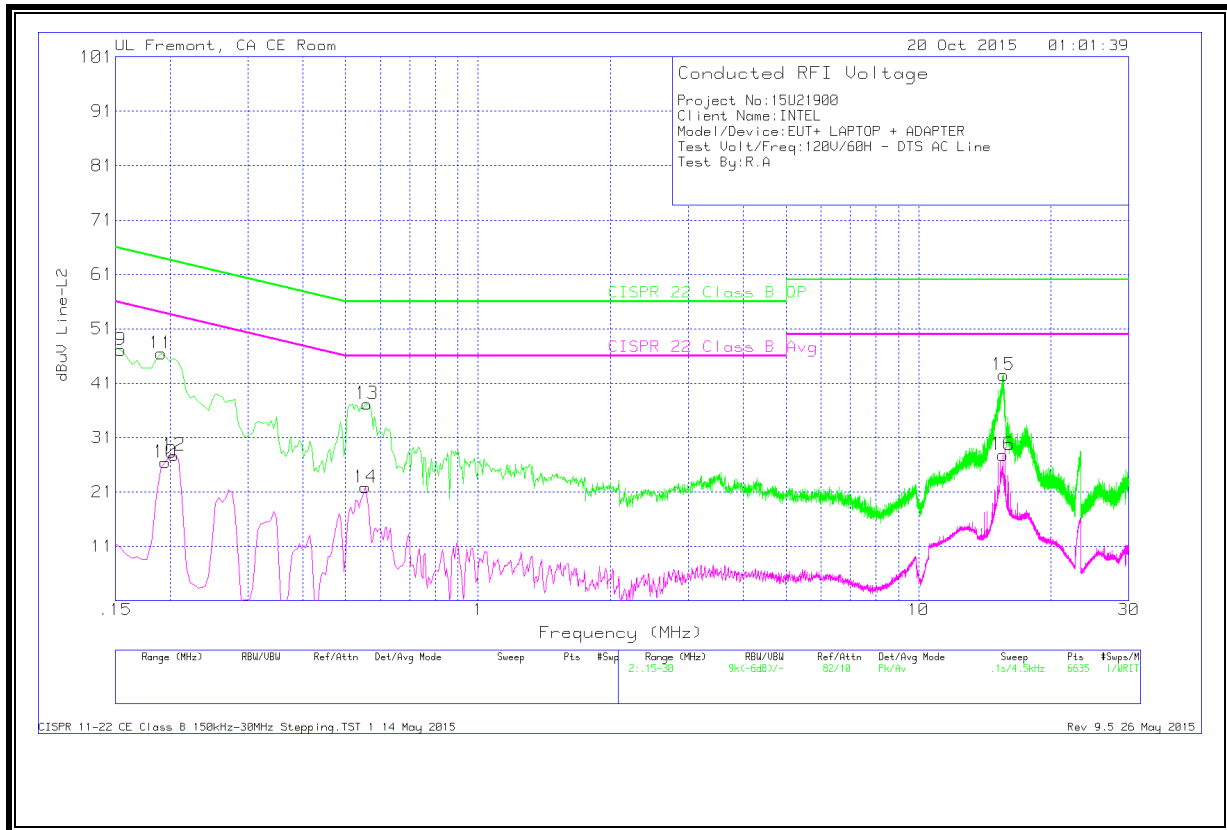

DATA

Range 2: Line-L2 .15 - 30MHz

Marker	Frequency (MHz)	Meter Reading (dBuV)	Det	T24 IL L2	LC Cables 2&3	Corrected Reading dBuV	CISPR 22 Class B QP	Margin (dB)	CISPR 22 Class B Avg	Margin (dB)
9	.1545	45.69	Pk	1.4	0	47.09	65.75	-18.66		
10	.195	25.44	Av	1	0	26.44	-	-	53.82	-27.38
11	.1905	45.36	Pk	1.1	0	46.46	64.01	-17.55		
12	.204	26.71	Av	1	0	27.71	-	-	53.45	-25.74
13	.5595	36.87	Pk	.3	0	37.17	56	-18.83		
14	.555	21.53	Av	.3	0	21.83	-	-	46	-24.17
15	15.585	41.99	Pk	.3	.2	42.49	60	-17.51		
16	15.5355	27.31	Av	.3	.2	27.81	-	-	50	-22.19

Pk - Peak detector

Av - Average detection