

## RR4-TR Remote Reader

With Integrated NextCentury Transceiver (Radio)

### Operation and Installation Guide

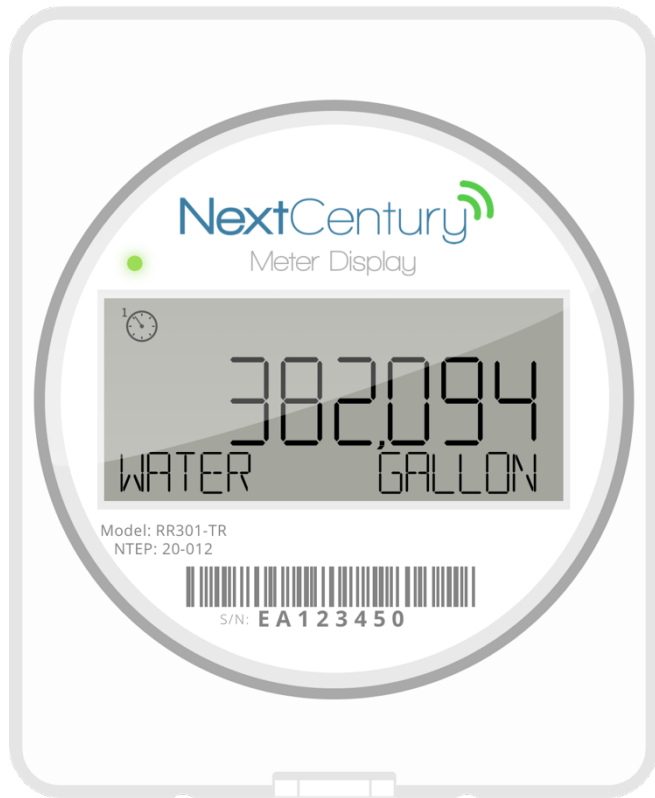

## 1| Product Overview

The NextCentury RR4-TR Remote Reader is an advanced meter reading solution which provides a high visibility remote display of one or two utility meters. The Remote Reader is an NTEP certified remote display for water, electric, and gas applications.

The Remote Reader has an attractive consumer design, making it an ideal solution for apartment and remote metering. The utility and unit of measure are clearly displayed, ensuring an accurate interpretation of the read.

In addition to displaying the meter read, the RR4-TR Remote Reader operates as a wireless transceiver end-point to transmit meter read data to the NextCentury cloud platform.

The Remote Reader utilizes **Dual Meter+™** technology, making this single model compatible with virtually all modern encoded and pulse-output utility meters, including water, electric, gas, run-time, and thermal meter models.

## 2| Technical Specifications

### 2.1 – Certifications

FCC: 2AB8I-RR4      IC: 20949-RR4  
NTEP: 20-012      IP-Rating: Tested to IP65

### 2.2 – Wireless

- NextCentury two-way Communications Radio
- 902-928 MHz Unlicensed Band

### 2.3 – Dual Meter+™

- Any combination of two encoded or pulse-output meters
- Pulse output configuration capable

### 2.4 – Configuration Methods

- A Cloud-connected GW301 Gateway or a DC301 Direct Connect device (sold separately) is required to change the RR4-TR configuration.
- Pre-programming available.

### 2.5 – Battery

- Preinstalled, field replaceable ER18505
- Up to \*10-year battery life

*\*Note: 10-year average battery life calculated and tested at typical operating temperatures between 70°F-90°F. Battery life may be reduced when operated outside of this range.*

### 2.6 – Dimensions:

- Display unit and mounting plate: 5.7" x 4.6" x 1.7" (145mm x 117mm x 44mm)
- Mounting holes center-to-center: 3.5" (88.4 mm)
- Compatible with a standard single gang wall-box

### 2.7 – Operation Environment:

- -20°C to 60°C (-4°F to 140°F)
- Should be installed in an indoor, dry environment
- Outdoor Ratings: (coming soon)

## 3| Meter Compatibility

The NextCentury Remote Reader integrates **Dual Meter+™** technology, allowing for compatibility with virtually all modern meter outputs.

### 3.1 – Pulse Output Meters

- Passive pulse sensing (including reed switch, solid-state relay, contact relay, open-drain types)
- Active voltage sensing (max. 16 VDC)

### 3.2 – Encoded Output Meters

- Neptune (Including ProRead, ECoder, and ProCoder register models)
- Sensus UI-1203 (Includes most meter models from Sensus, Hersey, Mueller, Master Meter, Badger, Kamstrup, Elster, Metron-Farnier, and Zenner)
- Elster/AMCO K-Frame (Includes most meter models from Elster, AMCO, ABB and Kent)

## 4| Packaging Contents

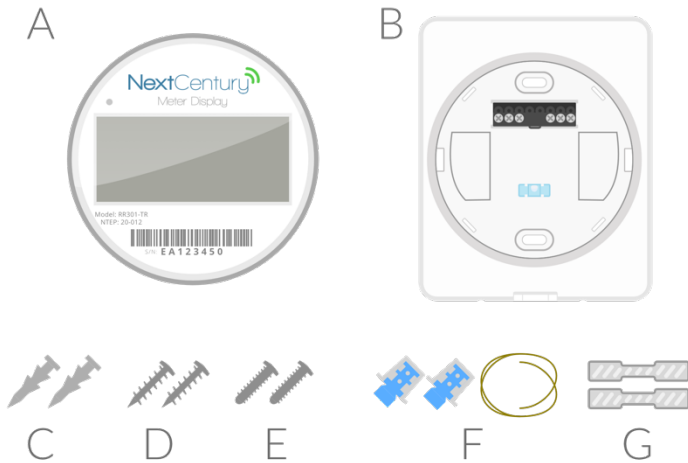

A - RR4-TR Remote Reader      E - Box Mount Screws #6-32  
 B - Mounting Plate              F - Wire Security Assembly  
 C - Sheetrock Anchors          G - Security Seal Tabs  
 D - Wall Mount Screws #6-20

## 5| In-Field Installation

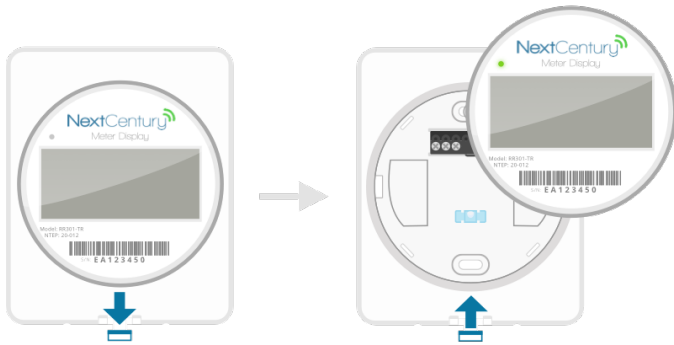

### 5.1 – Detach from Mounting Plate

- Pull down the security tab, the Remote Reader can then be pulled off the mounting plate.
- Slide the security tab back to its original position when installation is complete.

**DO NOT** open the Remote Reader unless replacement of the battery is necessary (approx. every 10 years). It is not necessary to disassemble/open a Remote Reader during installation.

### 5.2 – Mounting Plate Installation

- Hold the mounting plate at the desired height and use the integrated level to straighten.
- Use a pencil to mark holes for pre-drilling
- Pre-drill using a 7/32" (5.5mm) drill bit
- Insert plastic anchors and attach the mounting plate with a PH-1 screwdriver and the two screws (fig. 4-D).

### 5.3 – Wall Box (optional)

- Pass the meter wire(s) through the mounting plate access holes
- Use a PH-1 screwdriver and the two screws (fig. 4-E) to attach the mounting plate

### 5.4 – Meter Wiring

The Remote Reader can be connected to one or two meters. Use Meter 1 (left 3 terminals) and Meter 2 (right 3 terminals) to connect meters to the Remote Reader's mounting plate.

- Strip meter wire ends to 3/16" (5 mm)
- Insert the wire ends into the terminal block and tighten securely using a PH-1 screwdriver

### 5.5 – Meter Wiring Diagram

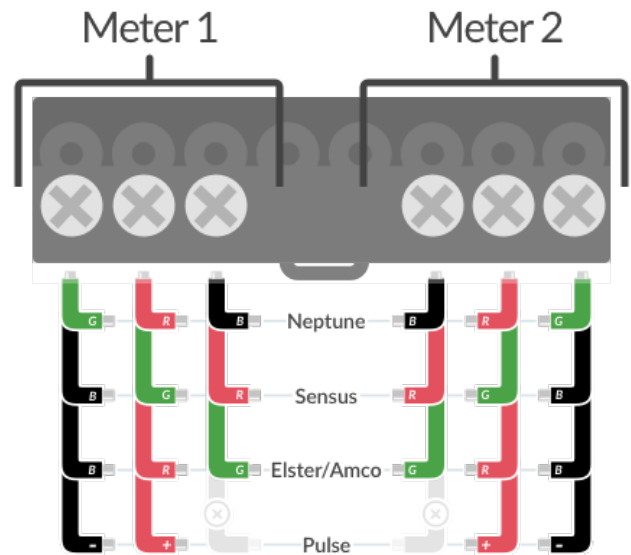

### 5.6 – Tamper Evident Seal

- The Security Tab Seal (figure 4-F) or Security Wire Seal (figure 4-G) can be used according to your installation specifications.

## 6| Configuration Programming Methods

### 6.1 – Cloud Configuration

- Performed using the NextCentury Website or Mobile App
- Use this configuration method when a Cloud-connected Gateway and Repeaters have already been installed.

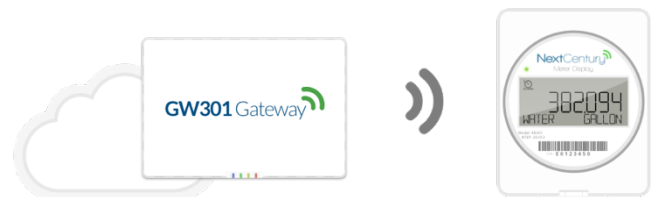

### 6.2 – Direct Connect with DC301 Configuration

- Performed using the DC301 *Direct Connect Programmer* (available separately).
- Use this configuration method when a cloud-connected Gateway is not yet available.
- May also be used for advanced troubleshooting and diagnostics.

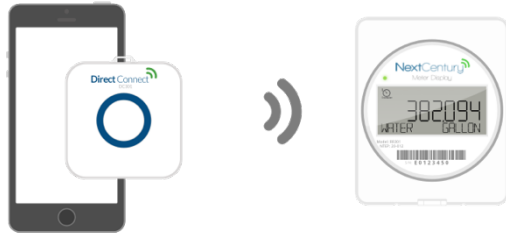

## 7| Setting the Configuration

### 7.1 – Configuration Changes

- The RR4-TR is capable of accepting new configuration parameters during any wireless check-in.

### 7.2 – Initiating Wireless Check-In

- A wireless check-in can be initiated when the RR4-TR is snapped onto its mounting plate.
- Subsequent check-ins can be initiated using a magnet within the magnetic activation zone.

### 7.3 – Magnetic Activation Zone

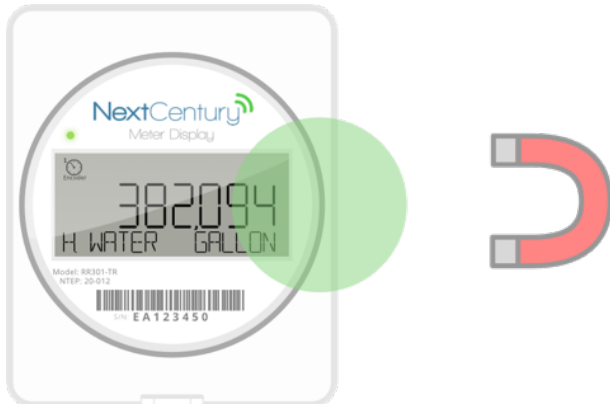

A wireless check-in is initiated when a magnet is moved past the activation zone highlighted in this figure.

### 7.4 – LED Indicator

The LED indicator provides feedback to easily check the status of the RR4-TR.

- 8x Checking In (red)
- 1x Meter 1 Pulse (blue)
- 2x Response Received (green)
- 1x Meter 2 Pulse (purple)

## 8| LCD Display

### 8.1 – LCD Display Example

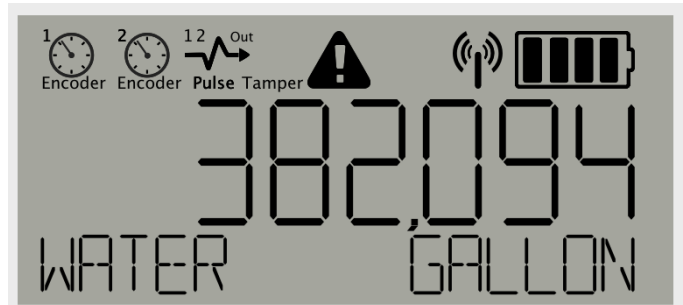

### 8.2 – Meter Display Views

The RR4-TR will rotate through the following views at a 5-10 second interval (as applicable to its configuration).

- 1 Meter 1
  - Meter read, utility, unit of measure
  - Meter read, serial number (encoded only)
- 2 Meter 2
  - Meter read, utility, unit of measure
  - Meter read, serial number (encoded only)

### 8.3 – Event Count

The RR4-TR maintains a lifetime count of all configuration change instances. (Example: displays as “Event 0001”.) The event count is displayed every 5<sup>th</sup> meter view (see section 8.2).

### 8.4 – Alerts

The Remote Reader displays an icon for active alerts. Freeze, leak, and low battery alerts are cleared automatically when the alert condition is no longer true.

Tamper alerts must be cleared manually using the Direct Connect or via the NextCentury Cloud (see section 6).

- Tamper Tamper  
RR4-TR removed from wall. Alert initial 30-minute hold-off for installation. Icon will remain until dismissed.
- Low Batt. Low Batt.  
Replace Battery (4-6 months remaining).

### 8.5 – Radio Signal-Strength

An RF indicator icon will appear immediately after the RR4-TR checks in. This indicator provides quick feedback to a technician of network signal strength.

- Radio Indicator  
Displays 1-3 bars based on the most recent check-in.

## 8| LCD Display (Cont.)

### 8.6 – Utility Types

The configured utility type is shown on the bottom left of the display.

- **All Water**
- **Cold Water**
- **Hot Water**
- **Commercial Water**
- **Gas**
- **Electric**
- **Run-Time**

### 8.7 – Units of Measure

The configured unit of measure is shown on the bottom right of the display.

- **Gallons** (water)
- **Liters** (water)
- **Cubic Feet** (water, gas)
- **Cubic Yards** (water, gas)
- **Cubic Meters** (water, gas)
- **Kilowatt Hour** (electric)
- **Watt Hour** (electric)
- **Hours** (run-time)
- **Minutes** (run-time)
- **Seconds** (run-time)

## 9| Television and Radio Interference

NOTE: This equipment has been tested and found to comply with the limits for a Class B digital device, pursuant to part 15 of the FCC Rules. These limits are designed to provide reasonable protection against harmful interference in a residential installation. This equipment generates, uses and can radiate radio frequency energy and, if not installed and used in accordance with the instructions, may cause harmful interference to radio communications. However, there is no guarantee that interference will not occur in a particular installation. If this equipment does cause harmful interference to radio or television reception, which can be determined by turning the equipment off and on, the user is encouraged to try to correct the interference by one or more of the following measures:

- Reorient or relocate the receiving antenna.
- Increase the separation between the equipment and receiver.
- Connect the equipment into an outlet on a circuit different from that to which the receiver is connected.
- Consult the dealer or an experienced radio/TV technician for help.

The FCC requires the user to be notified that any changes or modifications made to this device that are not expressly approved by Company Name may void the user's authority to operate the equipment.

### Radiation Exposure Statement:

This equipment complies with FCC radiation exposure limits set forth for an uncontrolled environment. This equipment should be installed and operated with minimum distance 20cm between the radiator & your body.

### As per 47 CFR §15.19

(All other devices shall bear the following statement in a conspicuous location on the device:

This device complies with part 15 of the FCC Rules. Operation is subject to the following two conditions: (1) This device may not cause harmful interference, and (2) this device must accept any interference received, including interference that may cause undesired operation.

### As per 47 CFR §15.21

The user's manual or instruction manual for an intentional or unintentional radiator shall caution the user that changes or modifications not expressly approved by the party responsible for compliance could void the user's authority to operate the equipment. In cases where the manual is provided only in a form other than paper, such as on a computer disk or over the Internet, the information required by this section may be included in the manual in that alternative form, provided the user can reasonably be expected to have the capability to access information in that form.

### ISED Statement

*This radio transmitter (identify the device by certification number) has been approved by Industry Canada to operate with the antenna types listed below with the maximum permissible gain indicated. Antenna types not included in this list, having a gain greater than the maximum gain indicated for that type, are strictly prohibited for use with this device.*

Immediately following the above notice, the manufacturer shall provide a list of all antenna types approved for use with the transmitter, indicating the maximum permissible antenna gain (in dBi).

### 8.4 User Manual Notice for Licence-Exempt Radio Apparatus

User manuals for license-exempt radio apparatus shall contain the following text, or an equivalent notice that shall be displayed in a conspicuous location, either in the user manual or on the device, or both:

*This device complies with Innovation, Science and Economic Development Canada's licence-exempt RSSs. Operation is subject to the following two conditions:*

- (1) This device may not cause interference; and*
- (2) This device must accept any interference, including interference that may cause undesired operation of the device.*

Cet appareil est conforme aux flux RSS exemptés de licence d'Innovation, Science et Développement économique Canada. L'opération est soumise aux deux conditions suivantes:

- (1) Cet appareil ne doit pas provoquer d'interférence; et

(2) Cet appareil doit accepter toute interférence, y compris les interférences susceptibles de provoquer un fonctionnement indésirable de l'appareil.

-----

#### **ISED Radiation Exposure Statement**

[English] Radiation Exposure Statement: This equipment complies with the IC RSS-102 radiation exposure limits set forth for an uncontrolled environment. This equipment should be installed and operated with a minimum distance of 20 cm between the radiator and your body.

[French] Énoncé d'exposition aux rayonnements: Cet équipement est conforme aux limites d'exposition aux rayonnements ioniques RSS-102 Pour un environnement incontrôlé. Cet équipement doit être installé et utilisé avec un Distance minimale de 20 cm entre le radiateur et votre corps.

---

## **12| Contact Information**

For any questions or concerns, please contact NextCentury Submetering Solutions Product Support:

- Phone: (844) 538.8203
- Email: [support@nextcenturymeters.com](mailto:support@nextcenturymeters.com)