

(FORM# RD-0400-06)

Model Name	AR9331
Page Name	Engineer
Size	Sheet 5
Rev	9

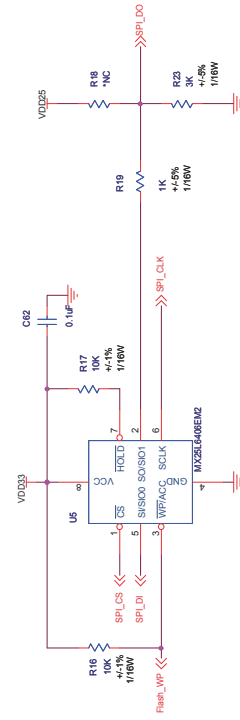

(FORM# RD-04000-06)

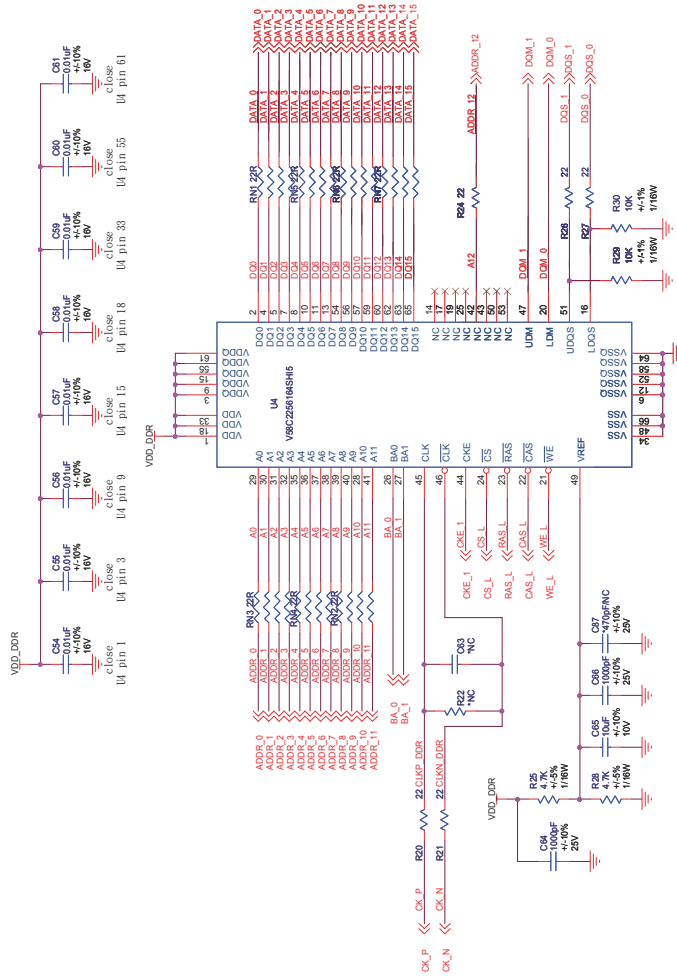
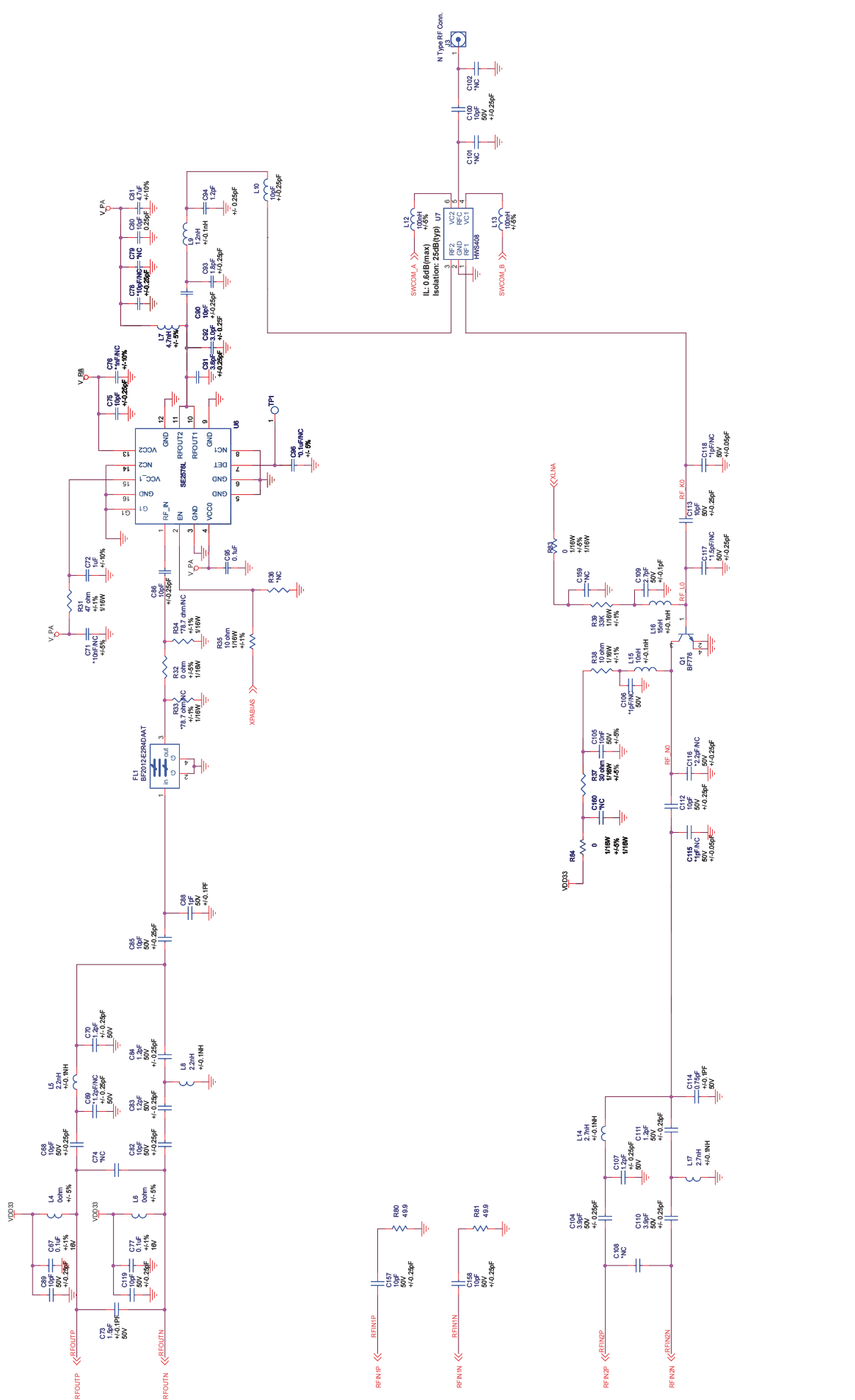

Model Name	Rev
Page Name	RF Front-ended
Size	Engineer
Sheet	7 of 9
Date	Wednesday, April 17, 2013

*All WAN and LAN ports support Auto-MDIX.

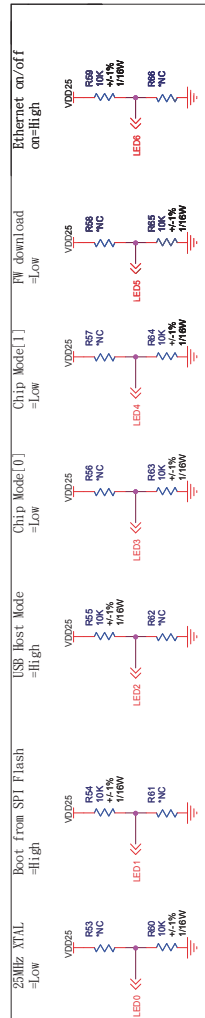
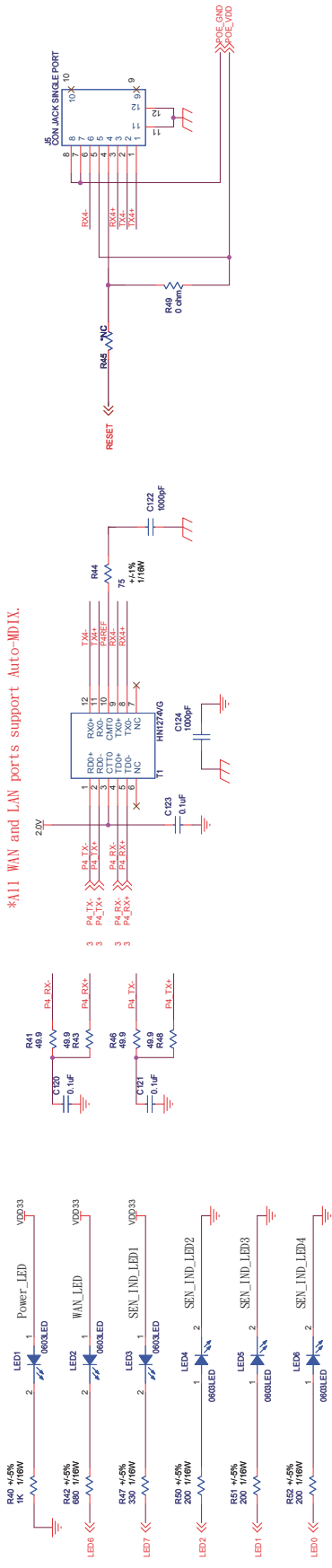

(FORM# RD-0400-06)

Model Name	Rev
Page Name	Engineer
Size	Sheet 8 of 9
Date	Wednesday, April 17, 2013

PNP TO GENERATE 2.0V For Ethernet Transformer

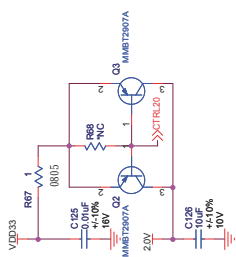

PNP GENERATE 2.5V For DDR1 SDRAM

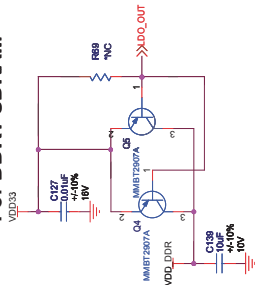

SWITCH REGULATOR GENERATE 1.2V

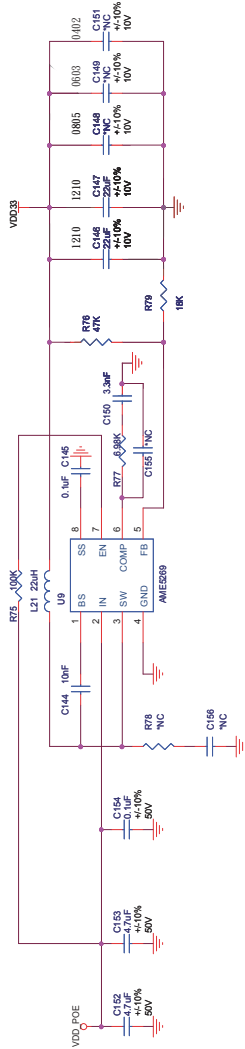
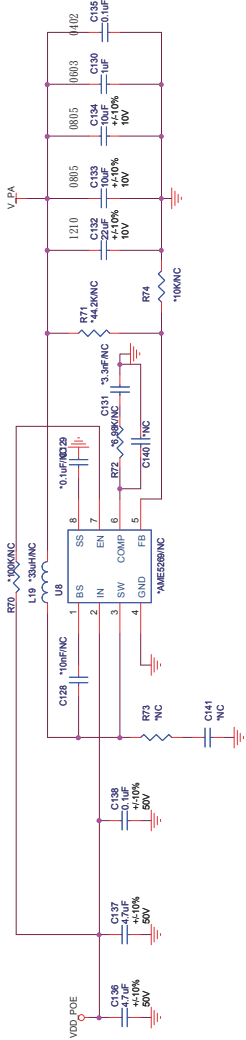
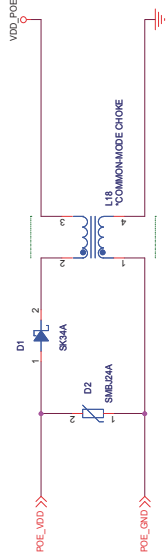
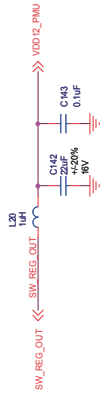

(FORM# RD-0400-06)

Model Name	Rev
Page Name	Power
Page	Webster, April 17, 2013
Sheet	9 of 9
Engineer	