



# FCC RADIO TEST REPORT

## FCC ID: 2AB87511

**Product :** 802.11n 150M Ultra Wireless LAN Router

**Trade Name :** ALFA

**Model Name :** AIP-W511, AIP-W511H, UR24, UR24H, FR24,  
FR24H

**Serial Model :** N/A

**Report No. :** NTEK-2014NT04210948

### Prepared for

Iconnect

No.9, Aly. 58, Ln. 112, Ruiguang Rd., Neihu Dist., Taipei City 114, Taiwan

### Prepared by

NTEK Testing Technology Co., Ltd.

1/F, Building E, Fenda Science Park, Sanwei Community, Xixiang Street  
Bao'an District, Shenzhen P.R. China

Tel.: +86-0755-61156588 Fax.: +86-0755-61156599

Website: [www.ntek.org.cn](http://www.ntek.org.cn)

## TEST RESULT CERTIFICATION

**Applicant's name** ..... : Iconnect  
Address ..... : No.9, Aly. 58, Ln. 112, Ruiguang Rd., Neihu Dist., Taipei City  
114, Taiwan

**Manufacture's Name** ..... : Iconnect  
Address ..... : No.9, Aly. 58, Ln. 112, Ruiguang Rd., Neihu Dist., Taipei City  
114, Taiwan

### Product description

Product name..... : 802.11n 150M Ultra Wireless LAN Router  
Model and/or type reference : AIP-W511,AIP-W511H,UR24,UR24H,FR24,FR24H  
Serial Model ..... : N/A  
DIFF ..... : All model's the function, software and electric circuit are the  
same , only with a product color and model named different.  
Test sample model: AIP-W511

**Standards** ..... : FCC Part15.247

Test procedure ..... ANSI C63.4-2003

This device described above has been tested by NTEK, and the test results show that the equipment under test (EUT) is in compliance with the FCC requirements. And it is applicable only to the tested sample identified in the report.

This report shall not be reproduced except in full, without the written approval of NTEK, this document may be altered or revised by NTEK, personal only, and shall be noted in the revision of the document.

**Date of Test**..... :

Date (s) of performance of tests..... : 01 June. 2013 ~07 June. 2013

Date of Issue ..... : 22 April. 2014

Test Result ..... : **Pass**

Testing Engineer : Apple Huang  
(Apple Huang)

Technical Manager : Tom Zhang  
(Tom Zhang)

Authorized Signatory : Bovey Yang  
(Bovey Yang)

**Table of Contents**

	<b>Page</b>
<b>1 . SUMMARY OF TEST RESULTS</b>	<b>5</b>
1.1 TEST FACILITY	6
1.2 MEASUREMENT UNCERTAINTY	6
<b>2 . GENERAL INFORMATION</b>	<b>7</b>
2.1 GENERAL DESCRIPTION OF EUT	7
2.2 DESCRIPTION OF TEST MODES	9
2.3 BLOCK DIGRAM SHOWING THE CONFIGURATION OF SYSTEM TESTED	10
2.4 DESCRIPTION OF SUPPORT UNITS(CONDUCTED MODE)	11
2.5 EQUIPMENTS LIST FOR ALL TEST ITEMS	12
<b>3 . EMC EMISSION TEST</b>	<b>13</b>
3.1 CONDUCTED EMISSION MEASUREMENT	13
3.1.1 POWER LINE CONDUCTED EMISSION LIMITS	13
3.1.2 TEST PROCEDURE	14
3.1.3 DEVIATION FROM TEST STANDARD	14
3.1.4 TEST SETUP	14
3.1.5 EUT OPERATING CONDITIONS	14
3.1.6 TEST RESULTS	15
3.2 RADIATED EMISSION MEASUREMENT	17
3.2.1 RADIATED EMISSION LIMITS	17
3.2.2 TEST PROCEDURE	18
3.2.3 DEVIATION FROM TEST STANDARD	18
3.2.4 TEST SETUP	19
3.2.5 EUT OPERATING CONDITIONS	20
3.2.6 TEST RESULTS (BETWEEN 9KHZ – 30 MHZ)	21
3.2.7 TEST RESULTS (BETWEEN 30MHZ – 1GHZ)	22
3.2.8 TEST RESULTS (ABOVE 1000 MHZ)	24
3.2.9 TEST RESULTS (RESTRICTED BANDS REQUIREMENTS)	36
<b>4 . POWER SPECTRAL DENSITY TEST</b>	<b>52</b>
4.1 APPLIED PROCEDURES / LIMIT	52
4.1.1 TEST PROCEDURE	52
4.1.2 DEVIATION FROM STANDARD	52
4.1.3 TEST SETUP	52
4.1.4 EUT OPERATION CONDITIONS	52
4.1.5 TEST RESULTS	53
<b>5 . BANDWIDTH TEST</b>	<b>61</b>
5.1 APPLIED PROCEDURES / LIMIT	61

**Table of Contents**

	<b>Page</b>
5.1.1 TEST PROCEDURE	61
5.1.2 DEVIATION FROM STANDARD	61
5.1.3 TEST SETUP	61
5.1.4 EUT OPERATION CONDITIONS	61
5.1.5 TEST RESULTS	62
<b>6 . PEAK OUTPUT POWER TEST</b>	<b>70</b>
6.1 APPLIED PROCEDURES / LIMIT	70
6.1.1 TEST PROCEDURE	70
6.1.2 DEVIATION FROM STANDARD	70
6.1.3 TEST SETUP	70
6.1.4 EUT OPERATION CONDITIONS	70
6.1.5 TEST RESULTS	71
<b>7 . ANTENNA REQUIREMENT</b>	<b>72</b>
7.1 STANDARD REQUIREMENT	72
7.2 EUT ANTENNA	72
<b>8 . EUT TEST PHOTO</b>	<b>73</b>
<b>APPENDIX-PHOTOGRAPHS OF EUT CONSTRUCTIONAL DETAILS</b>	

## 1. SUMMARY OF TEST RESULTS

Test procedures according to the technical standards:

<b>FCC Part15 (15.247) , Subpart C</b>			
<b>Standard Section</b>	<b>Test Item</b>	<b>Judgment</b>	<b>Remark</b>
15.207	Conducted Emission	PASS	
15.247 (a)(2)	6dB Bandwidth	PASS	
15.247 (b)	Peak Output Power	PASS	
15.247 (c)	Radiated Spurious Emission	PASS	
15.247 (d)	Power Spectral Density	PASS	
15.205	Band Edge Emission	PASS	
15.203	Antenna Requirement	PASS	

**NOTE:**

(1) "N/A" denotes test is not applicable in this Test Report

## 1.1 TEST FACILITY

NTEK Testing Technology Co., Ltd

Add.:1/F, Building E, Fenda Science Park, Sanwei Community, Xixiang Street, Bao'an District, Shenzhen P.R. China.

FCC Registration No.:238937; IC Registration No.:9270A-1

CNAS Registration No.:L5516

## 1.2 MEASUREMENT UNCERTAINTY

The reported uncertainty of measurement  $y \pm U$ , where expanded uncertainty  $U$  is based on a standard uncertainty multiplied by a coverage factor of  $k=2$ , providing a level of confidence of approximately **95 %**.

No.	Item	Uncertainty
1	Conducted Emission Test	$\pm 1.38\text{dB}$
2	RF power,conducted	$\pm 0.16\text{dB}$
3	Spurious emissions,conducted	$\pm 0.21\text{dB}$
4	All emissions,radiated(<1G)	$\pm 4.68\text{dB}$
5	All emissions,radiated(>1G)	$\pm 4.89\text{dB}$
6	Temperature	$\pm 0.5^\circ\text{C}$
7	Humidity	$\pm 2\%$

## 2. GENERAL INFORMATION

### 2.1 GENERAL DESCRIPTION OF EUT

Equipment	802.11n 150M Ultra Wireless LAN Router														
Trade Name	ALFA														
Model Name	AIP-W511,AIP-W511H,UR24,UR24H,FR24,FR24H														
Serial Model	N/A														
Model Difference	All model's the function, software and electric circuit are the same , only with a product color and model named different. Test sample model: AIP-W511														
Product Description	<p>The EUT is a 802.11n 150M Ultra Wireless LAN Router</p> <table border="1"> <tr> <td>Operation Frequency:</td> <td>802.11b/g/n 20:2412~2462 MHz 802.11n 40: 2422~2452MHz</td> </tr> <tr> <td>Modulation Type:</td> <td>CCK/OFDM/DBPSK/DAPSK</td> </tr> <tr> <td>Bit Rate of Transmitter</td> <td>802.11b:11/5.5/2/1 Mbps 802.11g:54/48/36/24/18/12/9/6Mbps 802.11n(20/40MHz):300/150/144.44/130/117/115.56/104/86.67/78/52/6.5 Mbps</td> </tr> <tr> <td>Number Of Channel</td> <td>802.11b/g/n20: 11CH 802.11n 40: 7CH</td> </tr> <tr> <td>Antenna Designation:</td> <td>Please see Note 3.</td> </tr> <tr> <td>Peak Output Power(Conducted):</td> <td>802.11b: 9.24 dBm (Max.) 802.11g: 8.25 dBm (Max.) 802.11n(20MHz): 7.88 dBm (Max.) 802.11n(40MHz): 7.09 dBm (Max.)</td> </tr> <tr> <td>Antenna Gain (dBi)</td> <td>1 dBi</td> </tr> </table> <p>Based on the application, features, or specification exhibited in User's Manual, the EUT is considered as an ITE/Computing Device. More details of EUT technical specification, please refer to the User's Manual.</p>	Operation Frequency:	802.11b/g/n 20:2412~2462 MHz 802.11n 40: 2422~2452MHz	Modulation Type:	CCK/OFDM/DBPSK/DAPSK	Bit Rate of Transmitter	802.11b:11/5.5/2/1 Mbps 802.11g:54/48/36/24/18/12/9/6Mbps 802.11n(20/40MHz):300/150/144.44/130/117/115.56/104/86.67/78/52/6.5 Mbps	Number Of Channel	802.11b/g/n20: 11CH 802.11n 40: 7CH	Antenna Designation:	Please see Note 3.	Peak Output Power(Conducted):	802.11b: 9.24 dBm (Max.) 802.11g: 8.25 dBm (Max.) 802.11n(20MHz): 7.88 dBm (Max.) 802.11n(40MHz): 7.09 dBm (Max.)	Antenna Gain (dBi)	1 dBi
Operation Frequency:	802.11b/g/n 20:2412~2462 MHz 802.11n 40: 2422~2452MHz														
Modulation Type:	CCK/OFDM/DBPSK/DAPSK														
Bit Rate of Transmitter	802.11b:11/5.5/2/1 Mbps 802.11g:54/48/36/24/18/12/9/6Mbps 802.11n(20/40MHz):300/150/144.44/130/117/115.56/104/86.67/78/52/6.5 Mbps														
Number Of Channel	802.11b/g/n20: 11CH 802.11n 40: 7CH														
Antenna Designation:	Please see Note 3.														
Peak Output Power(Conducted):	802.11b: 9.24 dBm (Max.) 802.11g: 8.25 dBm (Max.) 802.11n(20MHz): 7.88 dBm (Max.) 802.11n(40MHz): 7.09 dBm (Max.)														
Antenna Gain (dBi)	1 dBi														
Channel List	Please refer to the Note 2.														
Ratings	DC 3.7V														
Adapter	AC Power Input: 100-240V~, 50/60Hz, 0.4A Output: 5.0V  2.5A														
Battery	Rated Voltage: 3.7V Charge Limit: 4.2V Capacity :2800mAh														
Connecting I/O Port(s)	Please refer to the User's Manual														

Note:

1. For a more detailed features description, please refer to the manufacturer's specifications or the User's Manual.

2.

Channel List for 802.11b/g/n(20MHz)							
Channel	Frequency (MHz)	Channel	Frequency (MHz)	Channel	Frequency (MHz)	Channel	Frequency (MHz)
01	2412	04	2427	07	2442	10	2457
02	2417	05	2432	08	2447	11	2462
03	2422	06	2437	09	2452		

Channel List for 802.11n(40MHz)							
Channel	Frequency (MHz)	Channel	Frequency (MHz)	Channel	Frequency (MHz)	Channel	Frequency (MHz)
03	2422	06	2437	09	2452		
04	2427	07	2442				
05	2432	08	2447				

3.

Table for Filed Antenna

Ant .	Brand	Model Name	Antenna Type	Connector	Gain (dBi)	NOTE
A	N/A	N/A	Integral Antenna	N/A	1	N/A



## 2.2 DESCRIPTION OF TEST MODES

To investigate the maximum EMI emission characteristics generates from EUT, the test system was pre-scanning tested base on the consideration of following EUT operation mode or test configuration mode which possible have effect on EMI emission level. Each of these EUT operation mode(s) or test configuration mode(s) mentioned above was evaluated respectively.

Pretest Mode	Description
Mode 1	802.11b CH1/ CH6/ CH11
Mode 2	802.11g CH1/ CH6/ CH11
Mode 3	802.11n(20)CH1/ CH6/ CH11
Mode 4	802.11n(40) CH3/ CH6/ CH9
Mode 5	Link Mode

For Conducted Emission	
Final Test Mode	Description
Mode 5	Link Mode

For Radiated Emission	
Final Test Mode	Description
Mode 1	802.11b CH1/ CH6/ CH11
Mode 2	802.11g CH1/ CH6/ CH11
Mode 3	802.11n CH1/ CH6/ CH11
Mode 4	802.11n(40) CH3/ CH6/ CH9

Note:

- (1) The measurements are performed at the highest, middle, lowest available channels.
- (2) The measurements are performed at all Bit Rate of Transmitter, the worst data was reported

### 2.3 BLOCK DIGRAM SHOWING THE CONFIGURATION OF SYSTEM TESTED

Conducted Measurement:

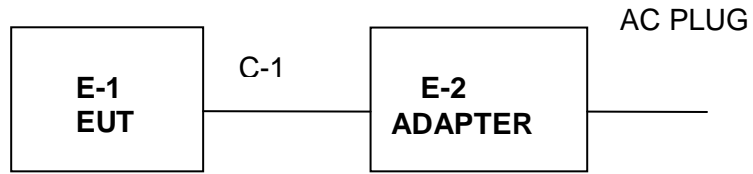

Radiated Measurement:

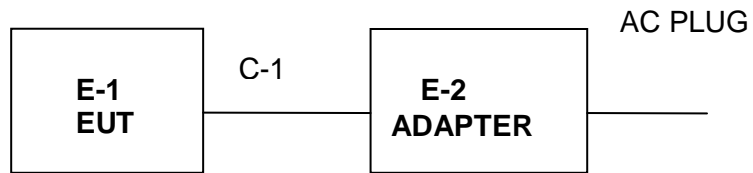

**2.4 DESCRIPTION OF SUPPORT UNITS(CONDUCTED MODE)**

The EUT has been tested as an independent unit together with other necessary accessories or support units. The following support units or accessories were used to form a representative test configuration during the tests.

Item	Equipment	Mfr/Brand	Model/Type No.	Series No.	Note
E-1	802.11n 150M Ultra Wireless LAN Router	N/A	AIP-W511	N/A	EUT
E-2	Adapter	N/A	GFP051U-050050-Q	N/A	

Item	Shielded Type	Ferrite Core	Length	Note
C-1	NO	NO	0.8m	

Note:

- (1) The support equipment was authorized by Declaration of Confirmation.
- (2) For detachable type I/O cable should be specified the length in cm in 『Length』 column.

## 2.5 EQUIPMENTS LIST FOR ALL TEST ITEMS

### Radiation Test equipment

Item	Kind of Equipment	Manufacturer	Type No.	Serial No.	Calibrated until
1	Spectrum Analyzer	Agilent	E4407B	160400005	Jul. 06. 2013
2	Test Receiver	R&S	ESPI	101318	Jul. 06. 2013
3	Bilog Antenna	TESEQ	CBL6111D	31216	Jul. 06. 2013
4	50Ω Coaxial Switch	Anritsu	MP59B	6200264416	Jul. 06. 2013
5	Spectrum Analyzer	ADVANTEST	R3132	150900201	Jul. 06. 2013
6	Horn Antenna	EM	EM-AH-10180	2011071402	Jul. 06. 2013
7	Horn Ant	Schwarzbeck	BBHA 9170	9170-181	Jul. 06. 2013
8	Amplifier	EM	EM-30180	060538	Jul. 06. 2013
9	Loop Antenna	ARA	PLA-1030/B	1029	Jul. 06. 2013
10	Power Meter	R&S	NRVS	100696	Jul. 06. 2013
11	Power Sensor (Peak)	R&S	NRV-Z31	0396.0101.19	Jul. 06., 2013

### Conduction Test equipment

Item	Kind of Equipment	Manufacturer	Type No.	Serial No.	Calibrated until
1	Test Receiver	R&S	ESCI	101160	Jul. 06. 2013
2	LISN	R&S	ENV216	101313	Jul. 06. 2013
3	LISN	EMCO	3816/2	00042990	Jul. 06. 2013
4	50Ω Coaxial Switch	Anritsu	MP59B	6200264417	Jul. 06. 2013
5	Passive Voltage Probe	R&S	ESH2-Z3	100196	Jul. 06. 2013
6	Absorbing clamp	R&S	MOS-21	100423	Jul. 06. 2013

### 3. EMC EMISSION TEST

#### 3.1 CONDUCTED EMISSION MEASUREMENT

##### 3.1.1 POWER LINE CONDUCTED EMISSION Limits (Frequency Range 150KHz-30MHz)

FREQUENCY (MHz)	Class A (dBuV)		Class B (dBuV)		Standard
	Quasi-peak	Average	Quasi-peak	Average	
0.15 -0.5	79.00	66.00	66 - 56 *	56 - 46 *	CISPR
0.50 -5.0	73.00	60.00	56.00	46.00	CISPR
5.0 -30.0	73.00	60.00	60.00	50.00	CISPR

0.15 -0.5	79.00	66.00	66 - 56 *	56 - 46 *	FCC
0.50 -5.0	73.00	60.00	56.00	46.00	FCC
5.0 -30.0	73.00	60.00	60.00	50.00	FCC

Note:

- (1) The tighter limit applies at the band edges.
- (2) The limit of " \* " marked band means the limitation decreases linearly with the logarithm of the frequency in the range.

The following table is the setting of the receiver

Receiver Parameters	Setting
Attenuation	10 dB
Start Frequency	0.15 MHz
Stop Frequency	30 MHz
IF Bandwidth	9 kHz

**3.1.2 TEST PROCEDURE**

- a. The EUT was placed 0.4 meters from the horizontal ground plane with EUT being connected to the power mains through a line impedance stabilization network (LISN). All other support equipments powered from additional LISN(s). The LISN provide 50 Ohm/ 50uH of coupling impedance for the measuring instrument.
- b. Interconnecting cables that hang closer than 40 cm to the ground plane shall be folded back and forth in the center forming a bundle 30 to 40 cm long.
- c. I/O cables that are not connected to a peripheral shall be bundled in the center. The end of the cable may be terminated, if required, using the correct terminating impedance. The overall length shall not exceed 1 m.
- d. LISN at least 80 cm from nearest part of EUT chassis.
- e. For the actual test configuration, please refer to the related Item –EUT Test Photos.

**3.1.3 DEVIATION FROM TEST STANDARD**

No deviation

**3.1.4 TEST SETUP**

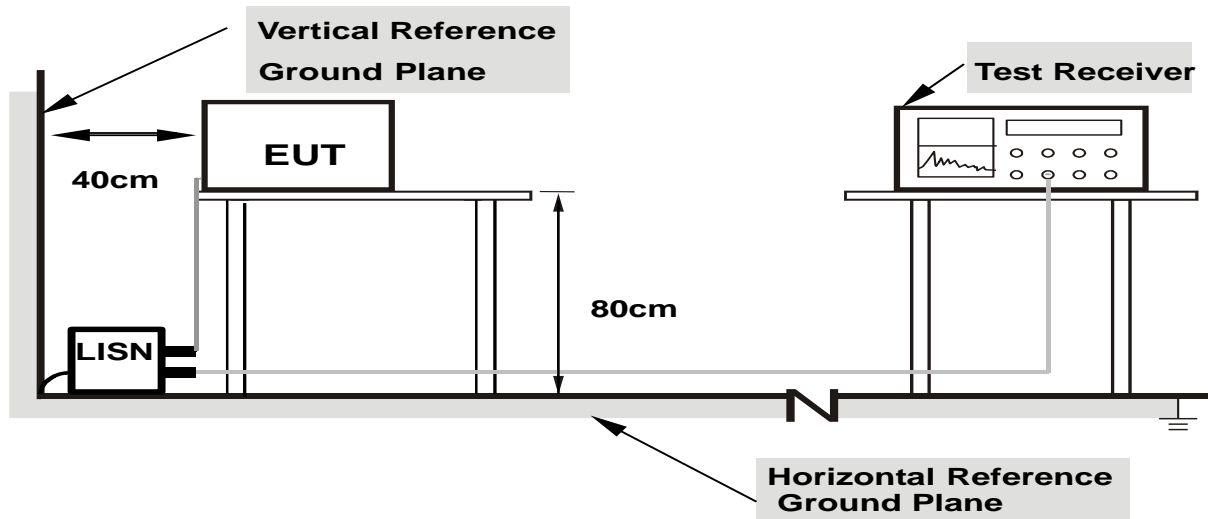

- Note: 1.Support units were connected to second LISN.**  
**2.Both of LISNs (AMN) are 80 cm from EUT and at least 80 from other units and other metal planes**

**3.1.5 EUT OPERATING CONDITIONS**

The EUT was configured for testing in a typical fashion (as a customer would normally use it). The EUT has been programmed to continuously transmit during test. This operating condition was tested and used to collect the included data.

### 3.1.6 TEST RESULTS

EUT :	802.11n 150M Ultra Wireless LAN Router	Model Name. :	AIP-W511
Temperature :	26 °C	Relative Humidity :	54%
Pressure :	1010hPa	Phase :	L
Test Voltage :	DC 5 V from Adapter AC120V/60Hz	Test Mode :	Mode 5

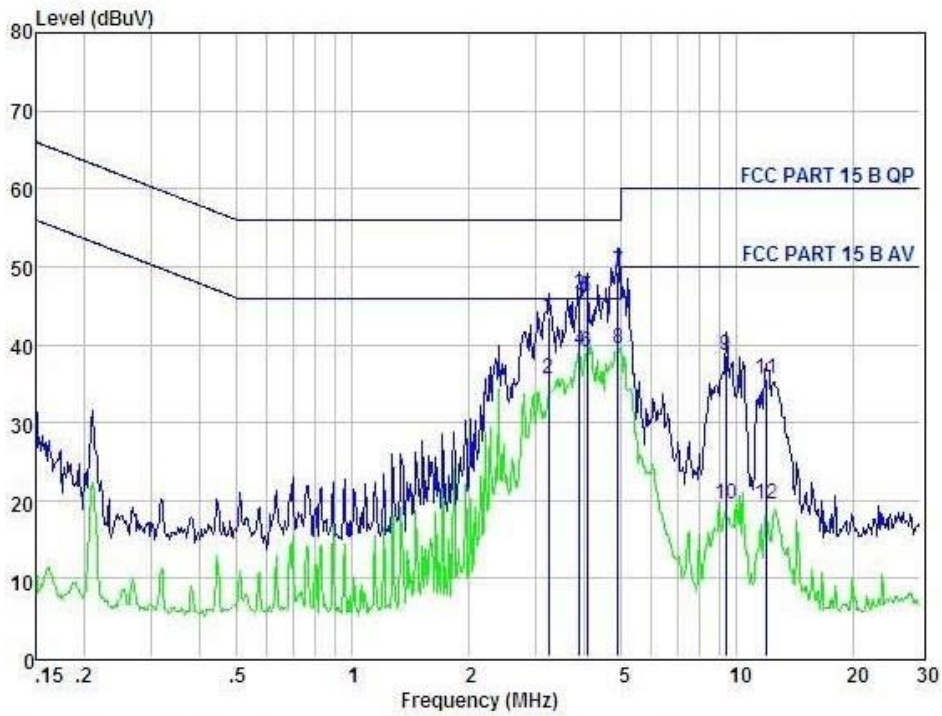

Condition : FCC PART 15 B QP

POL: LINE

Item	Freq MHz	Read dBuV	LISN Factor dB	Preamp Factor dB	Cable Loss dB	Level dBuV	Limit dBuV	Margin dBuV	Remark
1	3.241	33.75	0.07	-9.69	0.12	43.63	56.00	-12.37	QP
2	3.241	25.75	0.07	-9.69	0.12	35.63	46.00	-10.37	Average
3	3.901	36.46	0.08	-9.69	0.12	46.35	56.00	-9.65	QP
4	3.901	29.46	0.08	-9.69	0.12	39.35	46.00	-6.65	Average
5	4.070	36.23	0.08	-9.69	0.12	46.12	56.00	-9.88	QP
6	4.070	29.23	0.08	-9.69	0.12	39.12	46.00	-6.88	Average
7	4.900	39.49	0.10	-9.68	0.12	49.39	56.00	-6.61	QP
8	4.900	29.49	0.10	-9.68	0.12	39.39	46.00	-6.61	Average
9	9.352	28.82	0.17	-9.38	0.19	38.56	60.00	-21.44	QP
10	9.352	9.82	0.17	-9.38	0.19	19.56	50.00	-30.44	Average
11	11.933	25.55	0.26	-9.47	0.22	35.50	60.00	-24.50	QP
12	11.933	9.55	0.26	-9.47	0.22	19.50	50.00	-30.50	Average

EUT :	802.11n 150M Ultra Wireless LAN Router	Model Name. :	AIP-W511
Temperature :	26 °C	Relative Humidity :	54%
Pressure :	1010hPa	Phase :	N
Test Voltage :	DC 5 V from Adapter AC120V/60Hz	Test Mode :	Mode 5

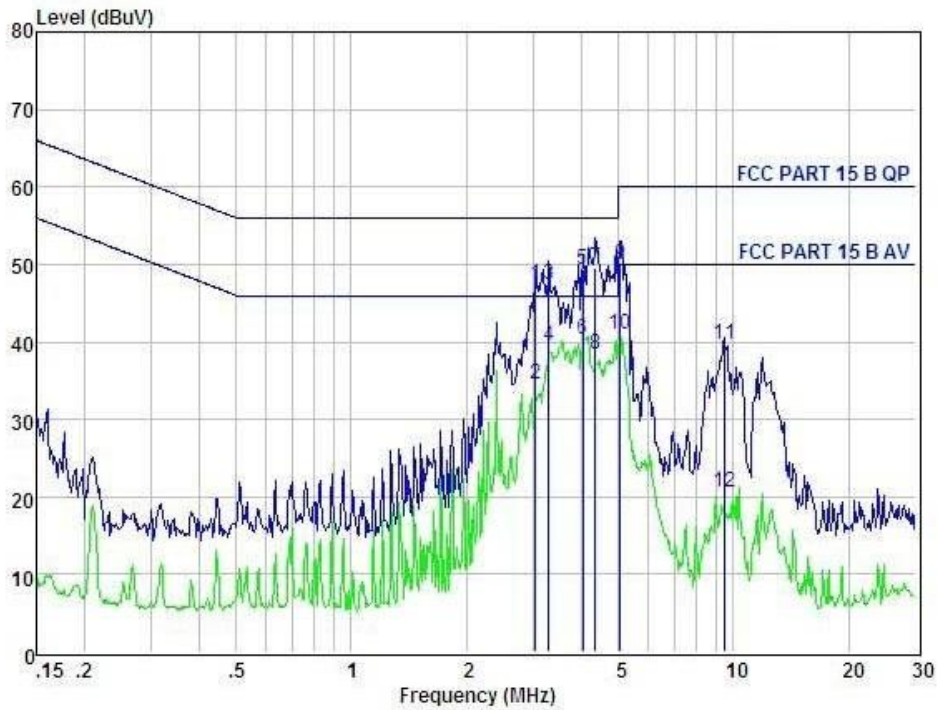

Condition : FCC PART 15 B QP POL: NEUTRAL

Item	Freq MHz	Read dBuV	LISN Factor dB	Preamp Factor dB	Cable Loss dB	Level dBuV	Limit dBuV	Margin dBuV	Remark
1	3.041	37.54	0.07	-9.69	0.12	47.42	56.00	-8.58	QP
2	3.041	24.54	0.07	-9.69	0.12	34.42	46.00	-11.58	Average
3	3.293	37.60	0.07	-9.69	0.12	47.48	56.00	-8.52	QP
4	3.293	29.60	0.07	-9.69	0.12	39.48	46.00	-6.52	Average
5	4.027	39.47	0.08	-9.69	0.12	49.36	56.00	-6.64	QP
6	4.027	30.47	0.08	-9.69	0.12	40.36	46.00	-5.64	Average
7	4.361	39.59	0.09	-9.68	0.12	49.48	56.00	-6.52	QP
8	4.361	28.59	0.09	-9.68	0.12	38.48	46.00	-7.52	Average
9	5.058	40.10	0.10	-9.68	0.12	50.00	60.00	-10.00	QP
10	5.058	31.10	0.10	-9.68	0.12	41.00	50.00	-9.00	Average
11	9.451	29.89	0.17	-9.38	0.19	39.63	60.00	-20.37	QP
12	9.451	10.89	0.17	-9.38	0.19	20.63	50.00	-29.37	Average



### 3.2 RADIATED EMISSION MEASUREMENT

#### 3.2.1 RADIATED EMISSION LIMITS (Frequency Range 9kHz-1000MHz)

20dBc in any 100 kHz bandwidth outside the operating frequency band. In case the emission fall within the restricted band specified on 15.205(a), then the 15.209(a) limit in the table below has to be followed.

Frequencies (MHz)	Field Strength (micovolts/meter)	Measurement Distance (meters)
0.009~0.490	2400/F(KHz)	300
0.490~1.705	24000/F(KHz)	30
1.705~30.0	30	30
30~88	100	3
88~216	150	3
216~960	200	3
Above 960	500	3

#### LIMITS OF RADIATED EMISSION MEASUREMENT (Above 1000MHz)

FREQUENCY (MHz)	Class A (dBuV/m) (at 3M)		Class B (dBuV/m) (at 3M)	
	PEAK	AVERAGE	PEAK	AVERAGE
Above 1000	80	60	74	54

Notes:

- (1) The limit for radiated test was performed according to FCC PART 15C.
- (2) The tighter limit applies at the band edges.
- (3) Emission level (dBuV/m)=20log Emission level (uV/m).

Spectrum Parameter	Setting
Attenuation	Auto
Start Frequency	1000 MHz
Stop Frequency	10th carrier harmonic
RB / VB (emission in restricted band)	1 MHz / 1 MHz for Peak, 1 MHz / 10Hz for Average

Receiver Parameter	Setting
Attenuation	Auto
Start ~ Stop Frequency	9kHz~150kHz / RB 200Hz for QP
Start ~ Stop Frequency	150kHz~30MHz / RB 9kHz for QP
Start ~ Stop Frequency	30MHz~1000MHz / RB 120kHz for QP

### 3.2.2 TEST PROCEDURE

- a. The measuring distance of at 3 m shall be used for measurements at frequency up to 1GHz. For frequencies above 1GHz, any suitable measuring distance may be used.
- b. The EUT was placed on the top of a rotating table 0.8 meters above the ground at a 3 meter open area test site. The table was rotated 360 degrees to determine the position of the highest radiation.
- c. The height of the equipment or of the substitution antenna shall be 0.8 m; the height of the test antenna shall vary between 1 m to 4 m. Both horizontal and vertical polarizations of the antenna are set to make the measurement.
- d. The initial step in collecting conducted emission data is a spectrum analyzer peak detector mode pre-scanning the measurement frequency range. Significant peaks are then marked and then Quasi Peak detector mode re-measured.
- e. If the Peak Mode measured value compliance with and lower than Quasi Peak Mode Limit, the EUT shall be deemed to meet QP Limits and then no additional QP Mode measurement performed.
- f. For the actual test configuration, please refer to the related Item –EUT Test Photos.

Note:

Both horizontal and vertical antenna polarities were tested and performed pretest to three orthogonal axis. The worst case emissions were reported

### 3.2.3 DEVIATION FROM TEST STANDARD

No deviation

### 3.2.4 TEST SETUP

(A) Radiated Emission Test-Up Frequency Below 30MHz

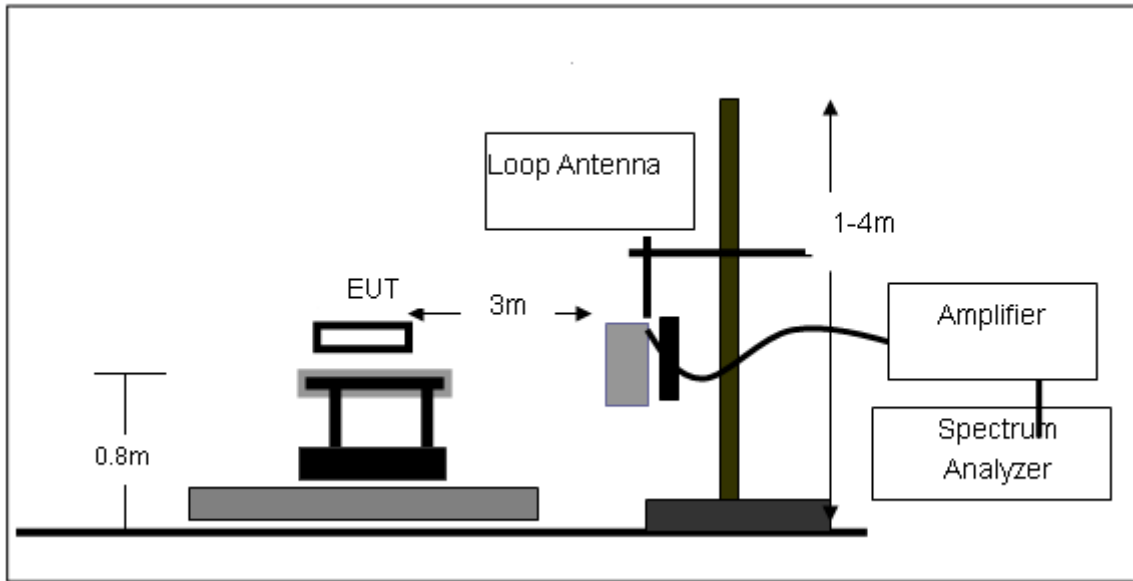

(B) Radiated Emission Test-Up Frequency 30MHz~1GHz

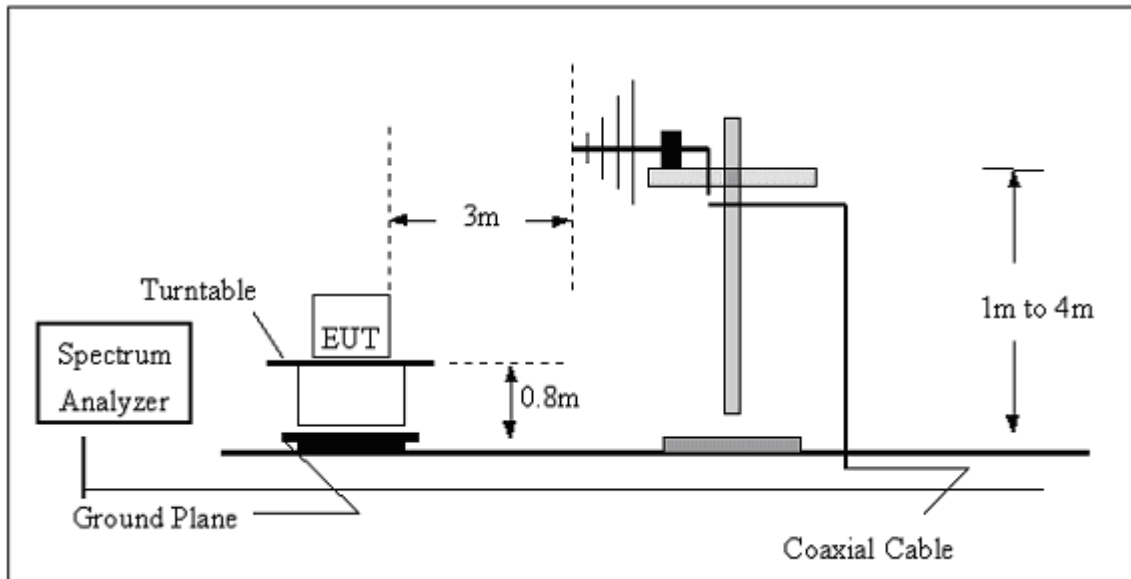

(C) Radiated Emission Test-Up Frequency Above 1GHz

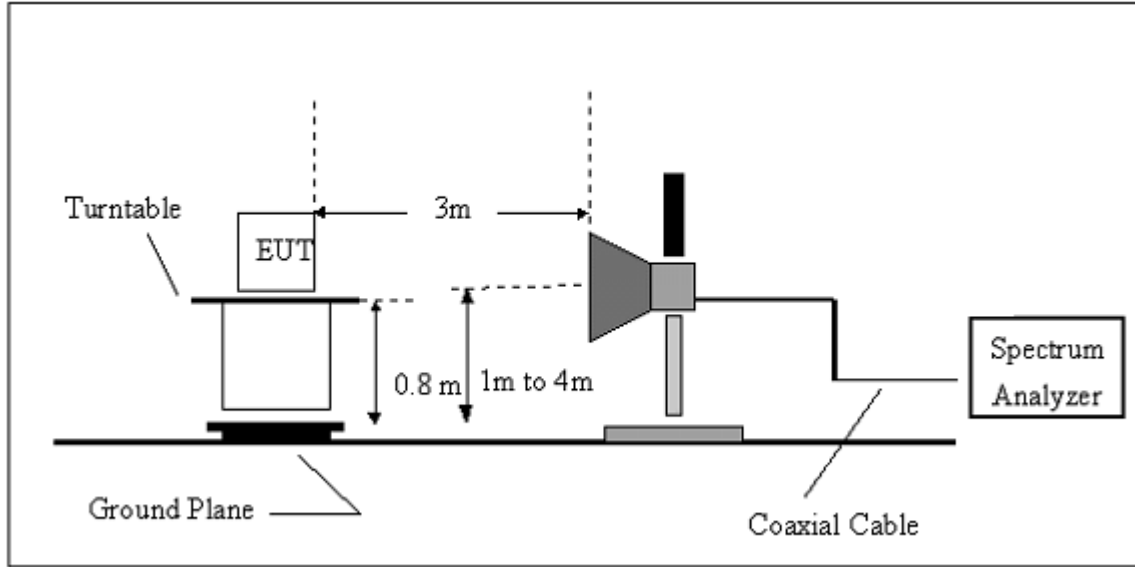

**3.2.5 EUT OPERATING CONDITIONS**

The EUT tested system was configured as the statements of 2.3 Unless otherwise a special operating condition is specified in the follows during the testing.

**3.2.6 TEST RESULTS (BETWEEN 9KHZ – 30 MHZ)**

EUT:	802.11n 150M Ultra Wireless LAN Router	Model Name. :	AIP-W511
Temperature:	20 °C	Relative Humidity:	48%
Pressure:	1010 hPa	Test Voltage :	DC 3.7V
Test Mode :	Link mode	Polarization :	--

Freq.	Reading	Limit	Margin	State
(MHz)	(dBuV/m)	(dBuV/m)	(dB)	P/F
--	--	--	--	PASS
--	--	--	--	PASS

**NOTE:**

The amplitude of spurious emissions which are attenuated by more than 20dB below the permissible value has no need to be reported.

Distance extrapolation factor =  $40 \log (\text{specific distance}/\text{test distance})(\text{dB})$ ;

Limit line = specific limits(dBuv) + distance extrapolation factor.

### 3.2.7 TEST RESULTS (BETWEEN 30MHZ – 1GHZ)

EUT :	802.11n 150M Ultra Wireless LAN Router	Model Name :	AIP-W511
Temperature :	20 °C	Relative Humidity :	48%
Pressure :	1010 hPa	Test Voltage :	DC 3.7V
Test Mode :	Link mode	Polarization :	Horizontal

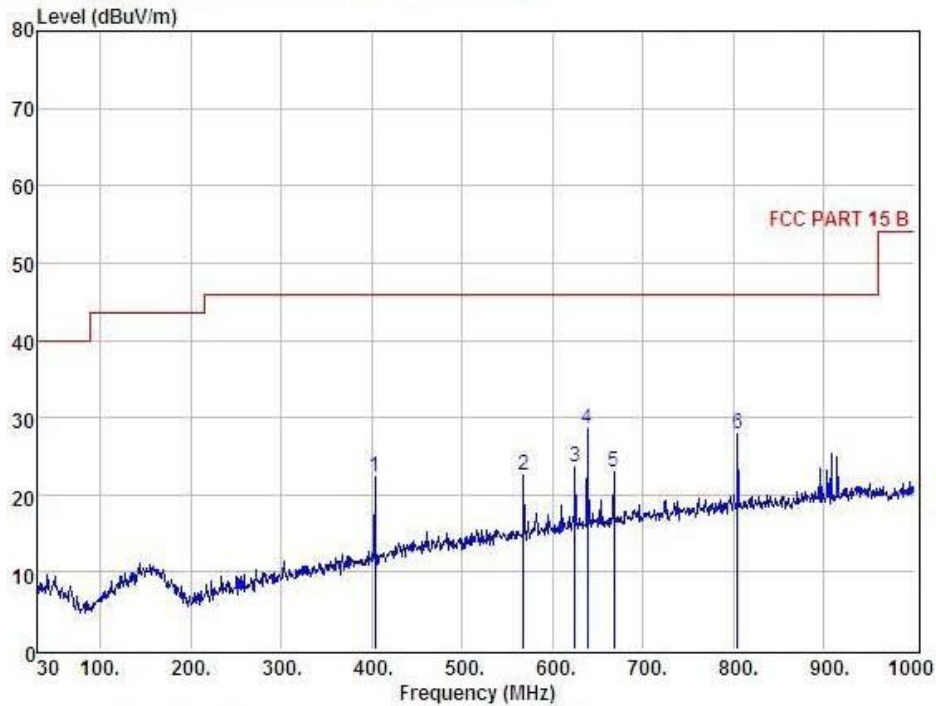

Condition : FCC PART 15 B 3m POL: HORIZONTAL

Item	Freq MHz	Read Level dBuV	Antenna Factor dB	Preamp Factor dB	Cable Loss dB	Level dBuV	Limit dBuV	Margin dBuV	Remark
1	403.45	36.51	14.84	31.43	2.48	22.40	46.00	-23.60	QP
2	567.38	33.45	17.67	31.74	3.13	22.51	46.00	-23.49	QP
3	624.61	33.32	18.76	31.81	3.25	23.52	46.00	-22.48	QP
4	638.19	38.13	18.94	31.80	3.28	28.55	46.00	-17.45	QP
5	667.29	32.04	19.30	31.78	3.33	22.89	46.00	-23.11	QP
6	804.06	35.16	20.73	31.65	3.61	27.85	46.00	-18.15	QP

EUT :	802.11n 150M Ultra Wireless LAN Router	Model Name :	AIP-W511
Temperature :	20 °C	Relative Humidity :	48%
Pressure :	1010 hPa	Test Voltage :	DC 3.7V
Test Mode :	Link mode	Polarization :	Vertical

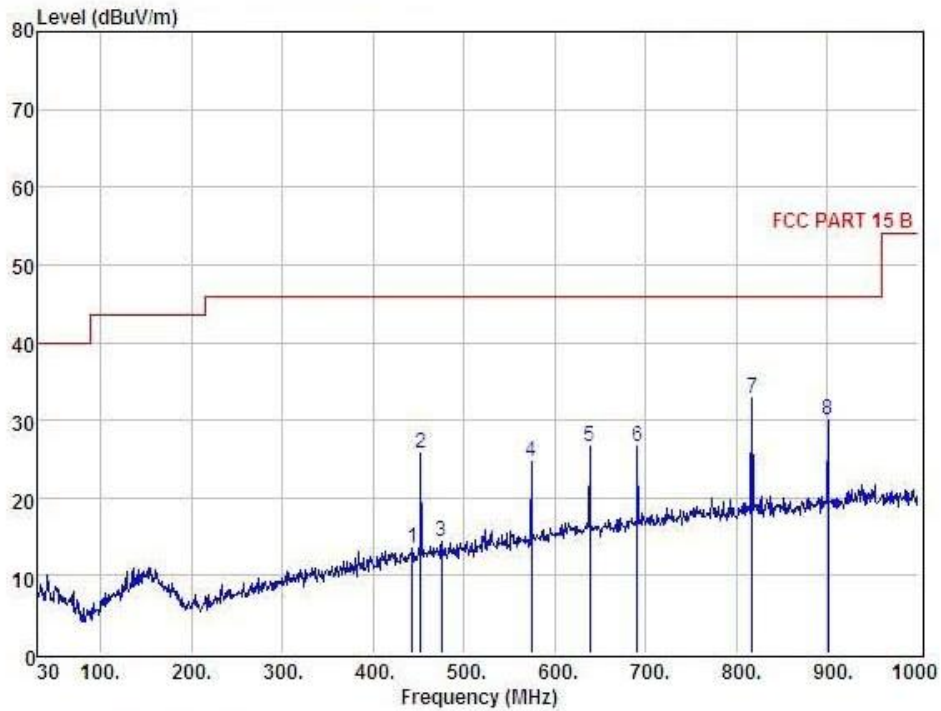

Condition : FCC PART 15 B 3m POL: VERTICAL									
Item	Freq MHz	Read Level dBuV	Antenna Factor dB	Preamp Factor dB	Cable Loss dB	Level dBuV	Limit dBuV	Margin dBuV	Remark
1	443.22	26.57	15.82	31.47	2.69	13.61	46.00	-32.39	QP
2	451.95	38.49	15.99	31.49	2.74	25.73	46.00	-20.27	QP
3	475.23	26.78	16.20	31.55	2.87	14.30	46.00	-31.70	QP
4	574.17	35.44	17.81	31.76	3.15	24.64	46.00	-21.36	QP
5	638.19	36.10	18.94	31.80	3.28	26.52	46.00	-19.48	QP
6	690.57	35.37	19.56	31.77	3.38	26.54	46.00	-19.46	QP
7	816.67	39.97	20.80	31.67	3.63	32.73	46.00	-13.27	QP
8	900.09	36.12	21.64	31.64	3.80	29.92	46.00	-16.08	QP

**3.2.8 TEST RESULTS (ABOVE 1000 MHZ)**

EUT :	802.11n 150M Ultra Wireless LAN Router	Model Name :	AIP-W511
Temperature :	20 °C	Relative Humidity :	48%
Pressure :	1010 hPa	Test Voltage :	DC 3.7V
Test Mode :	CH1 (802.11b Mode)/2412	Polarization :	Horizontal

Frequency (MHz)	Meter Reading (dBµV)	Factor (dB)	Emission Level (dBµV/m)	Limits (dBµV/m)	Margin (dB)	Value Type
4824.15	47.77	10.44	58.21	74	-15.79	peak
4824.15	32.42	10.44	42.86	54	-11.14	AVG
7236.149	43.09	12.39	55.48	74	-18.52	peak
7236.149	27.85	12.39	40.24	54	-13.76	AVG

Remark:  
Factor = Antenna Factor + Cable Loss – Pre-amplifier.

EUT :	802.11n 150M Ultra Wireless LAN Router	Model Name :	AIP-W511
Temperature :	20 °C	Relative Humidity :	48%
Pressure :	1010 hPa	Test Voltage :	DC 3.7V
Test Mode :	CH1 (802.11b Mode)/2412	Polarization :	Vertical

Frequency (MHz)	Meter Reading (dBµV)	Factor (dB)	Emission Level (dBµV/m)	Limits (dBµV/m)	Margin (dB)	Value Type
4874.145	48.99	10.4	59.39	74	-14.61	peak
4874.145	32.74	10.4	43.14	54	-10.86	AVG
7311.163	43.72	12.75	56.47	74	-17.53	peak
7311.163	28.61	12.75	41.36	54	-12.64	AVG

Remark:  
Factor = Antenna Factor + Cable Loss – Pre-amplifier.



EUT :	802.11n 150M Ultra Wireless LAN Router	Model Name :	AIP-W511
Temperature :	20 °C	Relative Humidity :	48%
Pressure :	1010 hPa	Test Voltage :	DC 3.7V
Test Mode :	CH6 (802.11b Mode)/2437	Polarization :	Horizontal

Frequency (MHz)	Meter Reading (dBµV)	Factor (dB)	Emission Level (dBµV/m)	Limits (dBµV/m)	Margin (dB)	Value Type
4874.159	50.12	10.4	60.52	74	-13.48	peak
4874.159	31.85	10.4	42.25	54	-11.75	AVG
7311.136	41.41	12.75	54.16	74	-19.84	peak
7311.136	24.73	12.75	37.48	54	-16.52	AVG

Remark:  
Factor = Antenna Factor + Cable Loss – Pre-amplifier.

EUT :	802.11n 150M Ultra Wireless LAN Router	Model Name :	AIP-W511
Temperature :	20 °C	Relative Humidity :	48%
Pressure :	1010 hPa	Test Voltage :	DC 3.7V
Test Mode :	CH6 (802.11b Mode)/2437	Polarization :	Vertical

Frequency (MHz)	Meter Reading (dBµV)	Factor (dB)	Emission Level (dBµV/m)	Limits (dBµV/m)	Margin (dB)	Value Type
4924.146	48.72	10.39	59.11	74	-14.89	peak
4934.146	32.2	10.44	42.64	54	-11.36	AVG
7386.143	43.74	12.68	56.42	74	-17.58	peak
7386.143	28.03	12.68	40.71	54	-13.29	AVG

Remark:  
1. Factor = Antenna Factor + Cable Loss – Pre-amplifier.  
2. No emission detected above 18GHz

EUT :	802.11n 150M Ultra Wireless LAN Router	Model Name :	AIP-W511
Temperature :	20 °C	Relative Humidity :	48%
Pressure :	1010 hPa	Test Voltage :	DC 3.7V
Test Mode :	CH11 (802.11b Mode)/2462	Polarization :	Horizontal

Frequency (MHz)	Meter Reading (dBµV)	Factor (dB)	Emission Level (dBµV/m)	Limits (dBµV/m)	Margin (dB)	Value Type
4924.145	49.8	10.39	60.19	74	-13.81	peak
4924.145	30.87	10.39	41.26	54	-12.74	AVG
7386.142	41.37	12.68	54.05	74	-19.95	peak
7386.142	26.89	12.68	39.57	54	-14.43	AVG

Remark:  
 1. Factor = Antenna Factor + Cable Loss – Pre-amplifier.  
 2. No emission detected above 18GHz

EUT :	802.11n 150M Ultra Wireless LAN Router	Model Name :	AIP-W511
Temperature :	20 °C	Relative Humidity :	48%
Pressure :	1010 hPa	Test Voltage :	DC 3.7V
Test Mode :	CH11 (802.11b Mode)/2462	Polarization :	Vertical

Frequency (MHz)	Meter Reading (dBµV)	Factor (dB)	Emission Level (dBµV/m)	Limits (dBµV/m)	Margin (dB)	Value Type
4924.122	49.09	10.39	59.48	74	-14.52	peak
4924.122	32.85	10.39	43.24	54	-10.76	AVG
7386.143	40.71	12.68	53.39	74	-20.61	peak
7386.143	29.43	12.68	42.11	54	-11.89	AVG

Remark:  
 Factor = Antenna Factor + Cable Loss – Pre-amplifier.

EUT :	802.11n 150M Ultra Wireless LAN Router	Model Name :	AIP-W511
Temperature :	20 °C	Relative Humidity :	48%
Pressure :	1010 hPa	Test Voltage :	DC 3.7V
Test Mode :	CH1 (802.11g Mode)/2412	Polarization :	Horizontal

Frequency (MHz)	Meter Reading (dBµV)	Factor (dB)	Emission Level (dBµV/m)	Limits (dBµV/m)	Margin (dB)	Value Type
4824.17	45.82	10.44	56.26	74	-17.74	peak
4824.17	30.18	10.44	40.62	54	-13.38	AVG
7236.224	43.37	12.39	55.76	74	-18.24	peak
7236.224	27.09	12.39	39.48	54	-14.52	AVG

Remark:  
Factor = Antenna Factor + Cable Loss – Pre-amplifier.

EUT :	802.11n 150M Ultra Wireless LAN Router	Model Name :	AIP-W511
Temperature :	20 °C	Relative Humidity :	48%
Pressure :	1010 hPa	Test Voltage :	DC 3.7V
Test Mode :	CH1 (802.11g Mode)/2412	Polarization :	Vertical

Frequency (MHz)	Meter Reading (dBµV)	Factor (dB)	Emission Level (dBµV/m)	Limits (dBµV/m)	Margin (dB)	Value Type
4824.155	50.38	10.44	60.82	74	-13.18	peak
4824.155	32.02	10.44	42.46	54	-11.54	AVG
7236.142	42.85	12.39	55.24	74	-18.76	peak
7236.142	27.12	12.39	39.51	54	-14.49	AVG

Remark:  
Factor = Antenna Factor + Cable Loss – Pre-amplifier.

EUT :	802.11n 150M Ultra Wireless LAN Router	Model Name :	AIP-W511
Temperature :	20 °C	Relative Humidity :	48%
Pressure :	1010 hPa	Test Voltage :	DC 3.7V
Test Mode :	CH6 (802.11g Mode)/2437	Polarization :	Horizontal

Frequency (MHz)	Meter Reading (dBµV)	Factor (dB)	Emission Level (dBµV/m)	Limits (dBµV/m)	Margin (dB)	Value Type
4874.14	46.07	10.4	56.47	74	-17.53	peak
4874.14	30.42	10.4	40.82	54	-13.18	AVG
7311.17	39.83	12.75	52.58	74	-21.42	peak
7311.17	25.62	12.75	38.37	54	-15.63	AVG

Remark:  
Factor = Antenna Factor + Cable Loss – Pre-amplifier.

EUT :	802.11n 150M Ultra Wireless LAN Router	Model Name :	AIP-W511
Temperature :	20 °C	Relative Humidity :	48%
Pressure :	1010 hPa	Test Voltage :	DC 3.7V
Test Mode :	CH6 (802.11g Mode)/2437	Polarization :	Vertical

Frequency (MHz)	Meter Reading (dBµV)	Factor (dB)	Emission Level (dBµV/m)	Limits (dBµV/m)	Margin (dB)	Value Type
4874.158	46.92	10.4	57.32	74	-16.68	peak
4874.158	31.06	10.4	41.46	54	-12.54	AVG
7311.137	42.1	12.75	54.85	74	-19.15	peak
7311.137	26.76	12.75	39.51	54	-14.49	AVG

Remark:  
Factor = Antenna Factor + Cable Loss – Pre-amplifier.

EUT :	802.11n 150M Ultra Wireless LAN Router	Model Name :	AIP-W511
Temperature :	20 °C	Relative Humidity :	48%
Pressure :	1010 hPa	Test Voltage :	DC 3.7V
Test Mode :	CH11 (802.11g Mode)/2462	Polarization :	Horizontal

Frequency (MHz)	Meter Reading (dBµV)	Factor (dB)	Emission Level (dBµV/m)	Limits (dBµV/m)	Margin (dB)	Value Type
4924.138	45.87	10.39	56.26	74	-17.74	peak
4924.138	30.35	10.39	40.74	54	-13.26	AVG
7386.149	40.84	12.68	53.52	74	-20.48	peak
7386.149	25.76	12.68	38.44	54	-15.56	AVG

Remark:  
Factor = Antenna Factor + Cable Loss – Pre-amplifier.

EUT :	802.11n 150M Ultra Wireless LAN Router	Model Name :	AIP-W511
Temperature :	20 °C	Relative Humidity :	48%
Pressure :	1010 hPa	Test Voltage :	DC 3.7V
Test Mode :	CH11(802.11g Mode)/2462	Polarization :	Vertical

Frequency (MHz)	Meter Reading (dBµV)	Factor (dB)	Emission Level (dBµV/m)	Limits (dBµV/m)	Margin (dB)	Value Type
4924.148	49.1	10.39	59.49	74	-14.51	peak
4924.148	30.87	10.39	41.26	54	-12.74	AVG
7386.13	41.69	12.68	54.37	74	-19.63	peak
7386.13	26.5	12.68	39.18	54	-14.82	AVG

Remark:  
Factor = Antenna Factor + Cable Loss – Pre-amplifier.

EUT :	802.11n 150M Ultra Wireless LAN Router	Model Name :	AIP-W511
Temperature :	20 °C	Relative Humidity :	48%
Pressure :	1010 hPa	Test Voltage :	DC 3.7V
Test Mode :	CH1(802.11n Mode)/20MHz	Polarization :	Horizontal

Frequency (MHz)	Meter Reading (dBµV)	Factor (dB)	Emission Level (dBµV/m)	Limits (dBµV/m)	Margin (dB)	Value Type
4824.14	47.77	10.44	58.21	74	-15.79	peak
4824.14	31.2	10.44	41.64	54	-12.36	AVG
7236.122	42.79	12.39	55.18	74	-18.82	peak
7236.122	26.88	12.39	39.27	54	-14.73	AVG

Remark:  
Factor = Antenna Factor + Cable Loss – Pre-amplifier.

EUT :	802.11n 150M Ultra Wireless LAN Router	Model Name :	AIP-W511
Temperature :	20 °C	Relative Humidity :	48%
Pressure :	1010 hPa	Test Voltage :	DC 3.7V
Test Mode :	CH1(802.11n Mode)/20MHz	Polarization :	Vertical

Frequency (MHz)	Meter Reading (dBµV)	Factor (dB)	Emission Level (dBµV/m)	Limits (dBµV/m)	Margin (dB)	Value Type
4824.141	47.95	10.44	58.39	74	-15.61	peak
4824.141	30.67	10.44	41.11	54	-12.89	AVG
7236.145	43.14	12.39	55.53	74	-18.47	peak
7236.145	28.09	12.39	40.48	54	-13.52	AVG

Remark:  
Factor = Antenna Factor + Cable Loss – Pre-amplifier.

EUT :	802.11n 150M Ultra Wireless LAN Router	Model Name :	AIP-W511
Temperature :	20 °C	Relative Humidity :	48%
Pressure :	1010 hPa	Test Voltage :	DC 3.7V
Test Mode :	CH6(802.11n Mode)/20MHz	Polarization :	Horizontal

Frequency	Meter Reading	Factor	Emission Level	Limits	Margin	Value Type
(MHz)	(dBμV)	(dB)	(dBμV/m)	(dBμV/m)	(dB)	
4874.16	46.97	10.4	57.37	74	-16.63	peak
4874.16	31.43	10.4	41.83	54	-12.17	AVG
7311.128	41.3	12.75	54.05	74	-19.95	peak
7311.128	25.89	12.75	38.64	54	-15.36	AVG

Remark:  
Factor = Antenna Factor + Cable Loss – Pre-amplifier.

EUT :	802.11n 150M Ultra Wireless LAN Router	Model Name :	AIP-W511
Temperature :	20 °C	Relative Humidity :	48%
Pressure :	1010 hPa	Test Voltage :	DC 3.7V
Test Mode :	CH6(802.11n Mode)/20MHz	Polarization :	Vertical

Frequency	Meter Reading	Factor	Emission Level	Limits	Margin	Value Type
(MHz)	(dBμV)	(dB)	(dBμV/m)	(dBμV/m)	(dB)	
4874.161	49.32	10.4	59.72	74	-14.28	peak
4874.161	31.45	10.4	41.85	54	-12.15	AVG
7311.166	42.49	12.75	55.24	74	-18.76	peak
7311.166	26.52	12.75	39.27	54	-14.73	AVG

Remark:  
Factor = Antenna Factor + Cable Loss – Pre-amplifier.

EUT :	802.11n 150M Ultra Wireless LAN Router	Model Name :	AIP-W511
Temperature :	20 °C	Relative Humidity :	48%
Pressure :	1010 hPa	Test Voltage :	DC 3.7V
Test Mode :	CH11(802.11n Mode)/20MHz	Polarization :	Horizontal

Frequency (MHz)	Meter Reading (dBµV)	Factor (dB)	Emission Level (dBµV/m)	Limits (dBµV/m)	Margin (dB)	Value Type
4924.14	48.07	10.39	58.46	74	-15.54	peak
4924.14	31.92	10.39	42.31	54	-11.69	AVG
7386.183	42.92	12.68	55.60	74	-18.40	peak
7386.183	26.57	12.68	39.25	54	-14.75	AVG

Remark:  
Factor = Antenna Factor + Cable Loss – Pre-amplifier.

EUT :	802.11n 150M Ultra Wireless LAN Router	Model Name :	AIP-W511
Temperature :	20 °C	Relative Humidity :	48%
Pressure :	1010 hPa	Test Voltage :	DC 3.7V
Test Mode :	CH11(802.11n Mode)/20MHz	Polarization :	Vertical

Frequency (MHz)	Meter Reading (dBµV)	Factor (dB)	Emission Level (dBµV/m)	Limits (dBµV/m)	Margin (dB)	Value Type
4924.15	50.39	10.39	60.78	74	-13.22	peak
4924.15	32.65	10.39	43.04	54	-10.96	AVG
7386.167	40.69	12.68	53.37	74	-20.63	peak
7386.167	28.51	12.68	41.19	54	-12.81	AVG

Remark:  
Factor = Antenna Factor + Cable Loss – Pre-amplifier.



EUT :	802.11n 150M Ultra Wireless LAN Router	Model Name :	AIP-W511
Temperature :	20 °C	Relative Humidity :	48%
Pressure :	1010 hPa	Test Voltage :	DC 3.7V
Test Mode :	CH3(802.11n Mode)/40MHz	Polarization :	Horizontal

Frequency (MHz)	Meter Reading (dBµV)	Factor (dB)	Emission Level (dBµV/m)	Limits (dBµV/m)	Margin (dB)	Value Type
4844.156	44.76	10.5	55.26	74	-18.74	peak
4844.156	31.37	10.5	41.87	54	-12.13	AVG
7266.319	41.84	12.5	54.34	74	-19.66	peak
7266.319	29.53	12.5	42.03	54	-11.97	AVG

Remark:  
Factor = Antenna Factor + Cable Loss – Pre-amplifier.

EUT :	802.11n 150M Ultra Wireless LAN Router	Model Name :	AIP-W511
Temperature :	20 °C	Relative Humidity :	48%
Pressure :	1010 hPa	Test Voltage :	DC 3.7V
Test Mode :	CH3(802.11n Mode)/40MHz	Polarization :	Vertical

Frequency (MHz)	Meter Reading (dBµV)	Factor (dB)	Emission Level (dBµV/m)	Limits (dBµV/m)	Margin (dB)	Value Type
4844.325	48.04	10.5	58.54	74	-15.46	peak
4844.325	34.75	10.5	45.25	54	-8.75	AVG
7266.258	41.57	12.5	54.07	74	-19.93	peak
7266.258	30.02	12.5	42.52	54	-11.48	AVG

Remark:  
Factor = Antenna Factor + Cable Loss – Pre-amplifier.

EUT :	802.11n 150M Ultra Wireless LAN Router	Model Name :	AIP-W511
Temperature :	20 °C	Relative Humidity :	48%
Pressure :	1010 hPa	Test Voltage :	DC 3.7V
Test Mode :	CH6(802.11n Mode)/40MHz	Polarization :	Horizontal

Frequency (MHz)	Meter Reading (dBµV)	Factor (dB)	Emission Level (dBµV/m)	Limits (dBµV/m)	Margin (dB)	Value Type
4874.238	46.33	10.4	56.73	74	-17.27	peak
4874.238	31.43	10.4	41.83	54	-12.17	AVG
7311.159	35.78	12.75	48.53	74	-25.47	peak
7311.159	27.57	12.75	40.32	54	-13.68	AVG

Remark:  
Factor = Antenna Factor + Cable Loss – Pre-amplifier.

EUT :	802.11n 150M Ultra Wireless LAN Router	Model Name :	AIP-W511
Temperature :	20 °C	Relative Humidity :	48%
Pressure :	1010 hPa	Test Voltage :	DC 3.7V
Test Mode :	CH6(802.11n Mode)/40MHz	Polarization :	Vertical

Frequency (MHz)	Meter Reading (dBµV)	Factor (dB)	Emission Level (dBµV/m)	Limits (dBµV/m)	Margin (dB)	Value Type
4874.535	46.04	10.4	56.44	74	-17.56	peak
4874.535	32.12	10.4	42.52	54	-11.48	AVG
7311.633	37.78	12.75	50.53	74	-23.47	peak
7311.633	29.72	12.75	42.47	54	-11.53	AVG

Remark:  
Factor = Antenna Factor + Cable Loss – Pre-amplifier.

EUT :	802.11n 150M Ultra Wireless LAN Router	Model Name :	AIP-W511
Temperature :	20 °C	Relative Humidity :	48%
Pressure :	1010 hPa	Test Voltage :	DC 3.7V
Test Mode :	CH9(802.11n Mode)/40MHz	Polarization :	Horizontal

Frequency (MHz)	Meter Reading (dBµV)	Factor (dB)	Emission Level (dBµV/m)	Limits (dBµV/m)	Margin (dB)	Value Type
4904.345	46.87	10.29	57.16	74	-16.84	peak
4904.345	32.74	10.29	43.03	54	-10.97	AVG
7356.247	41.23	12.79	54.02	74	-19.98	peak
7356.247	28.46	12.79	41.25	54	-12.75	AVG

Remark:  
Factor = Antenna Factor + Cable Loss – Pre-amplifier.

EUT :	802.11n 150M Ultra Wireless LAN Router	Model Name :	AIP-W511
Temperature :	20 °C	Relative Humidity :	48%
Pressure :	1010 hPa	Test Voltage :	DC 3.7V
Test Mode :	CH9(802.11n Mode)/40MHz	Polarization :	Vertical

Frequency (MHz)	Meter Reading (dBµV)	Factor (dB)	Emission Level (dBµV/m)	Limits (dBµV/m)	Margin (dB)	Value Type
4904.16	46.22	10.29	56.51	74	-17.49	peak
4904.16	33.13	10.29	43.42	54	-10.58	AVG
7356.423	37.55	12.79	50.34	74	-23.66	peak
7356.423	28.37	12.79	41.16	54	-12.84	AVG

Remark:  
Factor = Antenna Factor + Cable Loss – Pre-amplifier.

### 3.2.9 TEST RESULTS (RESTRICTED BANDS REQUIREMENTS)

EUT :	802.11n 150M Ultra Wireless LAN Router	Model Name :	AIP-W511
Temperature :	20 °C	Relative Humidity :	48%
Pressure :	1010 hPa	Test Voltage :	DC 3.7V
Test Mode :	CH1(802.11b Mode)	Polarization :	Horizontal

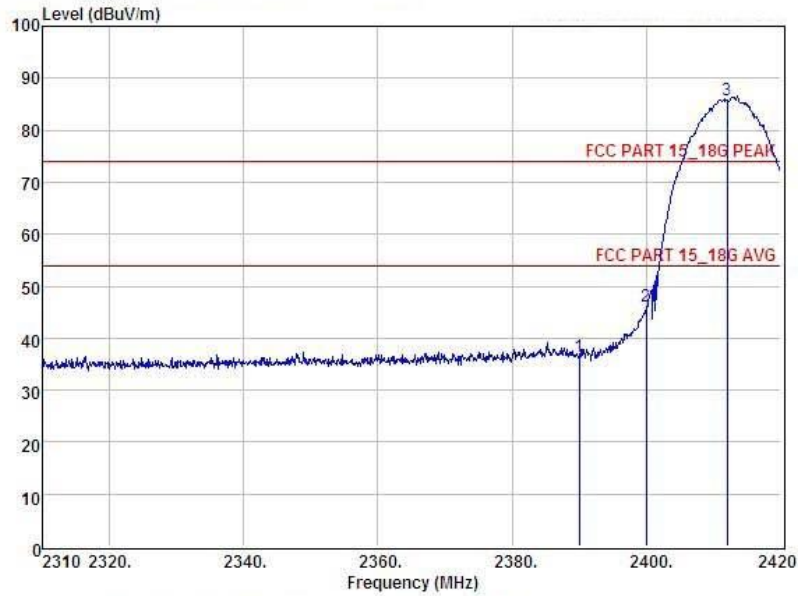

Condition : FCC PART 15\_18G PEAK 3m POL: HORIZONTAL

Item	Freq MHz	Read Level dBuV	Antenna Factor dB	Preamp Factor dB	Cable Loss dB	Level dBuV	Limit dBuV	Margin dBuV	Remark
1	2390.00	39.88	27.62	34.97	3.92	36.45	74.00	-37.55	Peak
2	2400.00	49.43	27.62	34.97	3.94	46.02	74.00	-27.98	Peak
3	2412.00	89.15	27.61	34.97	3.95	85.74	74.00	11.74	Peak

Remark: Level = Read Level + Antenna Factor - Preamp Factor + Cable Loss

EUT :	802.11n 150M Ultra Wireless LAN Router	Model Name :	AIP-W511
Temperature :	20 °C	Relative Humidity :	48%
Pressure :	1010 hPa	Test Voltage :	DC 3.7V
Test Mode :	CH1(802.11b Mode)	Polarization :	Vertical

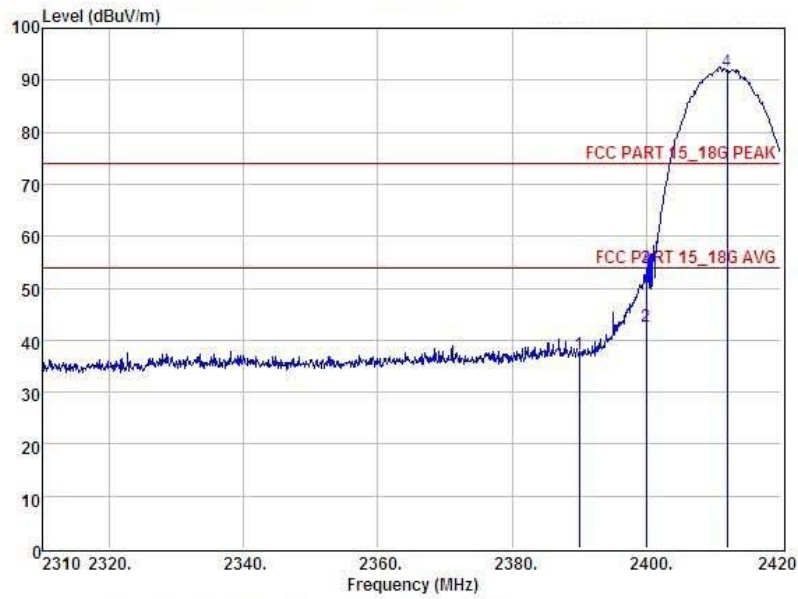

Condition : FCC PART 15_18G PEAK 3m POL: VERTICAL									
Item	Freq	Read	Antenna	Preamp	Cable	Level	Limit	Margin	Remark
	MHz	dBuV	Factor	Factor	Loss	dBuV	dBuV	dBuV	
1	2390.00	40.82	27.62	34.97	3.92	37.39	74.00	-36.61	Peak
2	2400.00	45.97	27.62	34.97	3.94	42.56	54.00	-11.44	Average
3	2400.00	57.16	27.62	34.97	3.94	53.75	74.00	-20.25	Peak
4	2412.00	95.23	27.61	34.97	3.95	91.82	74.00	17.82	Peak

Remark: Level = Read Level + Antenna Factor - Preamp Factor + Cable Loss

EUT :	802.11n 150M Ultra Wireless LAN Router	Model Name :	AIP-W511
Temperature :	20 °C	Relative Humidity :	48%
Pressure :	1010 hPa	Test Voltage :	DC 3.7V
Test Mode :	CH11(802.11b Mode)	Polarization :	Horizontal

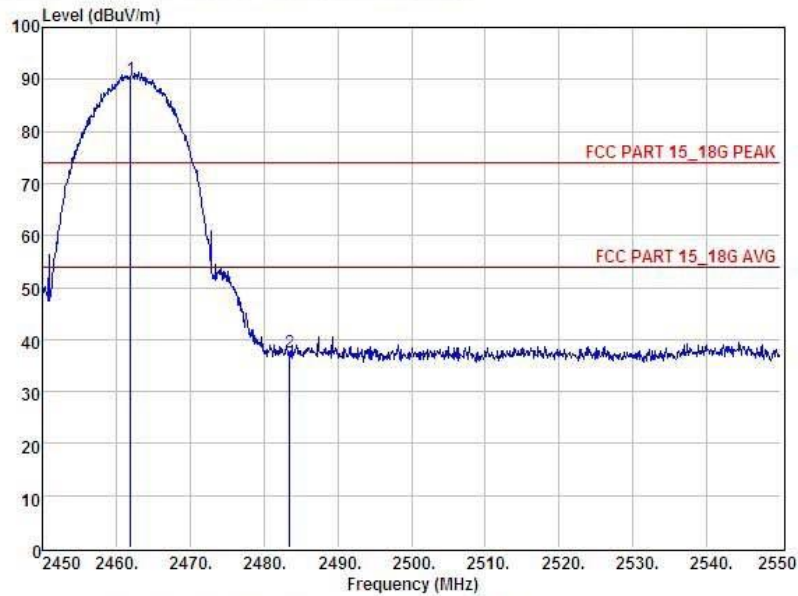

Condition : FCC PART 15_18G PEAK 3m POL: HORIZONTAL									
Item	Freq	Read	Antenna	Preamp	Cable	Level	Limit	Margin	Remark
	MHz	Level	Factor	Factor	Loss	dBuV	dBuV	dBuV	
		dBuV	dB	dB	dB				
1	2462.00	93.47	27.59	34.97	3.98	90.07	74.00	16.07	Peak
2	2483.50	40.83	27.59	34.97	4.00	37.45	74.00	-36.55	Peak

Remark: Level = Read Level + Antenna Factor - Preamp Factor + Cable Loss

EUT :	802.11n 150M Ultra Wireless LAN Router	Model Name :	AIP-W511
Temperature :	20 °C	Relative Humidity :	48%
Pressure :	1010 hPa	Test Voltage :	DC 3.7V
Test Mode :	CH11(802.11b Mode)	Polarization :	Vertical

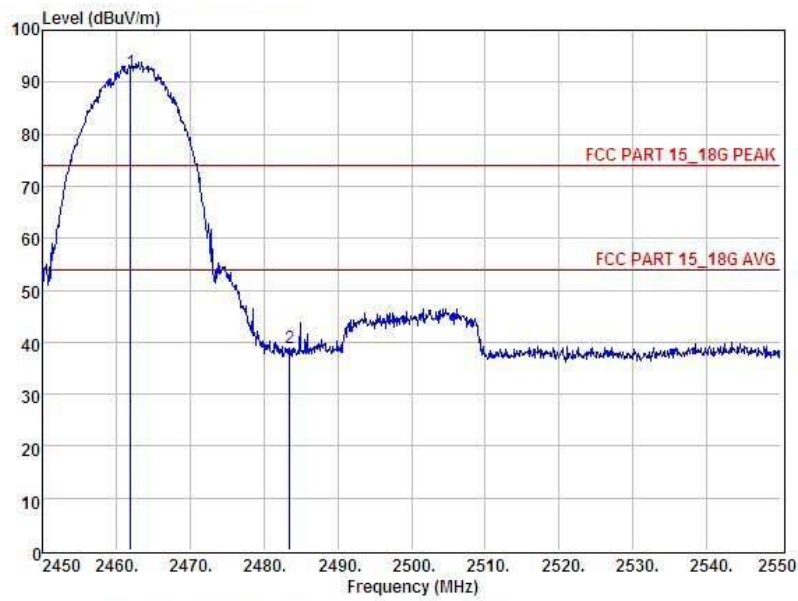

Condition : FCC PART 15_18G PEAK 3m POL: VERTICAL									
Item	Freq	Read	Antenna	Preamp	Cable	Level	Limit	Margin	Remark
	MHz	Level	Factor	Factor	Loss	dBuV	dBuV	dBuV	
		dBuV	dB	dB	dB				
1	2462.00	95.23	27.59	34.97	3.98	91.83	74.00	17.83	Peak
2	2483.50	42.19	27.59	34.97	4.00	38.81	74.00	-35.19	Peak

Remark: Level = Read Level + Antenna Factor - Preamp Factor + Cable Loss

EUT :	802.11n 150M Ultra Wireless LAN Router	Model Name :	AIP-W511
Temperature :	20 °C	Relative Humidity :	48%
Pressure :	1010 hPa	Test Voltage :	DC 3.7V
Test Mode :	CH1(802.11g Mode)	Polarization :	Horizontal

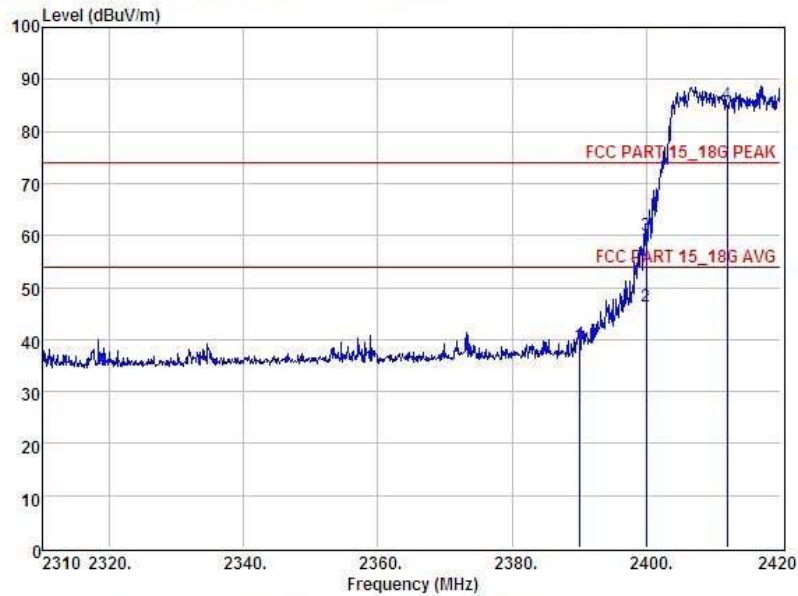

Condition : FCC PART 15\_18G PEAK 3m POL: HORIZONTAL

Item	Freq MHz	Read Level dBuV	Antenna Factor dB	Preamp Factor dB	Cable Loss dB	Level dBuV	Limit dBuV	Margin dBuV	Remark
1	2390.00	42.31	27.62	34.97	3.92	38.88	74.00	-35.12	Peak
2	2400.00	49.78	27.62	34.97	3.94	46.34	54.00	-7.66	Average
3	2400.00	63.46	27.62	34.97	3.94	60.05	74.00	-13.95	Peak
4	2412.00	88.54	27.61	34.97	3.95	85.13	74.00	11.13	Peak

Remark: Level = Read Level + Antenna Factor - Preamp Factor + Cable Loss



EUT :	802.11n 150M Ultra Wireless LAN Router	Model Name :	AIP-W511
Temperature :	20 °C	Relative Humidity :	48%
Pressure :	1010 hPa	Test Voltage :	DC 3.7V
Test Mode :	CH1(802.11gMode)	Polarization :	Vertical

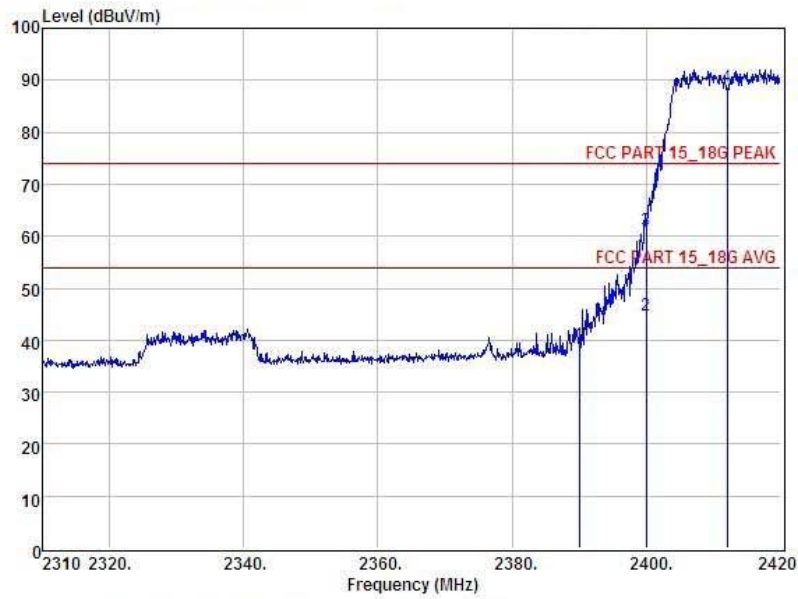

Condition : FCC PART 15\_18G PEAK 3m POL: VERTICAL

Item	Freq MHz	Read Level dBuV	Antenna Factor dB	Preamp Factor dB	Cable Loss dB	Level dBuV	Limit dBuV	Margin dBuV	Remark
1	2390.00	42.65	27.62	34.97	3.92	39.22	74.00	-34.78	Peak
2	2400.00	48.28	27.62	34.97	3.94	44.84	54.00	-9.16	Average
3	2400.00	64.54	27.62	34.97	3.94	61.13	74.00	-12.87	Peak
4	2412.00	82.18	27.61	34.97	3.95	88.77	74.00	14.77	Peak

Remark: Level = Read Level + Antenna Factor - Preamp Factor + Cable Loss

EUT :	802.11n 150M Ultra Wireless LAN Router	Model Name :	AIP-W511
Temperature :	20 °C	Relative Humidity :	48%
Pressure :	1010 hPa	Test Voltage :	DC 3.7V
Test Mode :	CH11(802.11g Mode)	Polarization :	Horizontal

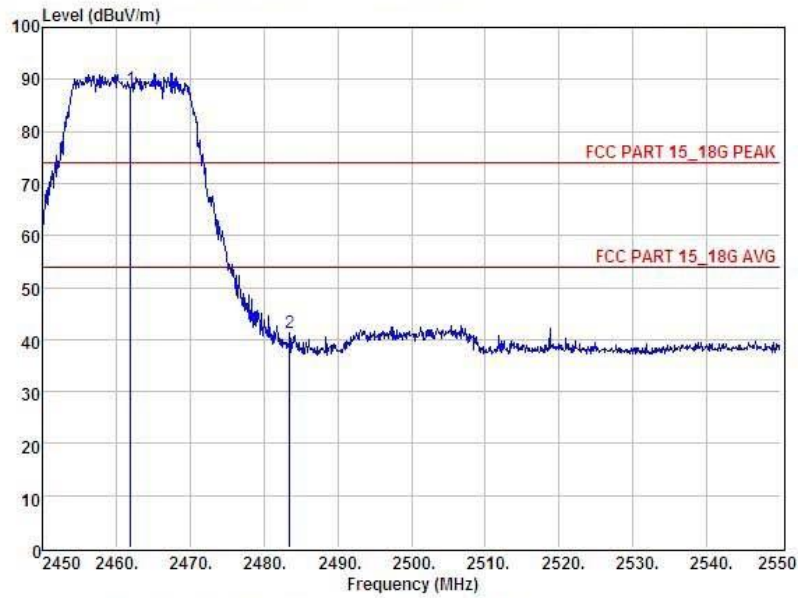

Condition : FCC PART 15 18G PEAK 3m POL: HORIZONTAL										
Item	Freq	Read	Antenna	Preamp	Cable	Level	Limit	Margin	Remark	
	MHz	Level	Factor	Factor	Loss	dBuV	dBuV	dBuV		
		dBuV	dB	dB	dB					
1	2462.00	91.68	27.59	34.97	3.98	88.28	74.00	14.28	Peak	
2	2483.50	44.77	27.59	34.97	4.00	41.39	74.00	-32.61	Peak	

Remark: Level = Read Level + Antenna Factor - Preamp Factor + Cable Loss

EUT :	802.11n 150M Ultra Wireless LAN Router	Model Name :	AIP-W511
Temperature :	20 °C	Relative Humidity :	48%
Pressure :	1010 hPa	Test Voltage :	DC 3.7V
Test Mode :	CH11(802.11g Mode)	Polarization :	Vertical

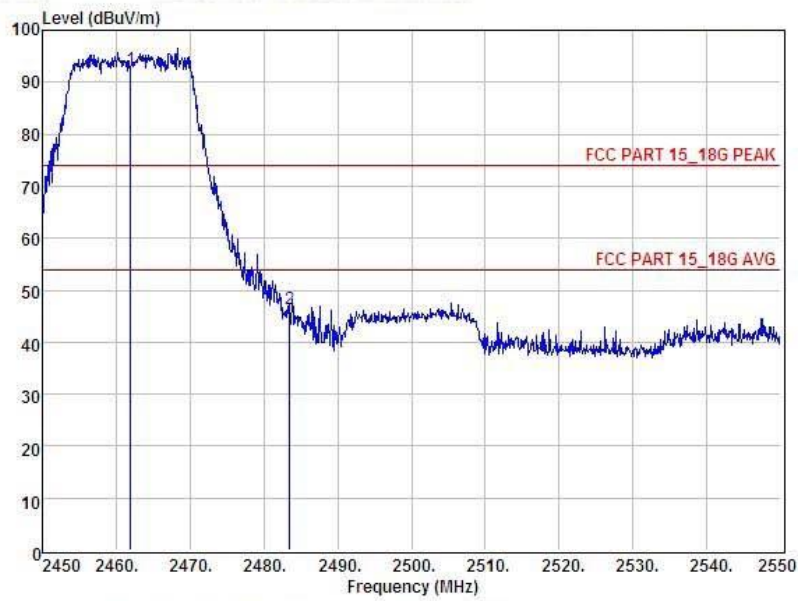

Condition : FCC PART 15_18G PEAK 3m POL: VERTICAL									
Item	Freq	Read Level	Antenna Factor	Preamp Factor	Cable Loss	Level	Limit	Margin	Remark
	MHz	dBuV	dB	dB	dB	dBuV	dBuV	dBuV	
1	2462.00	95.86	27.59	34.97	3.98	92.46	74.00	18.46	Peak
2	2483.50	49.69	27.59	34.97	4.00	46.31	74.00	-27.69	Peak

Remark: Level = Read Level + Antenna Factor - Preamp Factor + Cable Loss

EUT :	802.11n 150M Ultra Wireless LAN Router	Model Name :	AIP-W511
Temperature :	20 °C	Relative Humidity :	48%
Pressure :	1010 hPa	Test Voltage :	DC 3.7V
Test Mode :	CH1(802.11n Mode)/20MHz	Polarization :	Horizontal

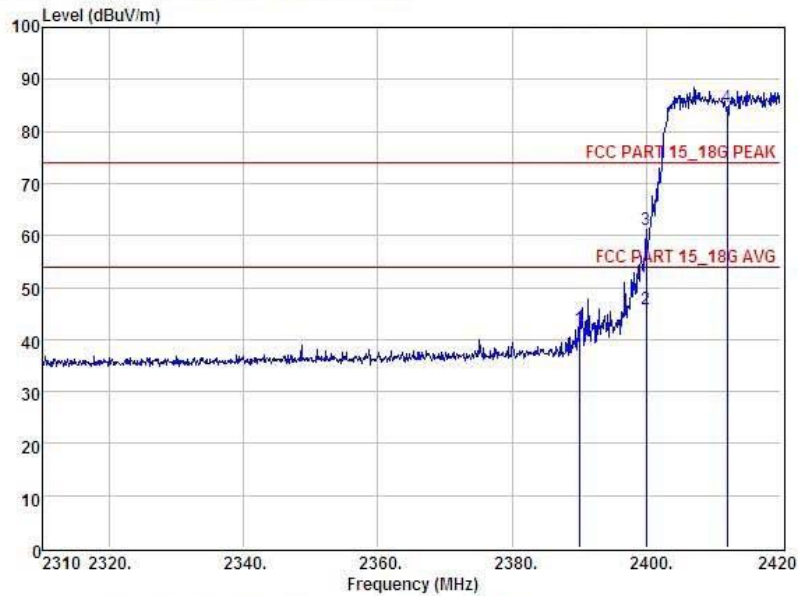

Condition : FCC PART 15\_18G PEAK 3m POL: HORIZONTAL

Item	Freq MHz	Read Level dBuV	Antenna Factor dB	Preamp Factor dB	Cable Loss dB	Level dBuV	Limit dBuV	Margin dBuV	Remark
1	2390.00	45.63	27.62	34.97	3.92	42.20	74.00	-31.80	Peak
2	2400.00	49.28	27.62	34.97	3.94	45.88	54.00	-8.15	Average
3	2400.00	64.62	27.62	34.97	3.94	61.21	74.00	-12.79	Peak
4	2412.00	88.00	27.61	34.97	3.95	84.59	74.00	10.59	Peak

Remark: Level = Read Level + Antenna Factor - Preamp Factor + Cable Loss

EUT :	802.11n 150M Ultra Wireless LAN Router	Model Name :	AIP-W511
Temperature :	20 °C	Relative Humidity :	48%
Pressure :	1010 hPa	Test Voltage :	DC 3.7V
Test Mode :	CH1(802.11n Mode)/20M	Polarization :	Vertical

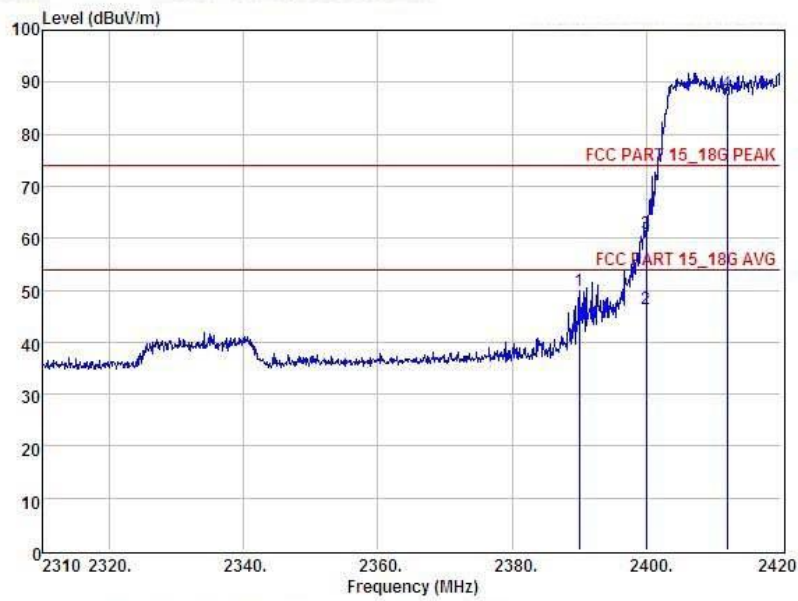

Condition : FCC PART 15_18G PEAK 3m POL: VERTICAL									
Item	Freq	Read	Antenna	Preamp	Cable	Level	Limit	Margin	Remark
	MHz	Level	Factor	Factor	Loss	dBuV	dBuV	dBuV	
		dBuV	dB	dB	dB				
1	2390.00	53.23	27.62	34.97	3.92	49.80	74.00	-24.20	Peak
2	2400.00	49.76	27.62	34.97	3.94	46.38	54.00	-7.65	Average
3	2400.00	64.29	27.62	34.97	3.94	60.89	74.00	-13.12	Peak
4	2412.00	91.36	27.61	34.97	3.95	87.95	74.00	13.95	Peak

Remark: Level = Read Level + Antenna Factor - Preamp Factor + Cable Loss

EUT :	802.11n 150M Ultra Wireless LAN Router	Model Name :	AIP-W511
Temperature :	20 °C	Relative Humidity :	48%
Pressure :	1010 hPa	Test Voltage :	DC 3.7V
Test Mode :	CH11(802.11n Mode)/20MHz	Polarization :	Horizontal

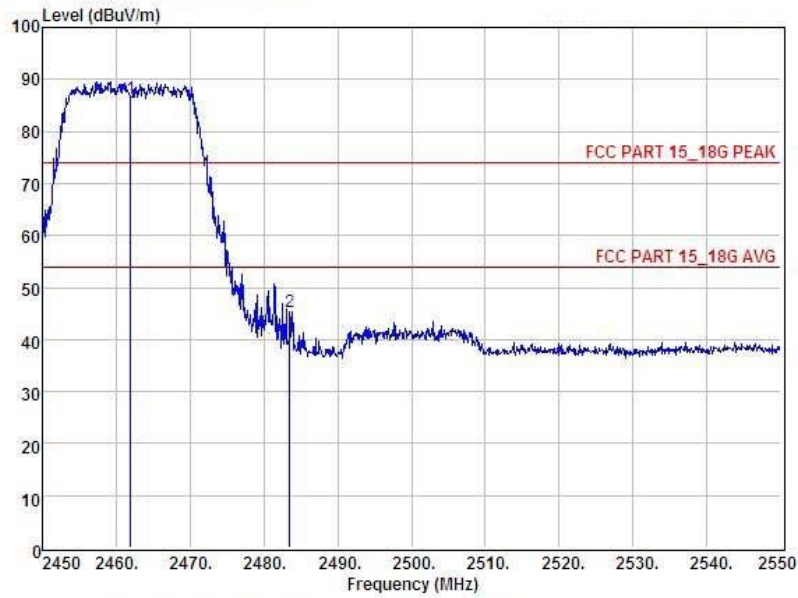

Condition : FCC PART 15_18G PEAK 3m POL: HORIZONTAL										
Item	Freq	Read	Antenna	Preamp	Cable	Level	Limit	Margin	Remark	
	MHz	Level	Factor	Factor	Loss	dBuV	dBuV	dBuV		
		dBuV	dB	dB	dB					
1	2462.00	89.65	27.59	34.97	3.98	86.25	74.00	12.25	Peak	
2	2483.50	48.81	27.59	34.97	4.00	45.43	74.00	-28.57	Peak	

Remark: Level = Read Level + Antenna Factor - Preamp Factor + Cable Loss

EUT :	802.11n 150M Ultra Wireless LAN Router	Model Name :	AIP-W511
Temperature :	20 °C	Relative Humidity :	48%
Pressure :	1010 hPa	Test Voltage :	DC 3.7V
Test Mode :	CH11(802.11n Mode)/20MHz	Polarization :	Vertical

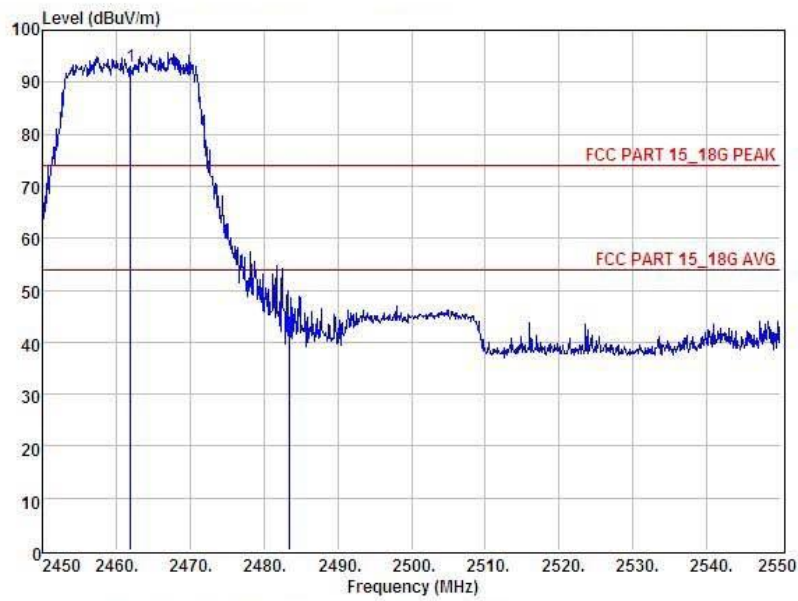

Condition : FCC PART 15_18G PEAK 3m POL: VERTICAL									
Item	Freq	Read	Antenna	Preamp	Cable	Level	Limit	Margin	Remark
	MHz	Level	Factor	Factor	Loss	dBuV	dBuV	dBuV	
		dBuV	dB	dB	dB				
1	2462.00	96.31	27.59	34.97	3.98	92.91	74.00	18.91	Peak
2	2483.50	44.51	27.59	34.97	4.00	41.13	74.00	-32.87	Peak

Remark: Level = Read Level + Antenna Factor - Preamp Factor + Cable Loss

EUT :	802.11n 150M Ultra Wireless LAN Router	Model Name :	AIP-W511
Temperature :	20 °C	Relative Humidity :	48%
Pressure :	1010 hPa	Test Voltage :	DC 3.7V
Test Mode :	CH3(802.11n Mode)/40M	Polarization :	Horizontal

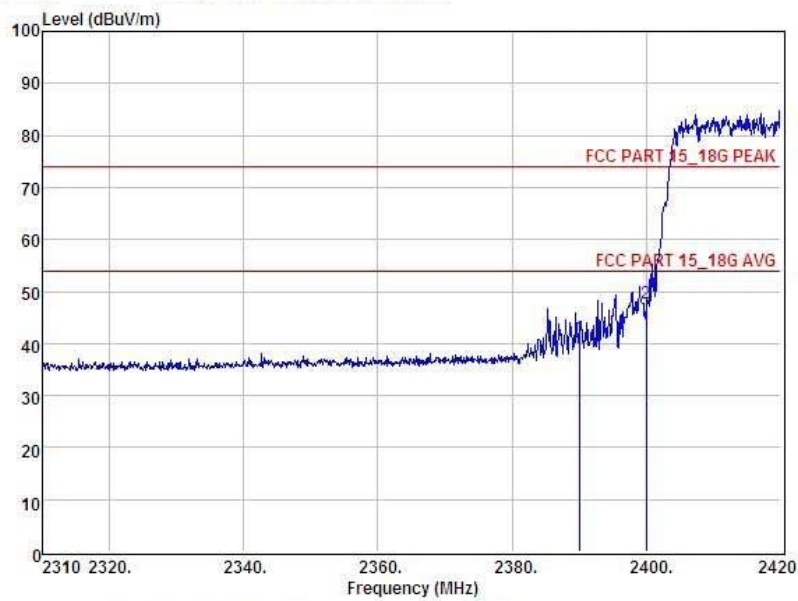

Condition : FCC PART 15\_18G PEAK 3m POL: HORIZONTAL

Item	Freq MHz	Read Level dBuV	Antenna Factor dB	Preamp Factor dB	Cable Loss dB	Level dBuV	Limit dBuV	Margin dBuV	Remark
1	2390.00	44.34	27.62	34.97	3.92	40.91	74.00	-33.09	Peak
2	2400.00	51.07	27.62	34.97	3.94	47.66	74.00	-26.34	Peak

Remark: Level = Read Level + Antenna Factor - Preamp Factor + Cable Loss



EUT :	802.11n 150M Ultra Wireless LAN Router	Model Name :	AIP-W511
Temperature :	20 °C	Relative Humidity :	48%
Pressure :	1010 hPa	Test Voltage :	DC 3.7V
Test Mode :	CH3(802.11n Mode)/40MHz	Polarization :	Vertical

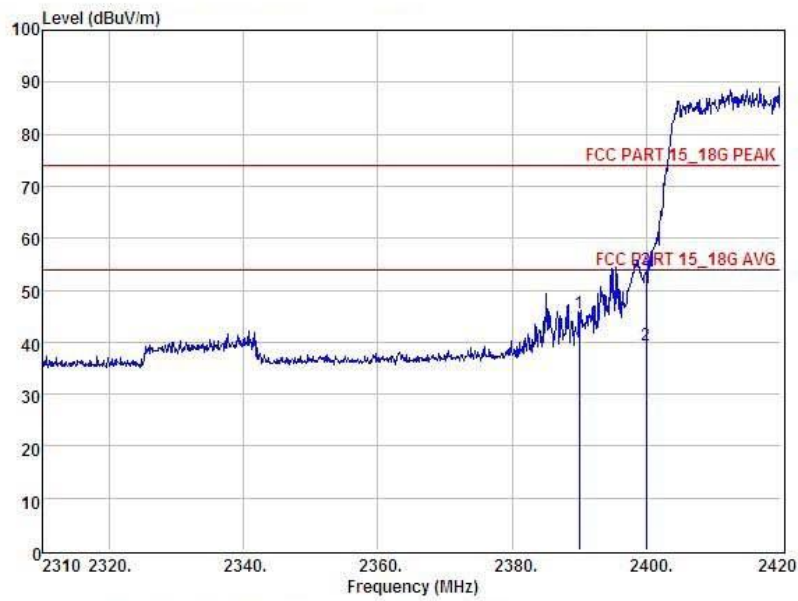

Condition : FCC PART 15_18G PEAK 3m POL: VERTICAL									
Item	Freq	Read	Antenna	Preamp	Cable	Level	Limit	Margin	Remark
	MHz	dBuV	Factor	Factor	Loss	dBuV	dBuV	dBuV	
			dB	dB	dB				
1	2390.00	49.06	27.62	34.97	3.92	45.63	74.00	-28.37	Peak
2	2400.00	42.80	27.62	34.97	3.94	39.39	54.00	-14.61	Average
3	2400.00	57.39	27.62	34.97	3.94	53.98	74.00	-20.02	Peak

Remark: Level = Read Level + Antenna Factor - Preamp Factor + Cable Loss

EUT :	802.11n 150M Ultra Wireless LAN Router	Model Name :	AIP-W511
Temperature :	20 °C	Relative Humidity :	48%
Pressure :	1010 hPa	Test Voltage :	DC 3.7V
Test Mode :	CH9(802.11n Mode)/40MHz	Polarization :	Horizontal

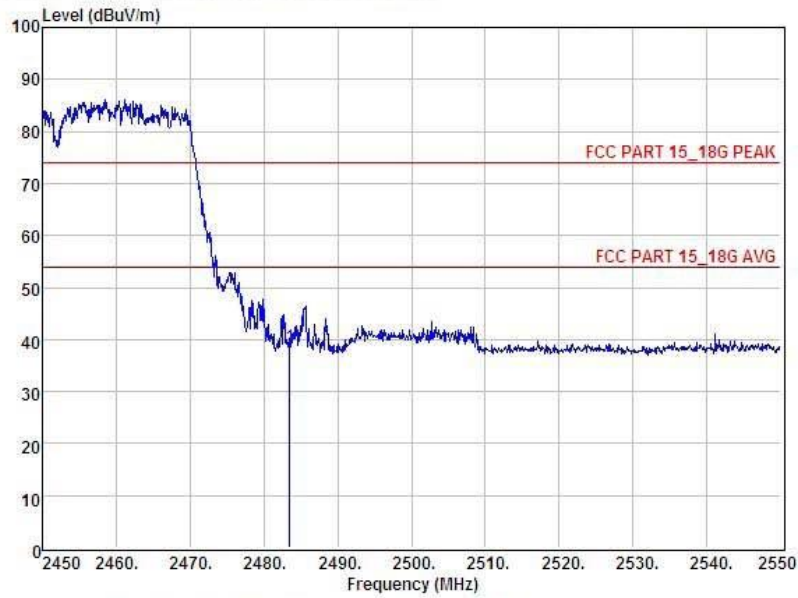

Condition : FCC PART 15_18G PEAK 3m POL: HORIZONTAL									
Item	Freq	Read	Antenna	Preamp	Cable	Level	Limit	Margin	Remark
	MHz	Level	Factor	Factor	Loss	dBuV	dBuV	dBuV	
		dBuV	dB	dB	dB				
1	2483.50	41.96	27.59	34.97	4.00	38.68	74.00	-35.42	Peak

Remark: Level = Read Level + Antenna Factor - Preamp Factor + Cable Loss

EUT :	802.11n 150M Ultra Wireless LAN Router	Model Name :	AIP-W511
Temperature :	20 °C	Relative Humidity :	48%
Pressure :	1010 hPa	Test Voltage :	DC 3.7V
Test Mode :	CH9(802.11n Mode)/40MHz	Polarization :	Vertical

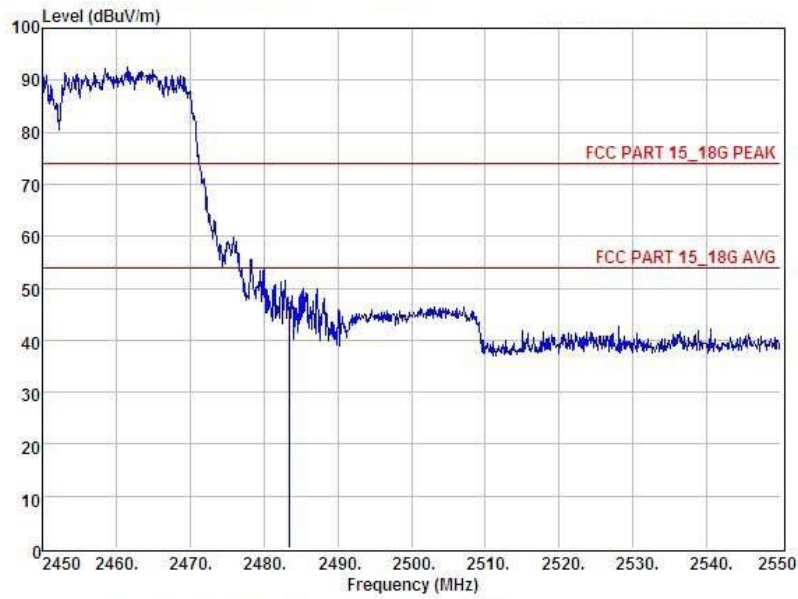

Condition : FCC PART 15_18G PEAK 3m POL: VERTICAL									
Item	Freq	Read	Antenna	Preamp	Cable	Level	Limit	Margin	Remark
	MHz	Level	Factor	Factor	Loss	dBuV	dBuV	dBuV	
		dBuV	dB	dB	dB				
1	2483.50	47.53	27.59	34.97	4.00	44.15	74.00	-29.85	Peak

Remark: Level = Read Level + Antenna Factor - Preamp Factor + Cable Loss

## 4. POWER SPECTRAL DENSITY TEST

### 4.1 APPLIED PROCEDURES / LIMIT

FCC Part15 (15.247) , Subpart C				
Section	Test Item	Limit	Frequency Range (MHz)	Result
15.247	Power Spectral Density	8 dBm (in any 3KHz)	2400-2483.5	PASS

#### 4.1.1 TEST PROCEDURE

1. Set analyzer center frequency to DTS channel center frequency.
2. Set the span to 1.5 times the DTS channel bandwidth.
3. Set the RBW  $\geq$  3 kHz.
4. Set the VBW  $\geq$  3 x RBW.
5. Detector = peak.
6. Sweep time = auto couple.
7. Trace mode = max hold.
8. Allow trace to fully stabilize.
9. Use the peak marker function to determine the maximum amplitude level.
10. If measured value exceeds limit, reduce RBW (no less than 3 kHz) and repeat.

#### 4.1.2 DEVIATION FROM STANDARD

No deviation.

#### 4.1.3 TEST SETUP

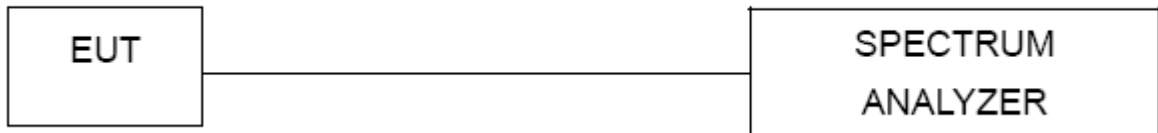

#### 4.1.4 EUT OPERATION CONDITIONS

The EUT tested system was configured as the statements of 2.3 Unless otherwise a special operating condition is specified in the follows during the testing.

### 4.1.5 TEST RESULTS

EUT :	802.11n 150M Ultra Wireless LAN Router	Model Name :	AIP-W511
Temperature :	25 °C	Relative Humidity :	60%
Pressure :	1015 hPa	Test Voltage :	DC 3.7V
Test Mode :	TX b Mode /CH01, CH06, CH11		

Frequency	Power Density (dBm)	Limit (dBm)	Result
2412 MHz	-3.00	8	<b>PASS</b>
2437 MHz	2.78	8	<b>PASS</b>
2462 MHz	-4.54	8	<b>PASS</b>

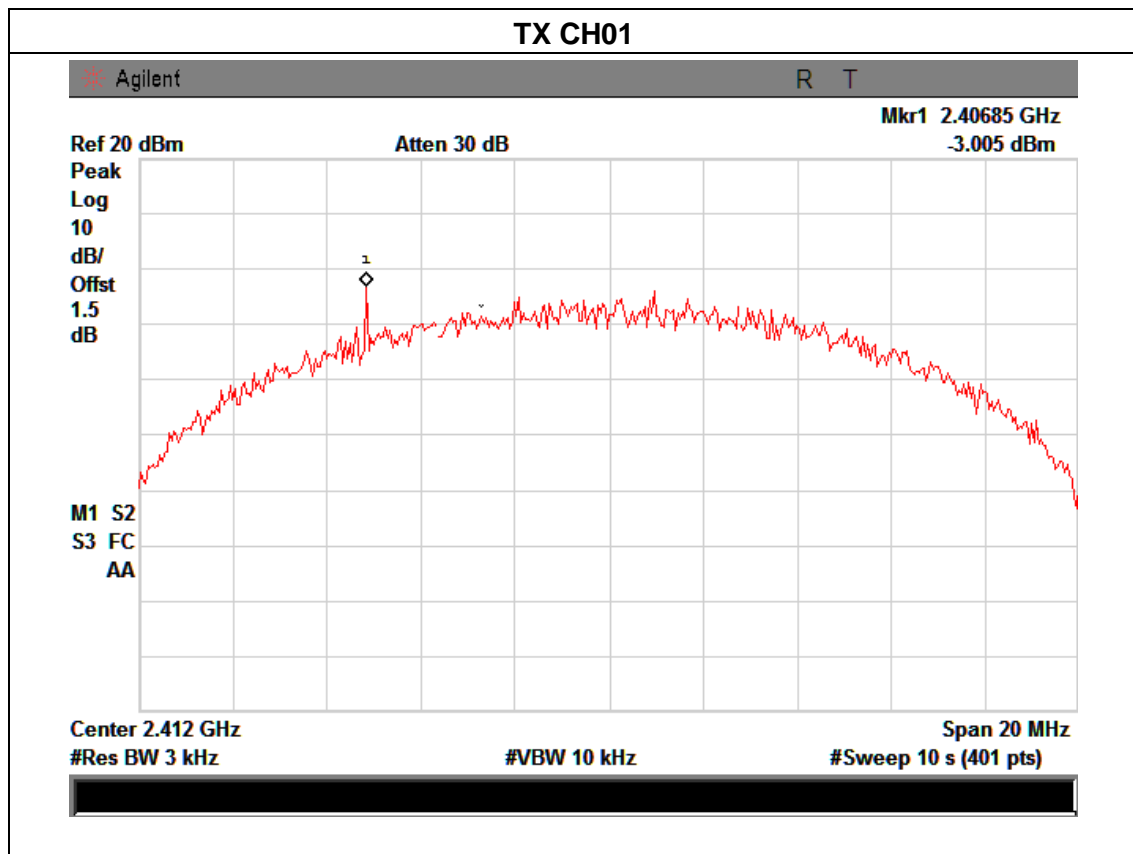

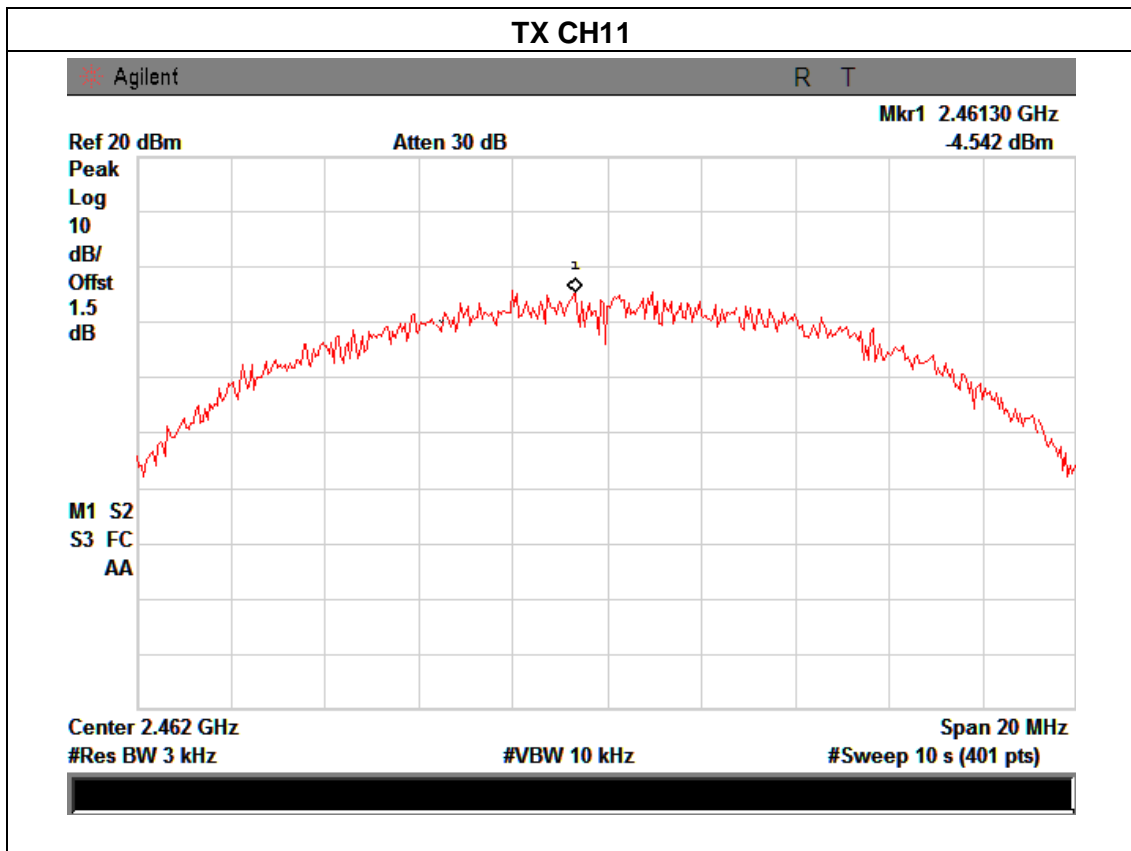
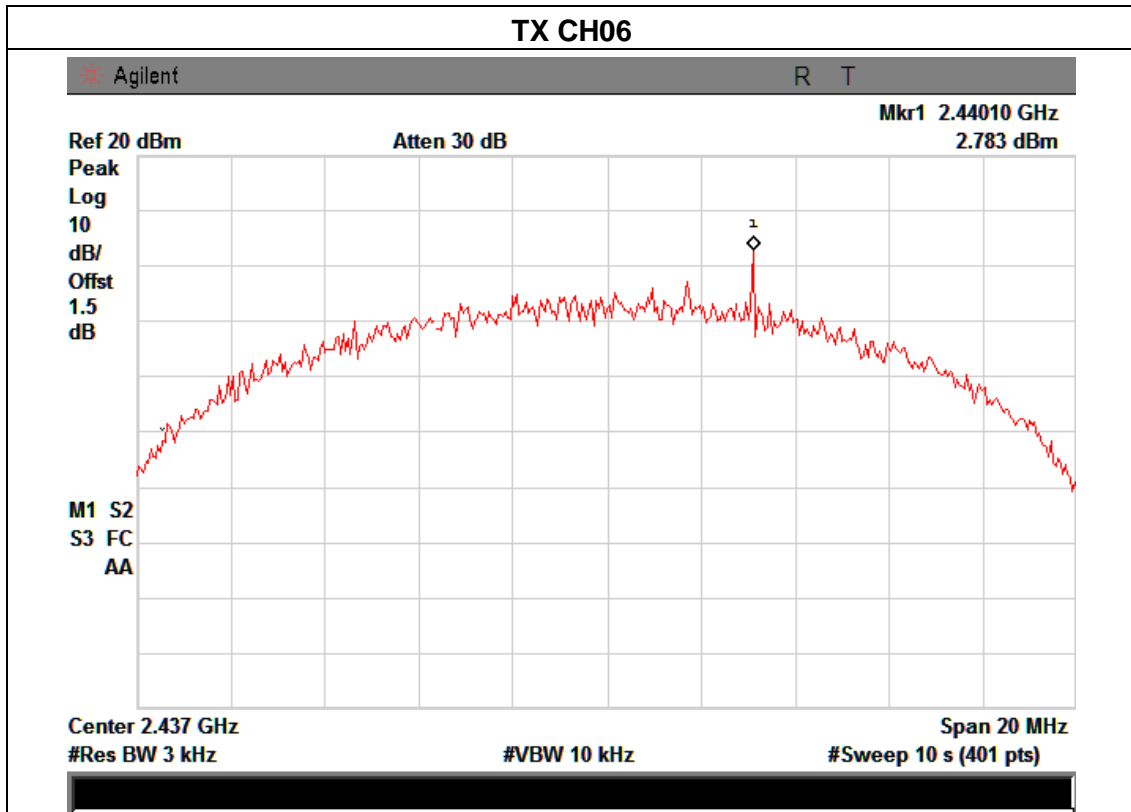

EUT :	802.11n 150M Ultra Wireless LAN Router	Model Name :	AIP-W511
Temperature :	25 °C	Relative Humidity :	60%
Pressure :	1015 hPa	Test Voltage :	DC 3.7V
Test Mode :	TX g Mode /CH01, CH06, CH11		

Frequency	Power Density (dBm)	Limit (dBm)	Result
2412 MHz	-12.19	8	<b>PASS</b>
2437 MHz	-12.27	8	<b>PASS</b>
2462 MHz	-11.31	8	<b>PASS</b>

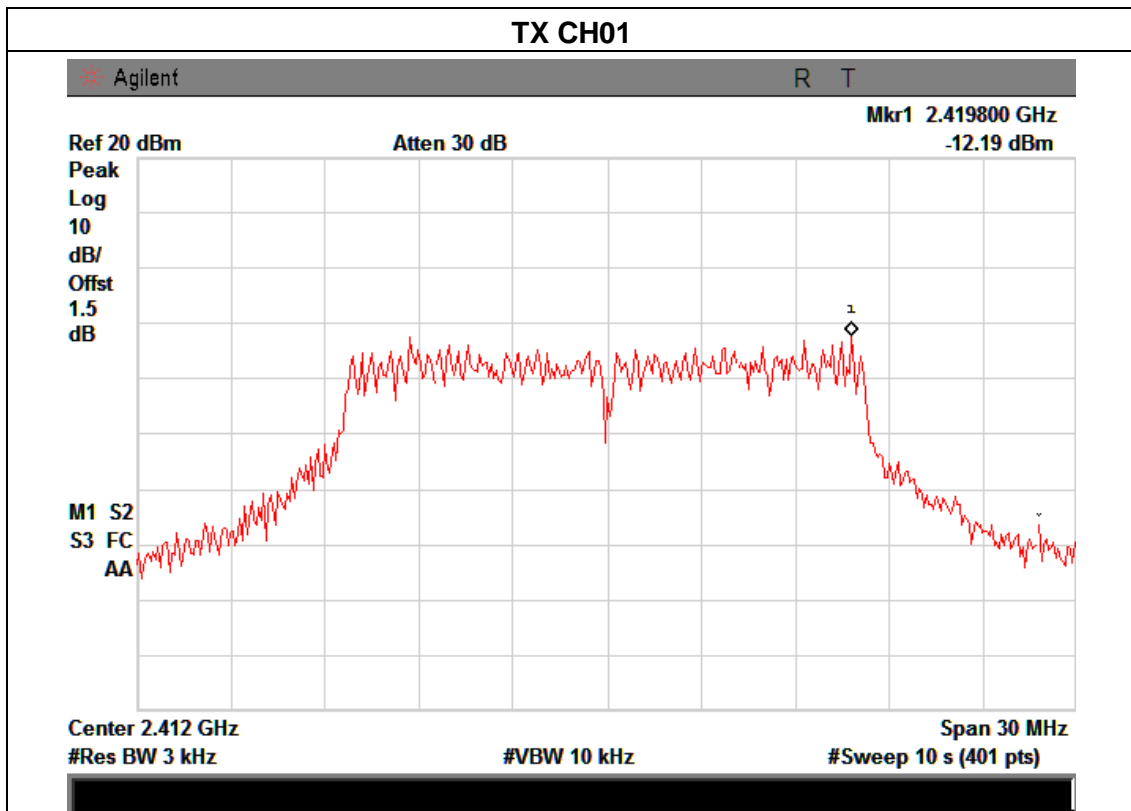

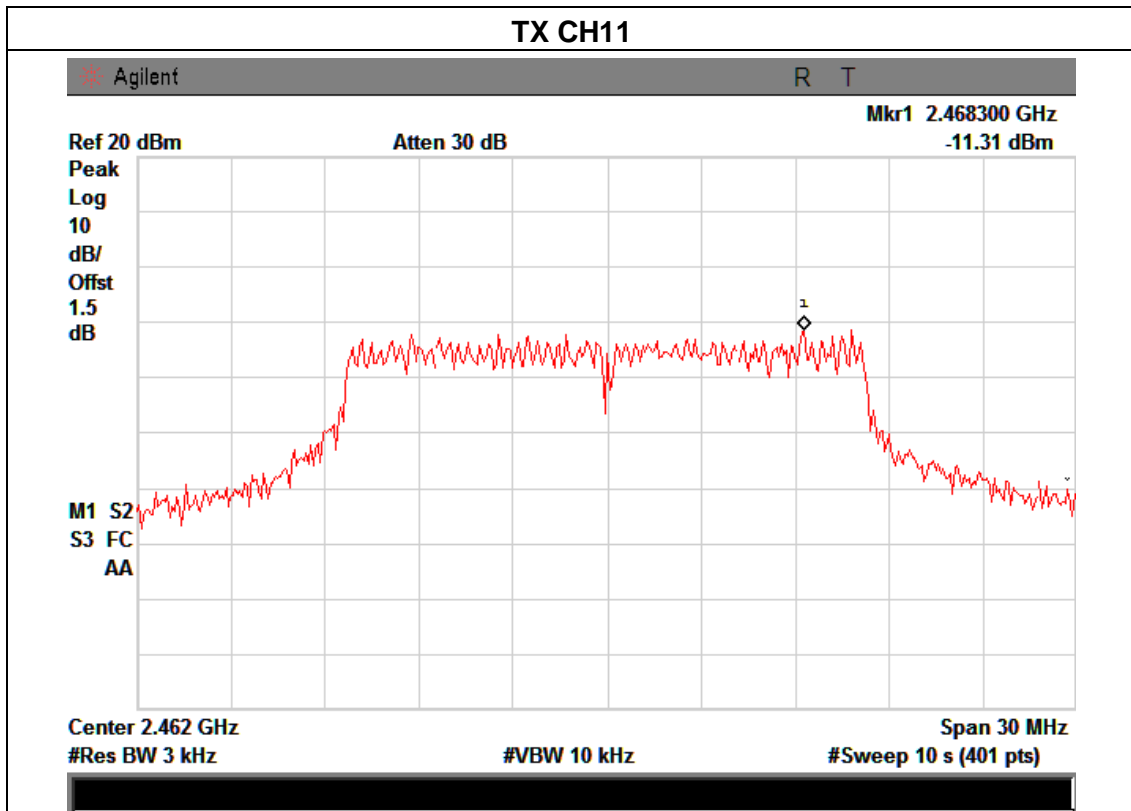
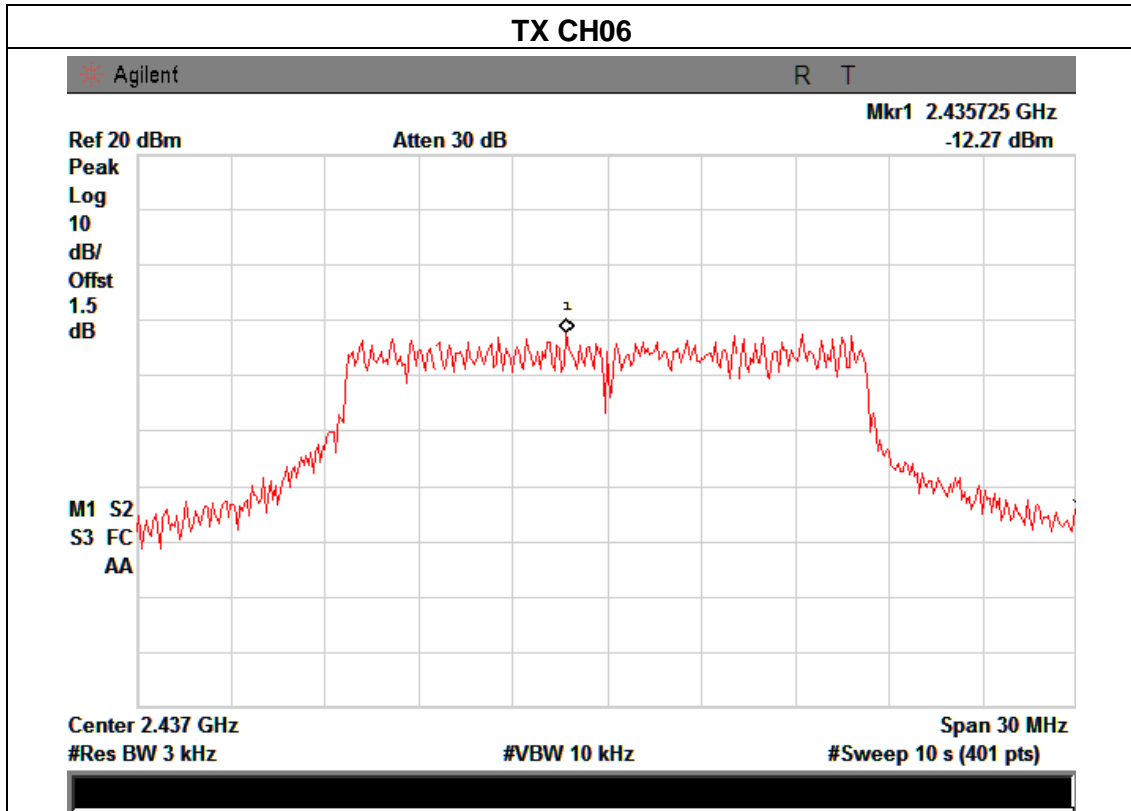



EUT :	802.11n 150M Ultra Wireless LAN Router	Model Name :	AIP-W511
Temperature :	25 °C	Relative Humidity :	60%
Pressure :	1015 hPa	Test Voltage :	DC 3.7V
Test Mode :	TX n Mode(20M) /CH01, CH06, CH11		

Frequency	Power Density (dBm)	Limit (dBm)	Result
2412 MHz	-12.02	8	PASS
2437 MHz	-11.75	8	PASS
2462 MHz	-10.51	8	PASS

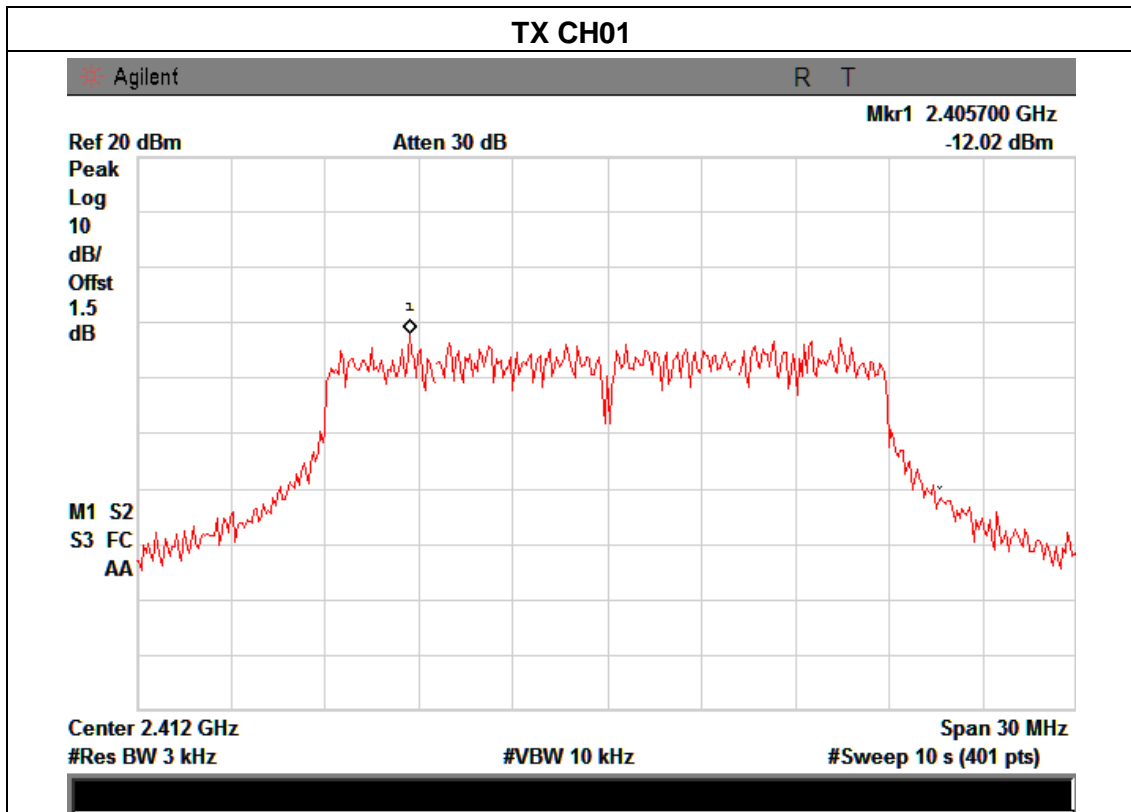

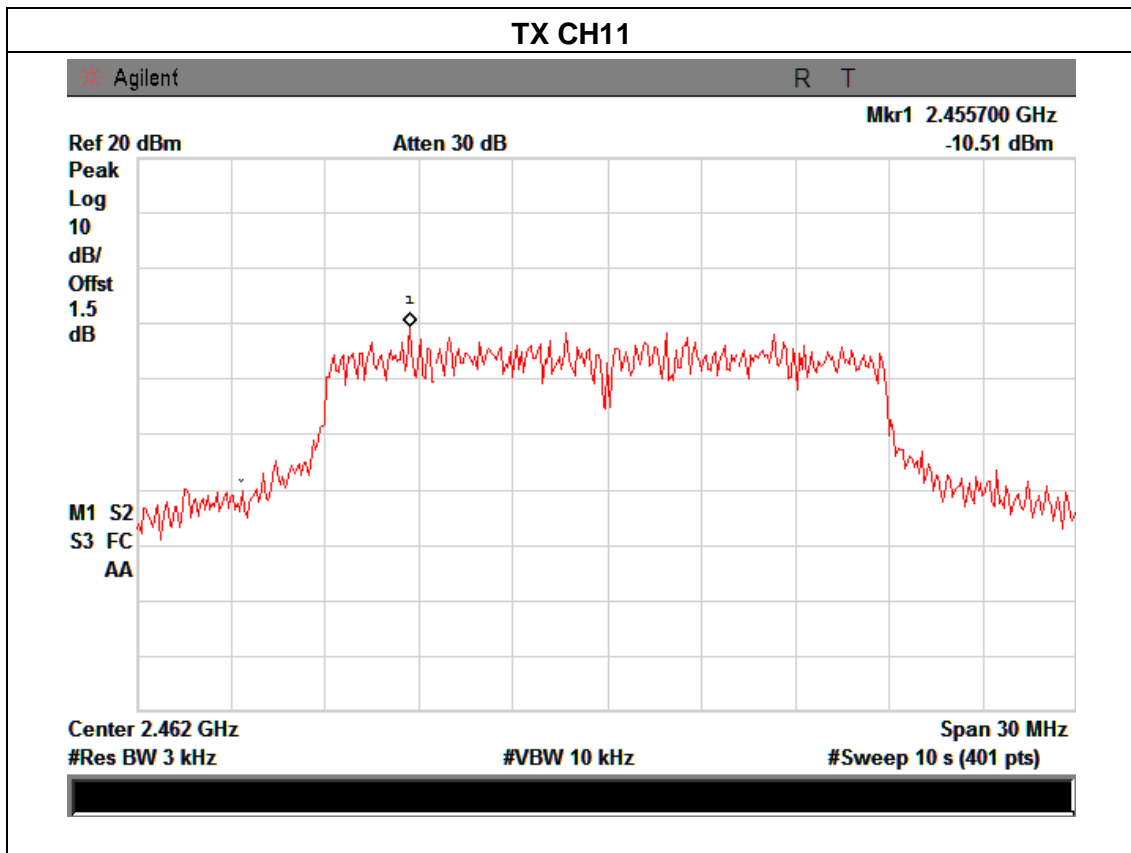
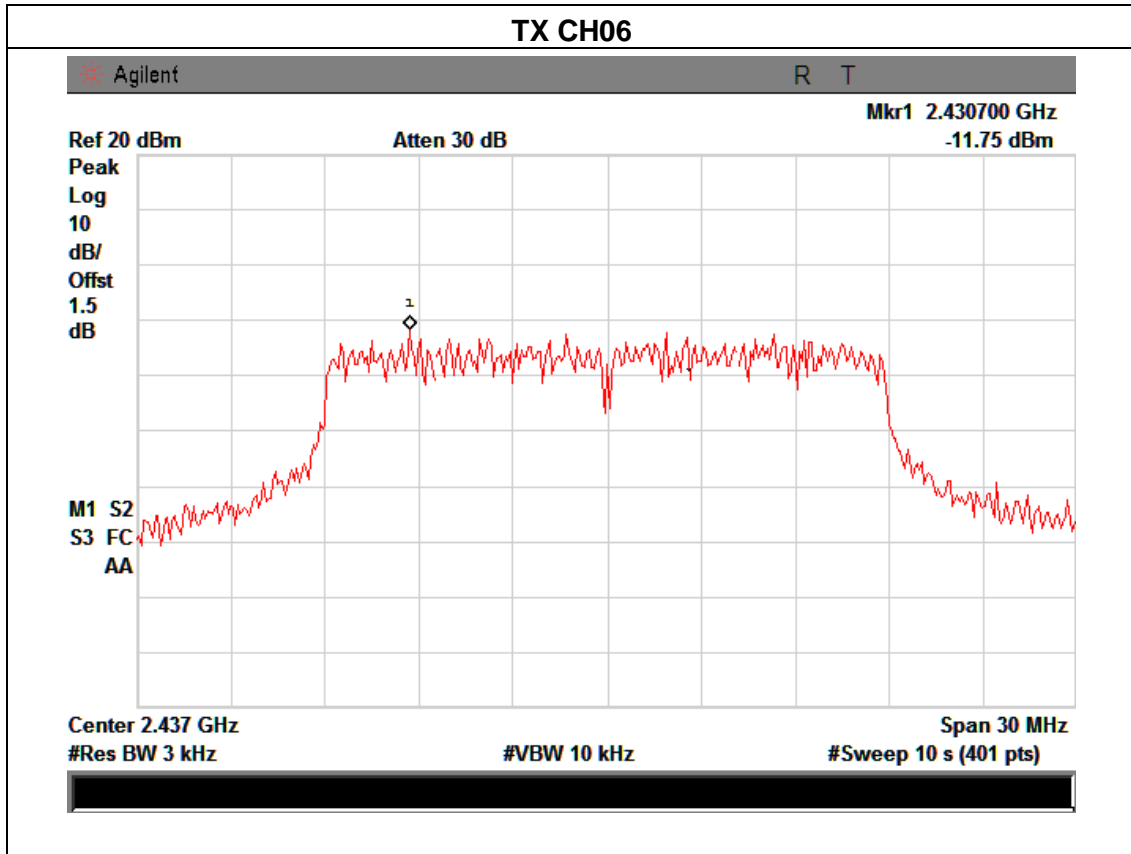

EUT :	802.11n 150M Ultra Wireless LAN Router	Model Name :	AIP-W511
Temperature :	25 °C	Relative Humidity :	60%
Pressure :	1015 hPa	Test Voltage :	DC 3.7V
Test Mode :	TX n Mode(40M) /CH03, CH06, CH09		

Frequency	Power Density (dBm)	Limit (dBm)	Result
2422 MHz	-12.05	8	PASS
2437 MHz	-11.90	8	PASS
2452 MHz	-12.55	8	PASS

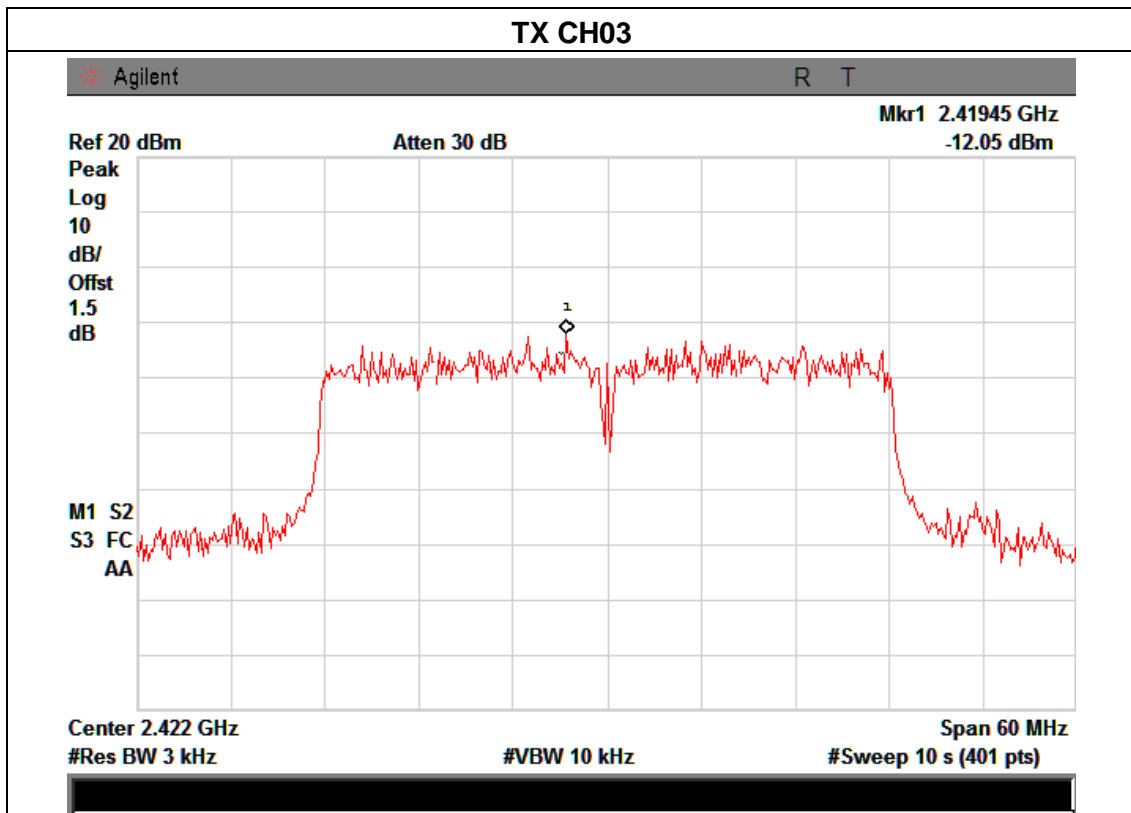

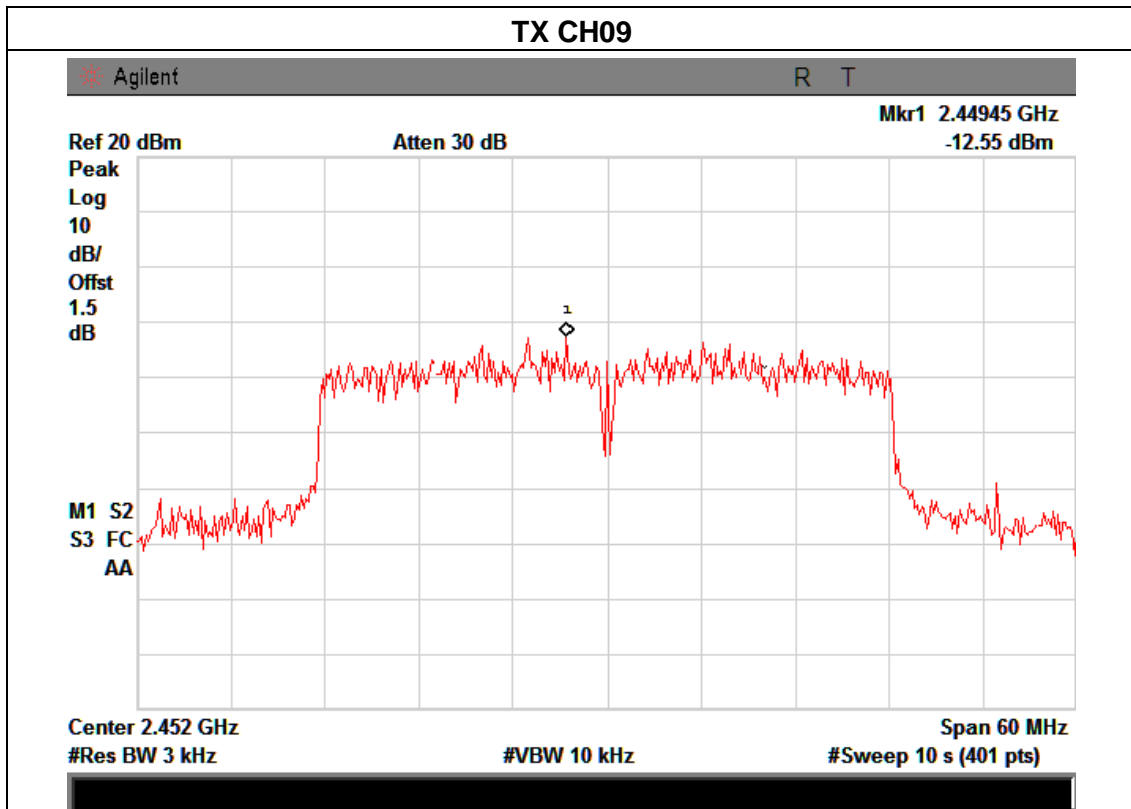
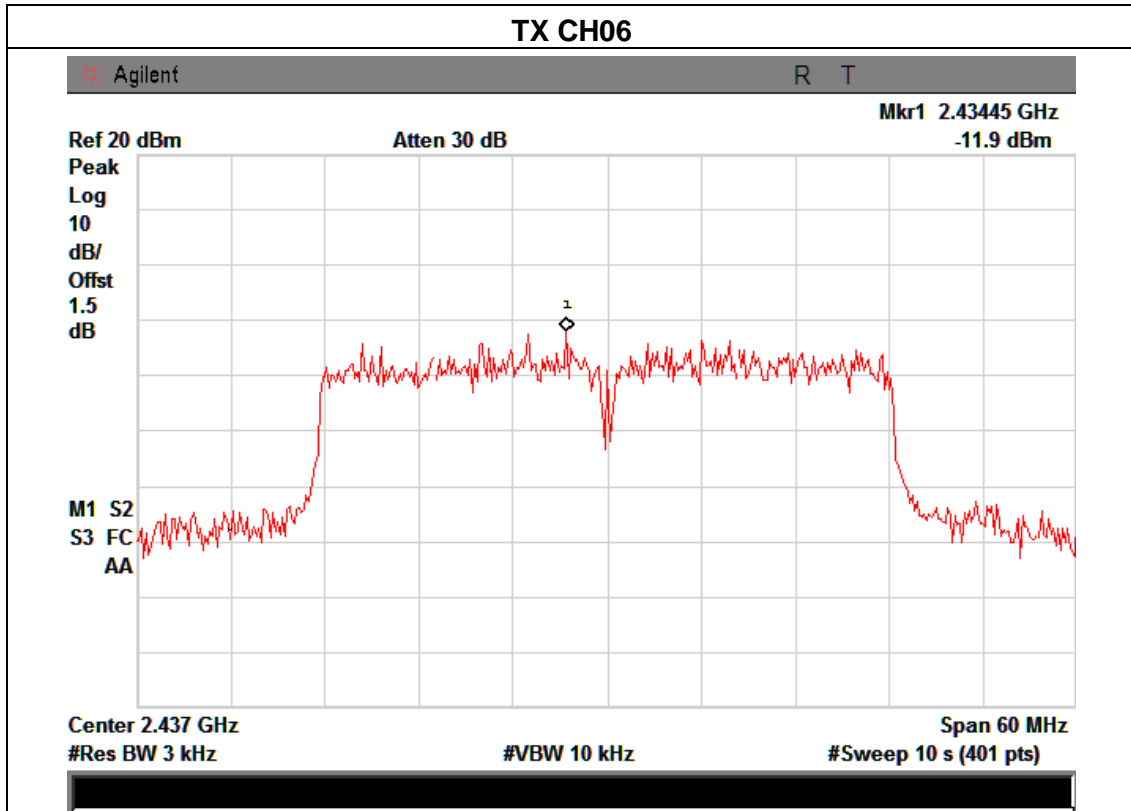

## 5. BANDWIDTH TEST

### 5.1 APPLIED PROCEDURES / LIMIT

FCC Part15 (15.247) , Subpart C				
Section	Test Item	Limit	Frequency Range (MHz)	Result
15.247(a)(2)	Bandwidth	$\geq 500\text{KHz}$ (6dB bandwidth)	2400-2483.5	PASS

#### 5.1.1 TEST PROCEDURE

Set RBW = 100 kHz.

Set the video bandwidth (VBW)  $\geq 3 \square$  RBW.

Detector = Peak.

Trace mode = max hold.

Sweep = auto couple.

Allow the trace to stabilize.

Measure the maximum width of the emission that is constrained by the frequencies associated with the two outermost amplitude points (upper and lower frequencies) that are attenuated by 6 dB relative to the maximum level measured in the fundamental emission.

#### 5.1.2 DEVIATION FROM STANDARD

No deviation.

#### 5.1.3 TEST SETUP

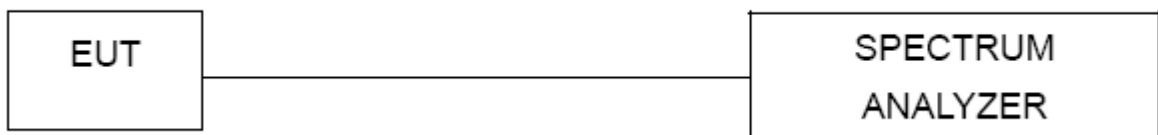

#### 5.1.4 EUT OPERATION CONDITIONS

The EUT tested system was configured as the statements of 2.3 Unless otherwise a special operating condition is specified in the follows during the testing.

### 5.1.5 TEST RESULTS

EUT :	802.11n 150M Ultra Wireless LAN Router	Model Name :	AIP-W511
Temperature :	25 °C	Relative Humidity :	60%
Pressure :	1012 hPa	Test Voltage :	DC 3.7V
Test Mode :	TX b Mode /CH01, CH06, CH11		

Frequency	6dB Bandwidth (MHz)	99% Occupied BW (MHz)	Channel Separation (MHz)	Result
2412 MHz	9.39	14.91	>=500KHz	<b>PASS</b>
2437 MHz	9.36	14.98	>=500KHz	<b>PASS</b>
2462 MHz	10.22	15.26	>=500KHz	<b>PASS</b>

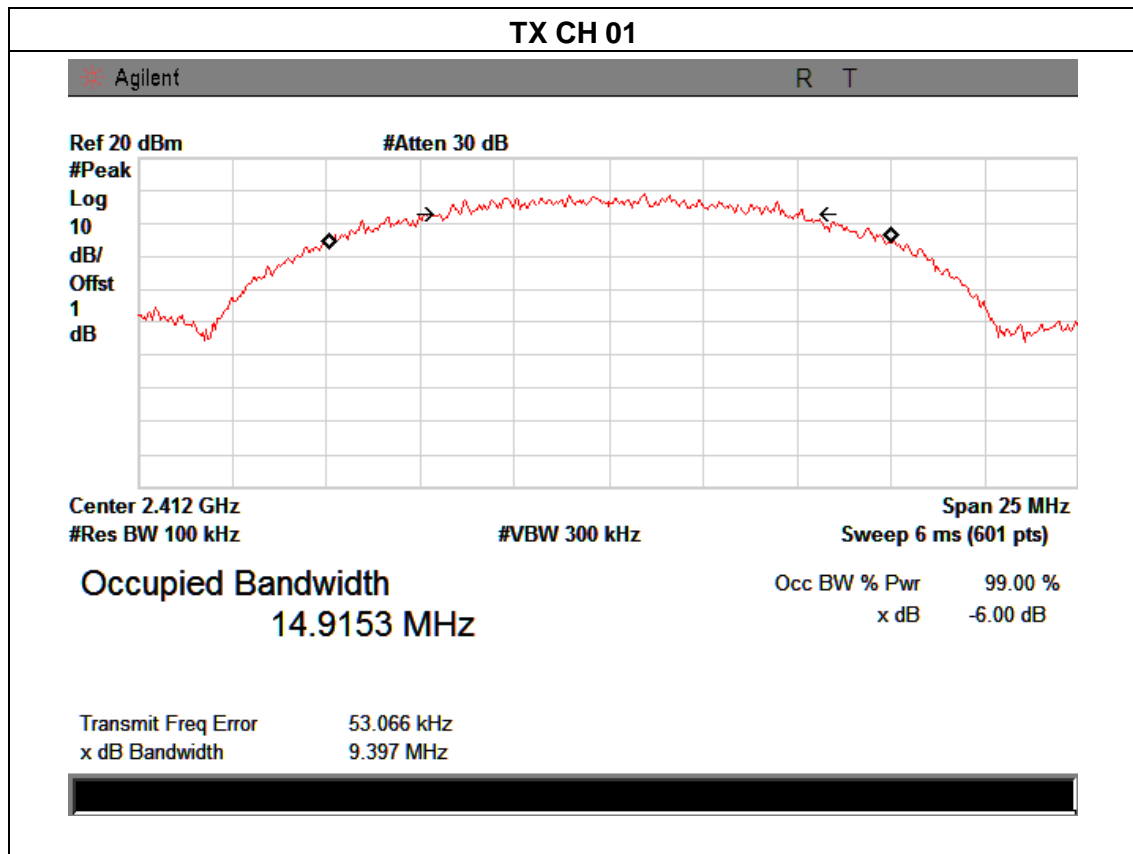

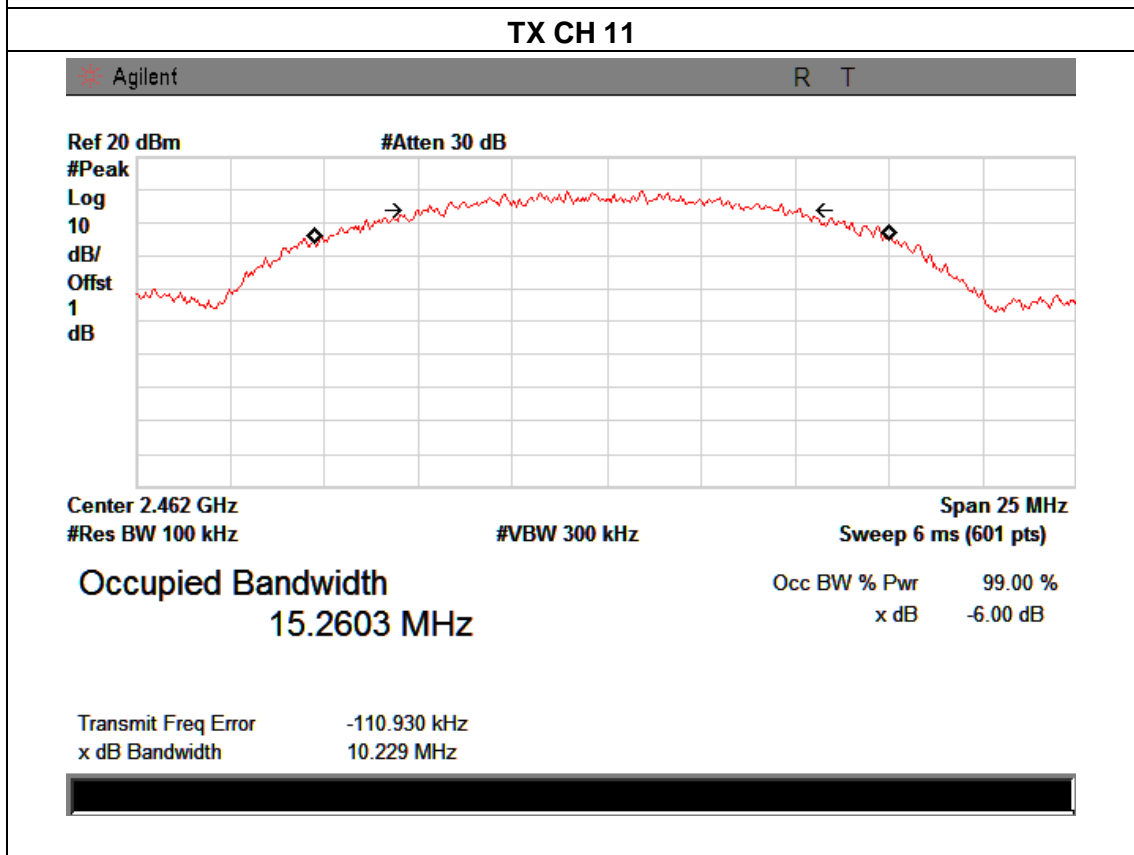
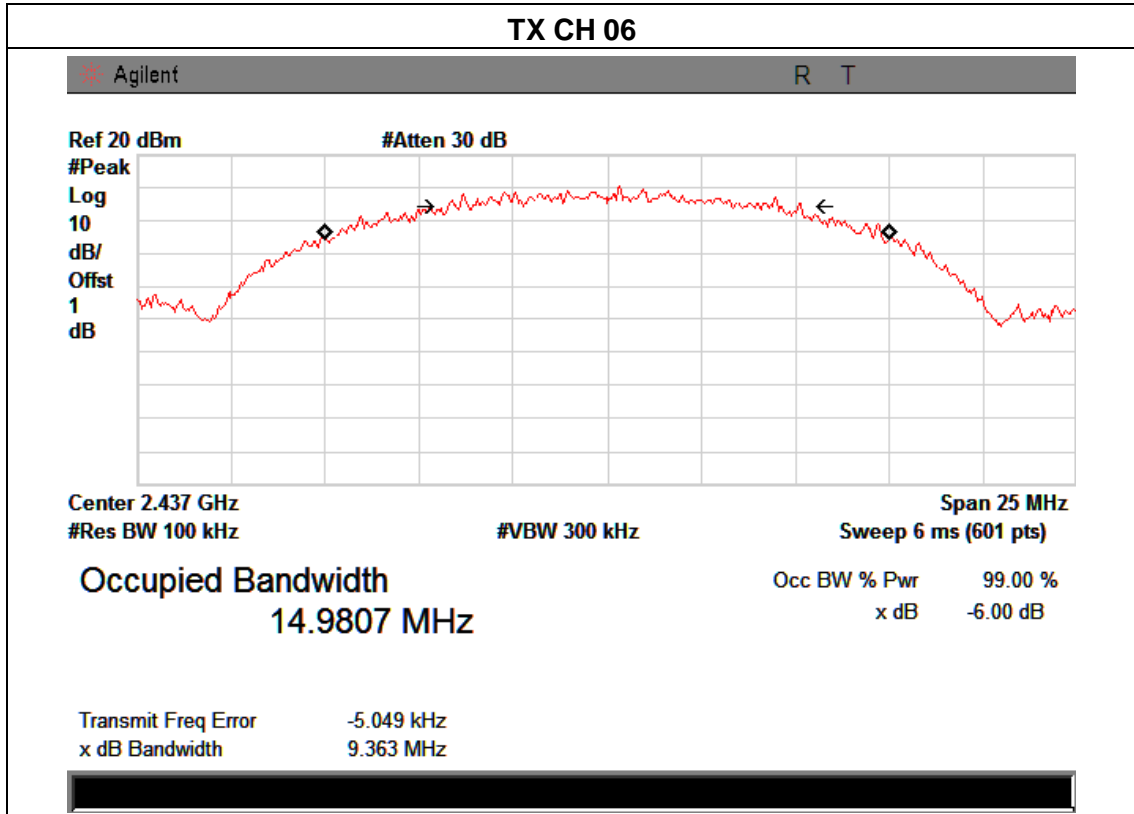

EUT :	802.11n 150M Ultra Wireless LAN Router	Model Name :	AIP-W511
Temperature :	25 °C	Relative Humidity :	60%
Pressure :	1012 hPa	Test Voltage :	DC 3.7V
Test Mode :	TX g Mode /CH01, CH06, CH11		

Frequency	6dB Bandwidth (MHz)	99% Occupied BW (MHz)	Channel Separation (MHz)	Result
2412 MHz	16.42	16.45	>=500KHz	<b>PASS</b>
2437 MHz	16.41	16.45	>=500KHz	<b>PASS</b>
2462 MHz	16.46	16.48	>=500KHz	<b>PASS</b>

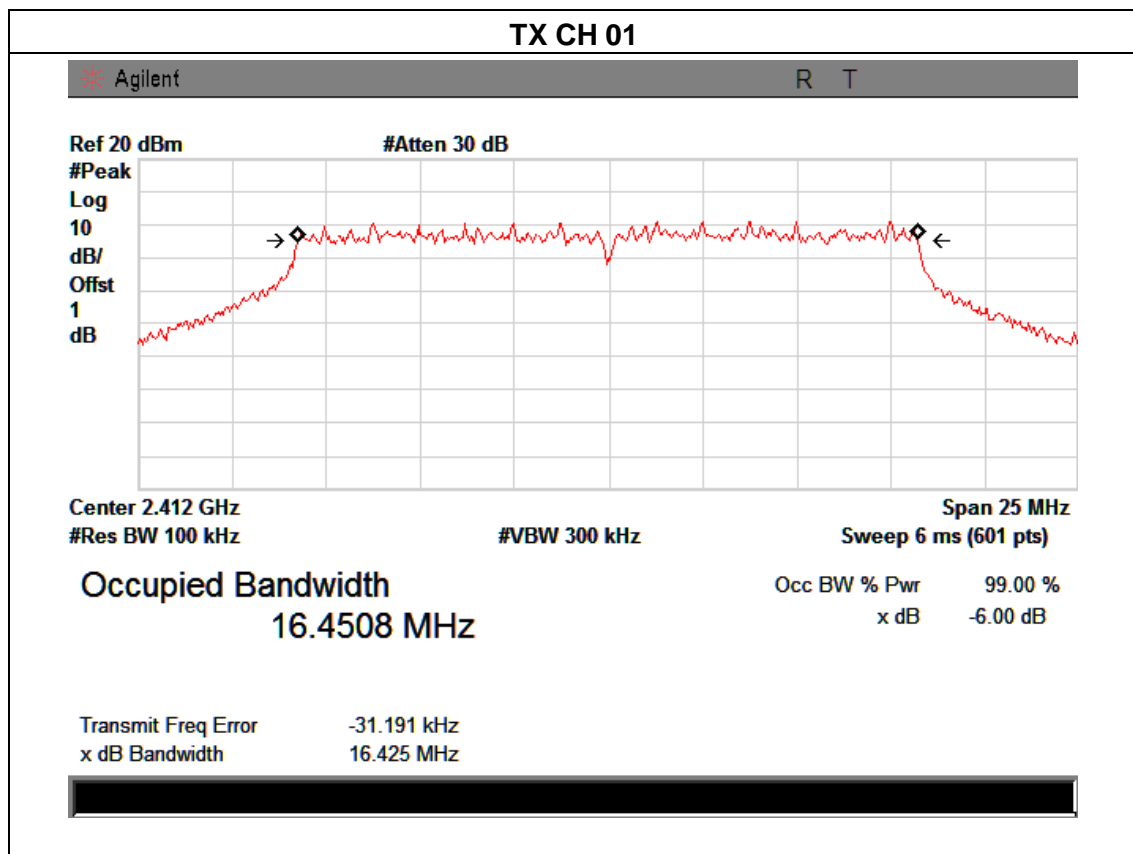



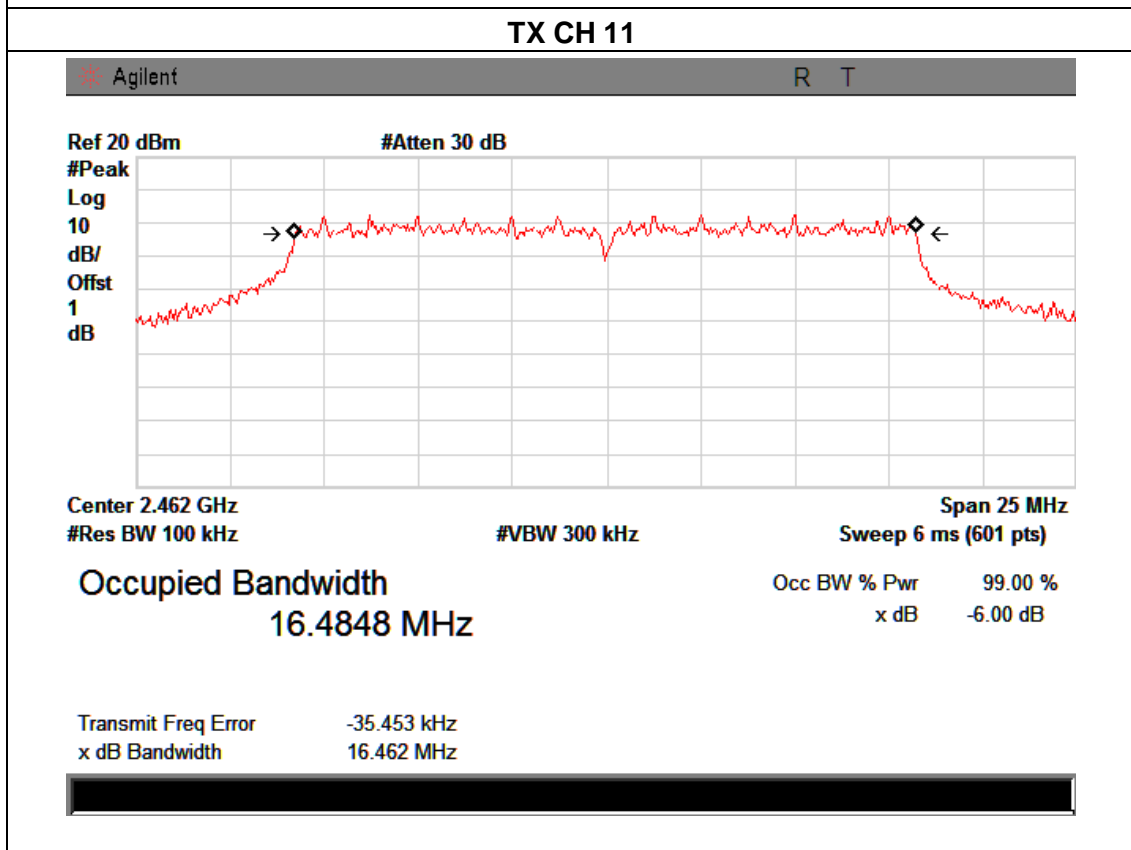
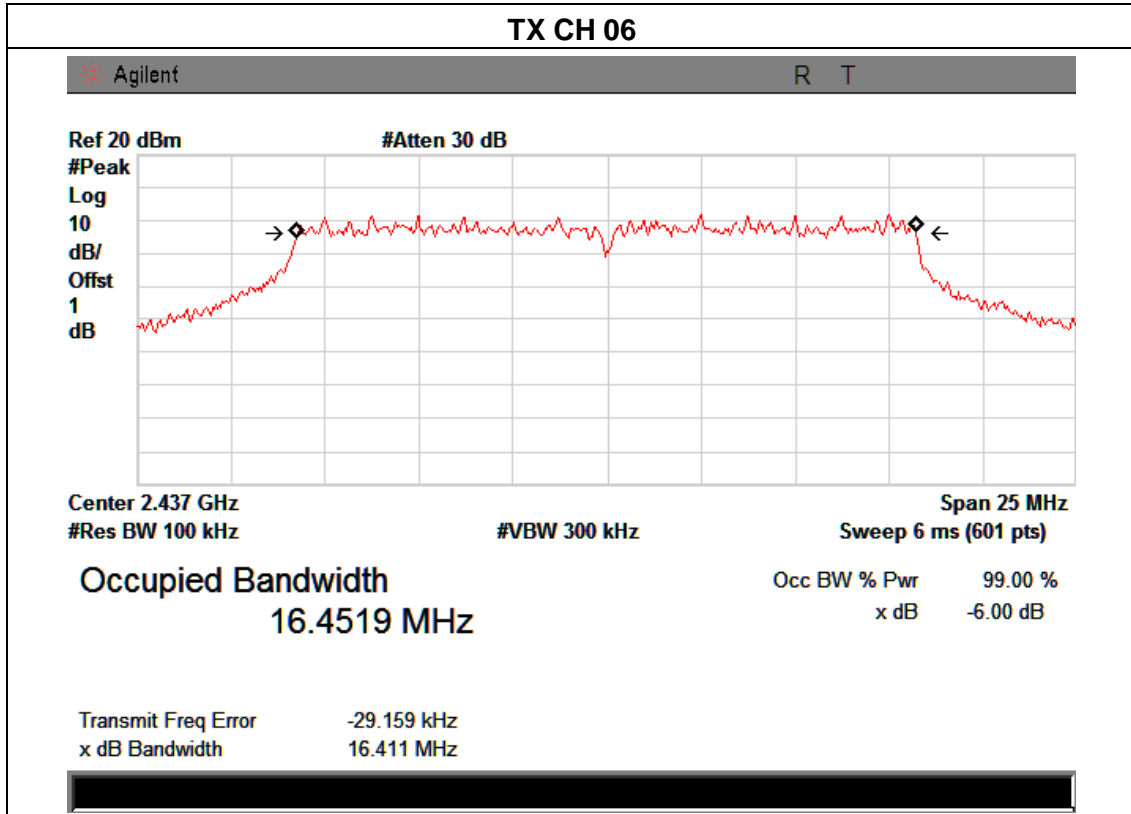

EUT :	802.11n 150M Ultra Wireless LAN Router	Model Name :	AIP-W511
Temperature :	25 °C	Relative Humidity :	60%
Pressure :	1012 hPa	Test Voltage :	DC 3.7V
Test Mode :	TX n Mode(20M) /CH01, CH06, CH11		

Frequency	6dB Bandwidth (MHz)	99% Occupied BW (MHz)	Channel Separation (MHz)	Result
2412 MHz	17.63	17.64	>=500KHz	<b>PASS</b>
2437 MHz	17.65	17.67	>=500KHz	<b>PASS</b>
2462 MHz	17.64	17.64	>=500KHz	<b>PASS</b>

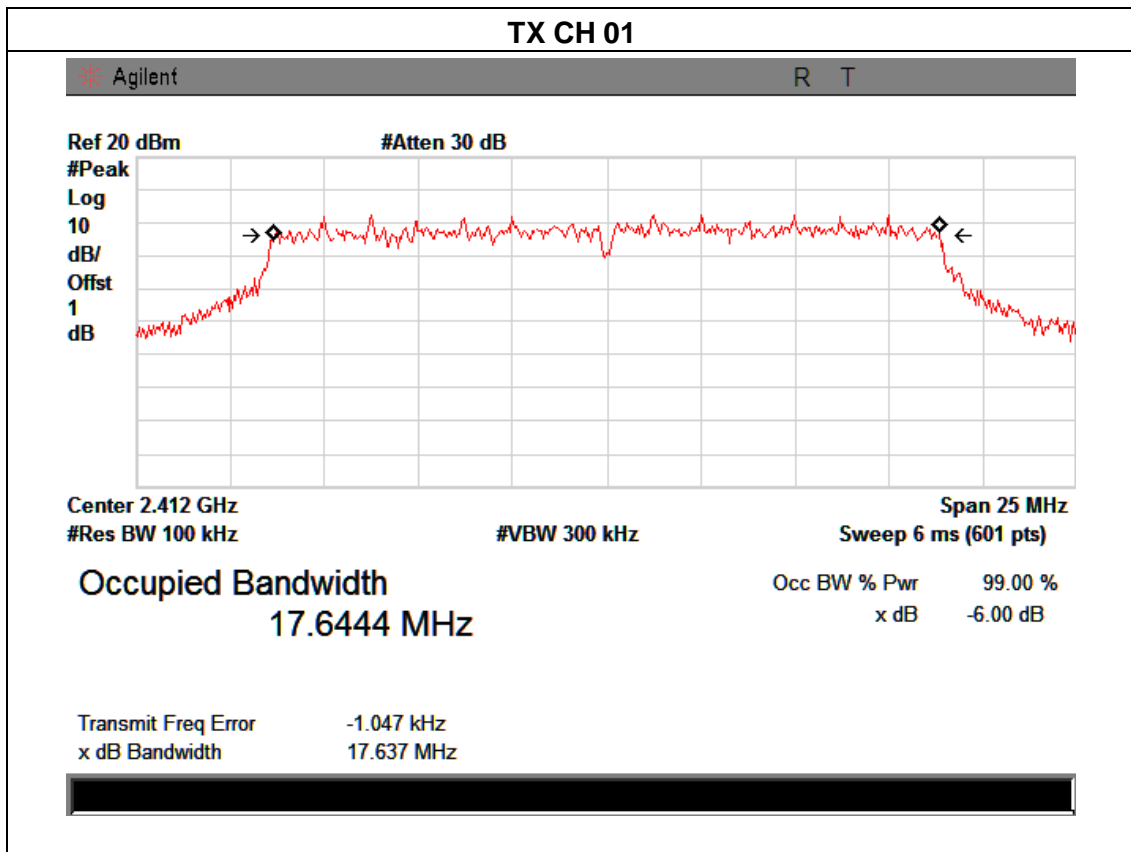

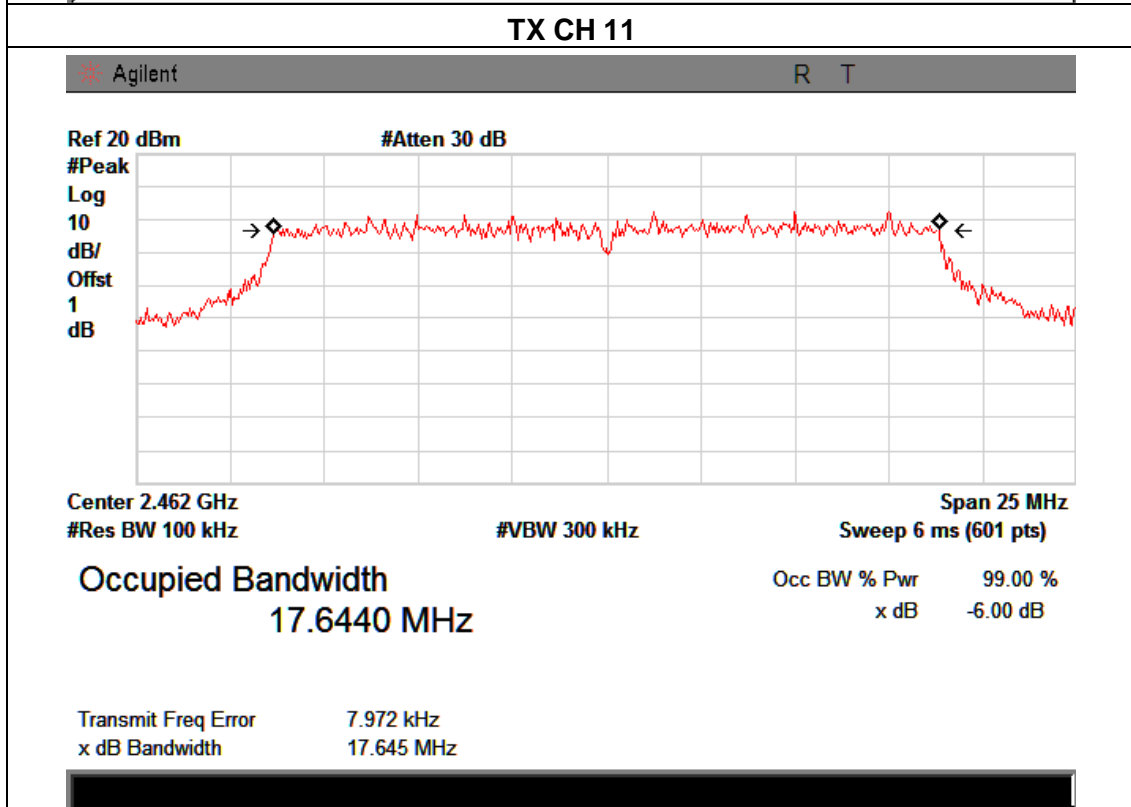
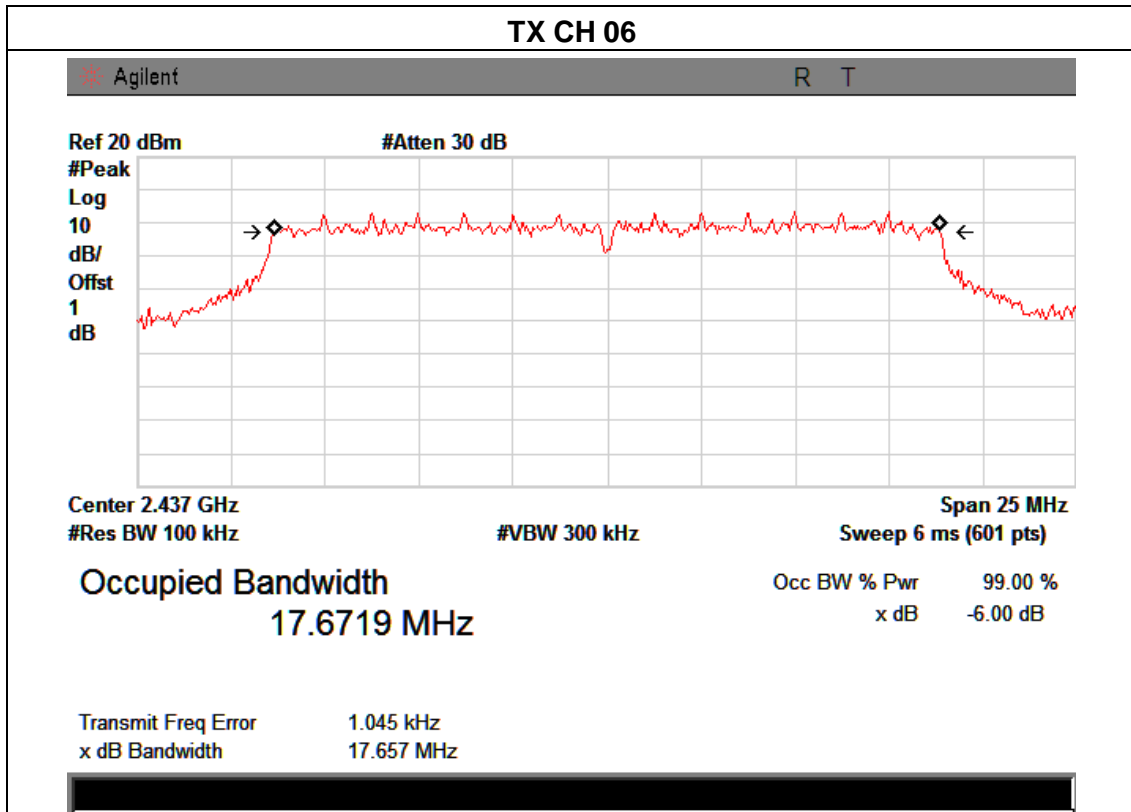

EUT :	802.11n 150M Ultra Wireless LAN Router	Model Name :	AIP-W511
Temperature :	25 °C	Relative Humidity :	60%
Pressure :	1012 hPa	Test Voltage :	DC 3.7V
Test Mode :	TX n Mode(40M) /CH03, CH06, CH09		

Frequency	6dB Bandwidth (MHz)	99% Occupied BW (MHz)	Channel Separation (MHz)	Result
2422 MHz	35.07	35.81	>=500KHz	<b>PASS</b>
2437 MHz	35.20	35.85	>=500KHz	<b>PASS</b>
2452 MHz	35.25	35.83	>=500KHz	<b>PASS</b>

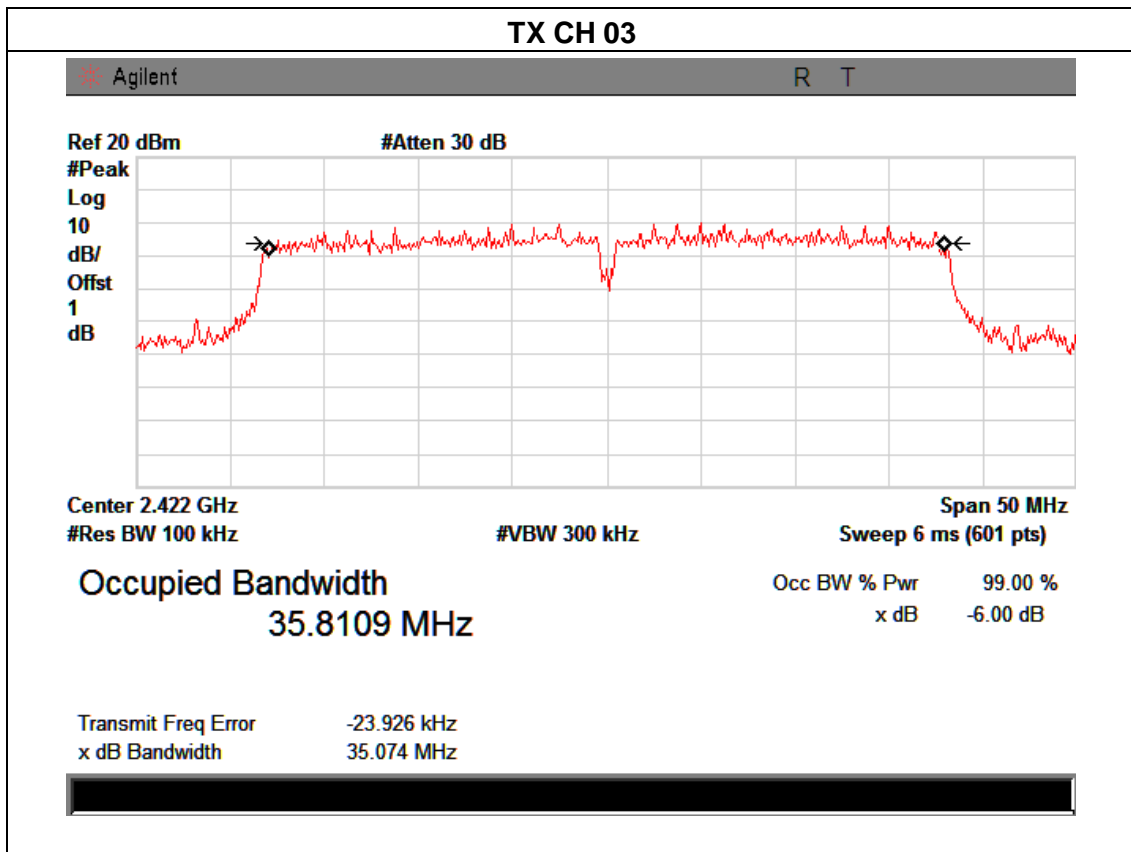

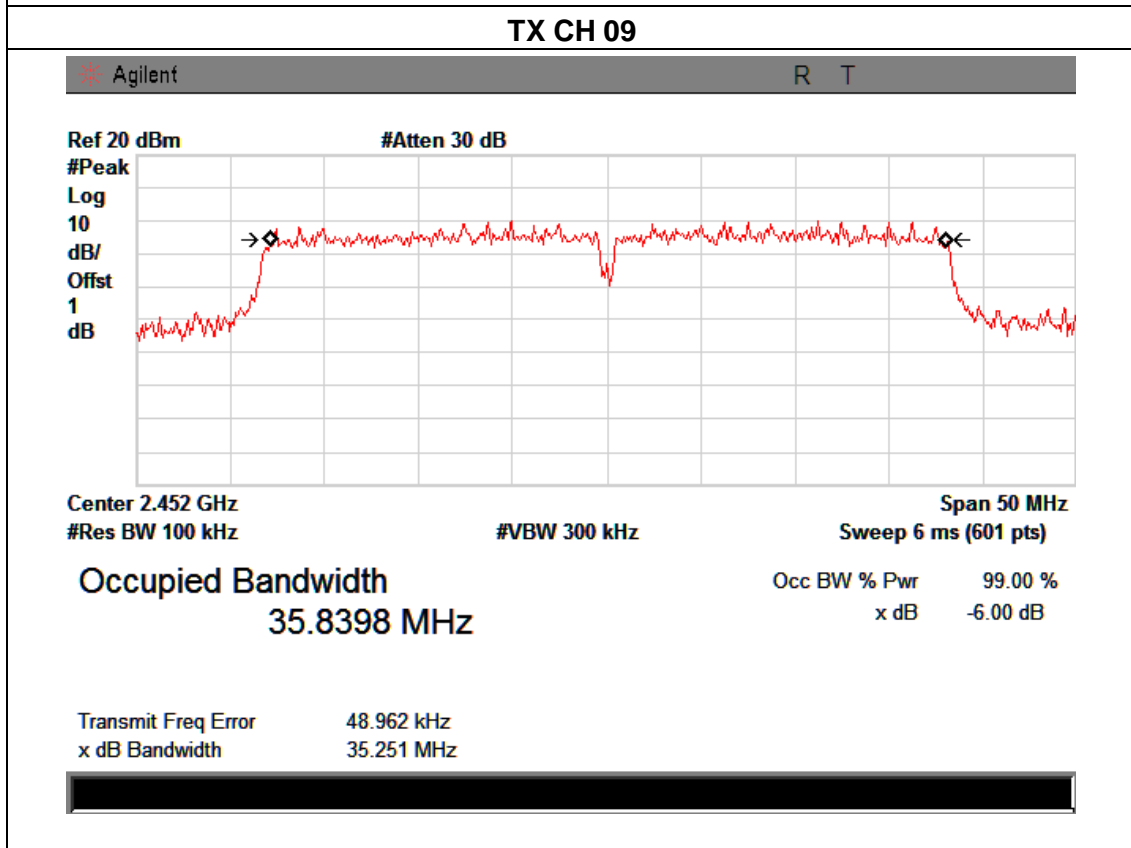
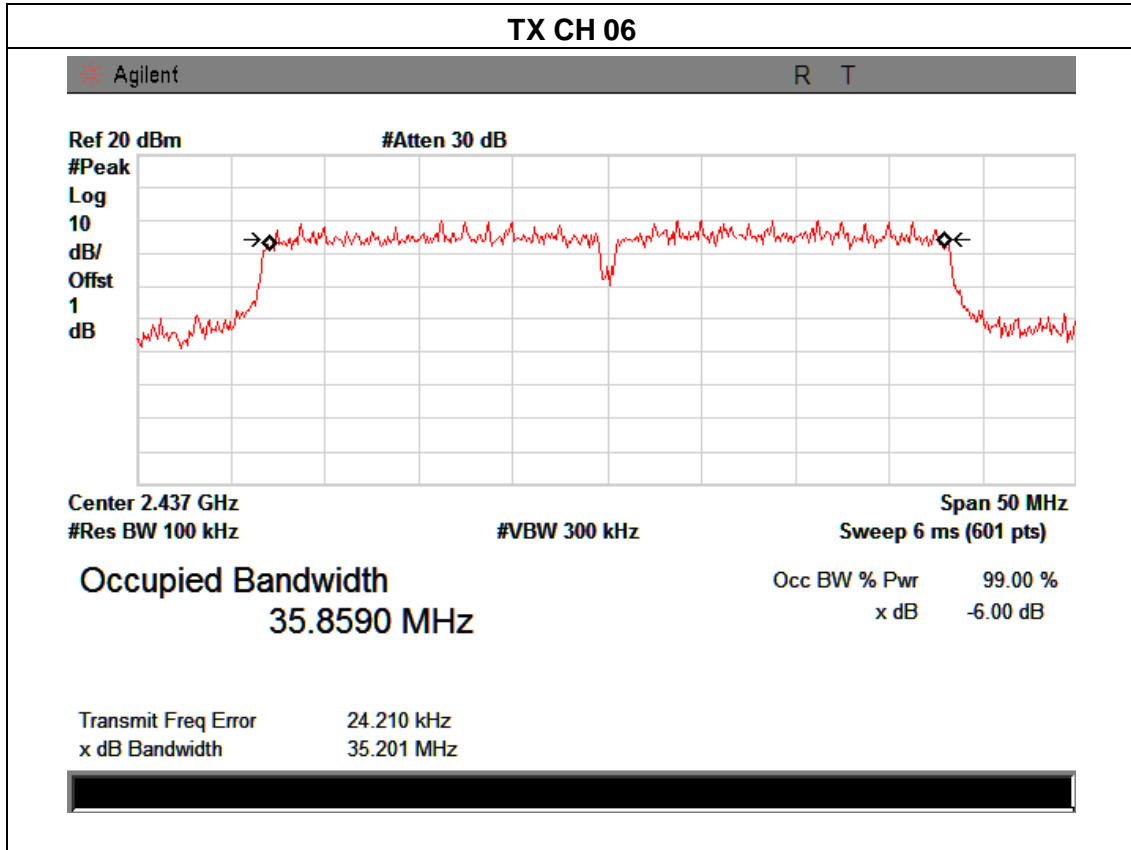

**6. PEAK OUTPUT POWER TEST**

**6.1 APPLIED PROCEDURES / LIMIT**

FCC Part15 (15.247) , Subpart C				
Section	Test Item	Limit	Frequency Range (MHz)	Result
15.247(b)(3)	Peak Output Power	1 watt or 30dBm	2400-2483.5	PASS

**6.1.1 TEST PROCEDURE**

- a. The EUT was directly connected to the Power meter

**6.1.2 DEVIATION FROM STANDARD**

No deviation.

**6.1.3 TEST SETUP**



**6.1.4 EUT OPERATION CONDITIONS**

The EUT tested system was configured as the statements of 2.3 Unless otherwise a special operating condition is specified in the follows during the testing.

**6.1.5 TEST RESULTS**

EUT :	802.11n 150M Ultra Wireless LAN Router	Model Name :	AIP-W511
Temperature :	25 °C	Relative Humidity :	60%
Pressure :	1012 hPa	Test Voltage :	DC 3.7V
Test Mode :	TX b/g/n(20M,40M) Mode /CH01, CH06, CH11		

<b>TX 802.11b Mode</b>			
Test Channe	Frequency	Peak Conducted Output Power	LIMIT
	(MHz)	(dBm)	dBm
CH01	2412	9.24	30
CH06	2437	9.18	30
CH11	2462	8.97	30
<b>TX 802.11g Mode</b>			
CH01	2412	8.03	30
CH06	2437	8.25	30
CH11	2462	7.96	30
<b>TX 802.11n20 Mode</b>			
CH01	2412	7.88	30
CH06	2437	7.75	30
CH11	2462	7.58	30
<b>TX 802.11n40 Mode</b>			
CH03	2422	7.09	30
CH06	2437	6.85	30
CH09	2452	6.47	30

## **7. ANTENNA REQUIREMENT**

### **7.1 STANDARD REQUIREMENT**

15.203 requirement: For intentional device, according to 15.203: an intentional radiator shall be designed to ensure that no antenna other than that furnished by the responsible party shall be used with the device.

### **7.2 EUT ANTENNA**

The EUT antenna is Internal antenna. It comply with the standard requirement.



### 8. EUT TEST PHOTO

#### Radiated Measurement Photos

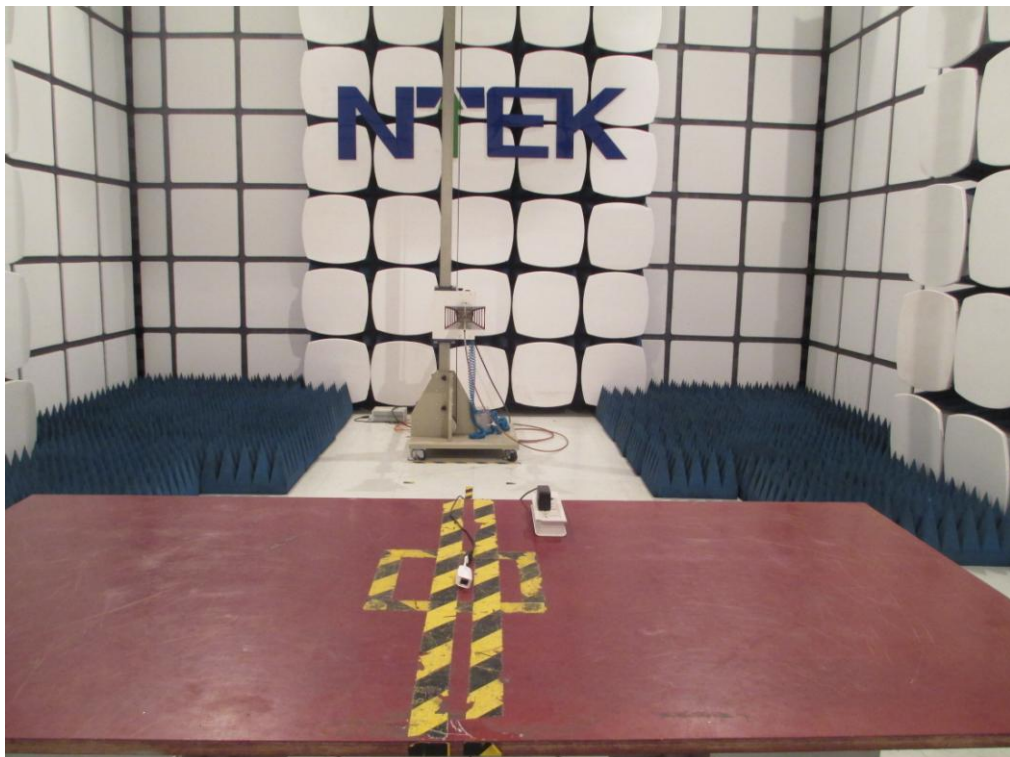
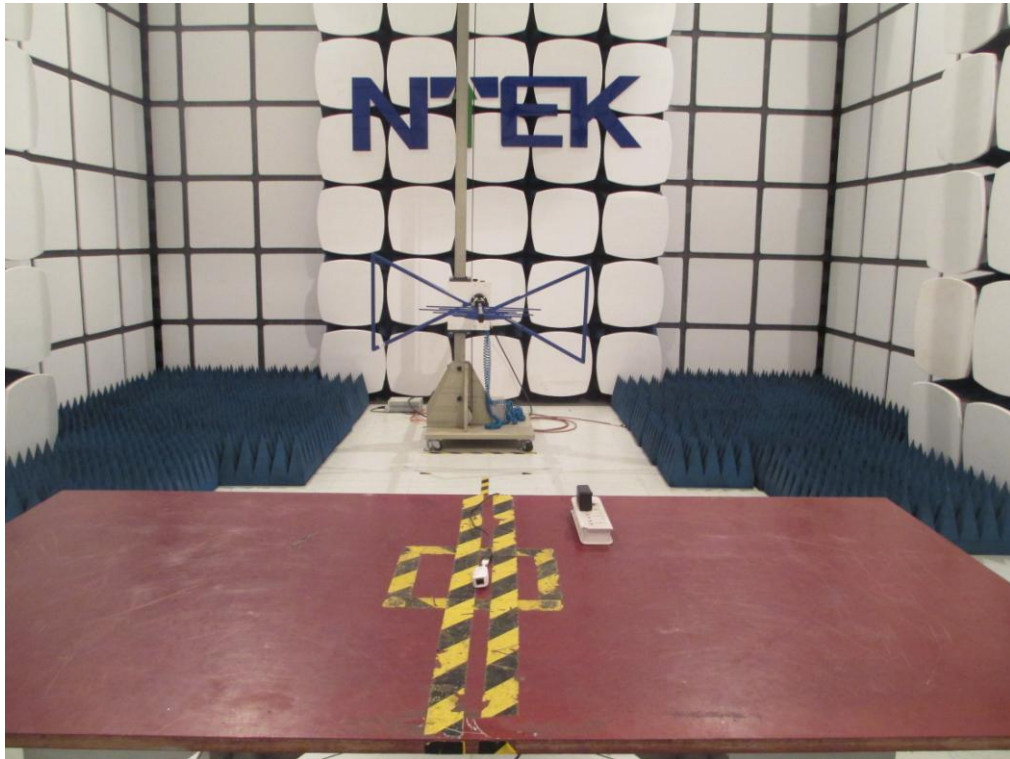

### Conducted Measurement Photos

