

FCC 47 CFR PART 15 SUBPART C

RF Test Report

Applicant : Iconnect
Applicant Address : No.9, Aly.58, Ln, 112, Ruiguang Rd., Neihu Dist, Taipei City,
Taiwan
Product Type : WiFi Pineapple
Trade Name : Hak5
Model Number : NANO
Applicable Standard : FCC 47 CFR PART 15 SUBPART C
ANSI C63.10:2013
Receive Date : Oct. 07, 2015
Test Period : Oct. 28 ~ 30, 2015
Issue Date : Nov. 20, 2015

Issue by

A Test Lab Techno Corp.
No. 140-1, Changan Street, Bade District,
Taoyuan City 33465, Taiwan (R.O.C)
Tel : +886-3-2710188 / Fax : +886-3-2710190



Taiwan Accreditation Foundation accreditation number: 1330

Note: This report shall not be reproduced except in full, without the written approval of A Test Lab Techno Corp. This document may be altered or revised by A Test Lab Techno Corp. personnel only, and shall be noted in the revision section of the document. The client should not use it to claim product endorsement by TAF, or any government agencies. The test results in the report only apply to the tested sample.

Revision History

Rev.	Issue Date	Revisions	Revised By
00	Nov. 16, 2015	Initial Issue	
01	Nov. 20, 2015	Revised report information.	Nico Peng

Verification of Compliance

Issued Date: 11/20/2015

Applicant : Iconnect
Address Applicant : No.9, Aly.58, Ln, 112, Ruiguang Rd., Neihu Dist, Taipei City, Taiwan
Product Type : WiFi Pineapple
Trade Name : Hak5
Model Number : NANO
FCC ID : 2AB87-NANO
EUT Rated Voltage : DC 5V, 2A
Test Voltage : 120 Vac / 60 Hz
Applicable Standard : FCC 47 CFR PART 15 SUBPART C
ANSI C63.10:2013
Test Result : Complied
Performing Lab. : A Test Lab Techno Corp.

No. 140-1, Changan Street, Bade District,
Taoyuan City 33465, Taiwan (R.O.C)
Tel : +886-3-2710188 / Fax : +886-3-2710190
Taiwan Accreditation Foundation accreditation number: 1330
<http://www.atl-lab.com.tw/e-index.htm>



A Test Lab Techno Corp. tested the above equipment in accordance with the requirements set forth in the above standards. All indications of Pass/Fail in this report are opinions expressed by A Test Lab Techno Corp. based on interpretations and/or observations of test results. Measurement Uncertainties were not taken into account and are published for informational purposes only. The test results show that the equipment tested is capable of demonstrating compliance with the requirements as documented in this report.

Approved By
(Manager)

: Fly Lu
(Fly Lu)

Reviewed By

(Testing Engineer)

: Eric Ou Yang
(Eric Ou Yang)

TABLE OF CONTENTS

1	General Information	6
2	EUT Description.....	7
3	Test Methodology.....	8
	3.1. Mode of Operation.....	8
	3.2. EUT Exercise Software	17
	3.3. Configuration of Test System Details.....	18
	3.4. Test Site Environment.....	19
4	Conducted Emission Measurement.....	20
	4.1. Limit.....	20
	4.2. Test Instruments	20
	4.3. Test Setup	20
	4.4. Test Procedure	21
	4.5. Test Result.....	22
5	Radiated Emission Measurement	26
	5.1. Limit.....	26
	5.2. Test Instruments	26
	5.3. Setup.....	27
	5.4. Test Procedure	29
	5.5. Test Result.....	31
6	Maximum Conducted Output Power Measurement.....	53
	6.1. Limit.....	53
	6.2. Test Setup	53
	6.3. Test Instruments	53
	6.4. Test Procedure	53
	6.5. Test Result.....	54
7	6dB RF Bandwidth Measurement.....	58
	7.1. Limit.....	58
	7.2. Test Setup	58
	7.3. Test Instruments	58
	7.4. Test Procedure	58
	7.5. Test Result.....	59
	7.6. Test Graphs	60

8	Maximum Power Density Measurement	68
8.1.	Limit	68
8.2.	Test Setup	68
8.3.	Test Instruments	68
8.4.	Test Procedure	68
8.5.	Test Result	69
8.6.	Test Graphs	70
9	Out of Band Conducted Emissions Measurement	78
9.1.	Limit	78
9.2.	Test Setup	78
9.3.	Test Instruments	78
9.4.	Test Procedure	78
9.5.	Test Graphs	79
10	Antenna Measurement	103
10.1.	Limit	103
10.2.	Antenna Connector Construction	103

1 General Information

1.1 Summary of Test Result

Standard	Item	Result	Remark
15.247			
15.207	AC Power Conducted Emission	PASS	----
Standard	Item	Result	Remark
15.247			
15.247(d)	Transmitter Radiated Emissions	PASS	----
15.247(b)(3)	Max. Output Power	PASS	----
15.247(a)(2)	6dB RF Bandwidth	PASS	----
15.247(e)	Power Spectral Density	PASS	----
15.247(d)	Out of Band Conducted Spurious Emission	PASS	----
15.203	Antenna Requirement	PASS	----

The test results of this report relate only to the tested sample(s) identified in this report. Manufacturer or whom it may concern should recognize the pass or fail of the test result.

1.2 Measurement Uncertainty

Test Item	Frequency Range	Uncertainty (dB)
Conducted Emission	9kHz ~ 150KHz	2.7
	150kHz ~ 30MHz	2.8
Radiated Emission	30MHz ~ 1000MHz	6.300
	1000MHz ~ 18000MHz	5.474
	18000MHz ~ 26500MHz	5.630
	26500MHz ~ 40000MHz	5.054

2 EUT Description

Applicant	Iconnect			
Applicant Address	No.9, Aly.58, Ln, 112, Ruiguang Rd., Neihu Dist, Taipei City, Taiwan			
Manufacturer	ALFA Network, Inc.			
Manufacturer Address	4F-1, NO.106, RUEIGUANG RD., NEIHU DISTRICT, TAIPEI CITY 114,TAIWAN			
Product Type	WiFi Pineapple			
Trade Name	Hak5			
Model Number	NANO			
FCC ID	2AB87-NANO			
Operate Freq. Band	Frequency Range (MHz)	Modulation	Channel Bandwidth	Data Rate 400 / 800 GI (ns)
IEEE 802.11b	2412 ~ 2462	DSSS	20MHz	Up to 11Mbps
IEEE 802.11g	2412 ~ 2462	DSSS+OFDM	20MHz	Up to 54Mbps
IEEE 802.11n 2.4GHz 20MHz	2412 ~ 2462	OFDM	20MHz	Up to 72.2Mbps
IEEE 802.11n 2.4GHz 40MHz	2422 ~ 2452	OFDM	40MHz	Up to 150Mbps
Antenna Delivery	1TX + 1RX			
Antenna Type	Dipole Antenna (Reversed-SMA Connector)			
Antenna Gain	2 dBi			

Frequency Band	Max. RF Output Power (W)
IEEE 802.11b	0.069
IEEE 802.11g	0.254
IEEE 802.11n 2.4GHz 20MHz	0.249
IEEE 802.11n 2.4GHz 40MHz	0.088

3 Test Methodology

3.1. Mode of Operation

Decision of Test ATL has verified the construction and function in typical operation. All the test modes were carried out with the EUT in normal operation, which was shown in this test report and defined as:

Test Mode
Mode 1: AR9271L_Normal operation mode
Mode 2: AR9271L_IEEE 802.11b link mode
Mode 3: AR9271L_IEEE 802.11g link mode
Mode 4: AR9271L_IEEE 802.11n 2.4GHz 20MHz link mode
Mode 5: AR9271L_IEEE 802.11n 2.4GHz 40MHz link mode
Mode 6: AR9331_Normal operation mode
Mode 7: AR9331_IEEE 802.11b link mode
Mode 8: AR9331_IEEE 802.11g link mode
Mode 9: AR9331_IEEE 802.11n 2.4GHz 20MHz link mode
Mode 10: AR9331_IEEE 802.11n 2.4GHz 40MHz link mode

Software used to control the EUT for staying in continuous transmitting mode was programmed.

After verification, all tests were carried out with the worst case test modes as shown below except radiated spurious emission below 1GHz and power line conducted emissions below 30MHz, which worst case was in normal link mode only.

Test Mode	ANT-1	ANT-2
Mode 2: AR9271L_IEEE 802.11b link mode		V
Mode 3: AR9271L_IEEE 802.11g link mode		V
Mode 4: AR9271L_IEEE 802.11n 2.4GHz 20MHz link mode		V
Mode 5: AR9271L_IEEE 802.11n 2.4GHz 40MHz link mode		V
Mode 7: AR9331_IEEE 802.11b link mode	V	
Mode 8: AR9331_IEEE 802.11g link mode	V	
Mode 9: AR9331_IEEE 802.11n 2.4GHz 20MHz link mode	V	
Mode 10: AR9331_IEEE 802.11n 2.4GHz 40MHz link mode	V	

Test Mode	Antenna Delivery	Test Channel	Data Rate 800GI (ns)
Mode 2: AR9271L_IIEEE 802.11b link mode	1TX / 1RX	1, 6, 11	1
Mode 3: AR9271L_IIEEE 802.11g link mode	1TX / 1RX	1, 6, 11	6
Mode 4: AR9271L_IIEEE 802.11n 2.4GHz 20MHz link mode	1TX / 1RX	1, 6, 11	6.5
Mode 5: AR9271L_IIEEE 802.11n 2.4GHz 40MHz link mode	1TX / 1RX	3, 6, 9	13.5
Mode 7: AR9331_IIEEE 802.11b link mode	1TX / 1RX	1, 6, 11	1
Mode 8: AR9331_IIEEE 802.11g link mode	1TX / 1RX	1, 6, 11	6
Mode 9: AR9331_IIEEE 802.11n 2.4GHz 20MHz link mode	1TX / 1RX	1, 6, 11	6.5
Mode 10: AR9331_IIEEE 802.11n 2.4GHz 40MHz link mode	1TX / 1RX	3, 6, 9	13.5

Duty cycle

Test Mode	Frequency (MHz)	on time (ms)	on+off time (ms)	Duty cycle	Duty Factor (dB)	1/T Minimum VBW (kHz)
Mode 2: AR9271L_IIEEE 802.11b link mode	2412.0	1.000	1.000	1.000	0.000	0.010
Mode 3: AR9271L_IIEEE 802.11g link mode	2412.0	1.000	1.000	1.000	0.000	0.010
Mode 4: AR9271L_IIEEE 802.11n 2.4GHz 20MHz link mode	2412.0	1.000	1.000	1.000	0.000	0.010
Mode 5: AR9271L_IIEEE 802.11n 2.4GHz 40MHz link mode	2422.0	1.000	1.000	1.000	0.000	0.010
Mode 7: AR9331_IIEEE 802.11b link mode	2412.0	1.000	1.000	1.000	0.000	0.010
Mode 8: AR9331_IIEEE 802.11g link mode	2412.0	2.040	2.080	0.981	0.084	0.010
Mode 9: AR9331_IIEEE 802.11n 2.4GHz 20MHz link mode	2412.0	1.910	1.940	0.985	0.068	0.010
Mode 10: AR9331_IIEEE 802.11n 2.4GHz 40MHz link mode	2422.0	0.950	0.960	0.990	0.045	0.010

Duty Cycle Graphs

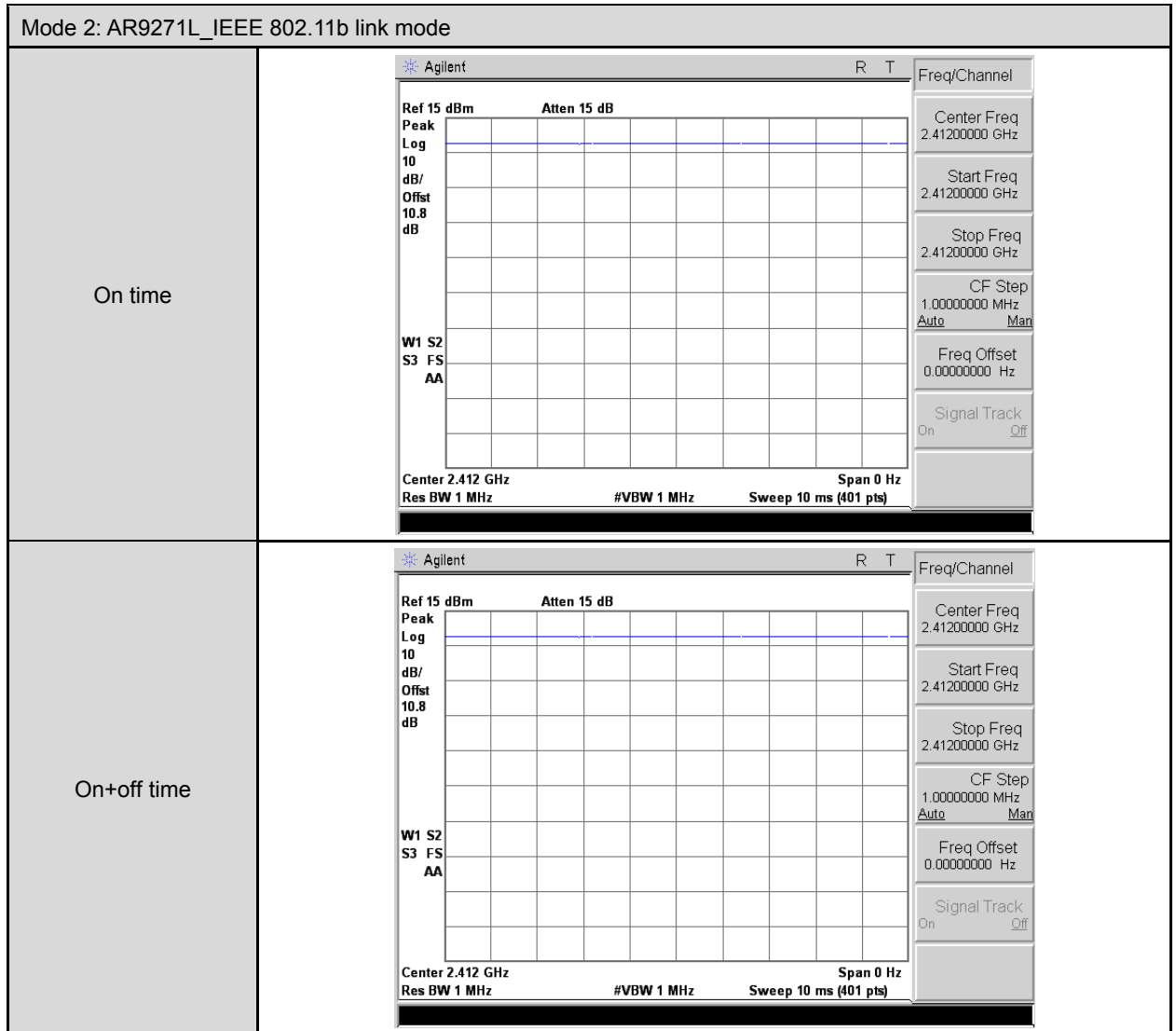

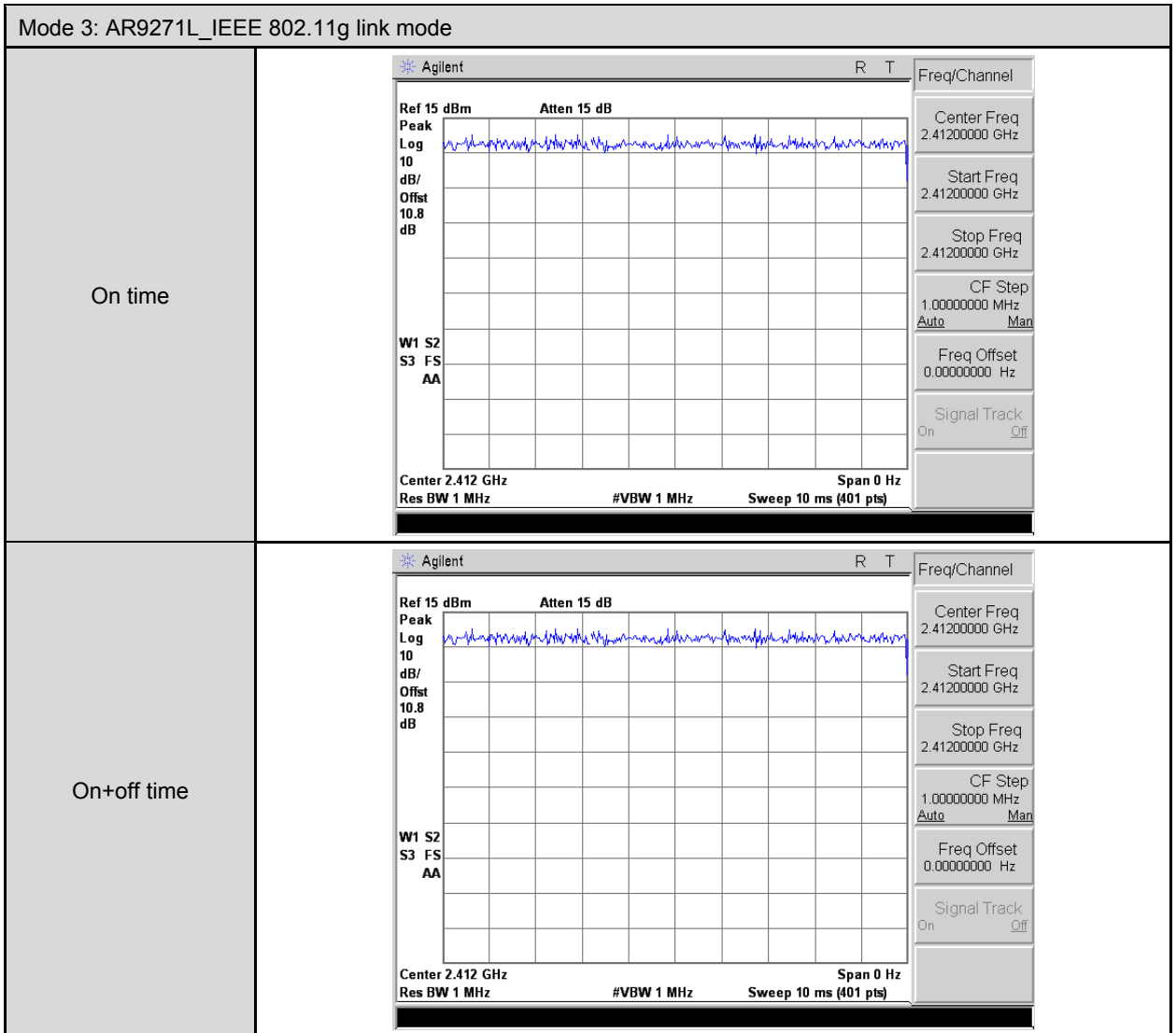

Mode 4: AR9271L_ IEEE 802.11n 2.4GHz 20MHz link mode

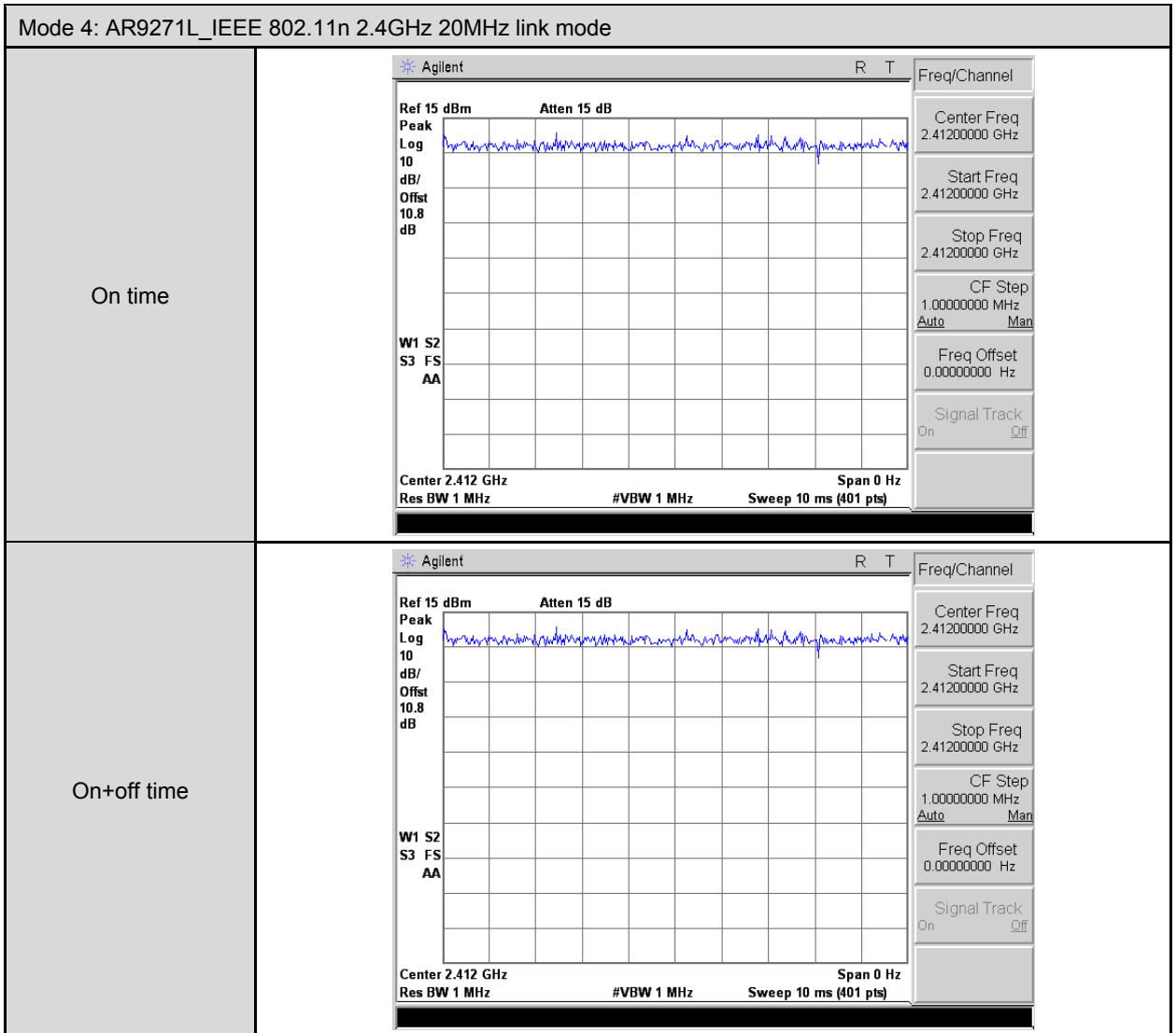

Mode 5: AR9271L_ IEEE 802.11n 2.4GHz 40MHz link mode

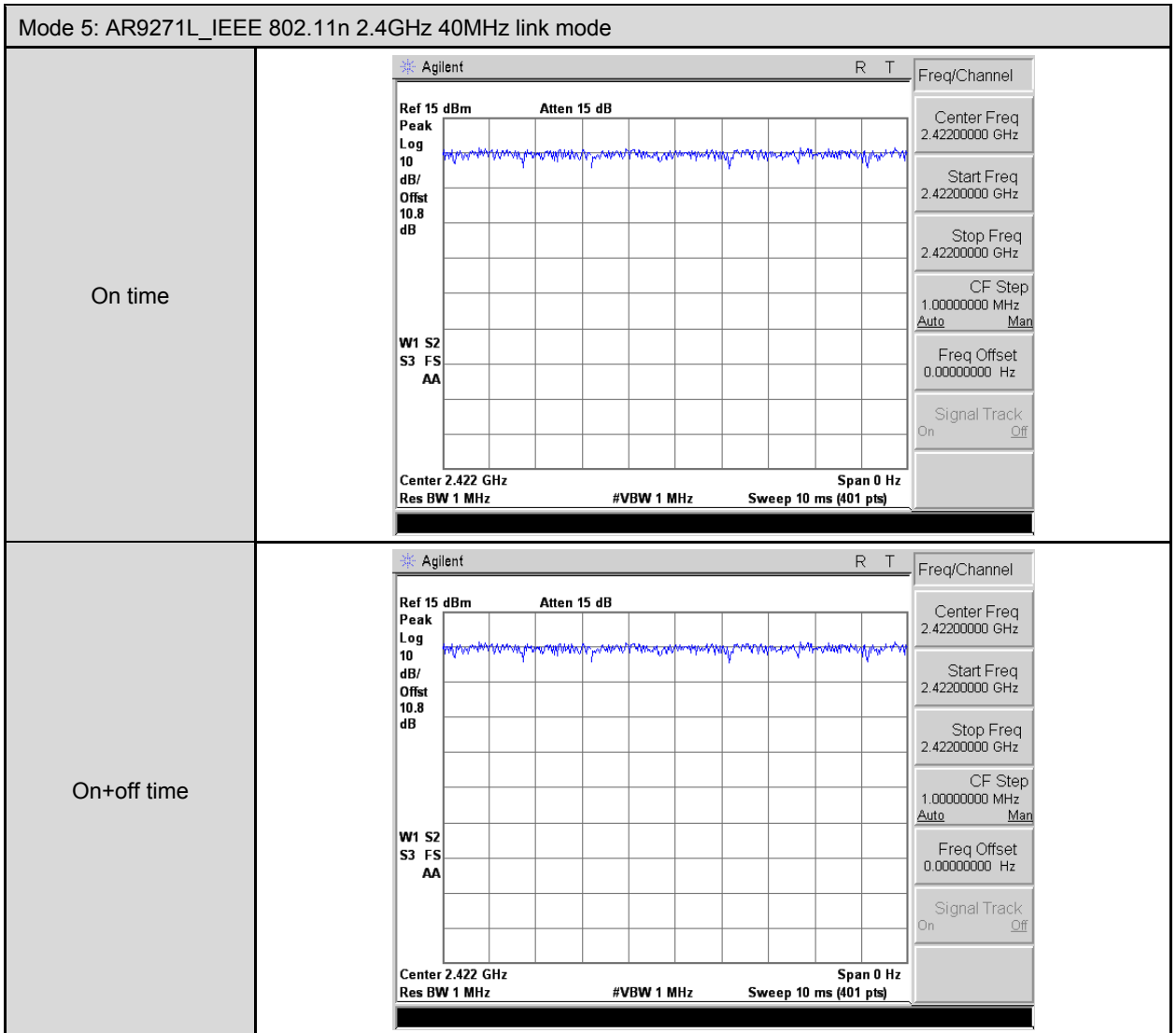

Mode 7: AR9331_ IEEE 802.11b link mode

<p>On time</p>	
<p>On+off time</p>	

Mode 8: AR9331_ IEEE 802.11g link mode

<p>On time</p>	
<p>On+off time</p>	

Mode 9: AR9331_ IEEE 802.11n 2.4GHz 20MHz link mode

<p>On time</p>	 <p>Agilent Spectrum Analyzer - Swept SA</p> <p>RF 100 dB AC SENSE INT ALIGN AUTO 05:51:31 PM Oct 30, 2015</p> <p>TRIG: Free Run Atten: 14 dB Avg Type: Log-Pwr</p> <p>Ref Offset 11 dB Ref 15.00 dBm ΔMkr1 1.910 ms 1.08 dB</p> <p>Center 2.412056635 GHz Res BW 1.0 MHz #VBW 1.0 MHz Sweep 10.00 ms (1001 pts)</p> <p>Frequency: Auto Tune Center Freq: 2.412056635 GHz Start Freq: 2.412056635 GHz Stop Freq: 2.412056635 GHz CF Step: 1.000000 MHz (Auto/Man) Freq Offset: 0 Hz</p>
<p>On+off time</p>	 <p>Agilent Spectrum Analyzer - Swept SA</p> <p>RF 100 dB AC SENSE INT ALIGN AUTO 05:52:03 PM Oct 30, 2015</p> <p>TRIG: Free Run Atten: 14 dB Avg Type: Log-Pwr</p> <p>Ref Offset 11 dB Ref 15.00 dBm ΔMkr1 1.940 ms -0.02 dB</p> <p>Center 2.412056635 GHz Res BW 1.0 MHz #VBW 1.0 MHz Sweep 10.00 ms (1001 pts)</p> <p>Frequency: Auto Tune Center Freq: 2.412056635 GHz Start Freq: 2.412056635 GHz Stop Freq: 2.412056635 GHz CF Step: 1.000000 MHz (Auto/Man) Freq Offset: 0 Hz</p>

Mode 10: AR9331_ IEEE 802.11n 2.4GHz 40MHz link mode	
On time	
On+off time	

3.2. EUT Exercise Software

- | |
|--|
| 1. Setup the EUT shown on 3.3. |
| 2. Turn on the power of all equipment. |
| 3. Turn on Wi-Fi function. |
| 4. EUT run test program. |

3.3. Configuration of Test System Details

Conducted Emissions

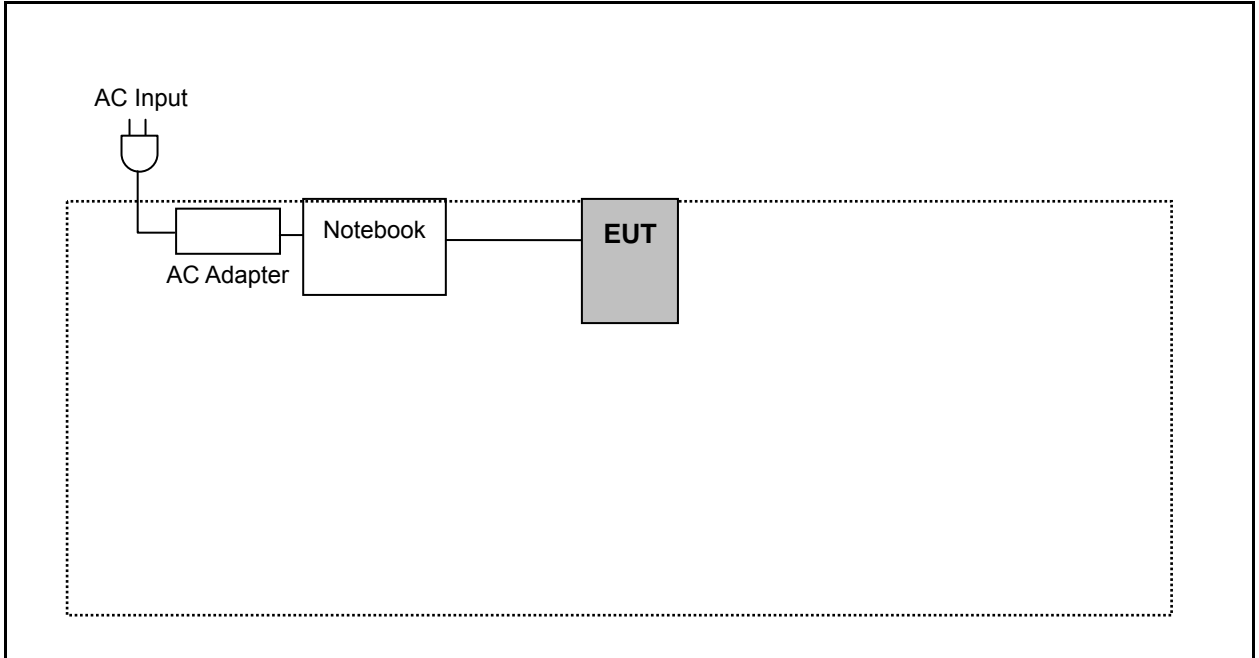

Radiated Emissions

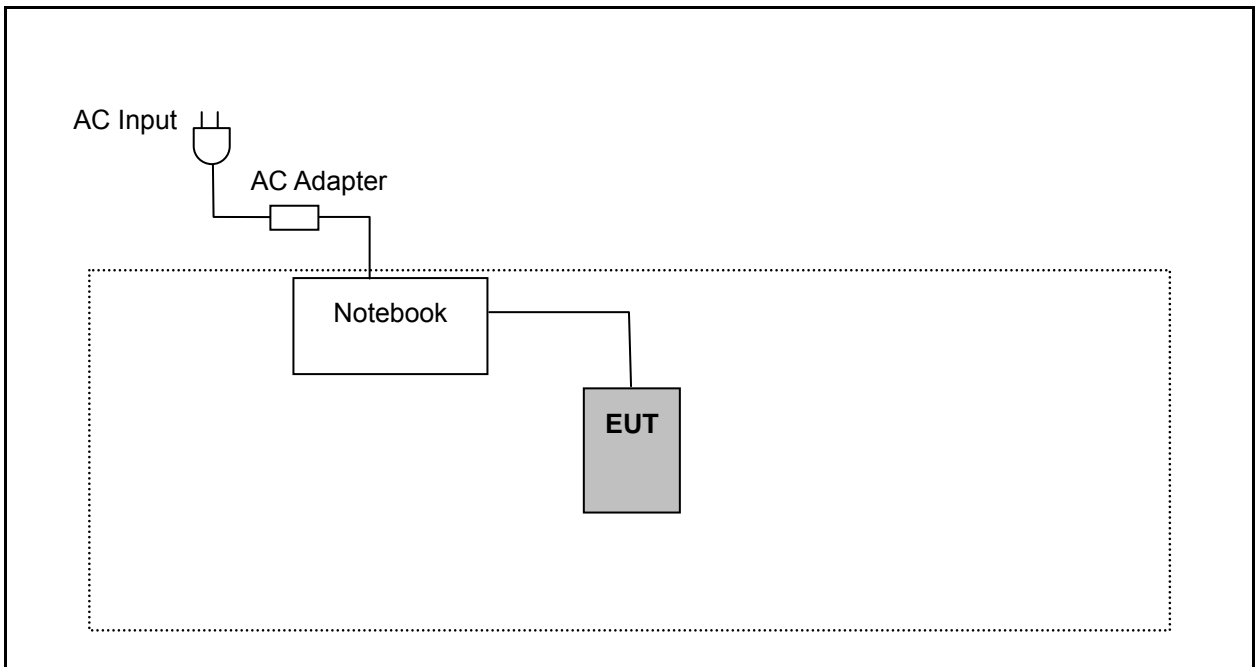

3.4. Test Site Environment

Items	Required (IEC 60068-1)	Actual
Temperature (°C)	15-35	26
Humidity (%RH)	25-75	60
Barometric pressure (mbar)	860-1060	950

4 Conducted Emission Measurement

4.1. Limit

Frequency (MHz)	Quasi-peak	Average
0.15 - 0.5	66 to 56	56 to 46
0.50 - 5.0	56	46
5.0 - 30.0	60	50

4.2. Test Instruments

Describe	Manufacturer	Model Number	Serial Number	Cal. Date	Remark
Test Receiver	R&S	ESCI	100367	06/25/2015	(1)
LISN	R&S	ENV216	101040	03/10/2015	(1)
LISN	R&S	ENV216	101041	03/06/2015	(1)
RF Cable	Woken	00100D1380194M	TE-02-02	06/26/2015	(1)
Test Site	ATL	TE02	TE02	N.C.R.	-----

Remark: (1) Calibration period 1 year. (2) Calibration period 2 years. (3) Calibration period 3 years.

Note: N.C.R. = No Calibration Request.

4.3. Test Setup

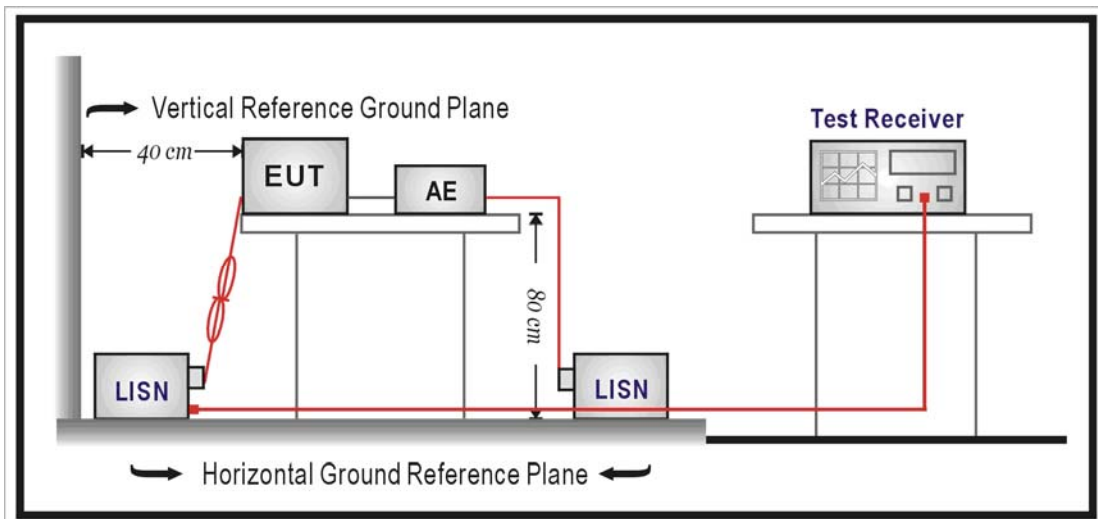

4.4. Test Procedure

The power line conducted emission measurements were performed in a shielded enclosure. The EUT was assembled on a wooden table which is 80 centimeters high, was placed 40 centimeters from the back wall and at least 1 meter from the sidewall.

Power was fed to the EUT from the public utility power grid through a line filter and EMCO Model 3162/2 SH Line Impedance Stabilization Networks (LISN). The LISN housing, measuring instrumentation case, ground plane, etc., were electrically bonded together at the same RF potential. The Spectrum analyzer was connected to the AC line through an isolation transformer. The 50-ohm output of the LISN was connected to the spectrum analyzer directly. Conducted emission levels were in the CISPR quasi-peak detection mode. The analyzer's 6 dB bandwidth was set to 9 KHz. No post-detector video filter was used.

The spectrum was scanned from 150 KHz to 30 MHz. The physical arrangement of the test system and associated cabling was varied (within the scope of arrangements likely to be encountered in actual use) to determine the effect on the unit's emanations in amplitude and frequency. All spurious emission frequencies were observed. The highest emission amplitudes relative to the appropriate limit were measured and have been recorded in paragraph 4.1.

4.5. Test Result

Standard:	FCC Part 15C	Line:	L1
Test item:	Conducted Emission	Power:	AC 120V/60Hz
Model Number:	NANO	Temp.(°C)/Hum.(%RH):	26(°C)/60%RH
Mode:	Mode 1	Date:	10/30/2015
		Test By:	Eric Ou Yang
Description:			

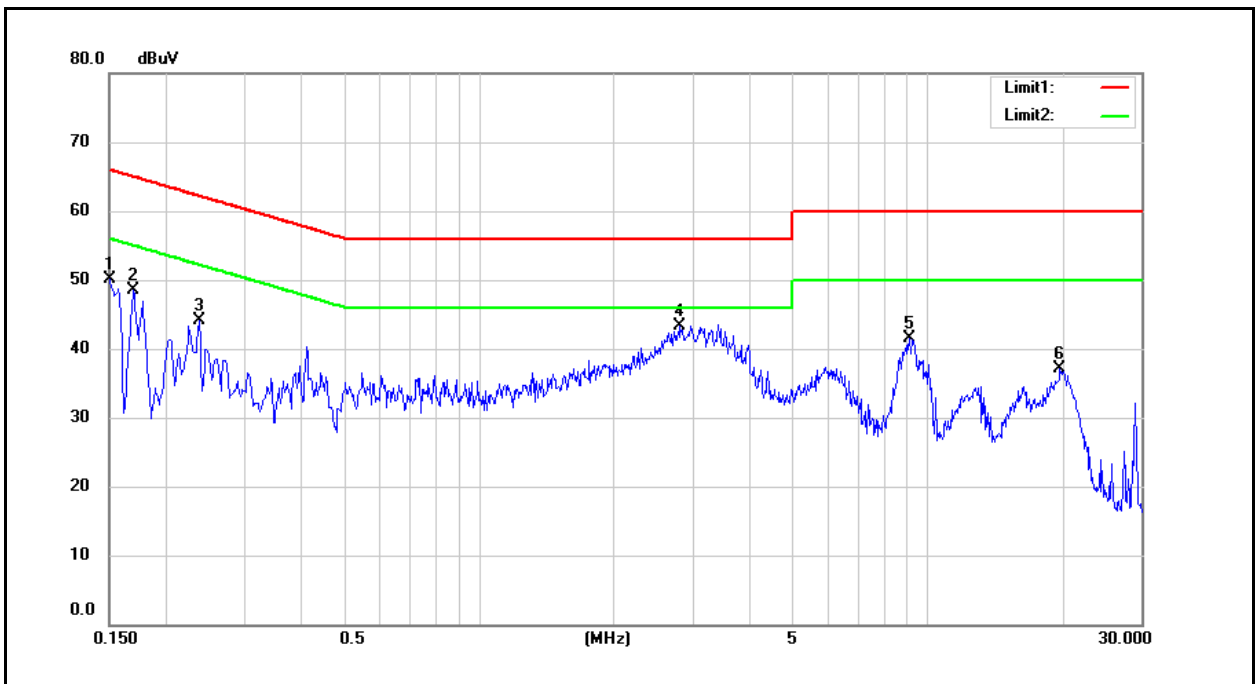

No.	Frequency (MHz)	QP reading (dBuV)	AVG reading (dBuV)	Correction factor (dB)	QP result (dBuV)	AVG result (dBuV)	QP limit (dBuV)	AVG limit (dBuV)	QP margin (dB)	AVG margin (dB)	Remark
1	0.1500	35.91	20.03	9.69	45.60	29.72	66.00	56.00	-20.40	-26.28	Pass
2	0.1700	32.06	15.91	9.69	41.75	25.60	64.96	54.96	-23.21	-29.36	Pass
3	0.2380	26.64	17.89	9.68	36.32	27.57	62.17	52.17	-25.85	-24.60	Pass
4	2.8100	28.94	23.87	9.79	38.73	33.66	56.00	46.00	-17.27	-12.34	Pass
5	9.1460	25.88	19.98	9.96	35.84	29.94	60.00	50.00	-24.16	-20.06	Pass
6	19.8180	21.15	15.99	10.05	31.20	26.04	60.00	50.00	-28.80	-23.96	Pass

Note: 1. Result (dBuV) = Correction factor (dB) + Reading(dBuV).

2. Correction factor (dB) = Cable loss (dB) + L.I.S.N. factor (dB).

Standard:	FCC Part 15C	Line:	N
Test item:	Conducted Emission	Power:	AC 120V/60Hz
Model Number:	NANO	Temp.(°C)/Hum.(%RH):	26(°C)/60%RH
Mode:	Mode 1	Date:	10/30/2015
		Test By:	Eric Ou Yang
Description:			

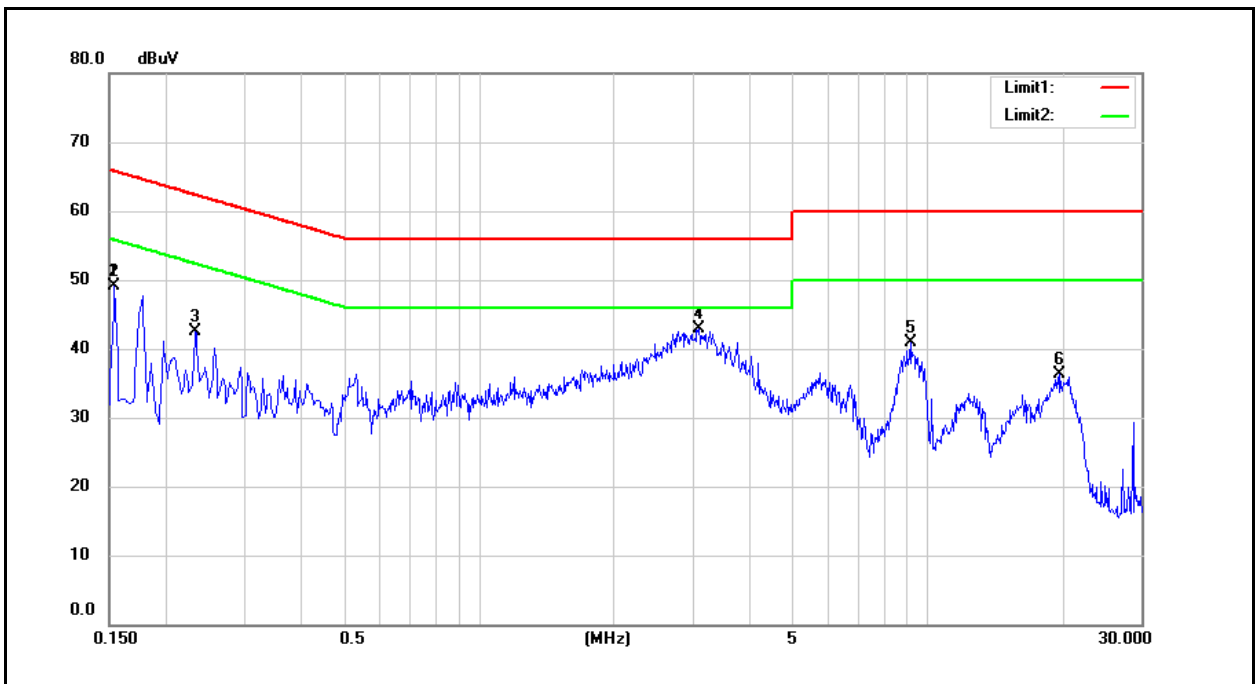

No.	Frequency (MHz)	QP reading (dBuV)	AVG reading (dBuV)	Correction factor (dB)	QP result (dBuV)	AVG result (dBuV)	QP limit (dBuV)	AVG limit (dBuV)	QP margin (dB)	AVG margin (dB)	Remark
1	0.1540	35.31	18.29	9.66	44.97	27.95	65.78	55.78	-20.81	-27.83	Pass
2	0.1540	39.43	39.43	9.66	49.09	49.09	65.78	55.78	-16.69	-6.69	Pass
3	0.2340	26.83	17.47	9.65	36.48	27.12	62.31	52.31	-25.83	-25.19	Pass
4	3.0980	28.81	23.48	9.78	38.59	33.26	56.00	46.00	-17.41	-12.74	Pass
5	9.1820	26.32	20.06	9.96	36.28	30.02	60.00	50.00	-23.72	-19.98	Pass
6	19.7420	20.72	15.34	10.16	30.88	25.50	60.00	50.00	-29.12	-24.50	Pass

Note: 1. Result (dBuV) = Correction factor (dB) + Reading(dBuV).

2. Correction factor (dB) = Cable loss (dB) + L.I.S.N. factor (dB).

Standard:	FCC Part 15C	Line:	L1
Test item:	Conducted Emission	Power:	AC 120V/60Hz
Model Number:	NANO	Temp.(°C)/Hum.(%RH):	26(°C)/60%RH
Mode:	Mode 6	Date:	10/30/2015
		Test By:	Eric Ou Yang
Description:			

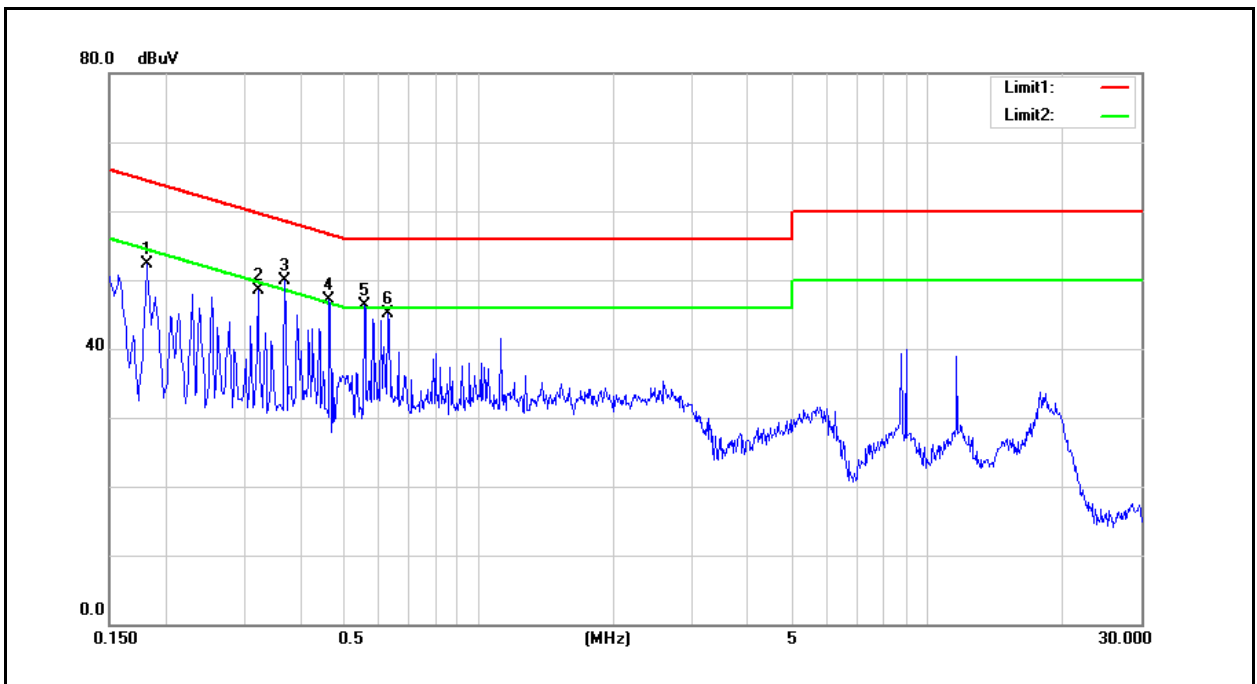

No.	Frequency (MHz)	QP reading (dBuV)	AVG reading (dBuV)	Correction factor (dB)	QP result (dBuV)	AVG result (dBuV)	QP limit (dBuV)	AVG limit (dBuV)	QP margin (dB)	AVG margin (dB)	Remark
1	0.1820	42.03	19.23	9.68	51.71	28.91	64.39	54.39	-12.68	-25.48	Pass
2	0.3220	43.08	16.92	9.69	52.77	26.61	59.66	49.66	-6.89	-23.05	Pass
3	0.3700	40.50	16.23	9.69	50.19	25.92	58.50	48.50	-8.31	-22.58	Pass
4	0.4660	22.77	13.00	9.70	32.47	22.70	56.58	46.58	-24.11	-23.88	Pass
5	0.5580	39.17	14.45	9.70	48.87	24.15	56.00	46.00	-7.13	-21.85	Pass
6	0.6300	39.53	16.93	9.70	49.23	26.63	56.00	46.00	-6.77	-19.37	Pass

Note: 1. Result (dBuV) = Correction factor (dB) + Reading(dBuV).

2. Correction factor (dB) = Cable loss (dB) + L.I.S.N. factor (dB).

Standard:	FCC Part 15C	Line:	N
Test item:	Conducted Emission	Power:	AC 120V/60Hz
Model Number:	NANO	Temp.(°C)/Hum.(%RH):	26(°C)/60%RH
Mode:	Mode 6	Date:	10/30/2015
		Test By:	Eric Ou Yang
Description:			

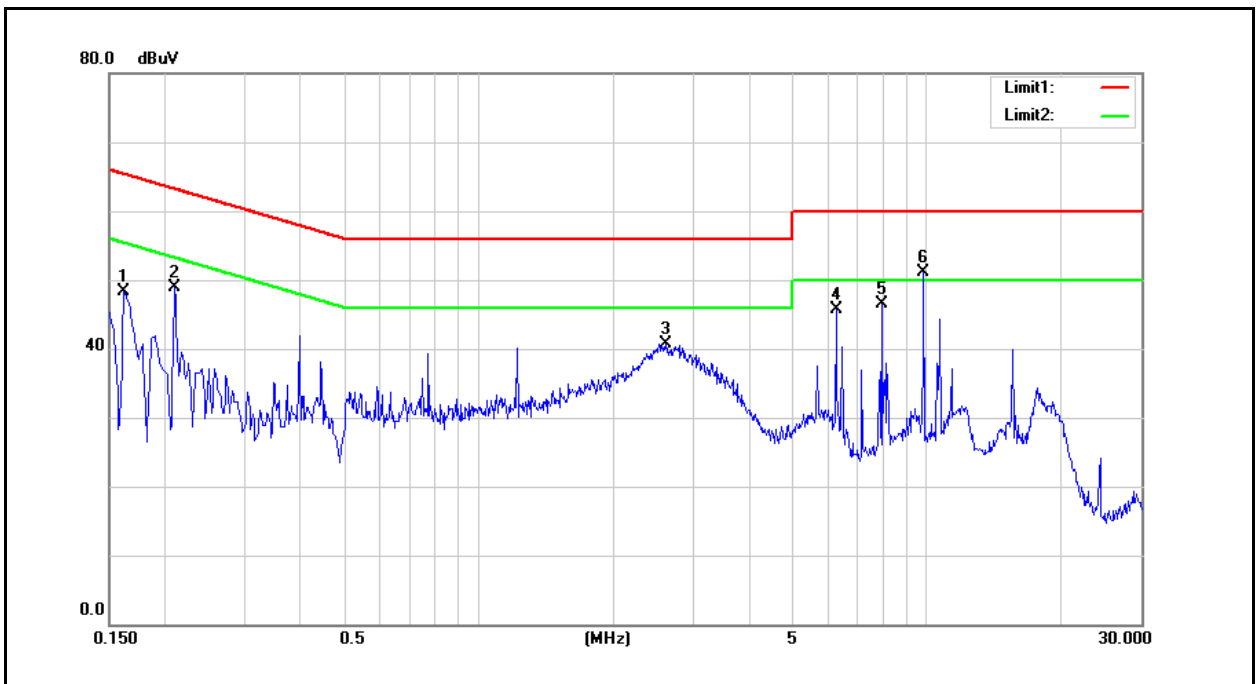

No.	Frequency (MHz)	QP reading (dBuV)	AVG reading (dBuV)	Correction factor (dB)	QP result (dBuV)	AVG result (dBuV)	QP limit (dBuV)	AVG limit (dBuV)	QP margin (dB)	AVG margin (dB)	Remark
1	0.1620	45.02	21.36	9.66	54.68	31.02	65.36	55.36	-10.68	-24.34	Pass
2	0.2100	41.27	22.79	9.65	50.92	32.44	63.21	53.21	-12.29	-20.77	Pass
3	2.6100	27.95	23.58	9.77	37.72	33.35	56.00	46.00	-18.28	-12.65	Pass
4	6.2660	15.93	11.14	9.88	25.81	21.02	60.00	50.00	-34.19	-28.98	Pass
5	7.9060	12.83	8.28	9.92	22.75	18.20	60.00	50.00	-37.25	-31.80	Pass
6	9.8220	12.63	7.21	9.98	22.61	17.19	60.00	50.00	-37.39	-32.81	Pass

Note: 1. Result (dBuV) = Correction factor (dB) + Reading(dBuV).

2. Correction factor (dB) = Cable loss (dB) + L.I.S.N. factor (dB).

5 Radiated Emission Measurement

5.1. Limit

According to §15.209(a), except as provided elsewhere in this subpart, the emissions from an intentional radiator shall not exceed the field strength levels specified in the following table:

Frequency (MHz)	Field Strength ($\mu\text{V}/\text{m}$ at meter)	Measurement Distance (meters)
0.009 – 0.490	2400 / F (kHz)	300
0.490 – 1.705	24000 / F (kHz)	30
1.705 – 30.0	30	30
30 - 88	100**	3
88-216	150**	3
216-960	200**	3
Above 960	500	3

** Except as provided in paragraph (g), fundamental emissions from intentional radiators operating under this Section shall not be located in the frequency bands 54-72 MHz, 76-88 MHz, 174-216 MHz or 470-806 MHz. However, operation within these frequency bands is permitted under other sections of this Part, e.g., Sections 15.231 and 15.241.

5.2. Test Instruments

3 Meter Chamber (966-A)					
Equipment	Manufacturer	Model Number	Serial Number	Cal. Date	Remark
RF Pre-selector	Agilent	N9039A	MY46520256	01/06/2015	(1)
Spectrum Analyzer	Agilent	E4446A	MY46180578	01/06/2015	(1)
Pre Amplifier	Agilent	8449B	3008A02237	02/24/2015	(1)
Pre Amplifier	Agilent	8447D	2944A10961	02/24/2015	(1)
Broadband Antenna (30MHz~1GHz)	SCHWARZBECK MESS-ELEKTRONIK	VULB9163	9163-270	08/11/2015	(1)
Horn Antenna (1~18GHz)	SCHWARZBECK MESS-ELEKTRONIK	BBHA9120D	9120D-550	06/12/2015	(1)
Horn Antenna (18~40GHz)	SCHWARZBECK MESS-ELEKTRONIK	BBHA9170	9170-320	07/06/2015	(1)
Loop Antenna	COM-POWER CORPORATION	AL-130	121014	02/02/2015	(1)
Microwave Cable	EMCI	EMC-104-SM-S M-14000	140202	02/24/2015	(1)
Microwave Cable	EMCI	EMC104-SM-S M-600	140301	02/24/2015	(1)
Test Site	ATL	TE01	888001	08/27/2015	(1)

Remark: (1) Calibration period 1 year. (2) Calibration period 2 years. (3) Calibration period 3 years.

Note: N.C.R. = No Calibration Request.

5.3. Setup

9kHz ~ 30MHz

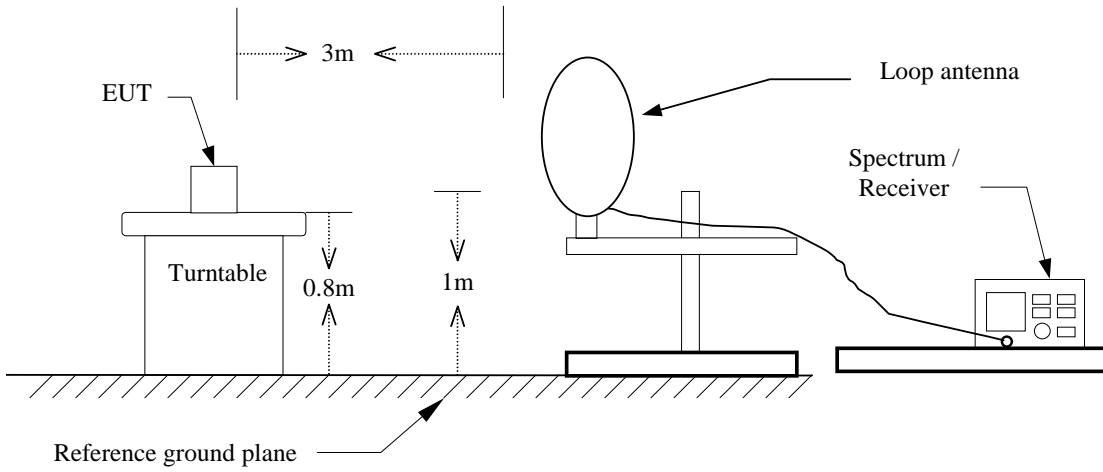

Below 1GHz

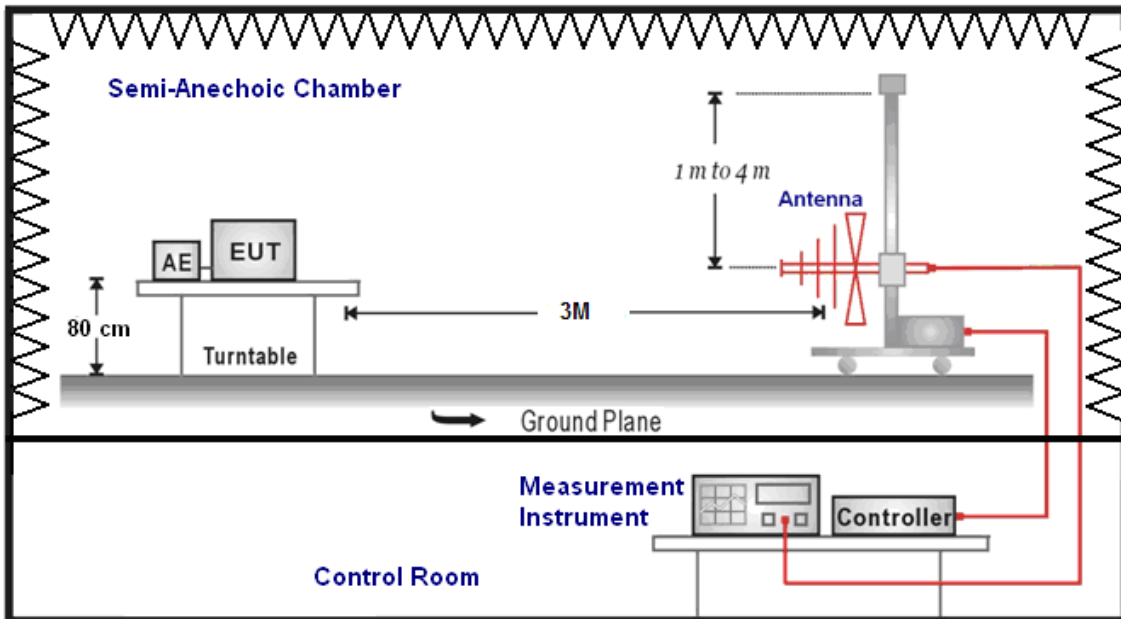

Above 1GHz

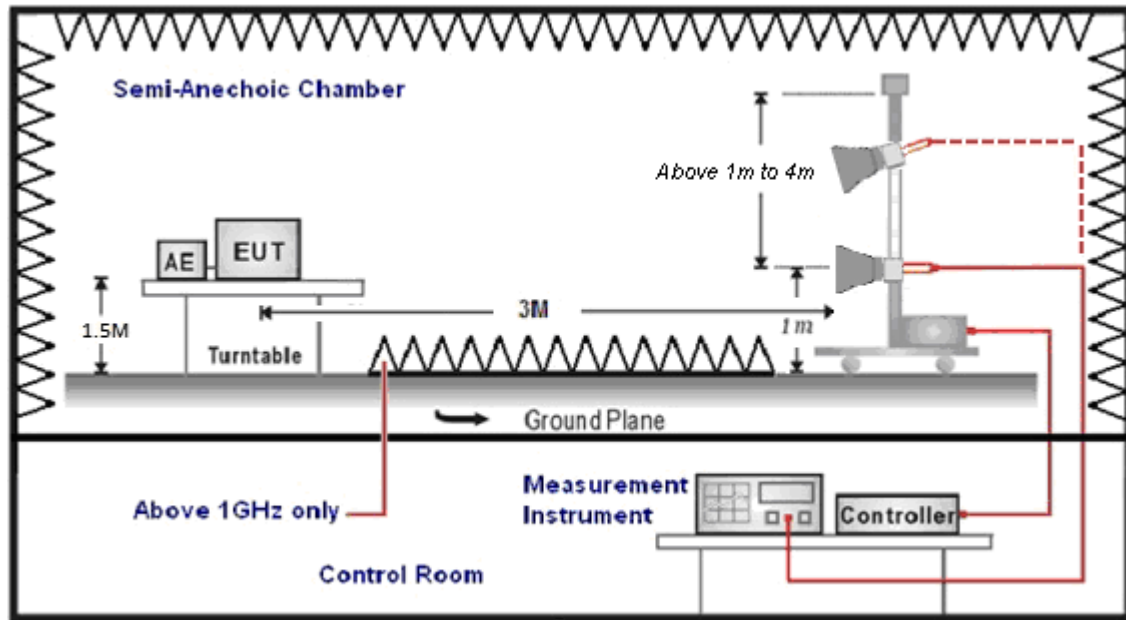

5.4. Test Procedure

Final radiation measurements were made on a three-meter, Semi Anechoic Chamber. The EUT system was placed on a nonconductive turntable which is 0.8 or 1.5 meters height (below 1GHz use 0.8m turntable / above 1GHz use 1.5m turntable), top surface 1.0 x 1.5 meter. The spectrum was examined from 250 MHz to 2.5 GHz in order to cover the whole spectrum below 10th harmonic which could generate from the EUT. During the test, EUT was set to transmit continuously & Measurements spectrum range from 9 kHz to 26.5 GHz is investigated.

For measurements below 1 GHz the resolution bandwidth is set to 100 kHz for peak detection measurements or 120 kHz for quasi-peak detection measurements. Peak detection is used unless otherwise noted as quasi-peak.

For measurements above 1 GHz the resolution bandwidth is set to 1 MHz, and then the video bandwidth is set to 1 MHz for peak measurements and 10 Hz for average measurements when Duty cycle >0.98 / 1/T for average measurements when Duty cycle <0.98. A nonconductive material surrounded the EUT to supporting the EUT for standing on three orthogonal planes. At each condition, the EUT was rotated 360 degrees, and the antenna was raised and lowered from one to four meters to find the maximum emission levels. Measurements were taken using both horizontal and vertical antenna polarization.

SCHWARZBECK MESS-ELEKTRONIK Biconilog Antenna (mode VULB9163) at 3 Meter and the SCHWARZBECK Double Ridged Guide Antenna (model BBHA9120D&9170) was used in frequencies 1 –26.5 GHz at a distance of 3 meter. The antenna at an angle toward the source of the emission. All test results were extrapolated to equivalent signal at 3 meters utilizing an inverse linear distance extrapolation Factor (20dB/decade).

For testing above 1GHz, the emission level of the EUT in peak mode was 20dB lower than average limit (that means the emission level in peak mode also complies with the limit in average mode), then testing will be stopped and peak values of EUT will be reported, otherwise, the emissions will be measured in average mode again and reported.

Appropriate preamplifiers were used for improving sensitivity and precautions were taken to avoid overloading or desensitizing the spectrum analyzer. No post – detector video filters were used in the test.

The spectrum analyzer's 6 dB bandwidth was set to 1 MHz, and the analyzer was operated in the peak detection mode, for frequencies both below and up 1 GHz. The average levels were obtained by subtracting the duty cycle correction factor from the peak readings.

The following procedures were used to convert the emission levels measured in decibels referenced to 1 microvolt (dBuV) into field intensity in micro volts pre meter (uV/m).

The actual field intensity in decibels referenced to 1 microvolt in to field intensity in micro volts per meter (dBuV/m).

The actual field intensity in referenced to 1 microvolt per meter (dBuV/m) is determined by algebraically adding the measured reading in dBuV, the antenna factor (dB), and cable loss (dB) and Subtracting the gain of preamplifier (dB) is auto calculate in spectrum analyzer.

(1) $\text{Amplitude (dBuV/m)} = \text{FI (dBuV)} + \text{AF (dBuV)} + \text{CL (dBuV)} - \text{Gain (dB)}$

FI= Reading of the field intensity.

AF= Antenna factor.

CL= Cable loss.

P.S Amplitude is auto calculate in spectrum analyzer.

(2) $\text{Actual Amplitude (dBuV/m)} = \text{Amplitude (dBuV)} - \text{Dis(dB)}$

The FCC specified emission limits were calculated according the EUT operating frequency and by following linear interpolation equations:

(a) For fundamental frequency : Transmitter Output < +30dBm

(b) For spurious frequency : Spurious emission limits = fundamental emission limit /10

Data of measurement within this frequency range without mark in the table above means the reading of emissions are attenuated more than 20dB below the permissible limits or the field strength is too small to be measured.

5.5. Test Result

Below 1GHz

Standard:	FCC Part 15C	Test Distance:	3m
Test item:	Radiated Emission	Power:	AC 120V/60Hz
Model Number:	NANO	Temp.(°C)/Hum.(%RH):	26(°C)/60%RH
Mode:	Mode 1	Date:	10/30/2015
		Test By:	Eric Ou Yang

Frequency (MHz)	Reading (dBuV)	Correct Factor (dB/m)	Result (dBuV/m)	Limit (dBuV/m)	Margin (dB)	Remark	Ant.Polar. H / V
200.0000	58.55	-17.74	40.81	43.50	-2.69	QP	H
244.5000	52.75	-16.24	36.51	46.00	-9.49	QP	H
400.0000	52.79	-11.79	41.00	46.00	-5.00	QP	H
600.0000	46.66	-7.37	39.29	46.00	-6.71	QP	H
637.5000	36.89	-6.96	29.93	46.00	-16.07	QP	H
796.5000	38.18	-4.74	33.44	46.00	-12.56	QP	H
200.0000	54.24	-17.74	36.50	43.50	-7.00	QP	V
300.5000	50.53	-14.33	36.20	46.00	-9.80	QP	V
400.0000	51.26	-11.79	39.47	46.00	-6.53	QP	V
530.0000	44.65	-9.06	35.59	46.00	-10.41	QP	V
600.0000	43.80	-7.37	36.43	46.00	-9.57	QP	V
799.5000	43.03	-4.68	38.35	46.00	-7.65	QP	V

Note: No emission found between lowest internal used/generated frequency to 30MHz (9kHz~30MHz).

Above 1GHz

Standard:	FCC Part 15C			Test Distance:	3m		
Test item:	Radiated Emission			Power:	AC 120V/60Hz		
Model Number:	NANO			Temp.(°C)/Hum.(%RH):	26(°C)/60%RH		
Mode:	Mode 2			Date:	10/29/2015		
Frequency:	2412MHz			Test By:	Eric Ou Yang		
Frequency (MHz)	Reading (dBuV)	Correct Factor (dB/m)	Result (dBuV/m)	Limit (dBuV/m)	Margin (dB)	Remark	Ant.Polar. H / V
3058.000	38.51	7.22	45.73	74.00	-28.27	peak	H
4824.000	38.74	10.70	49.44	74.00	-24.56	peak	H
6712.000	35.32	14.89	50.21	74.00	-23.79	peak	H
3219.000	43.62	7.35	50.97	74.00	-23.03	peak	V
4824.000	43.24	10.70	53.94	74.00	-20.06	peak	V
6663.000	34.98	14.83	49.81	74.00	-24.19	peak	V

Standard:	FCC Part 15C			Test Distance:	3m		
Test item:	Radiated Emission			Power:	AC 120V/60Hz		
Model Number:	NANO			Temp.(°C)/Hum.(%RH):	26(°C)/60%RH		
Mode:	Mode 2			Date:	10/29/2015		
Frequency:	2437MHz			Test By:	Eric Ou Yang		
Frequency (MHz)	Reading (dBuV)	Correct Factor (dB/m)	Result (dBuV/m)	Limit (dBuV/m)	Margin (dB)	Remark	Ant.Polar. H / V
3247.000	40.18	7.37	47.55	74.00	-26.45	peak	H
4874.000	37.11	10.79	47.90	74.00	-26.10	peak	H
6824.000	35.07	15.01	50.08	74.00	-23.92	peak	H
3247.000	42.72	7.37	50.09	74.00	-23.91	peak	V
4874.000	40.88	10.79	51.67	74.00	-22.33	peak	V
6684.000	35.58	14.86	50.44	74.00	-23.56	peak	V

Standard:	FCC Part 15C			Test Distance:	3m		
Test item:	Radiated Emission			Power:	AC 120V/60Hz		
Model Number:	NANO			Temp.(°C)/Hum.(%RH):	26(°C)/60%RH		
Mode:	Mode 2			Date:	10/29/2015		
Frequency:	2462MHz			Test By:	Eric Ou Yang		
Frequency (MHz)	Reading (dBuV)	Correct Factor (dB/m)	Result (dBuV/m)	Limit (dBuV/m)	Margin (dB)	Remark	Ant.Polar. H / V
3058.000	37.84	7.22	45.06	74.00	-28.94	peak	H
4924.000	37.46	10.88	48.34	74.00	-25.66	peak	H
6691.000	35.64	14.87	50.51	74.00	-23.49	peak	H
3128.000	38.03	7.27	45.30	74.00	-28.70	peak	V
4924.000	40.89	10.88	51.77	74.00	-22.23	peak	V
6677.000	34.69	14.85	49.54	74.00	-24.46	peak	V

Standard:	FCC Part 15C			Test Distance:	3m		
Test item:	Radiated Emission			Power:	AC 120V/60Hz		
Model Number:	NANO			Temp.(°C)/Hum.(%RH):	26(°C)/60%RH		
Mode:	Mode 3			Date:	10/29/2015		
Frequency:	2412MHz			Test By:	Eric Ou Yang		
Frequency (MHz)	Reading (dBuV)	Correct Factor (dB/m)	Result (dBuV/m)	Limit (dBuV/m)	Margin (dB)	Remark	Ant.Polar. H / V
3072.000	38.52	7.23	45.75	74.00	-28.25	peak	H
4824.000	38.24	10.70	48.94	74.00	-25.06	peak	H
6733.000	35.14	14.92	50.06	74.00	-23.94	peak	H
3114.000	37.13	7.27	44.40	74.00	-29.60	peak	V
4824.000	44.25	10.70	54.95	74.00	-19.05	peak	V
4824.000	33.09	10.70	43.79	54.00	-10.21	AVG	V
6684.000	35.35	14.86	50.21	74.00	-23.79	peak	V

Standard:	FCC Part 15C			Test Distance:	3m		
Test item:	Radiated Emission			Power:	AC 120V/60Hz		
Model Number:	NANO			Temp.(°C)/Hum.(%RH):	26(°C)/60%RH		
Mode:	Mode 3			Date:	10/29/2015		
Frequency:	2437MHz			Test By:	Eric Ou Yang		
Frequency (MHz)	Reading (dBuV)	Correct Factor (dB/m)	Result (dBuV/m)	Limit (dBuV/m)	Margin (dB)	Remark	Ant.Polar. H / V
3142.000	37.38	7.28	44.66	74.00	-29.34	peak	H
4874.000	37.19	10.79	47.98	74.00	-26.02	peak	H
6628.000	34.81	14.80	49.61	74.00	-24.39	peak	H
3051.000	37.89	7.22	45.11	74.00	-28.89	peak	V
4874.000	42.87	10.79	53.66	74.00	-20.34	peak	V
4874.000	32.18	10.79	42.97	54.00	-11.03	AVG	V
6775.000	35.34	14.97	50.31	74.00	-23.69	peak	V

Standard:	FCC Part 15C			Test Distance:	3m		
Test item:	Radiated Emission			Power:	AC 120V/60Hz		
Model Number:	NANO			Temp.(°C)/Hum.(%RH):	26(°C)/60%RH		
Mode:	Mode 3			Date:	10/29/2015		
Frequency:	2462MHz			Test By:	Eric Ou Yang		
Frequency (MHz)	Reading (dBuV)	Correct Factor (dB/m)	Result (dBuV/m)	Limit (dBuV/m)	Margin (dB)	Remark	Ant.Polar. H / V
3142.000	37.52	7.28	44.80	74.00	-29.20	peak	H
4924.000	36.65	10.88	47.53	74.00	-26.47	peak	H
6740.000	34.48	14.92	49.40	74.00	-24.60	peak	H
4874.000	32.18	10.79	42.97	54.00	-11.03	AVG	V
6775.000	35.34	14.97	50.31	74.00	-23.69	peak	V
4874.000	32.18	10.79	42.97	54.00	-11.03	AVG	V
6775.000	35.34	14.97	50.31	74.00	-23.69	peak	V

Standard:	FCC Part 15C			Test Distance:	3m		
Test item:	Radiated Emission			Power:	AC 120V/60Hz		
Model Number:	NANO			Temp.(°C)/Hum.(%RH):	26(°C)/60%RH		
Mode:	Mode 4			Date:	10/29/2015		
Frequency:	2412MHz			Test By:	Eric Ou Yang		
Frequency (MHz)	Reading (dBuV)	Correct Factor (dB/m)	Result (dBuV/m)	Limit (dBuV/m)	Margin (dB)	Remark	Ant.Polar. H / V
3121.000	37.32	7.27	44.59	74.00	-29.41	peak	H
4824.000	39.21	10.70	49.91	74.00	-24.09	peak	H
6712.000	34.75	14.89	49.64	74.00	-24.36	peak	H
3002.000	37.54	7.17	44.71	74.00	-29.29	peak	V
4824.000	42.60	10.70	53.30	74.00	-20.70	peak	V
4824.000	32.03	10.70	42.73	54.00	-11.27	AVG	V
6733.000	35.21	14.92	50.13	74.00	-23.87	peak	V

Standard:	FCC Part 15C			Test Distance:	3m		
Test item:	Radiated Emission			Power:	AC 120V/60Hz		
Model Number:	NANO			Temp.(°C)/Hum.(%RH):	26(°C)/60%RH		
Mode:	Mode 4			Date:	10/29/2015		
Frequency:	2437MHz			Test By:	Eric Ou Yang		
Frequency (MHz)	Reading (dBuV)	Correct Factor (dB/m)	Result (dBuV/m)	Limit (dBuV/m)	Margin (dB)	Remark	Ant.Polar. H / V
3121.000	37.82	7.27	45.09	74.00	-28.91	peak	H
4874.000	37.82	10.79	48.61	74.00	-25.39	peak	H
6691.000	35.41	14.87	50.28	74.00	-23.72	peak	H
3030.000	37.96	7.19	45.15	74.00	-28.85	peak	V
4874.000	41.12	10.79	51.91	74.00	-22.09	peak	V
6747.000	35.27	14.93	50.20	74.00	-23.80	peak	V

Standard:	FCC Part 15C		Test Distance:	3m			
Test item:	Radiated Emission		Power:	AC 120V/60Hz			
Model Number:	NANO		Temp.(°C)/Hum.(%RH):	26(°C)/60%RH			
Mode:	Mode 4		Date:	10/29/2015			
Frequency:	2462MHz		Test By:	Eric Ou Yang			
Frequency (MHz)	Reading (dBuV)	Correct Factor (dB/m)	Result (dBuV/m)	Limit (dBuV/m)	Margin (dB)	Remark	Ant.Polar. H / V
3149.000	38.42	7.29	45.71	74.00	-28.29	peak	H
4924.000	36.56	10.88	47.44	74.00	-26.56	peak	H
6649.000	35.46	14.83	50.29	74.00	-23.71	peak	H
3121.000	38.71	7.27	45.98	74.00	-28.02	peak	V
4924.000	40.03	10.88	50.91	74.00	-23.09	peak	V
6845.000	35.09	15.03	50.12	74.00	-23.88	peak	V

Standard:	FCC Part 15C		Test Distance:	3m			
Test item:	Radiated Emission		Power:	AC 120V/60Hz			
Model Number:	NANO		Temp.(°C)/Hum.(%RH):	26(°C)/60%RH			
Mode:	Mode 5		Date:	10/30/2015			
Frequency:	2422MHz		Test By:	Eric Ou Yang			
Frequency (MHz)	Reading (dBuV)	Correct Factor (dB/m)	Result (dBuV/m)	Limit (dBuV/m)	Margin (dB)	Remark	Ant.Polar. H / V
3163.000	38.64	7.30	45.94	74.00	-28.06	peak	H
4598.000	37.08	10.32	47.40	74.00	-26.60	peak	H
6621.000	36.01	14.79	50.80	74.00	-23.20	peak	H
3030.000	38.29	7.19	45.48	74.00	-28.52	peak	V
4724.000	36.75	10.54	47.29	74.00	-26.71	peak	V
6684.000	36.59	14.86	51.45	74.00	-22.55	peak	V

Standard:	FCC Part 15C	Test Distance:	3m
Test item:	Radiated Emission	Power:	AC 120V/60Hz
Model Number:	NANO	Temp.(°C)/Hum.(%RH):	26(°C)/60%RH
Mode:	Mode 5	Date:	10/30/2015
Frequency:	2437MHz	Test By:	Eric Ou Yang

Frequency (MHz)	Reading (dBuV)	Correct Factor (dB/m)	Result (dBuV/m)	Limit (dBuV/m)	Margin (dB)	Remark	Ant.Polar. H / V
3100.000	38.68	7.25	45.93	74.00	-28.07	peak	H
4633.000	37.05	10.38	47.43	74.00	-26.57	peak	H
6817.000	35.67	15.00	50.67	74.00	-23.33	peak	H
3058.000	38.81	7.22	46.03	74.00	-27.97	peak	V
4577.000	37.05	10.28	47.33	74.00	-26.67	peak	V
6726.000	36.00	14.90	50.90	74.00	-23.10	peak	V

Standard:	FCC Part 15C	Test Distance:	3m
Test item:	Radiated Emission	Power:	AC 120V/60Hz
Model Number:	NANO	Temp.(°C)/Hum.(%RH):	26(°C)/60%RH
Mode:	Mode 5	Date:	10/30/2015
Frequency:	2452MHz	Test By:	Eric Ou Yang

Frequency (MHz)	Reading (dBuV)	Correct Factor (dB/m)	Result (dBuV/m)	Limit (dBuV/m)	Margin (dB)	Remark	Ant.Polar. H / V
3177.000	38.84	7.31	46.15	74.00	-27.85	peak	H
4577.000	36.66	10.28	46.94	74.00	-27.06	peak	H
6649.000	35.83	14.83	50.66	74.00	-23.34	peak	H
3128.000	38.30	7.27	45.57	74.00	-28.43	peak	V
4647.000	36.86	10.41	47.27	74.00	-26.73	peak	V
6719.000	35.78	14.89	50.67	74.00	-23.33	peak	V

Standard:	FCC Part 15C	Test Distance:	3m
Test item:	Radiated Emission	Power:	AC 120V/60Hz
Model Number:	NANO	Temp.(°C)/Hum.(%RH):	26(°C)/60%RH
Mode:	Mode 6	Date:	10/30/2015
		Test By:	Eric Ou Yang

Frequency (MHz)	Reading (dBuV)	Correct Factor (dB/m)	Result (dBuV/m)	Limit (dBuV/m)	Margin (dB)	Remark	Ant.Polar. H / V
200.0000	59.59	-17.74	41.85	43.50	-1.65	QP	H
300.5000	51.56	-14.33	37.23	46.00	-8.77	QP	H
380.0000	42.59	-12.23	30.36	46.00	-15.64	QP	H
400.0000	51.08	-11.79	39.29	46.00	-6.71	QP	H
600.0000	44.89	-7.37	37.52	46.00	-8.48	QP	H
799.5000	37.66	-4.68	32.98	46.00	-13.02	QP	H
82.0000	45.96	-19.57	26.39	40.00	-13.61	QP	V
300.5000	43.51	-14.33	29.18	46.00	-16.82	QP	V
400.0000	39.70	-11.79	27.91	46.00	-18.09	QP	V
501.0000	36.69	-9.54	27.15	46.00	-18.85	QP	V
639.0000	39.64	-6.95	32.69	46.00	-13.31	QP	V
796.5000	38.34	-4.74	33.60	46.00	-12.40	QP	V

Note: No emission found between lowest internal used/generated frequency to 30MHz (9kHz~30MHz).

Standard:	FCC Part 15C			Test Distance:	3m		
Test item:	Radiated Emission			Power:	AC 120V/60Hz		
Model Number:	NANO			Temp.(°C)/Hum.(%RH):	26(°C)/60%RH		
Mode:	Mode 7			Date:	10/28/2015		
Frequency:	2412MHz			Test By:	Eric Ou Yang		
Frequency (MHz)	Reading (dBuV)	Correct Factor (dB/m)	Result (dBuV/m)	Limit (dBuV/m)	Margin (dB)	Remark	Ant.Polar. H / V
3100.000	38.15	7.25	45.40	74.00	-28.60	peak	H
4824.000	38.19	10.70	48.89	74.00	-25.11	peak	H
6754.000	35.31	14.93	50.24	74.00	-23.76	peak	H
3163.000	38.06	7.30	45.36	74.00	-28.64	peak	V
4824.000	43.70	10.70	54.40	74.00	-19.60	peak	V
4824.000	41.74	10.70	52.44	54.00	-1.56	AVG	V
6852.000	36.70	15.04	51.74	74.00	-22.26	peak	V

Standard:	FCC Part 15C			Test Distance:	3m		
Test item:	Radiated Emission			Power:	AC 120V/60Hz		
Model Number:	NANO			Temp.(°C)/Hum.(%RH):	26(°C)/60%RH		
Mode:	Mode 7			Date:	10/28/2015		
Frequency:	2437MHz			Test By:	Eric Ou Yang		
Frequency (MHz)	Reading (dBuV)	Correct Factor (dB/m)	Result (dBuV/m)	Limit (dBuV/m)	Margin (dB)	Remark	Ant.Polar. H / V
3289.000	39.84	7.41	47.25	74.00	-26.75	peak	H
4874.000	38.74	10.79	49.53	74.00	-24.47	peak	H
6614.000	35.67	14.78	50.45	74.00	-23.55	peak	H
3247.000	39.69	7.37	47.06	74.00	-26.94	peak	V
4874.000	43.66	10.79	54.45	74.00	-19.55	peak	V
4874.000	42.25	10.79	53.04	54.00	-0.96	AVG	V
6705.000	35.48	14.88	50.36	74.00	-23.64	peak	V

Standard:	FCC Part 15C			Test Distance:	3m		
Test item:	Radiated Emission			Power:	AC 120V/60Hz		
Model Number:	NANO			Temp.(°C)/Hum.(%RH):	26(°C)/60%RH		
Mode:	Mode 7			Date:	10/28/2015		
Frequency:	2462MHz			Test By:	Eric Ou Yang		
Frequency (MHz)	Reading (dBuV)	Correct Factor (dB/m)	Result (dBuV/m)	Limit (dBuV/m)	Margin (dB)	Remark	Ant.Polar. H / V
3079.000	38.41	7.23	45.64	74.00	-28.36	peak	H
4924.000	40.51	10.88	51.39	74.00	-22.61	peak	H
6649.000	35.32	14.83	50.15	74.00	-23.85	peak	H
3079.000	38.54	7.23	45.77	74.00	-28.23	peak	V
4924.000	43.86	10.88	54.74	74.00	-19.26	peak	V
4924.000	42.61	10.88	53.49	54.00	-0.51	AVG	V
6677.000	35.59	14.85	50.44	74.00	-23.56	peak	V

Standard:	FCC Part 15C			Test Distance:	3m		
Test item:	Radiated Emission			Power:	AC 120V/60Hz		
Model Number:	NANO			Temp.(°C)/Hum.(%RH):	26(°C)/60%RH		
Mode:	Mode 8			Date:	10/28/2015		
Frequency:	2412MHz			Test By:	Eric Ou Yang		
Frequency (MHz)	Reading (dBuV)	Correct Factor (dB/m)	Result (dBuV/m)	Limit (dBuV/m)	Margin (dB)	Remark	Ant.Polar. H / V
3002.000	38.37	7.17	45.54	74.00	-28.46	peak	H
4824.000	45.32	10.70	56.02	74.00	-17.98	peak	H
4824.000	35.61	10.70	46.31	54.00	-7.69	AVG	H
6691.000	35.79	14.87	50.66	74.00	-23.34	peak	H
3219.000	40.74	7.35	48.09	74.00	-25.91	peak	V
4824.000	55.34	10.70	66.04	74.00	-7.96	peak	V
4824.000	42.13	10.70	52.83	54.00	-1.17	AVG	V
5942.000	35.19	13.42	48.61	74.00	-25.39	peak	V

Standard:	FCC Part 15C			Test Distance:	3m		
Test item:	Radiated Emission			Power:	AC 120V/60Hz		
Model Number:	NANO			Temp.(°C)/Hum.(%RH):	26(°C)/60%RH		
Mode:	Mode 8			Date:	10/28/2015		
Frequency:	2437MHz			Test By:	Eric Ou Yang		
Frequency (MHz)	Reading (dBuV)	Correct Factor (dB/m)	Result (dBuV/m)	Limit (dBuV/m)	Margin (dB)	Remark	Ant.Polar. H / V
3002.000	39.06	7.17	46.23	74.00	-27.77	peak	H
4874.000	46.01	10.79	56.80	74.00	-17.20	peak	H
4874.000	36.55	10.79	47.34	54.00	-6.66	AVG	H
6789.000	35.55	14.97	50.52	74.00	-23.48	peak	H
3247.000	39.98	7.37	47.35	74.00	-26.65	peak	V
4874.000	53.20	10.79	63.99	74.00	-10.01	peak	V
4874.000	42.95	10.79	53.74	54.00	-0.26	AVG	V
6782.000	35.17	14.97	50.14	74.00	-23.86	peak	V

Standard:	FCC Part 15C			Test Distance:	3m		
Test item:	Radiated Emission			Power:	AC 120V/60Hz		
Model Number:	NANO			Temp.(°C)/Hum.(%RH):	26(°C)/60%RH		
Mode:	Mode 8			Date:	10/28/2015		
Frequency:	2462MHz			Test By:	Eric Ou Yang		
Frequency (MHz)	Reading (dBuV)	Correct Factor (dB/m)	Result (dBuV/m)	Limit (dBuV/m)	Margin (dB)	Remark	Ant.Polar. H / V
3135.000	38.48	7.28	45.76	74.00	-28.24	peak	H
4924.000	46.23	10.88	57.11	74.00	-16.89	peak	H
4924.000	35.39	10.88	46.27	54.00	-7.73	AVG	H
6628.000	35.61	14.80	50.41	74.00	-23.59	peak	H
3051.000	38.96	7.22	46.18	74.00	-27.82	peak	V
4924.000	53.35	10.88	64.23	74.00	-9.77	peak	V
4924.000	42.22	10.88	53.10	54.00	-0.90	AVG	V
6747.000	35.76	14.93	50.69	74.00	-23.31	peak	V

Standard:	FCC Part 15C			Test Distance:	3m		
Test item:	Radiated Emission			Power:	AC 120V/60Hz		
Model Number:	NANO			Temp.(°C)/Hum.(%RH):	26(°C)/60%RH		
Mode:	Mode 9			Date:	10/28/2015		
Frequency:	2412MHz			Test By:	Eric Ou Yang		
Frequency (MHz)	Reading (dBuV)	Correct Factor (dB/m)	Result (dBuV/m)	Limit (dBuV/m)	Margin (dB)	Remark	Ant.Polar. H / V
2981.000	38.87	7.12	45.99	74.00	-28.01	peak	H
4824.000	45.26	10.70	55.96	74.00	-18.04	peak	H
4824.000	35.76	10.70	46.46	54.00	-7.54	AVG	H
6782.000	36.11	14.97	51.08	74.00	-22.92	peak	H
3051.000	38.80	7.22	46.02	74.00	-27.98	peak	V
4824.000	55.45	10.70	66.15	74.00	-7.85	peak	V
4824.000	41.87	10.70	52.57	54.00	-1.43	AVG	V
6761.000	36.81	14.94	51.75	74.00	-22.25	peak	V

Standard:	FCC Part 15C			Test Distance:	3m		
Test item:	Radiated Emission			Power:	AC 120V/60Hz		
Model Number:	NANO			Temp.(°C)/Hum.(%RH):	26(°C)/60%RH		
Mode:	Mode 9			Date:	10/28/2015		
Frequency:	2437MHz			Test By:	Eric Ou Yang		
Frequency (MHz)	Reading (dBuV)	Correct Factor (dB/m)	Result (dBuV/m)	Limit (dBuV/m)	Margin (dB)	Remark	Ant.Polar. H / V
3128.000	38.38	7.27	45.65	74.00	-28.35	peak	H
4874.000	47.40	10.79	58.19	74.00	-15.81	peak	H
4874.000	36.15	10.79	46.94	54.00	-7.06	AVG	H
6684.000	35.21	14.86	50.07	74.00	-23.93	peak	H
3002.000	39.03	7.17	46.20	74.00	-27.80	peak	V
4874.000	53.84	10.79	64.63	74.00	-9.37	peak	V
4874.000	42.72	10.79	53.51	54.00	-0.49	AVG	V
6803.000	35.50	14.98	50.48	74.00	-23.52	peak	V

Standard:	FCC Part 15C			Test Distance:	3m		
Test item:	Radiated Emission			Power:	AC 120V/60Hz		
Model Number:	NANO			Temp.(°C)/Hum.(%RH):	26(°C)/60%RH		
Mode:	Mode 9			Date:	10/28/2015		
Frequency:	2462MHz			Test By:	Eric Ou Yang		
Frequency (MHz)	Reading (dBuV)	Correct Factor (dB/m)	Result (dBuV/m)	Limit (dBuV/m)	Margin (dB)	Remark	Ant.Polar. H / V
3002.000	38.17	7.17	45.34	74.00	-28.66	peak	H
4924.000	47.11	10.88	57.99	74.00	-16.01	peak	H
4924.000	35.12	10.88	46.00	54.00	-8.00	AVG	H
6656.000	35.65	14.83	50.48	74.00	-23.52	peak	H
3107.000	39.65	7.26	46.91	74.00	-27.09	peak	V
4924.000	53.68	10.88	64.56	74.00	-9.44	peak	V
4924.000	41.83	10.88	52.71	54.00	-1.29	AVG	V
6705.000	34.76	14.88	49.64	74.00	-24.36	peak	V

Standard:	FCC Part 15C			Test Distance:	3m		
Test item:	Radiated Emission			Power:	AC 120V/60Hz		
Model Number:	NANO			Temp.(°C)/Hum.(%RH):	26(°C)/60%RH		
Mode:	Mode 10			Date:	10/28/2015		
Frequency:	2422MHz			Test By:	Eric Ou Yang		
Frequency (MHz)	Reading (dBuV)	Correct Factor (dB/m)	Result (dBuV/m)	Limit (dBuV/m)	Margin (dB)	Remark	Ant.Polar. H / V
3121.000	38.64	7.27	45.91	74.00	-28.09	peak	H
4844.000	43.73	10.74	54.47	74.00	-19.53	peak	H
4844.000	32.97	10.74	43.71	54.00	-10.29	AVG	H
6782.000	35.42	14.97	50.39	74.00	-23.61	peak	H
3002.000	39.18	7.17	46.35	74.00	-27.65	peak	V
4844.000	50.08	10.74	60.82	74.00	-13.18	peak	V
4844.000	38.83	10.74	49.57	54.00	-4.43	AVG	V
6698.000	35.70	14.88	50.58	74.00	-23.42	peak	V

Standard:	FCC Part 15C			Test Distance:	3m		
Test item:	Radiated Emission			Power:	AC 120V/60Hz		
Model Number:	NANO			Temp.(°C)/Hum.(%RH):	26(°C)/60%RH		
Mode:	Mode 10			Date:	10/28/2015		
Frequency:	2437MHz			Test By:	Eric Ou Yang		
Frequency (MHz)	Reading (dBuV)	Correct Factor (dB/m)	Result (dBuV/m)	Limit (dBuV/m)	Margin (dB)	Remark	Ant.Polar. H / V
3128.000	38.76	7.27	46.03	74.00	-27.97	peak	H
4874.000	43.11	10.79	53.90	74.00	-20.10	peak	H
4874.000	33.12	10.79	43.91	54.00	-10.09	AVG	H
6733.000	36.34	14.92	51.26	74.00	-22.74	peak	H
3128.000	38.78	7.27	46.05	74.00	-27.95	peak	V
4874.000	48.97	10.79	59.76	74.00	-14.24	peak	V
4874.000	39.30	10.79	50.09	54.00	-3.91	AVG	V
6782.000	35.24	14.97	50.21	74.00	-23.79	peak	V

Standard:	FCC Part 15C			Test Distance:	3m		
Test item:	Radiated Emission			Power:	AC 120V/60Hz		
Model Number:	NANO			Temp.(°C)/Hum.(%RH):	26(°C)/60%RH		
Mode:	Mode 10			Date:	10/28/2015		
Frequency:	2452MHz			Test By:	Eric Ou Yang		
Frequency (MHz)	Reading (dBuV)	Correct Factor (dB/m)	Result (dBuV/m)	Limit (dBuV/m)	Margin (dB)	Remark	Ant.Polar. H / V
2897.000	40.59	6.88	47.47	74.00	-26.53	peak	H
4904.000	43.71	10.84	54.55	74.00	-19.45	peak	H
4904.000	32.51	10.84	43.35	54.00	-10.65	AVG	H
6663.000	35.66	14.83	50.49	74.00	-23.51	peak	H
3016.000	39.59	7.18	46.77	74.00	-27.23	peak	V
4904.000	50.45	10.84	61.29	74.00	-12.71	peak	V
4904.000	38.78	10.84	49.62	54.00	-4.38	AVG	V
6614.000	35.67	14.78	50.45	74.00	-23.55	peak	V

Band Edge

Standard:	FCC Part 15C			Test Distance:	3m		
Test item:	Radiated Emission			Power:	AC 120V/60Hz		
Model Number:	NANO			Temp.(°C)/Hum.(%RH):	26(°C)/60%RH		
Mode:	Mode 2			Date:	10/29/2015		
Frequency:	2412 MHz			Test By:	Eric Ou Yang		
Frequency (MHz)	Reading (dBuV)	Correct Factor (dB/m)	Result (dBuV/m)	Limit (dBuV/m)	Margin (dB)	Remark	Ant.Polar. H / V
2373.470	42.84	5.41	48.25	74.00	-25.75	peak	H
2390.000	41.13	5.45	46.58	74.00	-27.42	peak	H
2377.980	47.69	5.41	53.10	74.00	-20.90	peak	V
2377.980	35.64	5.41	41.05	54.00	-12.95	AVG	V
2390.000	44.08	5.45	49.53	74.00	-24.47	peak	V

Standard:	FCC Part 15C			Test Distance:	3m		
Test item:	Radiated Emission			Power:	AC 120V/60Hz		
Model Number:	NANO			Temp.(°C)/Hum.(%RH):	26(°C)/60%RH		
Mode:	Mode 2			Date:	10/29/2015		
Frequency:	2462 MHz			Test By:	Eric Ou Yang		
Frequency (MHz)	Reading (dBuV)	Correct Factor (dB/m)	Result (dBuV/m)	Limit (dBuV/m)	Margin (dB)	Remark	Ant.Polar. H / V
2483.500	40.68	5.70	46.38	74.00	-27.62	peak	H
2485.680	43.16	5.71	48.87	74.00	-25.13	peak	H
2483.500	44.63	5.70	50.33	74.00	-23.67	peak	V
2487.760	47.52	5.71	53.23	74.00	-20.77	peak	V
2487.760	35.41	5.71	41.12	54.00	-12.88	AVG	V

Standard:	FCC Part 15C			Test Distance:	3m		
Test item:	Radiated Emission			Power:	AC 120V/60Hz		
Model Number:	NANO			Temp.(°C)/Hum.(%RH):	26(°C)/60%RH		
Mode:	Mode 3			Date:	10/29/2015		
Frequency:	2412 MHz			Test By:	Eric Ou Yang		
Frequency (MHz)	Reading (dBuV)	Correct Factor (dB/m)	Result (dBuV/m)	Limit (dBuV/m)	Margin (dB)	Remark	Ant.Polar. H / V
2389.640	57.13	5.45	62.58	74.00	-11.42	peak	H
2389.640	39.60	5.45	45.05	54.00	-8.95	AVG	H
2390.000	52.53	5.45	57.98	74.00	-16.02	peak	H
2390.000	40.45	5.45	45.90	54.00	-8.10	AVG	H
2389.200	62.00	5.45	67.45	74.00	-6.55	peak	V
2389.200	43.41	5.45	48.86	54.00	-5.14	AVG	V
2390.000	60.99	5.45	66.44	74.00	-7.56	peak	V
2390.000	45.21	5.45	50.66	54.00	-3.34	AVG	V

Standard:	FCC Part 15C			Test Distance:	3m		
Test item:	Radiated Emission			Power:	AC 120V/60Hz		
Model Number:	NANO			Temp.(°C)/Hum.(%RH):	26(°C)/60%RH		
Mode:	Mode 3			Date:	10/29/2015		
Frequency:	2462 MHz			Test By:	Eric Ou Yang		
Frequency (MHz)	Reading (dBuV)	Correct Factor (dB/m)	Result (dBuV/m)	Limit (dBuV/m)	Margin (dB)	Remark	Ant.Polar. H / V
2483.500	56.64	5.70	62.34	74.00	-11.66	peak	H
2483.500	40.49	5.70	46.19	54.00	-7.81	AVG	H
2484.120	58.38	5.70	64.08	74.00	-9.92	peak	H
2484.120	39.58	5.70	45.28	54.00	-8.72	AVG	H
2483.500	60.38	5.70	66.08	74.00	-7.92	peak	V
2483.500	45.57	5.70	51.27	54.00	-2.73	AVG	V
2484.040	63.81	5.70	69.51	74.00	-4.49	peak	V
2484.040	44.42	5.70	50.12	54.00	-3.88	AVG	V

Standard:	FCC Part 15C			Test Distance:	3m		
Test item:	Radiated Emission			Power:	AC 120V/60Hz		
Model Number:	NANO			Temp.(°C)/Hum.(%RH):	26(°C)/60%RH		
Mode:	Mode 4			Date:	10/29/2015		
Frequency:	2412 MHz			Test By:	Eric Ou Yang		
Frequency (MHz)	Reading (dBuV)	Correct Factor (dB/m)	Result (dBuV/m)	Limit (dBuV/m)	Margin (dB)	Remark	Ant.Polar. H / V
2389.530	56.55	5.45	62.00	74.00	-12.00	peak	H
2389.530	41.14	5.45	46.59	54.00	-7.41	AVG	H
2390.000	56.55	5.45	62.00	74.00	-12.00	peak	H
2390.000	41.80	5.45	47.25	54.00	-6.75	AVG	H
2389.640	63.22	5.45	68.67	74.00	-5.33	peak	V
2389.640	46.36	5.45	51.81	54.00	-2.19	AVG	V
2390.000	60.40	5.45	65.85	74.00	-8.15	peak	V
2390.000	46.94	5.45	52.39	54.00	-1.61	AVG	V

Standard:	FCC Part 15C			Test Distance:	3m		
Test item:	Radiated Emission			Power:	AC 120V/60Hz		
Model Number:	NANO			Temp.(°C)/Hum.(%RH):	26(°C)/60%RH		
Mode:	Mode 4			Date:	10/29/2015		
Frequency:	2462 MHz			Test By:	Eric Ou Yang		
Frequency (MHz)	Reading (dBuV)	Correct Factor (dB/m)	Result (dBuV/m)	Limit (dBuV/m)	Margin (dB)	Remark	Ant.Polar. H / V
2483.500	56.94	5.70	62.64	74.00	-11.36	peak	H
2483.500	42.73	5.70	48.43	54.00	-5.57	AVG	H
2484.800	59.46	5.71	65.17	74.00	-8.83	peak	H
2484.800	41.30	5.71	47.01	54.00	-6.99	AVG	H
2483.500	60.23	5.70	65.93	74.00	-8.07	peak	V
2483.500	47.34	5.70	53.04	54.00	-0.96	AVG	V
2484.040	63.61	5.70	69.31	74.00	-4.69	peak	V
2484.040	46.37	5.70	52.07	54.00	-1.93	AVG	V

Standard:	FCC Part 15C			Test Distance:	3m		
Test item:	Radiated Emission			Power:	AC 120V/60Hz		
Model Number:	NANO			Temp.(°C)/Hum.(%RH):	26(°C)/60%RH		
Mode:	Mode 5			Date:	10/30/2015		
Frequency:	2422 MHz			Test By:	Eric Ou Yang		
Frequency (MHz)	Reading (dBuV)	Correct Factor (dB/m)	Result (dBuV/m)	Limit (dBuV/m)	Margin (dB)	Remark	Ant.Polar. H / V
2388.840	59.75	5.45	65.20	74.00	-8.80	peak	H
2388.840	43.77	5.45	49.22	54.00	-4.78	AVG	H
2390.000	60.93	5.45	66.38	74.00	-7.62	peak	H
2390.000	44.43	5.45	49.88	54.00	-4.12	AVG	H
2386.920	63.59	5.45	69.04	74.00	-4.96	peak	V
2386.920	46.53	5.45	51.98	54.00	-2.02	AVG	V
2390.000	62.35	5.45	67.80	74.00	-6.20	peak	V
2390.000	47.63	5.45	53.08	54.00	-0.92	AVG	V

Standard:	FCC Part 15C			Test Distance:	3m		
Test item:	Radiated Emission			Power:	AC 120V/60Hz		
Model Number:	NANO			Temp.(°C)/Hum.(%RH):	26(°C)/60%RH		
Mode:	Mode 5			Date:	10/30/2015		
Frequency:	2452 MHz			Test By:	Eric Ou Yang		
Frequency (MHz)	Reading (dBuV)	Correct Factor (dB/m)	Result (dBuV/m)	Limit (dBuV/m)	Margin (dB)	Remark	Ant.Polar. H / V
2483.500	60.88	5.70	66.58	74.00	-7.42	peak	H
2483.500	43.09	5.70	48.79	54.00	-5.21	AVG	H
2484.700	60.72	5.71	66.43	74.00	-7.57	peak	H
2484.700	42.57	5.71	48.28	54.00	-5.72	AVG	H
2483.500	63.50	5.70	69.20	74.00	-4.80	peak	V
2483.500	45.59	5.70	51.29	54.00	-2.71	AVG	V
2483.900	62.30	5.70	68.00	74.00	-6.00	peak	V
2483.900	45.41	5.70	51.11	54.00	-2.89	AVG	V

Standard:	FCC Part 15C			Test Distance:	3m		
Test item:	Radiated Emission			Power:	AC 120V/60Hz		
Model Number:	NANO			Temp.(°C)/Hum.(%RH):	26(°C)/60%RH		
Mode:	Mode 7			Date:	10/28/2015		
Frequency:	2412 MHz			Test By:	Eric Ou Yang		
Frequency (MHz)	Reading (dBuV)	Correct Factor (dB/m)	Result (dBuV/m)	Limit (dBuV/m)	Margin (dB)	Remark	Ant.Polar. H / V
2378.530	43.14	5.43	48.57	74.00	-25.43	peak	H
2390.000	41.18	5.45	46.63	74.00	-27.37	peak	H
2355.650	44.02	5.36	49.38	74.00	-24.62	peak	V
2390.000	41.24	5.45	46.69	74.00	-27.31	peak	V

Standard:	FCC Part 15C			Test Distance:	3m		
Test item:	Radiated Emission			Power:	AC 120V/60Hz		
Model Number:	NANO			Temp.(°C)/Hum.(%RH):	26(°C)/60%RH		
Mode:	Mode 7			Date:	10/29/2015		
Frequency:	2462 MHz			Test By:	Eric Ou Yang		
Frequency (MHz)	Reading (dBuV)	Correct Factor (dB/m)	Result (dBuV/m)	Limit (dBuV/m)	Margin (dB)	Remark	Ant.Polar. H / V
2483.500	39.22	5.70	44.92	74.00	-29.08	peak	H
2484.560	41.59	5.71	47.30	74.00	-26.70	peak	H
2483.500	42.27	5.70	47.97	74.00	-26.03	peak	V
2498.400	45.26	5.74	51.00	74.00	-23.00	peak	V

Standard:	FCC Part 15C			Test Distance:	3m		
Test item:	Radiated Emission			Power:	AC 120V/60Hz		
Model Number:	NANO			Temp.(°C)/Hum.(%RH):	26(°C)/60%RH		
Mode:	Mode 8			Date:	10/29/2015		
Frequency:	2412 MHz			Test By:	Eric Ou Yang		
Frequency (MHz)	Reading (dBuV)	Correct Factor (dB/m)	Result (dBuV/m)	Limit (dBuV/m)	Margin (dB)	Remark	Ant.Polar. H / V
2389.420	54.23	5.45	59.68	74.00	-14.32	peak	H
2389.420	38.63	5.45	44.08	54.00	-9.92	AVG	H
2390.000	53.67	5.45	59.12	74.00	-14.88	peak	H
2390.000	40.10	5.45	45.55	54.00	-8.45	AVG	H
2389.420	59.51	5.45	64.96	74.00	-9.04	peak	V
2389.420	40.59	5.45	46.04	54.00	-7.96	AVG	V
2390.000	56.83	5.45	62.28	74.00	-11.72	peak	V
2390.000	41.95	5.45	47.40	54.00	-6.60	AVG	V

Standard:	FCC Part 15C			Test Distance:	3m		
Test item:	Radiated Emission			Power:	AC 120V/60Hz		
Model Number:	NANO			Temp.(°C)/Hum.(%RH):	26(°C)/60%RH		
Mode:	Mode 8			Date:	10/29/2015		
Frequency:	2462 MHz			Test By:	Eric Ou Yang		
Frequency (MHz)	Reading (dBuV)	Correct Factor (dB/m)	Result (dBuV/m)	Limit (dBuV/m)	Margin (dB)	Remark	Ant.Polar. H / V
2483.500	54.53	5.70	60.23	74.00	-13.77	peak	H
2483.500	38.43	5.70	44.13	54.00	-9.87	AVG	H
2484.200	55.08	5.70	60.78	74.00	-13.22	peak	H
2484.200	36.70	5.70	42.40	54.00	-11.60	AVG	H
2483.500	56.95	5.70	62.65	74.00	-11.35	peak	V
2483.500	43.32	5.70	49.02	54.00	-4.98	AVG	V
2484.320	61.20	5.70	66.90	74.00	-7.10	peak	V
2484.320	41.23	5.70	46.93	54.00	-7.07	AVG	V

Standard:	FCC Part 15C			Test Distance:	3m		
Test item:	Radiated Emission			Power:	AC 120V/60Hz		
Model Number:	NANO			Temp.(°C)/Hum.(%RH):	26(°C)/60%RH		
Mode:	Mode 9			Date:	10/29/2015		
Frequency:	2412 MHz			Test By:	Eric Ou Yang		
Frequency (MHz)	Reading (dBuV)	Correct Factor (dB/m)	Result (dBuV/m)	Limit (dBuV/m)	Margin (dB)	Remark	Ant.Polar. H / V
2388.430	56.94	5.45	62.39	74.00	-11.61	peak	H
2388.430	39.33	5.45	44.78	54.00	-9.22	AVG	H
2390.000	54.98	5.45	60.43	74.00	-13.57	peak	H
2390.000	43.15	5.45	48.60	54.00	-5.40	AVG	H
2389.310	62.58	5.45	68.03	74.00	-5.97	peak	V
2389.310	43.27	5.45	48.72	54.00	-5.28	AVG	V
2390.000	59.45	5.45	64.90	74.00	-9.10	peak	V
2390.000	44.74	5.45	50.19	54.00	-3.81	AVG	V

Standard:	FCC Part 15C			Test Distance:	3m		
Test item:	Radiated Emission			Power:	AC 120V/60Hz		
Model Number:	NANO			Temp.(°C)/Hum.(%RH):	26(°C)/60%RH		
Mode:	Mode 9			Date:	10/29/2015		
Frequency:	2462 MHz			Test By:	Eric Ou Yang		
Frequency (MHz)	Reading (dBuV)	Correct Factor (dB/m)	Result (dBuV/m)	Limit (dBuV/m)	Margin (dB)	Remark	Ant.Polar. H / V
2483.500	54.41	5.70	60.11	74.00	-13.89	peak	H
2483.500	40.45	5.70	46.15	54.00	-7.85	AVG	H
2484.000	58.16	5.70	63.86	74.00	-10.14	peak	H
2484.000	39.58	5.70	45.28	54.00	-8.72	AVG	H
2483.500	61.07	5.70	66.77	74.00	-7.23	peak	V
2483.500	46.00	5.70	51.70	54.00	-2.30	AVG	V
2484.040	63.47	5.70	69.17	74.00	-4.83	peak	V
2484.040	44.97	5.70	50.67	54.00	-3.33	AVG	V

Standard:	FCC Part 15C			Test Distance:	3m		
Test item:	Radiated Emission			Power:	AC 120V/60Hz		
Model Number:	NANO			Temp.(°C)/Hum.(%RH):	26(°C)/60%RH		
Mode:	Mode 10			Date:	10/28/2015		
Frequency:	2422 MHz			Test By:	Eric Ou Yang		
Frequency (MHz)	Reading (dBuV)	Correct Factor (dB/m)	Result (dBuV/m)	Limit (dBuV/m)	Margin (dB)	Remark	Ant.Polar. H / V
2389.320	61.37	5.45	66.82	74.00	-7.18	peak	H
2389.320	44.93	5.45	50.38	54.00	-3.62	AVG	H
2390.000	57.19	5.45	62.64	74.00	-11.36	peak	H
2390.000	45.16	5.45	50.61	54.00	-3.39	AVG	H
2388.480	62.38	5.45	67.83	74.00	-6.17	peak	V
2388.480	46.11	5.45	51.56	54.00	-2.44	AVG	V
2390.000	58.67	5.45	64.12	74.00	-9.88	peak	V
2390.000	46.98	5.45	52.43	54.00	-1.57	AVG	V

Standard:	FCC Part 15C			Test Distance:	3m		
Test item:	Radiated Emission			Power:	AC 120V/60Hz		
Model Number:	NANO			Temp.(°C)/Hum.(%RH):	26(°C)/60%RH		
Mode:	Mode 10			Date:	10/28/2015		
Frequency:	2452 MHz			Test By:	Eric Ou Yang		
Frequency (MHz)	Reading (dBuV)	Correct Factor (dB/m)	Result (dBuV/m)	Limit (dBuV/m)	Margin (dB)	Remark	Ant.Polar. H / V
2483.500	56.97	5.70	62.67	74.00	-11.33	peak	H
2483.500	46.09	5.70	51.79	54.00	-2.21	AVG	H
2485.950	60.82	5.71	66.53	74.00	-7.47	peak	H
2485.950	45.49	5.71	51.20	54.00	-2.80	AVG	H
2483.500	61.03	5.70	66.73	74.00	-7.27	peak	V
2483.500	46.63	5.70	52.33	54.00	-1.67	AVG	V
2488.050	63.23	5.71	68.94	74.00	-5.06	peak	V
2488.050	41.59	5.71	47.30	54.00	-6.70	AVG	V

6 Maximum Conducted Output Power Measurement

6.1. Limit

For systems using digital modulation in the 2400-2483.5MHz, the limit for maximum output power is 30dBm.

6.2. Test Setup

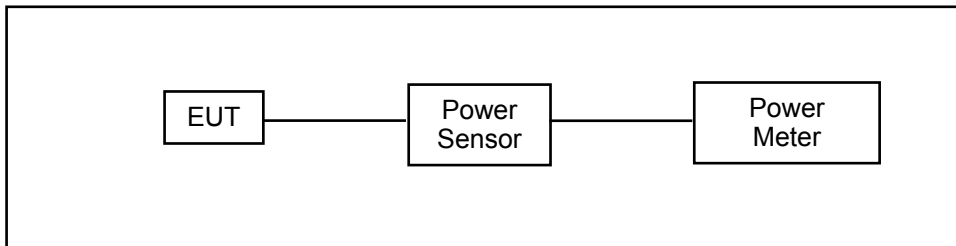

6.3. Test Instruments

Equipment	Manufacturer	Model Number	Serial Number	Cal. Date	Remark
Power Sensor	Anritsu	MA2411B	1126022	08/24/2015	(1)
Power Meter	Anritsu	ML2495A	1135009	08/24/2015	(1)
Test Site	ATL	TE05	TE05	N.C.R.	-----

Remark: (1) Calibration period 1 year. (2) Calibration period 2 years. (3) Calibration period 3 years.

Note: N.C.R. = No Calibration Request.

6.4. Test Procedure

The tests below are run with the EUT's transmitter set at high power in TX mode. The EUT is needed to force selection of output power level and channel number. While testing, EUT was set to transmit continuously. Remove the Subjective device's antenna and connect the RF output port to power sensor. The maximum output power shall not exceed 1 watt.

Use a direct connection between the antenna port of transmitter and the power sensor, for prevent the power sensor input attenuation 40-50 dB. Set the RBW Bandwidth of the emission or use a channel power meter mode.

For antennas with gains of 6 dBi or less, maximum allowed transmitter output is 1 watt (+30 dBm). For antennas with gains greater than 6 dBi, transmitter output level must be decreased by an amount equal to (GAIN - 6)/3 dBm.

The antenna port of the EUT was connected to the input of a power sensor. Power was read directly and cable loss correction was added to the reading to obtain power at the EUT antenna terminals.

6.5. Test Result

Model Number	NANO					
Test Item	Maximum Conducted Output Power					
Test Mode	Mode 2: AR9271L_IIEEE 802.11b link mode					
Date of Test	10/29/2015				Test Site	TE05
Frequency (MHz)	Data Rate	Average Power		Peak Power		Limit (dBm)
		(dBm)	(W)	(dBm)	(W)	
2412	1M	15.45	0.035	18.37	0.069	< 30
2437		15.34	0.034	18.29	0.067	< 30
2462		15.31	0.034	18.21	0.066	< 30
2437	2M	15.33	0.034	18.26	0.067	< 30
2437	5.5M	15.31	0.034	18.24	0.067	< 30
2437	11M	15.29	0.034	18.21	0.066	< 30

Model Number	NANO					
Test Item	Maximum Conducted Output Power					
Test Mode	Mode 3: AR9271L_IIEEE 802.11g link mode					
Date of Test	10/29/2015				Test Site	TE05
Frequency (MHz)	Data Rate	Average Power		Peak Power		Limit (dBm)
		(dBm)	(W)	(dBm)	(W)	
2412	6M	15.57	0.036	24.05	0.254	< 30
2437		15.39	0.035	23.94	0.248	< 30
2462		14.93	0.031	23.69	0.234	< 30
2437	9M	15.35	0.034	23.90	0.245	< 30
2437	12M	15.33	0.034	23.88	0.244	< 30
2437	18M	15.32	0.034	23.87	0.244	< 30
2437	24M	15.30	0.034	23.84	0.242	< 30
2437	36M	15.29	0.034	23.83	0.242	< 30
2437	48M	15.26	0.034	23.79	0.239	< 30
2437	54M	15.25	0.033	23.77	0.238	< 30

Model Number	NANO					
Test Item	Maximum Conducted Output Power					
Test Mode	Mode 4: AR9271L_IEEE 802.11n 2.4GHz 20MHz link mode					
Date of Test	10/29/2015				Test Site	TE05
Frequency (MHz)	Data Rate	Average Power		Peak Power		Limit (dBm)
		(dBm)	(W)	(dBm)	(W)	
2412	6.5M	15.28	0.034	23.97	0.249	< 30
2437		15.17	0.033	23.84	0.242	< 30
2462		14.42	0.028	23.38	0.218	< 30
2437	13M	15.14	0.033	23.82	0.241	< 30
2437	19.5M	15.13	0.033	23.81	0.240	< 30
2437	26M	15.11	0.032	23.80	0.240	< 30
2437	39M	15.10	0.032	23.78	0.239	< 30
2437	52M	15.08	0.032	23.76	0.238	< 30
2437	58.5M	15.06	0.032	23.75	0.237	< 30
2437	65M	15.05	0.032	23.73	0.236	< 30

Model Number	NANO					
Test Item	Maximum Conducted Output Power					
Test Mode	Mode 5: AR9271L_IEEE 802.11n 2.4GHz 40MHz link mode					
Date of Test	10/29/2015				Test Site	TE05
Frequency (MHz)	Data Rate	Average Power		Peak Power		Limit (dBm)
		(dBm)	(W)	(dBm)	(W)	
2422	13.5M	11.01	0.013	19.45	0.088	< 30
2437		10.96	0.012	19.21	0.083	< 30
2452		10.87	0.012	19.17	0.083	< 30
2437	27M	10.93	0.012	19.19	0.083	< 30
2437	40.5M	10.86	0.012	19.16	0.082	< 30
2437	54M	10.82	0.012	19.09	0.081	< 30
2437	81M	10.77	0.012	19.06	0.081	< 30
2437	108M	10.71	0.012	19.01	0.080	< 30
2437	121.5M	10.66	0.012	18.95	0.079	< 30
2437	135M	10.62	0.012	18.90	0.078	< 30

Model Number	NANO					
Test Item	Maximum Conducted Output Power					
Test Mode	Mode 7: AR9331_IEEE 802.11b link mode					
Date of Test	10/29/2015				Test Site	TE05
Frequency (MHz)	Data Rate	Average Power		Peak Power		Limit (dBm)
		(dBm)	(W)	(dBm)	(W)	
2412	1M	8.55	0.007	11.13	0.013	< 30
2437		8.21	0.007	11.02	0.013	< 30
2462		8.33	0.007	11.06	0.013	< 30
2437	2M	8.20	0.007	11.01	0.013	< 30
2437	5.5M	8.12	0.006	10.96	0.012	< 30
2437	11M	8.14	0.007	10.98	0.013	< 30

Model Number	NANO					
Test Item	Maximum Conducted Output Power					
Test Mode	Mode 8: AR9331_IEEE 802.11g link mode					
Date of Test	10/29/2015				Test Site	TE05
Frequency (MHz)	Data Rate	Average Power		Peak Power		Limit (dBm)
		(dBm)	(W)	(dBm)	(W)	
2412	6M	12.85	0.019	18.82	0.076	< 30
2437		12.97	0.020	19.73	0.094	< 30
2462		12.82	0.019	18.98	0.079	< 30
2437	9M	12.10	0.016	19.15	0.082	< 30
2437	12M	12.19	0.017	19.22	0.084	< 30
2437	18M	12.00	0.016	19.05	0.080	< 30
2437	24M	12.80	0.019	19.38	0.087	< 30
2437	36M	12.15	0.016	19.53	0.090	< 30
2437	48M	12.92	0.020	19.68	0.093	< 30
2437	54M	12.46	0.018	19.55	0.090	< 30

Model Number	NANO					
Test Item	Maximum Conducted Output Power					
Test Mode	Mode 9: AR9331_IEEE 802.11n 2.4GHz 20MHz link mode					
Date of Test	10/29/2015				Test Site	TE05
Frequency (MHz)	Data Rate	Average Power		Peak Power		Limit (dBm)
		(dBm)	(W)	(dBm)	(W)	
2412	6.5M	11.93	0.016	18.87	0.077	< 30
2437		12.51	0.018	19.61	0.091	< 30
2462		12.03	0.016	19.02	0.080	< 30
2437	13M	11.96	0.016	18.26	0.067	< 30
2437	19.5M	11.98	0.016	18.21	0.066	< 30
2437	26M	12.13	0.016	18.82	0.076	< 30
2437	39M	11.99	0.016	18.80	0.076	< 30
2437	52M	12.39	0.017	19.36	0.086	< 30
2437	58.5M	12.28	0.017	19.55	0.090	< 30
2437	65M	12.40	0.017	19.46	0.088	< 30

Model Number	NANO					
Test Item	Maximum Conducted Output Power					
Test Mode	Mode 10: AR9331_IEEE 802.11n 2.4GHz 40MHz link mode					
Date of Test	10/29/2015				Test Site	TE05
Frequency (MHz)	Data Rate	Average Power		Peak Power		Limit (dBm)
		(dBm)	(W)	(dBm)	(W)	
2422	13.5M	11.75	0.015	19.25	0.084	< 30
2437		11.68	0.015	19.15	0.082	< 30
2452		11.66	0.015	18.92	0.078	< 30
2437	27M	11.17	0.013	18.07	0.064	< 30
2437	40.5M	11.03	0.013	17.97	0.063	< 30
2437	54M	11.07	0.013	18.63	0.073	< 30
2437	81M	11.00	0.013	18.62	0.073	< 30
2437	108M	10.90	0.012	18.29	0.067	< 30
2437	121.5M	11.32	0.014	18.99	0.079	< 30
2437	135M	11.60	0.014	19.07	0.081	< 30

7 6dB RF Bandwidth Measurement

7.1. Limit

6dB RF Bandwidth: Systems using digital modulation techniques may operate in the 2400–2483.5 MHz bands. The minimum 6 dB band-width shall be at least 500 kHz.

7.2. Test Setup

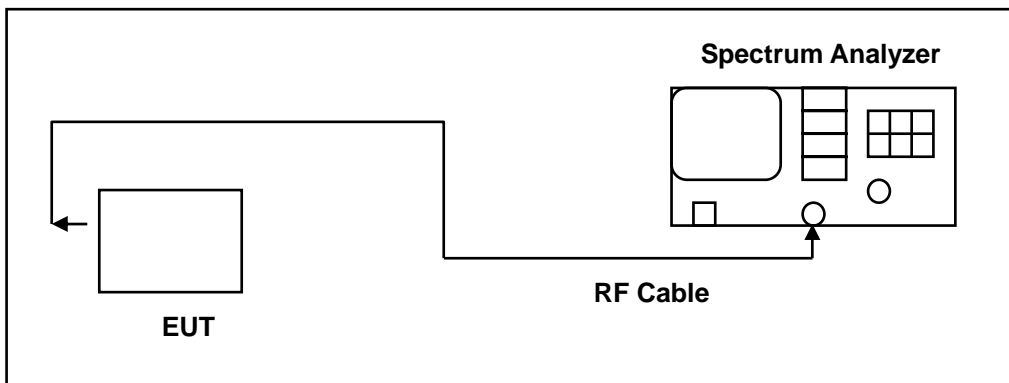

7.3. Test Instruments

Equipment	Manufacturer	Model Number	Serial Number	Cal. Date	Remark
Spectrum Analyzer	Agilent	E4445A	MY45300744	12/16/2014	(1)
Test Site	ATL	TE05	TE05	N.C.R.	----

dRemark: (1) Calibration period 1 year. (2) Calibration period 2 years. (3) Calibration period 3 years.

Note: N.C.R. = No Calibration Request.

7.4. Test Procedure

The EUT tested to DTS test procedure of KDB558074D01 for compliance to FCC 47CFR 15.247 requirements.

6dB RF Bandwidth: The antenna port of the EUT was connected to the input of a spectrum analyzer. Analyzer RES RBW was set to 100 kHz. For each RF output channel investigated, the spectrum analyzer center frequency was set to the channel carrier. A peak output reading was taken, a DISPLAY line was drawn 6 dB lower than peak level. The 6 dB bandwidth was determined from where the channel output spectrum intersected the display line.

The test was performed at 3 channels (Channel low, middle, high)

99 % Occupied Bandwidth: The transmitter shall be operated at its maximum carrier power measured under normal test conditions.

The video bandwidth shall be set to 3 times the resolution bandwidth. Video averaging is not permitted. Where practical, a sampling detector shall be used since a peak or, peak hold, may produce a wider bandwidth than actual.

The trace data points are recovered and are directly summed in linear terms. The recovered amplitude data points, beginning at the lowest frequency, are placed in a running sum until 0.5% of the total is reached and that frequency recorded. The process is repeated for the highest frequency data points. This frequency is recorded.

7.5. Test Result

Model Number	NANO		
Test Item	6dB RF Bandwidth		
Test Mode	Mode 2: AR9271L_ IEEE 802.11b link mode Mode 3: AR9271L_ IEEE 802.11g link mode Mode 4: AR9271L_ IEEE 802.11n 2.4GHz 20MHz link mode Mode 5: AR9271L_ IEEE 802.11n 2.4GHz 40MHz link mode Mode 7: AR9331_ IEEE 802.11b link mode Mode 8: AR9331_ IEEE 802.11g link mode Mode 9: AR9331_ IEEE 802.11n 2.4GHz 20MHz link mode Mode 10: AR9331_ IEEE 802.11n 2.4GHz 40MHz link mode		
Date of Test	10/29/2015	Test Site	TE05
Test Mode	Frequency (MHz)	Measurement (MHz)	Limit (MHz)
Mode 2	2412	12.132	> 0.500
	2437	12.125	> 0.500
	2462	12.120	> 0.500
Mode 3	2412	16.443	> 0.500
	2437	16.461	> 0.500
	2462	16.465	> 0.500
Mode 4	2412	17.641	> 0.500
	2437	17.622	> 0.500
	2462	17.662	> 0.500
Mode 5	2422	36.331	> 0.500
	2437	36.275	> 0.500
	2452	36.102	> 0.500
Mode 7	2412	7.080	> 0.500
	2437	7.518	> 0.500
	2462	7.086	> 0.500
Mode 8	2412	16.350	> 0.500
	2437	16.360	> 0.500
	2462	16.350	> 0.500
Mode 9	2412	17.570	> 0.500
	2437	17.570	> 0.500
	2462	17.580	> 0.500
Mode 10	2422	35.110	> 0.500
	2437	35.100	> 0.500
	2452	35.120	> 0.500

7.6. Test Graphs

Mode 2: AR9271L_ IEEE 802.11b link mode	
2412	<p>Agilent R T</p> <p>Ch Freq 2.412 GHz Trig Free</p> <p>Occupied Bandwidth</p> <p>Ref 15 dBm Atten 15 dB</p> <p>#Peak Log 10 dB/ Offset 10.8 dB</p> <p>Center 2.412 GHz Span 30 MHz</p> <p>#Res BW 100 kHz #VBW 300 kHz Sweep 4 ms (401 pts)</p> <p>Occupied Bandwidth 15.6350 MHz</p> <p>Occ BW % Pwr 99.00 % x dB -6.00 dB</p> <p>Transmit Freq Error -8.358 kHz</p> <p>x dB Bandwidth 12.132 MHz</p> <p>Freq/Channel</p> <p>Center Freq 2.41200000 GHz</p> <p>Start Freq 2.39700000 GHz</p> <p>Stop Freq 2.42700000 GHz</p> <p>CF Step 3.00000000 MHz Auto Man</p> <p>Freq Offset 0.00000000 Hz</p> <p>Signal Track On Off</p>
2437	<p>Agilent R T</p> <p>Ch Freq 2.437 GHz Trig Free</p> <p>Occupied Bandwidth</p> <p>Ref 15 dBm Atten 15 dB</p> <p>#Peak Log 10 dB/ Offset 10.8 dB</p> <p>Center 2.437 GHz Span 30 MHz</p> <p>#Res BW 100 kHz #VBW 300 kHz Sweep 4 ms (401 pts)</p> <p>Occupied Bandwidth 15.5746 MHz</p> <p>Occ BW % Pwr 99.00 % x dB -6.00 dB</p> <p>Transmit Freq Error -59.637 kHz</p> <p>x dB Bandwidth 12.125 MHz</p> <p>Freq/Channel</p> <p>Center Freq 2.43700000 GHz</p> <p>Start Freq 2.42200000 GHz</p> <p>Stop Freq 2.45200000 GHz</p> <p>CF Step 3.00000000 MHz Auto Man</p> <p>Freq Offset 0.00000000 Hz</p> <p>Signal Track On Off</p>
2462	<p>Agilent R T</p> <p>Ch Freq 2.462 GHz Trig Free</p> <p>Occupied Bandwidth</p> <p>Ref 15 dBm Atten 15 dB</p> <p>#Peak Log 10 dB/ Offset 10.8 dB</p> <p>Center 2.462 GHz Span 30 MHz</p> <p>#Res BW 100 kHz #VBW 300 kHz Sweep 4 ms (401 pts)</p> <p>Occupied Bandwidth 15.7216 MHz</p> <p>Occ BW % Pwr 99.00 % x dB -6.00 dB</p> <p>Transmit Freq Error -32.116 kHz</p> <p>x dB Bandwidth 12.120 MHz</p> <p>Freq/Channel</p> <p>Center Freq 2.46200000 GHz</p> <p>Start Freq 2.44700000 GHz</p> <p>Stop Freq 2.47700000 GHz</p> <p>CF Step 3.00000000 MHz Auto Man</p> <p>Freq Offset 0.00000000 Hz</p> <p>Signal Track On Off</p>

Mode 3: AR9271L_ IEEE 802.11g link mode	
2412	
2437	
2462	

Mode 4: AR9271L_ IEEE 802.11n 2.4GHz 20MHz link mode

<p>2412</p>	<p>Agilent R T</p> <p>Ch Freq 2.412 GHz Trig Free</p> <p>Occupied Bandwidth</p> <p>Ref 15 dBm Atten 15 dB</p> <p>#Peak Log 10 dB/ Offset 10.8 dB</p> <p>Center 2.412 GHz Span 30 MHz #Res BW 100 kHz #VBW 300 kHz Sweep 4 ms (401 pts)</p> <p>Occupied Bandwidth 17.7571 MHz</p> <p>Occ BW % Pwr 99.00 % x dB -6.00 dB</p> <p>Transmit Freq Error -3.382 kHz x dB Bandwidth 17.641 MHz</p> <p>Freq/Channel</p> <p>Center Freq 2.41200000 GHz</p> <p>Start Freq 2.39700000 GHz</p> <p>Stop Freq 2.42700000 GHz</p> <p>CF Step 3.00000000 MHz Auto Man</p> <p>Freq Offset 0.00000000 Hz</p> <p>Signal Track On Off</p>
<p>2437</p>	<p>Agilent R T</p> <p>Ch Freq 2.437 GHz Trig Free</p> <p>Occupied Bandwidth</p> <p>Ref 15 dBm Atten 15 dB</p> <p>#Peak Log 10 dB/ Offset 10.8 dB</p> <p>Center 2.437 GHz Span 30 MHz #Res BW 100 kHz #VBW 300 kHz Sweep 4 ms (401 pts)</p> <p>Occupied Bandwidth 17.7280 MHz</p> <p>Occ BW % Pwr 99.00 % x dB -6.00 dB</p> <p>Transmit Freq Error -9.148 kHz x dB Bandwidth 17.622 MHz</p> <p>Freq/Channel</p> <p>Center Freq 2.43700000 GHz</p> <p>Start Freq 2.42200000 GHz</p> <p>Stop Freq 2.45200000 GHz</p> <p>CF Step 3.00000000 MHz Auto Man</p> <p>Freq Offset 0.00000000 Hz</p> <p>Signal Track On Off</p>
<p>2462</p>	<p>Agilent R T</p> <p>Ch Freq 2.462 GHz Trig Free</p> <p>Occupied Bandwidth</p> <p>Ref 15 dBm Atten 15 dB</p> <p>#Peak Log 10 dB/ Offset 10.8 dB</p> <p>Center 2.462 GHz Span 30 MHz #Res BW 100 kHz #VBW 300 kHz Sweep 4 ms (401 pts)</p> <p>Occupied Bandwidth 17.7312 MHz</p> <p>Occ BW % Pwr 99.00 % x dB -6.00 dB</p> <p>Transmit Freq Error -6.909 kHz x dB Bandwidth 17.662 MHz</p> <p>Freq/Channel</p> <p>Center Freq 2.46200000 GHz</p> <p>Start Freq 2.44700000 GHz</p> <p>Stop Freq 2.47700000 GHz</p> <p>CF Step 3.00000000 MHz Auto Man</p> <p>Freq Offset 0.00000000 Hz</p> <p>Signal Track On Off</p>

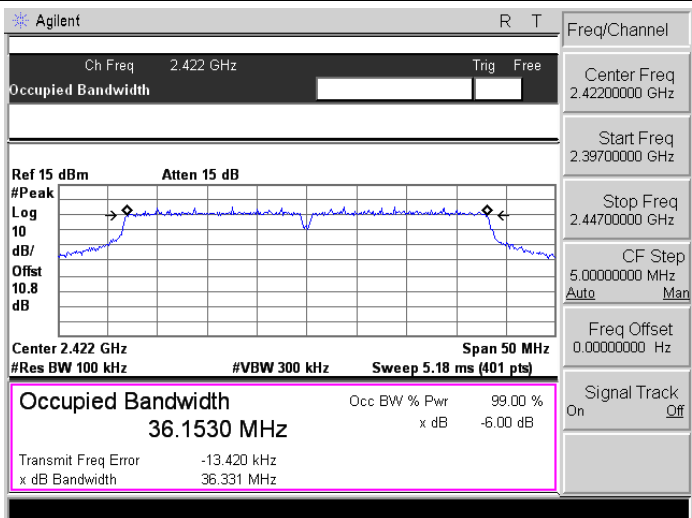
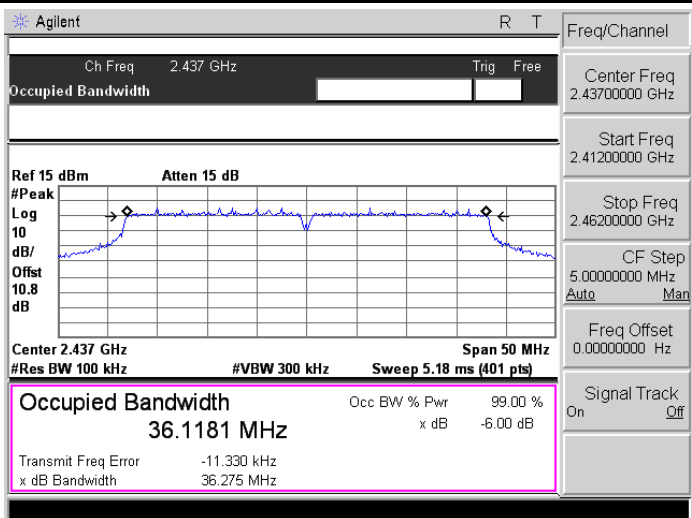
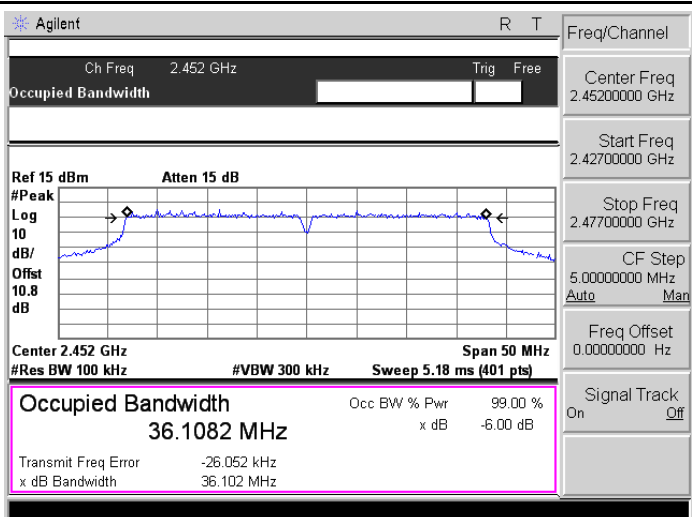
Mode 5: AR9271L_IEEE 802.11n 2.4GHz 40MHz link mode	
2422	 <p>Agilent R T</p> <p>Ch Freq 2.422 GHz Trig Free</p> <p>Occupied Bandwidth</p> <p>Ref 15 dBm Atten 15 dB</p> <p>#Peak Log 10 dB/ Offst 10.8 dB</p> <p>Center 2.422 GHz Span 50 MHz #Res BW 100 kHz #VBW 300 kHz Sweep 5.18 ms (401 pts)</p> <p>Occupied Bandwidth Occ BW % Pwr 99.00 % 36.1530 MHz x dB -6.00 dB</p> <p>Transmit Freq Error -13.420 kHz x dB Bandwidth 36.331 MHz</p> <p>Freq/Channel</p> <p>Center Freq 2.4220000 GHz</p> <p>Start Freq 2.39700000 GHz</p> <p>Stop Freq 2.44700000 GHz</p> <p>CF Step 5.00000000 MHz Auto Man</p> <p>Freq Offset 0.00000000 Hz</p> <p>Signal Track On Off</p>
2437	 <p>Agilent R T</p> <p>Ch Freq 2.437 GHz Trig Free</p> <p>Occupied Bandwidth</p> <p>Ref 15 dBm Atten 15 dB</p> <p>#Peak Log 10 dB/ Offst 10.8 dB</p> <p>Center 2.437 GHz Span 50 MHz #Res BW 100 kHz #VBW 300 kHz Sweep 5.18 ms (401 pts)</p> <p>Occupied Bandwidth Occ BW % Pwr 99.00 % 36.1181 MHz x dB -6.00 dB</p> <p>Transmit Freq Error -11.330 kHz x dB Bandwidth 36.275 MHz</p> <p>Freq/Channel</p> <p>Center Freq 2.4370000 GHz</p> <p>Start Freq 2.41200000 GHz</p> <p>Stop Freq 2.46200000 GHz</p> <p>CF Step 5.00000000 MHz Auto Man</p> <p>Freq Offset 0.00000000 Hz</p> <p>Signal Track On Off</p>
2452	 <p>Agilent R T</p> <p>Ch Freq 2.452 GHz Trig Free</p> <p>Occupied Bandwidth</p> <p>Ref 15 dBm Atten 15 dB</p> <p>#Peak Log 10 dB/ Offst 10.8 dB</p> <p>Center 2.452 GHz Span 50 MHz #Res BW 100 kHz #VBW 300 kHz Sweep 5.18 ms (401 pts)</p> <p>Occupied Bandwidth Occ BW % Pwr 99.00 % 36.1082 MHz x dB -6.00 dB</p> <p>Transmit Freq Error -26.052 kHz x dB Bandwidth 36.102 MHz</p> <p>Freq/Channel</p> <p>Center Freq 2.4520000 GHz</p> <p>Start Freq 2.42700000 GHz</p> <p>Stop Freq 2.47700000 GHz</p> <p>CF Step 5.00000000 MHz Auto Man</p> <p>Freq Offset 0.00000000 Hz</p> <p>Signal Track On Off</p>

Mode 7: AR9331_ IEEE 802.11b link mode

<p>2412</p>	<p>Agilent Spectrum Analyzer - Occupied BW</p> <p>Center Freq: 2.41200000 GHz Trig: Free Run #Attenu: 10 dB Radio Std: None Avg/Hold: >10/10 Radio Device: BTS</p> <p>Ref Offset 11 dB Ref 15.00 dBm</p> <p>Center 2.412 GHz #Res BW 100 kHz #VBW 300 kHz Span 30 MHz Sweep 3.733 ms</p> <p>Occupied Bandwidth 11.969 MHz Total Power 14.2 dBm</p> <p>Transmit Freq Error 31.003 kHz OBW Power 99.00 % x dB Bandwidth 7.080 MHz x dB -6.00 dB</p> <p>Frequency: 2.41200000 GHz CF Step: 3.000000 MHz Freq Offset: 0 Hz</p>
<p>2437</p>	<p>Agilent Spectrum Analyzer - Occupied BW</p> <p>Center Freq: 2.43700000 GHz Trig: Free Run #Attenu: 10 dB Radio Std: None Avg/Hold: >10/10 Radio Device: BTS</p> <p>Ref Offset 11 dB Ref 15.00 dBm</p> <p>Center 2.437 GHz #Res BW 100 kHz #VBW 300 kHz Span 30 MHz Sweep 3.733 ms</p> <p>Occupied Bandwidth 11.985 MHz Total Power 14.1 dBm</p> <p>Transmit Freq Error 2.723 kHz OBW Power 99.00 % x dB Bandwidth 7.518 MHz x dB -6.00 dB</p> <p>Frequency: 2.43700000 GHz CF Step: 3.000000 MHz Freq Offset: 0 Hz</p>
<p>2462</p>	<p>Agilent Spectrum Analyzer - Occupied BW</p> <p>Center Freq: 2.46200000 GHz Trig: Free Run #Attenu: 10 dB Radio Std: None Avg/Hold: >10/10 Radio Device: BTS</p> <p>Ref Offset 11 dB Ref 15.00 dBm</p> <p>Center 2.462 GHz #Res BW 100 kHz #VBW 300 kHz Span 30 MHz Sweep 3.733 ms</p> <p>Occupied Bandwidth 11.949 MHz Total Power 13.6 dBm</p> <p>Transmit Freq Error -18.679 kHz OBW Power 99.00 % x dB Bandwidth 7.086 MHz x dB -6.00 dB</p> <p>Frequency: 2.46200000 GHz CF Step: 3.000000 MHz Freq Offset: 0 Hz</p>

Mode 8: AR9331_ IEEE 802.11g link mode

<p>2412</p>	<p>Agilent Spectrum Analyzer - Occupied BW</p> <p>Center Freq: 2.412000000 GHz Trig: Free Run #Attenu: 10 dB</p> <p>Ref Offset 11 dB Ref 15.00 dBm</p> <p>Center 2.412 GHz #Res BW 100 kHz</p> <p>Span 30 MHz Sweep 3.733 ms</p> <p>Occupied Bandwidth 16.436 MHz Total Power 17.6 dBm</p> <p>Transmit Freq Error 16.434 kHz OBW Power 99.00 %</p> <p>x dB Bandwidth 16.35 MHz x dB -6.00 dB</p>
<p>2437</p>	<p>Agilent Spectrum Analyzer - Occupied BW</p> <p>Center Freq: 2.437000000 GHz Trig: Free Run #Attenu: 10 dB</p> <p>Ref Offset 11 dB Ref 15.00 dBm</p> <p>Center 2.437 GHz #Res BW 100 kHz</p> <p>Span 30 MHz Sweep 3.733 ms</p> <p>Occupied Bandwidth 16.431 MHz Total Power 17.3 dBm</p> <p>Transmit Freq Error -1.387 kHz OBW Power 99.00 %</p> <p>x dB Bandwidth 16.36 MHz x dB -6.00 dB</p>
<p>2462</p>	<p>Agilent Spectrum Analyzer - Occupied BW</p> <p>Center Freq: 2.462000000 GHz Trig: Free Run #Attenu: 10 dB</p> <p>Ref Offset 11 dB Ref 15.00 dBm</p> <p>Center 2.462 GHz #Res BW 100 kHz</p> <p>Span 30 MHz Sweep 3.733 ms</p> <p>Occupied Bandwidth 16.419 MHz Total Power 17.3 dBm</p> <p>Transmit Freq Error -9.357 kHz OBW Power 99.00 %</p> <p>x dB Bandwidth 16.35 MHz x dB -6.00 dB</p>

Mode 9: AR9331_ IEEE 802.11n 2.4GHz 20MHz link mode

<p>2412</p>	<p>Agilent Spectrum Analyzer - Occupied BW</p> <p>Center Freq: 2.412000000 GHz Trig: Free Run #Attenu: 10 dB</p> <p>Ref Offset 11 dB Ref 15.00 dBm</p> <p>Center 2.412 GHz #Res BW 100 kHz</p> <p>Span 30 MHz Sweep 3.733 ms</p> <p>Occupied Bandwidth 17.627 MHz Total Power 17.5 dBm</p> <p>Transmit Freq Error 16.461 kHz x dB Bandwidth 17.57 MHz</p> <p>OBW Power 99.00 % x dB -6.00 dB</p> <p>Frequency: 2.412000000 GHz Center Freq: 2.412000000 GHz CF Step: 3.000000 MHz Freq Offset: 0 Hz</p>
<p>2437</p>	<p>Agilent Spectrum Analyzer - Occupied BW</p> <p>Center Freq: 2.437000000 GHz Trig: Free Run #Attenu: 10 dB</p> <p>Ref Offset 11 dB Ref 15.00 dBm</p> <p>Center 2.437 GHz #Res BW 100 kHz</p> <p>Span 30 MHz Sweep 3.733 ms</p> <p>Occupied Bandwidth 17.619 MHz Total Power 17.9 dBm</p> <p>Transmit Freq Error 2.039 kHz x dB Bandwidth 17.57 MHz</p> <p>OBW Power 99.00 % x dB -6.00 dB</p> <p>Frequency: 2.437000000 GHz Center Freq: 2.437000000 GHz CF Step: 3.000000 MHz Freq Offset: 0 Hz</p>
<p>2462</p>	<p>Agilent Spectrum Analyzer - Occupied BW</p> <p>Center Freq: 2.462000000 GHz Trig: Free Run #Attenu: 10 dB</p> <p>Ref Offset 11 dB Ref 15.00 dBm</p> <p>Center 2.462 GHz #Res BW 100 kHz</p> <p>Span 30 MHz Sweep 3.733 ms</p> <p>Occupied Bandwidth 17.628 MHz Total Power 16.8 dBm</p> <p>Transmit Freq Error -5.501 kHz x dB Bandwidth 17.58 MHz</p> <p>OBW Power 99.00 % x dB -6.00 dB</p> <p>Frequency: 2.462000000 GHz Center Freq: 2.462000000 GHz CF Step: 3.000000 MHz Freq Offset: 0 Hz</p>

Mode 10: AR9331_ IEEE 802.11n 2.4GHz 40MHz link mode

<p>2422</p>	<p>Agilent Spectrum Analyzer - Occupied BW</p> <p>Center Freq: 2.42200000 GHz Trig: Free Run #Attenu: 10 dB</p> <p>Ref Offset 11 dB Ref 15.00 dBm</p> <p>Center 2.422 GHz #Res BW 100 kHz</p> <p>Span 50 MHz Sweep 0.2 ms</p> <p>Occupied Bandwidth 35.797 MHz Total Power 17.1 dBm</p> <p>Transmit Freq Error 22.850 kHz OBW Power 99.00 %</p> <p>x dB Bandwidth 35.11 MHz x dB -6.00 dB</p>
<p>2437</p>	<p>Agilent Spectrum Analyzer - Occupied BW</p> <p>Center Freq: 2.43700000 GHz Trig: Free Run #Attenu: 10 dB</p> <p>Ref Offset 11 dB Ref 15.00 dBm</p> <p>Center 2.437 GHz #Res BW 100 kHz</p> <p>Span 50 MHz Sweep 0.2 ms</p> <p>Occupied Bandwidth 35.813 MHz Total Power 16.6 dBm</p> <p>Transmit Freq Error 6.895 kHz OBW Power 99.00 %</p> <p>x dB Bandwidth 35.10 MHz x dB -6.00 dB</p>
<p>2452</p>	<p>Agilent Spectrum Analyzer - Occupied BW</p> <p>Center Freq: 2.45200000 GHz Trig: Free Run #Attenu: 10 dB</p> <p>Ref Offset 11 dB Ref 15.00 dBm</p> <p>Center 2.452 GHz #Res BW 100 kHz</p> <p>Span 50 MHz Sweep 0.2 ms</p> <p>Occupied Bandwidth 35.818 MHz Total Power 16.5 dBm</p> <p>Transmit Freq Error -43.957 kHz OBW Power 99.00 %</p> <p>x dB Bandwidth 35.12 MHz x dB -6.00 dB</p>

8 Maximum Power Density Measurement

8.1. Limit

For digitally modulated systems, the power spectral density conducted from the intentional radiator to the antenna shall not be greater than 8 dBm in any 3 kHz band during any time interval of continuous transmission.

8.2. Test Setup

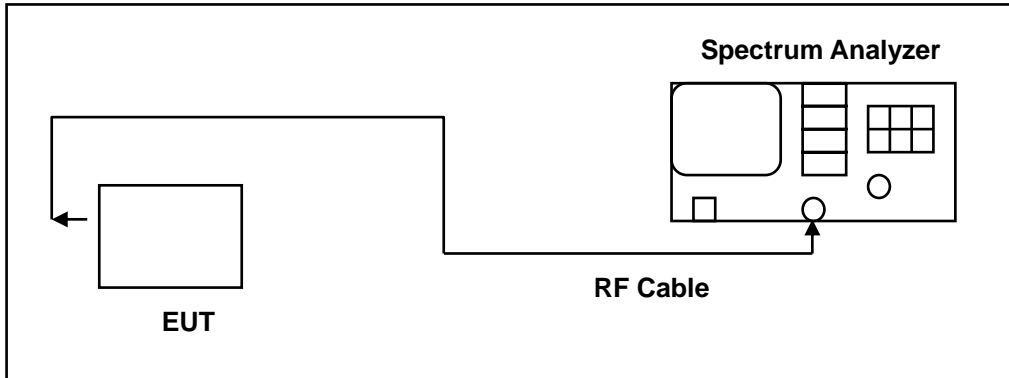

8.3. Test Instruments

Equipment	Manufacturer	Model Number	Serial Number	Cal. Date	Remark
Spectrum Analyzer	Agilent	E4445A	MY45300744	12/16/2014	(1)
Test Site	ATL	TE05	TE05	N.C.R.	-----

Remark: (1) Calibration period 1 year. (2) Calibration period 2 years. (3) Calibration period 3 years.

Note: N.C.R. = No Calibration Request.

8.4. Test Procedure

The EUT tested to DTS test procedure of KDB558074D01 for compliance to FCC 47CFR 15.247 requirements.

1. Set analyzer center frequency to DTS channel center frequency.
2. Set the span to 1.5 times the DTS bandwidth.
3. Set the RBW to: $3 \text{ kHz} \leq \text{RBW} \leq 100 \text{ kHz}$.
4. Set the VBW $\geq 3 \times \text{RBW}$.
5. Detector = peak.
6. Sweep time = auto couple.
7. Trace mode = max hold.
8. Allow trace to fully stabilize.
9. Use the peak marker function to determine the maximum amplitude level within the RBW.
10. If measured value exceeds limit, reduce RBW (no less than 3 kHz) and repeat.

8.5. Test Result

Model Number	NANO		
Test Item	Maximum Power Density		
Test Mode	Mode 2: AR9271L_ IEEE 802.11b link mode Mode 3: AR9271L_ IEEE 802.11g link mode Mode 4: AR9271L_ IEEE 802.11n 2.4GHz 20MHz link mode Mode 5: AR9271L_ IEEE 802.11n 2.4GHz 40MHz link mode Mode 7: AR9331_ IEEE 802.11b link mode Mode 8: AR9331_ IEEE 802.11g link mode Mode 9: AR9331_ IEEE 802.11n 2.4GHz 20MHz link mode Mode 10: AR9331_ IEEE 802.11n 2.4GHz 40MHz link mode		
Date of Test	10/29/2015	Test Site	TE05
Test Mode	Frequency (MHz)	Measurement (dBm/3KHz)	Limit (dBm/3KHz)
Mode 2	2412	-8.235	< 8
	2437	-7.884	< 8
	2462	-8.821	< 8
Mode 3	2412	-8.481	< 8
	2437	-8.414	< 8
	2462	-9.788	< 8
Mode 4	2412	-9.669	< 8
	2437	-9.453	< 8
	2462	-10.020	< 8
Mode 5	2422	-13.490	< 8
	2437	-10.860	< 8
	2452	-12.270	< 8
Mode 6	2412	-14.694	< 8
	2437	-12.287	< 8
	2462	-14.587	< 8
Mode 7	2412	-18.560	< 8
	2437	-14.742	< 8
	2462	-14.593	< 8
Mode 8	2412	-15.276	< 8
	2437	-13.749	< 8
	2462	-11.041	< 8
Mode 9	2422	-17.539	< 8
	2437	-17.729	< 8
	2452	-17.296	< 8

8.6. Test Graphs

Mode 2: AR9271L_ IEEE 802.11b link mode	
2412	<p>Agilent R T Ref 10 dBm Atten 10 dB Mkr1 2.4127600 GHz -8.235 dBm Peak Log 10 dB/Offst 10.8 dB M1 S2 S3 FC AA Center 2.412 GHz Span 19 MHz #Res BW 3 kHz #VBW 10 kHz Sweep 2.173 s (401 pts)</p> <p>Freq/Channel Center Freq 2.41200000 GHz Start Freq 2.40250000 GHz Stop Freq 2.42150000 GHz CF Step 1.90000000 MHz Auto Man Freq Offset 0.00000000 Hz Signal Track On Off</p>
2437	<p>Agilent R T Ref 10 dBm Atten 10 dB Mkr1 2.4378075 GHz -7.884 dBm Peak Log 10 dB/Offst 10.8 dB M1 S2 S3 FC AA Center 2.437 GHz Span 19 MHz #Res BW 3 kHz #VBW 10 kHz Sweep 2.173 s (401 pts)</p> <p>Freq/Channel Center Freq 2.43700000 GHz Start Freq 2.42750000 GHz Stop Freq 2.44650000 GHz CF Step 1.90000000 MHz Auto Man Freq Offset 0.00000000 Hz Signal Track On Off</p>
2462	<p>Agilent R T Ref 10 dBm Atten 10 dB Mkr1 2.4594825 GHz -8.821 dBm Peak Log 10 dB/Offst 10.8 dB M1 S2 S3 FC AA Center 2.462 GHz Span 19 MHz #Res BW 3 kHz #VBW 10 kHz Sweep 2.173 s (401 pts)</p> <p>Freq/Channel Center Freq 2.46200000 GHz Start Freq 2.45250000 GHz Stop Freq 2.47150000 GHz CF Step 1.90000000 MHz Auto Man Freq Offset 0.00000000 Hz Signal Track On Off</p>

Mode 3: AR9271L_ IEEE 802.11g link mode

2412

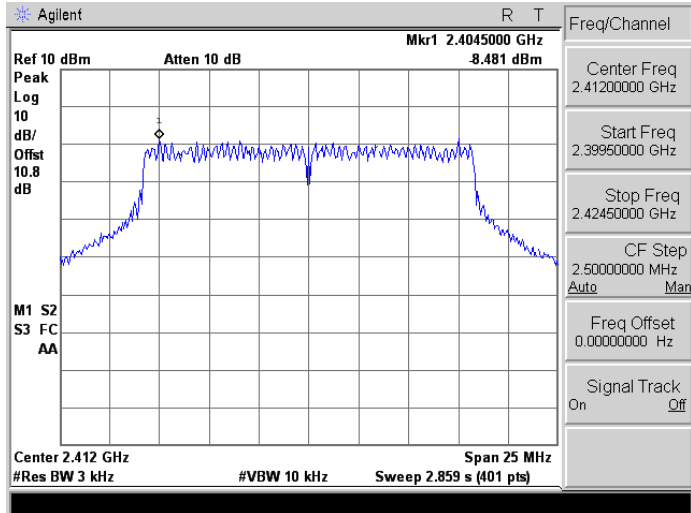

2437

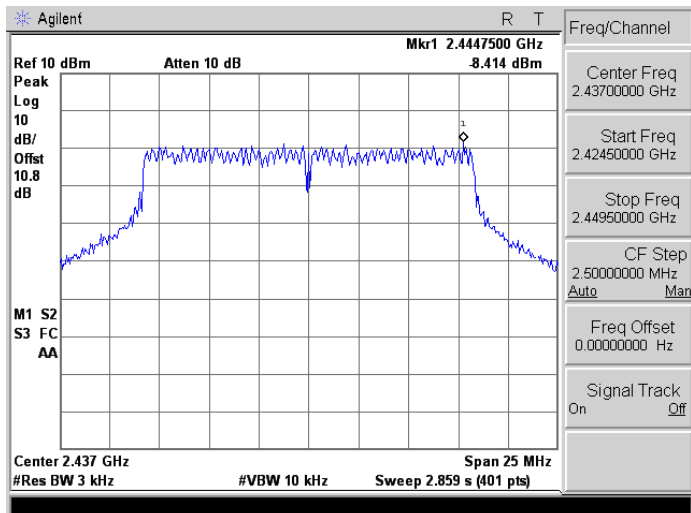

2462

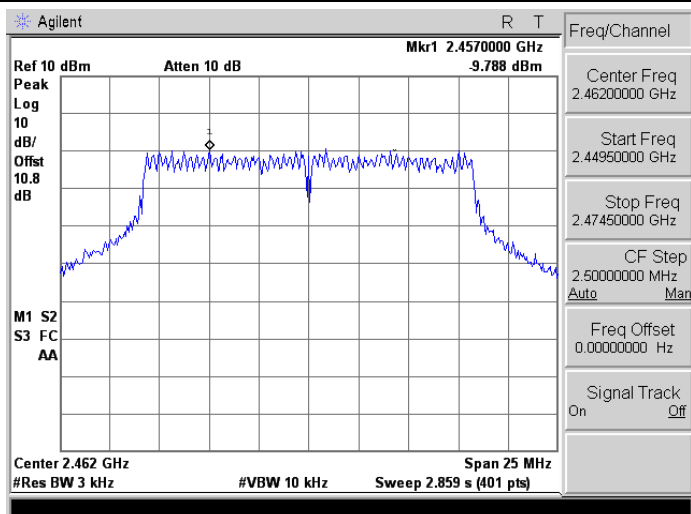

Mode 4: AR9271L_IEEE 802.11n 2.4GHz 20MHz link mode

<p>2412</p>	
<p>2437</p>	
<p>2462</p>	

Mode 5: AR9271L_ IEEE 802.11n 2.4GHz 40MHz link mode

<p>2422</p>	<p>Agilent R T</p> <p>Ref 10 dBm Atten 10 dB Mkr1 2.42475 GHz -13.49 dBm</p> <p>Peak Log 10 dB/Offst 10.8 dB</p> <p>M1 S2 S3 FC AA</p> <p>Center 2.422 GHz Span 55 MHz #Res BW 3 kHz #VBW 10 kHz Sweep 6.29 s (401 pts)</p> <p>Freq/Channel</p> <p>Center Freq 2.4220000 GHz</p> <p>Start Freq 2.39450000 GHz</p> <p>Stop Freq 2.44950000 GHz</p> <p>CF Step 5.50000000 MHz Auto Man</p> <p>Freq Offset 0.00000000 Hz</p> <p>Signal Track On Off</p>
<p>2437</p>	<p>Agilent R T</p> <p>Ref 10 dBm Atten 10 dB Mkr1 2.43700 GHz -10.86 dBm</p> <p>Peak Log 10 dB/Offst 10.8 dB</p> <p>M1 S2 S3 FC AA</p> <p>Center 2.437 GHz Span 55 MHz #Res BW 3 kHz #VBW 10 kHz Sweep 6.29 s (401 pts)</p> <p>Freq/Channel</p> <p>Center Freq 2.43700000 GHz</p> <p>Start Freq 2.40950000 GHz</p> <p>Stop Freq 2.46450000 GHz</p> <p>CF Step 5.50000000 MHz Auto Man</p> <p>Freq Offset 0.00000000 Hz</p> <p>Signal Track On Off</p>
<p>2452</p>	<p>Agilent R T</p> <p>Ref 10 dBm Atten 10 dB Mkr1 2.46451 GHz -12.27 dBm</p> <p>Peak Log 10 dB/Offst 10.8 dB</p> <p>M1 S2 S3 FC AA</p> <p>Center 2.452 GHz Span 55 MHz #Res BW 3 kHz #VBW 10 kHz Sweep 6.29 s (401 pts)</p> <p>Freq/Channel</p> <p>Center Freq 2.45200000 GHz</p> <p>Start Freq 2.42450000 GHz</p> <p>Stop Freq 2.47950000 GHz</p> <p>CF Step 5.50000000 MHz Auto Man</p> <p>Freq Offset 0.00000000 Hz</p> <p>Signal Track On Off</p>

Mode 7: AR9331_ IEEE 802.11b link mode

<p>2412</p>	<p>Agilent Spectrum Analyzer - Swept SA</p> <p>PRO: Wide IF Gain: 0.0 dB Trig: Free Run Atten: 14 dB Avg Type: Log-Pwr AvgHold: 24/100</p> <p>Mkr1 2.410 776 GHz -14.694 dBm</p> <p>Ref Offset 11 dB Ref 15.00 dBm</p> <p>Center 2.412000 GHz #Res BW 3.0 kHz #VBW 10 kHz Span 12.00 MHz Sweep 1.265 s (1001 pts)</p> <p>Frequency: Auto Tune Center Freq: 2.412000000 GHz Start Freq: 2.406000000 GHz Stop Freq: 2.418000000 GHz CF Step: 1.200000 MHz (Auto) Freq Offset: 0 Hz</p>
<p>2437</p>	<p>Agilent Spectrum Analyzer - Swept SA</p> <p>PRO: Wide IF Gain: 0.0 dB Trig: Free Run Atten: 14 dB Avg Type: Log-Pwr AvgHold: 21/100</p> <p>Mkr1 2.437 948 GHz -12.287 dBm</p> <p>Ref Offset 11 dB Ref 15.00 dBm</p> <p>Center 2.437000 GHz #Res BW 3.0 kHz #VBW 10 kHz Span 12.00 MHz Sweep 1.265 s (1001 pts)</p> <p>Frequency: Auto Tune Center Freq: 2.437000000 GHz Start Freq: 2.431000000 GHz Stop Freq: 2.443000000 GHz CF Step: 1.200000 MHz (Auto) Freq Offset: 0 Hz</p>
<p>2462</p>	<p>Agilent Spectrum Analyzer - Swept SA</p> <p>PRO: Wide IF Gain: 0.0 dB Trig: Free Run Atten: 14 dB Avg Type: Log-Pwr AvgHold: 9/100</p> <p>Mkr1 2.462 720 GHz -14.587 dBm</p> <p>Ref Offset 11 dB Ref 15.00 dBm</p> <p>Center 2.462000 GHz #Res BW 3.0 kHz #VBW 10 kHz Span 12.00 MHz Sweep 1.265 s (1001 pts)</p> <p>Frequency: Auto Tune Center Freq: 2.462000000 GHz Start Freq: 2.456000000 GHz Stop Freq: 2.468000000 GHz CF Step: 1.200000 MHz (Auto) Freq Offset: 0 Hz</p>

Mode 8: AR9331_ IEEE 802.11g link mode

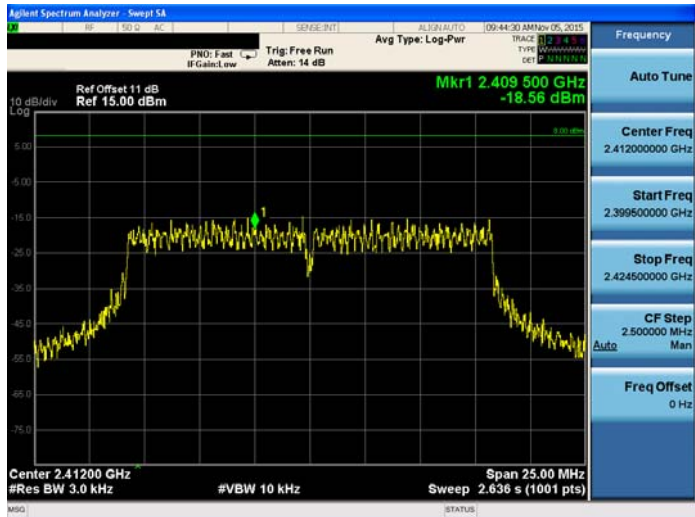
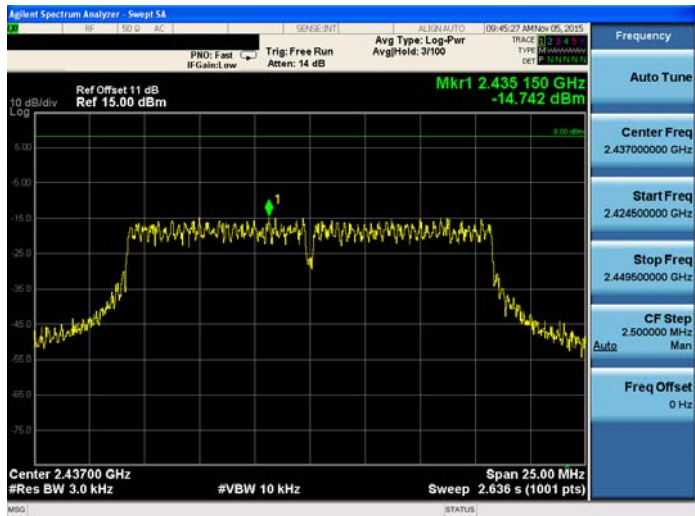
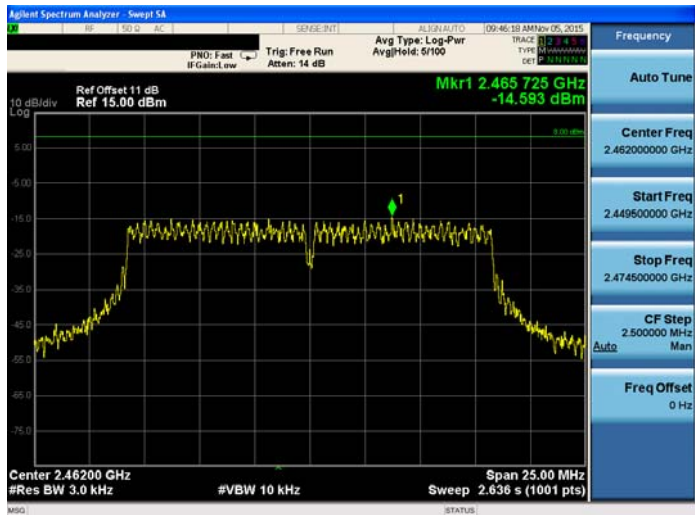
<p>2412</p>	
<p>2437</p>	
<p>2462</p>	

Mode 9: AR9331_ IEEE 802.11n 2.4GHz 20MHz link mode

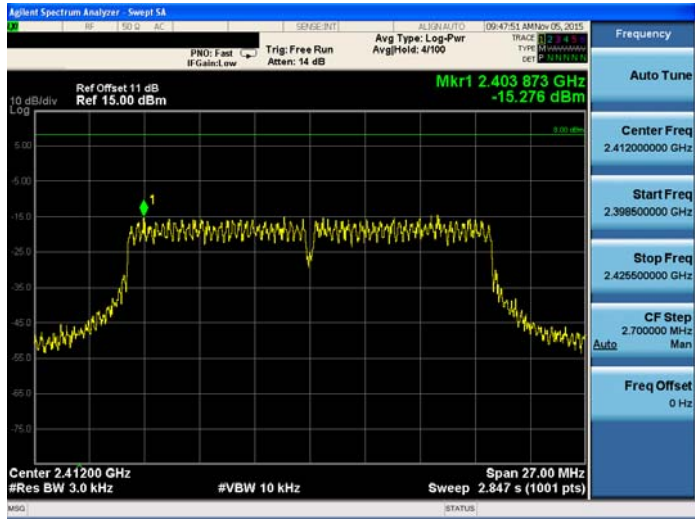
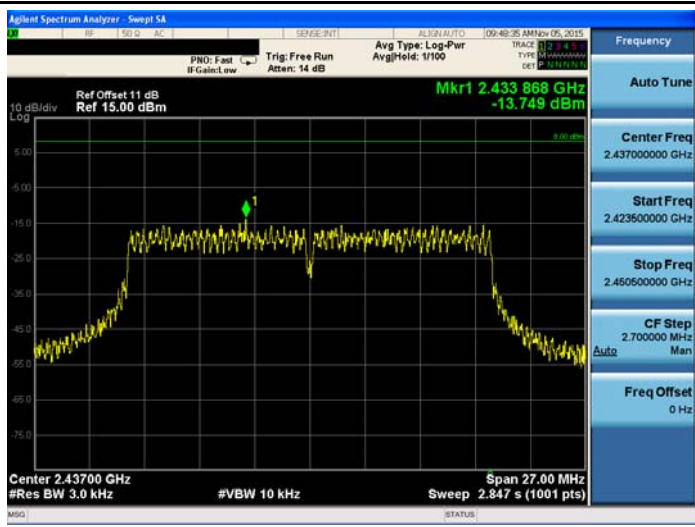
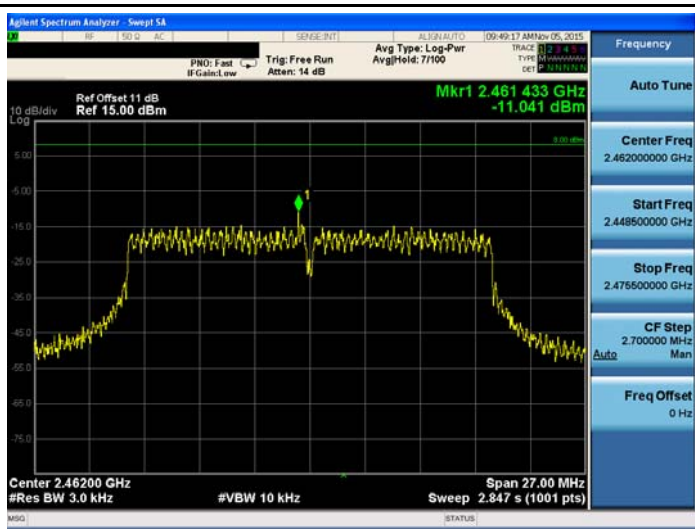
<p>2412</p>	 <p>Agilent Spectrum Analyzer - Swept SA</p> <p>Center 2.41200 GHz #Res BW 3.0 kHz #VBW 10 kHz Sweep 2.847 s (1001 pts)</p> <p>Mkr1 2.403 873 GHz -15.276 dBm</p> <p>Ref Offset 11 dB Ref 15.00 dBm</p> <p>Center Freq: 2.41200000 GHz</p> <p>Start Freq: 2.398600000 GHz</p> <p>Stop Freq: 2.425600000 GHz</p> <p>CF Step: 2.700000 MHz</p> <p>Freq Offset: 0 Hz</p>
<p>2437</p>	 <p>Agilent Spectrum Analyzer - Swept SA</p> <p>Center 2.43700 GHz #Res BW 3.0 kHz #VBW 10 kHz Sweep 2.847 s (1001 pts)</p> <p>Mkr1 2.433 868 GHz -13.749 dBm</p> <p>Ref Offset 11 dB Ref 15.00 dBm</p> <p>Center Freq: 2.43700000 GHz</p> <p>Start Freq: 2.423600000 GHz</p> <p>Stop Freq: 2.450600000 GHz</p> <p>CF Step: 2.700000 MHz</p> <p>Freq Offset: 0 Hz</p>
<p>2462</p>	 <p>Agilent Spectrum Analyzer - Swept SA</p> <p>Center 2.46200 GHz #Res BW 3.0 kHz #VBW 10 kHz Sweep 2.847 s (1001 pts)</p> <p>Mkr1 2.461 433 GHz -11.041 dBm</p> <p>Ref Offset 11 dB Ref 15.00 dBm</p> <p>Center Freq: 2.46200000 GHz</p> <p>Start Freq: 2.448600000 GHz</p> <p>Stop Freq: 2.475600000 GHz</p> <p>CF Step: 2.700000 MHz</p> <p>Freq Offset: 0 Hz</p>

Mode 10: AR9331_ IEEE 802.11n 2.4GHz 40MHz link mode

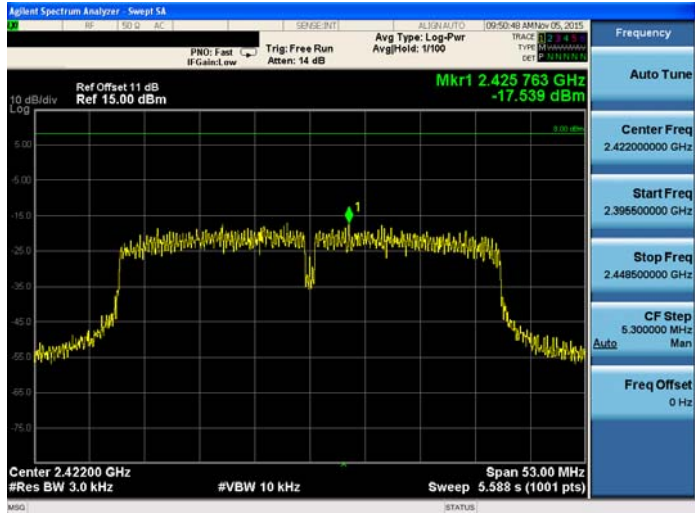
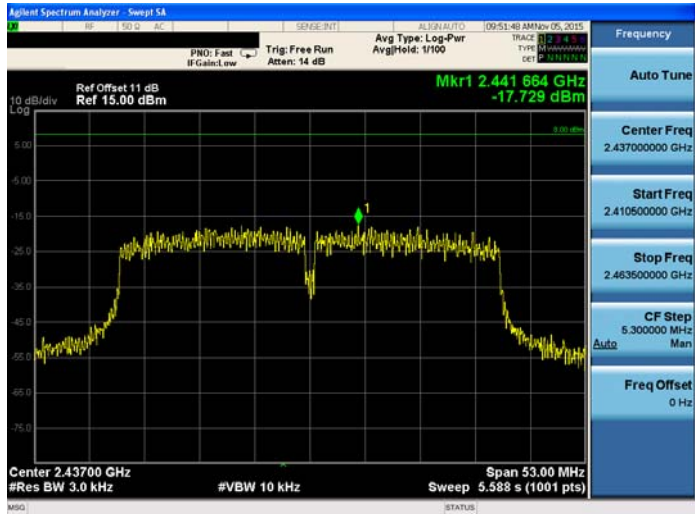
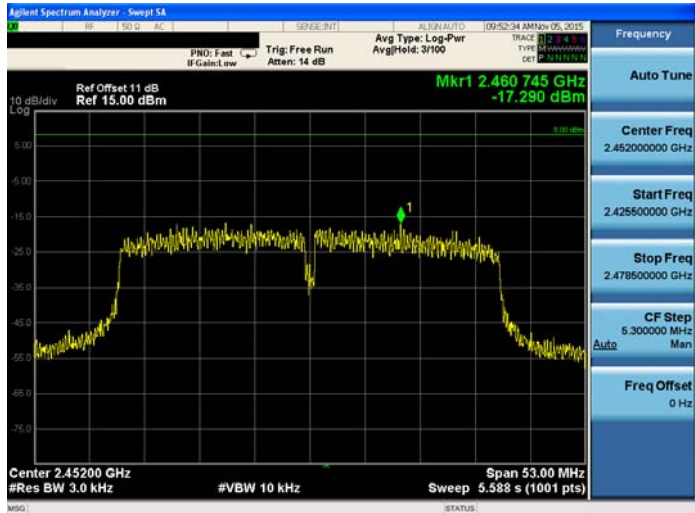
<p>2422</p>	 <p>Agilent Spectrum Analyzer - Swept SA</p> <p>Frequency</p> <p>Auto Tune</p> <p>Center Freq 2.42200000 GHz</p> <p>Start Freq 2.39660000 GHz</p> <p>Stop Freq 2.44860000 GHz</p> <p>CF Step 5.300000 MHz Auto Man</p> <p>Freq Offset 0 Hz</p> <p>Mkr1 2.425 763 GHz -17.539 dBm</p> <p>Ref Offset 11 dB Ref 15.00 dBm</p> <p>Center 2.42200 GHz #Res BW 3.0 kHz #VBW 10 kHz Sweep 5.588 s (1001 pts)</p>
<p>2437</p>	 <p>Agilent Spectrum Analyzer - Swept SA</p> <p>Frequency</p> <p>Auto Tune</p> <p>Center Freq 2.43700000 GHz</p> <p>Start Freq 2.41060000 GHz</p> <p>Stop Freq 2.46360000 GHz</p> <p>CF Step 5.300000 MHz Auto Man</p> <p>Freq Offset 0 Hz</p> <p>Mkr1 2.441 664 GHz -17.729 dBm</p> <p>Ref Offset 11 dB Ref 15.00 dBm</p> <p>Center 2.43700 GHz #Res BW 3.0 kHz #VBW 10 kHz Sweep 5.588 s (1001 pts)</p>
<p>2452</p>	 <p>Agilent Spectrum Analyzer - Swept SA</p> <p>Frequency</p> <p>Auto Tune</p> <p>Center Freq 2.45200000 GHz</p> <p>Start Freq 2.42660000 GHz</p> <p>Stop Freq 2.47860000 GHz</p> <p>CF Step 5.300000 MHz Auto Man</p> <p>Freq Offset 0 Hz</p> <p>Mkr1 2.460 745 GHz -17.290 dBm</p> <p>Ref Offset 11 dB Ref 15.00 dBm</p> <p>Center 2.45200 GHz #Res BW 3.0 kHz #VBW 10 kHz Sweep 5.588 s (1001 pts)</p>

9 Out of Band Conducted Emissions Measurement

9.1. Limit

In any 100 kHz bandwidth outside the frequency band in which the spread spectrum or digitally modulated intentional radiator is operating, the radio frequency power that is produced by the intentional radiator shall be at least 20 dB below that in the 100 kHz bandwidth within the band that contains the highest level of the desired power

9.2. Test Setup

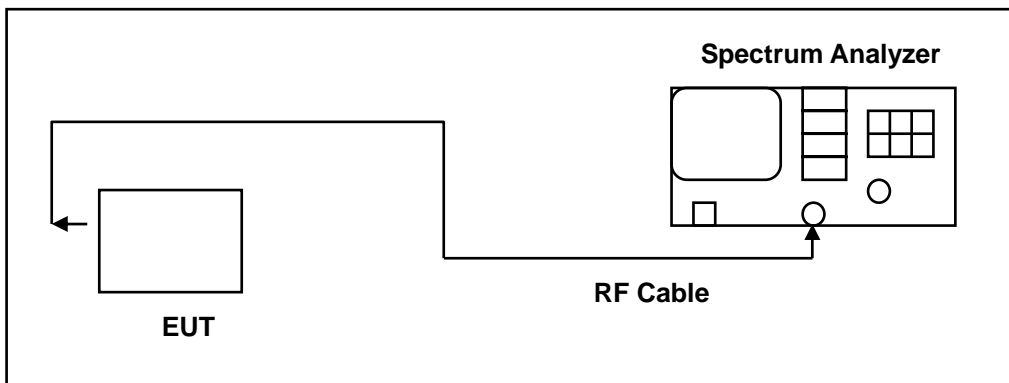

9.3. Test Instruments

Equipment	Manufacturer	Model Number	Serial Number	Cal. Date	Remark
Spectrum Analyzer	Agilent	E4445A	MY45300744	12/16/2014	(1)
Spectrum Analyzer	Agilent	E4408B	MY45107753	07/27/2015	(1)
Test Site	ATL	TE05	TE05	N.C.R.	-----

Remark: (1) Calibration period 1 year. (2) Calibration period 2 years. (3) Calibration period 3 years.

Note: N.C.R. = No Calibration Request.

9.4. Test Procedure

In any 100 kHz bandwidth outside the EUT pass band, the RF power produced by the modulation products of the spreading sequence, the information sequence, and the carrier frequency shall be at least 20 dB below that of the maximum in-band 100 kHz emission, antenna output of the EUT was coupled directly to spectrum analyzer; if an external attenuator and/or cable was used, these losses are compensated for with the analyzer OFFSET function.

All other types of emissions from the EUT shall meet the general limits for radiated frequencies outside the pass band.

The test was performed at 3 channels.

9.5. Test Graphs

Reference level

Mode 2: AR9271L_ IEEE 802.11b link mode	
2412	<p>Agilent R T Ref 10 dBm Atten 10 dB Mkr1 2.4110025 GHz 4.971 dBm Peak Log 10 dB/ Offst 10.8 dB M1 S2 S3 FC AA Center 2.412 GHz Span 19 MHz #Res BW 100 kHz #VBW 300 kHz Sweep 4 ms (401 pts)</p> <p>Freq/Channel Center Freq 2.41200000 GHz Start Freq 2.40250000 GHz Stop Freq 2.42150000 GHz CF Step 1.90000000 MHz Auto Man Freq Offset 0.00000000 Hz Signal Track On Off</p>
2437	<p>Agilent R T Ref 10 dBm Atten 10 dB Mkr1 2.4375225 GHz 5.466 dBm Peak Log 10 dB/ Offst 10.8 dB M1 S2 S3 FC AA Center 2.437 GHz Span 19 MHz #Res BW 100 kHz #VBW 300 kHz Sweep 4 ms (401 pts)</p> <p>Freq/Channel Center Freq 2.43700000 GHz Start Freq 2.42750000 GHz Stop Freq 2.44650000 GHz CF Step 1.90000000 MHz Auto Man Freq Offset 0.00000000 Hz Signal Track On Off</p>
2462	<p>Agilent R T Ref 10 dBm Atten 10 dB Mkr1 2.4375225 GHz 5.466 dBm Peak Log 10 dB/ Offst 10.8 dB M1 S2 S3 FC AA Center 2.437 GHz Span 19 MHz #Res BW 100 kHz #VBW 300 kHz Sweep 4 ms (401 pts)</p> <p>Freq/Channel Center Freq 2.43700000 GHz Start Freq 2.42750000 GHz Stop Freq 2.44650000 GHz CF Step 1.90000000 MHz Auto Man Freq Offset 0.00000000 Hz Signal Track On Off</p>

Mode 3: AR9271L_ IEEE 802.11g link mode

<p>2412</p>	<p>Agilent R T</p> <p>Ref 10 dBm Atten 10 dB Mkr1 2.4157500 GHz 4.723 dBm</p> <p>Peak Log 10 dB/Offst 10.8 dB</p> <p>M1 S2 S3 FC AA</p> <p>Center 2.412 GHz Span 25 MHz #Res BW 100 kHz #VBW 300 kHz Sweep 4 ms (401 pts)</p> <p>Freq/Channel</p> <p>Center Freq 2.41200000 GHz</p> <p>Start Freq 2.39950000 GHz</p> <p>Stop Freq 2.42450000 GHz</p> <p>CF Step 2.50000000 MHz Auto Man</p> <p>Freq Offset 0.00000000 Hz</p> <p>Signal Track On Off</p>
<p>2437</p>	<p>Agilent R T</p> <p>Ref 10 dBm Atten 10 dB Mkr1 2.4445000 GHz 4.599 dBm</p> <p>Peak Log 10 dB/Offst 10.8 dB</p> <p>M1 S2 S3 FC AA</p> <p>Center 2.437 GHz Span 25 MHz #Res BW 100 kHz #VBW 300 kHz Sweep 4 ms (401 pts)</p> <p>Freq/Channel</p> <p>Center Freq 2.43700000 GHz</p> <p>Start Freq 2.42450000 GHz</p> <p>Stop Freq 2.44950000 GHz</p> <p>CF Step 2.50000000 MHz Auto Man</p> <p>Freq Offset 0.00000000 Hz</p> <p>Signal Track On Off</p>
<p>2462</p>	<p>Agilent R T</p> <p>Ref 10 dBm Atten 10 dB Mkr1 2.4557500 GHz 3.908 dBm</p> <p>Peak Log 10 dB/Offst 10.8 dB</p> <p>M1 S2 S3 FC AA</p> <p>Center 2.462 GHz Span 25 MHz #Res BW 100 kHz #VBW 300 kHz Sweep 4 ms (401 pts)</p> <p>Freq/Channel</p> <p>Center Freq 2.46200000 GHz</p> <p>Start Freq 2.44950000 GHz</p> <p>Stop Freq 2.47450000 GHz</p> <p>CF Step 2.50000000 MHz Auto Man</p> <p>Freq Offset 0.00000000 Hz</p> <p>Signal Track On Off</p>

Mode 4: AR9271L_ IEEE 802.11n 2.4GHz 20MHz link mode

<p>2412</p>	<p>Agilent R T</p> <p>Ref 10 dBm Atten 10 dB Mkr1 2.4070050 GHz 4.214 dBm</p> <p>Peak Log 10 dB/Offst 10.8 dB</p> <p>M1 S2 S3 FC AA</p> <p>Center 2.412 GHz Span 27 MHz #Res BW 100 kHz #VBW 300 kHz Sweep 4 ms (401 pts)</p> <p>Freq/Channel</p> <p>Center Freq 2.41200000 GHz</p> <p>Start Freq 2.39850000 GHz</p> <p>Stop Freq 2.42550000 GHz</p> <p>CF Step 2.70000000 MHz Auto Man</p> <p>Freq Offset 0.00000000 Hz</p> <p>Signal Track On Off</p>
<p>2437</p>	<p>Agilent R T</p> <p>Ref 10 dBm Atten 10 dB Mkr1 2.4332200 GHz 3.974 dBm</p> <p>Peak Log 10 dB/Offst 10.8 dB</p> <p>M1 S2 S3 FC AA</p> <p>Center 2.437 GHz Span 27 MHz #Res BW 100 kHz #VBW 300 kHz Sweep 4 ms (401 pts)</p> <p>Freq/Channel</p> <p>Center Freq 2.43700000 GHz</p> <p>Start Freq 2.42350000 GHz</p> <p>Stop Freq 2.45050000 GHz</p> <p>CF Step 2.70000000 MHz Auto Man</p> <p>Freq Offset 0.00000000 Hz</p> <p>Signal Track On Off</p>
<p>2462</p>	<p>Agilent R T</p> <p>Ref 10 dBm Atten 10 dB Mkr1 2.4557225 GHz 3.87 dBm</p> <p>Peak Log 10 dB/Offst 10.8 dB</p> <p>M1 S2 S3 FC AA</p> <p>Center 2.462 GHz Span 27 MHz #Res BW 100 kHz #VBW 300 kHz Sweep 4 ms (401 pts)</p> <p>Freq/Channel</p> <p>Center Freq 2.46200000 GHz</p> <p>Start Freq 2.44850000 GHz</p> <p>Stop Freq 2.47550000 GHz</p> <p>CF Step 2.70000000 MHz Auto Man</p> <p>Freq Offset 0.00000000 Hz</p> <p>Signal Track On Off</p>

Mode 5: AR9271L_IEEE 802.11n 2.4GHz 40MHz link mode

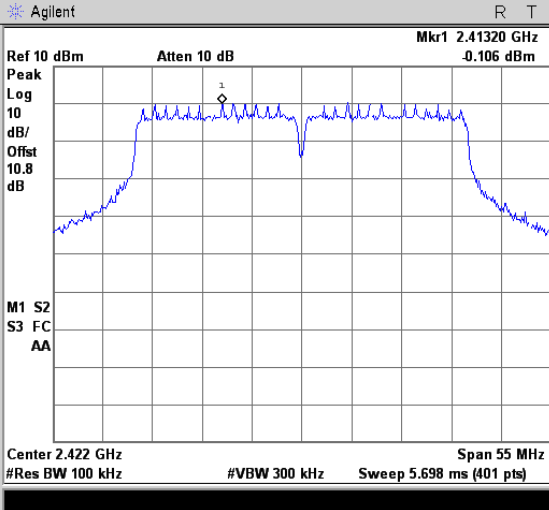
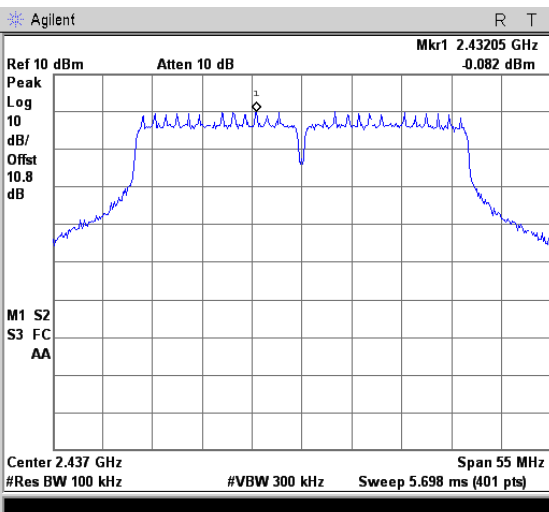
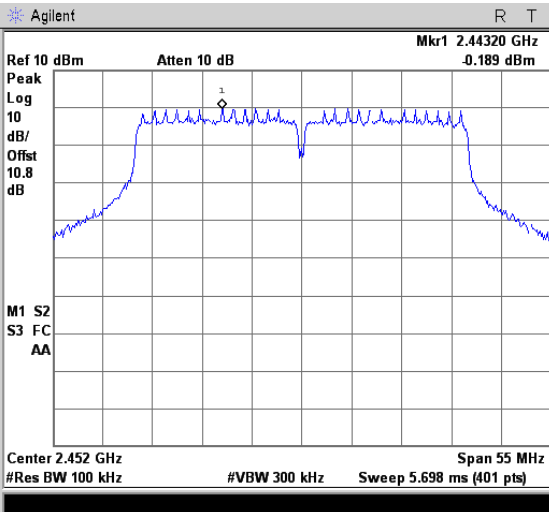
<p>2422</p>	 <p>Agilent R T</p> <p>Ref 10 dBm Atten 10 dB Mkr1 2.41320 GHz -0.106 dBm</p> <p>Peak Log 10 dB/Offset 10.8 dB</p> <p>M1 S2 S3 FC AA</p> <p>Center 2.422 GHz Span 55 MHz #Res BW 100 kHz #VBW 300 kHz Sweep 5.698 ms (401 pts)</p> <p>Freq/Channel</p> <p>Center Freq 2.4220000 GHz</p> <p>Start Freq 2.3945000 GHz</p> <p>Stop Freq 2.4495000 GHz</p> <p>CF Step 5.5000000 MHz Auto Man</p> <p>Freq Offset 0.0000000 Hz</p> <p>Signal Track On Off</p>
<p>2437</p>	 <p>Agilent R T</p> <p>Ref 10 dBm Atten 10 dB Mkr1 2.43205 GHz -0.082 dBm</p> <p>Peak Log 10 dB/Offset 10.8 dB</p> <p>M1 S2 S3 FC AA</p> <p>Center 2.437 GHz Span 55 MHz #Res BW 100 kHz #VBW 300 kHz Sweep 5.698 ms (401 pts)</p> <p>Freq/Channel</p> <p>Center Freq 2.4370000 GHz</p> <p>Start Freq 2.4095000 GHz</p> <p>Stop Freq 2.4645000 GHz</p> <p>CF Step 5.5000000 MHz Auto Man</p> <p>Freq Offset 0.0000000 Hz</p> <p>Signal Track On Off</p>
<p>2452</p>	 <p>Agilent R T</p> <p>Ref 10 dBm Atten 10 dB Mkr1 2.44320 GHz -0.189 dBm</p> <p>Peak Log 10 dB/Offset 10.8 dB</p> <p>M1 S2 S3 FC AA</p> <p>Center 2.452 GHz Span 55 MHz #Res BW 100 kHz #VBW 300 kHz Sweep 5.698 ms (401 pts)</p> <p>Freq/Channel</p> <p>Center Freq 2.4520000 GHz</p> <p>Start Freq 2.4245000 GHz</p> <p>Stop Freq 2.4795000 GHz</p> <p>CF Step 5.5000000 MHz Auto Man</p> <p>Freq Offset 0.0000000 Hz</p> <p>Signal Track On Off</p>

Mode 7: AR9331_ IEEE 802.11b link mode

<p>2412</p>	<p>Agilent Spectrum Analyzer - Sweep SA</p> <p>Ref Offset 11 dB Ref 15.00 dBm</p> <p>Mkr1 2.412 GHz -4.18 dBm</p> <p>Start 30 MHz #Res BW 100 kHz</p> <p>Stop 26.50 GHz #VBW 300 kHz Sweep 2.530 s (1001 pts)</p> <table border="1"> <thead> <tr> <th>MKR</th> <th>MODE</th> <th>TRC</th> <th>SCL</th> <th>X</th> <th>Y</th> <th>FUNCTION</th> <th>FUNCTION WIDTH</th> <th>FUNCTION VALUE</th> </tr> </thead> <tbody> <tr> <td>1</td> <td>N</td> <td>f</td> <td></td> <td>2.412 GHz</td> <td>-4.18 dBm</td> <td></td> <td></td> <td></td> </tr> <tr> <td>2</td> <td>N</td> <td>f</td> <td></td> <td>4.821 GHz</td> <td>-47.17 dBm</td> <td></td> <td></td> <td></td> </tr> </tbody> </table>	MKR	MODE	TRC	SCL	X	Y	FUNCTION	FUNCTION WIDTH	FUNCTION VALUE	1	N	f		2.412 GHz	-4.18 dBm				2	N	f		4.821 GHz	-47.17 dBm			
MKR	MODE	TRC	SCL	X	Y	FUNCTION	FUNCTION WIDTH	FUNCTION VALUE																				
1	N	f		2.412 GHz	-4.18 dBm																							
2	N	f		4.821 GHz	-47.17 dBm																							
<p>2437</p>	<p>Agilent Spectrum Analyzer - Sweep SA</p> <p>Ref Offset 11 dB Ref 15.00 dBm</p> <p>Mkr1 2.437 GHz -4.98 dBm</p> <p>Start 30 MHz #Res BW 100 kHz</p> <p>Stop 26.50 GHz #VBW 300 kHz Sweep 2.530 s (1001 pts)</p> <table border="1"> <thead> <tr> <th>MKR</th> <th>MODE</th> <th>TRC</th> <th>SCL</th> <th>X</th> <th>Y</th> <th>FUNCTION</th> <th>FUNCTION WIDTH</th> <th>FUNCTION VALUE</th> </tr> </thead> <tbody> <tr> <td>1</td> <td>N</td> <td>f</td> <td></td> <td>2.437 GHz</td> <td>-4.98 dBm</td> <td></td> <td></td> <td></td> </tr> <tr> <td>2</td> <td>N</td> <td>f</td> <td></td> <td>4.874 GHz</td> <td>-46.02 dBm</td> <td></td> <td></td> <td></td> </tr> </tbody> </table>	MKR	MODE	TRC	SCL	X	Y	FUNCTION	FUNCTION WIDTH	FUNCTION VALUE	1	N	f		2.437 GHz	-4.98 dBm				2	N	f		4.874 GHz	-46.02 dBm			
MKR	MODE	TRC	SCL	X	Y	FUNCTION	FUNCTION WIDTH	FUNCTION VALUE																				
1	N	f		2.437 GHz	-4.98 dBm																							
2	N	f		4.874 GHz	-46.02 dBm																							
<p>2462</p>	<p>Agilent Spectrum Analyzer - Sweep SA</p> <p>Ref Offset 11 dB Ref 15.00 dBm</p> <p>Mkr1 2.462 GHz -1.402 dBm</p> <p>Start 30 MHz #Res BW 100 kHz</p> <p>Stop 26.50 GHz #VBW 300 kHz Sweep 2.530 s (1001 pts)</p> <table border="1"> <thead> <tr> <th>MKR</th> <th>MODE</th> <th>TRC</th> <th>SCL</th> <th>X</th> <th>Y</th> <th>FUNCTION</th> <th>FUNCTION WIDTH</th> <th>FUNCTION VALUE</th> </tr> </thead> <tbody> <tr> <td>1</td> <td>N</td> <td>f</td> <td></td> <td>2.462 GHz</td> <td>-1.402 dBm</td> <td></td> <td></td> <td></td> </tr> <tr> <td>2</td> <td>N</td> <td>f</td> <td></td> <td>4.927 GHz</td> <td>-46.090 dBm</td> <td></td> <td></td> <td></td> </tr> </tbody> </table>	MKR	MODE	TRC	SCL	X	Y	FUNCTION	FUNCTION WIDTH	FUNCTION VALUE	1	N	f		2.462 GHz	-1.402 dBm				2	N	f		4.927 GHz	-46.090 dBm			
MKR	MODE	TRC	SCL	X	Y	FUNCTION	FUNCTION WIDTH	FUNCTION VALUE																				
1	N	f		2.462 GHz	-1.402 dBm																							
2	N	f		4.927 GHz	-46.090 dBm																							

Mode 8: AR9331_ IEEE 802.11g link mode

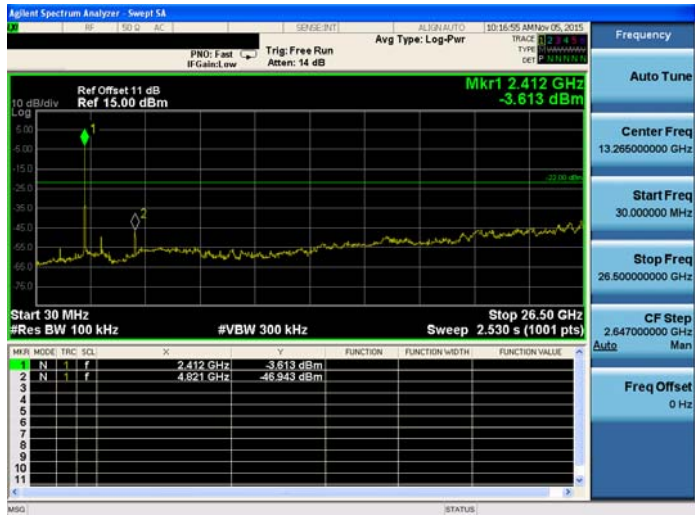
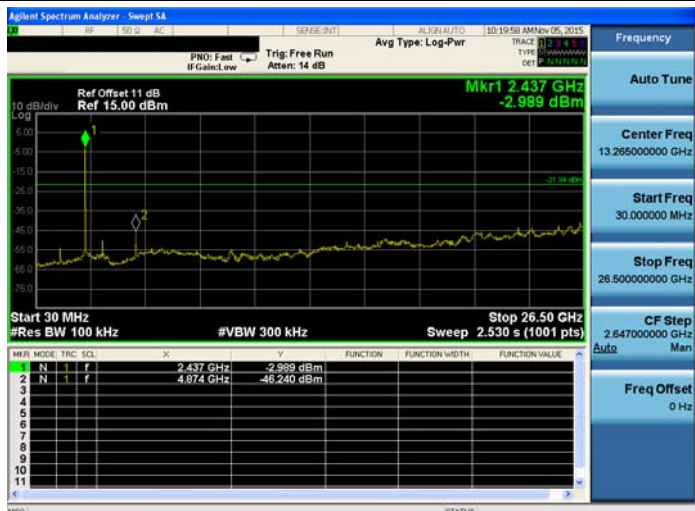
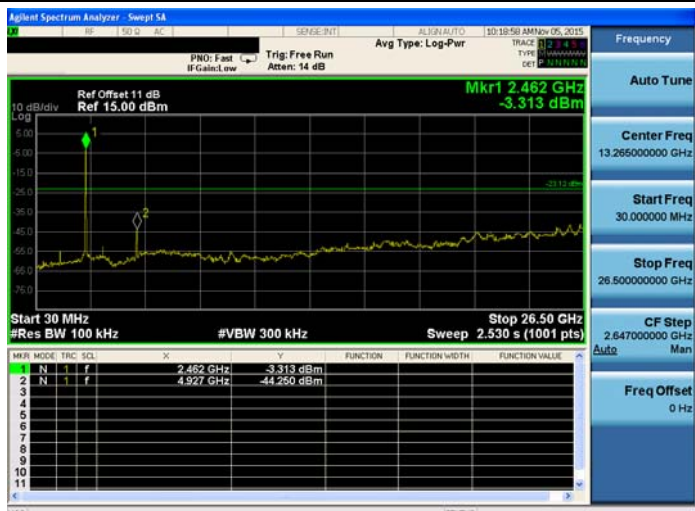
<p>2412</p>	 <table border="1" data-bbox="635 728 1212 873"> <thead> <tr> <th>MKR</th> <th>MODE</th> <th>TRC</th> <th>SCL</th> <th>X</th> <th>Y</th> <th>FUNCTION</th> <th>FUNCTION WIDTH</th> <th>FUNCTION VALUE</th> </tr> </thead> <tbody> <tr> <td>1</td> <td>N</td> <td>f</td> <td></td> <td>2.412 GHz</td> <td>-3.613 dBm</td> <td></td> <td></td> <td></td> </tr> <tr> <td>2</td> <td>N</td> <td>f</td> <td></td> <td>4.821 GHz</td> <td>-46.943 dBm</td> <td></td> <td></td> <td></td> </tr> </tbody> </table>	MKR	MODE	TRC	SCL	X	Y	FUNCTION	FUNCTION WIDTH	FUNCTION VALUE	1	N	f		2.412 GHz	-3.613 dBm				2	N	f		4.821 GHz	-46.943 dBm			
MKR	MODE	TRC	SCL	X	Y	FUNCTION	FUNCTION WIDTH	FUNCTION VALUE																				
1	N	f		2.412 GHz	-3.613 dBm																							
2	N	f		4.821 GHz	-46.943 dBm																							
<p>2437</p>	 <table border="1" data-bbox="635 1249 1212 1395"> <thead> <tr> <th>MKR</th> <th>MODE</th> <th>TRC</th> <th>SCL</th> <th>X</th> <th>Y</th> <th>FUNCTION</th> <th>FUNCTION WIDTH</th> <th>FUNCTION VALUE</th> </tr> </thead> <tbody> <tr> <td>1</td> <td>N</td> <td>f</td> <td></td> <td>2.437 GHz</td> <td>-2.989 dBm</td> <td></td> <td></td> <td></td> </tr> <tr> <td>2</td> <td>N</td> <td>f</td> <td></td> <td>4.874 GHz</td> <td>-46.240 dBm</td> <td></td> <td></td> <td></td> </tr> </tbody> </table>	MKR	MODE	TRC	SCL	X	Y	FUNCTION	FUNCTION WIDTH	FUNCTION VALUE	1	N	f		2.437 GHz	-2.989 dBm				2	N	f		4.874 GHz	-46.240 dBm			
MKR	MODE	TRC	SCL	X	Y	FUNCTION	FUNCTION WIDTH	FUNCTION VALUE																				
1	N	f		2.437 GHz	-2.989 dBm																							
2	N	f		4.874 GHz	-46.240 dBm																							
<p>2462</p>	 <table border="1" data-bbox="635 1776 1212 1921"> <thead> <tr> <th>MKR</th> <th>MODE</th> <th>TRC</th> <th>SCL</th> <th>X</th> <th>Y</th> <th>FUNCTION</th> <th>FUNCTION WIDTH</th> <th>FUNCTION VALUE</th> </tr> </thead> <tbody> <tr> <td>1</td> <td>N</td> <td>f</td> <td></td> <td>2.462 GHz</td> <td>-3.313 dBm</td> <td></td> <td></td> <td></td> </tr> <tr> <td>2</td> <td>N</td> <td>f</td> <td></td> <td>4.927 GHz</td> <td>-44.260 dBm</td> <td></td> <td></td> <td></td> </tr> </tbody> </table>	MKR	MODE	TRC	SCL	X	Y	FUNCTION	FUNCTION WIDTH	FUNCTION VALUE	1	N	f		2.462 GHz	-3.313 dBm				2	N	f		4.927 GHz	-44.260 dBm			
MKR	MODE	TRC	SCL	X	Y	FUNCTION	FUNCTION WIDTH	FUNCTION VALUE																				
1	N	f		2.462 GHz	-3.313 dBm																							
2	N	f		4.927 GHz	-44.260 dBm																							

Mode 9: AR9331_ IEEE 802.11n 2.4GHz 20MHz link mode

<p>2412</p>	<p>Agilent Spectrum Analyzer - Swept SA</p> <p>Ref Offset 11 dB Ref 15.00 dBm</p> <p>Mkr1 2.412 GHz -3.52 dBm</p> <p>Start 30 MHz #Res BW 100 kHz #VBW 300 kHz Stop 26.50 GHz Sweep 2.530 s (1001 pts)</p> <table border="1"> <thead> <tr> <th>MKR</th> <th>MODE</th> <th>TRC</th> <th>SCL</th> <th>X</th> <th>Y</th> <th>FUNCTION</th> <th>FUNCTION WIDTH</th> <th>FUNCTION VALUE</th> </tr> </thead> <tbody> <tr> <td>1</td> <td>N</td> <td>f</td> <td></td> <td>2.412 GHz</td> <td>-3.523 dBm</td> <td></td> <td></td> <td></td> </tr> <tr> <td>2</td> <td>N</td> <td>f</td> <td></td> <td>4.821 GHz</td> <td>-46.27 dBm</td> <td></td> <td></td> <td></td> </tr> </tbody> </table>	MKR	MODE	TRC	SCL	X	Y	FUNCTION	FUNCTION WIDTH	FUNCTION VALUE	1	N	f		2.412 GHz	-3.523 dBm				2	N	f		4.821 GHz	-46.27 dBm			
MKR	MODE	TRC	SCL	X	Y	FUNCTION	FUNCTION WIDTH	FUNCTION VALUE																				
1	N	f		2.412 GHz	-3.523 dBm																							
2	N	f		4.821 GHz	-46.27 dBm																							
<p>2437</p>	<p>Agilent Spectrum Analyzer - Swept SA</p> <p>Ref Offset 11 dB Ref 15.00 dBm</p> <p>Mkr1 2.437 GHz -3.153 dBm</p> <p>Start 30 MHz #Res BW 100 kHz #VBW 300 kHz Stop 26.50 GHz Sweep 2.530 s (1001 pts)</p> <table border="1"> <thead> <tr> <th>MKR</th> <th>MODE</th> <th>TRC</th> <th>SCL</th> <th>X</th> <th>Y</th> <th>FUNCTION</th> <th>FUNCTION WIDTH</th> <th>FUNCTION VALUE</th> </tr> </thead> <tbody> <tr> <td>1</td> <td>N</td> <td>f</td> <td></td> <td>2.437 GHz</td> <td>-3.153 dBm</td> <td></td> <td></td> <td></td> </tr> <tr> <td>2</td> <td>N</td> <td>f</td> <td></td> <td>4.874 GHz</td> <td>-43.163 dBm</td> <td></td> <td></td> <td></td> </tr> </tbody> </table>	MKR	MODE	TRC	SCL	X	Y	FUNCTION	FUNCTION WIDTH	FUNCTION VALUE	1	N	f		2.437 GHz	-3.153 dBm				2	N	f		4.874 GHz	-43.163 dBm			
MKR	MODE	TRC	SCL	X	Y	FUNCTION	FUNCTION WIDTH	FUNCTION VALUE																				
1	N	f		2.437 GHz	-3.153 dBm																							
2	N	f		4.874 GHz	-43.163 dBm																							
<p>2462</p>	<p>Agilent Spectrum Analyzer - Swept SA</p> <p>Ref Offset 11 dB Ref 15.00 dBm</p> <p>Mkr1 2.462 GHz -3.93 dBm</p> <p>Start 30 MHz #Res BW 100 kHz #VBW 300 kHz Stop 26.50 GHz Sweep 2.530 s (1001 pts)</p> <table border="1"> <thead> <tr> <th>MKR</th> <th>MODE</th> <th>TRC</th> <th>SCL</th> <th>X</th> <th>Y</th> <th>FUNCTION</th> <th>FUNCTION WIDTH</th> <th>FUNCTION VALUE</th> </tr> </thead> <tbody> <tr> <td>1</td> <td>N</td> <td>f</td> <td></td> <td>2.462 GHz</td> <td>-3.93 dBm</td> <td></td> <td></td> <td></td> </tr> <tr> <td>2</td> <td>N</td> <td>f</td> <td></td> <td>4.927 GHz</td> <td>-47.67 dBm</td> <td></td> <td></td> <td></td> </tr> </tbody> </table>	MKR	MODE	TRC	SCL	X	Y	FUNCTION	FUNCTION WIDTH	FUNCTION VALUE	1	N	f		2.462 GHz	-3.93 dBm				2	N	f		4.927 GHz	-47.67 dBm			
MKR	MODE	TRC	SCL	X	Y	FUNCTION	FUNCTION WIDTH	FUNCTION VALUE																				
1	N	f		2.462 GHz	-3.93 dBm																							
2	N	f		4.927 GHz	-47.67 dBm																							

Mode 10: AR9331_IEEE 802.11n 2.4GHz 40MHz link mode

2422

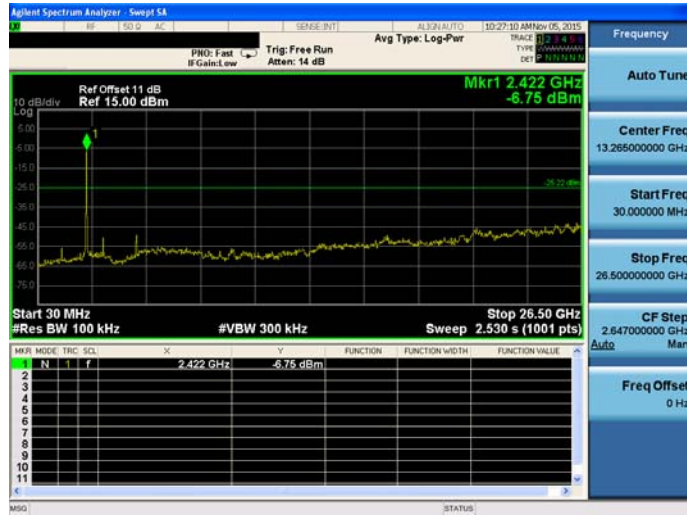

2437

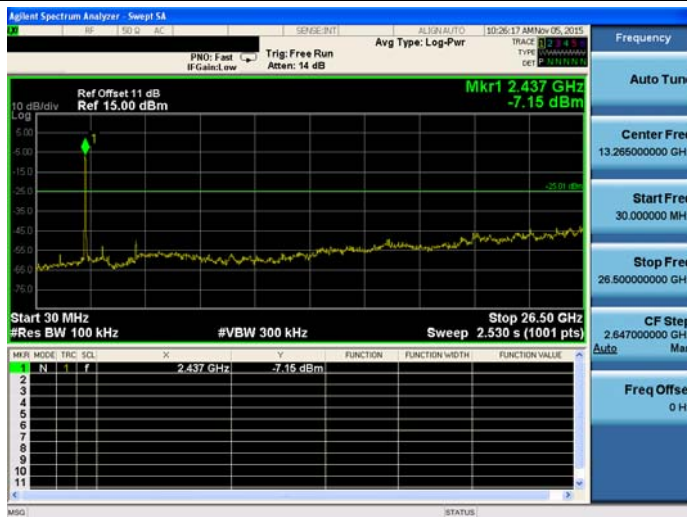

2452

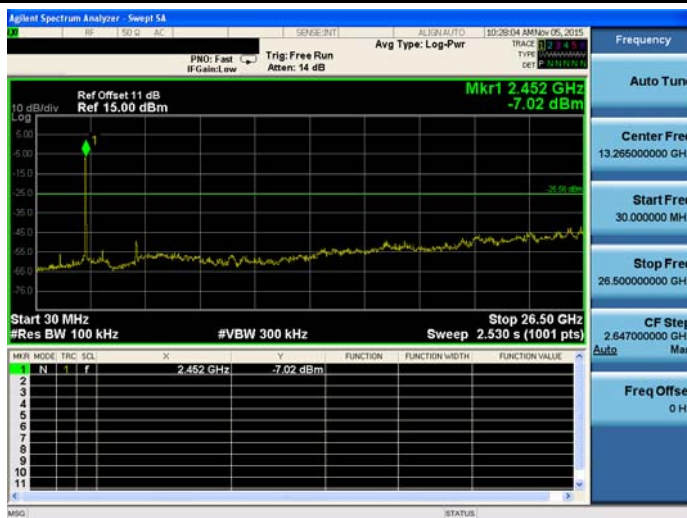

Out of Band Conducted Emissions

Mode 2: AR9271L_ IEEE 802.11b link mode

<p>2412</p>	<table border="1"> <thead> <tr> <th>Marker</th> <th>Trace</th> <th>Type</th> <th>X Axis</th> <th>Amplitude</th> </tr> </thead> <tbody> <tr> <td>1</td> <td>(1)</td> <td>Freq</td> <td>2.41 GHz</td> <td>4.794 dBm</td> </tr> <tr> <td>2</td> <td>(1)</td> <td>Freq</td> <td>4.79 GHz</td> <td>-39.22 dBm</td> </tr> </tbody> </table>	Marker	Trace	Type	X Axis	Amplitude	1	(1)	Freq	2.41 GHz	4.794 dBm	2	(1)	Freq	4.79 GHz	-39.22 dBm
Marker	Trace	Type	X Axis	Amplitude												
1	(1)	Freq	2.41 GHz	4.794 dBm												
2	(1)	Freq	4.79 GHz	-39.22 dBm												
<p>2437</p>	<table border="1"> <thead> <tr> <th>Marker</th> <th>Trace</th> <th>Type</th> <th>X Axis</th> <th>Amplitude</th> </tr> </thead> <tbody> <tr> <td>1</td> <td>(1)</td> <td>Freq</td> <td>2.44 GHz</td> <td>5.24 dBm</td> </tr> <tr> <td>2</td> <td>(1)</td> <td>Freq</td> <td>4.86 GHz</td> <td>-38.6 dBm</td> </tr> </tbody> </table>	Marker	Trace	Type	X Axis	Amplitude	1	(1)	Freq	2.44 GHz	5.24 dBm	2	(1)	Freq	4.86 GHz	-38.6 dBm
Marker	Trace	Type	X Axis	Amplitude												
1	(1)	Freq	2.44 GHz	5.24 dBm												
2	(1)	Freq	4.86 GHz	-38.6 dBm												
<p>2462</p>	<table border="1"> <thead> <tr> <th>Marker</th> <th>Trace</th> <th>Type</th> <th>X Axis</th> <th>Amplitude</th> </tr> </thead> <tbody> <tr> <td>1</td> <td>(1)</td> <td>Freq</td> <td>2.46 GHz</td> <td>5.394 dBm</td> </tr> <tr> <td>2</td> <td>(1)</td> <td>Freq</td> <td>4.93 GHz</td> <td>-39.05 dBm</td> </tr> </tbody> </table>	Marker	Trace	Type	X Axis	Amplitude	1	(1)	Freq	2.46 GHz	5.394 dBm	2	(1)	Freq	4.93 GHz	-39.05 dBm
Marker	Trace	Type	X Axis	Amplitude												
1	(1)	Freq	2.46 GHz	5.394 dBm												
2	(1)	Freq	4.93 GHz	-39.05 dBm												

Mode 3: AR9271L_ IEEE 802.11g link mode

2412	<p>Agilent R T</p> <p>Ref 10 dBm Atten 10 dB Mkr1 2.41 GHz 3.098 dBm</p> <p>Peak Log 10 dB/Offst 10.8 dB DI -15.3 dBm</p> <p>Start 30 MHz Stop 26.5 GHz #Res BW 100 kHz #VBW 300 kHz Sweep 2.742 s (401 pts)</p> <table border="1"> <thead> <tr> <th>Marker</th> <th>Trace</th> <th>Type</th> <th>X Axis</th> <th>Amplitude</th> </tr> </thead> <tbody> <tr> <td>1</td> <td>(1)</td> <td>Freq</td> <td>2.41 GHz</td> <td>3.098 dBm</td> </tr> </tbody> </table> <p>Freq/Channel: Center Freq 13.2650000 GHz, Start Freq 30.0000000 MHz, Stop Freq 26.5000000 GHz, CF Step 2.64700000 GHz, Freq Offset 0.00000000 Hz, Signal Track On Off</p>	Marker	Trace	Type	X Axis	Amplitude	1	(1)	Freq	2.41 GHz	3.098 dBm
Marker	Trace	Type	X Axis	Amplitude							
1	(1)	Freq	2.41 GHz	3.098 dBm							
2437	<p>Agilent R T</p> <p>Ref 10 dBm Atten 10 dB Mkr1 2.44 GHz 1.513 dBm</p> <p>Peak Log 10 dB/Offst 10.8 dB DI -15.4 dBm</p> <p>Start 30 MHz Stop 26.5 GHz #Res BW 100 kHz #VBW 300 kHz Sweep 2.742 s (401 pts)</p> <table border="1"> <thead> <tr> <th>Marker</th> <th>Trace</th> <th>Type</th> <th>X Axis</th> <th>Amplitude</th> </tr> </thead> <tbody> <tr> <td>1</td> <td>(1)</td> <td>Freq</td> <td>2.44 GHz</td> <td>1.513 dBm</td> </tr> </tbody> </table> <p>Freq/Channel: Center Freq 13.2650000 GHz, Start Freq 30.0000000 MHz, Stop Freq 26.5000000 GHz, CF Step 2.64700000 GHz, Freq Offset 0.00000000 Hz, Signal Track On Off</p>	Marker	Trace	Type	X Axis	Amplitude	1	(1)	Freq	2.44 GHz	1.513 dBm
Marker	Trace	Type	X Axis	Amplitude							
1	(1)	Freq	2.44 GHz	1.513 dBm							
2462	<p>Agilent R T</p> <p>Ref 10 dBm Atten 10 dB Mkr1 2.46 GHz 1.137 dBm</p> <p>Peak Log 10 dB/Offst 10.8 dB DI -16.1 dBm</p> <p>Start 30 MHz Stop 26.5 GHz #Res BW 100 kHz #VBW 300 kHz Sweep 2.742 s (401 pts)</p> <table border="1"> <thead> <tr> <th>Marker</th> <th>Trace</th> <th>Type</th> <th>X Axis</th> <th>Amplitude</th> </tr> </thead> <tbody> <tr> <td>1</td> <td>(1)</td> <td>Freq</td> <td>2.46 GHz</td> <td>1.137 dBm</td> </tr> </tbody> </table> <p>Freq/Channel: Center Freq 13.2650000 GHz, Start Freq 30.0000000 MHz, Stop Freq 26.5000000 GHz, CF Step 2.64700000 GHz, Freq Offset 0.00000000 Hz, Signal Track On Off</p>	Marker	Trace	Type	X Axis	Amplitude	1	(1)	Freq	2.46 GHz	1.137 dBm
Marker	Trace	Type	X Axis	Amplitude							
1	(1)	Freq	2.46 GHz	1.137 dBm							

Mode 4: AR9271L_ IEEE 802.11n 2.4GHz 20MHz link mode

2412

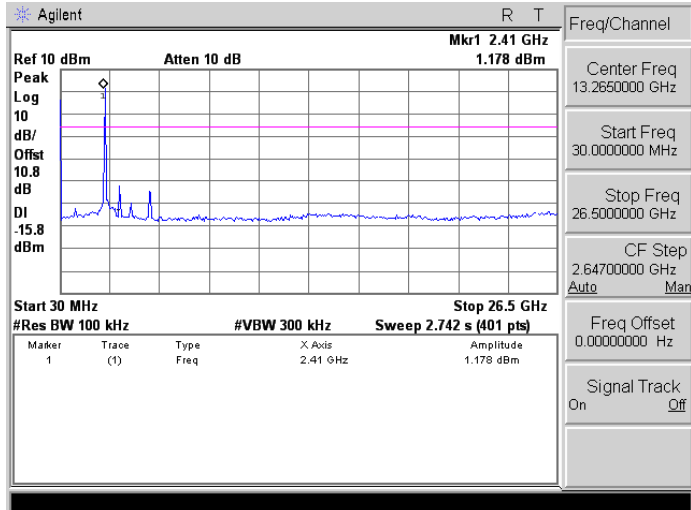

2437

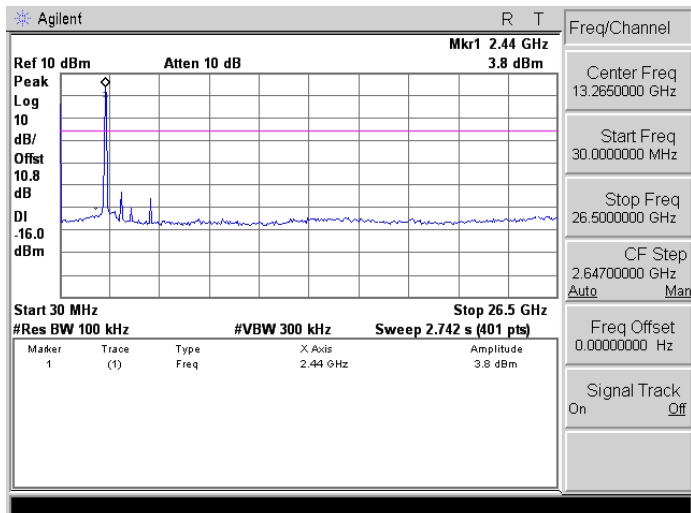

2462

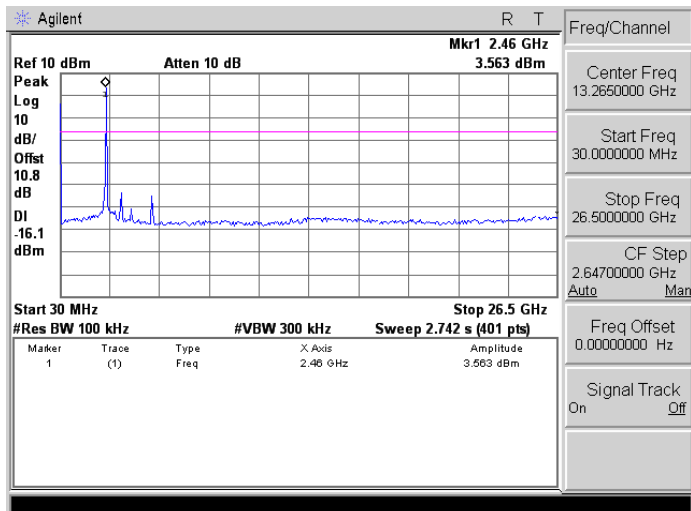

Mode 5: AR9271L_ IEEE 802.11n 2.4GHz 40MHz link mode

2422

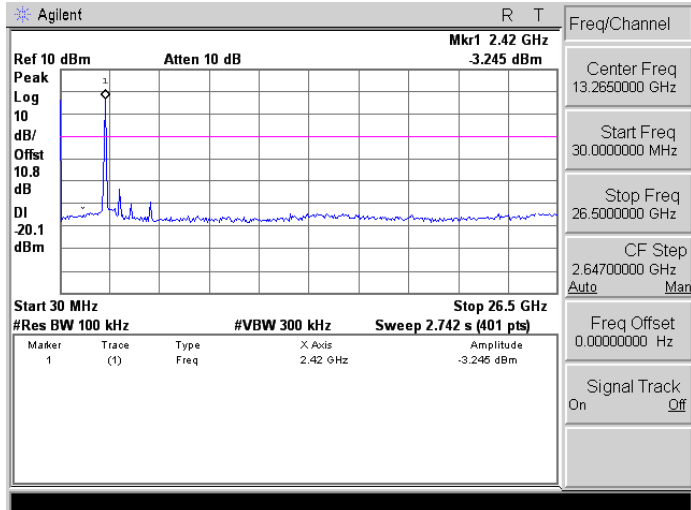

2437

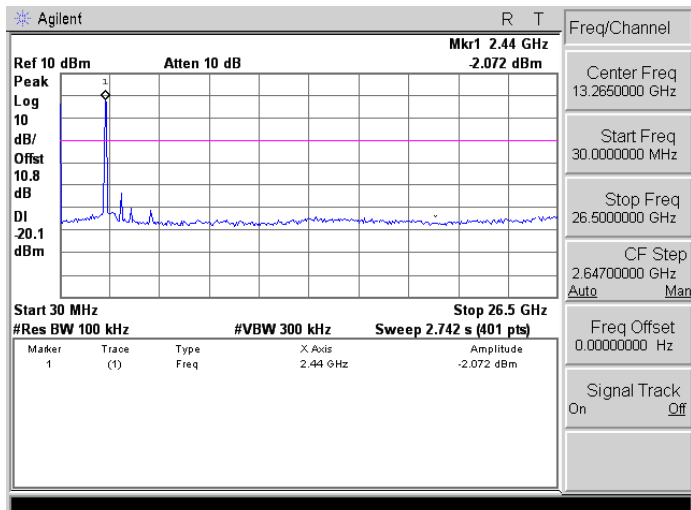

2452

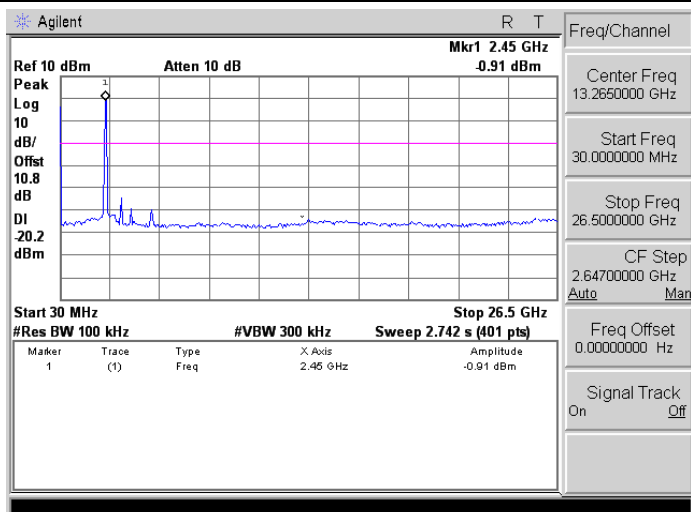

Mode 7: AR9331_ IEEE 802.11b link mode

<p>2412</p>	<p>Agilent Spectrum Analyzer - Sweep SA</p> <p>Ref Offset 11 dB Ref 15.00 dBm</p> <p>Mkr1 2.412 GHz -4.18 dBm</p> <p>Start 30 MHz #Res BW 100 kHz</p> <p>Stop 26.50 GHz #VBW 300 kHz Sweep 2.530 s (1001 pts)</p> <table border="1"> <thead> <tr> <th>MKR</th> <th>MODE</th> <th>TRC</th> <th>SCL</th> <th>X</th> <th>Y</th> <th>FUNCTION</th> <th>FUNCTION WIDTH</th> <th>FUNCTION VALUE</th> </tr> </thead> <tbody> <tr> <td>1</td> <td>N</td> <td>f</td> <td></td> <td>2.412 GHz</td> <td>-4.18 dBm</td> <td></td> <td></td> <td></td> </tr> <tr> <td>2</td> <td>N</td> <td>f</td> <td></td> <td>4.821 GHz</td> <td>-47.17 dBm</td> <td></td> <td></td> <td></td> </tr> </tbody> </table>	MKR	MODE	TRC	SCL	X	Y	FUNCTION	FUNCTION WIDTH	FUNCTION VALUE	1	N	f		2.412 GHz	-4.18 dBm				2	N	f		4.821 GHz	-47.17 dBm			
MKR	MODE	TRC	SCL	X	Y	FUNCTION	FUNCTION WIDTH	FUNCTION VALUE																				
1	N	f		2.412 GHz	-4.18 dBm																							
2	N	f		4.821 GHz	-47.17 dBm																							
<p>2437</p>	<p>Agilent Spectrum Analyzer - Sweep SA</p> <p>Ref Offset 11 dB Ref 15.00 dBm</p> <p>Mkr1 2.437 GHz -4.98 dBm</p> <p>Start 30 MHz #Res BW 100 kHz</p> <p>Stop 26.50 GHz #VBW 300 kHz Sweep 2.530 s (1001 pts)</p> <table border="1"> <thead> <tr> <th>MKR</th> <th>MODE</th> <th>TRC</th> <th>SCL</th> <th>X</th> <th>Y</th> <th>FUNCTION</th> <th>FUNCTION WIDTH</th> <th>FUNCTION VALUE</th> </tr> </thead> <tbody> <tr> <td>1</td> <td>N</td> <td>f</td> <td></td> <td>2.437 GHz</td> <td>-4.98 dBm</td> <td></td> <td></td> <td></td> </tr> <tr> <td>2</td> <td>N</td> <td>f</td> <td></td> <td>4.874 GHz</td> <td>-46.02 dBm</td> <td></td> <td></td> <td></td> </tr> </tbody> </table>	MKR	MODE	TRC	SCL	X	Y	FUNCTION	FUNCTION WIDTH	FUNCTION VALUE	1	N	f		2.437 GHz	-4.98 dBm				2	N	f		4.874 GHz	-46.02 dBm			
MKR	MODE	TRC	SCL	X	Y	FUNCTION	FUNCTION WIDTH	FUNCTION VALUE																				
1	N	f		2.437 GHz	-4.98 dBm																							
2	N	f		4.874 GHz	-46.02 dBm																							
<p>2462</p>	<p>Agilent Spectrum Analyzer - Sweep SA</p> <p>Ref Offset 11 dB Ref 15.00 dBm</p> <p>Mkr1 2.462 GHz -1.402 dBm</p> <p>Start 30 MHz #Res BW 100 kHz</p> <p>Stop 26.50 GHz #VBW 300 kHz Sweep 2.530 s (1001 pts)</p> <table border="1"> <thead> <tr> <th>MKR</th> <th>MODE</th> <th>TRC</th> <th>SCL</th> <th>X</th> <th>Y</th> <th>FUNCTION</th> <th>FUNCTION WIDTH</th> <th>FUNCTION VALUE</th> </tr> </thead> <tbody> <tr> <td>1</td> <td>N</td> <td>f</td> <td></td> <td>2.462 GHz</td> <td>-1.402 dBm</td> <td></td> <td></td> <td></td> </tr> <tr> <td>2</td> <td>N</td> <td>f</td> <td></td> <td>4.927 GHz</td> <td>-46.090 dBm</td> <td></td> <td></td> <td></td> </tr> </tbody> </table>	MKR	MODE	TRC	SCL	X	Y	FUNCTION	FUNCTION WIDTH	FUNCTION VALUE	1	N	f		2.462 GHz	-1.402 dBm				2	N	f		4.927 GHz	-46.090 dBm			
MKR	MODE	TRC	SCL	X	Y	FUNCTION	FUNCTION WIDTH	FUNCTION VALUE																				
1	N	f		2.462 GHz	-1.402 dBm																							
2	N	f		4.927 GHz	-46.090 dBm																							

Mode 8: AR9331_ IEEE 802.11g link mode

<p>2412</p>	<p>Agilent Spectrum Analyzer - Swept SA</p> <p>Frequency: 2412 MHz</p> <p>Mkr1 2.412 GHz -3.613 dBm</p> <p>Ref Offset 11 dB Ref 15.00 dBm</p> <p>Start 30 MHz #Res BW 100 kHz #VBW 300 kHz Stop 26.50 GHz Sweep 2.530 s (1001 pts)</p> <table border="1"> <thead> <tr> <th>MKR</th> <th>MODE</th> <th>TRC</th> <th>SCL</th> <th>X</th> <th>Y</th> <th>FUNCTION</th> <th>FUNCTION WIDTH</th> <th>FUNCTION VALUE</th> </tr> </thead> <tbody> <tr> <td>1</td> <td>N</td> <td>f</td> <td></td> <td>2.412 GHz</td> <td>-3.613 dBm</td> <td></td> <td></td> <td></td> </tr> <tr> <td>2</td> <td>N</td> <td>f</td> <td></td> <td>4.821 GHz</td> <td>-46.943 dBm</td> <td></td> <td></td> <td></td> </tr> </tbody> </table>	MKR	MODE	TRC	SCL	X	Y	FUNCTION	FUNCTION WIDTH	FUNCTION VALUE	1	N	f		2.412 GHz	-3.613 dBm				2	N	f		4.821 GHz	-46.943 dBm			
MKR	MODE	TRC	SCL	X	Y	FUNCTION	FUNCTION WIDTH	FUNCTION VALUE																				
1	N	f		2.412 GHz	-3.613 dBm																							
2	N	f		4.821 GHz	-46.943 dBm																							
<p>2437</p>	<p>Agilent Spectrum Analyzer - Swept SA</p> <p>Frequency: 2437 MHz</p> <p>Mkr1 2.437 GHz -2.989 dBm</p> <p>Ref Offset 11 dB Ref 15.00 dBm</p> <p>Start 30 MHz #Res BW 100 kHz #VBW 300 kHz Stop 26.50 GHz Sweep 2.530 s (1001 pts)</p> <table border="1"> <thead> <tr> <th>MKR</th> <th>MODE</th> <th>TRC</th> <th>SCL</th> <th>X</th> <th>Y</th> <th>FUNCTION</th> <th>FUNCTION WIDTH</th> <th>FUNCTION VALUE</th> </tr> </thead> <tbody> <tr> <td>1</td> <td>N</td> <td>f</td> <td></td> <td>2.437 GHz</td> <td>-2.989 dBm</td> <td></td> <td></td> <td></td> </tr> <tr> <td>2</td> <td>N</td> <td>f</td> <td></td> <td>4.874 GHz</td> <td>-46.240 dBm</td> <td></td> <td></td> <td></td> </tr> </tbody> </table>	MKR	MODE	TRC	SCL	X	Y	FUNCTION	FUNCTION WIDTH	FUNCTION VALUE	1	N	f		2.437 GHz	-2.989 dBm				2	N	f		4.874 GHz	-46.240 dBm			
MKR	MODE	TRC	SCL	X	Y	FUNCTION	FUNCTION WIDTH	FUNCTION VALUE																				
1	N	f		2.437 GHz	-2.989 dBm																							
2	N	f		4.874 GHz	-46.240 dBm																							
<p>2462</p>	<p>Agilent Spectrum Analyzer - Swept SA</p> <p>Frequency: 2462 MHz</p> <p>Mkr1 2.462 GHz -3.313 dBm</p> <p>Ref Offset 11 dB Ref 15.00 dBm</p> <p>Start 30 MHz #Res BW 100 kHz #VBW 300 kHz Stop 26.50 GHz Sweep 2.530 s (1001 pts)</p> <table border="1"> <thead> <tr> <th>MKR</th> <th>MODE</th> <th>TRC</th> <th>SCL</th> <th>X</th> <th>Y</th> <th>FUNCTION</th> <th>FUNCTION WIDTH</th> <th>FUNCTION VALUE</th> </tr> </thead> <tbody> <tr> <td>1</td> <td>N</td> <td>f</td> <td></td> <td>2.462 GHz</td> <td>-3.313 dBm</td> <td></td> <td></td> <td></td> </tr> <tr> <td>2</td> <td>N</td> <td>f</td> <td></td> <td>4.927 GHz</td> <td>-44.260 dBm</td> <td></td> <td></td> <td></td> </tr> </tbody> </table>	MKR	MODE	TRC	SCL	X	Y	FUNCTION	FUNCTION WIDTH	FUNCTION VALUE	1	N	f		2.462 GHz	-3.313 dBm				2	N	f		4.927 GHz	-44.260 dBm			
MKR	MODE	TRC	SCL	X	Y	FUNCTION	FUNCTION WIDTH	FUNCTION VALUE																				
1	N	f		2.462 GHz	-3.313 dBm																							
2	N	f		4.927 GHz	-44.260 dBm																							

Mode 9: AR9331_ IEEE 802.11n 2.4GHz 20MHz link mode

<p>2412</p>	<p>Agilent Spectrum Analyzer - Swept SA</p> <p>Ref Offset 11 dB Ref 15.00 dBm</p> <p>Mkr1 2.412 GHz -3.52 dBm</p> <p>Start 30 MHz #Res BW 100 kHz</p> <p>Stop 26.50 GHz #VBW 300 kHz Sweep 2.530 s (1001 pts)</p> <table border="1"> <thead> <tr> <th>MKR</th> <th>MODE</th> <th>TRC</th> <th>SCL</th> <th>X</th> <th>Y</th> <th>FUNCTION</th> <th>FUNCTION WIDTH</th> <th>FUNCTION VALUE</th> </tr> </thead> <tbody> <tr> <td>1</td> <td>N</td> <td>f</td> <td></td> <td>2.412 GHz</td> <td>-3.523 dBm</td> <td></td> <td></td> <td></td> </tr> <tr> <td>2</td> <td>N</td> <td>f</td> <td></td> <td>4.821 GHz</td> <td>-46.27 dBm</td> <td></td> <td></td> <td></td> </tr> </tbody> </table>	MKR	MODE	TRC	SCL	X	Y	FUNCTION	FUNCTION WIDTH	FUNCTION VALUE	1	N	f		2.412 GHz	-3.523 dBm				2	N	f		4.821 GHz	-46.27 dBm			
MKR	MODE	TRC	SCL	X	Y	FUNCTION	FUNCTION WIDTH	FUNCTION VALUE																				
1	N	f		2.412 GHz	-3.523 dBm																							
2	N	f		4.821 GHz	-46.27 dBm																							
<p>2437</p>	<p>Agilent Spectrum Analyzer - Swept SA</p> <p>Ref Offset 11 dB Ref 15.00 dBm</p> <p>Mkr1 2.437 GHz -3.153 dBm</p> <p>Start 30 MHz #Res BW 100 kHz</p> <p>Stop 26.50 GHz #VBW 300 kHz Sweep 2.530 s (1001 pts)</p> <table border="1"> <thead> <tr> <th>MKR</th> <th>MODE</th> <th>TRC</th> <th>SCL</th> <th>X</th> <th>Y</th> <th>FUNCTION</th> <th>FUNCTION WIDTH</th> <th>FUNCTION VALUE</th> </tr> </thead> <tbody> <tr> <td>1</td> <td>N</td> <td>f</td> <td></td> <td>2.437 GHz</td> <td>-3.153 dBm</td> <td></td> <td></td> <td></td> </tr> <tr> <td>2</td> <td>N</td> <td>f</td> <td></td> <td>4.874 GHz</td> <td>-43.163 dBm</td> <td></td> <td></td> <td></td> </tr> </tbody> </table>	MKR	MODE	TRC	SCL	X	Y	FUNCTION	FUNCTION WIDTH	FUNCTION VALUE	1	N	f		2.437 GHz	-3.153 dBm				2	N	f		4.874 GHz	-43.163 dBm			
MKR	MODE	TRC	SCL	X	Y	FUNCTION	FUNCTION WIDTH	FUNCTION VALUE																				
1	N	f		2.437 GHz	-3.153 dBm																							
2	N	f		4.874 GHz	-43.163 dBm																							
<p>2462</p>	<p>Agilent Spectrum Analyzer - Swept SA</p> <p>Ref Offset 11 dB Ref 15.00 dBm</p> <p>Mkr1 2.462 GHz -3.93 dBm</p> <p>Start 30 MHz #Res BW 100 kHz</p> <p>Stop 26.50 GHz #VBW 300 kHz Sweep 2.530 s (1001 pts)</p> <table border="1"> <thead> <tr> <th>MKR</th> <th>MODE</th> <th>TRC</th> <th>SCL</th> <th>X</th> <th>Y</th> <th>FUNCTION</th> <th>FUNCTION WIDTH</th> <th>FUNCTION VALUE</th> </tr> </thead> <tbody> <tr> <td>1</td> <td>N</td> <td>f</td> <td></td> <td>2.462 GHz</td> <td>-3.93 dBm</td> <td></td> <td></td> <td></td> </tr> <tr> <td>2</td> <td>N</td> <td>f</td> <td></td> <td>4.927 GHz</td> <td>-47.67 dBm</td> <td></td> <td></td> <td></td> </tr> </tbody> </table>	MKR	MODE	TRC	SCL	X	Y	FUNCTION	FUNCTION WIDTH	FUNCTION VALUE	1	N	f		2.462 GHz	-3.93 dBm				2	N	f		4.927 GHz	-47.67 dBm			
MKR	MODE	TRC	SCL	X	Y	FUNCTION	FUNCTION WIDTH	FUNCTION VALUE																				
1	N	f		2.462 GHz	-3.93 dBm																							
2	N	f		4.927 GHz	-47.67 dBm																							

Mode 10: AR9331_ IEEE 802.11n 2.4GHz 40MHz link mode

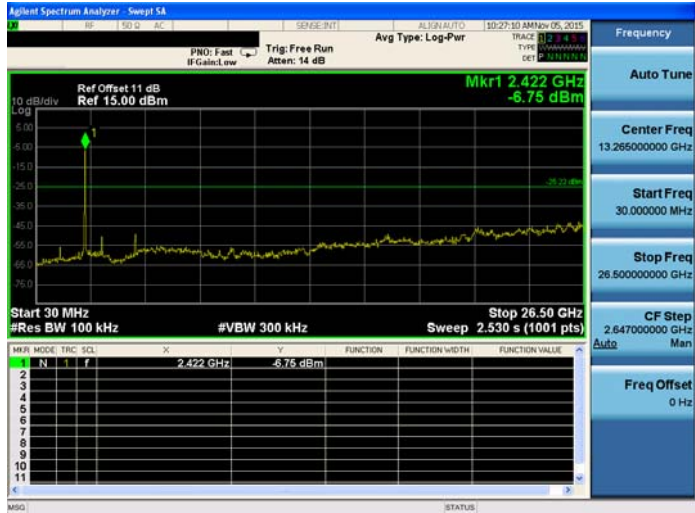
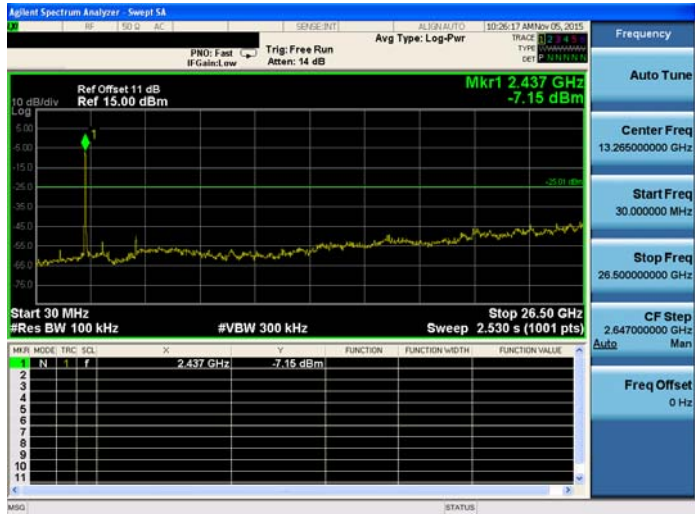
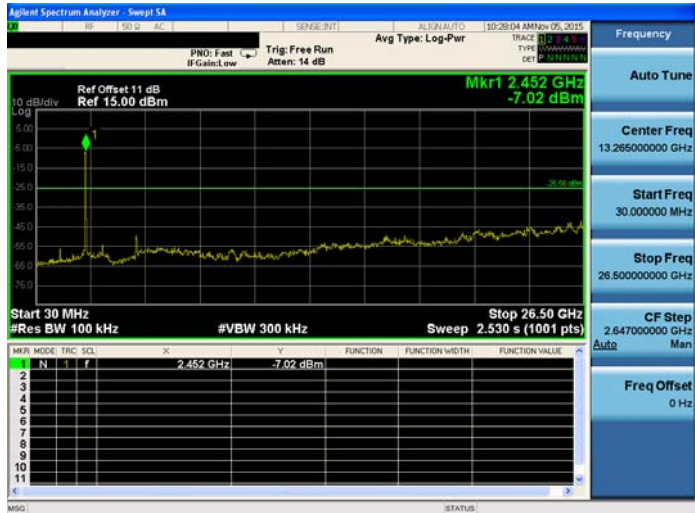
<p>2422</p>	 <p>Agilent Spectrum Analyzer - Swept SA</p> <p>Ref Offset 11 dB Ref 15.00 dBm</p> <p>Mkr1 2.422 GHz -6.75 dBm</p> <p>Start 30 MHz #Res BW 100 kHz</p> <p>Stop 26.50 GHz #VBW 300 kHz Sweep 2.530 s (1001 pts)</p> <p>MKR MODE: TRC: SCL: X: Y: FUNCTION: FUNCTION WIDTH: FUNCTION VALUE</p> <p>1: N: f: 2.422 GHz: -6.75 dBm</p> <p>Frequency: Auto Tune Center Freq: 13.285000000 GHz Start Freq: 30.000000 MHz Stop Freq: 26.500000000 GHz CF Step: 2.647000000 GHz Man Freq Offset: 0 Hz</p>
<p>2437</p>	 <p>Agilent Spectrum Analyzer - Swept SA</p> <p>Ref Offset 11 dB Ref 15.00 dBm</p> <p>Mkr1 2.437 GHz -7.15 dBm</p> <p>Start 30 MHz #Res BW 100 kHz</p> <p>Stop 26.50 GHz #VBW 300 kHz Sweep 2.530 s (1001 pts)</p> <p>MKR MODE: TRC: SCL: X: Y: FUNCTION: FUNCTION WIDTH: FUNCTION VALUE</p> <p>1: N: f: 2.437 GHz: -7.15 dBm</p> <p>Frequency: Auto Tune Center Freq: 13.285000000 GHz Start Freq: 30.000000 MHz Stop Freq: 26.500000000 GHz CF Step: 2.647000000 GHz Man Freq Offset: 0 Hz</p>
<p>2452</p>	 <p>Agilent Spectrum Analyzer - Swept SA</p> <p>Ref Offset 11 dB Ref 15.00 dBm</p> <p>Mkr1 2.452 GHz -7.02 dBm</p> <p>Start 30 MHz #Res BW 100 kHz</p> <p>Stop 26.50 GHz #VBW 300 kHz Sweep 2.530 s (1001 pts)</p> <p>MKR MODE: TRC: SCL: X: Y: FUNCTION: FUNCTION WIDTH: FUNCTION VALUE</p> <p>1: N: f: 2.452 GHz: -7.02 dBm</p> <p>Frequency: Auto Tune Center Freq: 13.285000000 GHz Start Freq: 30.000000 MHz Stop Freq: 26.500000000 GHz CF Step: 2.647000000 GHz Man Freq Offset: 0 Hz</p>

Conducted Band Edge

Mode 2: AR9271L_ IEEE 802.11b link mode

2412

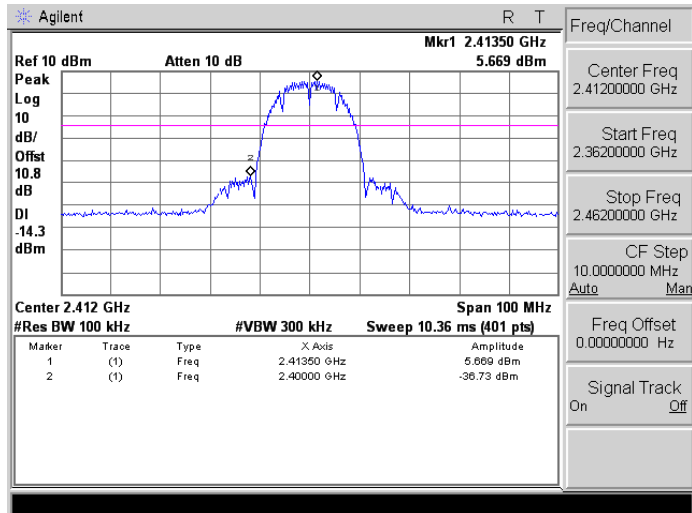

2462

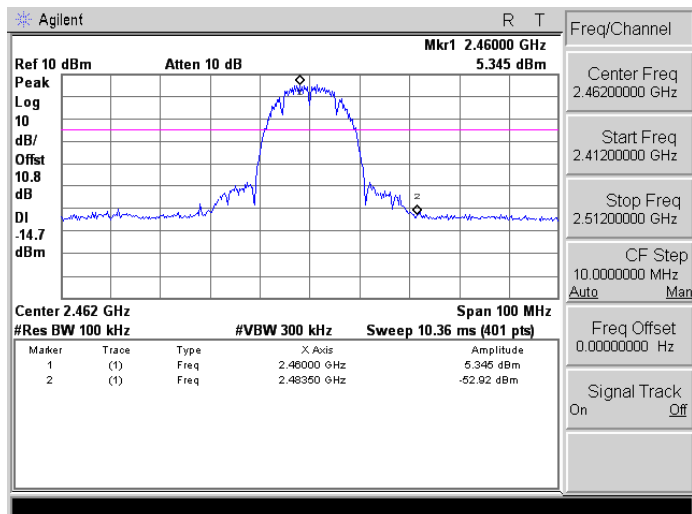

Mode 3: AR9271L_ IEEE 802.11g link mode

2412

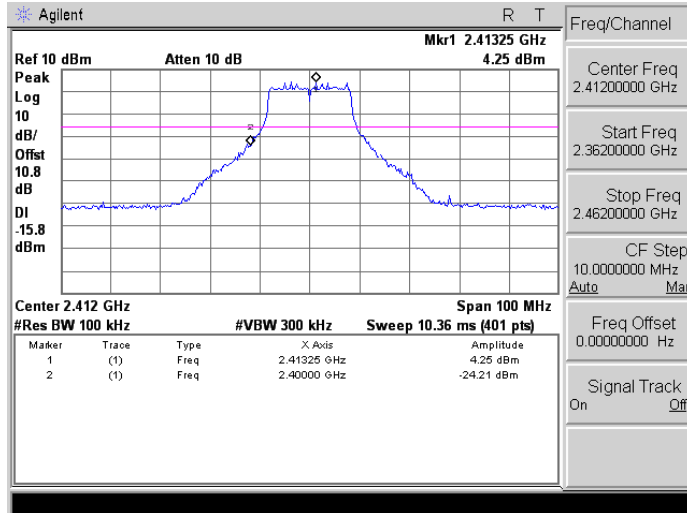

2462

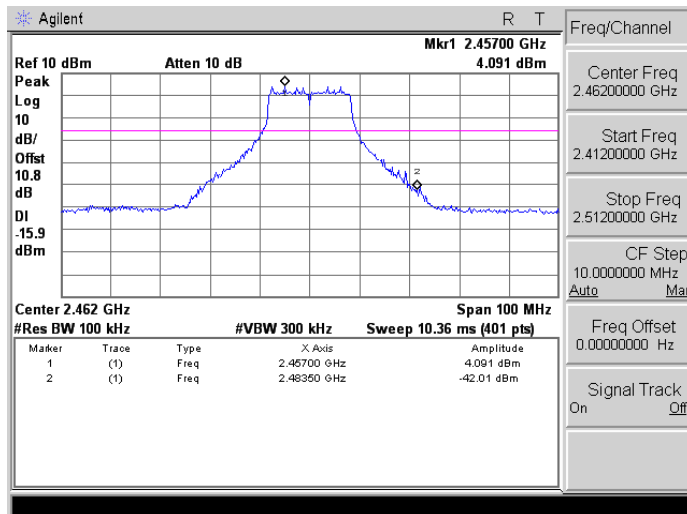

Mode 4: AR9271L_IEEE 802.11n 2.4GHz 20MHz link mode

2412

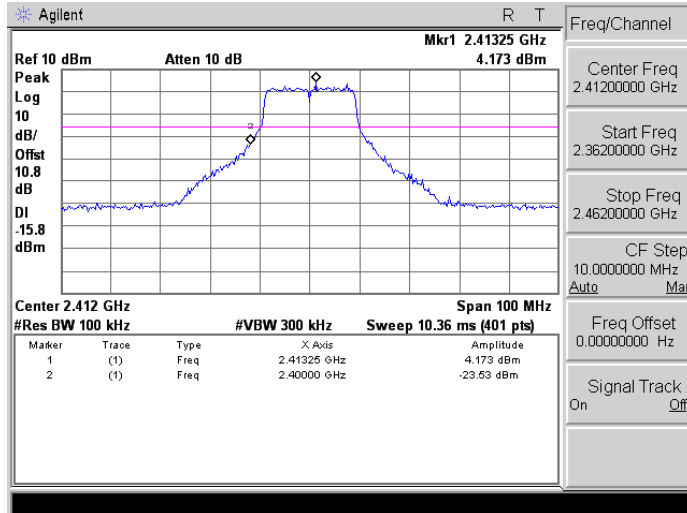

2462

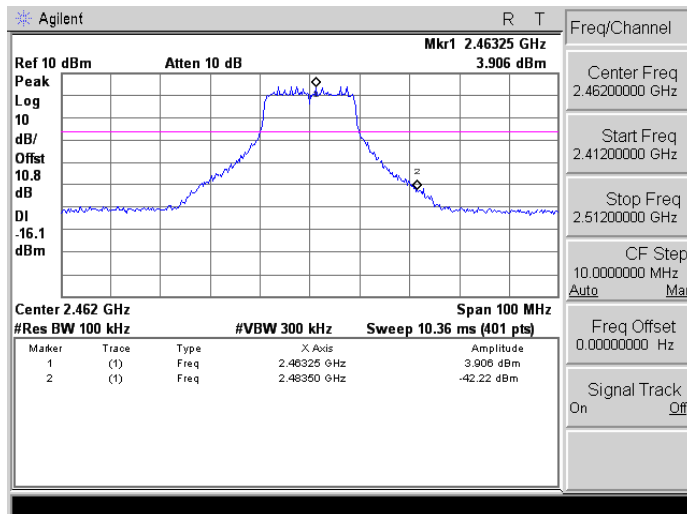

Mode 5: AR9271L_IEEE 802.11n 2.4GHz 40MHz link mode

2422

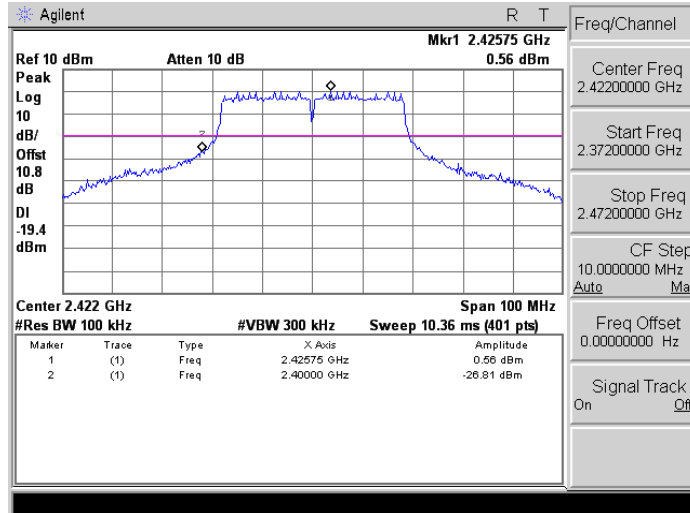

2452

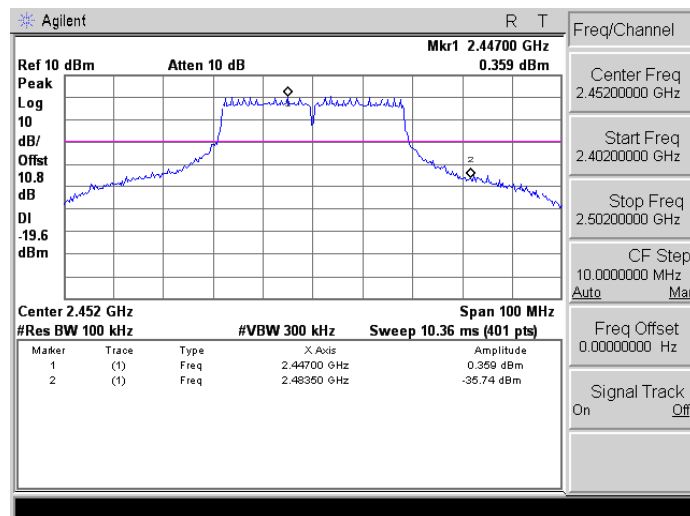

Mode 7: AR9331_ IEEE 802.11b link mode

2412

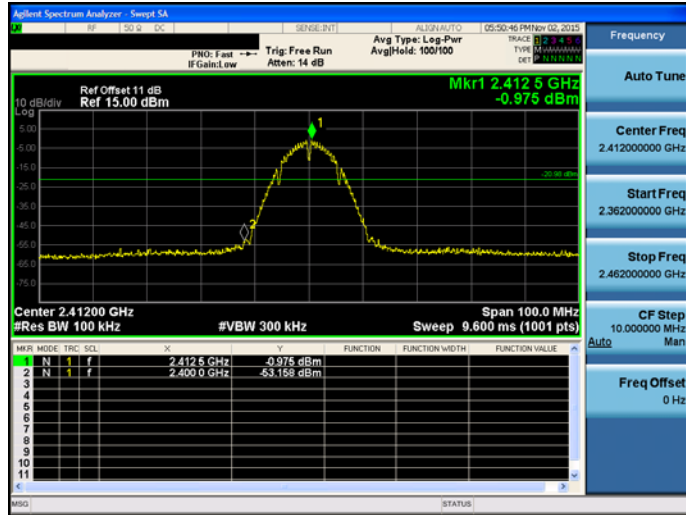

2462

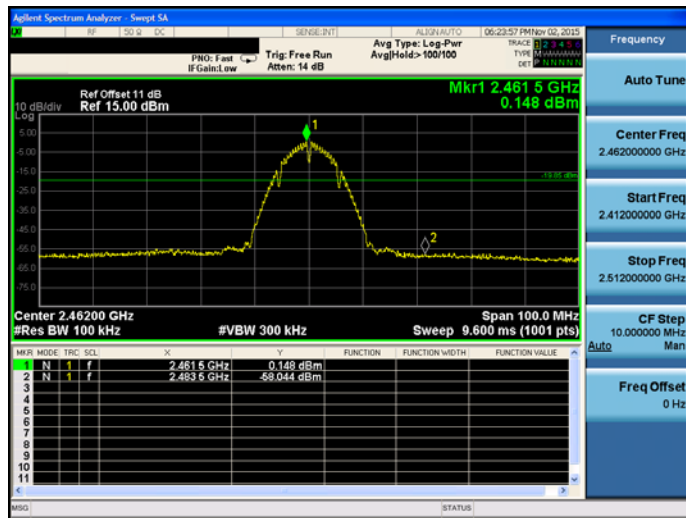

Mode 8: AR9331_ IEEE 802.11g link mode

2412

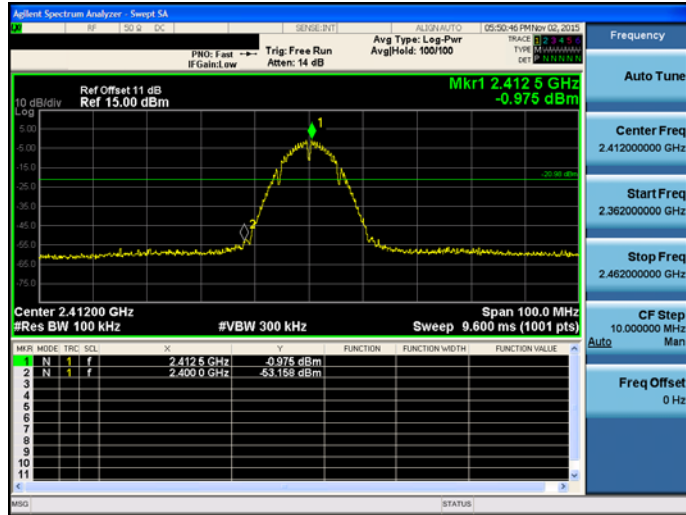

2462

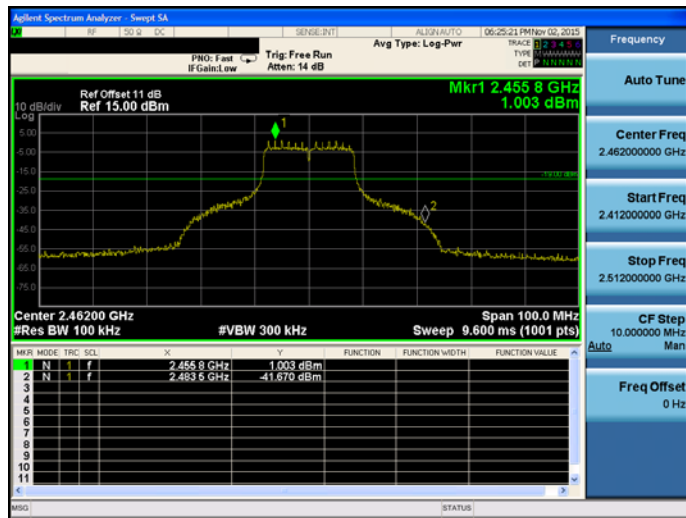

Mode 9: AR9331_ IEEE 802.11n 2.4GHz 20MHz link mode

2412



2462

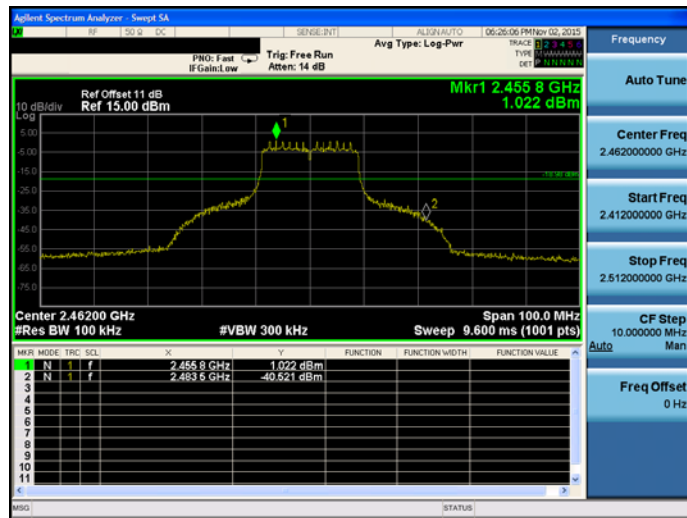

Mode 10: AR9331_ IEEE 802.11n 2.4GHz 40MHz link mode

2422

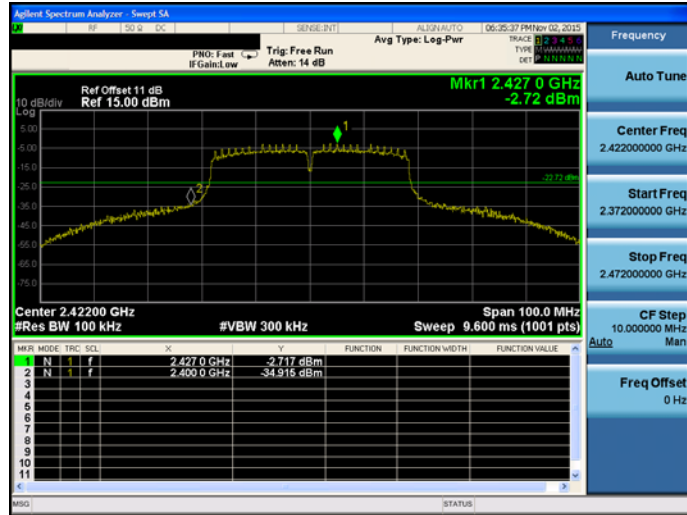

2452

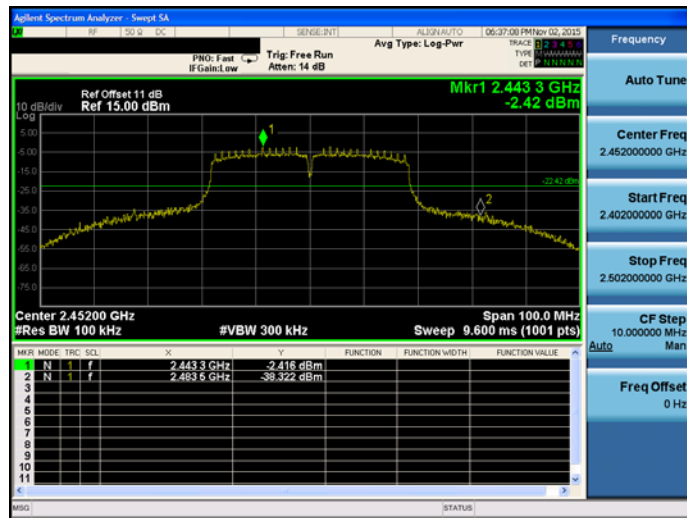

10 Antenna Measurement

10.1.Limit

For intentional device, according to 15.203, an intentional radiator shall be designed to ensure that no antenna other than that furnished by the responsible party shall be used with the device.

And According to 15.247 (b), if transmitting antennas of directional gain greater than 6 dBi are used, the power shall be reduced by the amount in dB that the directional gain of the antenna exceeds 6dBi.

10.2.Antenna Connector Construction

The antenna used in this product is Dipole Antenna (Reversed-SMA Connector). And the maximum Gain of this antenna is only 2 dBi.