

TEST REPORT

Product : WisePad 2 Plus
Trade mark : BBPOS
Model/Type reference : WPP23
Serial Number : N/A
Report Number : EED32J00113705
FCC ID : 2AB7X-WPP23
Date of Issue : Jul. 11, 2017
Test Standards : 47 CFR Part 2
47 CFR Part 22 subpart H
47 CFR Part 24 subpart E
Test result : PASS

Prepared for:

BBPOS International Limited
Suite 1602, 16/F, Tower 2, Nina Tower, No. 8 Yeung Uk Road,
Tsuen Wan, NT, Hong Kong

Prepared by:

Centre Testing International Group Co., Ltd.
Hongwei Industrial Zone, Bao'an 70 District,
Shenzhen, Guangdong, China
TEL: +86-755-3368 3668
FAX: +86-755-3368 3385

Tested By:

Tom chen

Tom chen (Test Project)

Compiled by:

Kevin Yang

Kevin yang (Project Engineer)

Reviewed by:

Ware Xin

Ware xin (Reviewer)

Approved by:

Sheek Luo

Sheek Luo (Lab supervisor)

Date:

Jul. 11, 2017

Report Seal

Check No.:2496595088



2 Version

Version No.	Date	Description
00	Jul. 11, 2017	Original

3 Test Summary

GSM 850, WCDMA(Band V)			
Test Item	Test Requirement	Test method	Result
Conducted output power	Part 2.1046(a)/Part 22.913(a)	TIA-603-E-2016 &KDB 971168 D01v02r02	PASS
Effective Radiated Power of Transmitter(ERP)	Part 2.1046(a)/Part 22.913(a)	TIA-603-E-2016 &KDB 971168 D01v02r02	PASS
99%&26dB Occupied Bandwidth	Part 2.1049(h)	Part 22.917(b) &KDB 971168 D01v02r02	PASS
Band Edge at antenna terminals	Part 2.1051/Part 22.917(a)	Part 22.917(b) &KDB 971168 D01v02r02	PASS
Spurious emissions at antenna terminals	Part 2.1051/ Part 2.1057/ Part 22.917(a)(b)	TIA-603-E-2016 &KDB 971168 D01v02r02	PASS
Field strength of spurious radiation	Part 2.1053/ Part 2.1057/ Part 22.917(a)(b)	TIA-603-E-2016 &KDB 971168 D01v02r02	PASS
Frequency stability	Part 2.1055/ Part 22.355	TIA-603-E-2016 &KDB 971168 D01v02r02	PASS
GSM 1900,WCDMA(Band II)			
Test Item	Test Requirement	Test method	Result
Conducted output power	Part 2.1046(a) /Part 24.232(c)	TIA-603-E-2016&KDB 971168 D01v02r02	PASS
Effective Radiated Power of Transmitter(EIRP)	Part 2.1046(a) / Part 24.232(c)	TIA-603-E-2016 &KDB 971168 D01v02r02	PASS
peak-to-average ratio	Part 24.232(d)	KDB 971168 D01v02r02	PASS
99% &26dB Occupied Bandwidth	Part 2.1049(h)	Part 24.238(b) &KDB 971168 D01v02r02	PASS
Band Edge at antenna terminals	Part 2.1051/ Part 24.238(a)	Part 24.238(b) &KDB 971168 D01v02r02	PASS
Spurious emissions at antenna terminals	Part 2.1051/ Part 2.1057/ Part 24.238(a)(b)	TIA-603-E-2016 &KDB 971168 D01v02r02	PASS
Field strength of spurious radiation	Part 2.1053 /Part 2.1057 / Part 24.238(a)(b)	TIA-603-E-2016 &KDB 971168 D01v02r02	PASS
Frequency stability	Part 2.1055/Part 24.235	TIA-603-E-2016 &KDB 971168 D01v02r02	PASS

Remark:

The tested sample and the sample information are provided by the client.

4 Content

1 COVER PAGE	1
2 VERSION	2
3 TEST SUMMARY	3
4 CONTENT	4
5 TEST REQUIREMENT	5
5.1 TEST SETUP.....	5
5.1.1 For Conducted test setup.....	5
5.1.2 For Radiated Emissions test setup.....	5
5.2 TEST ENVIRONMENT.....	6
5.3 TEST CONDITION.....	6
6 GENERAL INFORMATION	8
6.1 CLIENT INFORMATION.....	8
6.2 GENERAL DESCRIPTION OF EUT.....	8
6.3 PRODUCT SPECIFICATION SUBJECTIVE TO THIS STANDARD.....	8
6.4 DESCRIPTION OF SUPPORT UNITS.....	8
6.5 TEST FACILITY.....	9
6.6 DEVIATION FROM STANDARDS.....	9
6.7 ABNORMALITIES FROM STANDARD CONDITIONS.....	9
6.8 OTHER INFORMATION REQUESTED BY THE CUSTOMER.....	9
6.9 MEASUREMENT UNCERTAINTY (95% CONFIDENCE LEVELS, K=2).....	9
7 EQUIPMENT LIST	10
8 RADIO TECHNICAL REQUIREMENTS SPECIFICATION	12
Appendix A)RF Power Output.....	13
Appendix B)Peak-to-Average Ratio.....	19
Appendix C)BandWidth.....	29
Appendix D)Band Edges Compliance.....	46
Appendix E)Spurious Emission at Antenna Terminal.....	57
Appendix F)Frequency Stability.....	133
Appendix G): Effective Radiated Power of Transmitter (ERP/EIRP).....	147
Appendix H): Field strength of spurious radiation.....	151
PHOTOGRAPHS OF TEST SETUP	167
PHOTOGRAPHS OF EUT CONSTRUCTIONAL DETAILS	169

5 Test Requirement

5.1 Test setup

5.1.1 For Conducted test setup

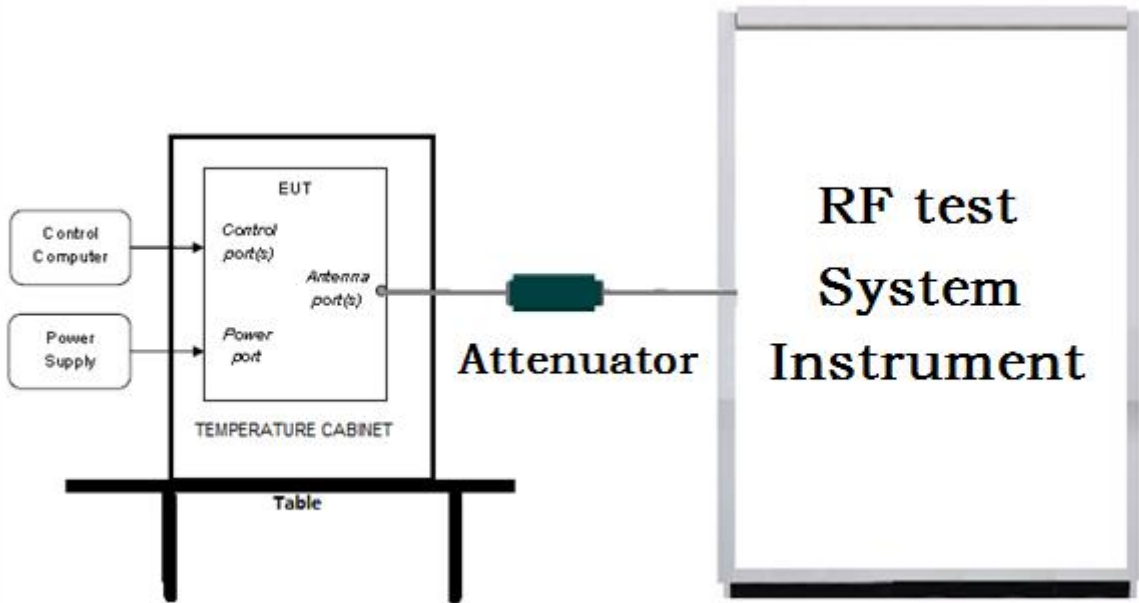

5.1.2 For Radiated Emissions test setup

Radiated Emissions setup:

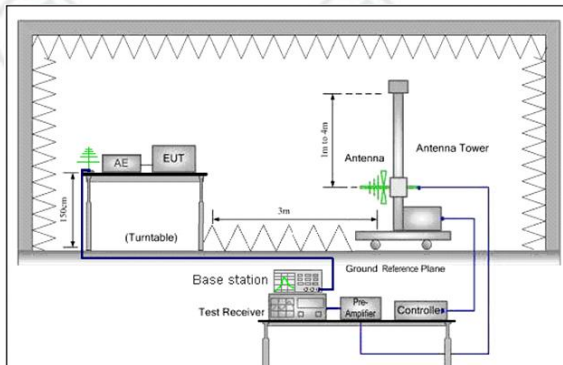

Figure 1.30MHz to 1GHz

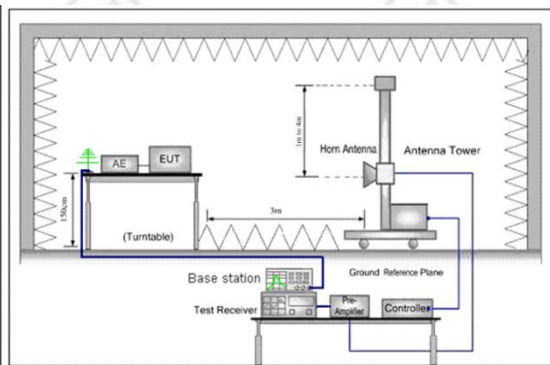

Figure 2. above 1GHz

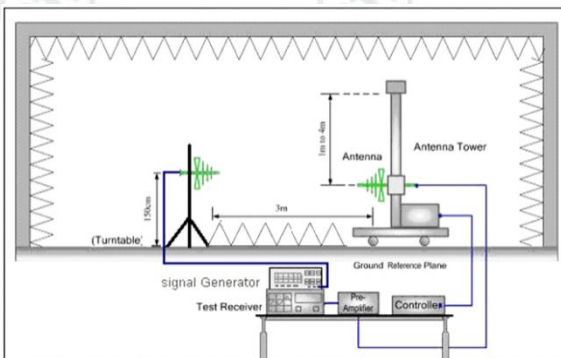

Figure 1. 30MHz to 1GHz

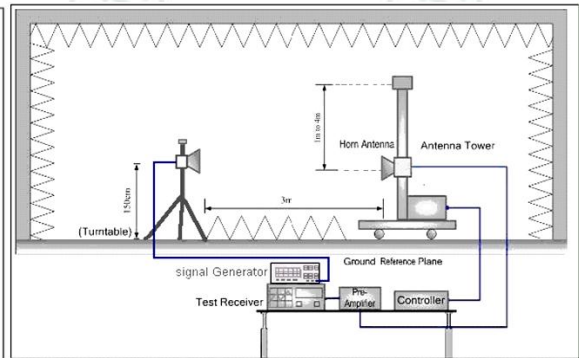

Figure 2. above 1GHz

5.2 Test Environment

Operating Environment:	
Temperature:	22°C
Humidity:	55% RH
Atmospheric Pressure:	1010mbar

5.3 Test Condition

Test channel:

Test Mode	Tx/Rx	RF Channel		
		Low(L)	Middle(M)	High(H)
GPRS/ EDGE850	Tx (824 MHz ~849 MHz)	Channel 128	Channel 190	Channel 251
		824.2MHz	836.6 MHz	848.8 MHz
	Rx (869 MHz ~894 MHz)	Channel 128	Channel 190	Channel 251
		869.2 MHz	881.6 MHz	893.8 MHz
WCDMA/HSD PA HSUPA HSPA+(Down Link) band V	Tx (824 MHz ~849 MHz)	Channel 4132	Channel 4182	Channel 4233
		826.4 MHz	836.4 MHz	846.6 MHz
	Rx (869 MHz ~894 MHz)	Channel 4357	Channel 4407	Channel 4458
		871.4 MHz	881.4 MHz	891.6 MHz
GPRS/ EDGE1900	Tx (1850 MHz ~1910 MHz)	Channel 512	Channel 661	Channel 810
		1850.2MHz	1880.0 MHz	1909.8 MHz
	Rx (1930 MHz ~1990 MHz)	Channel 512	Channel 661	Channel 810
		1930.2 MHz	1960.0 MHz	1989.8 MHz
WCDMA/HSD PA HSUPA HSPA+(Down Link) Band II	Tx (1850 MHz ~1910 MHz)	Channel 9262	Channel 9400	Channel 9538
		1852.4 MHz	1880.0 MHz	1907.6 MHz
	Rx (1930 MHz ~1990 MHz)	Channel 9662	Channel 9800	Channel 9938
		1932.4 MHz	1960.0 MHz	1987.6 MHz

Pre-scan all mode and data rates and positions,find the worse case mode as below:

band	Radiated	Conducted
GPRS/EDGE 850	1)GPRS 8 Link 2)EDGE 8 Link	1)GPRS 8 Link 2)EDGE 8 Link
GPRS/EDGE 1900	1)GPRS 8 Link 2)EDGE 8 Link	1)GPRS 8 Link 2)EDGE 8 Link
WCDMA Band V	1)RMC 12.2Kbps Link 2)HSDPA 3)HSUPA	1)RMC 12.2Kbps Link 2)HSDPA 3)HSUPA
WCDMA Band II	1)RMC 12.2Kbps Link 2)HSDPA 3)HSUPA	1)RMC 12.2Kbps Link 2)HSDPA 3)HSUPA

Test mode:

Test Mode	Test Modes description
GSM/TM2	GSM system, GPRS, GMSK modulation
GSM/TM3	GSM system, EDGE, 8PSK modulation
Test Mode	Test Modes description
UMTS/TM1	WCDMA system, QPSK modulation
UMTS/TM2	HSDPA system, QPSK modulation
UMTS/TM3	HSUPA system, QPSK modulation

6 General Information

6.1 Client Information

Applicant:	BBPOS International Limited
Address of Applicant:	Suite 1602, 16/F, Tower 2, Nina Tower, No. 8 Yeung Uk Road, Tsuen Wan, NT, Hong Kong
Manufacturer:	BBPOS International Limited
Address of Manufacturer:	Suite 1602, 16/F, Tower 2, Nina Tower, No. 8 Yeung Uk Road, Tsuen Wan, NT, Hong Kong

6.2 General Description of EUT

Product Name:	WisePad 2 Plus
Mode No.(EUT):	WPP23
Trade Mark:	BBPOS
EUT Supports Radios application:	GPRS/EDGE 850/1900 WCDMA/HSDPA /HSUPA Band V/Band II
Firmware version of the sample:	0.06.01.03
Hardware version of the sample:	V1.0.0
Power Supply:	DC 3.7V by Battery DC 5V by USB port
Battery	Li-polymer 3.7V, 1300mAh
Sample Received Date:	Jun. 7, 2017
Sample tested Date:	Jun. 7, 2017 to Jul. 5, 2017

6.3 Product Specification subjective to this standard

Frequency Band:	GPRS/EDGE 850: Tx:824.20 -848.80MHz; Rx: 869.20 – 893.80MHz GPRS/EDGE 1900: Tx:1850.20 – 1909.80MHz; Rx:1930.20 – 1989.80MHz WCDMA/HSDPA/HSUPA Band V: Tx:826.40 -846.60MHz; Rx: 871.40 – 891.60MHz WCDMA/HSDPA/HSUPA Band II: Tx:1852.40 – 1907.60MHz; Rx:1932.40 – 1987.60MHz
Modulation Type:	GPRS Mode with GMSK Modulation EDGE Mode with 8PSK Modulation WCDMA Mode with QPSK Modulation
Sample Type:	Portable
Antenna Type:	Monopole
Antenna Gain:	GSM850MHz: -2dBi GSM1900MHz: 0dBi WCDMA1900MHz: 0dBi WCDMA850MHz: -2dBi
Test Voltage:	DC 3.7V by Battery DC 5V by USB port

6.4 Description of Support Units

The EUT has been tested independently.

6.5 Test Facility

Test location

The test site a is located on *Hongwei Industrial Zone, Bao'an 70 District, Shenzhen, Guangdong, China.*

Test site at Centre Testing International Group Co., Ltd has been fully described in reports submitted to the Federal Communication Commission (FCC). The details of these reports have been found to be in compliance with the requirements of Section 2.948 of the FCC Rules on November 06, 2014.

The facility also complies with the radiated and AC line conducted test site criteria set forth in ANSI C63.4-2014.

FCC-Registration No.: 886427

Centre Testing International Group Co., Ltd. EMC Laboratory has been registered and fully described in a report filed with the FCC (Federal Communications Commission). The acceptance letter from the FCC is maintained in our files. Registration 886427.

6.6 Deviation from Standards

None.

6.7 Abnormalities from Standard Conditions

None.

6.8 Other Information Requested by the Customer

None.

6.9 Measurement Uncertainty (95% confidence levels, k=2)

No.	Item	Measurement Uncertainty
1	Radio Frequency	7.9×10^{-8}
2	RF power, conducted	0.31dB (30MHz-1GHz)
		0.57dB (1GHz-18GHz)
3	Radiated Spurious emission test	4.5dB (30MHz-1GHz)
		4.8dB (1GHz-12.75GHz)
4	Conduction emission	3.6dB (9kHz to 150kHz)
		3.2dB (150kHz to 30MHz)
5	Temperature test	0.64°C
6	Humidity test	2.8%
7	DC power voltages	0.025%

7 Equipment List

Communication RF test system					
Equipment	Manufacturer	Mode No.	Serial Number	Cal. Date (mm-dd-yyyy)	Cal. Due date (mm-dd-yyyy)
Spectrum Analyzer	Agilent	E4440A	MY46185649	12-16-2016	12-15-2017
Signal Generator	Agilent	E4438C	MY45095744	03-14-2017	03-13-2018
Communication test set	Agilent	E5515C	GB47050534	03-14-2017	03-13-2018
Signal Generator	Keysight	E8257D	MY53401106	03-14-2017	03-13-2018
Communication test set	R&S	CMW500	152394	03-14-2017	03-13-2018
High-pass filter	Sinoscite	FL3CX03WG18 NM12-0398-002	---	01-12-2017	01-11-2018
High-pass filter	MICRO-TRONICS	SPA-F-63029-4	---	01-12-2017	01-11-2018
band rejection filter	Sinoscite	FL5CX01CA09C L12-0395-001	---	01-12-2017	01-11-2018
band rejection filter	Sinoscite	FL5CX01CA08C L12-0393-001	---	01-12-2017	01-11-2018
band rejection filter	Sinoscite	FL5CX02CA04C L12-0396-002	---	01-12-2017	01-11-2018
band rejection filter	Sinoscite	FL5CX02CA03C L12-0394-001	---	01-12-2017	01-11-2018
DC Power	Keysight	E3642A	MY54426112	03-14-2017	03-13-2018
DC Power	Keysight	E3642A	MY54426115	03-14-2017	03-13-2018
PC-2	Lenovo	R4960d	---	04-01-2017	03-31-2018
PC-3	Lenovo	R4960d	---	04-01-2017	03-31-2018
RF control unit	JS Tonscend	JS0806-1	158060004	03-14-2017	03-13-2018
DC power Box	JS Tonscend	JS0806-4	158060007	04-01-2017	03-31-2018
LTE Automatic test software	JS Tonscend	JS1120-1	---	04-01-2017	03-31-2018
WCDMA Automatic test software	JS Tonscend	JS1120-3	---	04-01-2017	03-31-2018
GSM Automatic test software	JS Tonscend	JS1120-3	---	04-01-2017	03-31-2018

Radiated Spurious Emission & Radiated Emission					
Equipment	Manufacturer	Mode No.	Serial Number	Cal. date (mm-dd-yyyy)	Cal. Due date (mm-dd-yyyy)
3M Chamber & Accessory Equipment	TDK	SAC-3	---	06-05-2016	06-05-2019
TRILOG Broadband Antenna	SCHWARZBECK	VULB9163	9163-484	05-23-2017	05-22-2018
Microwave Preamplifier	Agilent	8449B	3008A02425	02-16-2017	02-15-2018
Horn Antenna	ETS-LINDGREN	3117	00057407	07-20-2015	07-18-2018
Loop Antenna	ETS	6502	00071730	07-30-2015	07-28-2017
Spectrum Analyzer	R&S	FSP40	100416	06-13-2017	06-12-2018
Receiver	R&S	ESCI	100435	06-13-2017	06-12-2018
Multi device Controller	matureo	NCD/070/10711 112	---	01-12-2017	01-11-2018
LISN	schwarzbeck	NNBM8125	81251547	06-13-2017	06-12-2018
LISN	schwarzbeck	NNBM8125	81251548	06-13-2017	06-12-2018
Signal Generator	Agilent	E4438C	MY45095744	03-14-2017	03-13-2018
Signal Generator	Keysight	E8257D	MY53401106	03-14-2017	03-13-2018
Temperature/ Humidity Indicator	TAYLOR	1451	1905	05-08-2017	05-07-2018
Communication test set	Agilent	E5515C	GB47050534	03-14-2017	03-13-2018
Cable line	Fulai(7M)	SF106	5219/6A	01-12-2017	01-11-2018
Cable line	Fulai(6M)	SF106	5220/6A	01-12-2017	01-11-2018
Cable line	Fulai(3M)	SF106	5216/6A	01-12-2017	01-11-2018
Cable line	Fulai(3M)	SF106	5217/6A	01-12-2017	01-11-2018
Communication test set	R&S	CMW500	152394	03-14-2017	03-13-2018
High-pass filter(3-18GHz)	Sinoscite	FL3CX03WG18 NM12-0398-002	---	01-12-2017	01-11-2018
High-pass filter(6-18GHz)	MICRO-TRONICS	SPA-F-63029-4	---	01-12-2017	01-11-2018
band rejection filter	Sinoscite	FL5CX01CA09C L12-0395-001	---	01-12-2017	01-11-2018
band rejection filter	Sinoscite	FL5CX01CA08C L12-0393-001	---	01-12-2017	01-11-2018
band rejection filter	Sinoscite	FL5CX02CA04C L12-0396-002	---	01-12-2017	01-11-2018
band rejection filter	Sinoscite	FL5CX02CA03C L12-0394-001	---	01-12-2017	01-11-2018

8 Radio Technical Requirements Specification

Reference documents for testing:

No.	Identity	Document Title
1	PART 22 (2015)	PART 22 – PUBLIC MOBILE SERVICES Subpart H – Cellular Radiotelephone Service
2	PART 24 (2015)	PART 24 – PERSONAL COMMUNICATIONS SERVICES Subpart E – Broadband PCS
3	PART 2 (2015)	Frequency allocations and radio treaty matters; general rules and regulations
4	TIA-603-E-2016	Land Mobile FM or PM -Communications Equipment -Measurement and Performance Standards
5	KDB971168 D01	KDB971168 D01 Power Meas License Digital Systems v02r02

Test Results List:

Test Requirement	Test method	Test item	Verdict	Note
Part 2.1046(a)/Part 22.913(a)/ part 24.232(c)	TIA-603-E&KDB 971168 D01v02r02	Conducted output power	PASS	Appendix A)
Part 24.232(d)	KDB 971168 D01v02r02	peak-to-average ratio	PASS	Appendix B)
Part 2.1049(h)	Part 22.917(b)/ Part 24.238(b) &KDB 971168 D01v02r02	99% &26dB Occupied Bandwidth	PASS	Appendix C)
Part 2.1051/Part 22.917(a)/ Part 24.238(a)	Part 22.917(b)/ Part 24.238(b) &KDB 971168 D01v02r02	Band Edge at antenna terminals	PASS	Appendix D)
Part 2.1051/ Part 2.1057/ Part 22.917(a)(b)/ Part 24.238(a)(b)	TIA-603-E &KDB 971168 D01v02r02	Spurious emissions at antenna terminals	PASS	Appendix E)
Part 2.1055/ Part 22.355/ Part 24.235	TIA-603-E &KDB 971168 D01v02r02	Frequency stability	PASS	Appendix F)
Part 2.1046(a)/Part 22.913(a)/ Part 24.232(c)	TIA-603-E &KDB 971168 D01v02r02	Effective Radiated Power of Transmitter(ERP)	PASS	Appendix G)
Part 2.1053/ Part 2.1057/ Part 22.917(a)(b)/ Part 24.238(a)(b)	TIA-603-E &KDB 971168 D01v02r02	Field strength of spurious radiation	PASS	Appendix H)

Appendix A)RF Power Output

Test Requirement:	Part 2.1046(a)		
Test Method:	TIA-603-E-2016 Clause 2.2.1		
Test Setup:	Refer to section 5 for details		
Limit:	Mode	GSM 850/WCDMA/HSDPA /HSUPA 850 Band V	GSM 1900/WCDMA/HSDPA /HSUPA 1900 Band II
	Frequency	824 – 849MHz	1850 – 1910MHz
	Limit	38.45dBm (ERP)	33.01dBm (EIRP)
Measurement Procedure:	The transmitter output was connected to a calibrated coaxial cable, attenuator and power meter, the other end of which was connected to a Base Station Simulator. The Base Station Simulator was set to force the EUT to its maximum power setting. The power output at the transmitter antenna port was determined by adding the value of the cable insertion loss to the power reading. The tests were performed at three frequencies (low channel, middle channel and high channel) and on the highest power levels, which can be setup on the transmitters.		
Instruments Used:	Refer to section 7 for details		
Test Results:	Pass		

Test Data:

Test Band	Test Mode	Test Channel	Test Slot	Measured(dbm)	Limit (dbm)	Verdict
GSM850	GSM/TM2	LCH	Slot1	32.39	38.5	PASS
			Slot2	32.10	38.5	PASS
			Slot3	30.43	38.5	PASS
			Slot4	29.41	38.5	PASS
		MCH	Slot1	32.69	38.5	PASS
			Slot2	32.61	38.5	PASS
			Slot3	30.78	38.5	PASS
			Slot4	29.73	38.5	PASS
		HCH	Slot1	32.68	38.5	PASS
			Slot2	32.54	38.5	PASS
			Slot3	30.76	38.5	PASS
			Slot4	29.77	38.5	PASS
Test Band	Test Mode	Test Channel	Test Slot	Measured(dbm)	Limit (dbm)	Verdict
GSM850	GSM/TM3	LCH	Slot1	26.64	38.5	PASS
			Slot2	26.97	38.5	PASS
			Slot3	26.93	38.5	PASS
			Slot4	26.90	38.5	PASS
		MCH	Slot1	26.57	38.5	PASS
			Slot2	26.91	38.5	PASS
			Slot3	26.86	38.5	PASS
			Slot4	26.83	38.5	PASS
		HCH	Slot1	26.80	38.5	PASS
			Slot2	27.06	38.5	PASS
			Slot3	27.05	38.5	PASS
			Slot4	27.02	38.5	PASS

Test Band	Test Mode	Test Channel	Test Slot	Measured(dbm)	Limit (dbm)	Verdict
GSM1900	GSM/TM2	LCH	Slot1	30.47	33	PASS
			Slot2	30.52	33	PASS
			Slot3	30.45	33	PASS
			Slot4	30.44	33	PASS
		MCH	Slot1	30.35	33	PASS
			Slot2	30.36	33	PASS
			Slot3	30.34	33	PASS
			Slot4	30.29	33	PASS
		HCH	Slot1	30.56	33	PASS
			Slot2	30.56	33	PASS
			Slot3	30.54	33	PASS
			Slot4	30.49	33	PASS
Test Band	Test Mode	Test Channel	Test Slot	Measured(dbm)	Limit (dbm)	Verdict
GSM1900	GSM/TM3	LCH	Slot1	26.64	33	PASS
			Slot2	25.95	33	PASS
			Slot3	25.94	33	PASS
			Slot4	25.90	33	PASS
		MCH	Slot1	26.57	33	PASS
			Slot2	25.82	33	PASS
			Slot3	25.82	33	PASS
			Slot4	25.82	33	PASS
		HCH	Slot1	25.79	33	PASS
			Slot2	26.07	33	PASS
			Slot3	26.11	33	PASS
			Slot4	26.05	33	PASS

Test Band	Test Mode	Test Channel	Measured(dbm)	Limit (dbm)	Verdict
WCDMA850	UMTS/TM1	LCH	23.30	38.5	PASS
		MCH	23.80	38.5	PASS
		HCH	23.10	38.5	PASS
Test Band	Test Mode	Test Channel	Measured(dbm)	Limit (dbm)	Verdict
WCDMA850	UMTS/TM2	LCH_SubTest-1	23.28	38.5	PASS
		LCH_SubTest-2	22.71	38.5	PASS
		LCH_SubTest-3	22.34	38.5	PASS
		LCH_SubTest-4	22.08	38.5	PASS
		MCH_SubTest-1	22.78	38.5	PASS
		MCH_SubTest-2	22.18	38.5	PASS
		MCH_SubTest-3	22.86	38.5	PASS
		MCH_SubTest-4	22.52	38.5	PASS
		HCH_SubTest-1	22.10	38.5	PASS
		HCH_SubTest-2	22.52	38.5	PASS
		HCH_SubTest-3	22.17	38.5	PASS
		HCH_SubTest-4	22.90	38.5	PASS
Test Band	Test Mode	Test Channel	Measured(dbm)	Limit (dbm)	Verdict
WCDMA850	UMTS/TM3	LCH_SubTest-1	22.81	38.5	PASS
		LCH_SubTest-2	23.10	38.5	PASS
		LCH_SubTest-3	22.28	38.5	PASS
		LCH_SubTest-4	22.04	38.5	PASS
		LCH_SubTest-5	22.80	38.5	PASS
		MCH_SubTest-1	22.26	38.5	PASS
		MCH_SubTest-2	22.48	38.5	PASS
		MCH_SubTest-3	22.89	38.5	PASS
		MCH_SubTest-4	22.48	38.5	PASS
		MCH_SubTest-5	22.25	38.5	PASS

		HCH_SubTest-1	22.52	38.5	PASS
		HCH_SubTest-2	22.74	38.5	PASS
		HCH_SubTest-3	22.17	38.5	PASS
		HCH_SubTest-4	22.72	38.5	PASS
		HCH_SubTest-5	22.57	38.5	PASS

Test Band	Test Mode	Test Channel	Measured(dbm)	Limit (dbm)	Verdict
WCDMA1900	UMTS/TM1	LCH	23.62	33	PASS
		MCH	22.74	33	PASS
		HCH	22.31	33	PASS

Test Band	Test Mode	Test Channel	Measured(dbm)	Limit (dbm)	Verdict
WCDMA1900	UMTS/TM2	LCH_SubTest-1	22.51	33	PASS
		LCH_SubTest-2	22.80	33	PASS
		LCH_SubTest-3	22.48	33	PASS
		LCH_SubTest-4	22.21	33	PASS
		MCH_SubTest-1	22.44	33	PASS
		MCH_SubTest-2	22.84	33	PASS
		MCH_SubTest-3	22.54	33	PASS
		MCH_SubTest-4	22.29	33	PASS
		HCH_SubTest-1	22.11	33	PASS
		HCH_SubTest-2	22.50	33	PASS
		HCH_SubTest-3	22.59	33	PASS
		HCH_SubTest-4	20.92	33	PASS

Test Band	Test Mode	Test Channel	Measured(dbm)	Limit (dbm)	Verdict
WCDMA1900	UMTS/TM3	LCH_SubTest-1	22.86	33	PASS
		LCH_SubTest-2	22.10	33	PASS
		LCH_SubTest-3	22.57	33	PASS
		LCH_SubTest-4	22.09	33	PASS
		LCH_SubTest-5	22.75	33	PASS

	MCH_SubTest-1	22.80	33	PASS
	MCH_SubTest-2	21.99	33	PASS
	MCH_SubTest-3	22.38	33	PASS
	MCH_SubTest-4	22.12	33	PASS
	MCH_SubTest-5	22.73	33	PASS
	HCH_SubTest-1	22.42	33	PASS
	HCH_SubTest-2	22.71	33	PASS
	HCH_SubTest-3	22.13	33	PASS
	HCH_SubTest-4	21.76	33	PASS
	HCH_SubTest-5	22.33	33	PASS

Appendix B) Peak-to-Average Ratio

Test Requirement:	Part 24.232(d)
Test Method:	KDB 971168 D01
Test Setup:	Refer to section 5 for details
Limit:	13dB
Measurement Procedure:	Use one of the procedures to measure the total peak power and record as PPK. Use one of the applicable procedures to measure the total average power and record as PAvg. Both the peak and average power levels must be expressed in the same logarithmic units (e.g., dBm). Determine the PAPR from: $PAPR (dB) = PPK (dBm) - PAvg (dBm)$.
Instruments Used:	Refer to section 7 for details
Test Results:	Pass

Test Data:

Test Band	Test Mode	Test Channel	Measured (db)	Limit (db)	Verdict
GSM1900	GSM/TM2	LCH	2.67	13	PASS
		MCH	2.67	13	PASS
		HCH	2.67	13	PASS
	GSM/TM3	LCH	5.36	13	PASS
		MCH	5.50	13	PASS
		HCH	5.58	13	PASS

1.1 Test Mode=GSM/TM2

1.1.1.1 Test Channel=LCH

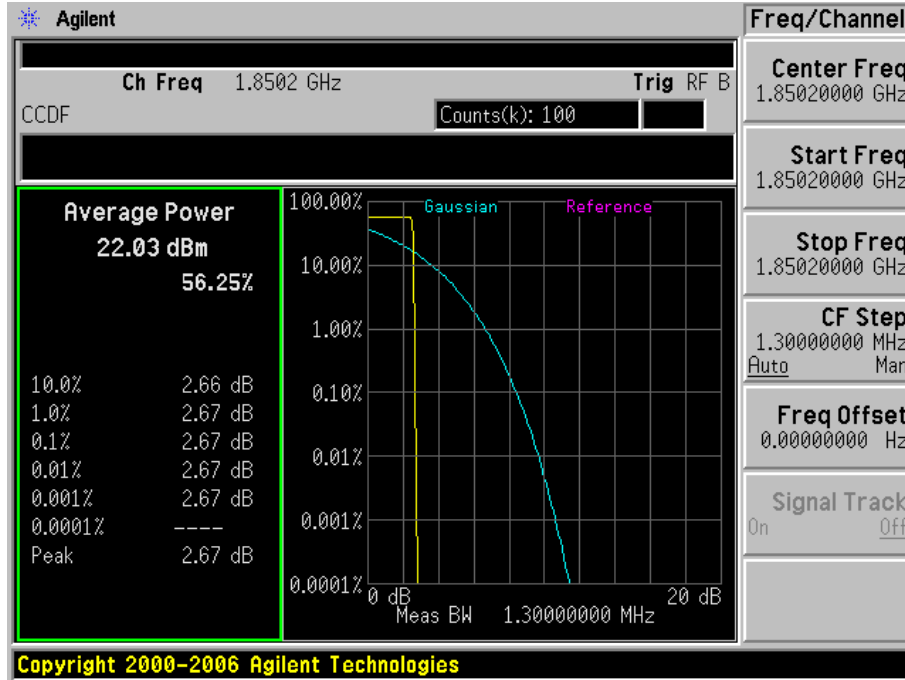

1.1.1.2 Test Channel=MCH

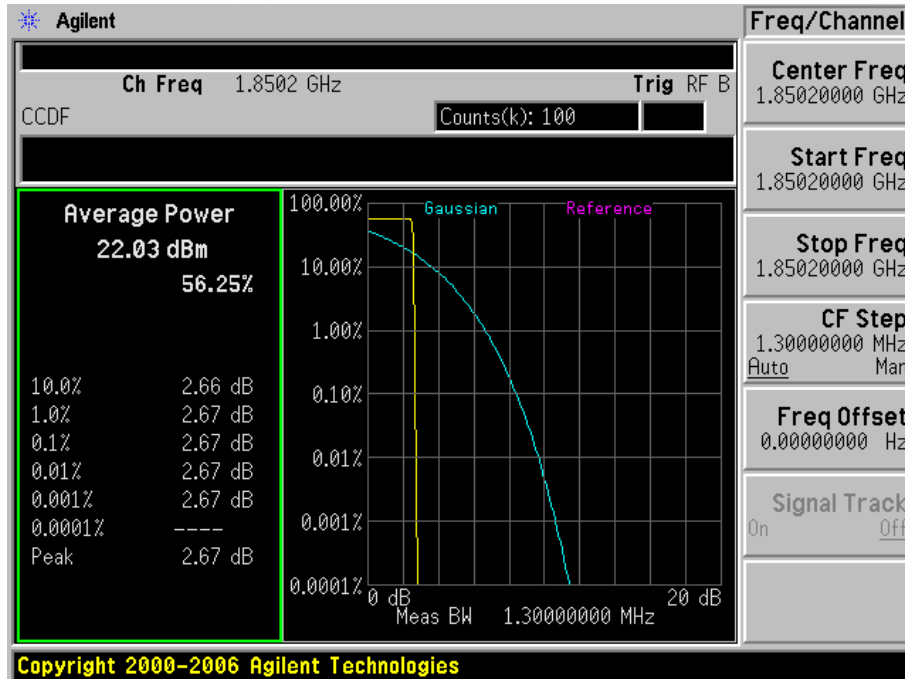

1.1.1.3 Test Channel=HCH

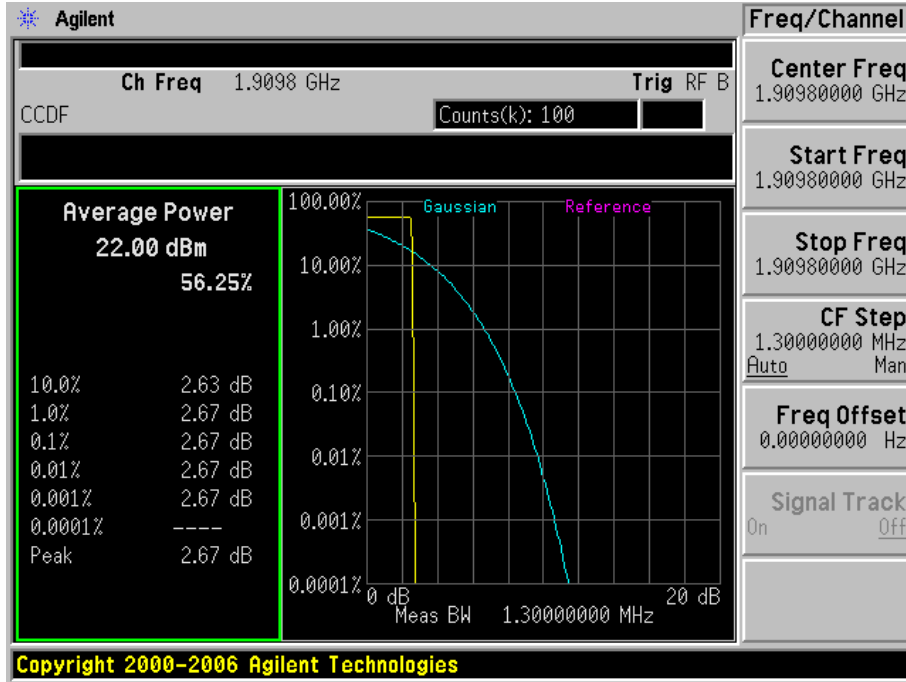

1.2 Test Mode=GSM/TM3

1.2.1.1 Test Channel=LCH

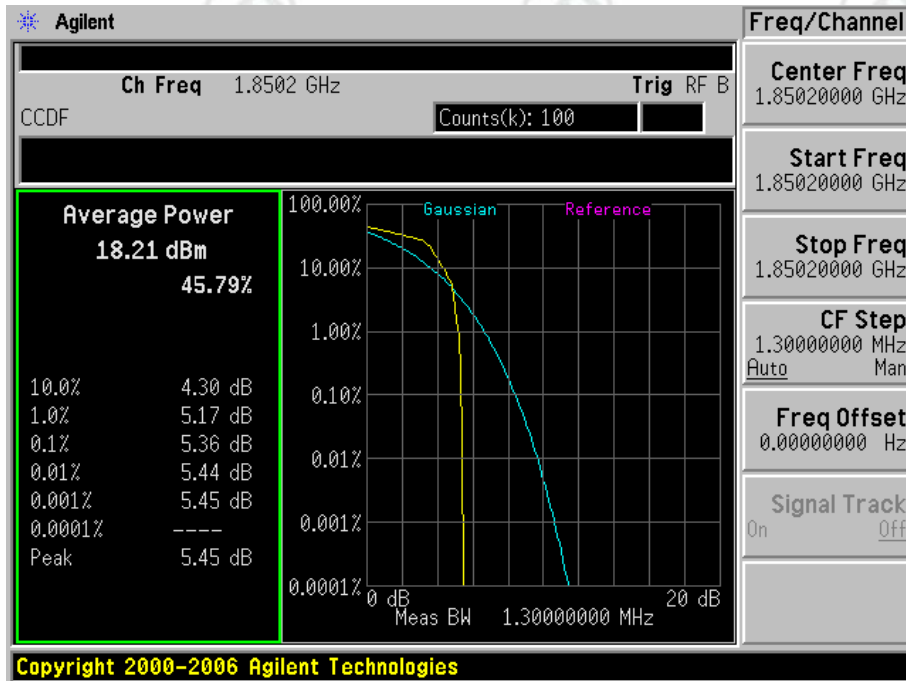

1.2.1.2 Test Channel=MCH

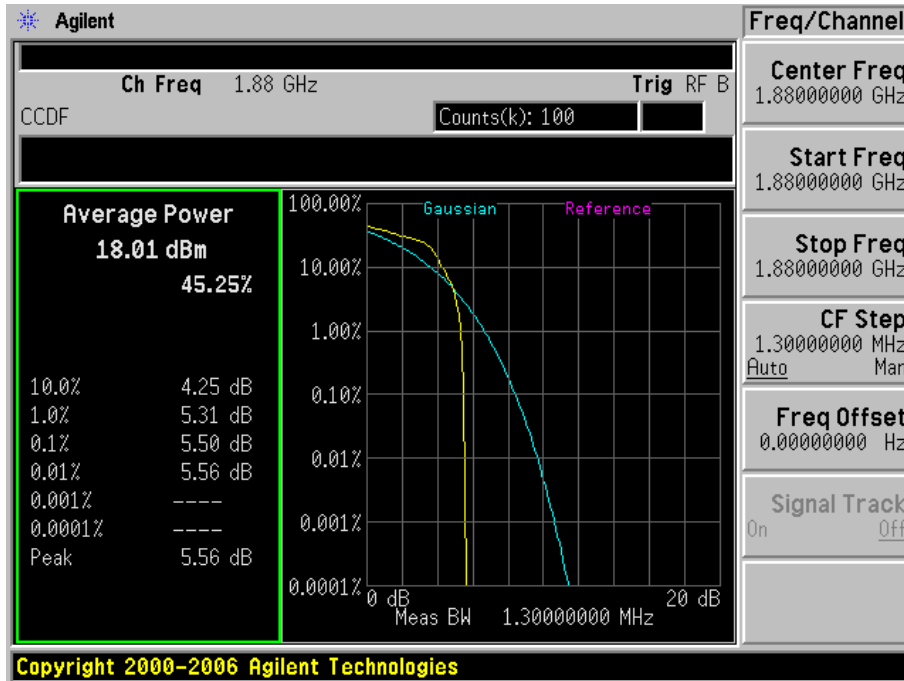

1.2.1.3 Test Channel=HCH

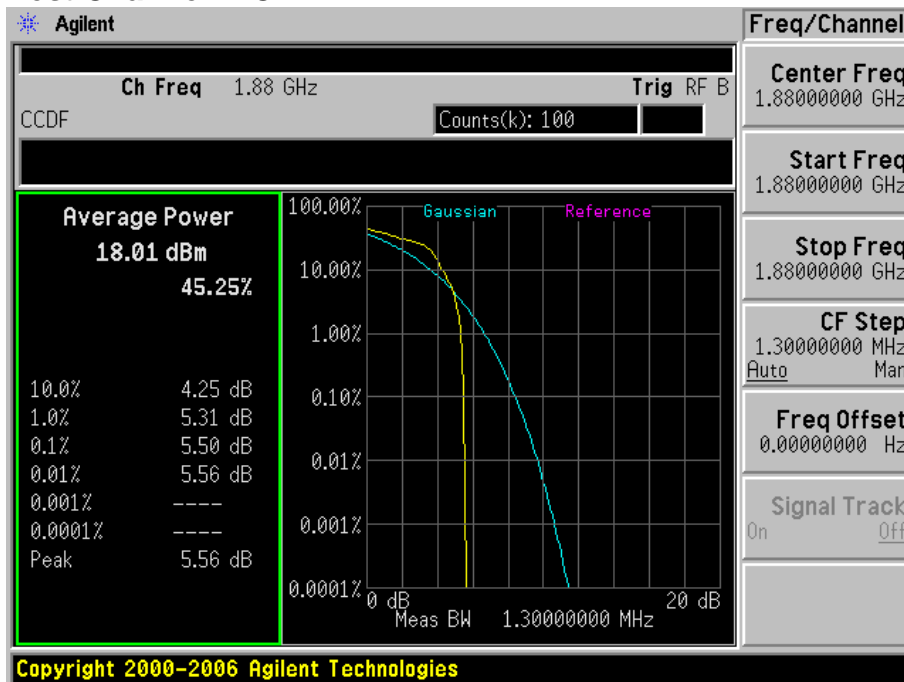

Test Band	Test Mode	Test Channel	Measured(db)	Limit (db)	Verdict
WCDMA1900	UMTS/TM1	LCH	2.82	13	PASS
		MCH	2.78	13	PASS
		HCH	2.75	13	PASS
Test Band	Test Mode	Test Channel	Measured(db)	Limit (db)	Verdict
WCDMA1900	UMTS/TM2	LCH	3.16	13	PASS
		MCH	3.26	13	PASS
		HCH	3.07	13	PASS
Test Band	Test Mode	Test Channel	Measured(db)	Limit (db)	Verdict
WCDMA1900	UMTS/TM3	LCH	4.39	13	PASS
		MCH	4.45	13	PASS
		HCH	4.46	13	PASS

1.1 Test Band=WCDMA1900

1.1.1 Test Mode=UMTS/TM1

1.1.1.1 Test Channel=LCH

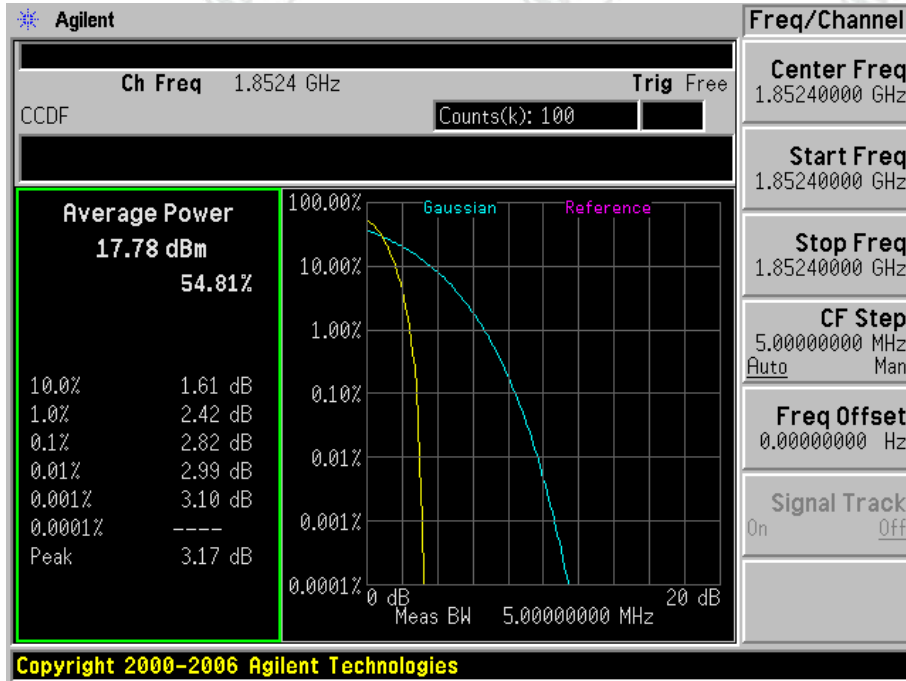

1.1.1.2 Test Channel=MCH

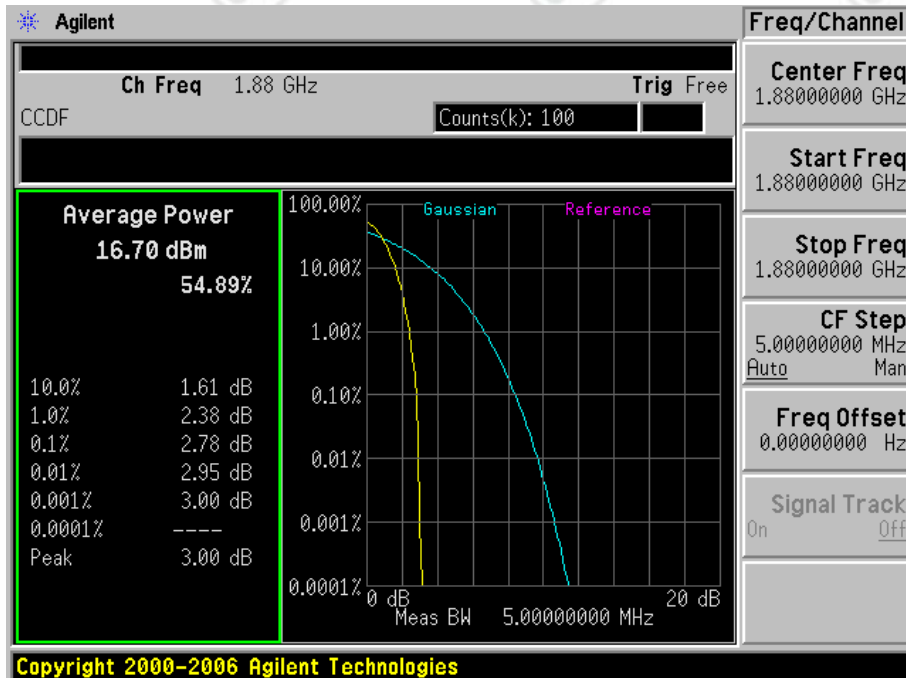

1.1.1.3 Test Channel=HCH

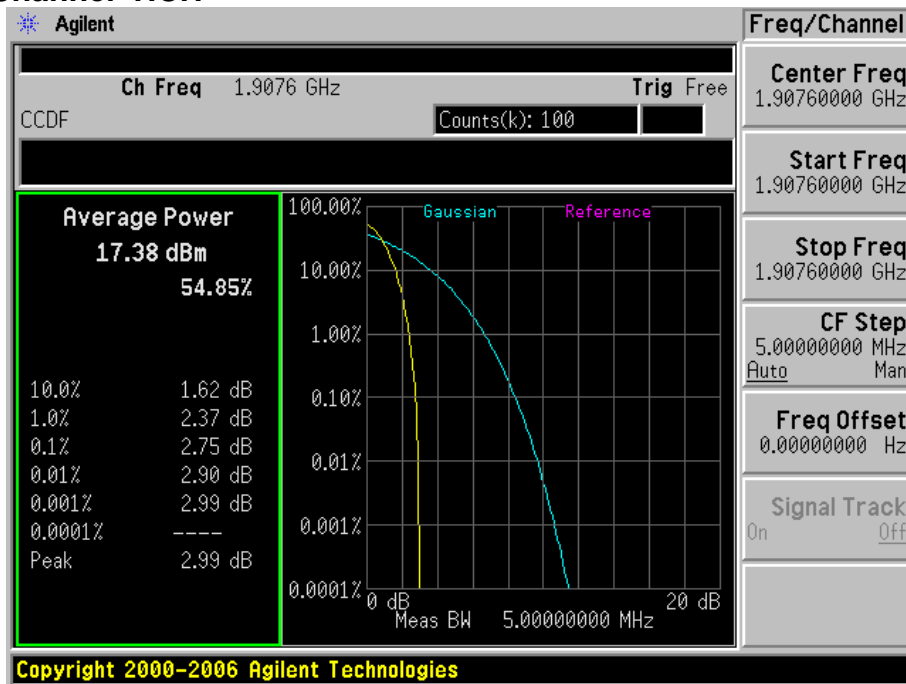

1.1.2 Test Mode=UMTS/TM2

1.1.2.1 Test Channel=LCH

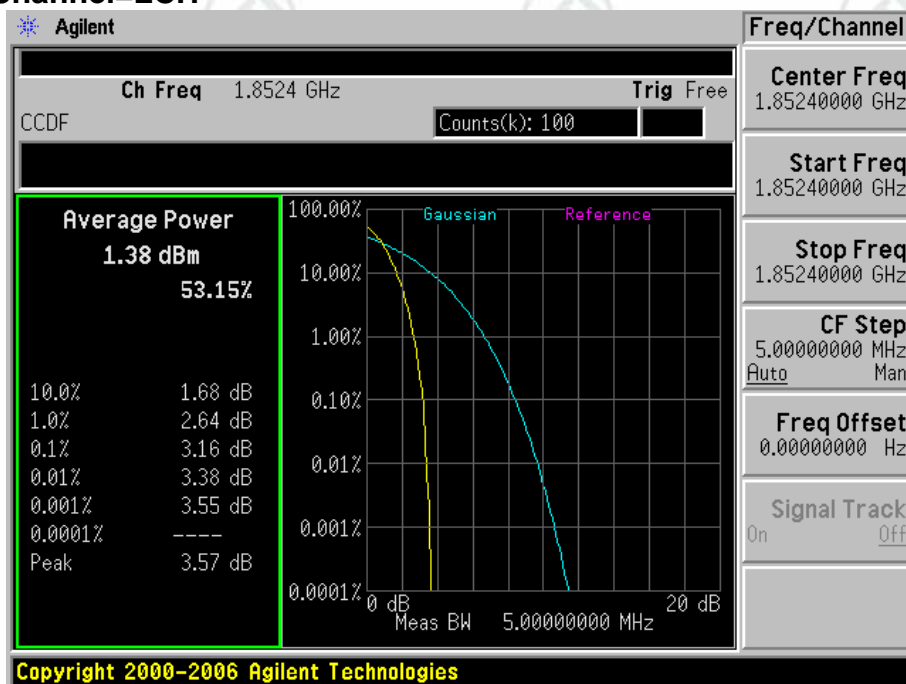

1.1.2.2 Test Channel=MCH

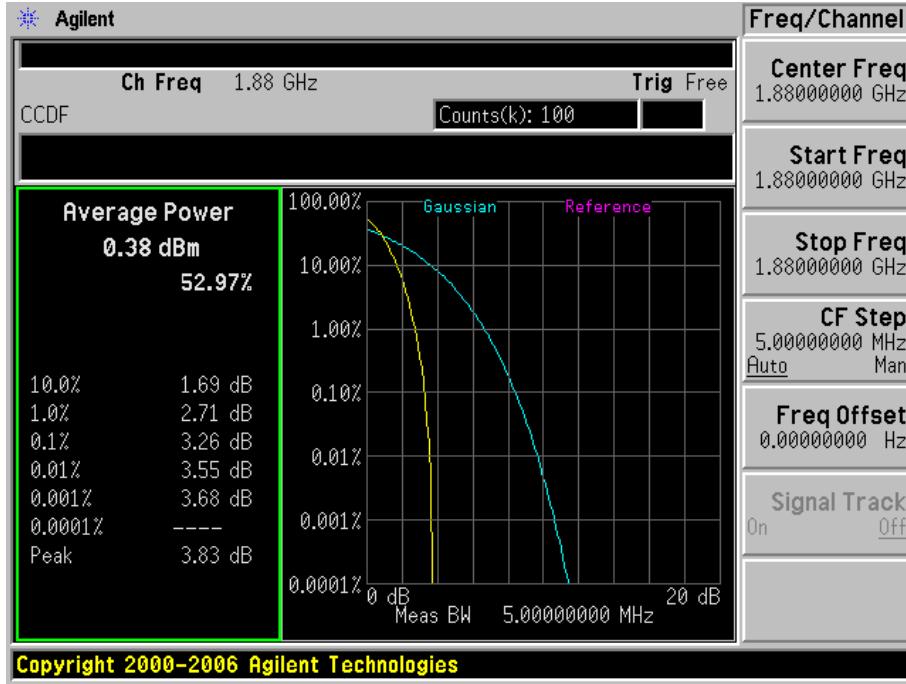

1.1.2.3 Test Channel=HCH

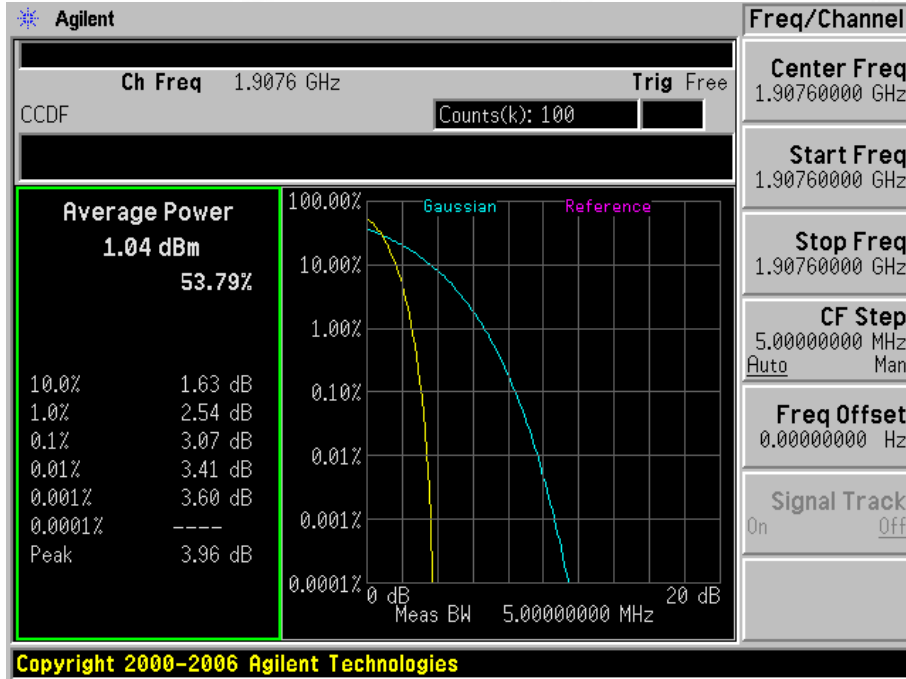

1.1.3 Test Mode=UMTS/TM3

1.1.3.1 Test Channel=LCH

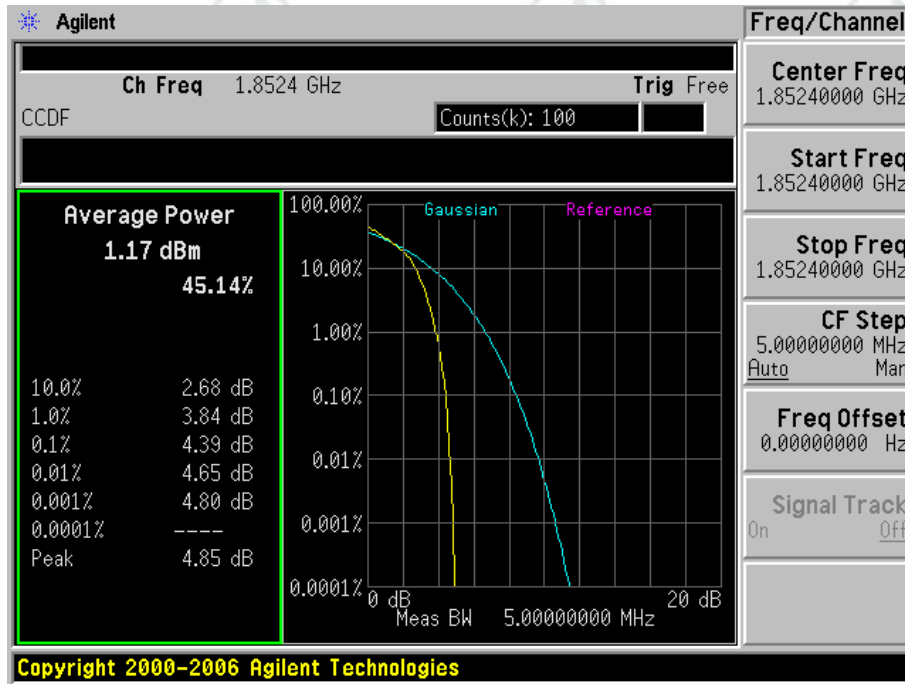

1.1.3.2 Test Channel=MCH

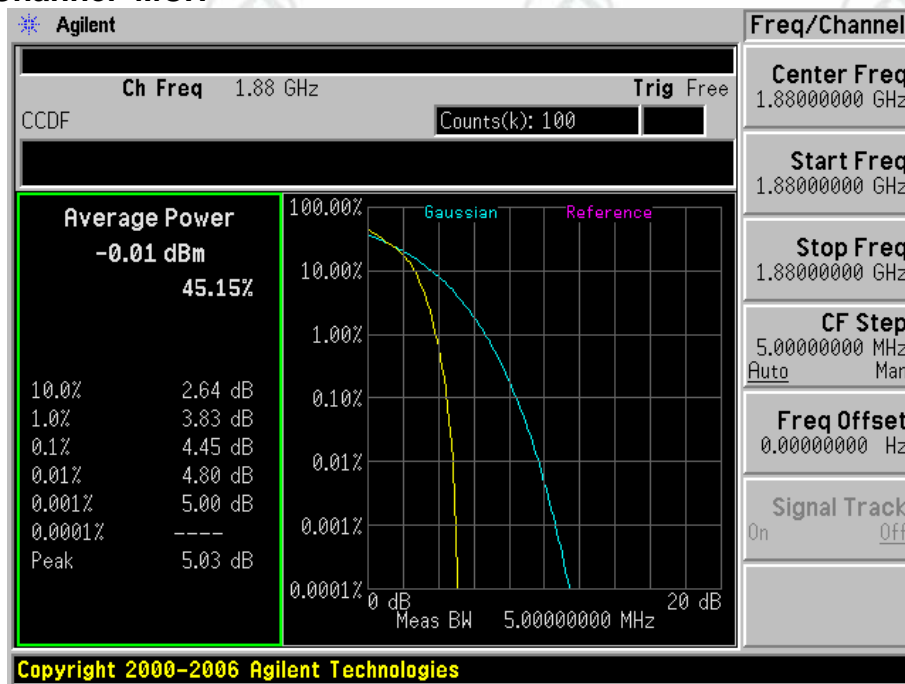

1.1.3.3 Test Channel=HCH

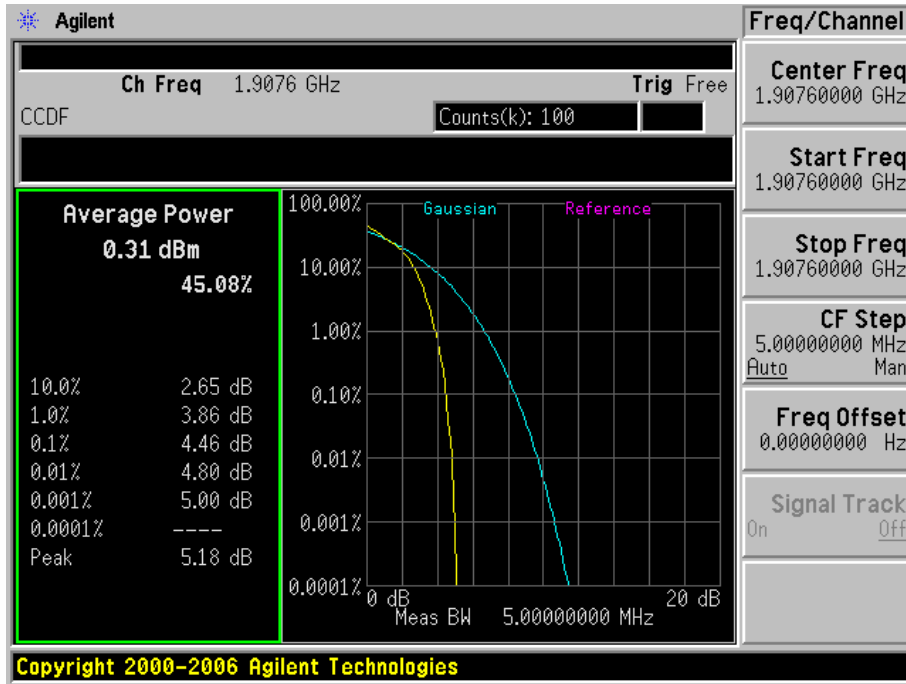

Appendix C)BandWidth

Test Requirement:	Part 2.1049(h)
Test Method:	Part 22.917(b)/Part 24.238(b)
Test Setup:	Refer to section 5 for details
Limit:	N/A
Measurement Procedure:	The transmitter output was connected to a calibrated coaxial cable, attenuator and Spectrum analyser, the other end of which was connected to a Base Station Simulator. The Base Station Simulator was set to force the EUT to its maximum power setting. The tests were performed at three frequencies (low channel, middle channel and high channel).the resolution bandwidth of the analyser is set to 100kHz or 1% of the emission bandwidth, the EUT emission bandwidth is measured as the width of the signal between two points, outside of which all emission are attenuated at least 26dB below the transmitter power. The video bandwidth of the spectrum analyzer was set at thrice the resolution bandwidth. Detector Mode was set to peak or peak hold power.
Instruments Used:	Refer to section 7 for details
Test Results:	Pass

Test data:

Test Band	Test Mode	Test Channel	Occupied Bandwidth (KHZ)	Emission Bandwidth (KHZ)	Verdict
GSM850	GSM/TM2	LCH	243.46	312.76	PASS
		MCH	243.35	312.63	PASS
		HCH	243.93	313.33	PASS
	GSM/TM3	LCH	249.81	315.57	PASS
		MCH	251.42	306.15	PASS
		HCH	249.78	313.74	PASS

Test Band	Test Mode	Test Channel	Occupied Bandwidth (KHZ)	Emission Bandwidth (KHZ)	Verdict
GSM1900	GSM/TM2	LCH	243.89	315.82	PASS
		MCH	247.57	314.41	PASS
		HCH	244.65	316.73	PASS
	GSM/TM3	LCH	249.69	313.17	PASS
		MCH	251.57	320.76	PASS
		HCH	250.23	310.40	PASS

1.1 Test GSM 850
1.1.1 Test Mode=GSM/TM2
1.1.1.1 Test Channel=LCH

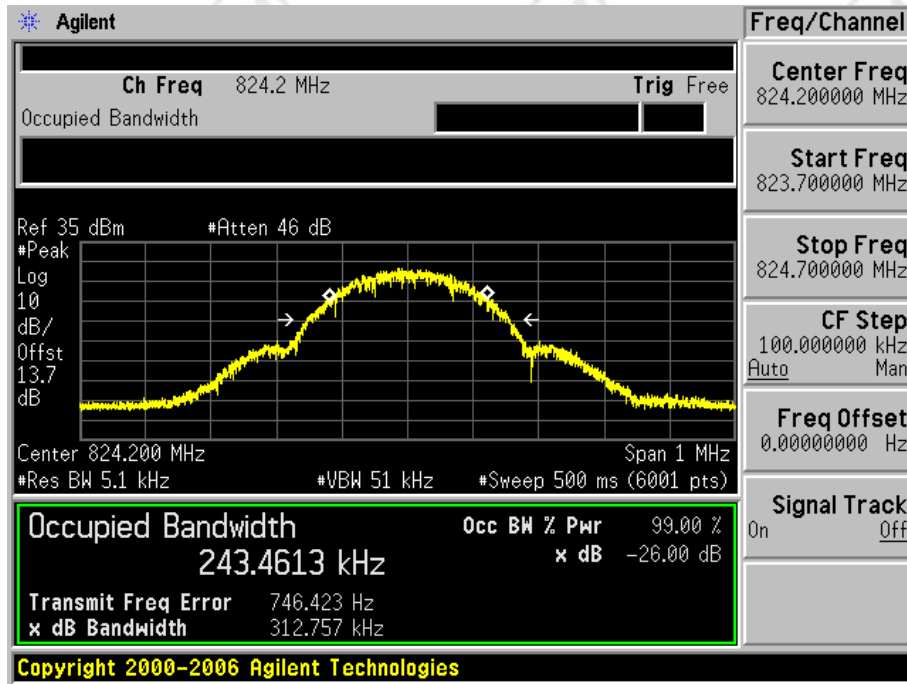

1.1.1.2 Test Channel=MCH

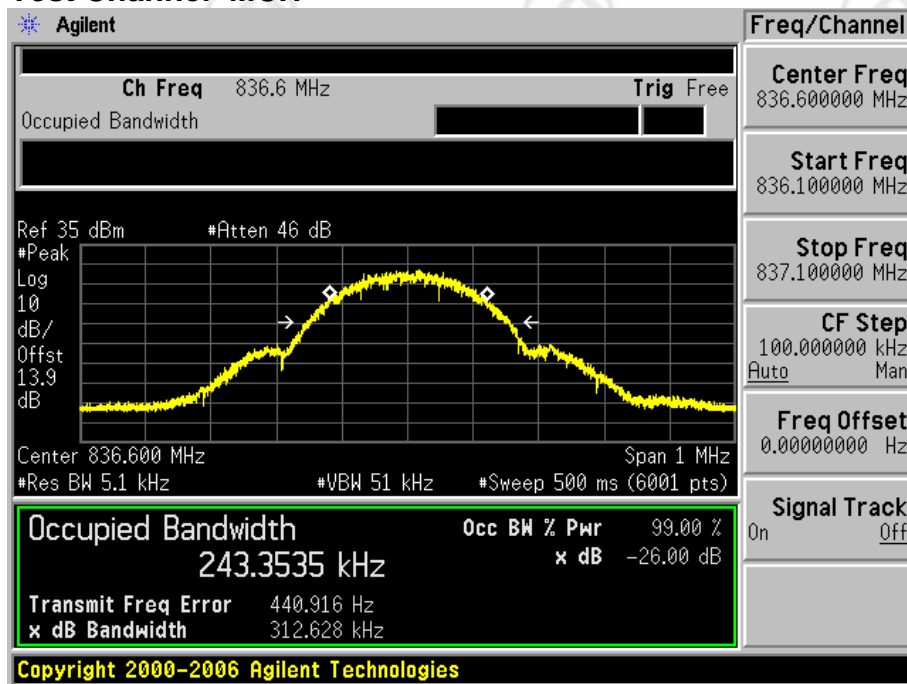

1.1.1.3 Test Channel=HCH

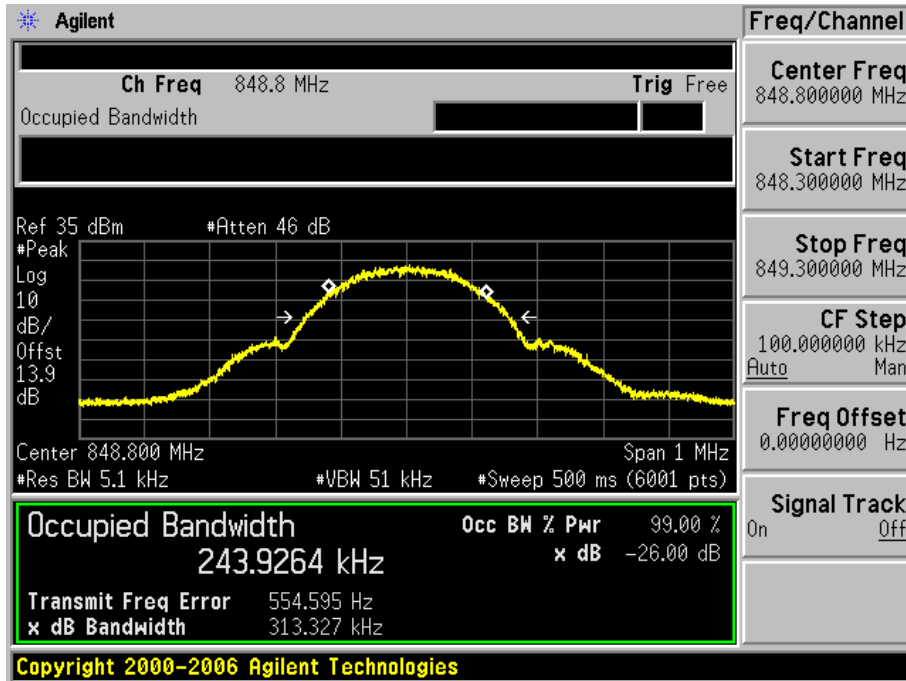

1.1.2 Test Mode=GSM/TM3

1.1.2.1 Test Channel=LCH

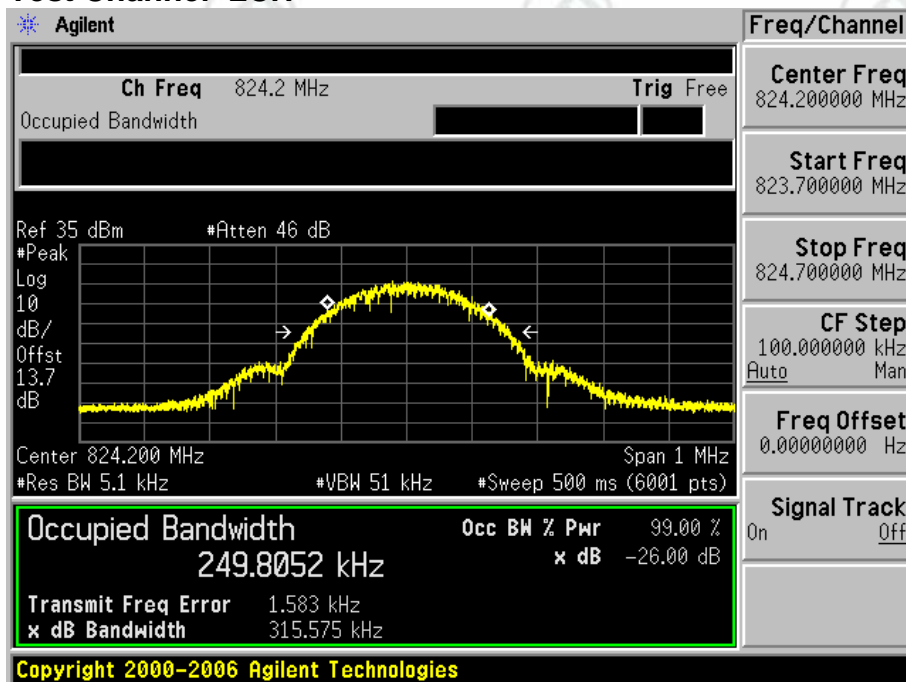

1.1.2.2 Test Channel=MCH

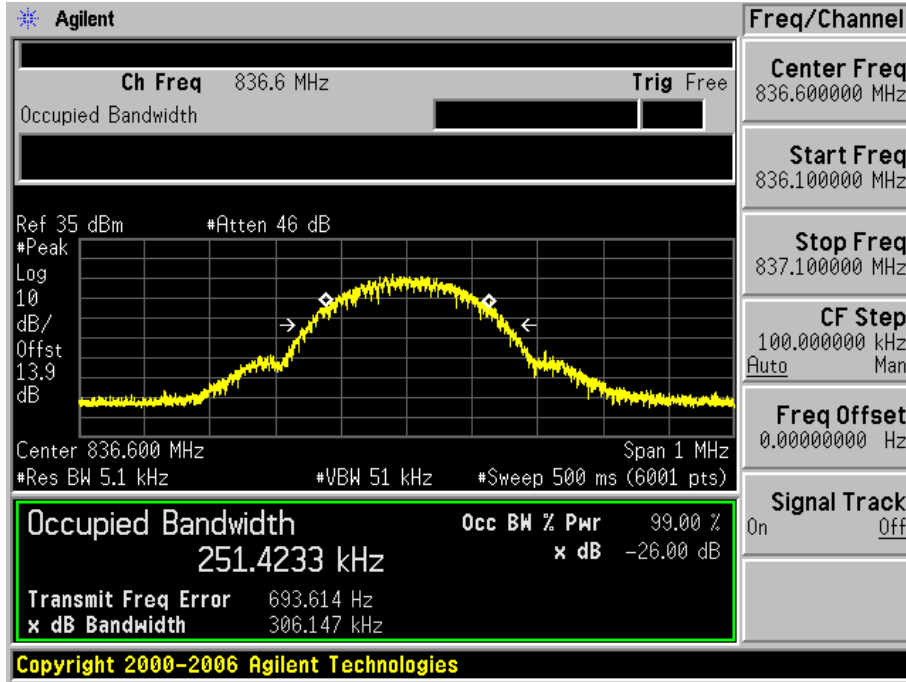

1.1.2.3 Test Channel=HCH

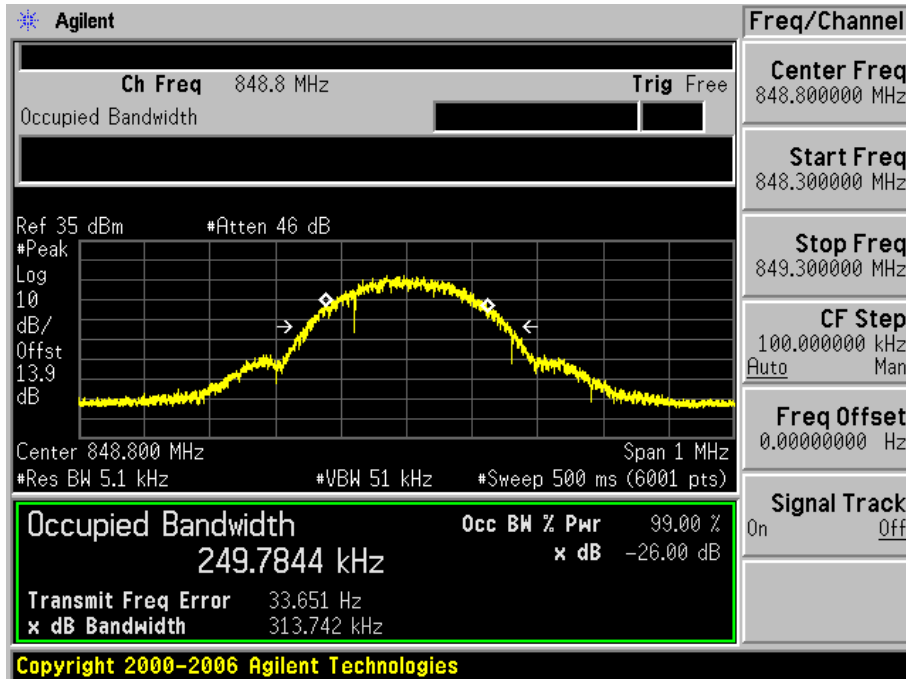

1.2 Test Band=GSM1900

1.2.1 Test Mode=GSM/TM2

1.2.1.1 Test Channel=LCH

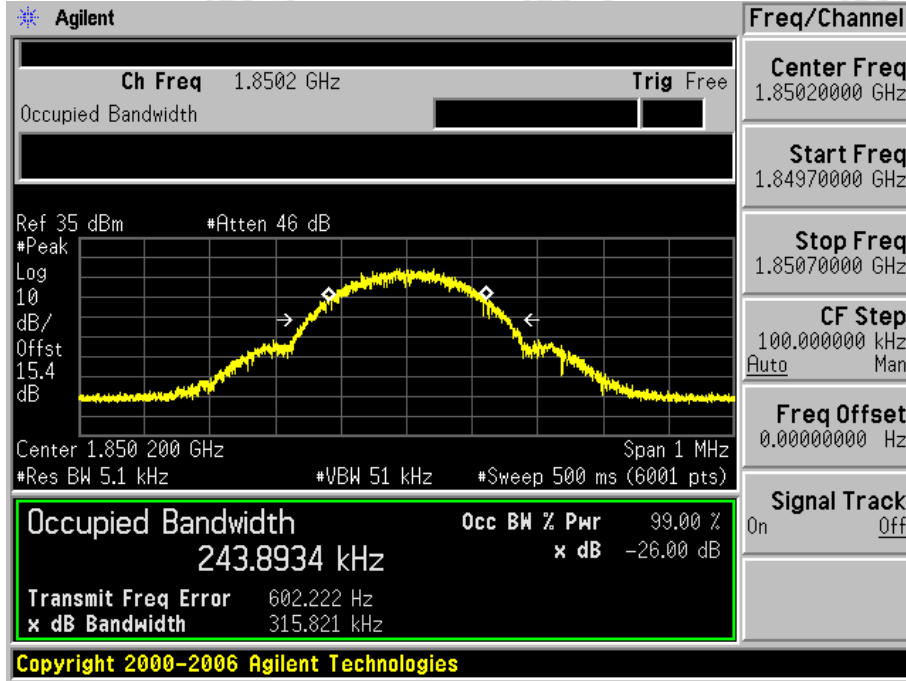

1.2.1.2 Test Channel=MCH

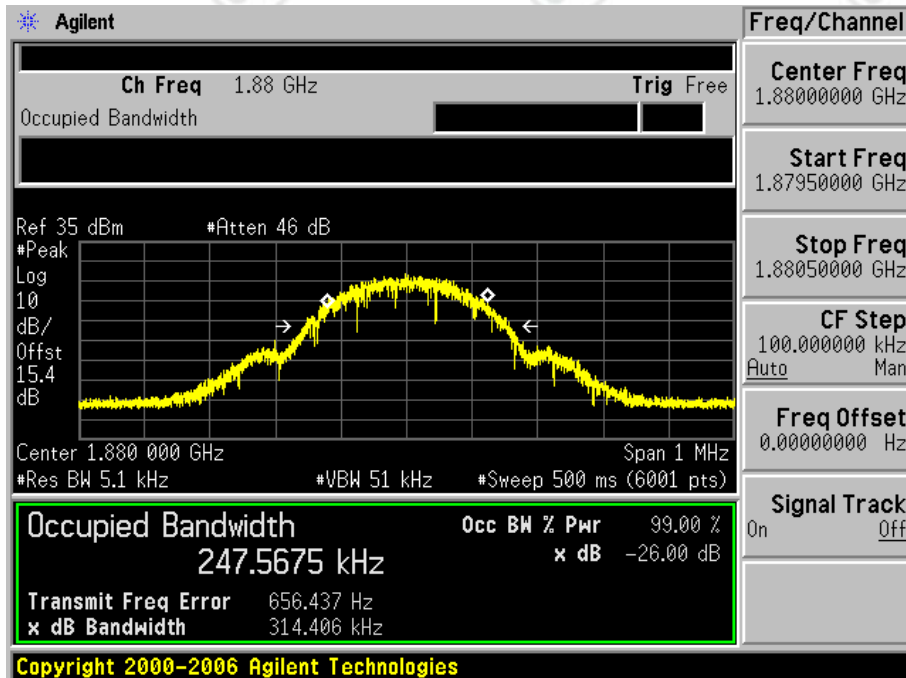

1.2.1.3 Test Channel=HCH

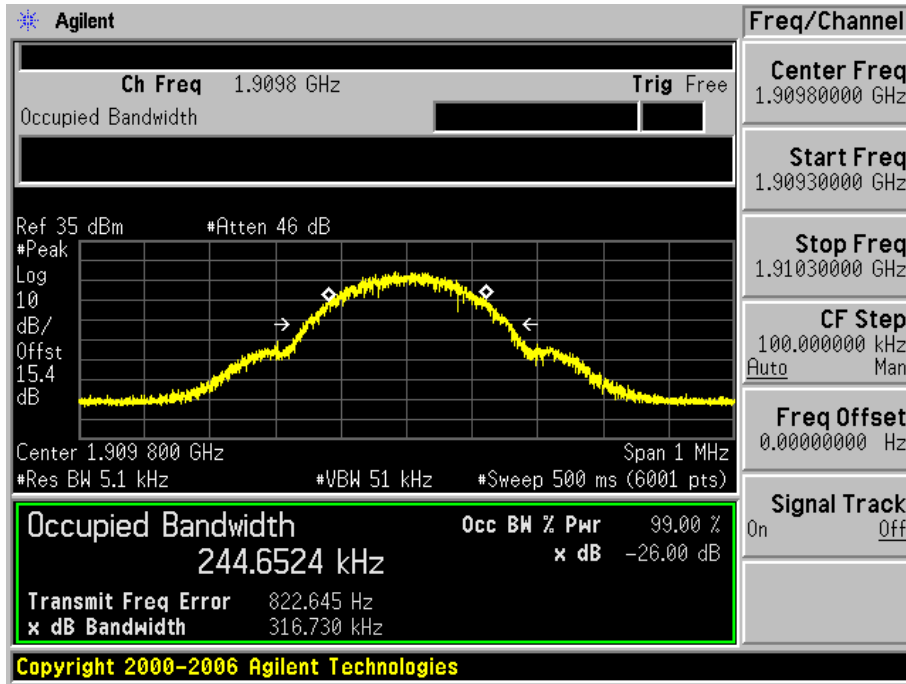

1.2.2 Test Mode=GSM/TM3

1.2.2.1 Test Channel=LCH

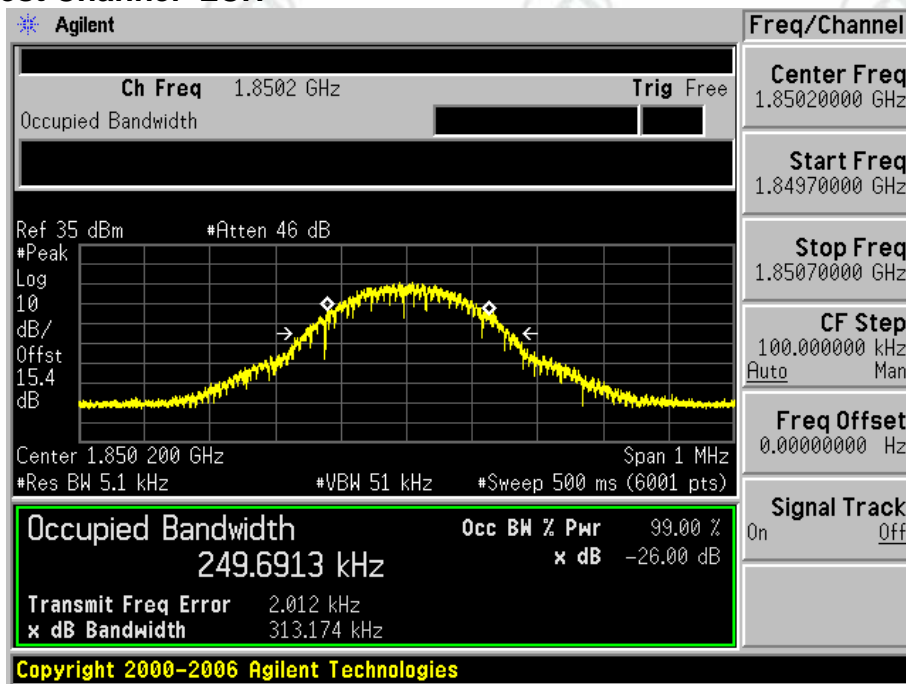

1.2.2.2 Test Channel=MCH

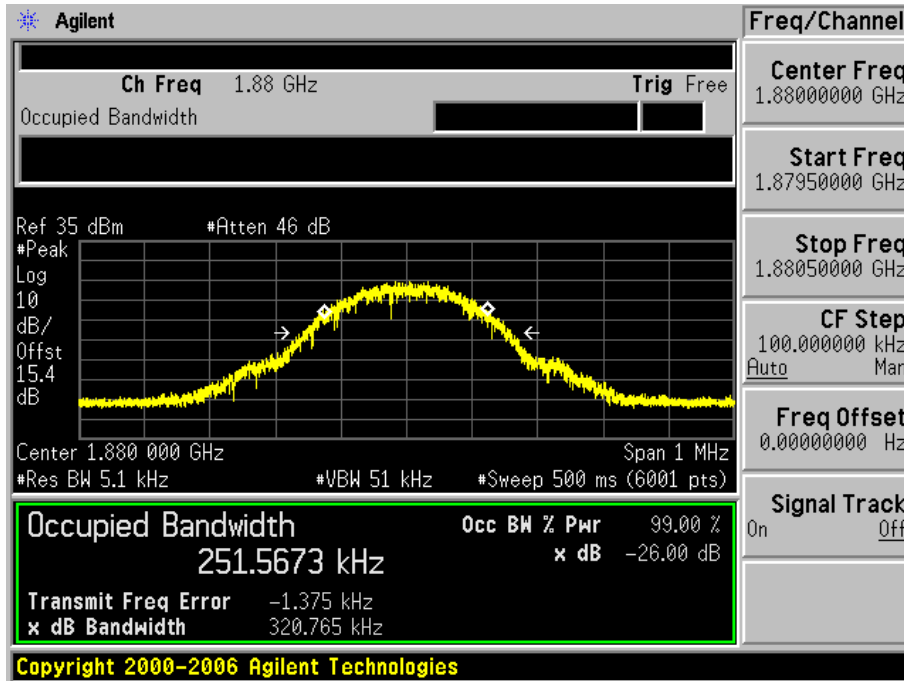

1.2.2.3 Test Channel=HCH

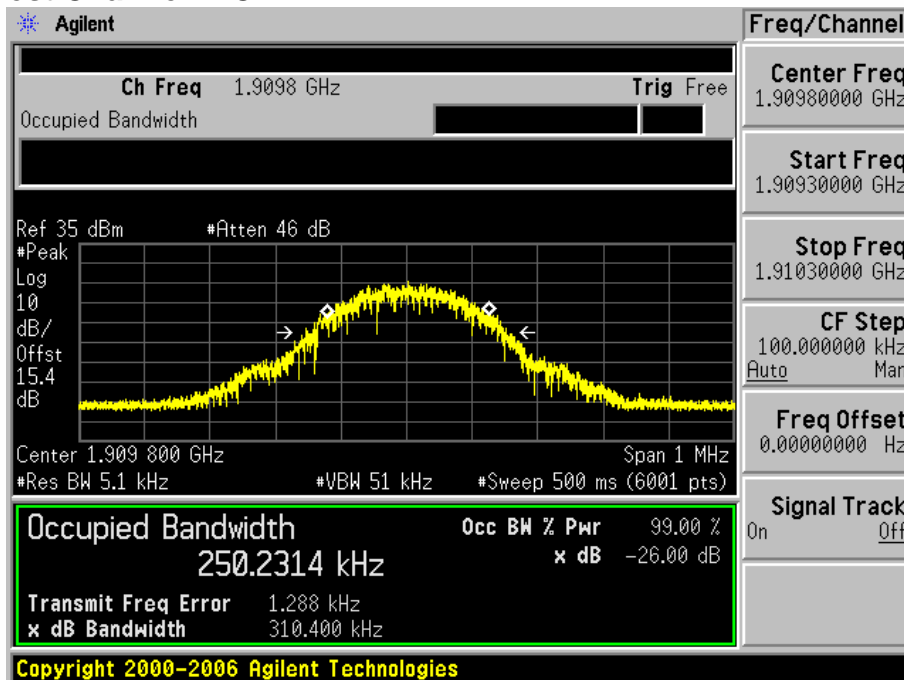

Test Band	Test Mode	Test Channel	Occupied Bandwidth (KHZ)	Emission Bandwidth (KHZ)	Verdict
WCDMA850	UMTS/TM1	LCH	4061.8	4664	PASS
		MCH	4077.4	4675	PASS
		HCH	4104.6	4662	PASS
WCDMA850	UMTS/TM2	LCH	4069.3	4660	PASS
		MCH	4087.4	4672	PASS
		HCH	4070.7	4633	PASS
WCDMA850	UMTS/TM3	LCH	4045.0	4602	PASS
		MCH	4050.9	4631	PASS
		HCH	4055.1	4650	PASS

Test Band	Test Mode	Test Channel	Occupied Bandwidth (KHZ)	Emission Bandwidth (KHZ)	Verdict
WCDMA1900	UMTS/TM1	LCH	4086.7	4632	PASS
		MCH	4080.2	4697	PASS
		HCH	4078.3	4686	PASS
WCDMA1900	UMTS/TM2	LCH	4060.4	4655	PASS
		MCH	4065.3	4656	PASS
		HCH	4055.2	4648	PASS
WCDMA1900	UMTS/TM3	LCH	4073.5	4646	PASS
		MCH	4055.4	4632	PASS
		HCH	4051.7	4633	PASS

2 For WCDMA
2.1 Test Band=WCDMA850
2.1.1 Test Mode=UMTS/TM1
2.1.1.1 Test Channel=LCH

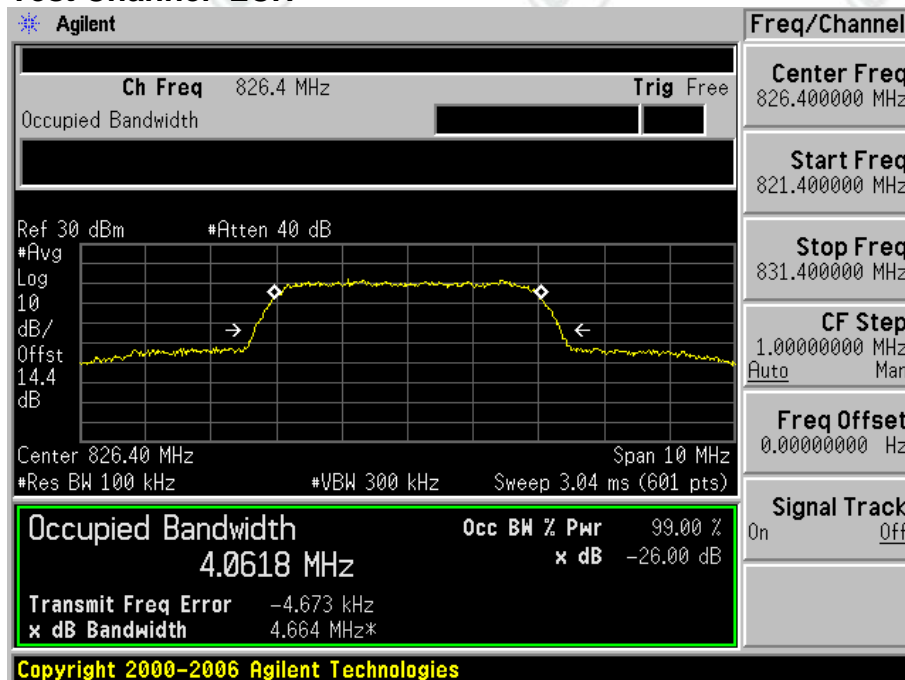

2.1.1.2 Test Channel=MCH

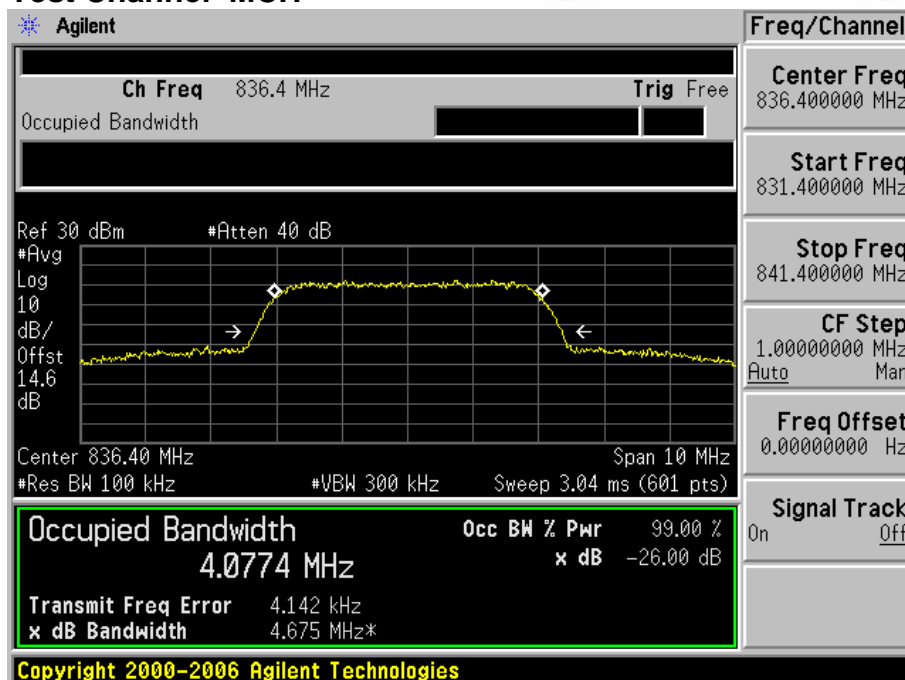

2.1.1.3 Test Channel=HCH

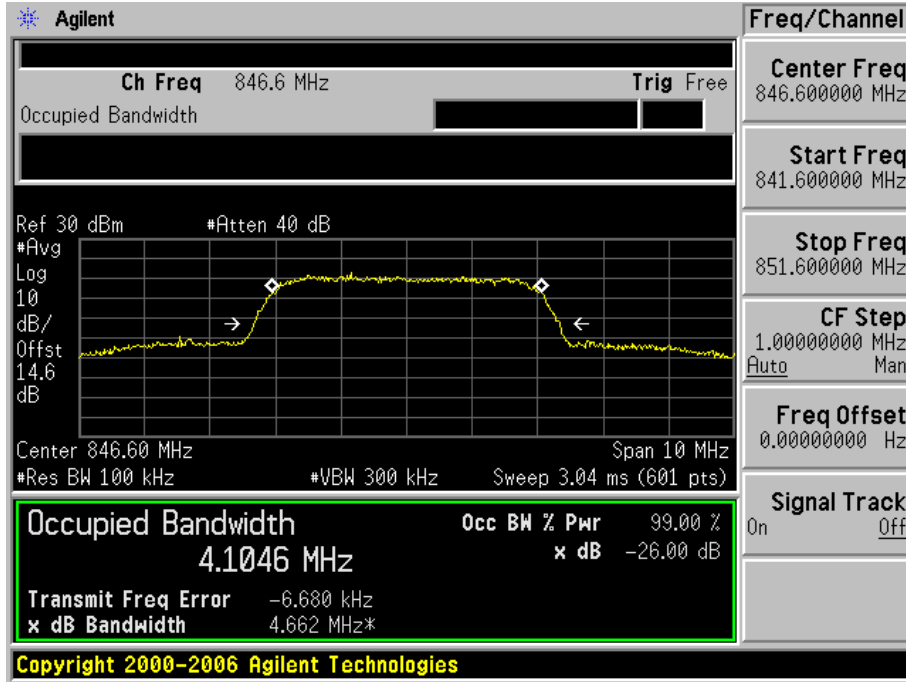

2.1.2 Test Mode=UMTS/TM2

2.1.2.1 Test Channel=LCH

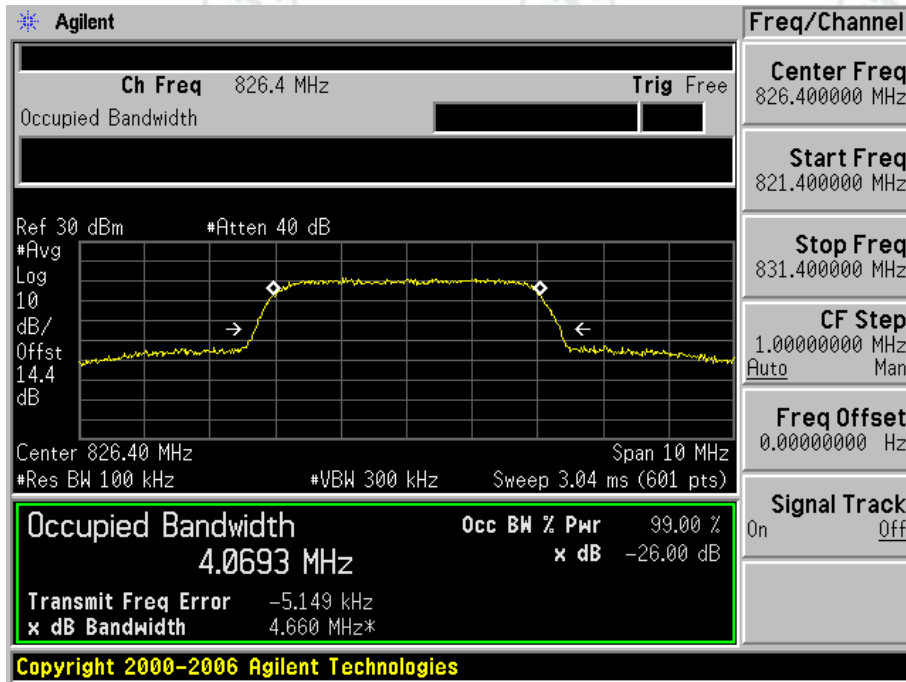

2.1.2.2 Test Channel=MCH

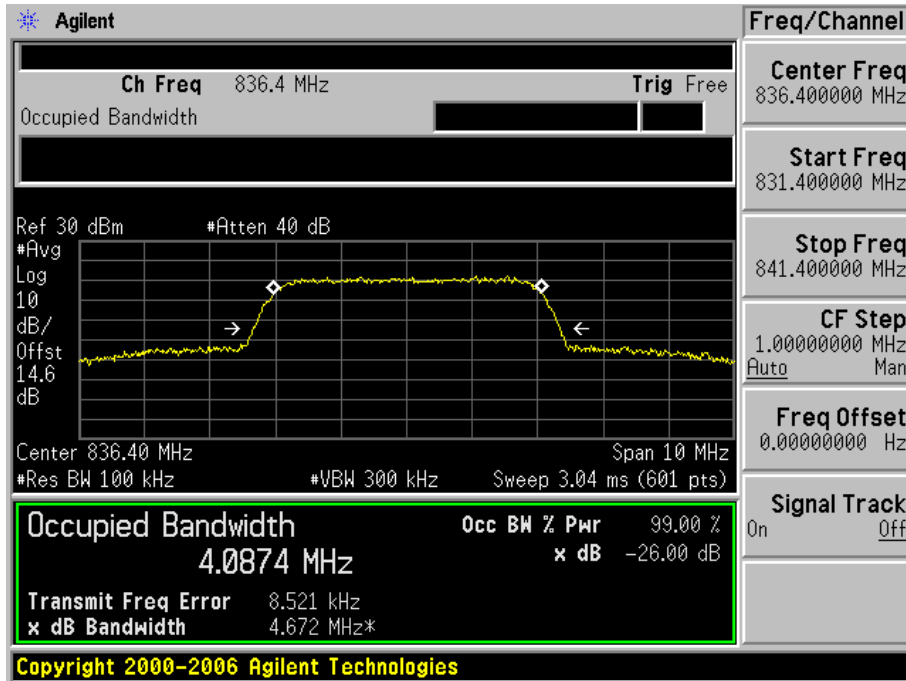

2.1.2.3 Test Channel=HCH

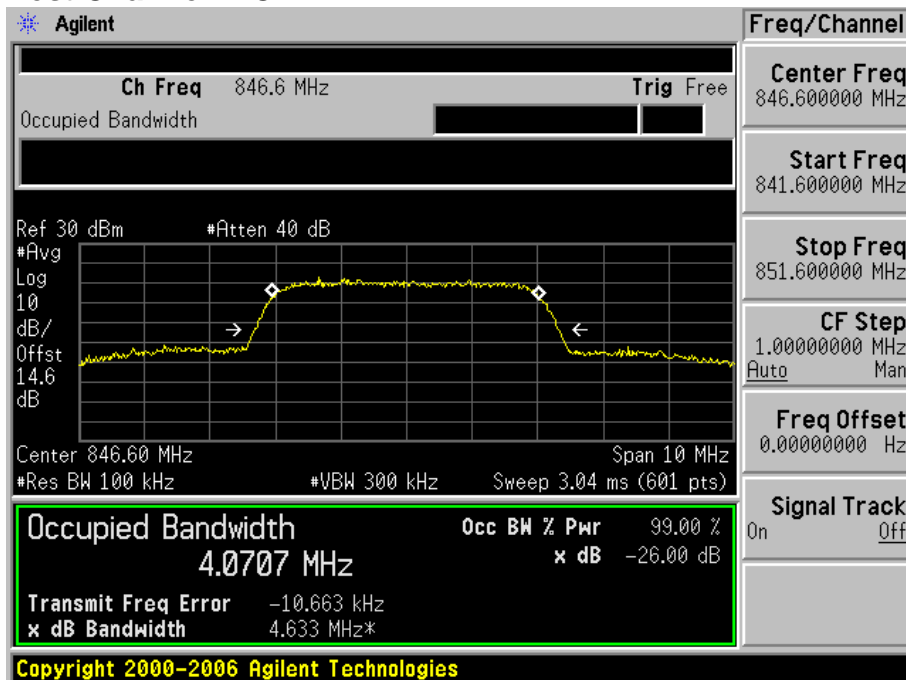

2.1.3 Test Mode=UMTS/TM3

2.1.3.1 Test Channel=LCH

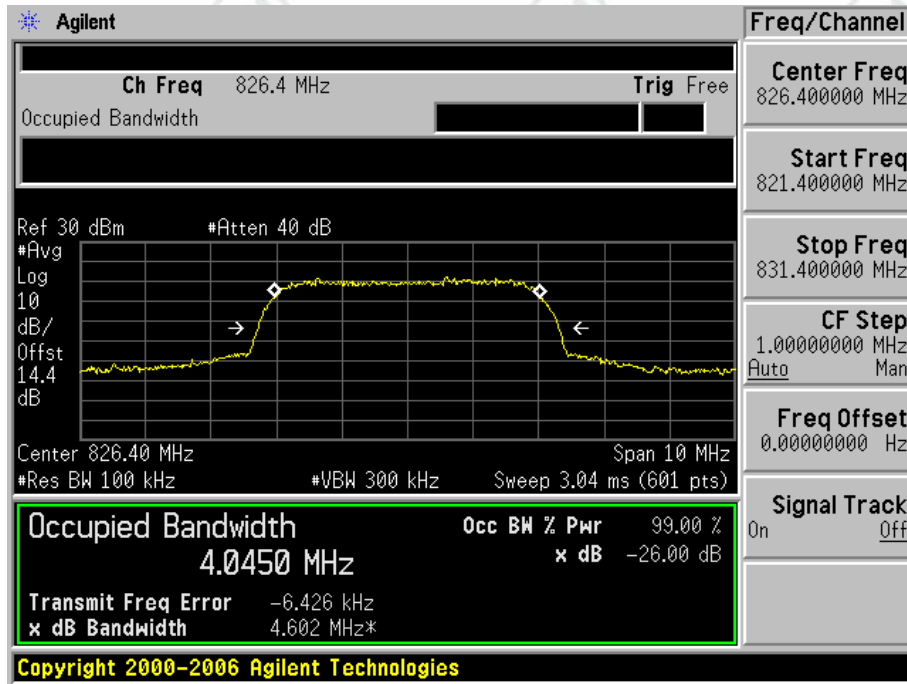

2.1.3.2 Test Channel=MCH

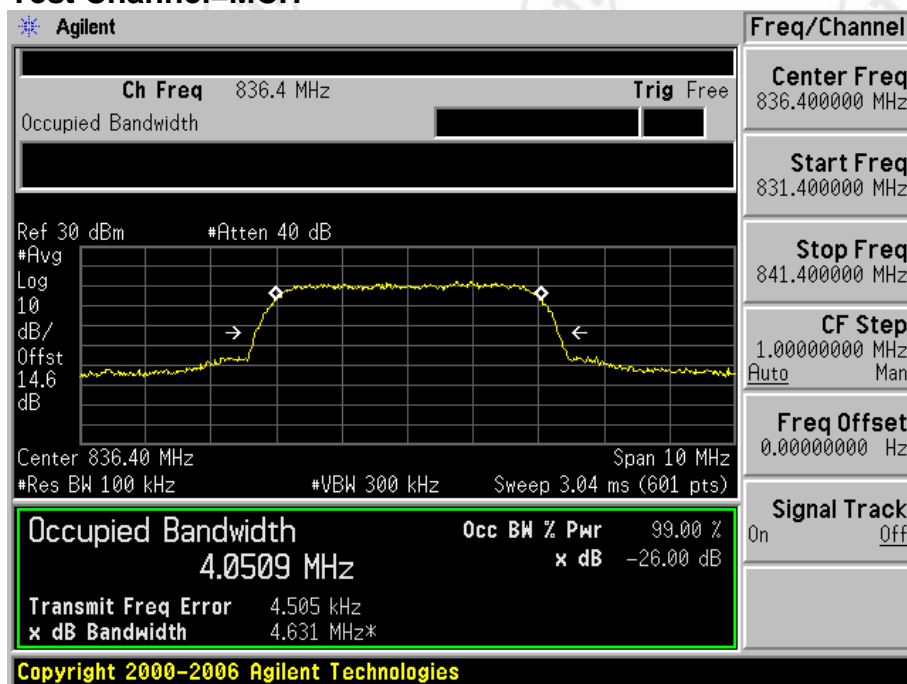

2.1.3.3 Test Channel=HCH

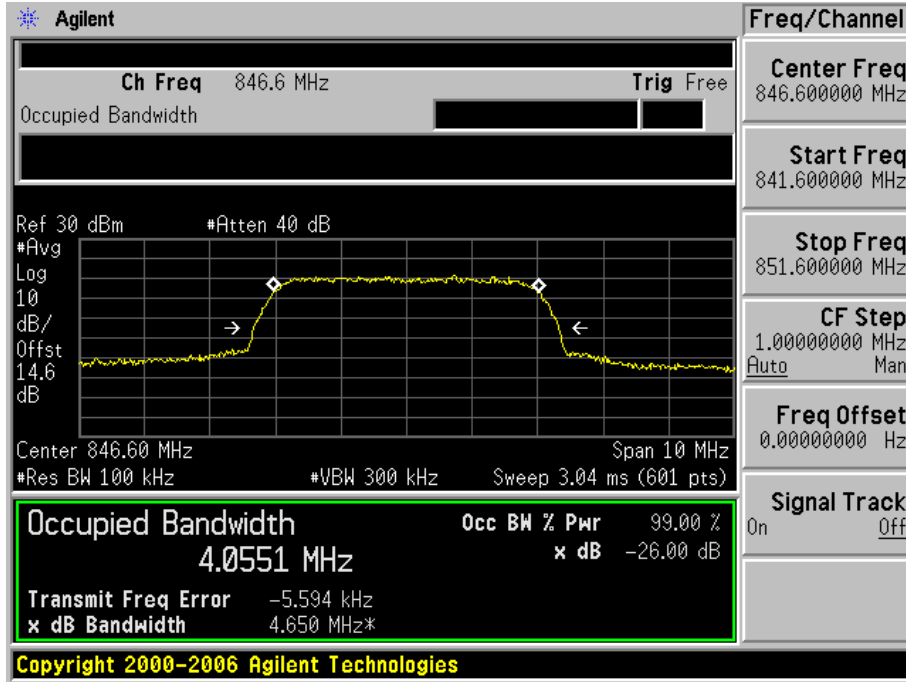

2.2 Test Band=WCDMA1900

2.2.1 Test Mode=UMTS/TM1

2.2.1.1 Test Channel=LCH

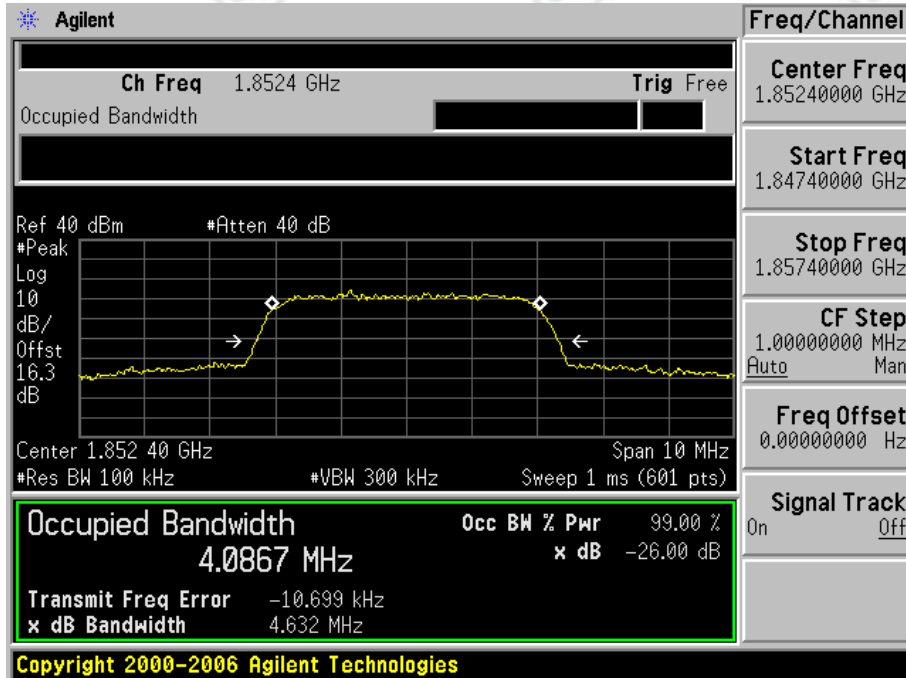

2.2.1.2 Test Channel=MCH

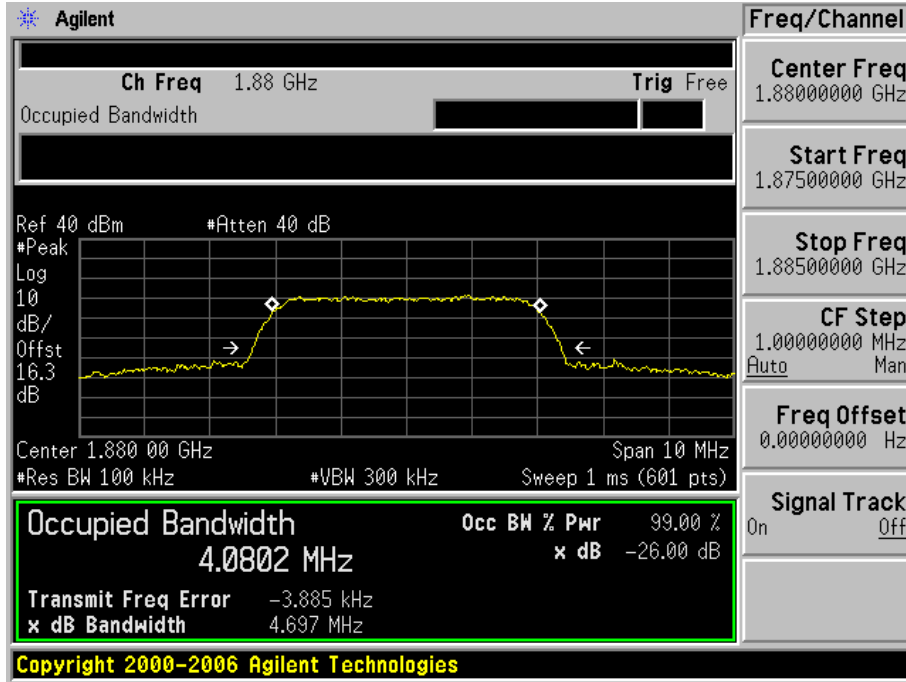

2.2.1.3 Test Channel=HCH

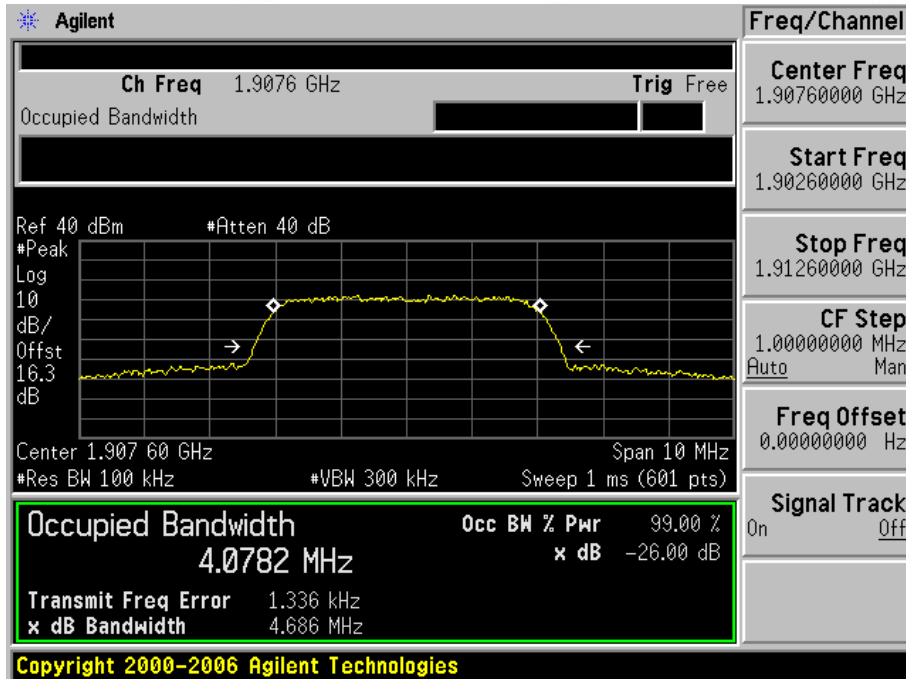

2.2.2 Test Mode=UMTS/TM2

2.2.2.1 Test Channel=LCH

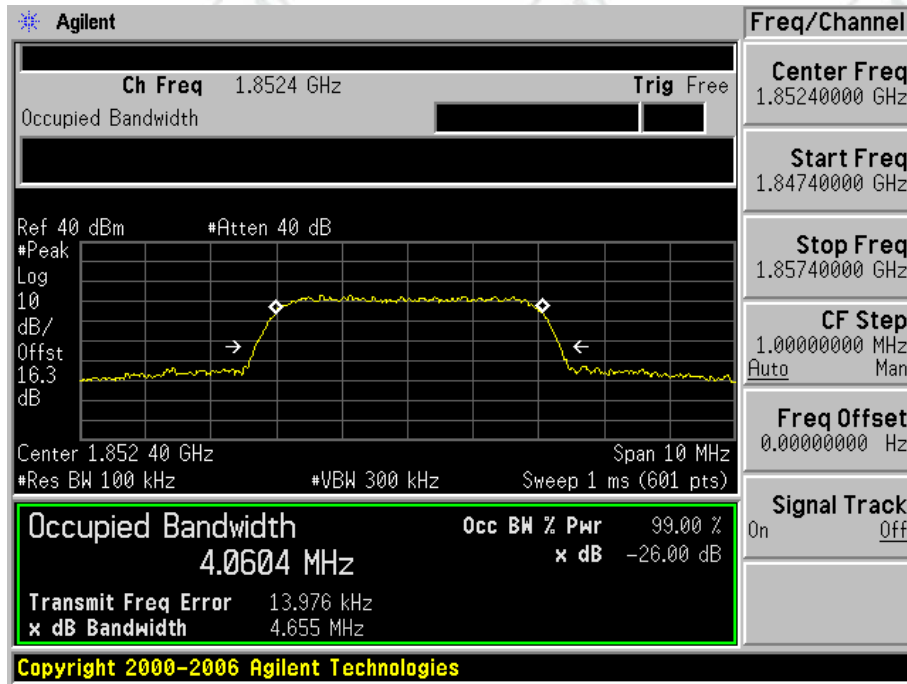

2.2.2.2 Test Channel=MCH

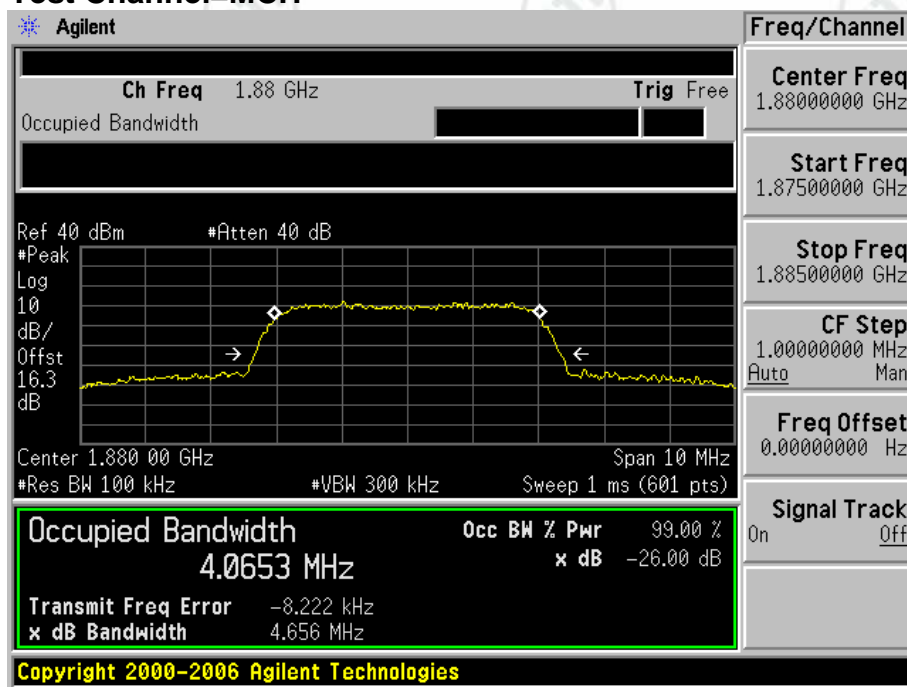

2.2.2.3 Test Channel=HCH

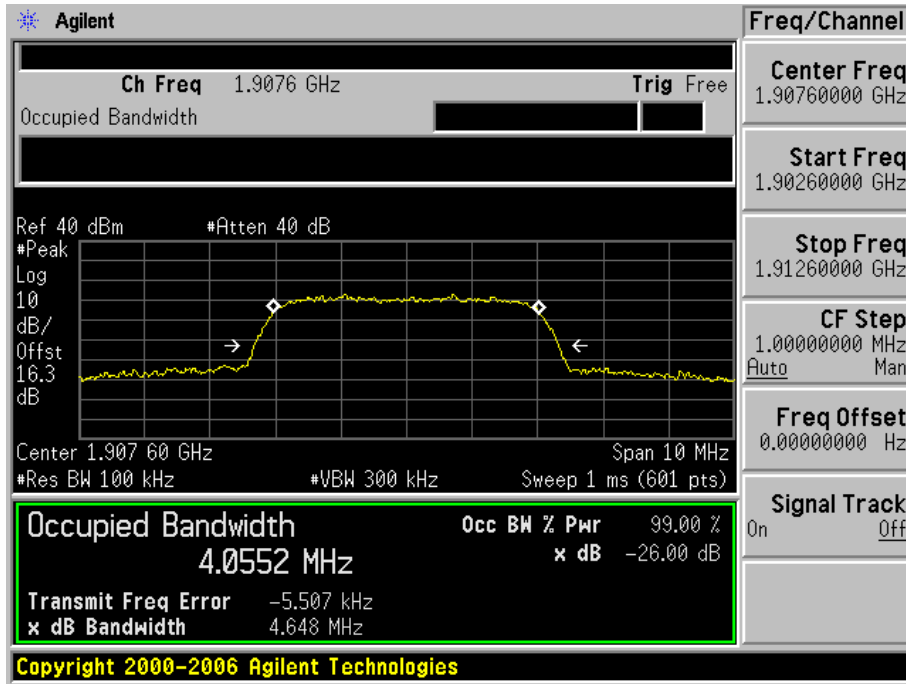

2.2.3 Test Mode=UMTS/TM3

2.2.3.1 Test Channel=LCH

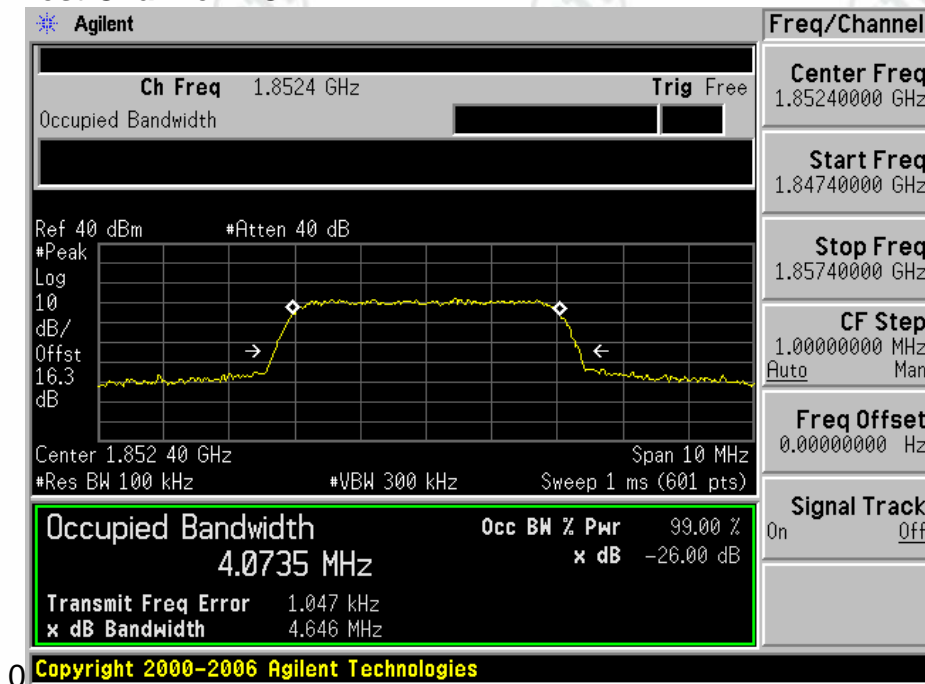

2.2.3.2 Test Channel=MCH

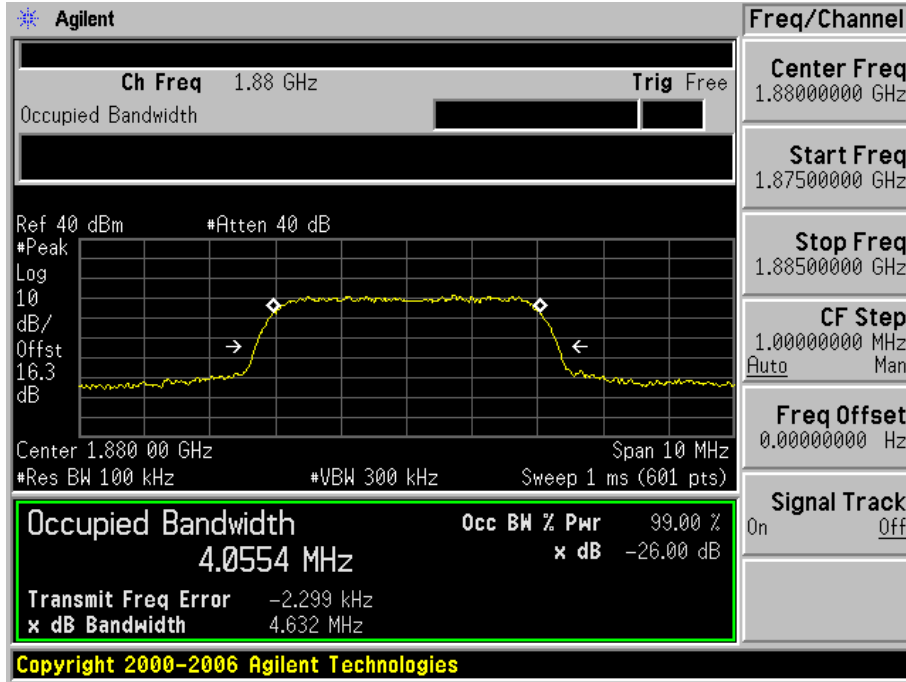

2.2.3.3 Test Channel=HCH

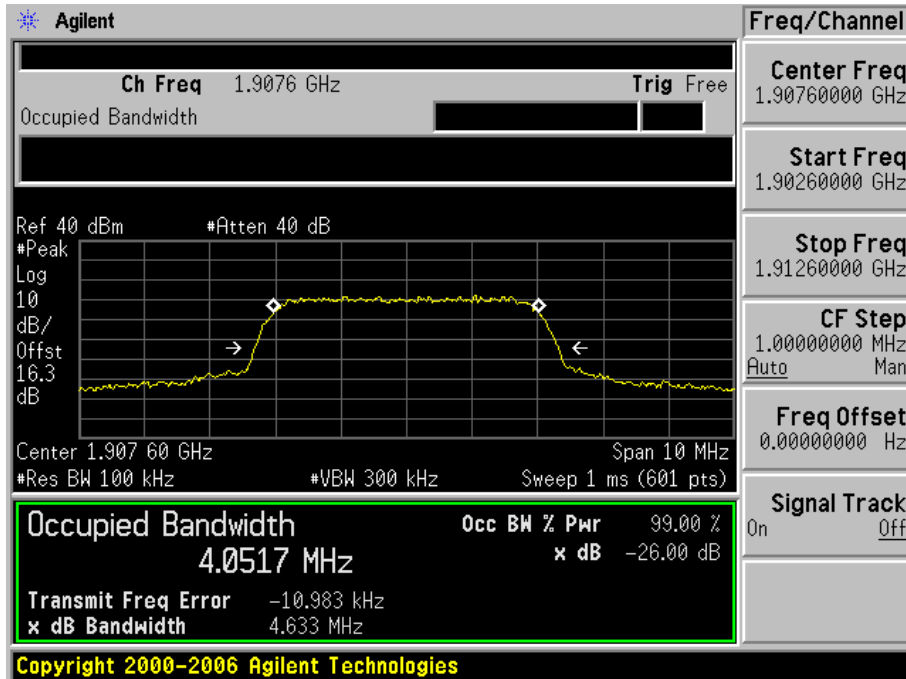

Appendix D)Band Edges Compliance

Test Requirement:	Part 2.1051		
Test Method:	Part 22.917(b)/Part 24.238(b)		
Test Setup:	Refer to section 5 for details		
Measurement Procedure:	The transmitter output was connected to a calibrated coaxial cable, attenuator and Spectrum analyser, the other end of which was connected to a Base Station Simulator. The Base Station Simulator was set to force the EUT to its maximum power setting. The tests were performed at three frequencies (low channel and high channel).in the 1MHz bands immediately outside and adjacent to the frequency block a resolution bandwidth of 100kHz or 1% of the emission bandwidth of the fundamental emission of the transmitter may be employed. The EUT emission bandwidth is measured as the width of the signal between two points, outside of which all emission are attenuated at least 26dB below the transmitter power. The video bandwidth of the spectrum analyzer was set at thrice the resolution bandwidth. Detector Mode was set to peak or peak hold power.		
Limit:	Operation Band	Frequency Range (MHz)	Limit
	GPRS/EDGE/WCDMA 850	Below 824 and above 849	Attenuated at least $43+10\log(P)$
	GPRS/EDGE/WCDMA 1900	Below 1850 and above 1910	Attenuated at least $43+10\log(P)$
Instruments Used:	Refer to section 7 for details		
Test Results:	Pass		

Test result:

- 1 For GSM**
- 1.1 Test Band=GSM850**
- 1.1.1 Test Mode=GSM/TM2**
- 1.1.1.1 Test Channel=LCH**

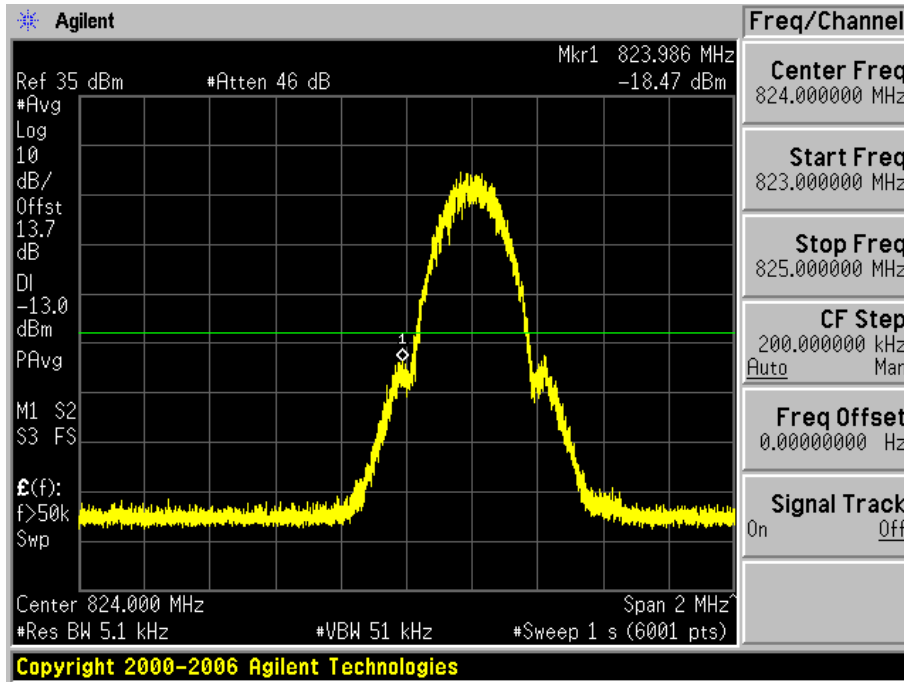

1.1.1.2 Test Channel=HCH

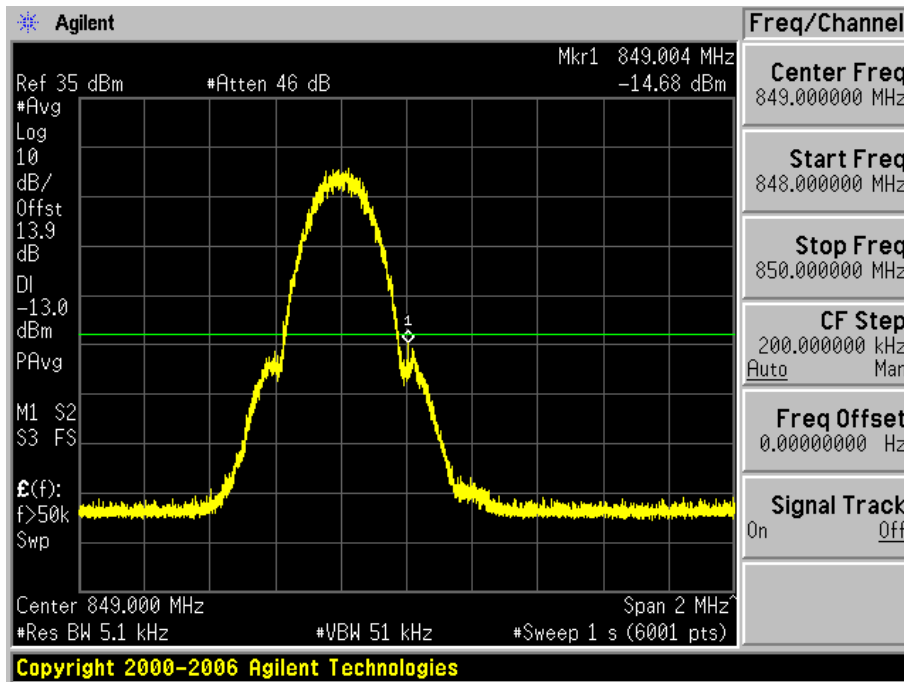

1.1.2 Test Mode=GSM/TM3

1.1.2.1 Test Channel=LCH

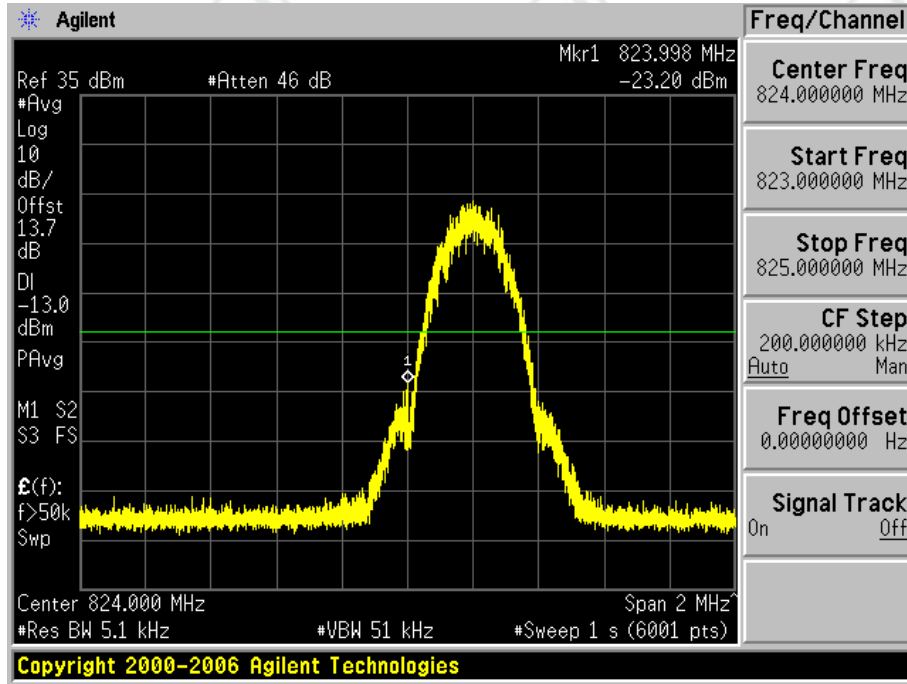

1.1.2.2 Test Channel=HCH

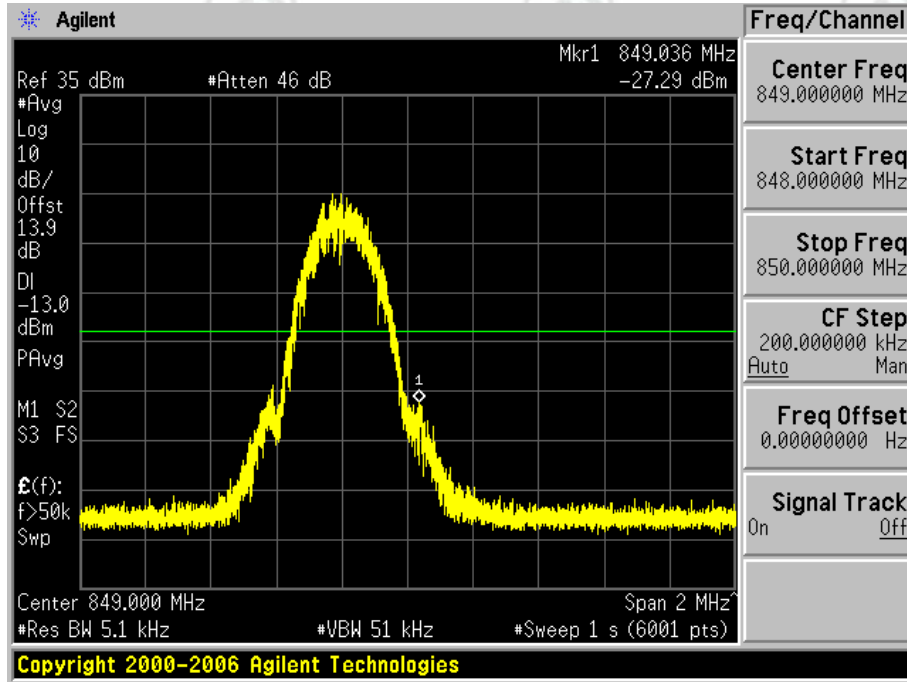

1.2 Test Band=GSM1900
1.2.1 Test Mode=GSM/TM2
1.2.1.1 Test Channel=LCH

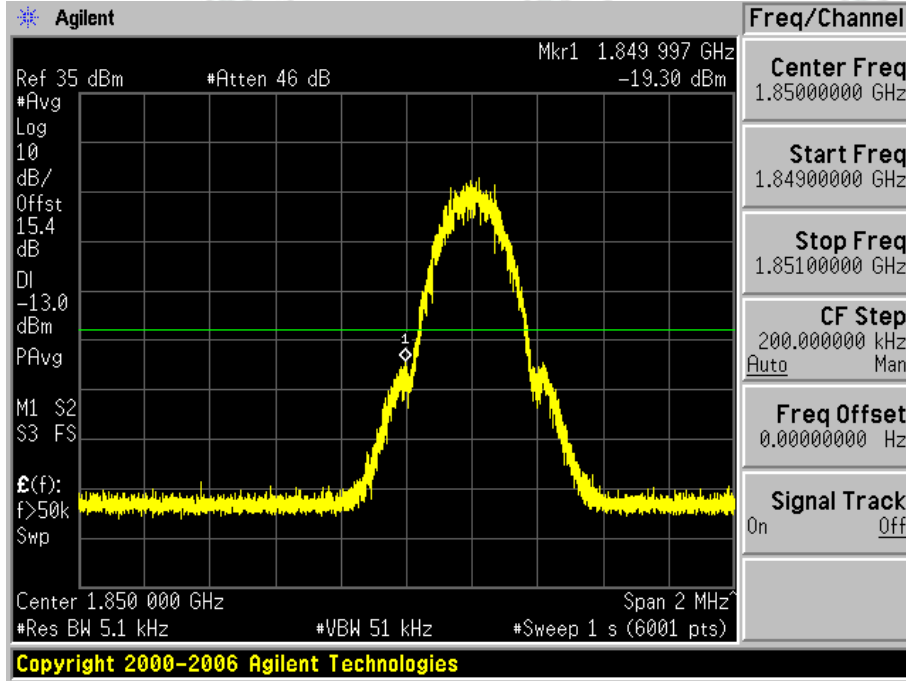

1.2.1.2 Test Channel=HCH

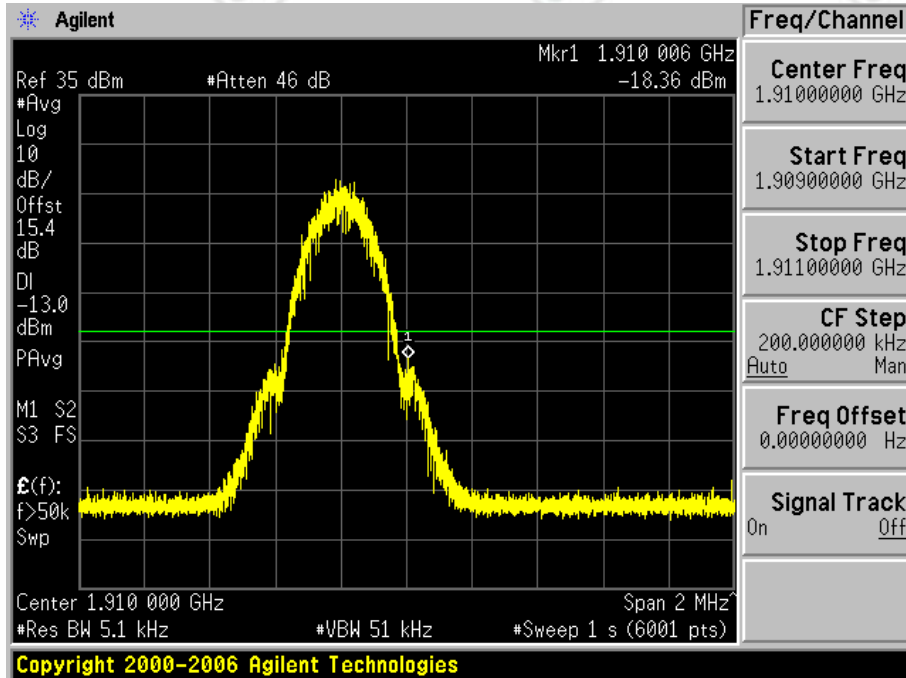

1.2.2 Test Mode=GSM/TM3

1.2.2.1 Test Channel=LCH

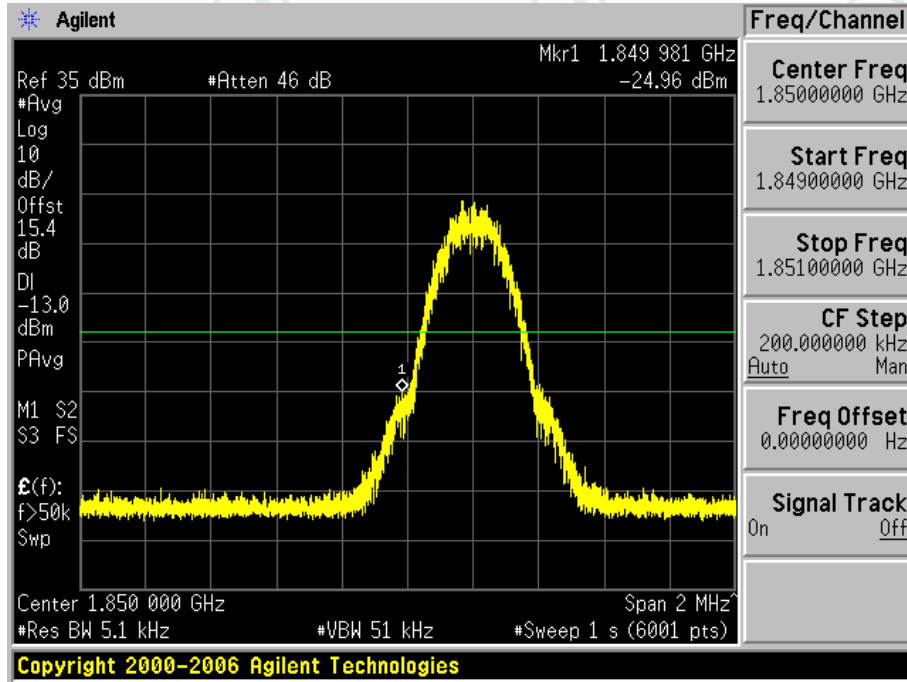

1.2.2.2 Test Channel=HCH

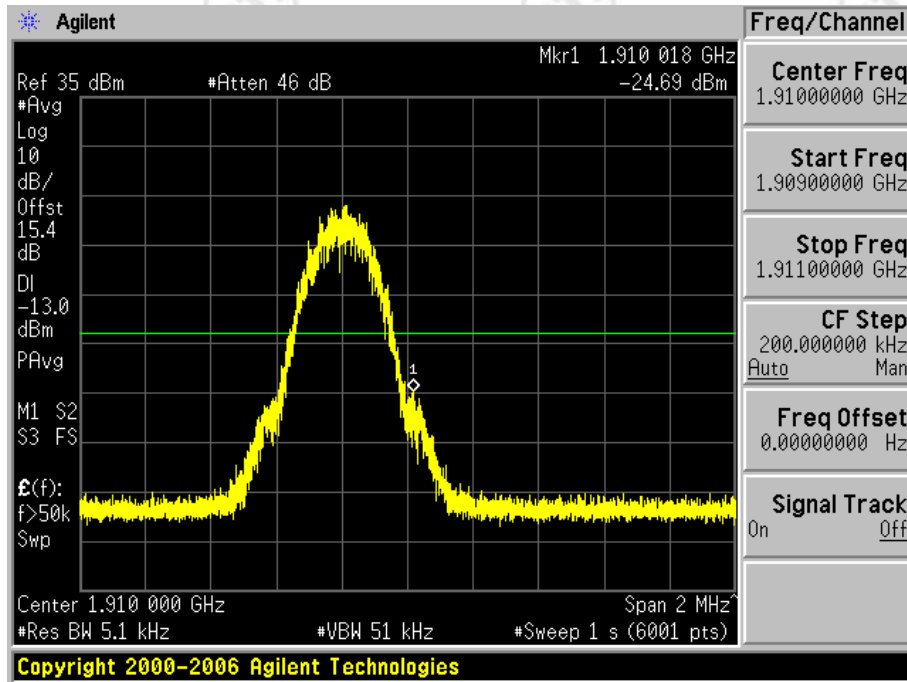

- 2 For WCDMA
- 2.1 Test Band=WCDMA850
- 2.1.1 Test Mode=UMTS/TM1
- 2.1.1.1 Test Channel=LCH



- 2.1.1.2 Test Channel=HCH

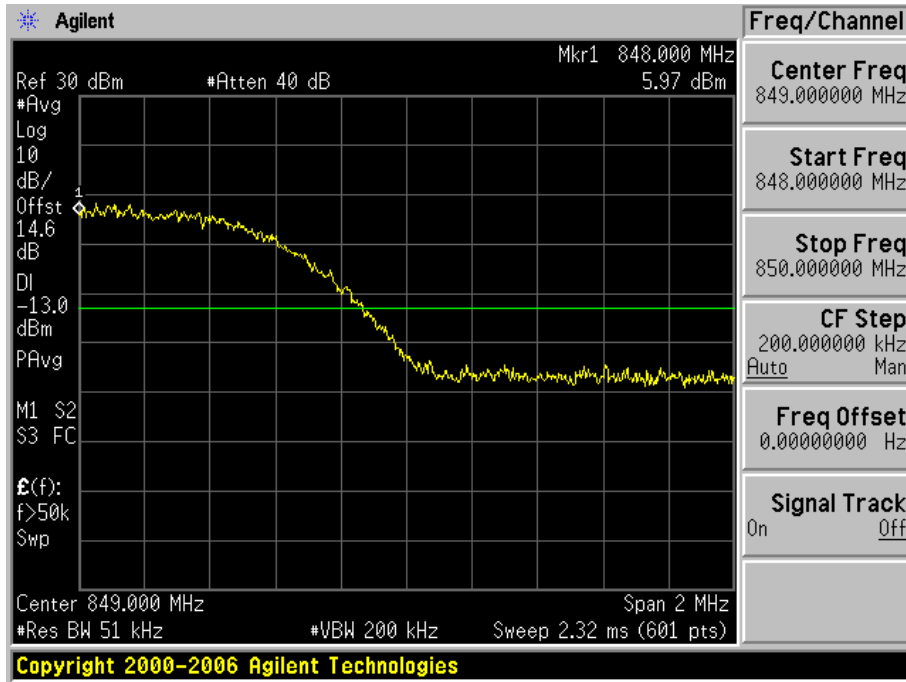

2.1.2 Test Mode=UMTS/TM2

2.1.2.1 Test Channel=LCH

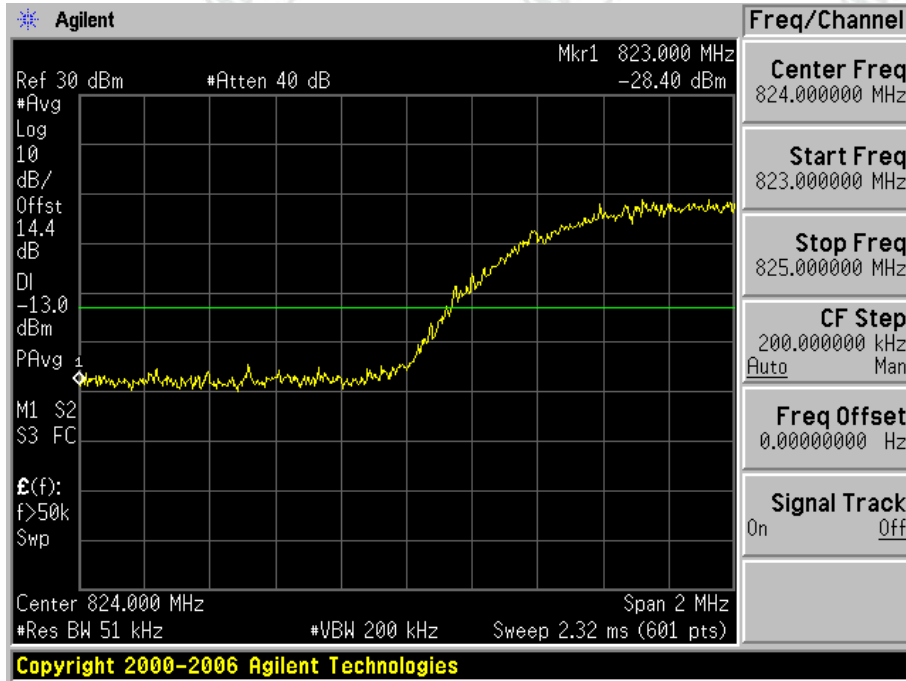

2.1.2.2 Test Channel=HCH

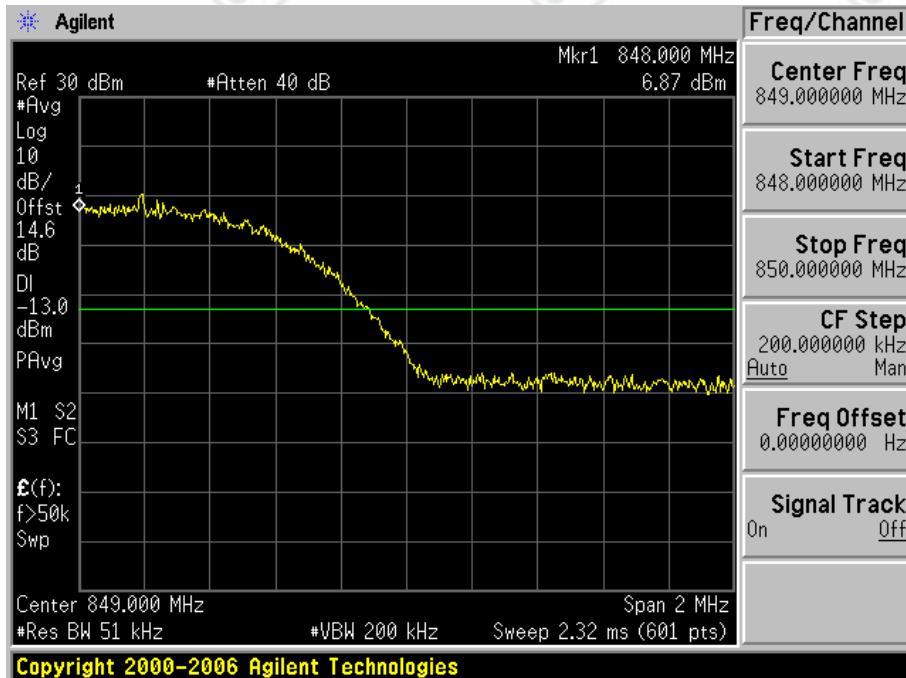

2.1.3

Test Mode=UMTS/TM3

2.1.3.1

Test Channel=LCH

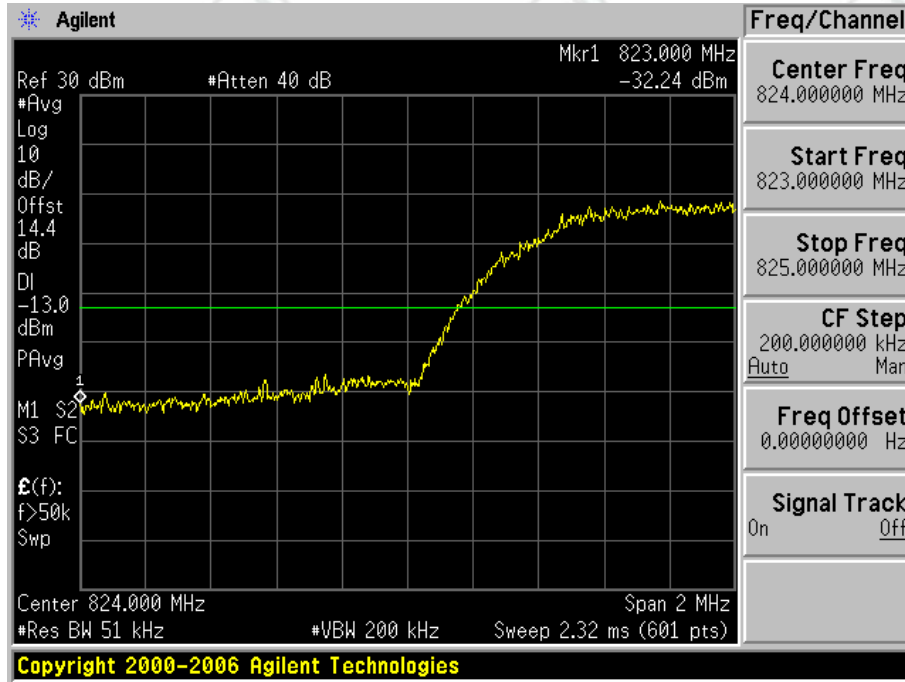

2.1.3.2

Test Channel=HCH

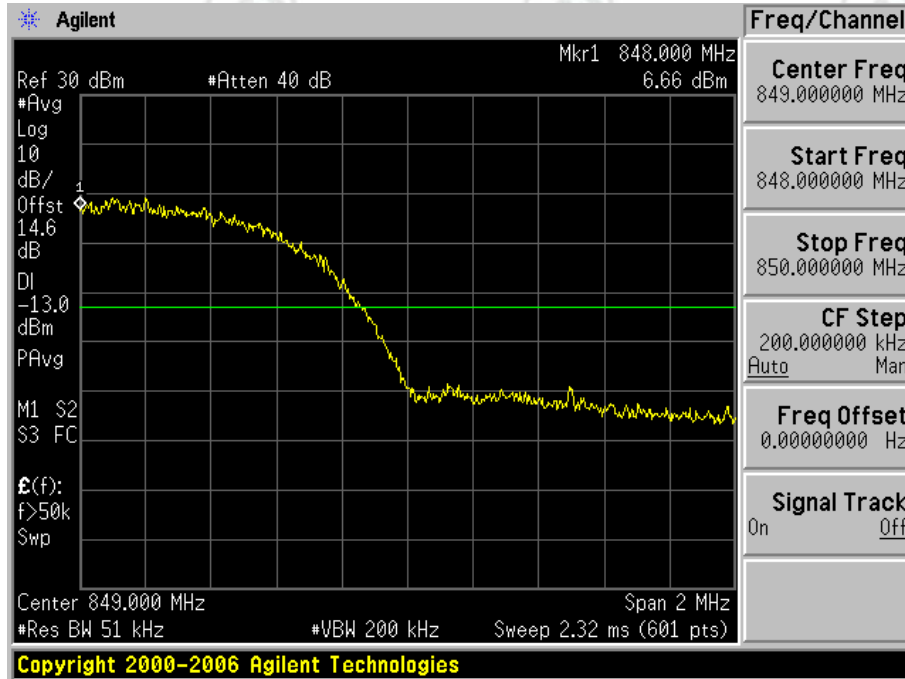

2.2 Test Band=WCDMA1900

2.2.1 Test Mode=UMTSTM1

2.2.1.1 Test Channel=LCH

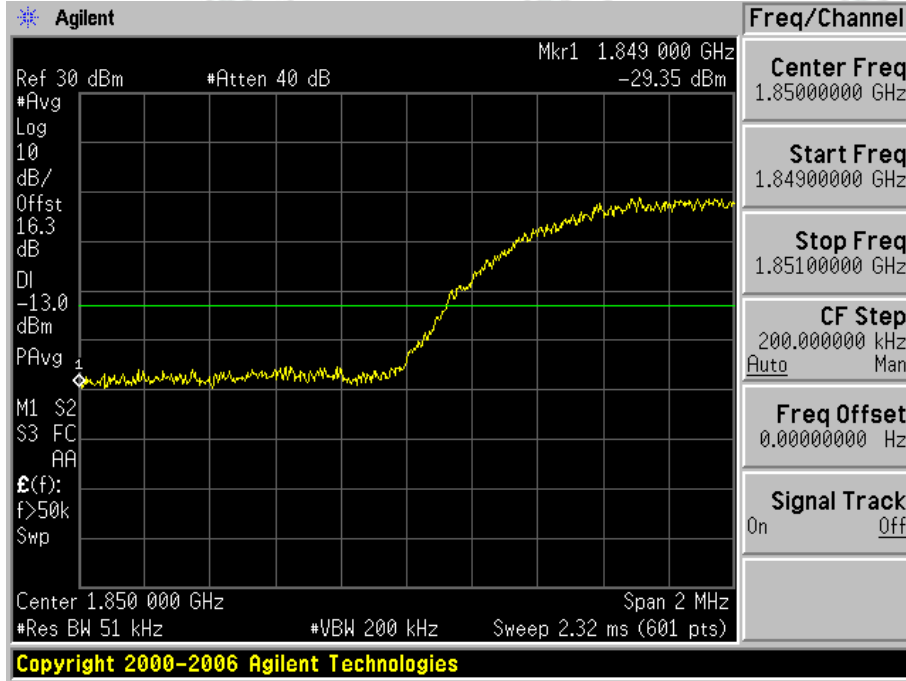

2.2.1.2 Test Channel=HCH

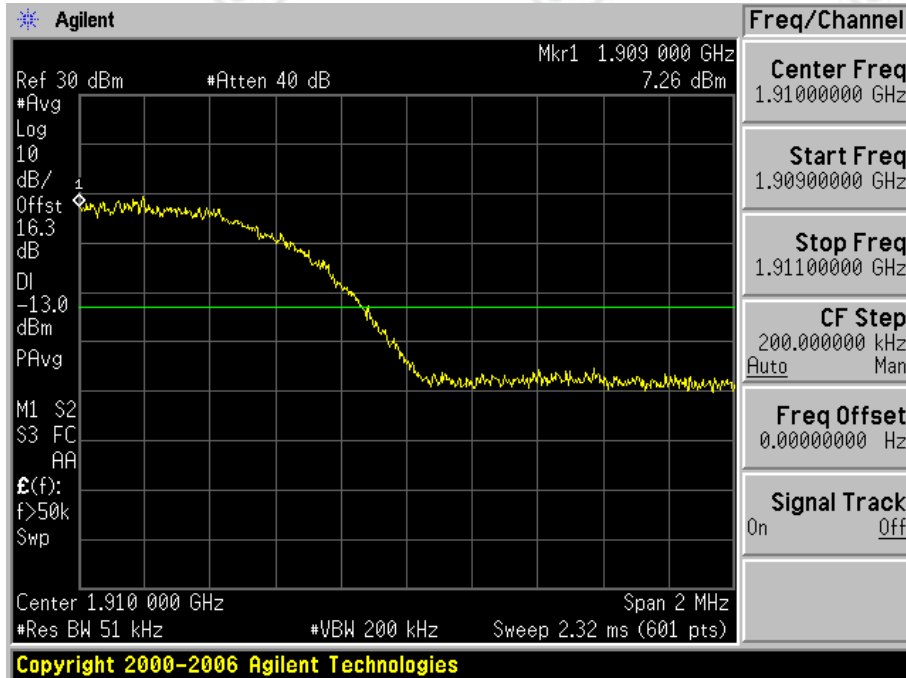

2.2.2 Test Mode=UMTS/TM2

2.2.2.1 Test Channel=LCH

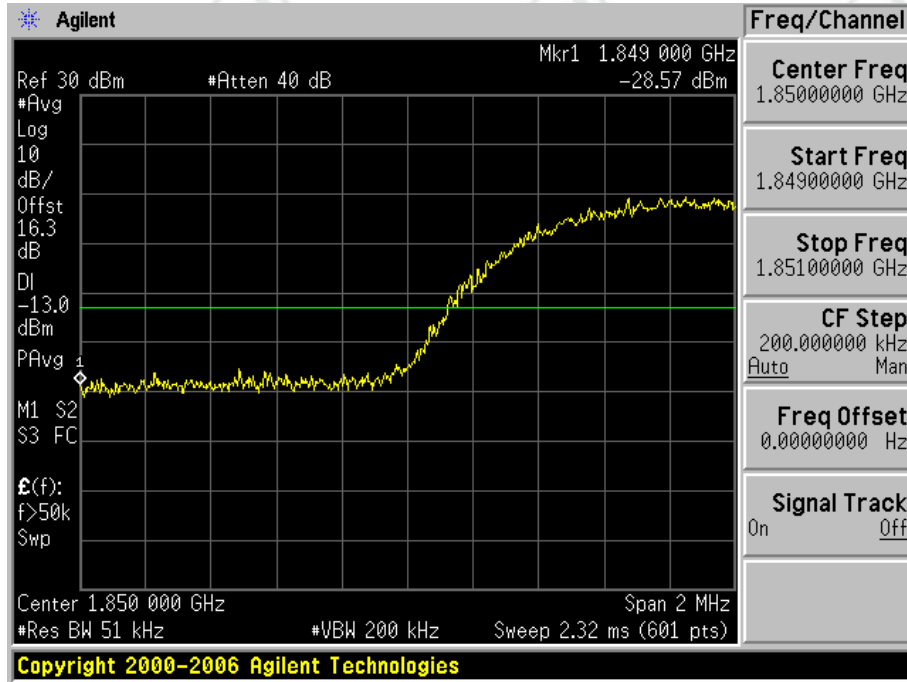

2.2.2.2 Test Channel=HCH

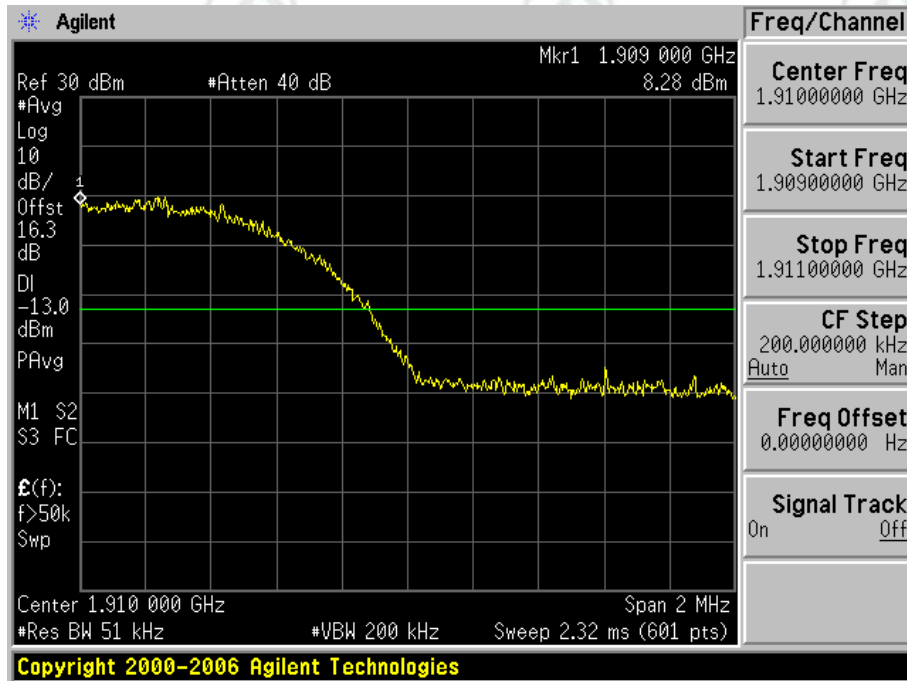

2.2.3 Test Mode=UMTS/TM3

2.2.3.1 Test Channel=LCH

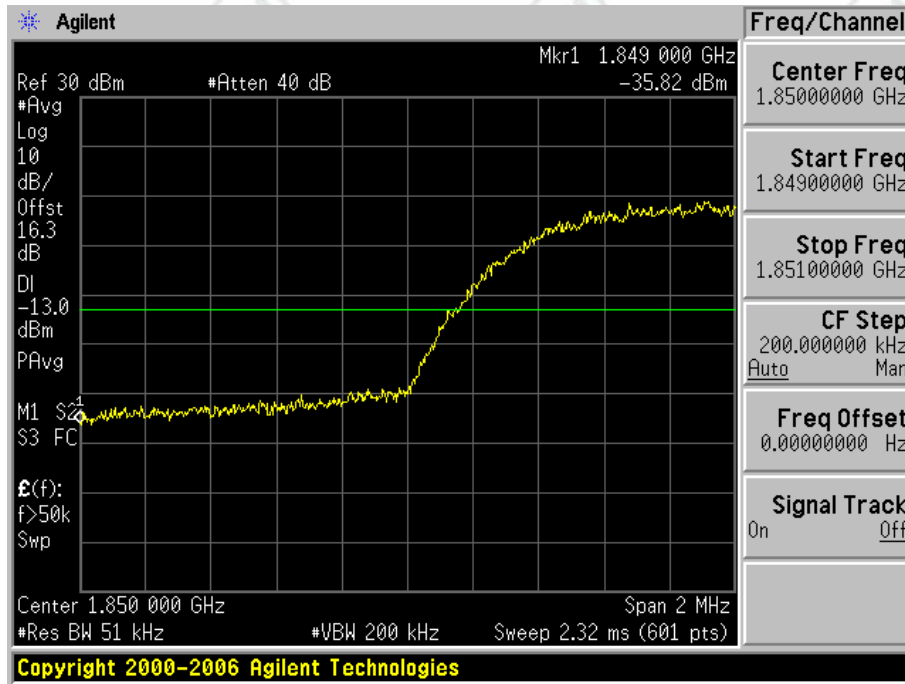

2.2.3.2 Test Channel=HCH

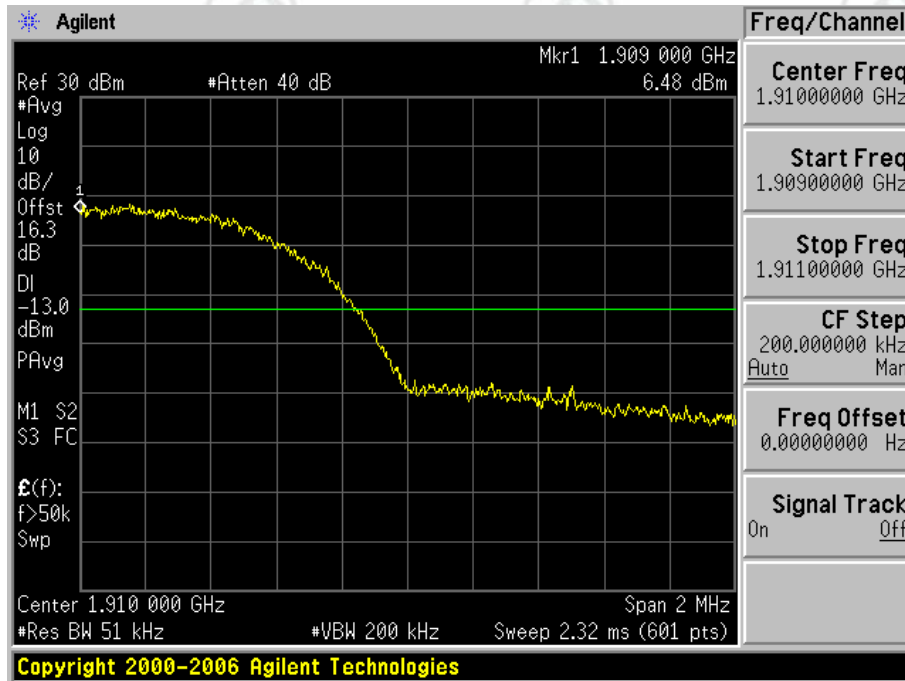

Appendix E)Spurious Emission at Antenna Terminal

Test Requirement:	Part 2.1051/Part 2.1057
Test Method:	TIA-603-E-2016 Clause 2.2.13
Test Setup:	Refer to section 5 for details
Measurement Procedure:	The transmitter output was connected to a calibrated coaxial cable, attenuator and Spectrum analyzer, the other end of which was connected to a Base Station Simulator. The Base Station Simulator was set to force the EUT to its maximum power setting. The tests were performed at three frequencies (low channel and high channel).the equipment operates below 10GHz: to the tenth harmonic of the highest fundamental frequency or to 40GHz.whichever is lower, the resolution bandwidth of the spectrum analyzer was set at 100kHz for spurious emissions below 1 GHz, and 1 MHz for spurious emissions above 1GHz.the video bandwidth of the spectrum analyzer was set at thrice the resolution bandwidth. Detector Mode was set to mean or average power.
Instruments Used:	Refer to section 7 for details
Limit:	Attenuated at least $43+10\log(P)$
Test Results:	Pass

- 1 For GSM**
- 1.1 Test Band=GSM850**
- 1.1.1 Test Mode=GSM/TM2**
- 1.1.1.1 Test Channel=LCH**

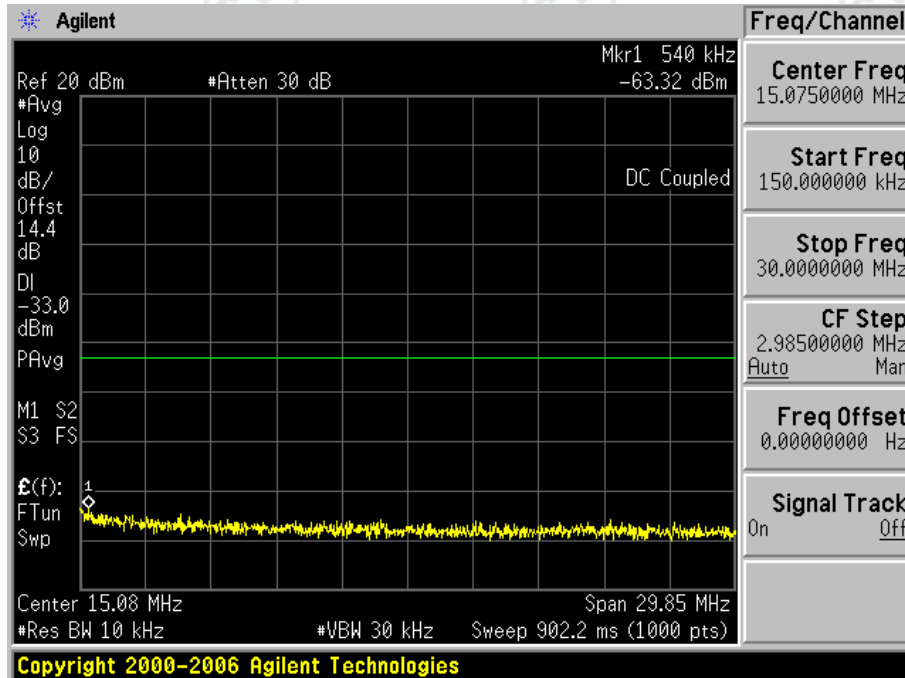
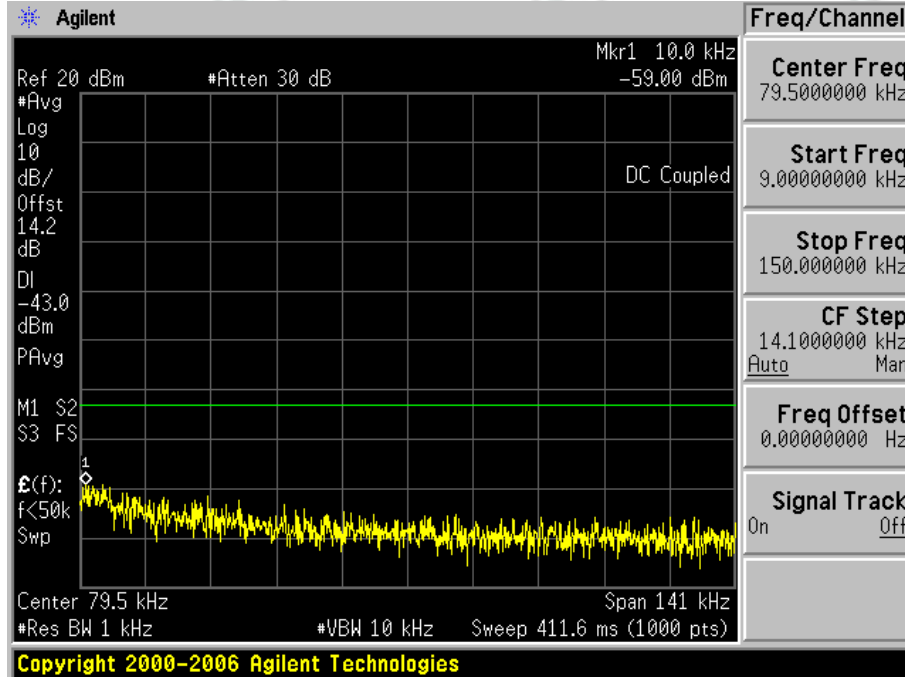

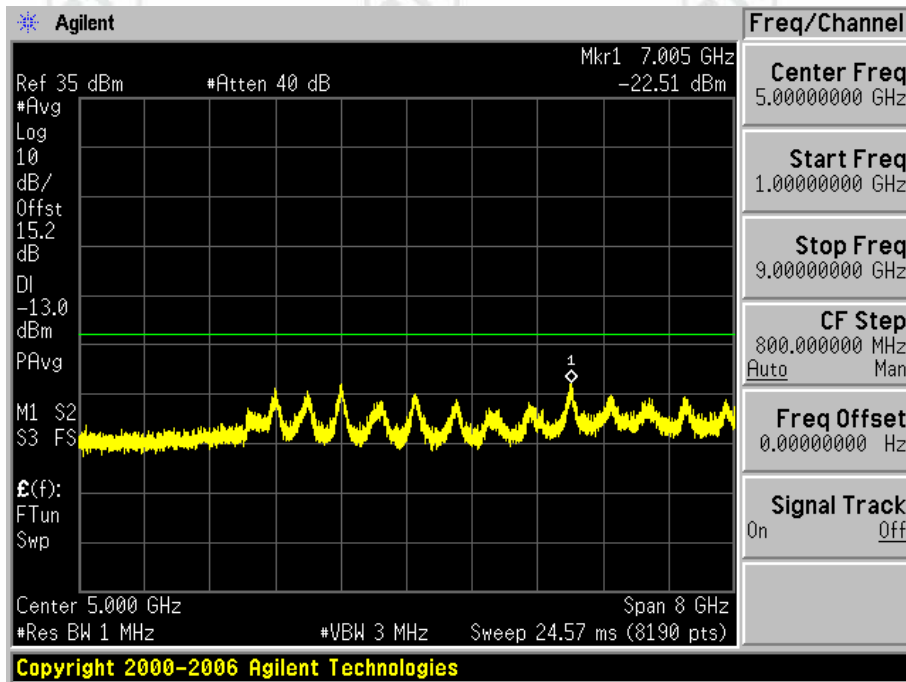
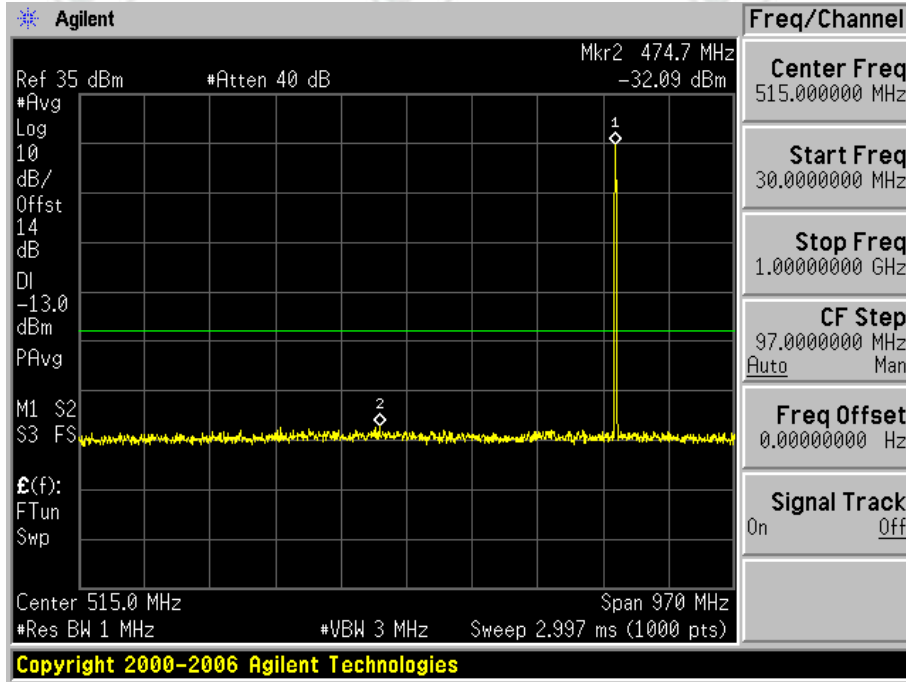

1.1.1.2 Test Channel=MCH

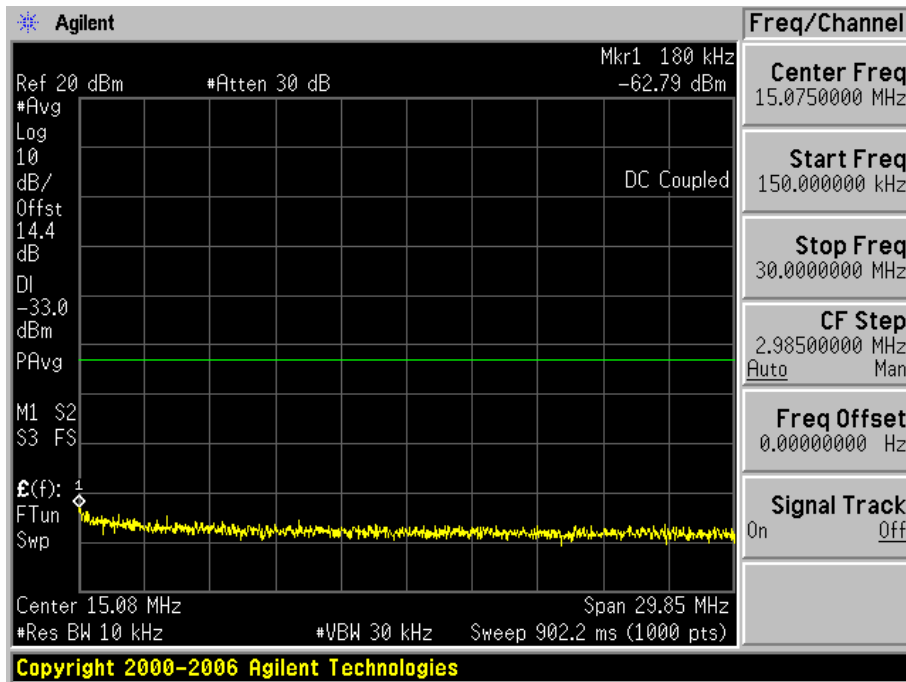
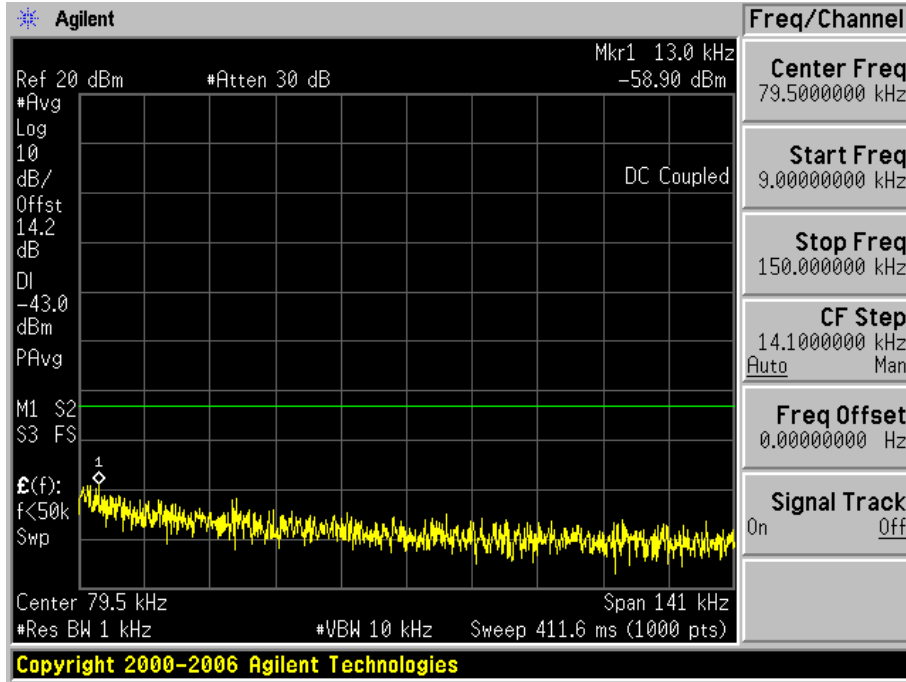

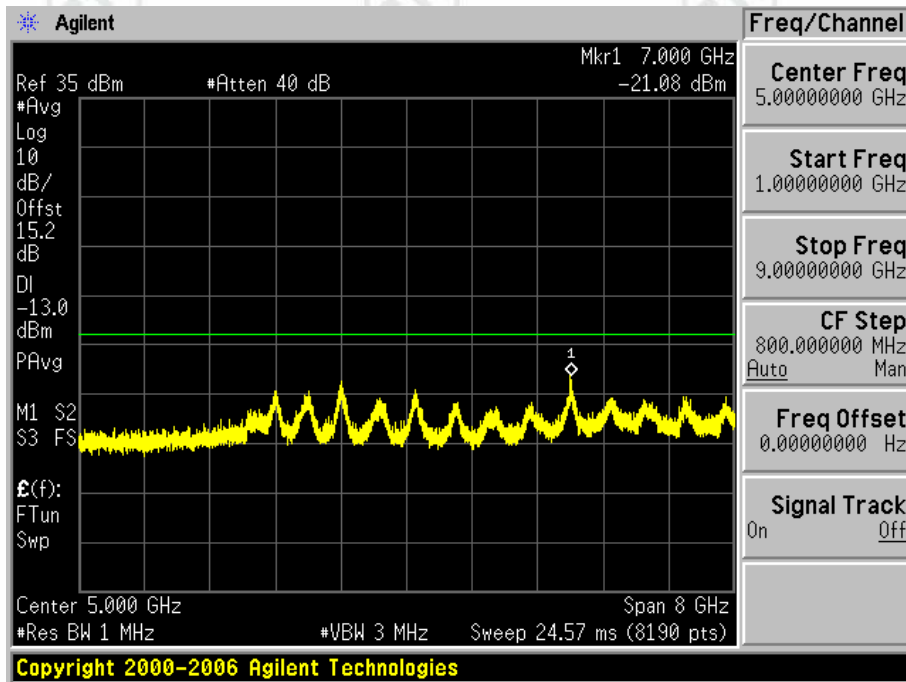
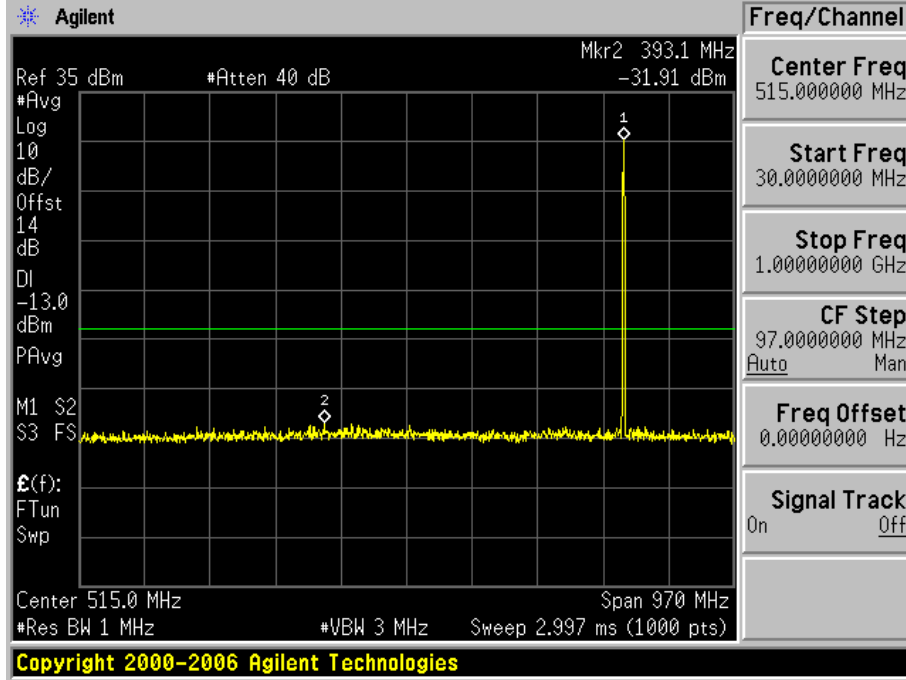

1.1.1.3 Test Channel=HCH

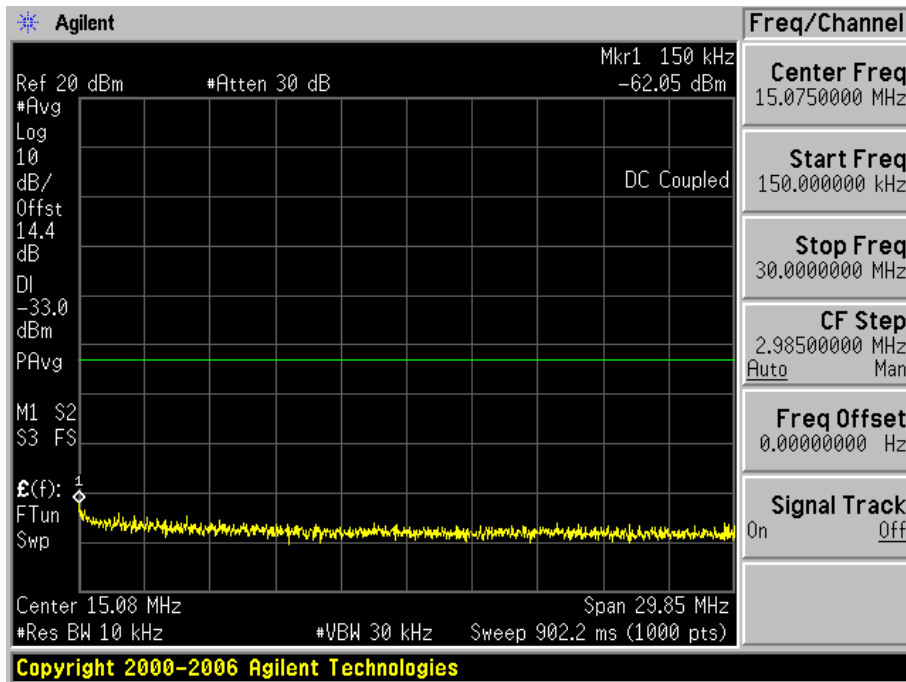
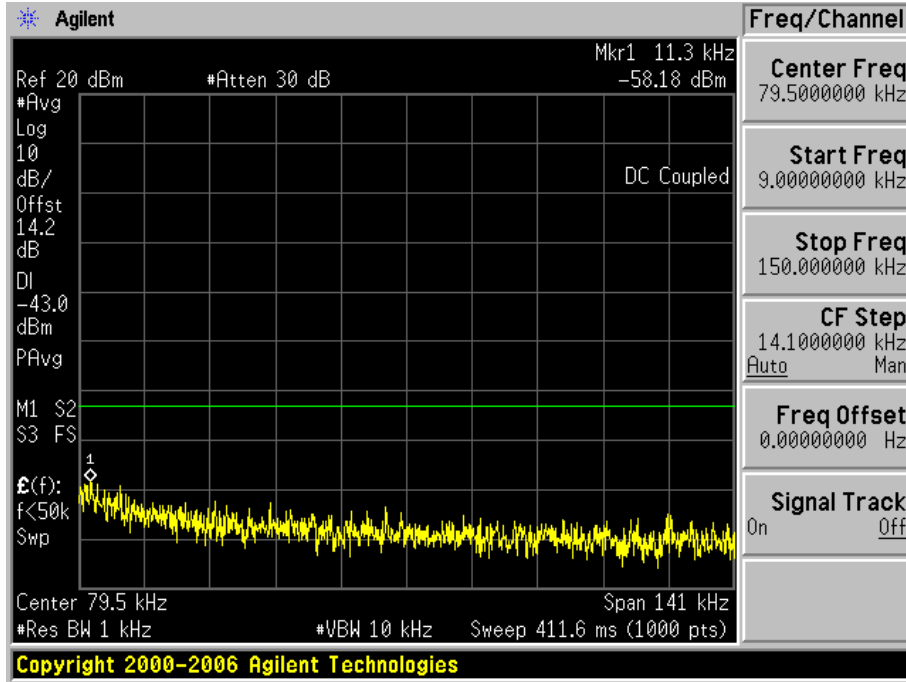

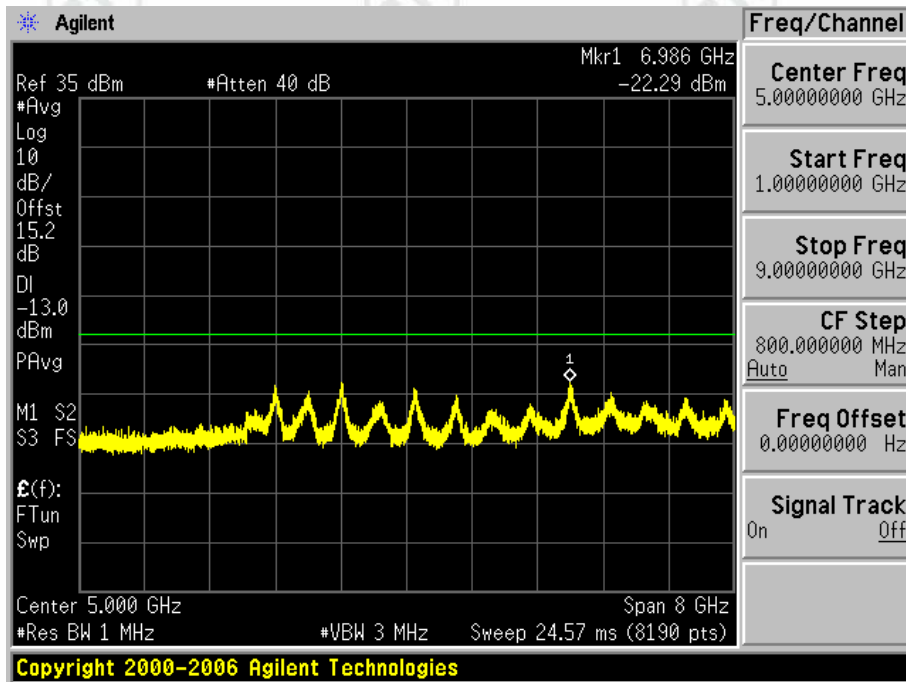
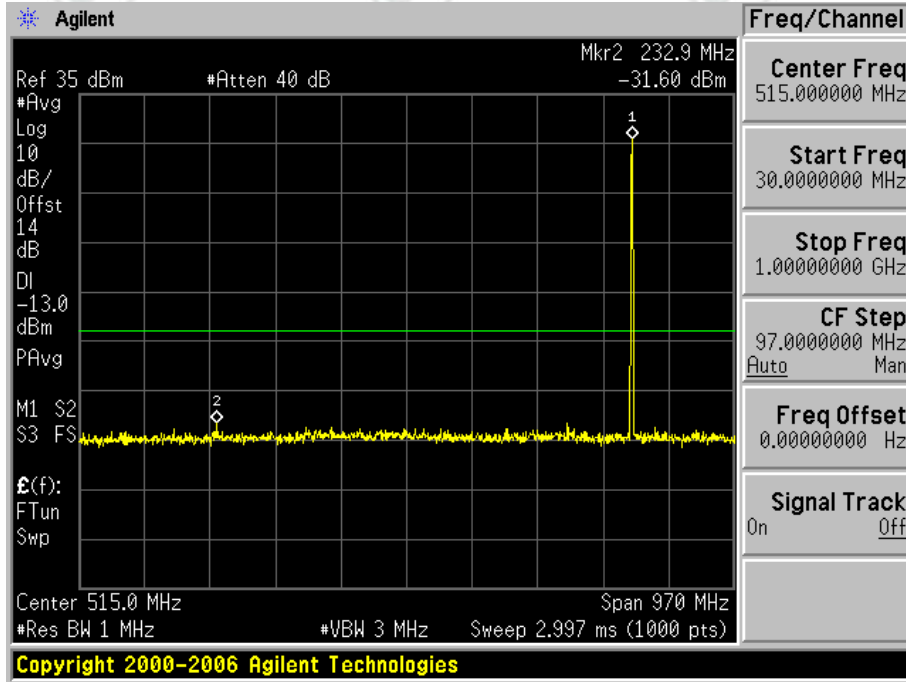

1.1.2 Test Mode=GSM/TM3

1.1.2.1 Test Channel=LCH

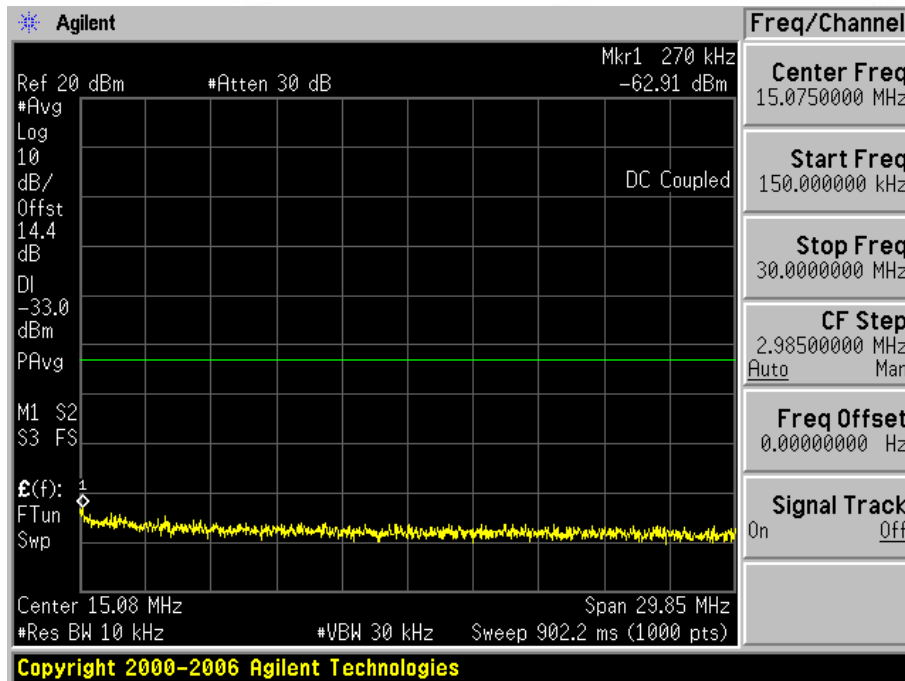
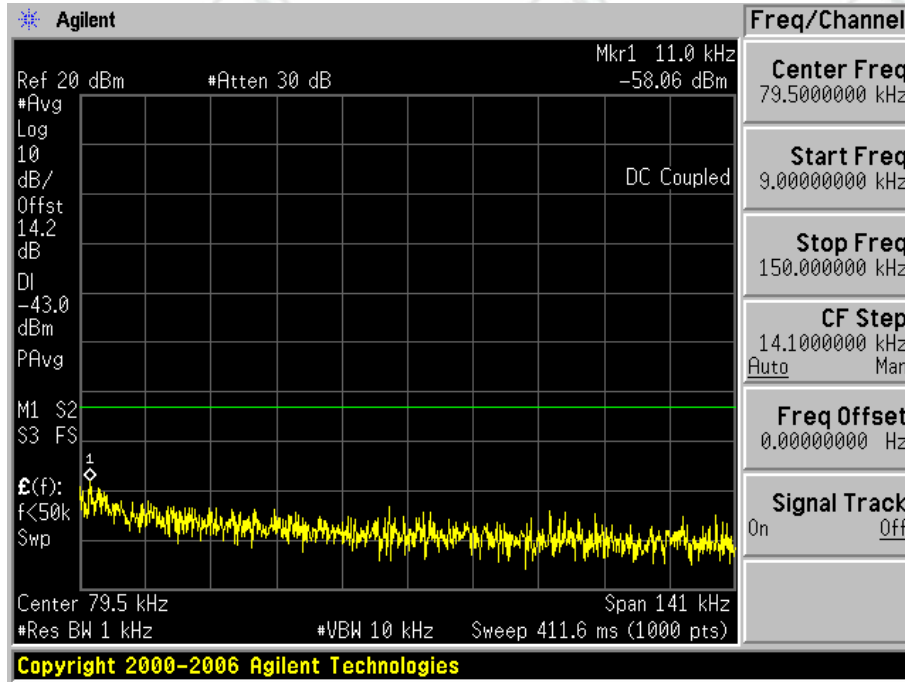

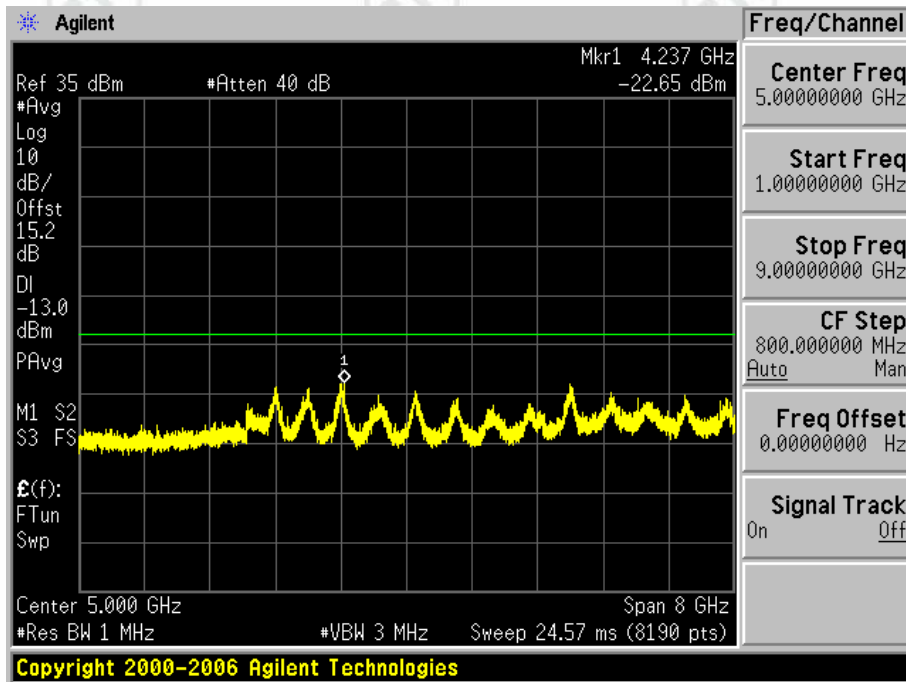
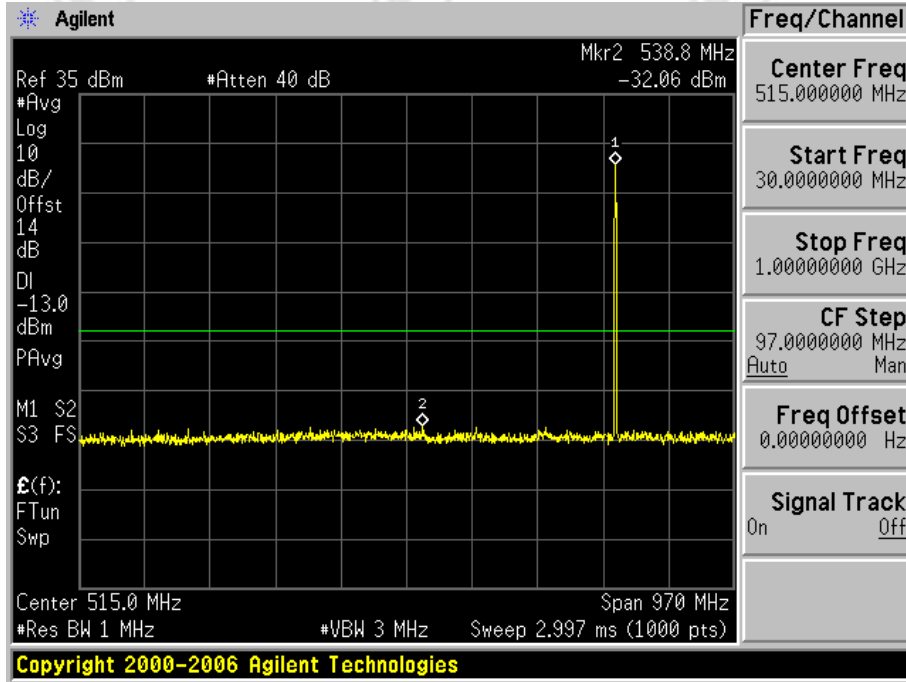

1.1.2.2 Test Channel=MCH

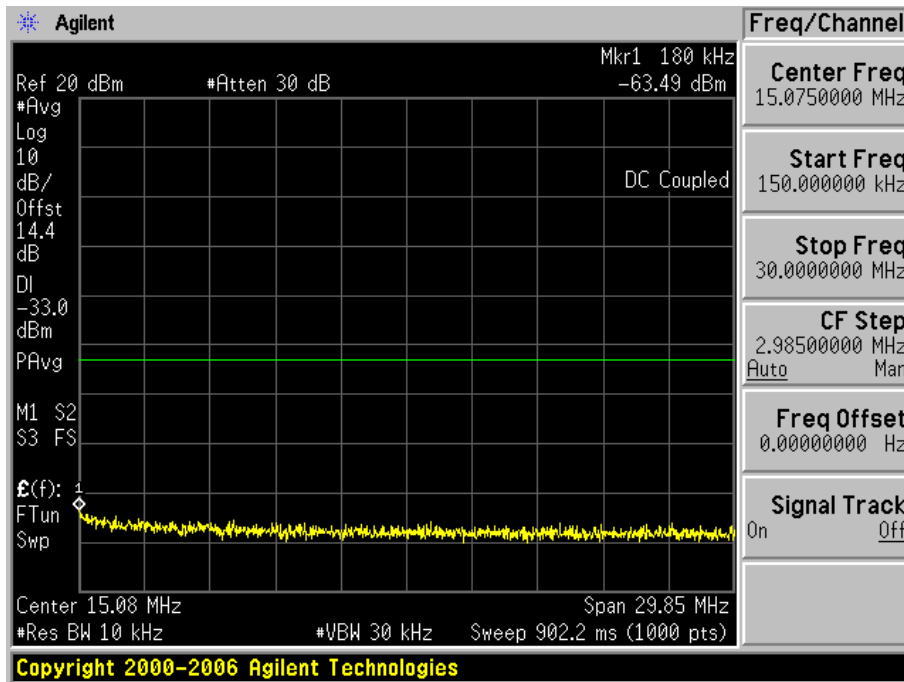
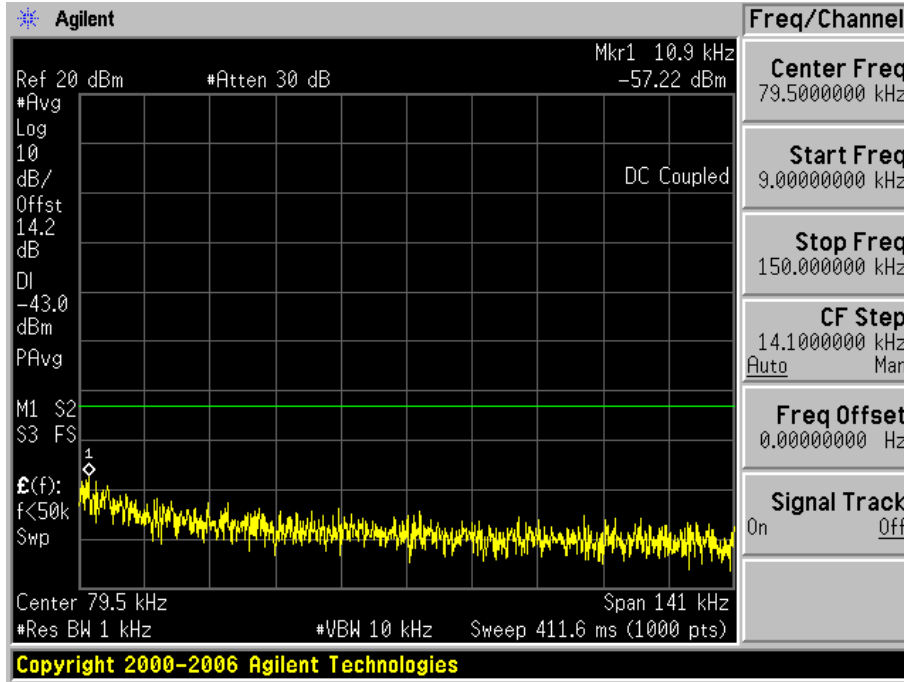

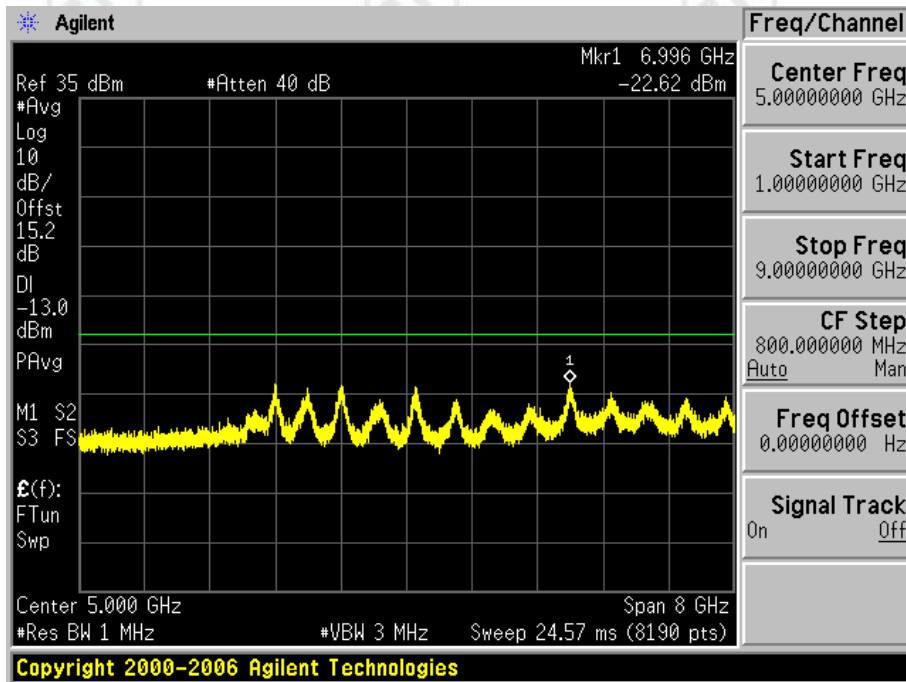
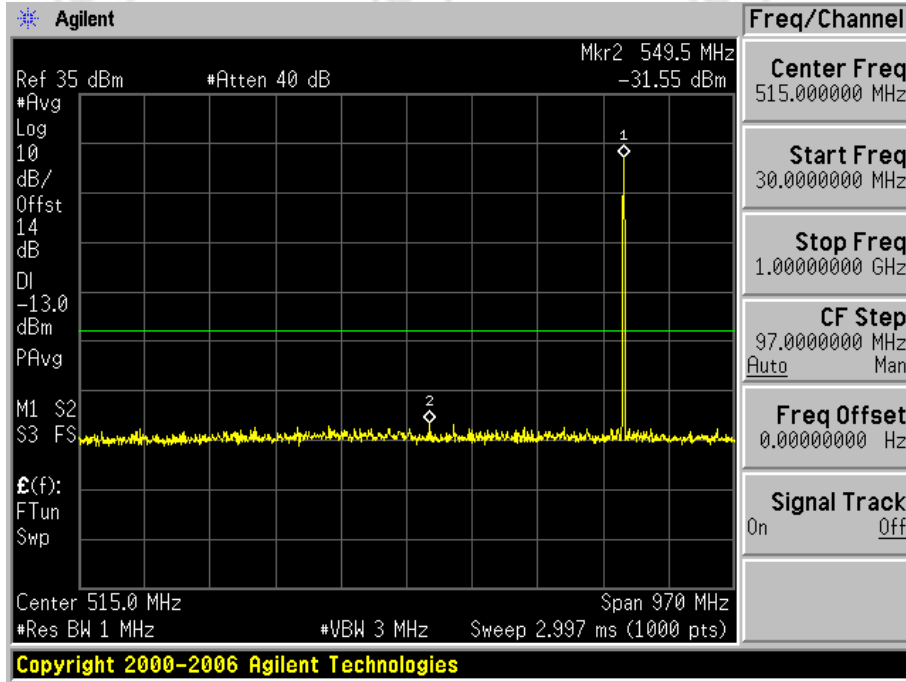

1.1.2.3 Test Channel=HCH

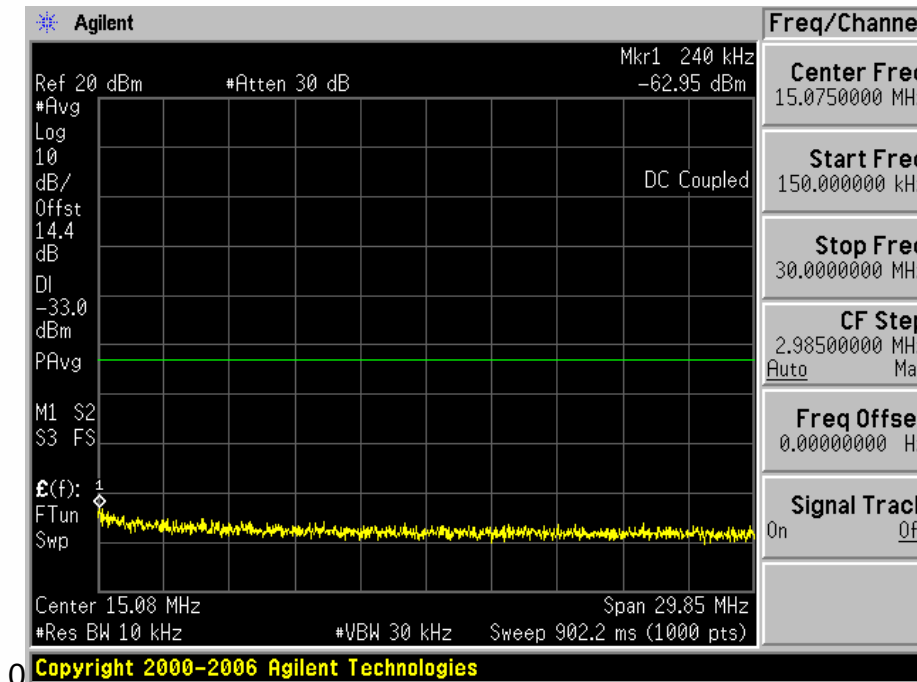
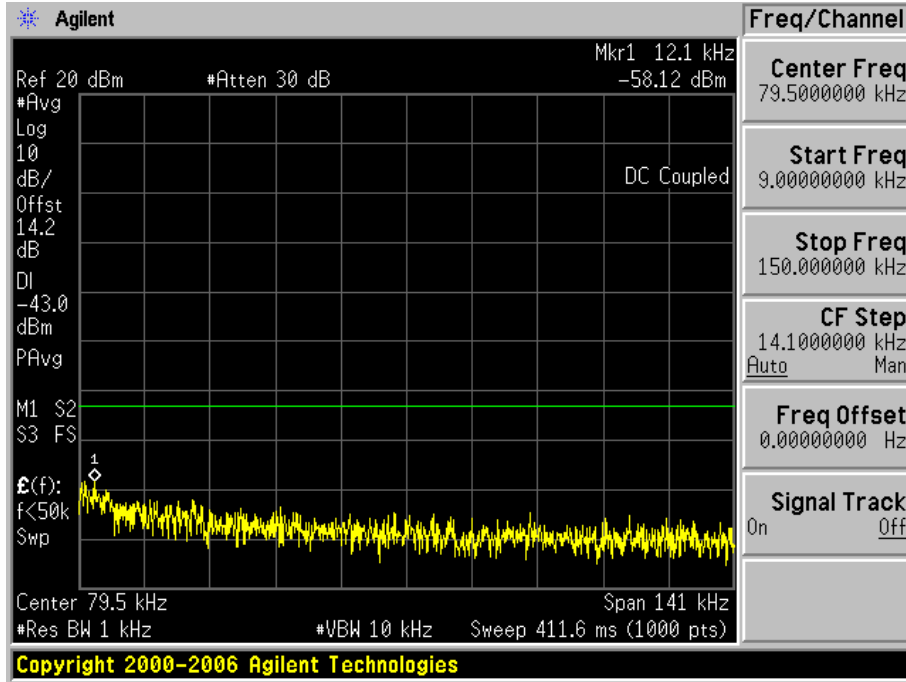

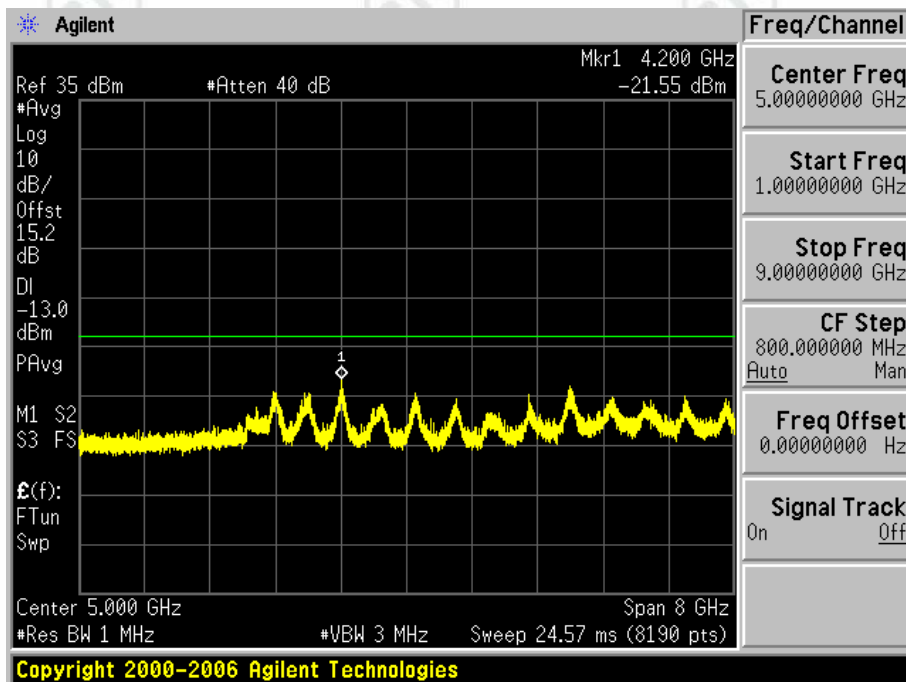
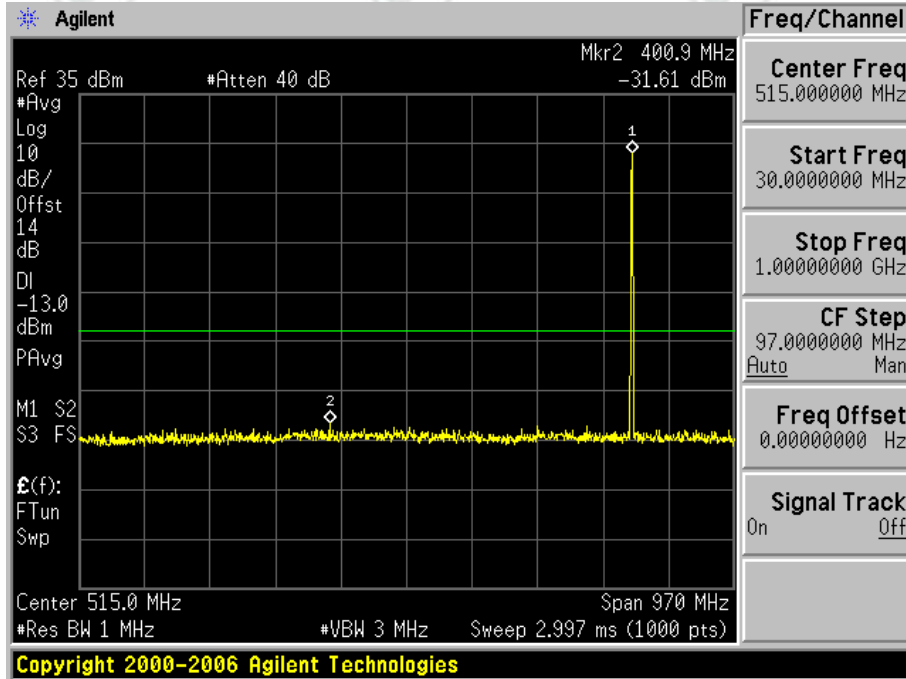

1.2 Test Band=GSM1900
1.2.1 Test Mode=GSM/TM2
1.2.1.1 Test Channel=LCH

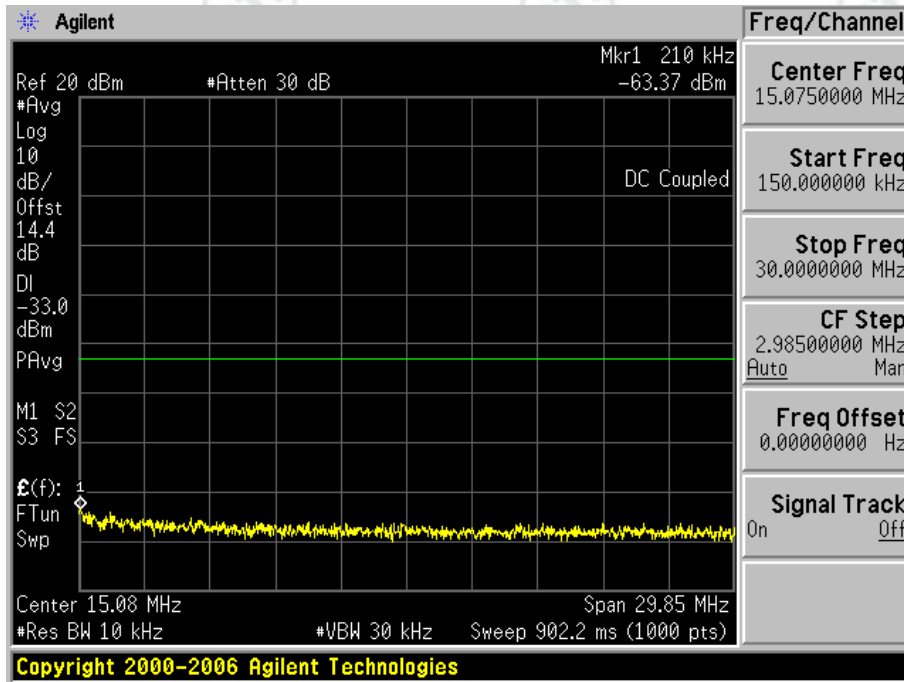
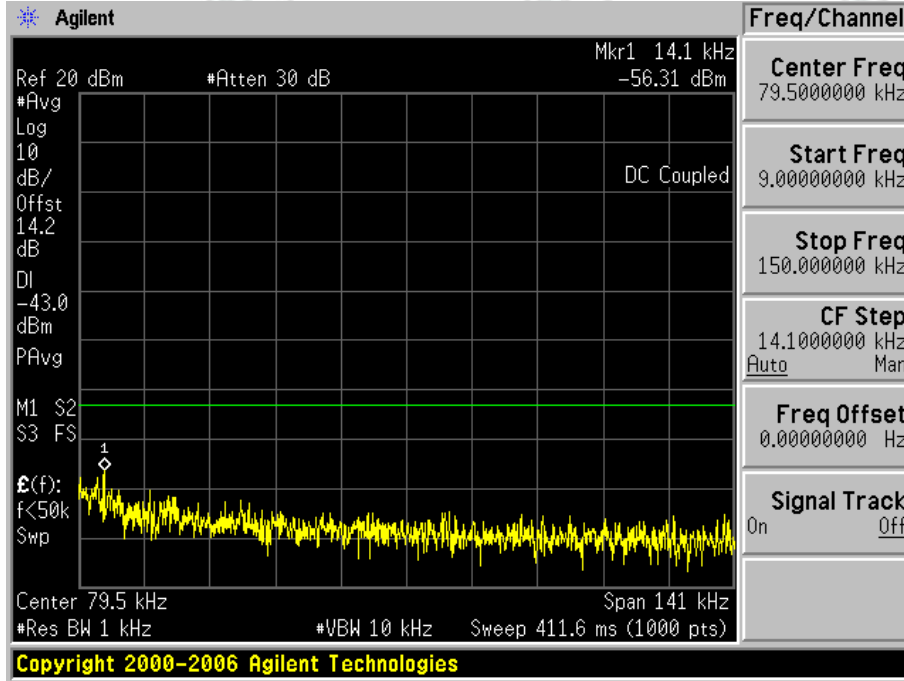

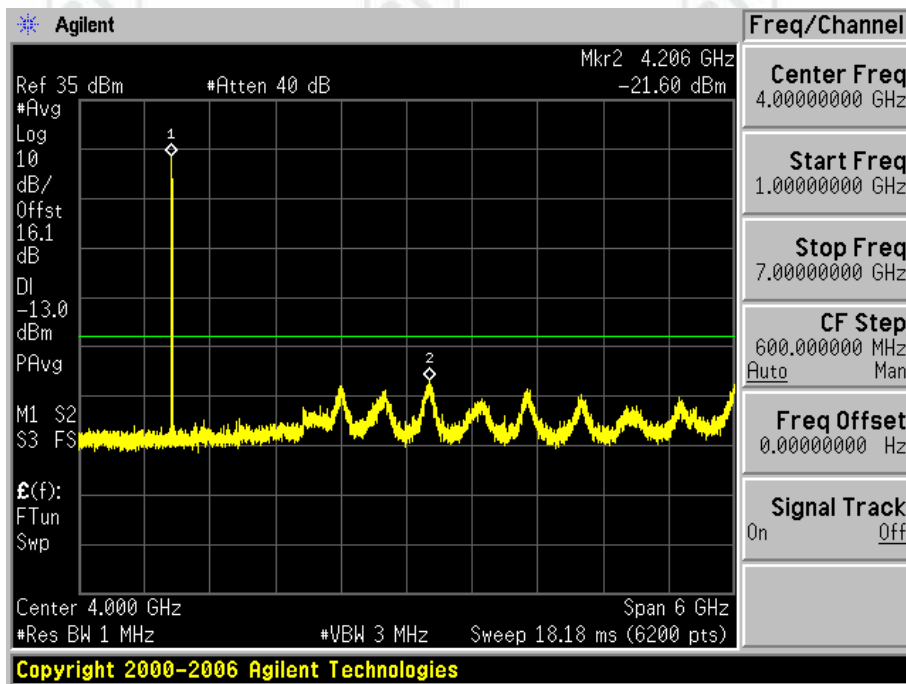
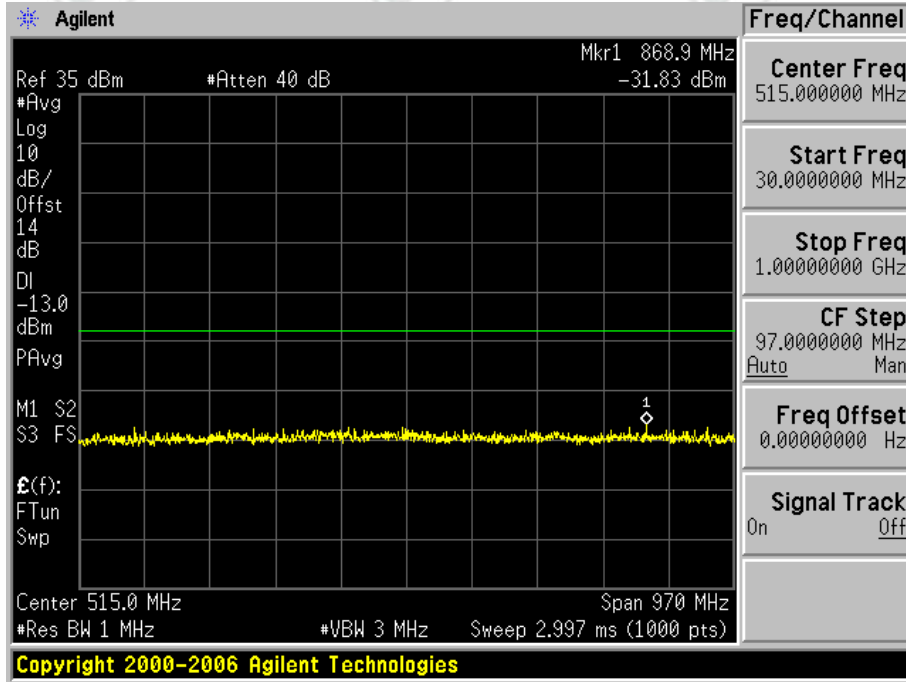

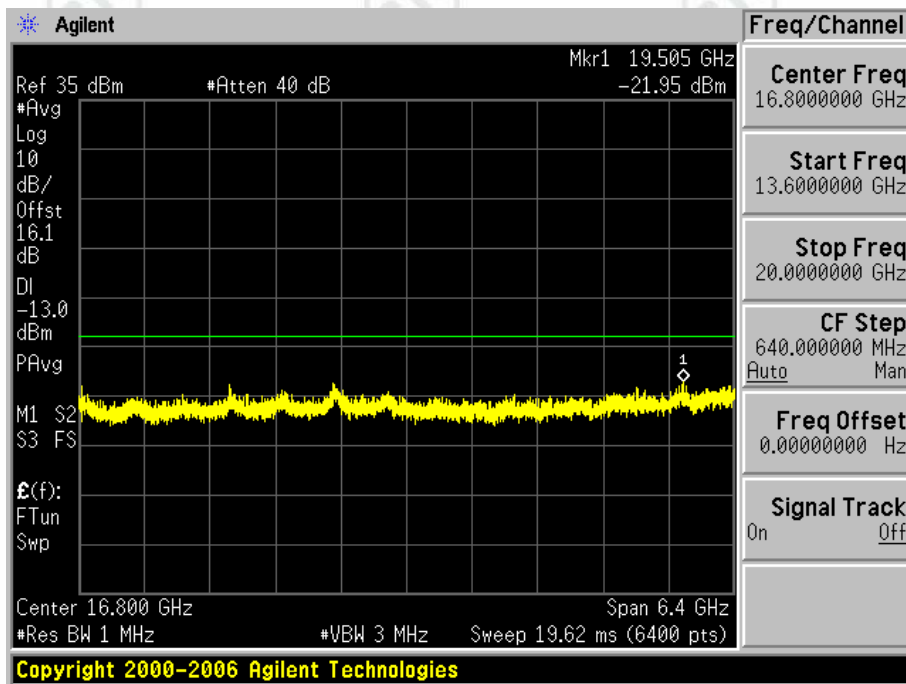
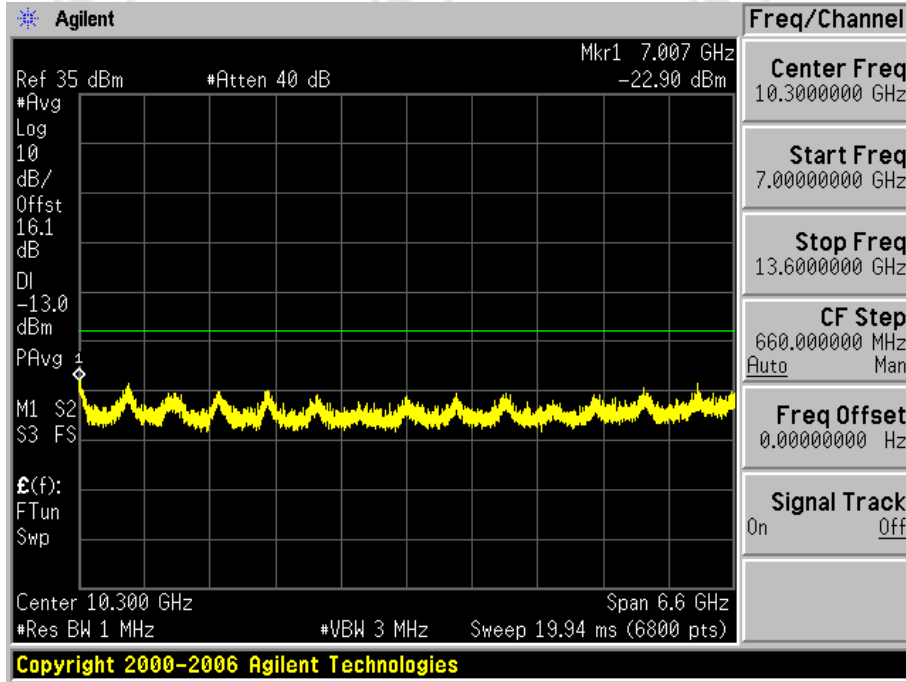

1.2.1.2 Test Channel=MCH

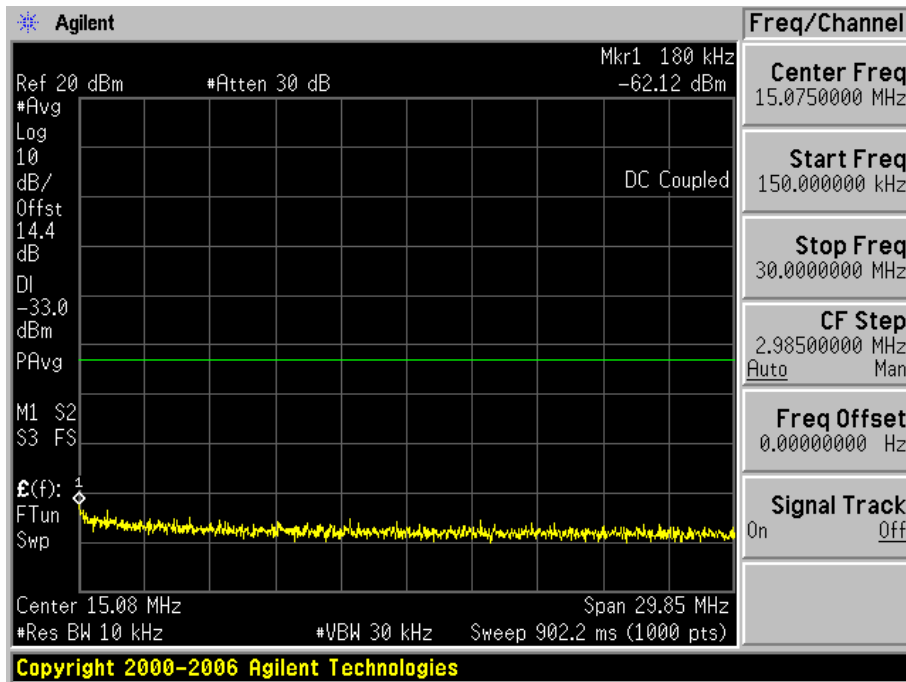
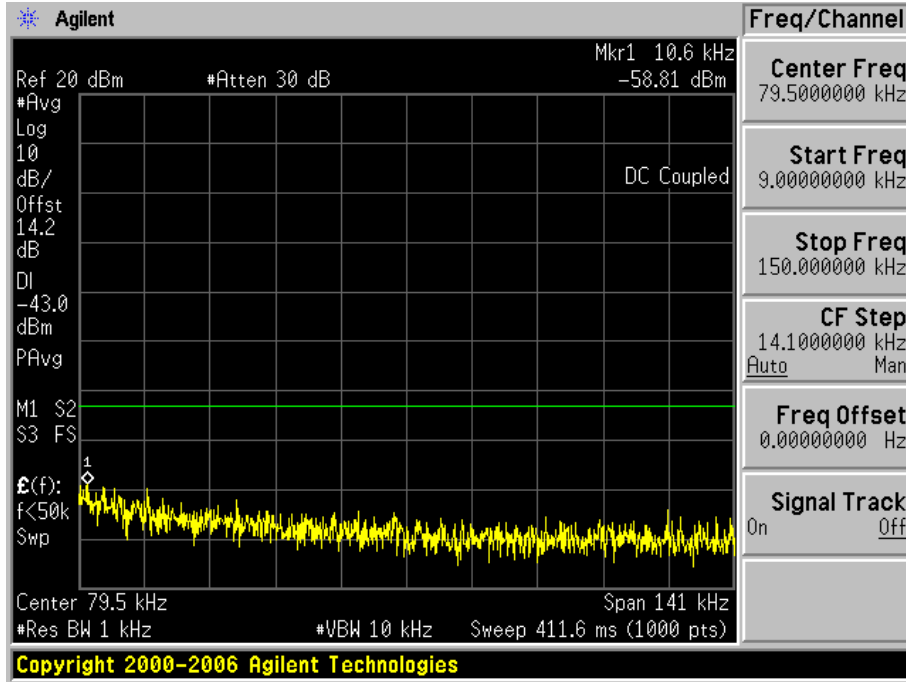

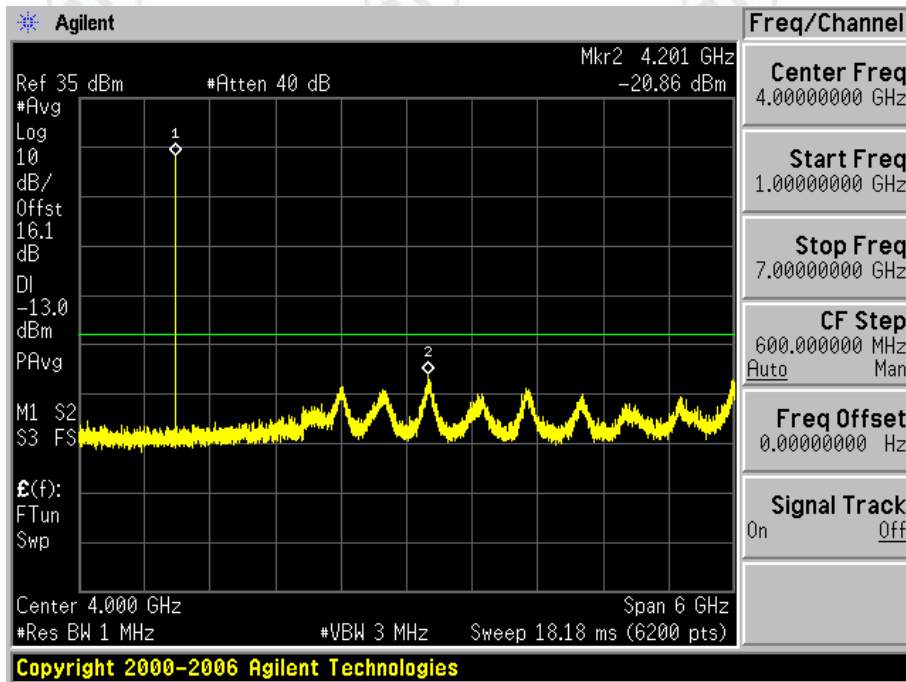
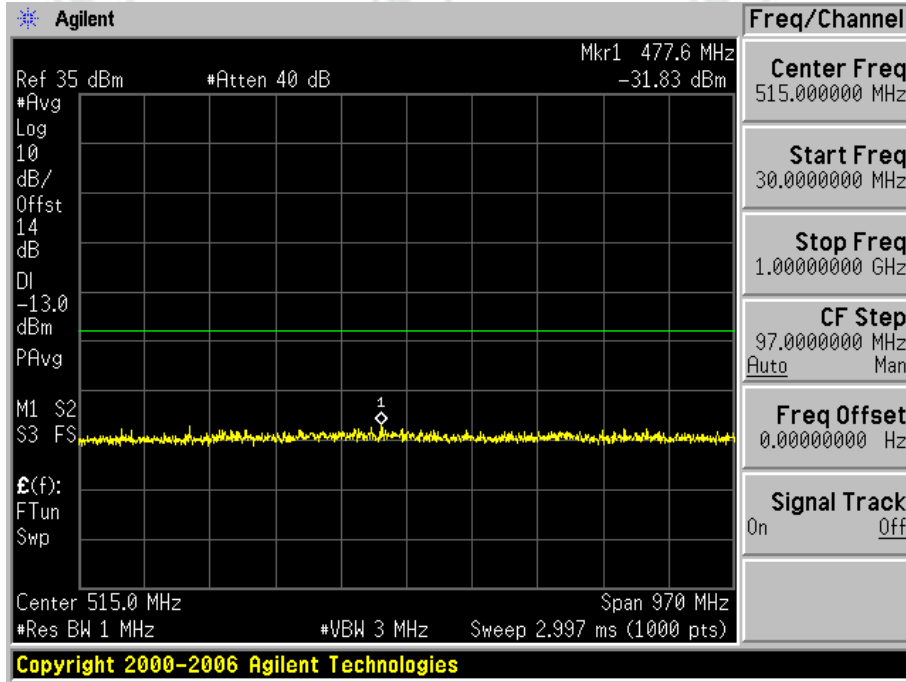

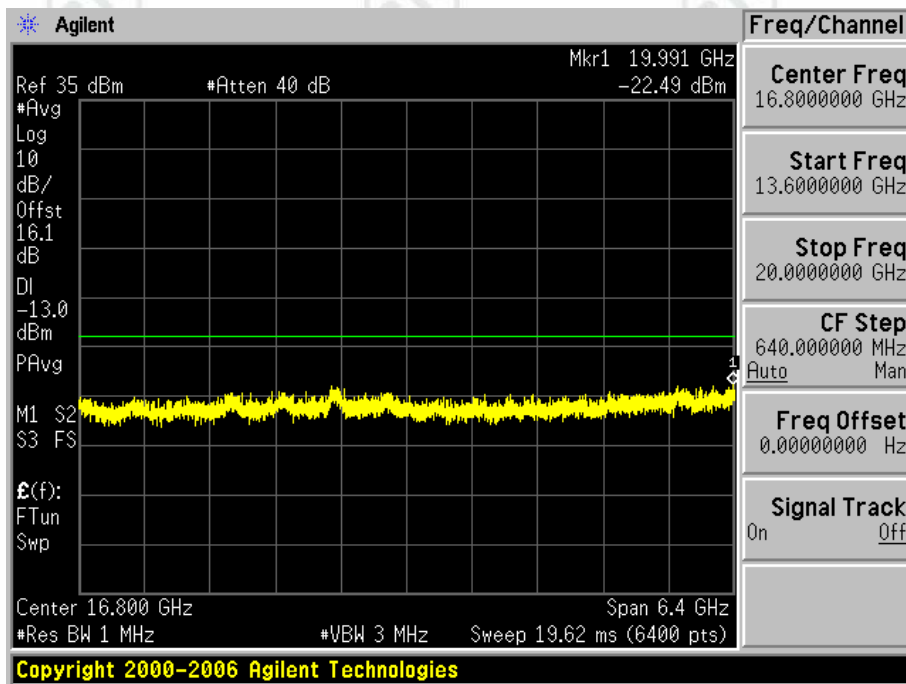
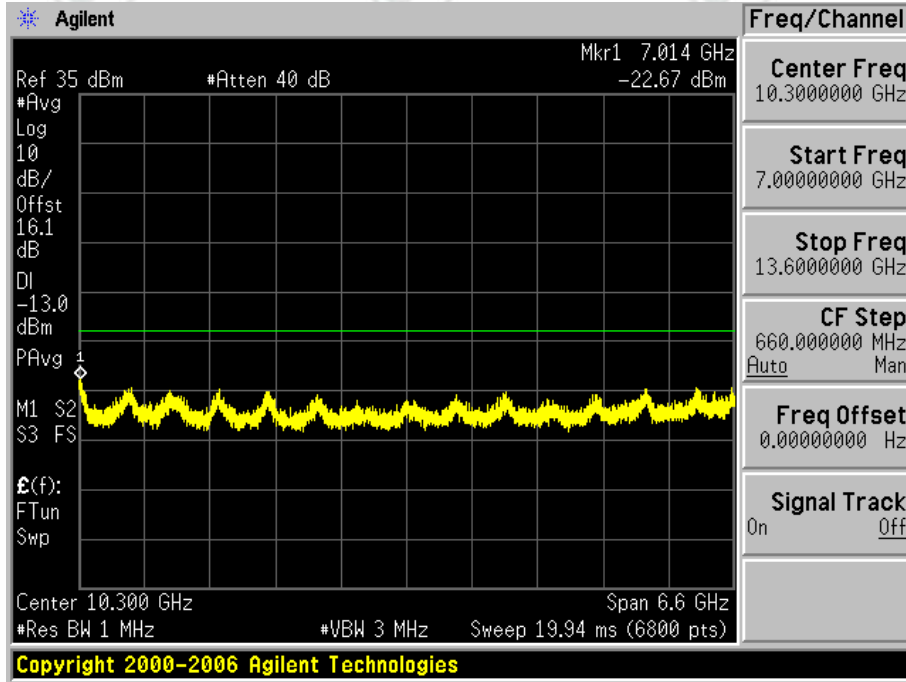

1.2.1.3 Test Channel=HCH

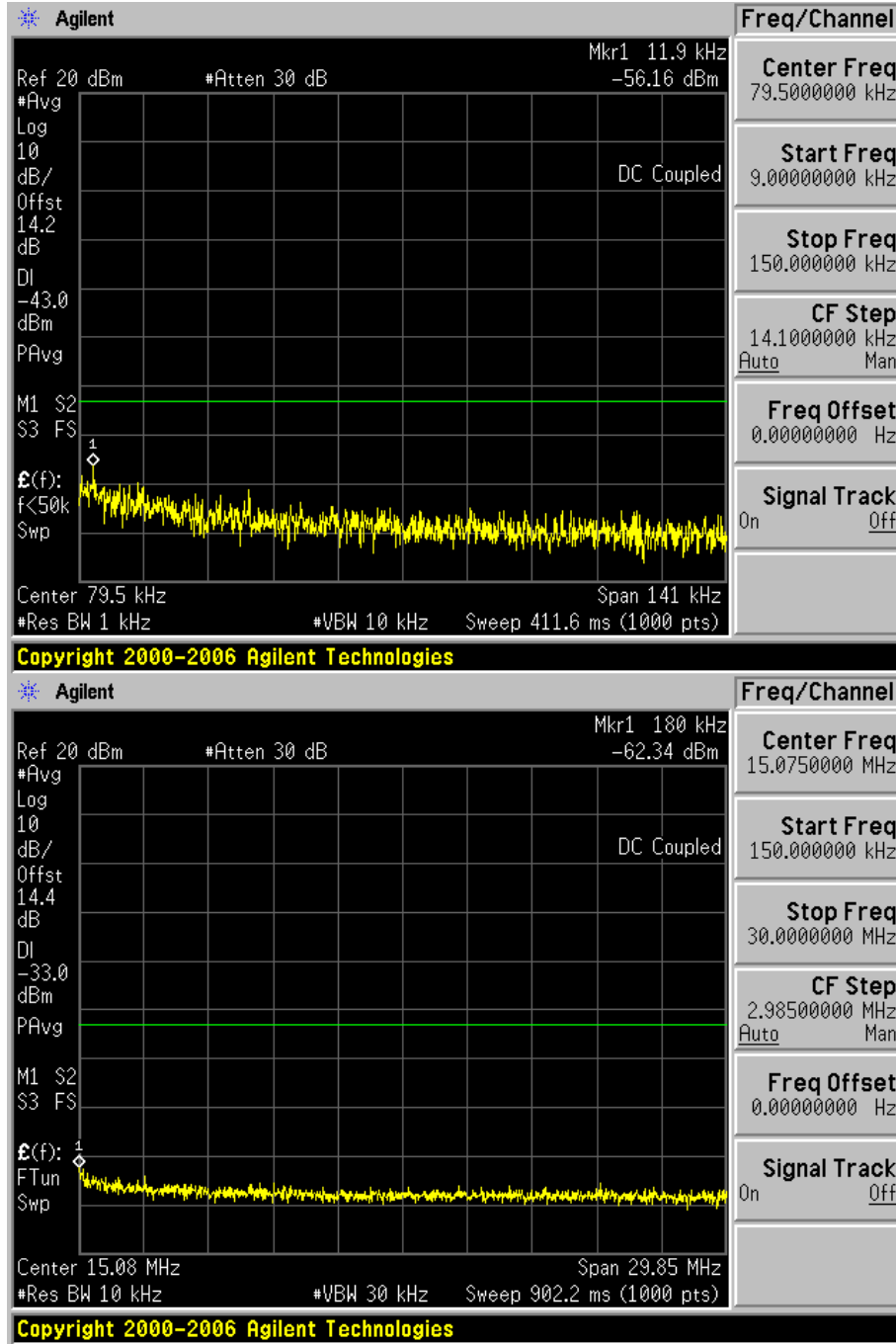

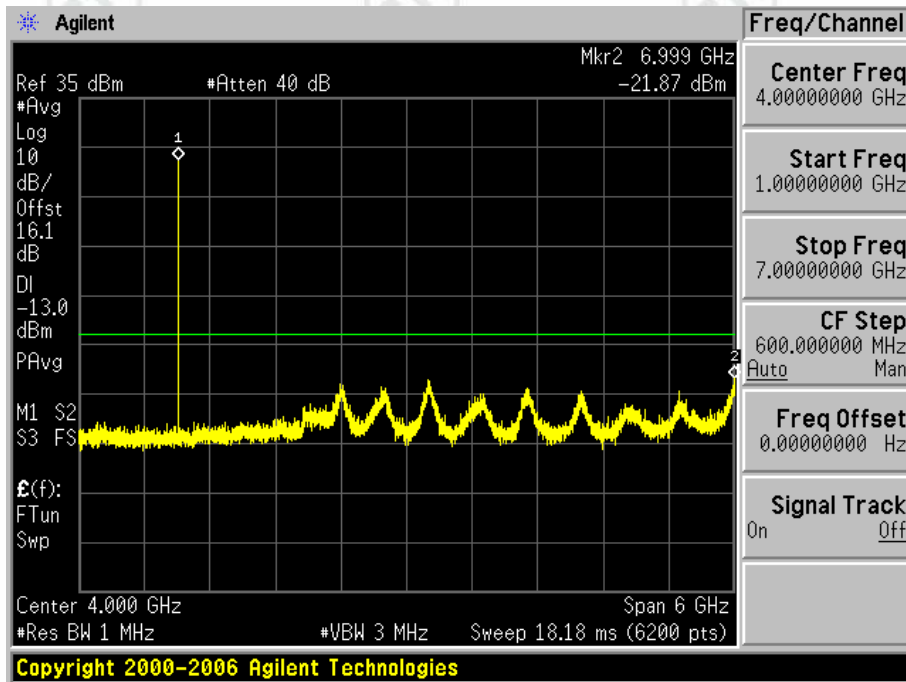
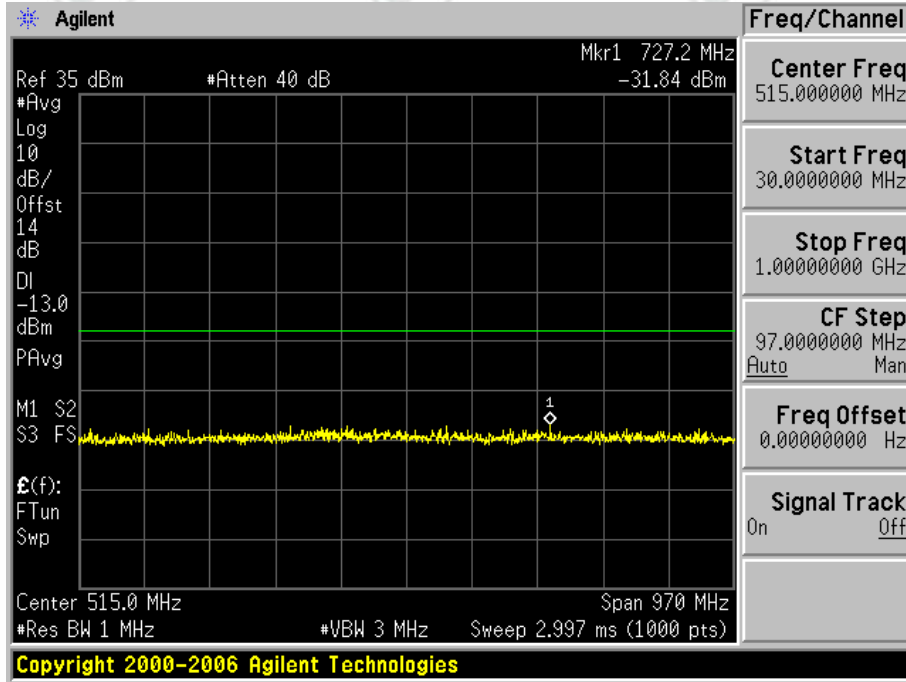

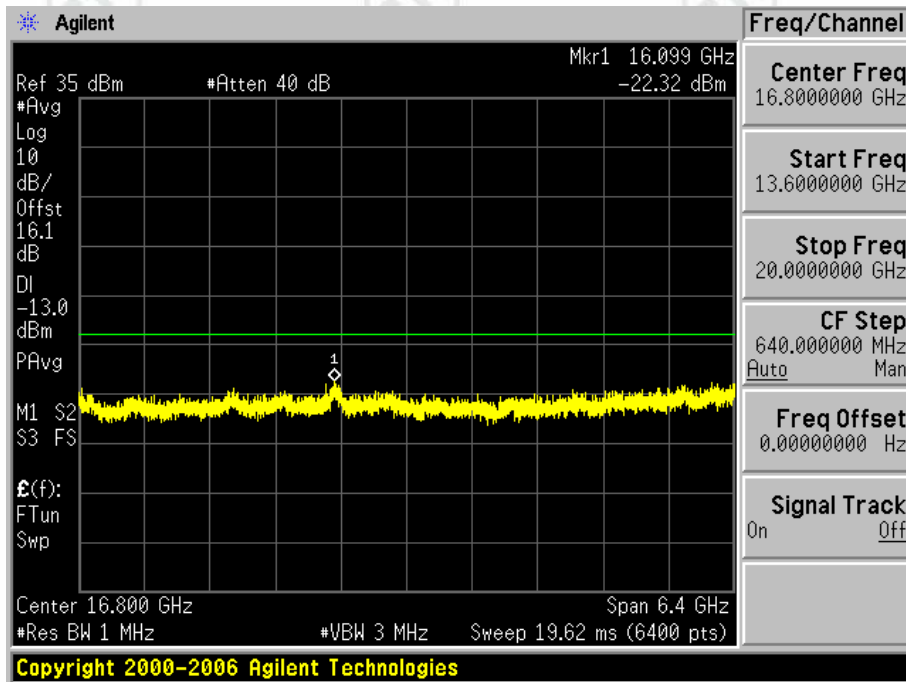
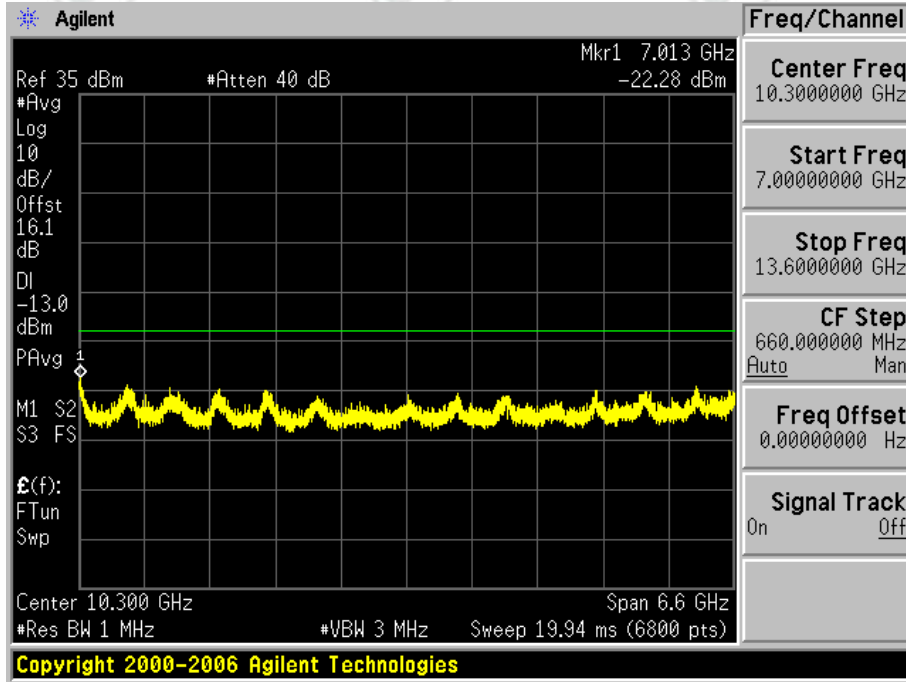

1.2.2 Test Mode=GSM/TM3

1.2.2.1 Test Channel=LCH

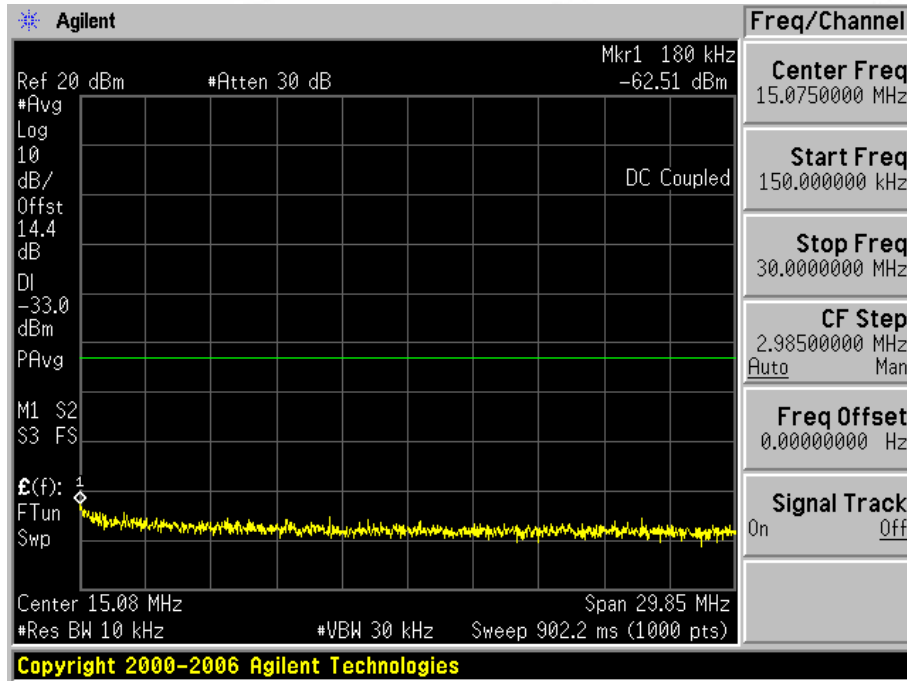
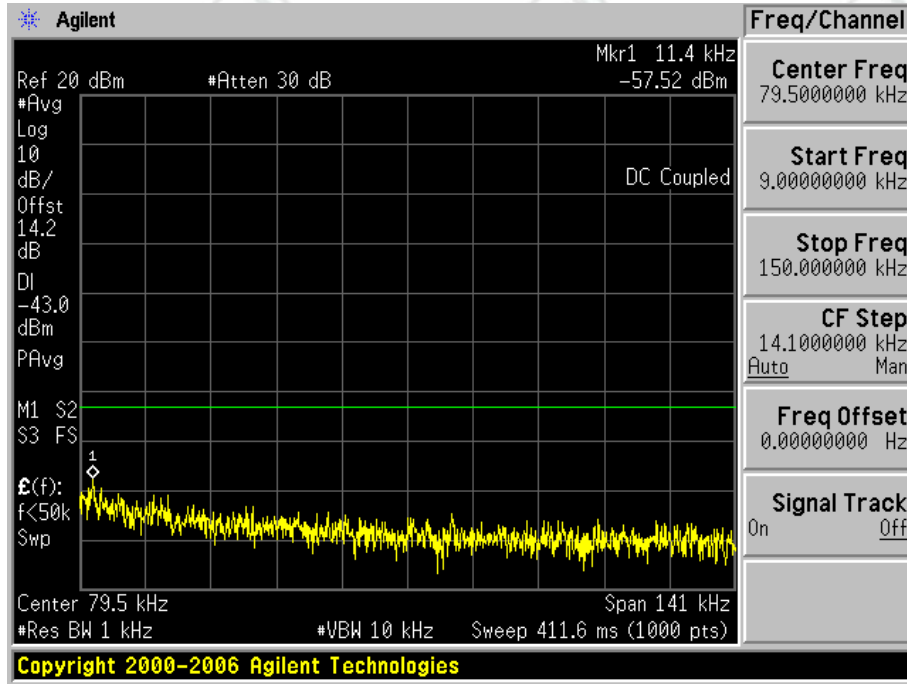

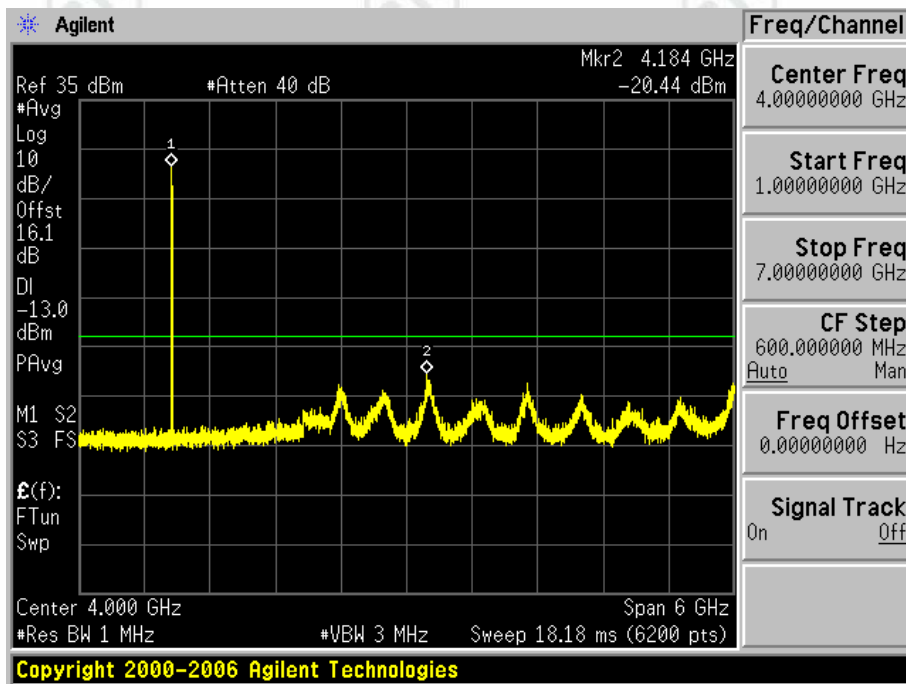
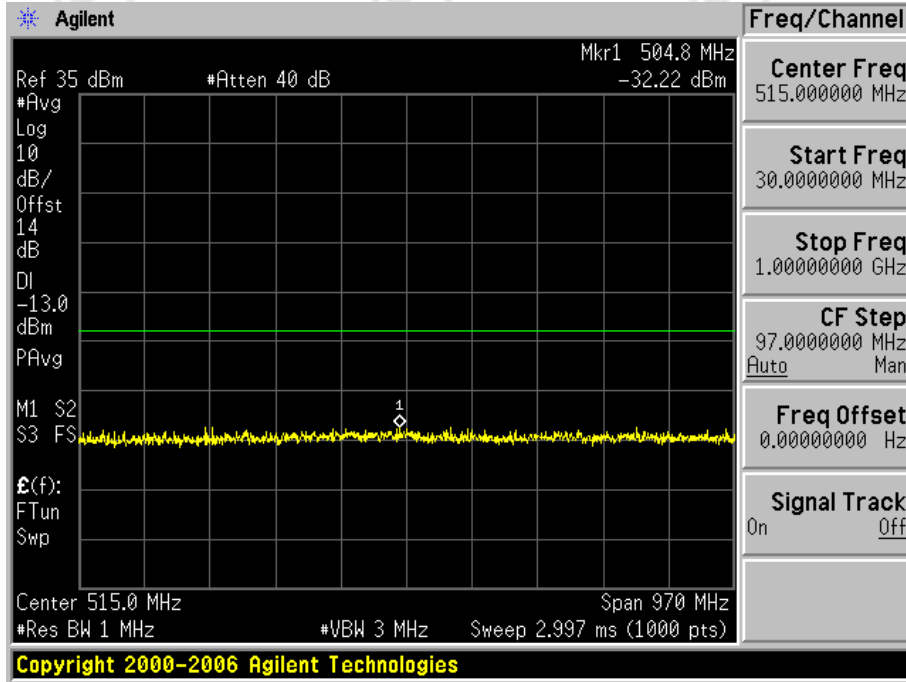

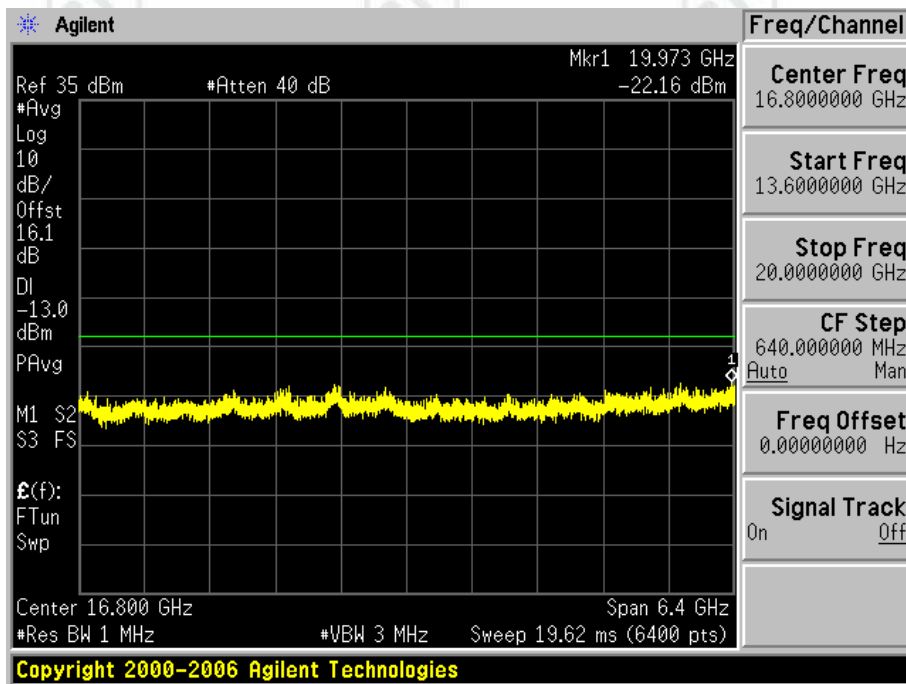
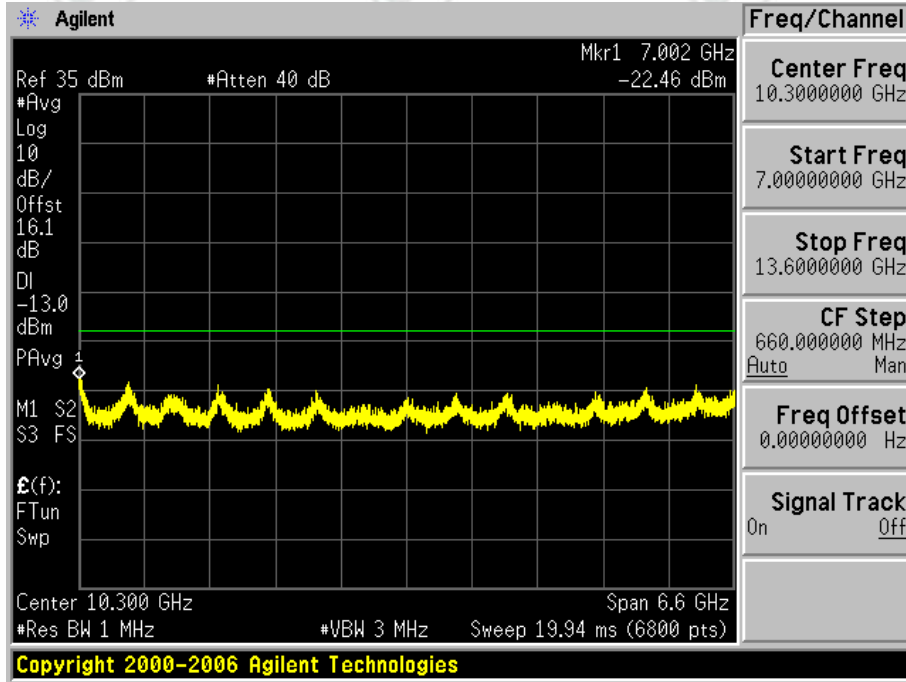

1.2.2.2 Test Channel=MCH

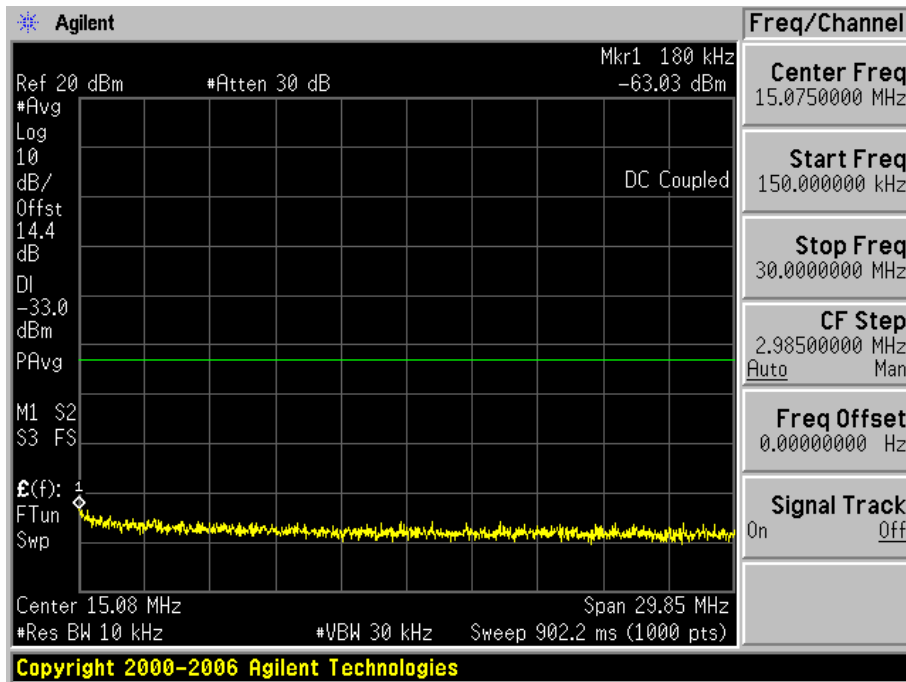
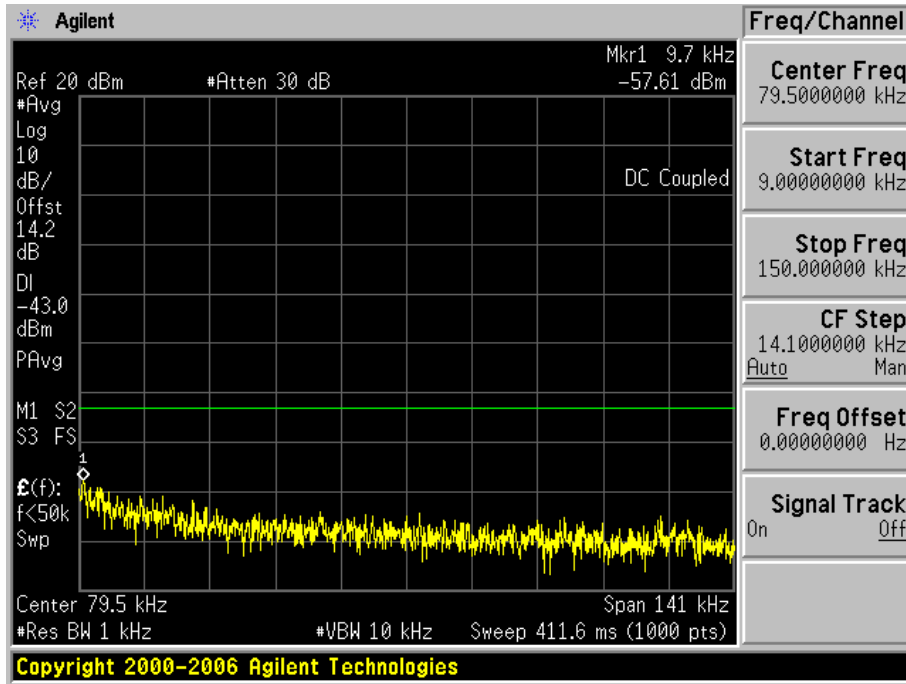

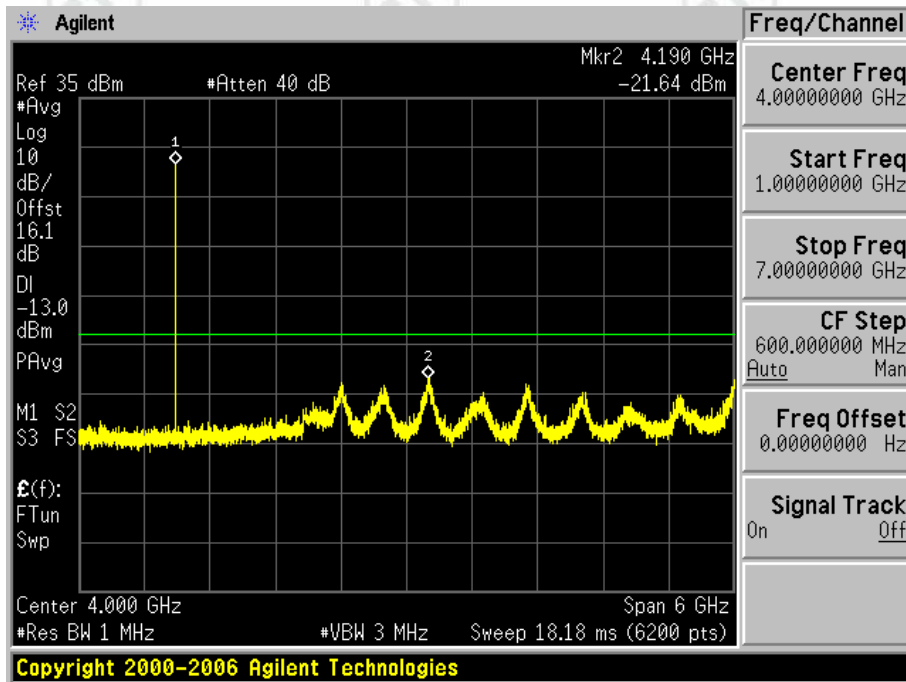
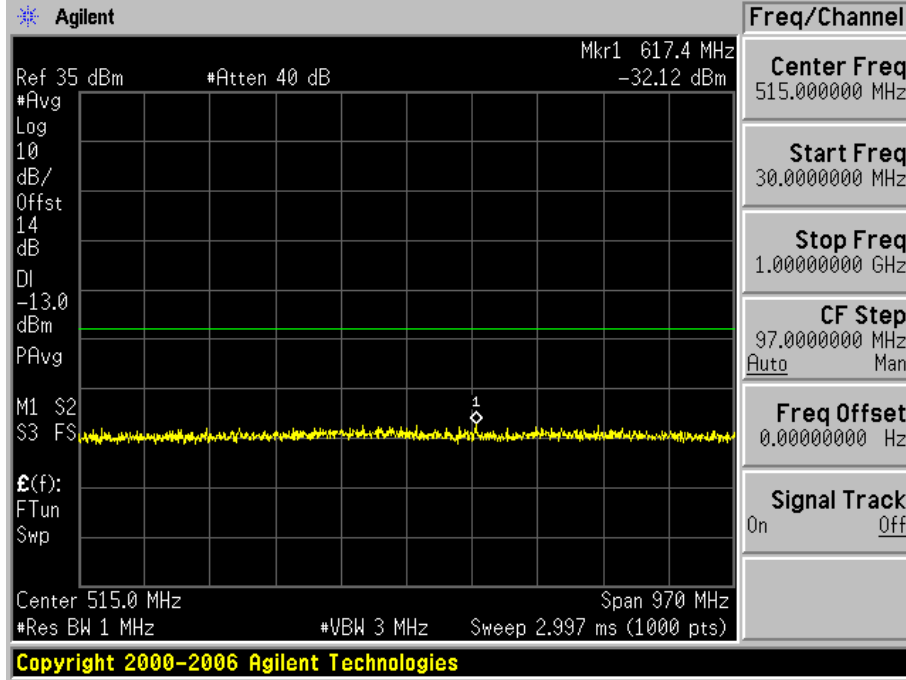

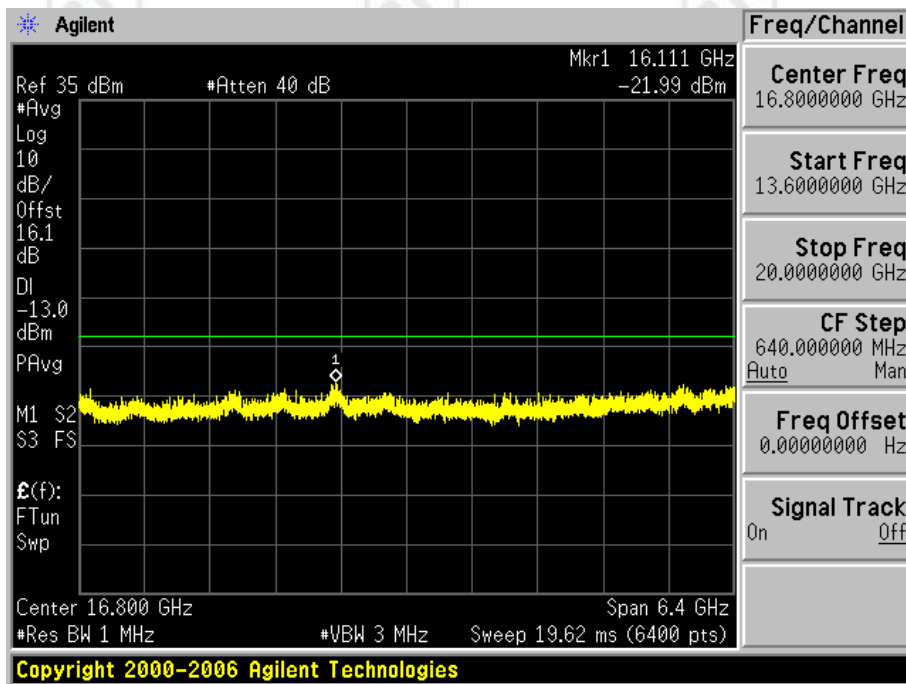
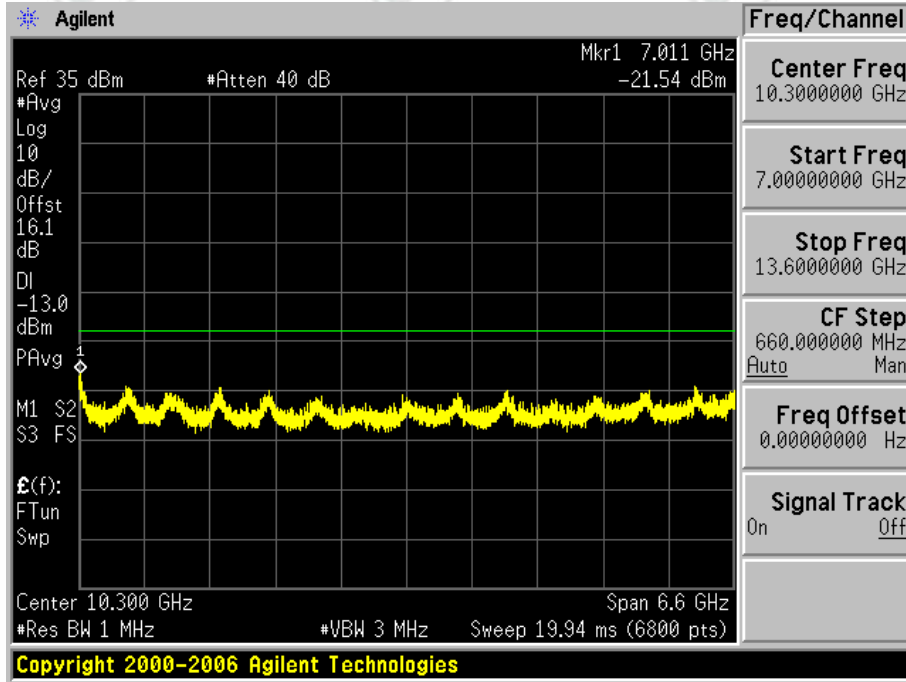

1.2.2.3 Test Channel=HCH

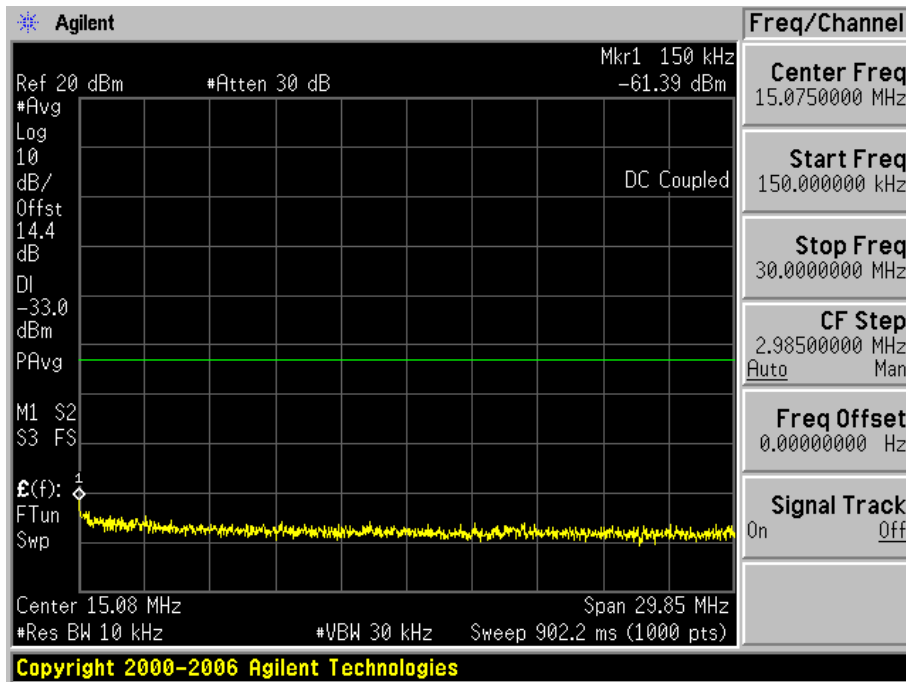
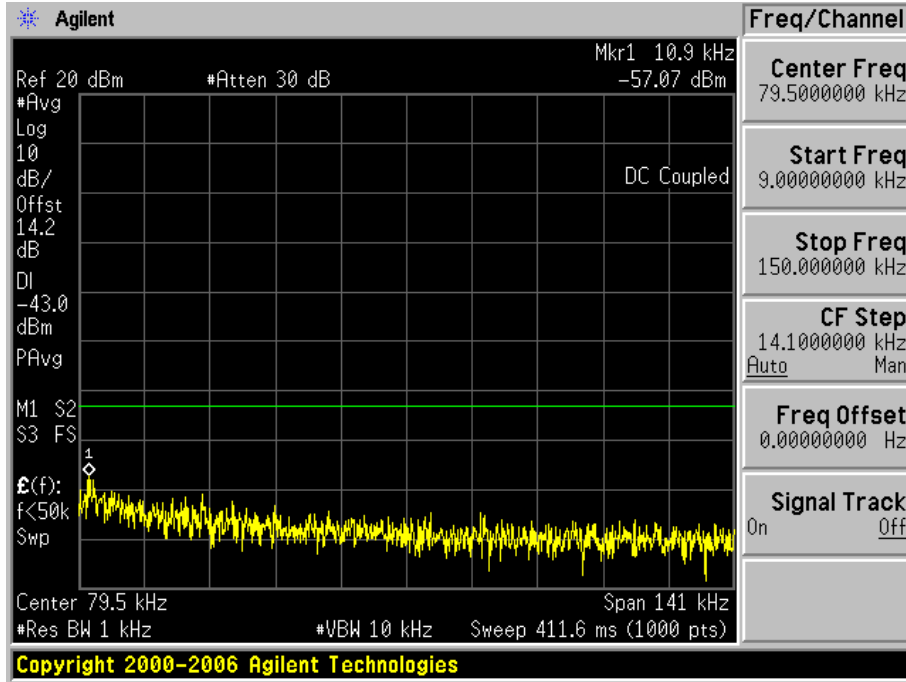

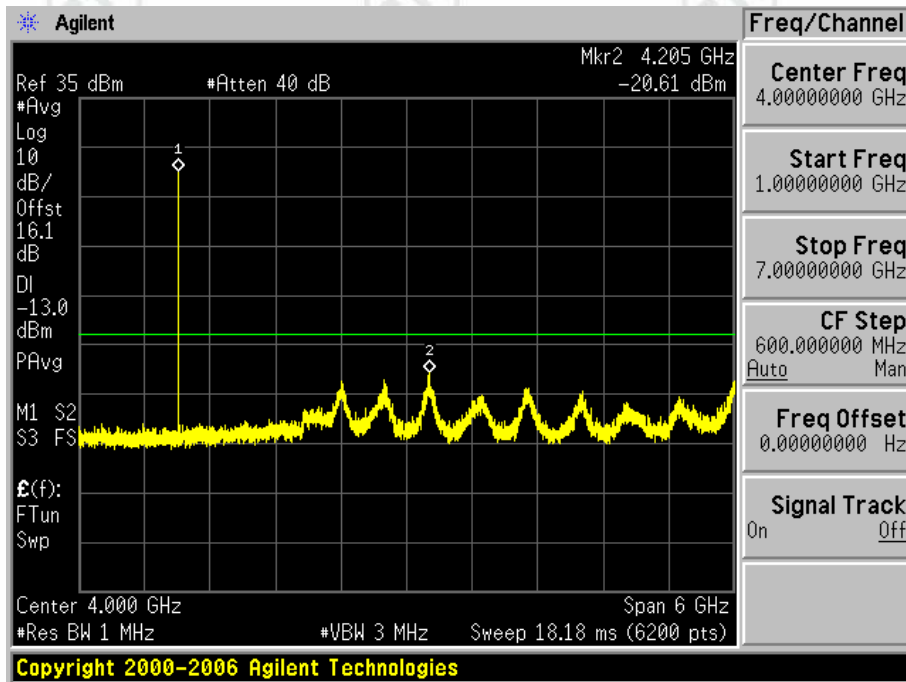
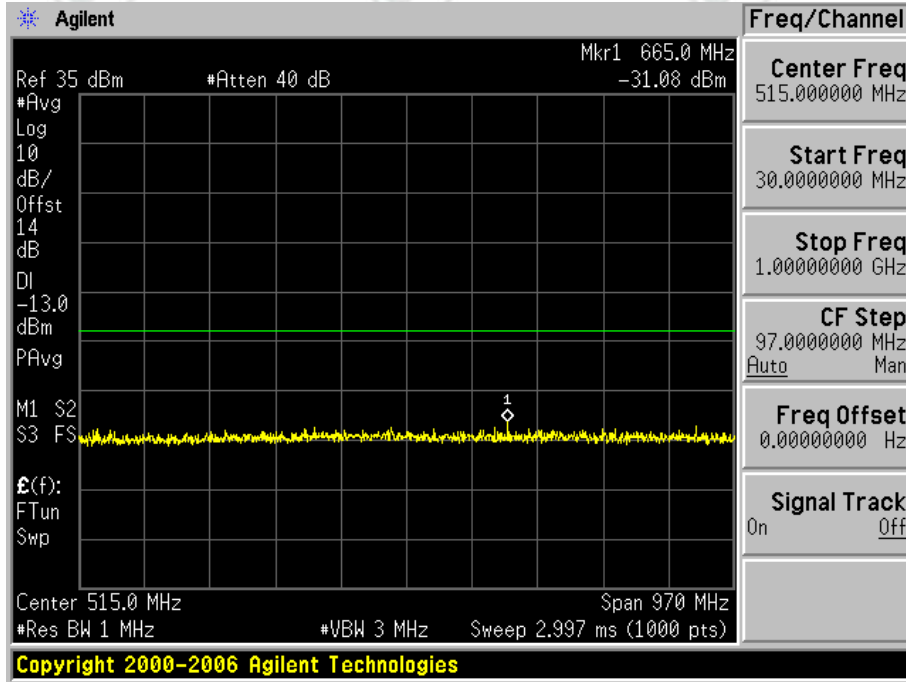

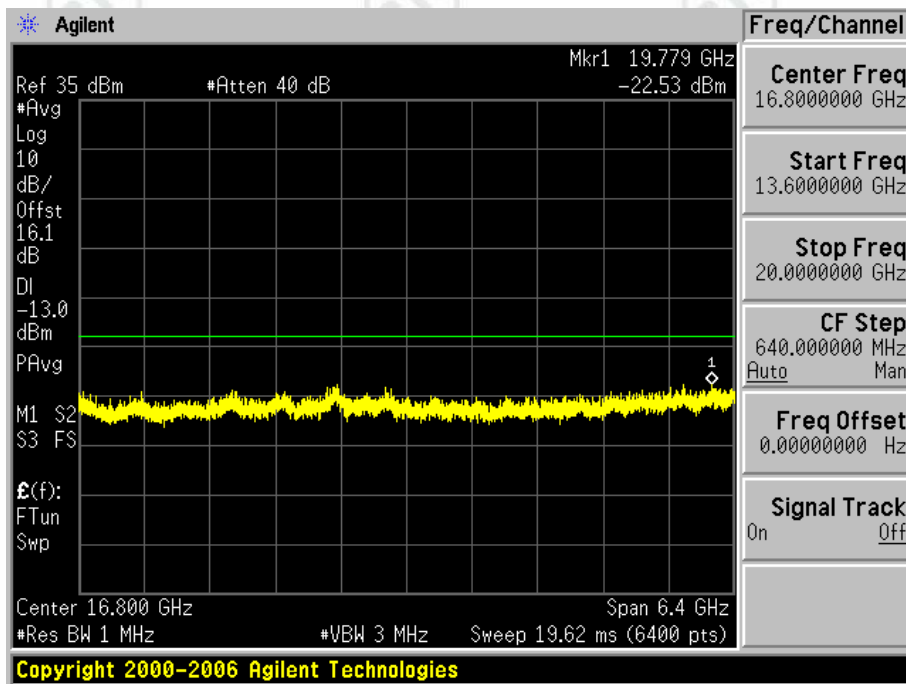
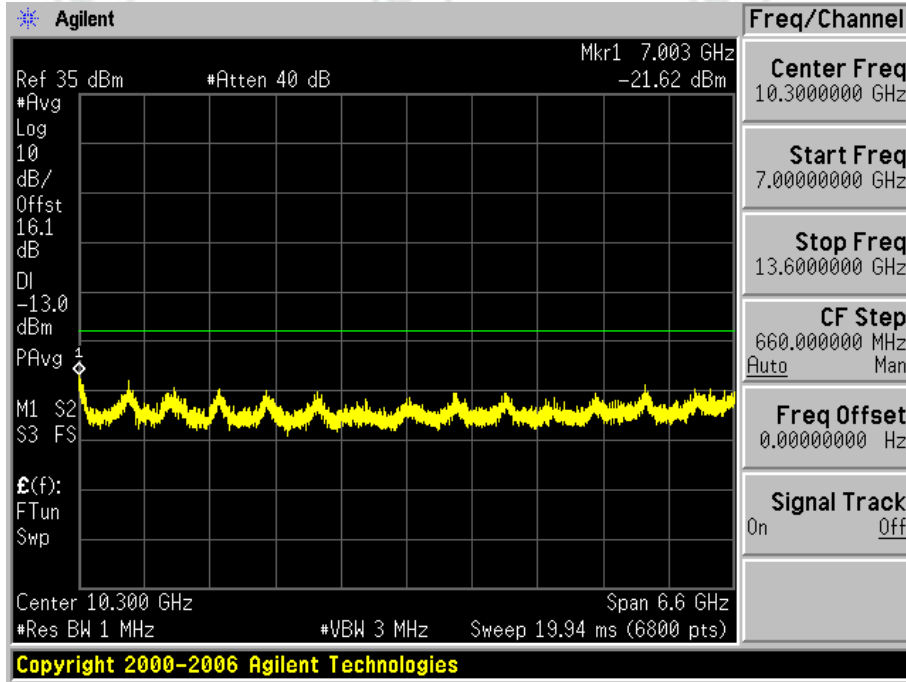

- 2 For WCDMA
- 2.1 Test Band=WCDMA850
- 2.1.1 Test Mode=UMTS/TM1
- 2.1.1.1 Test Channel=LCH

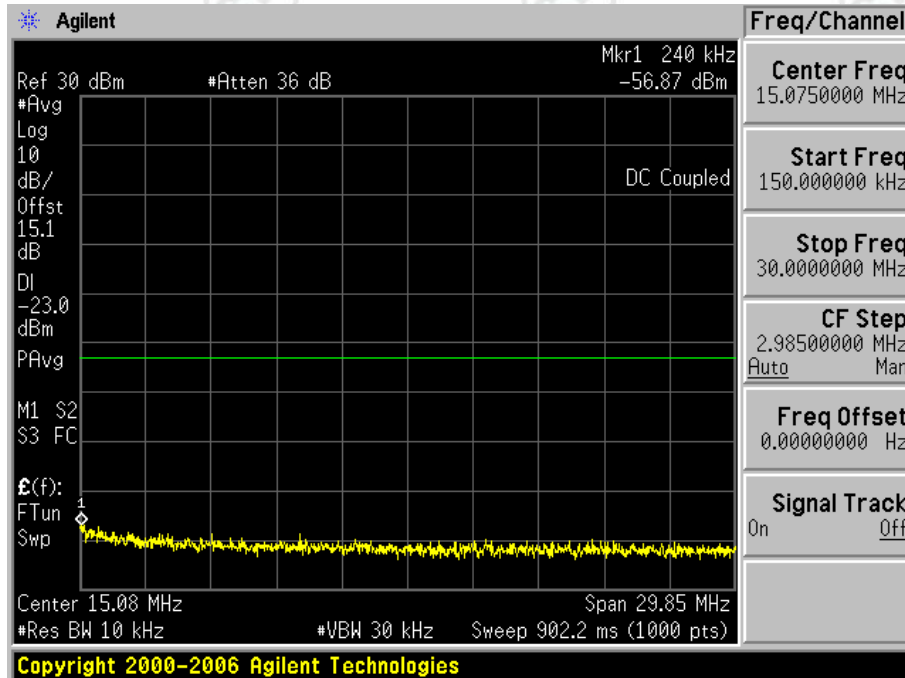
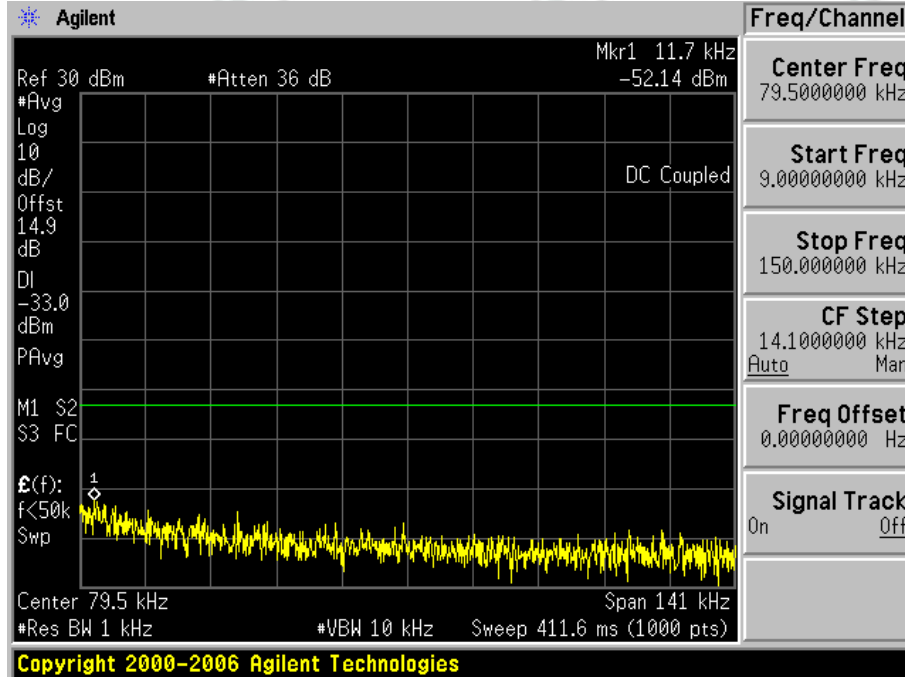

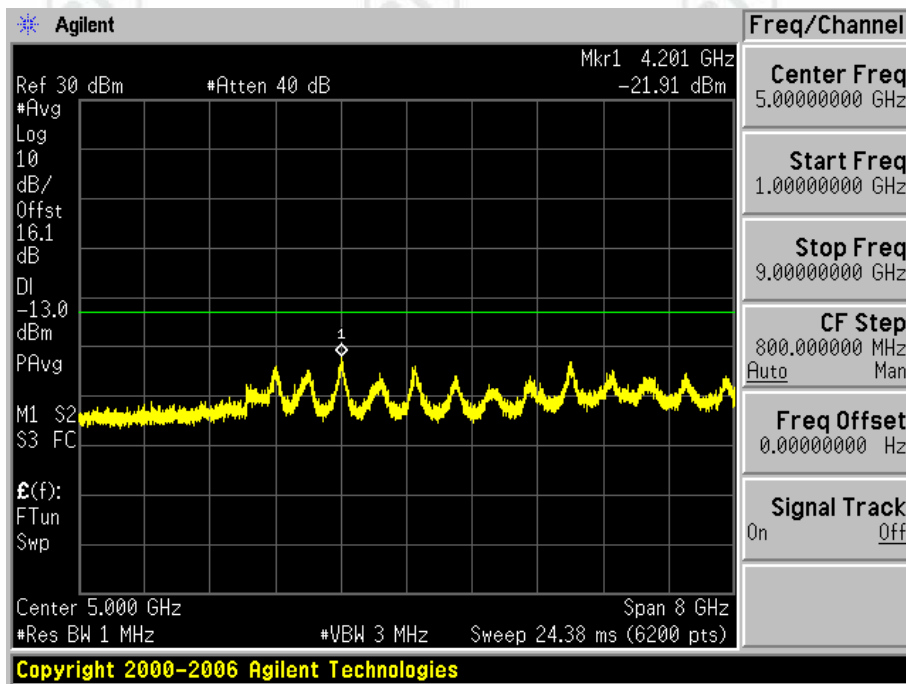
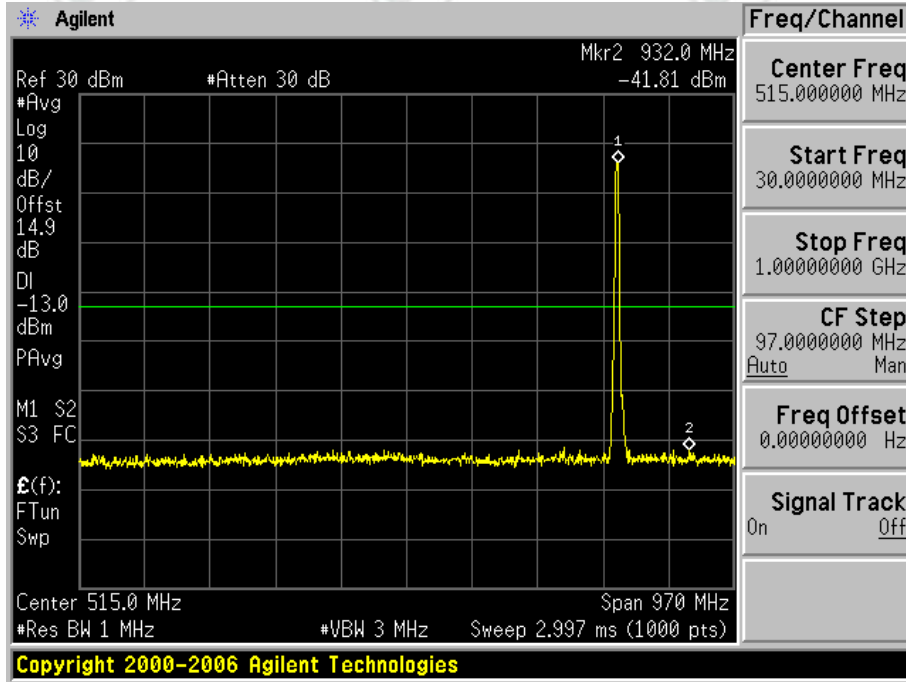

2.1.1.2 Test Channel=MCH

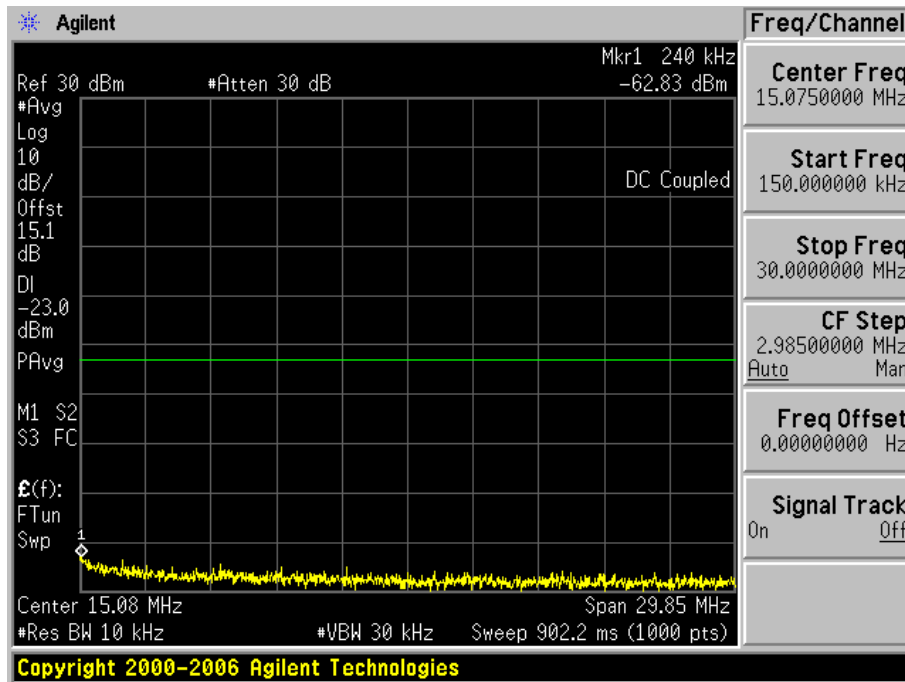
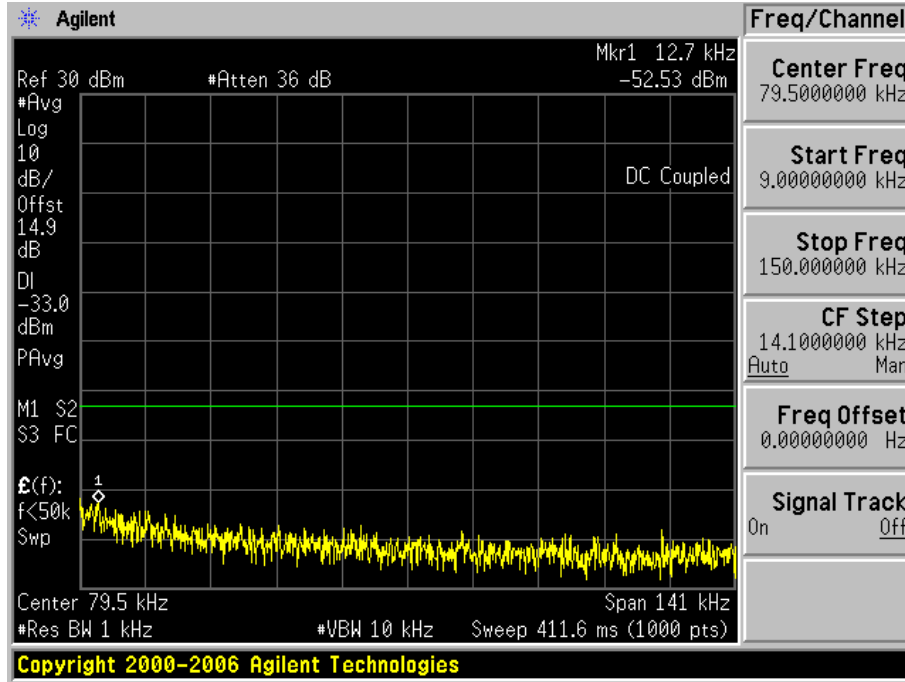

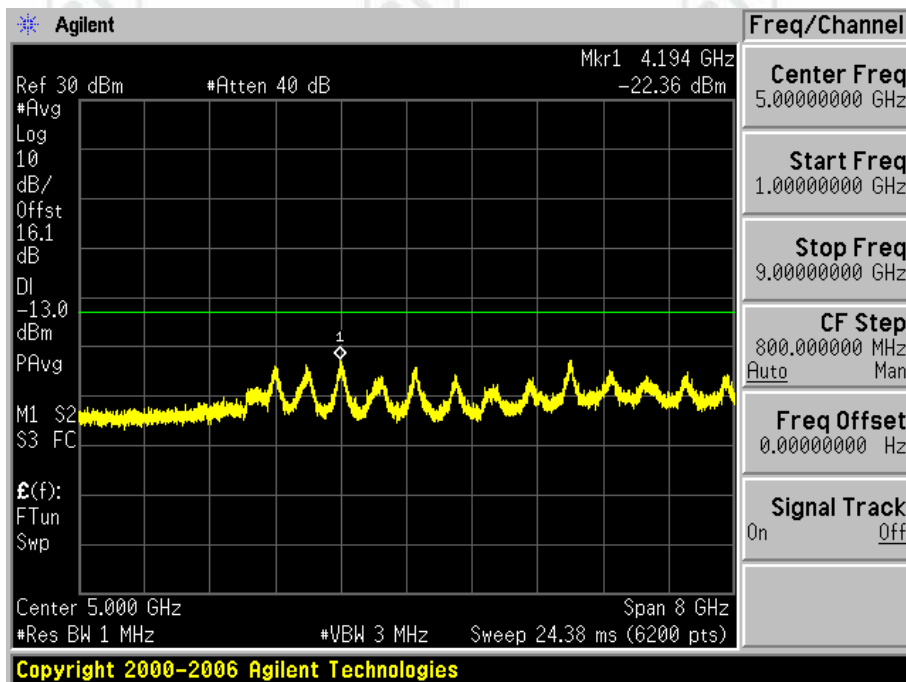
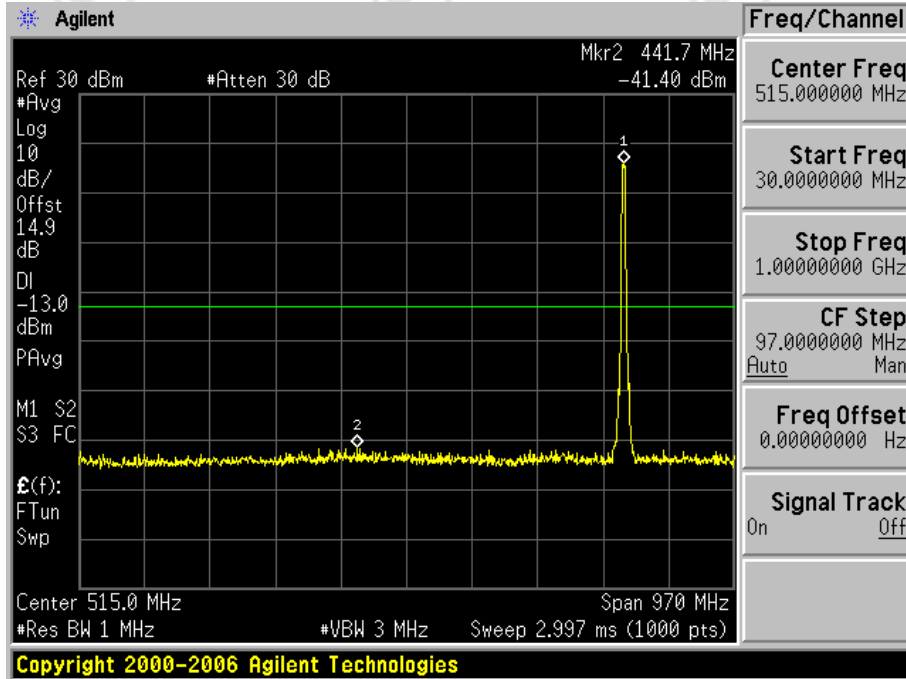

2.1.1.3 Test Channel=HCH

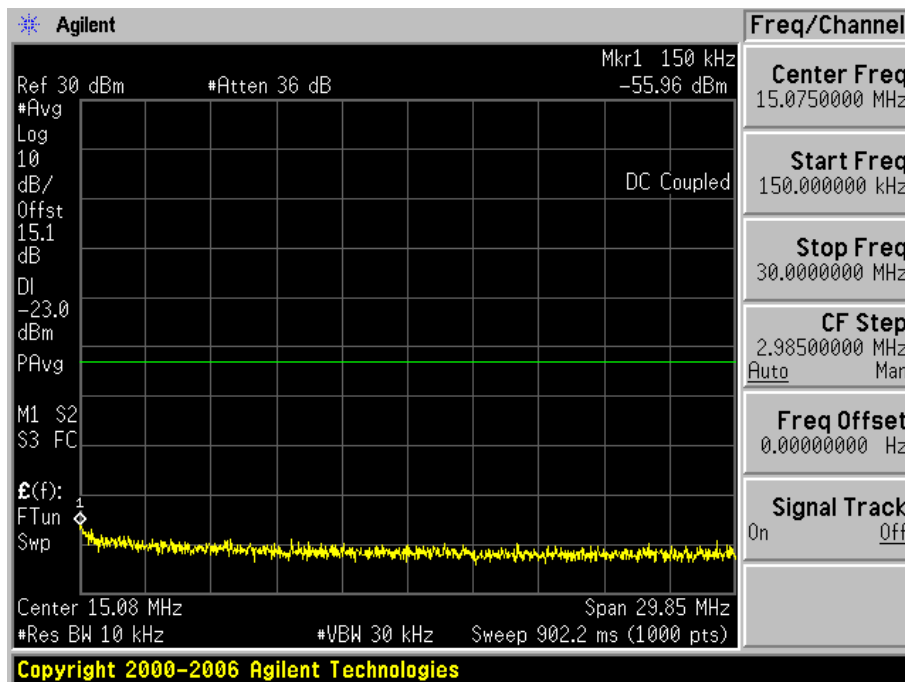
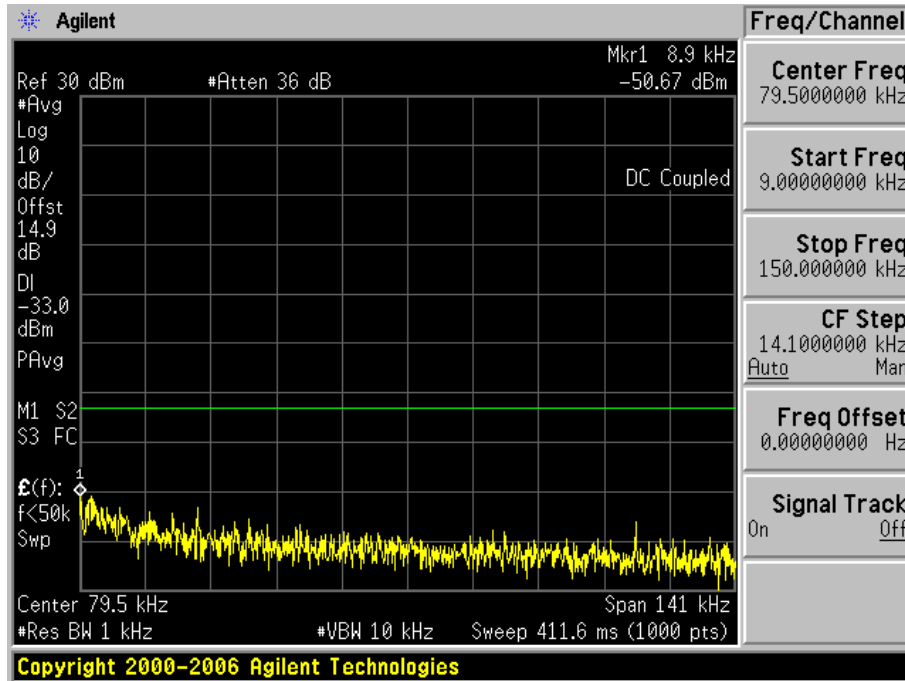

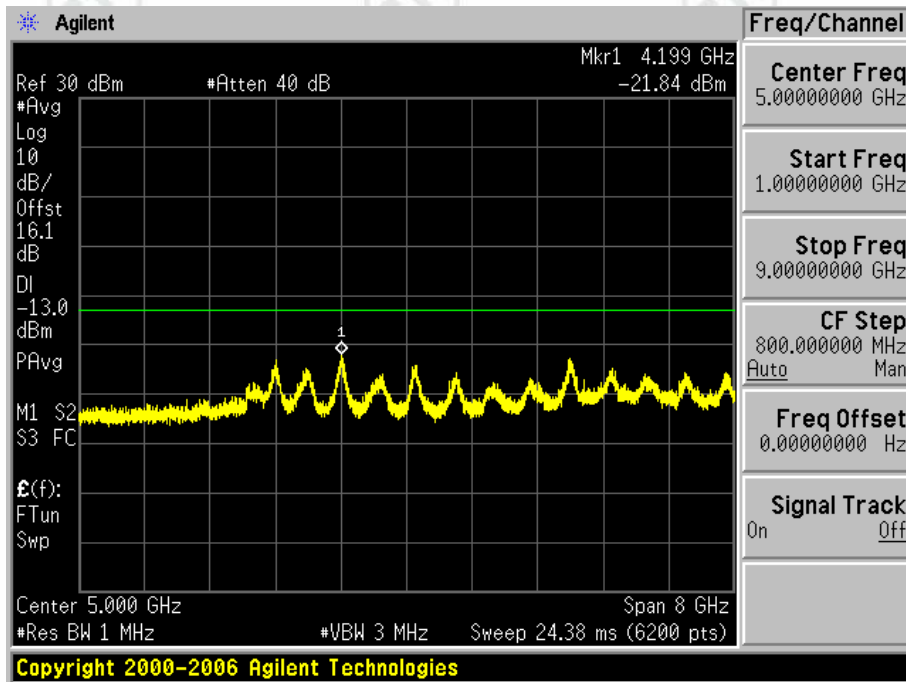
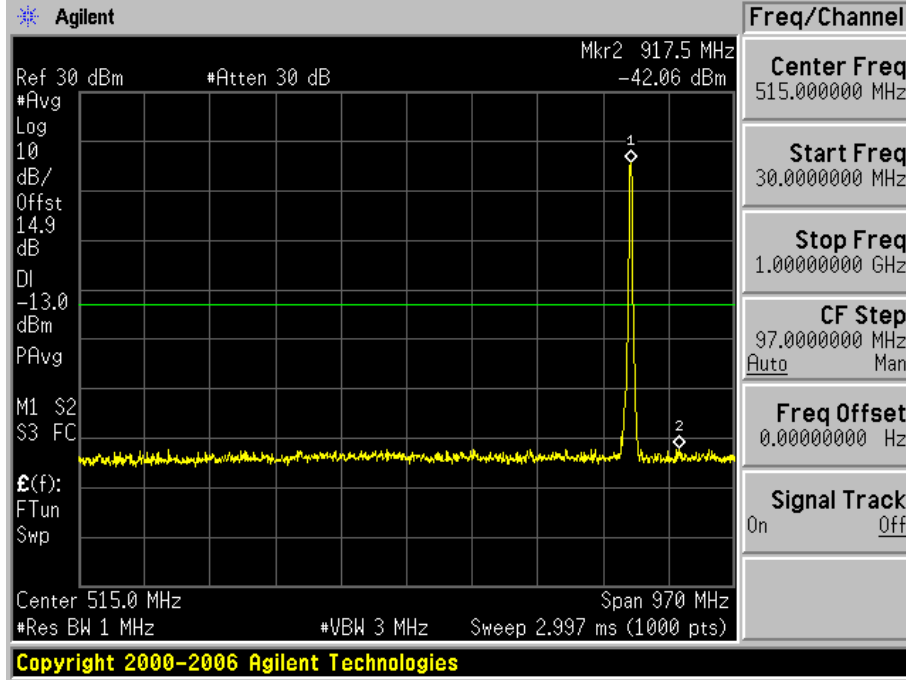

2.1.2 Test Mode=UMTS/TM2

2.1.2.1 Test Channel=LCH

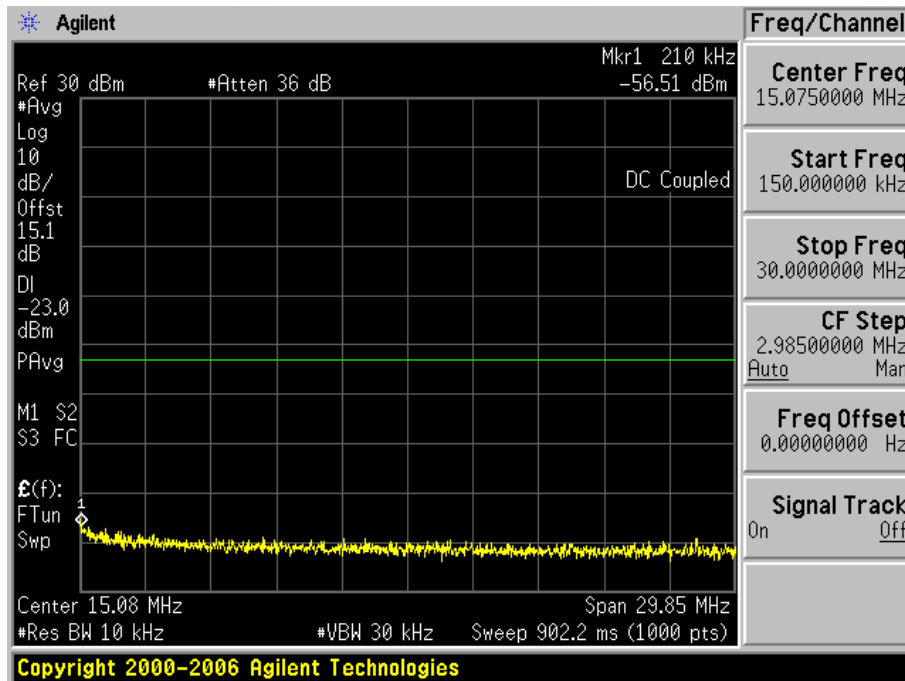
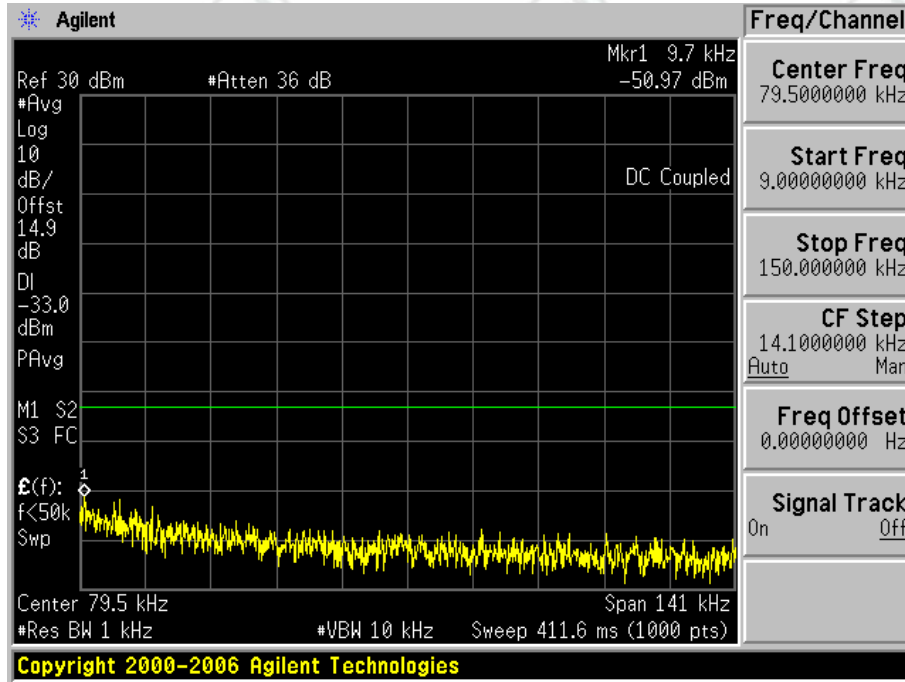

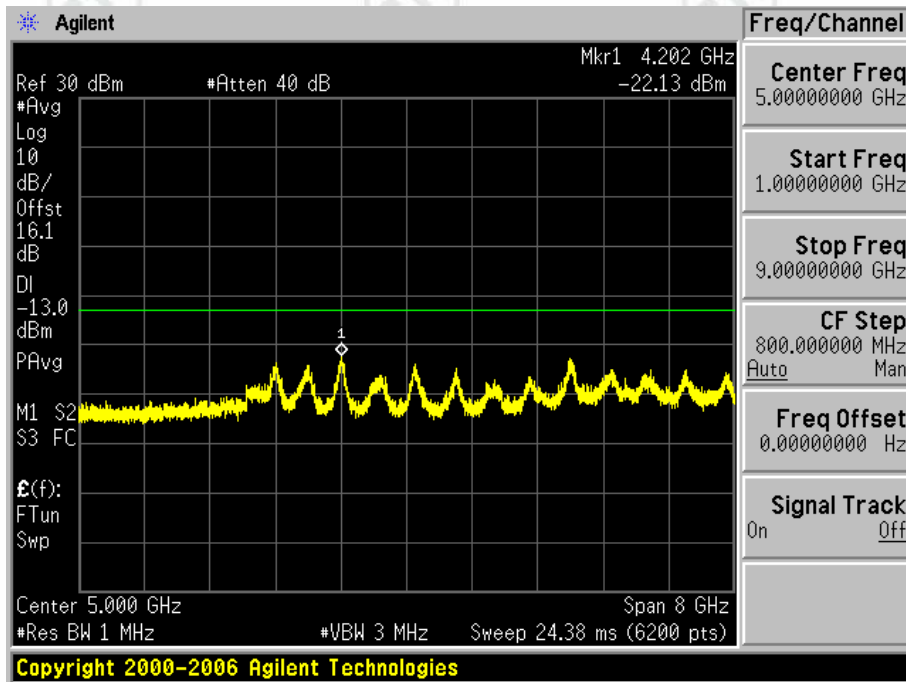
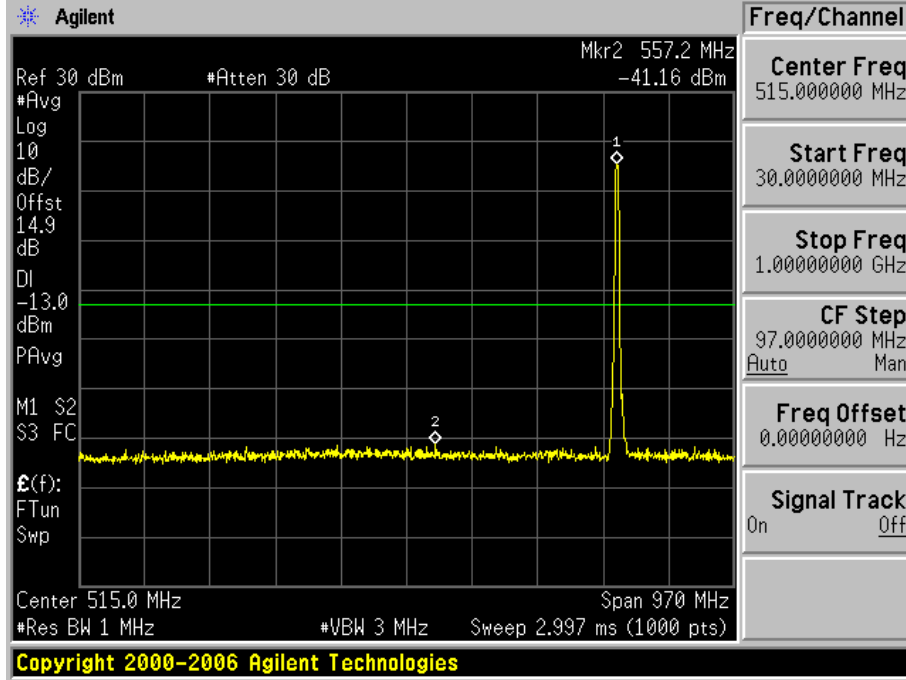

2.1.2.2 Test Channel=MCH

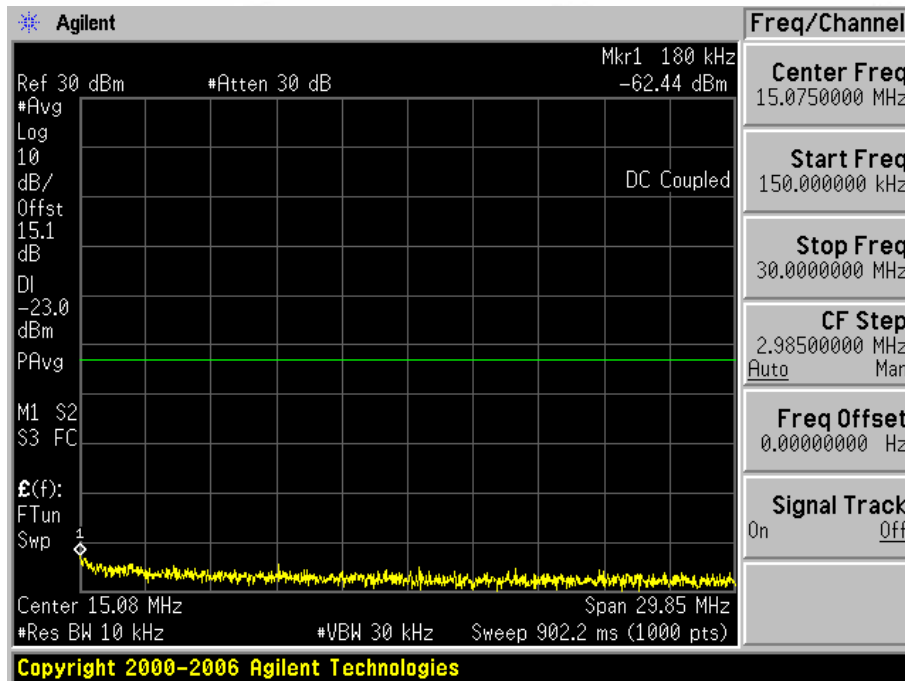
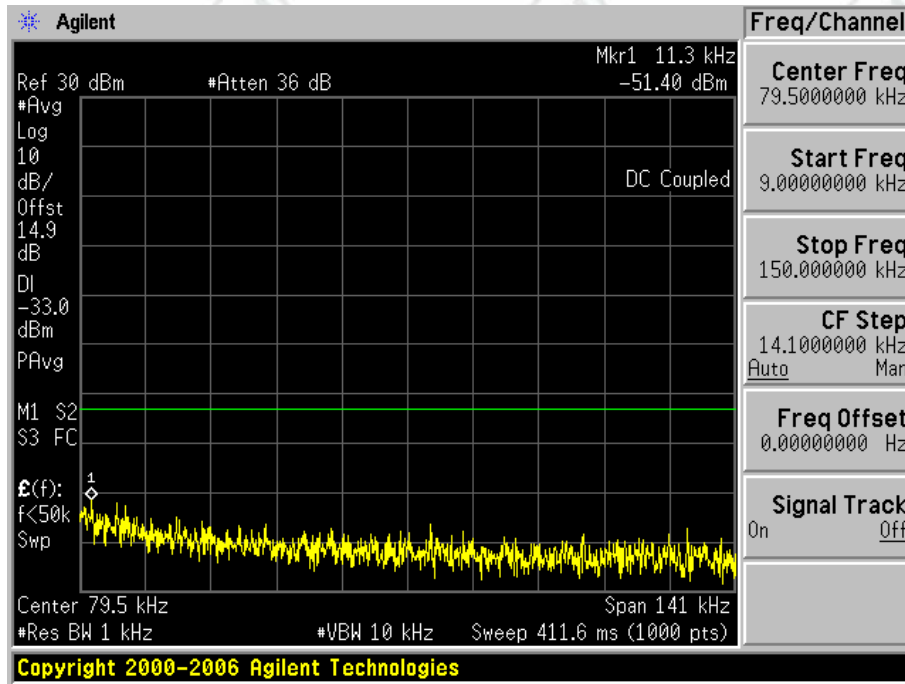

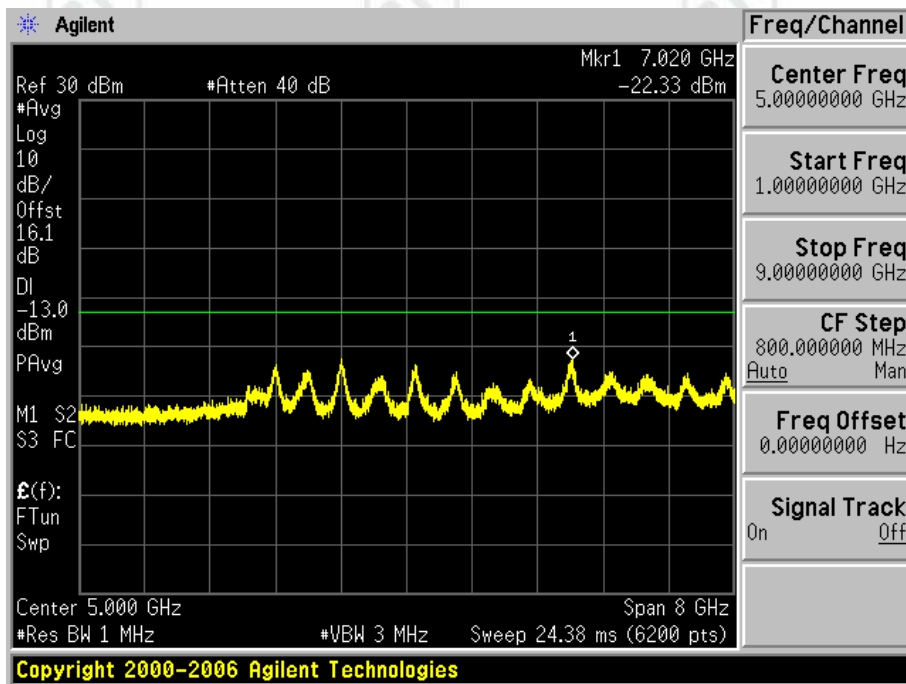
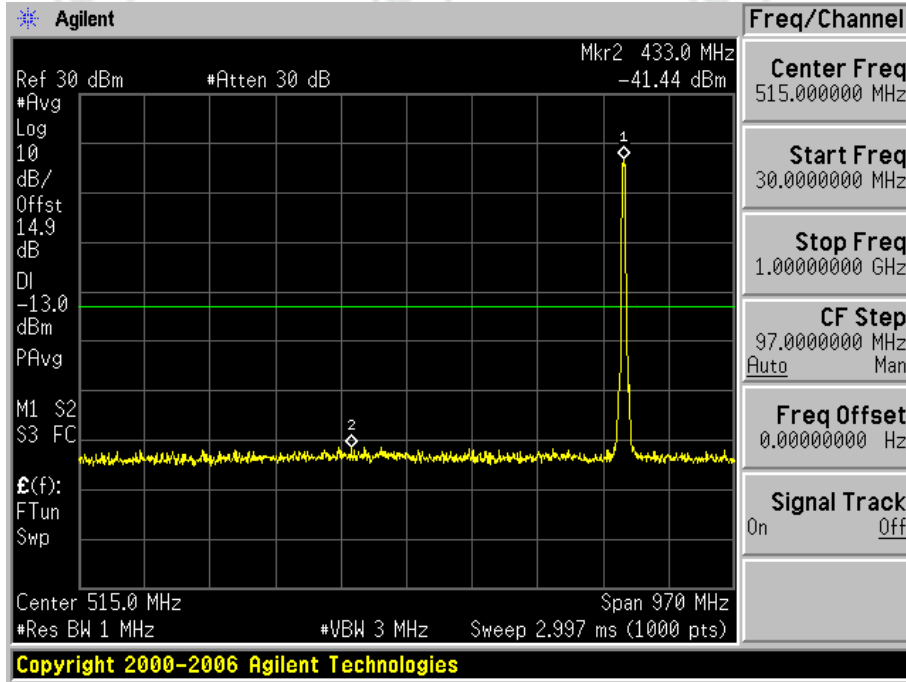

2.1.2.3 Test Channel=HCH

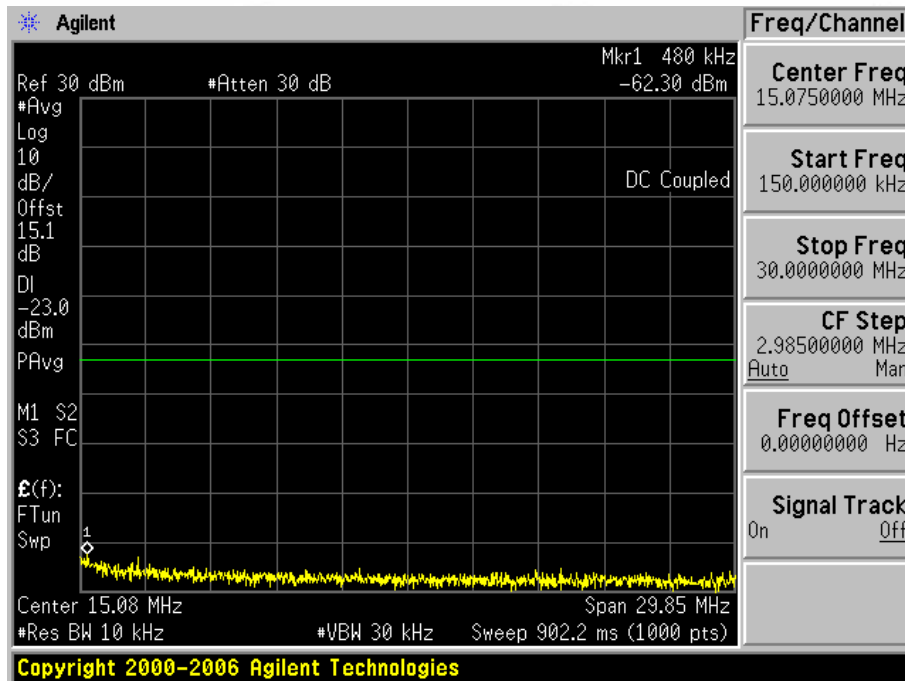
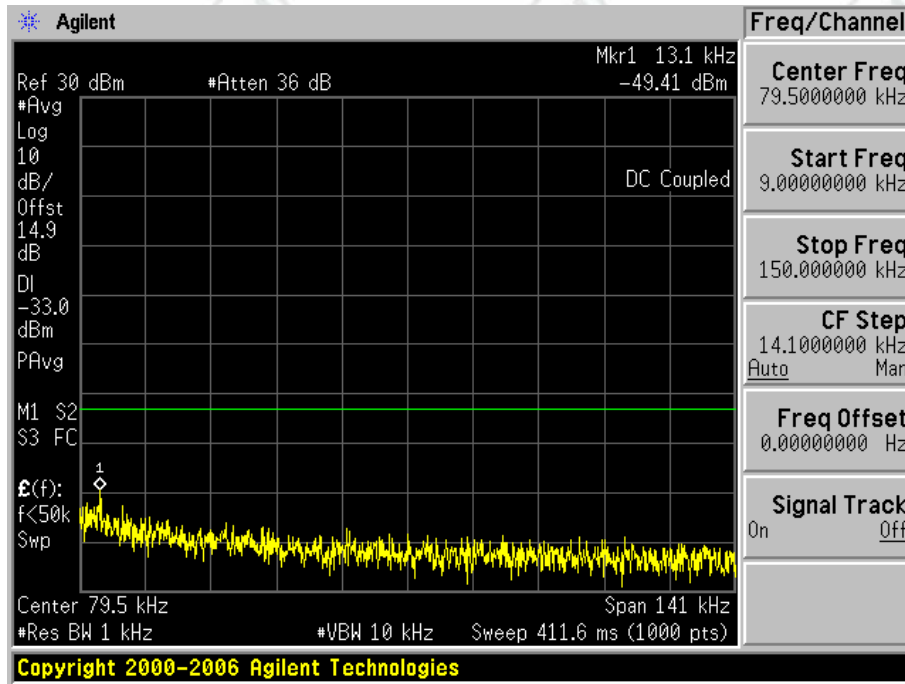

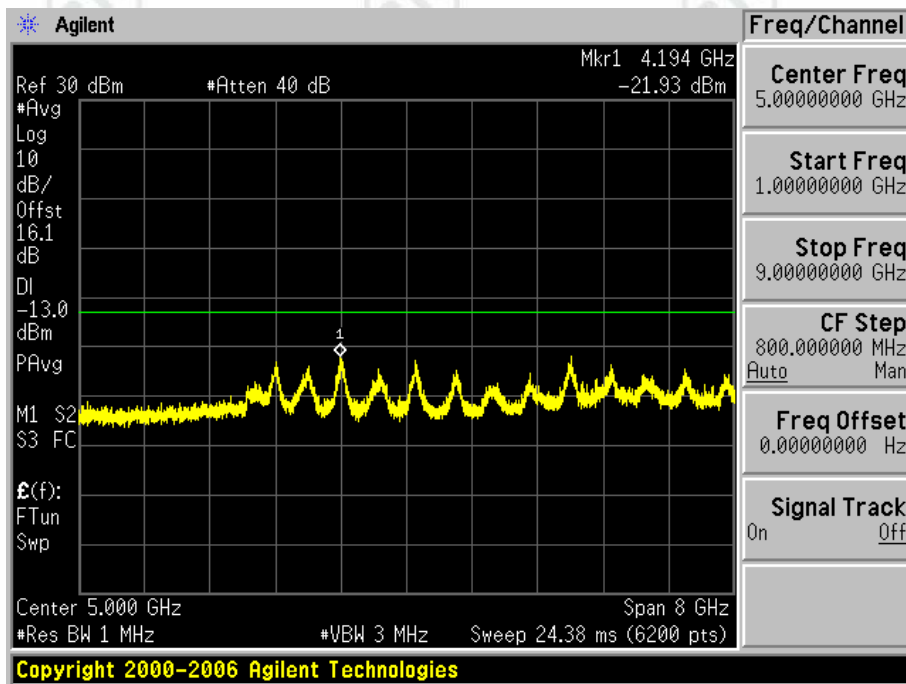
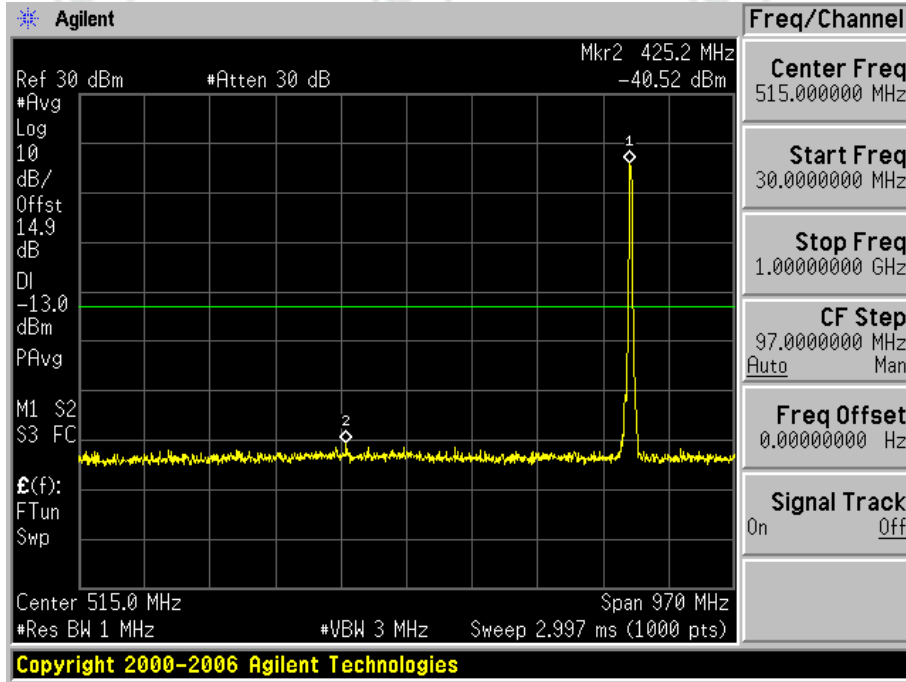

2.1.3

Test Mode=UMTS/TM3

2.1.3.1

Test Channel=LCH

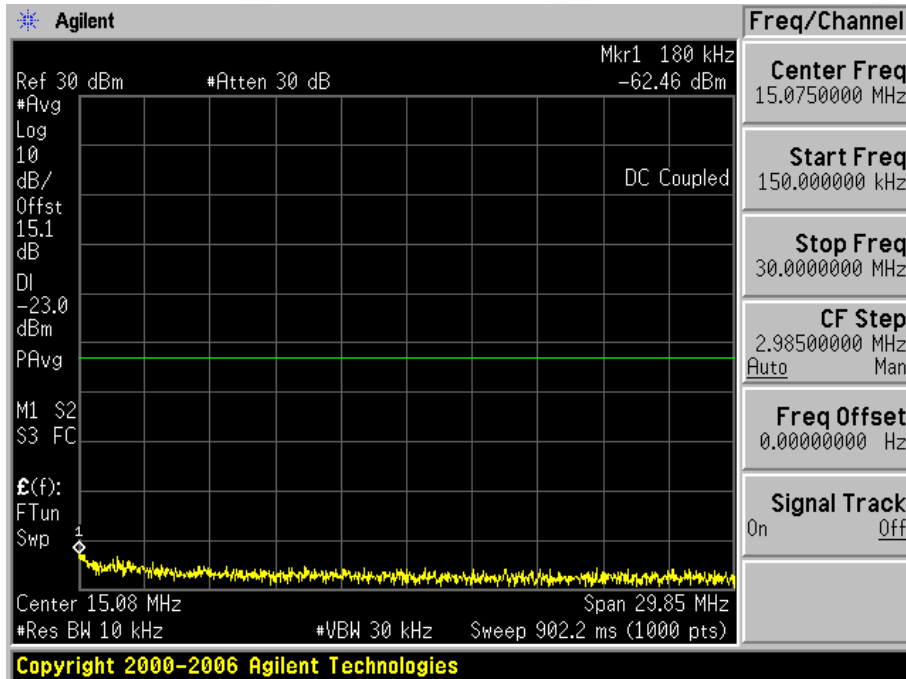
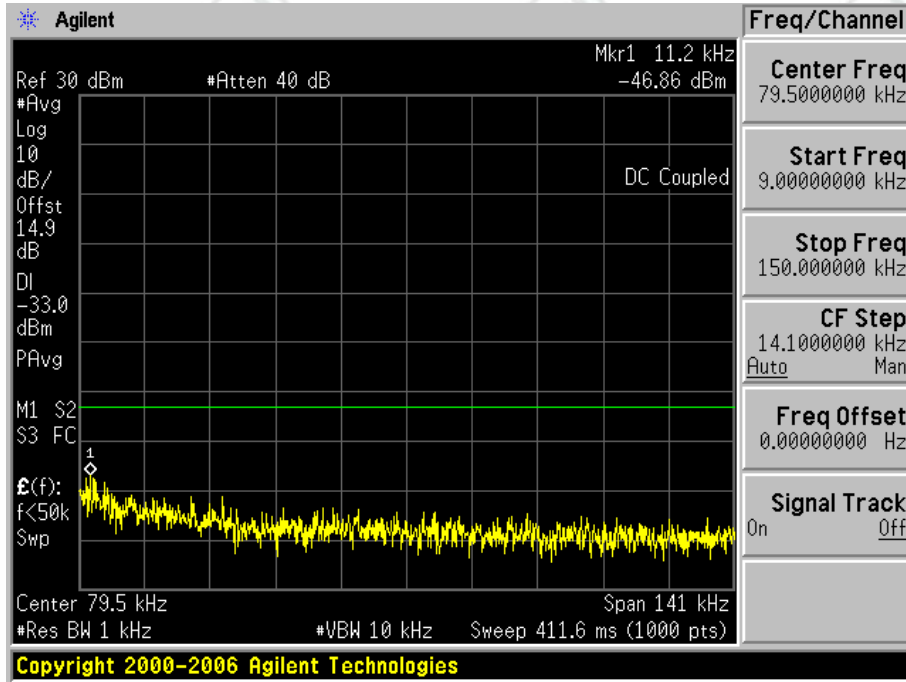

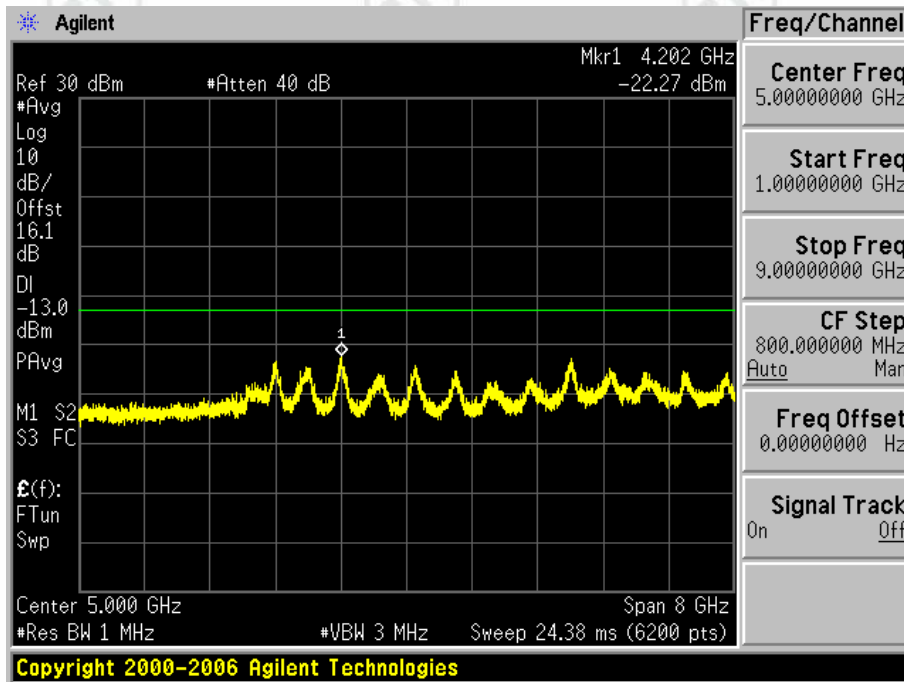
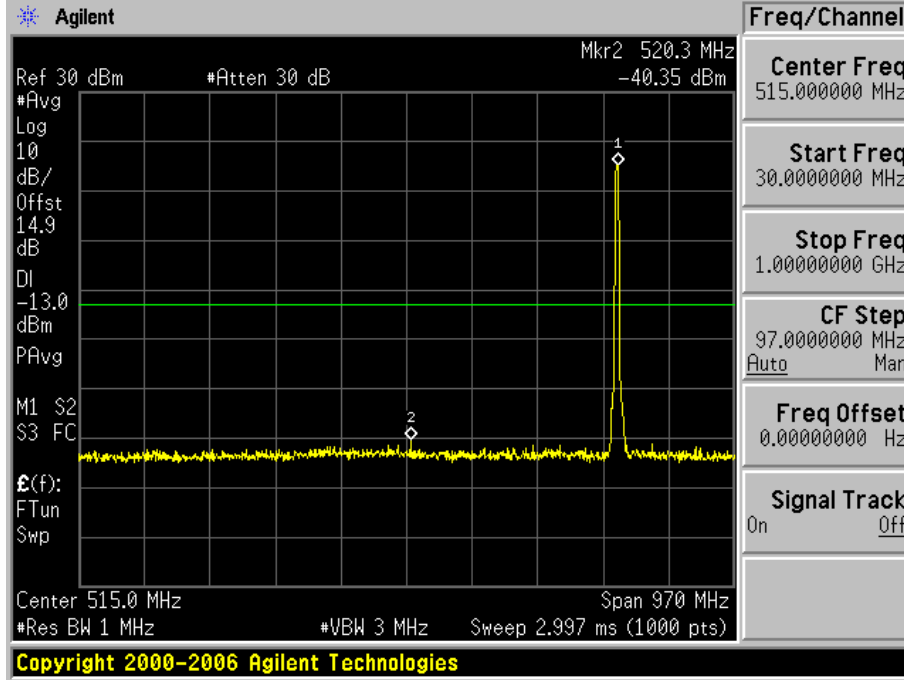

2.1.3.2 Test Channel=MCH

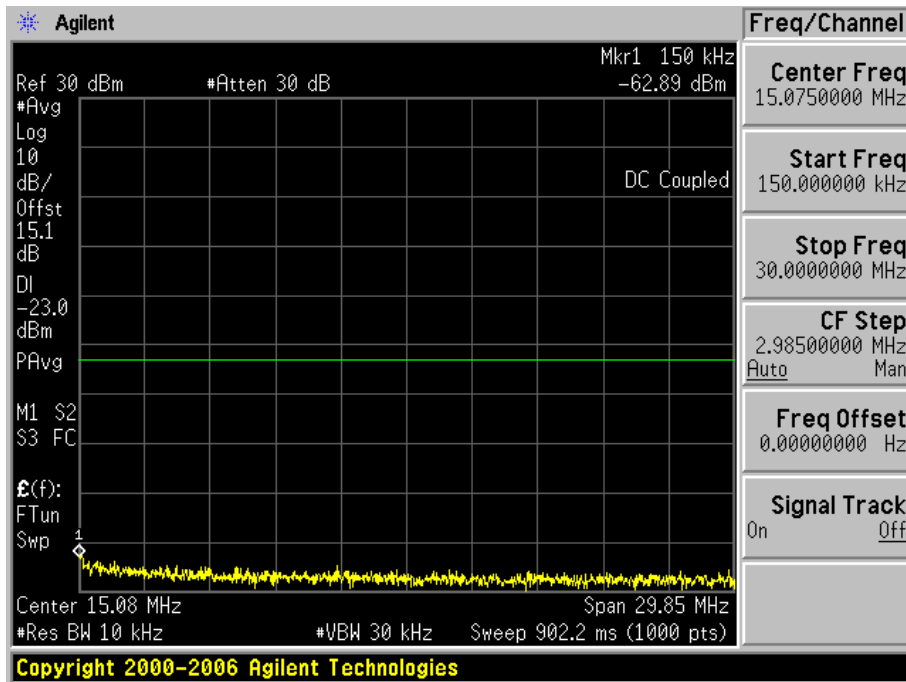
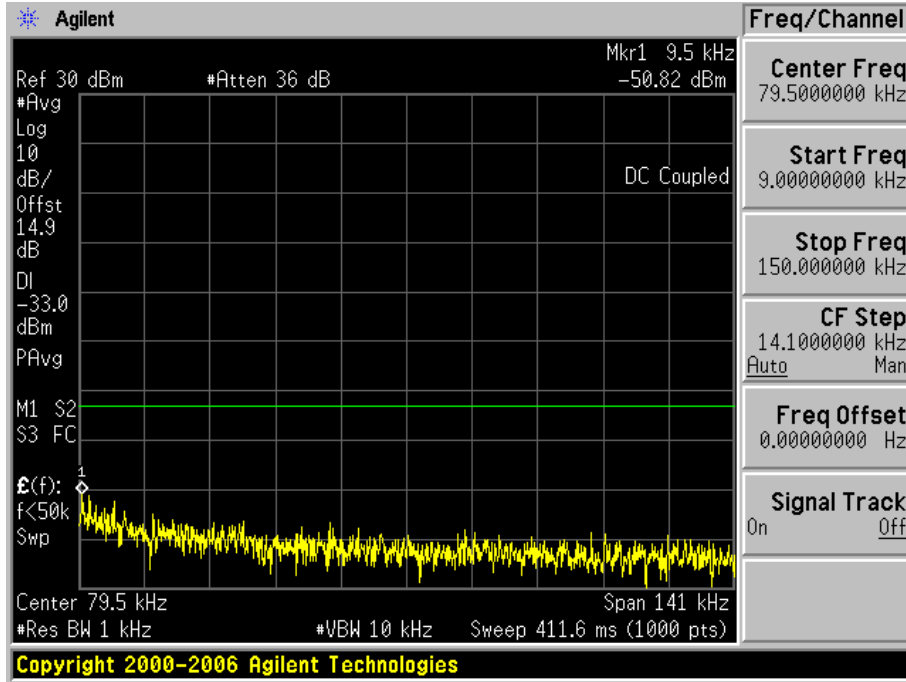

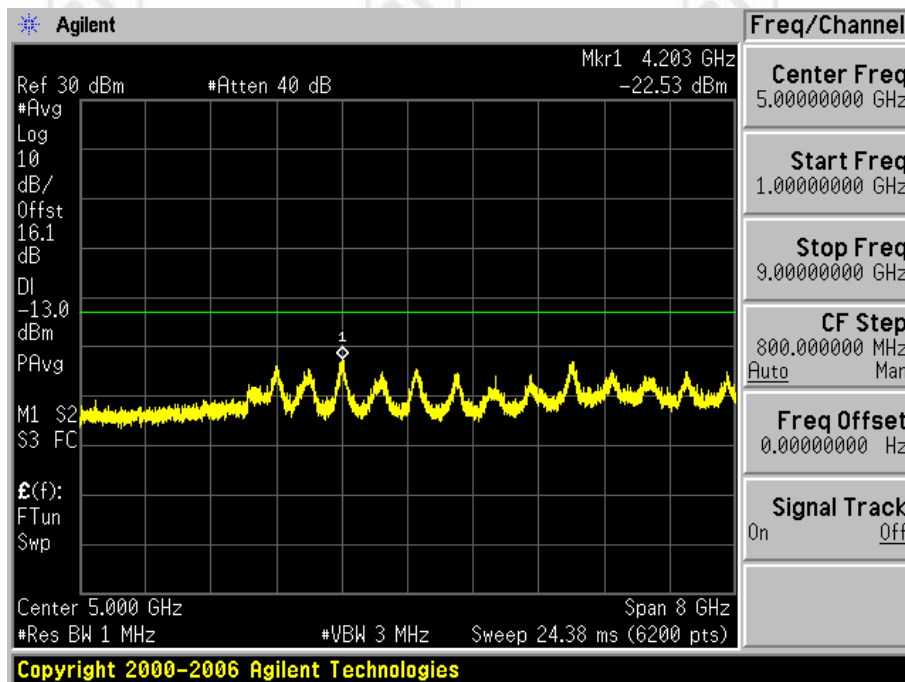
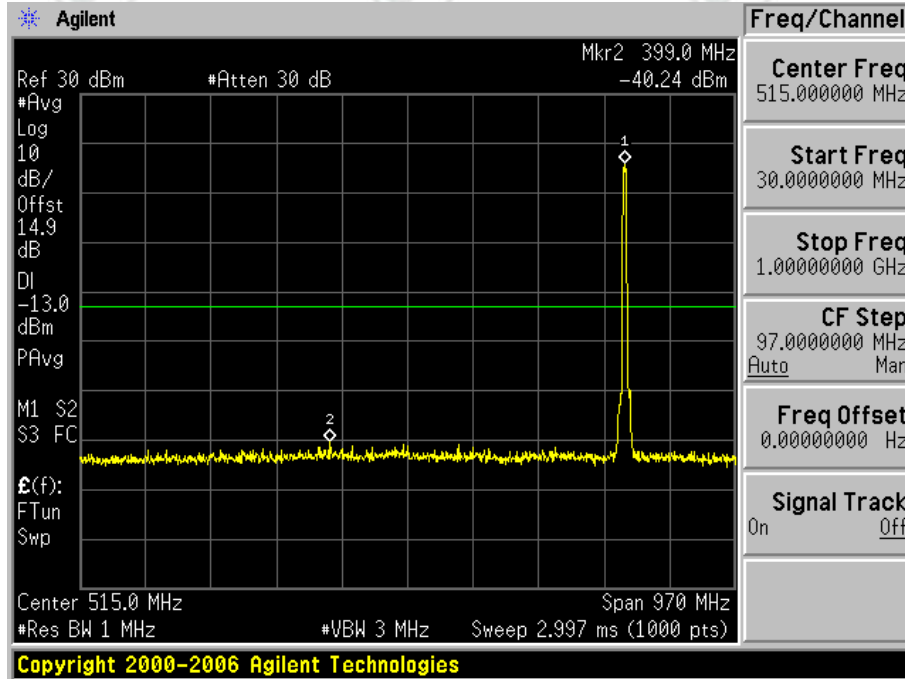

2.1.3.3 Test Channel=HCH

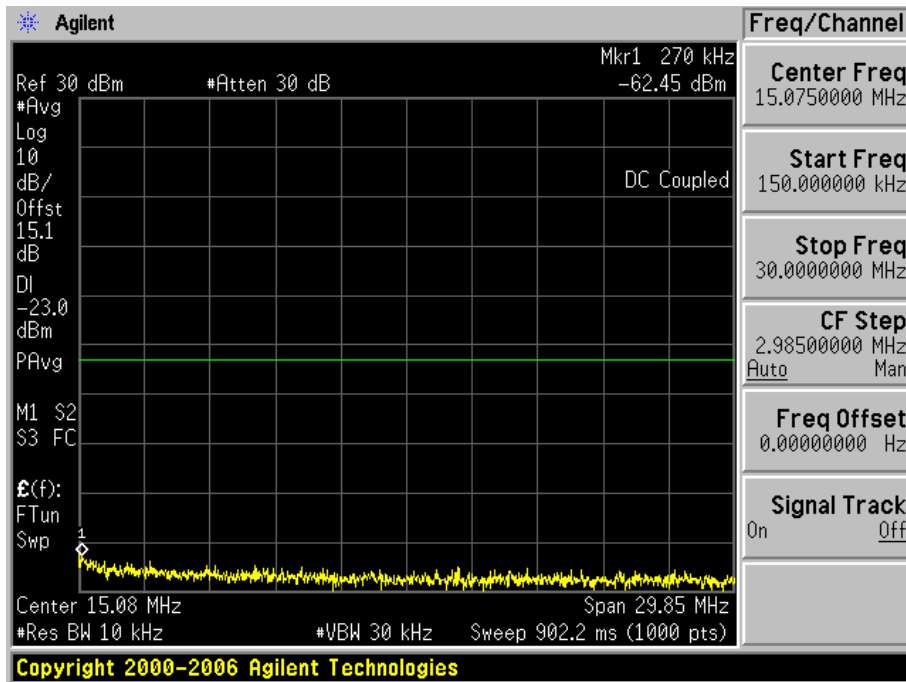
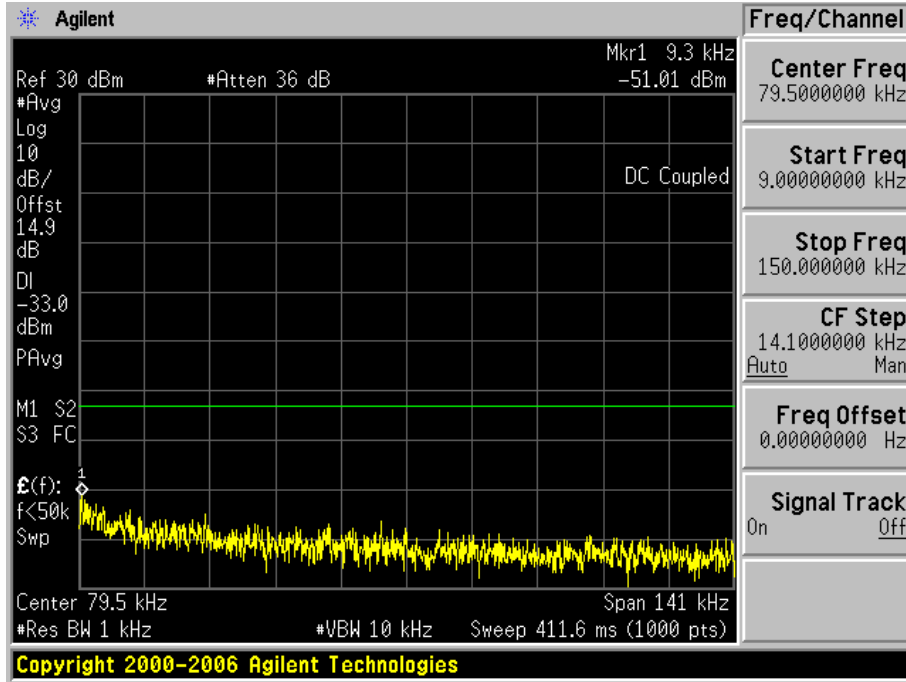

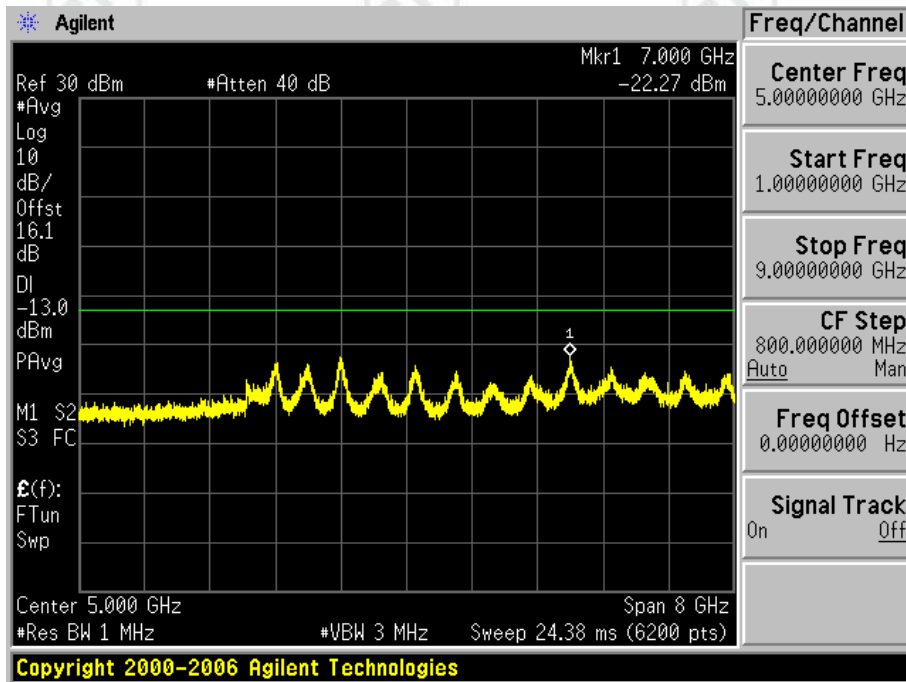
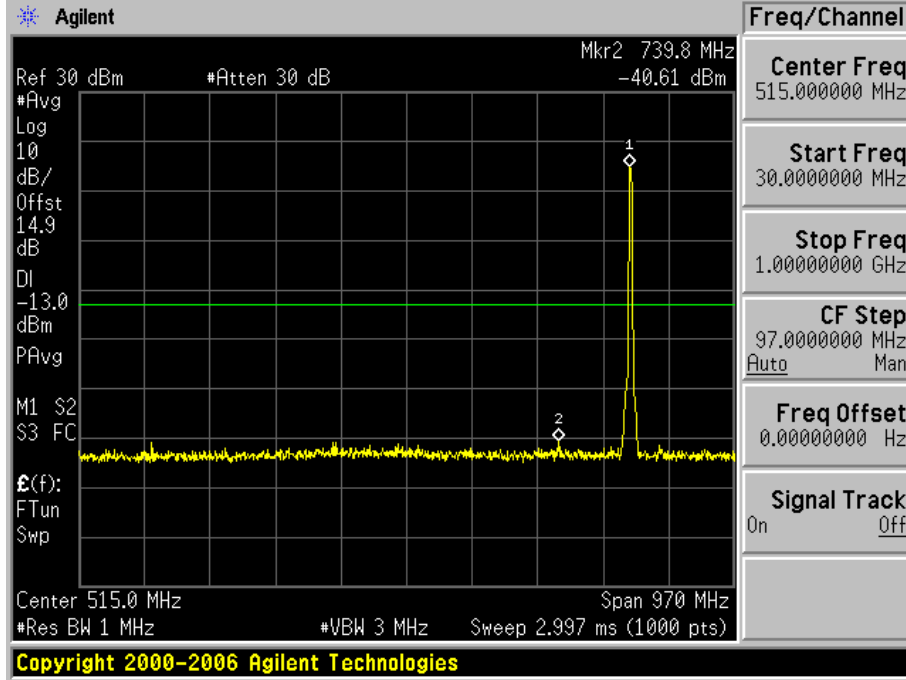

2.2 Test Band=WCDMA1900

2.2.1 Test Mode=UMTS/TM1

2.2.1.1 Test Channel=LCH

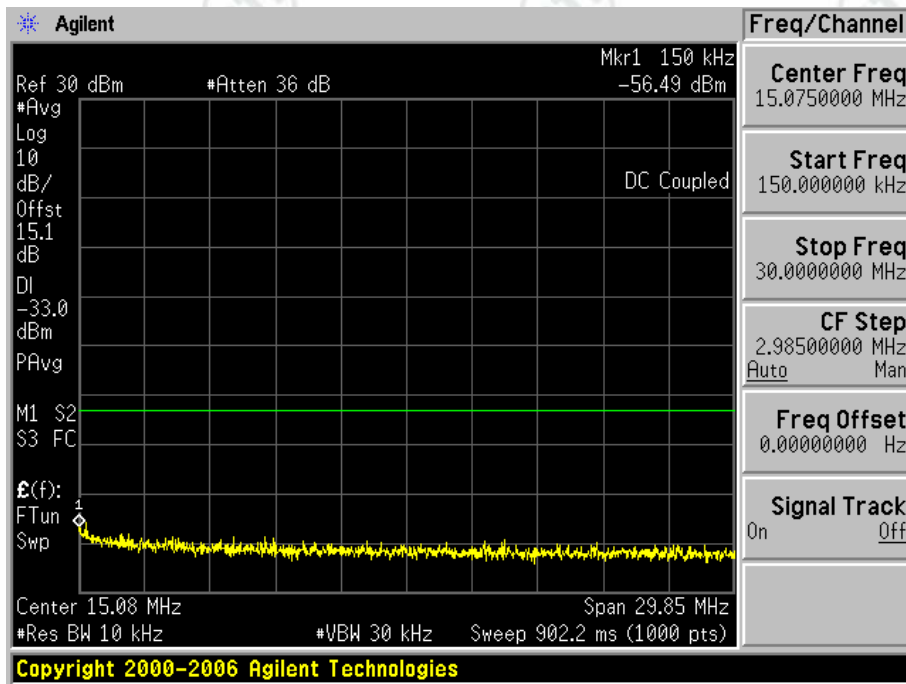
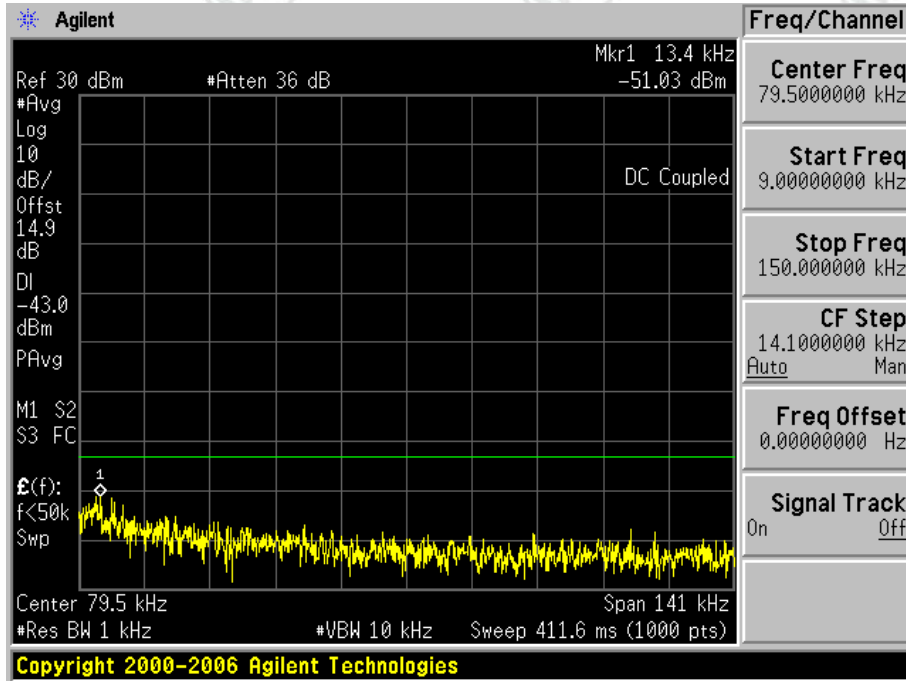

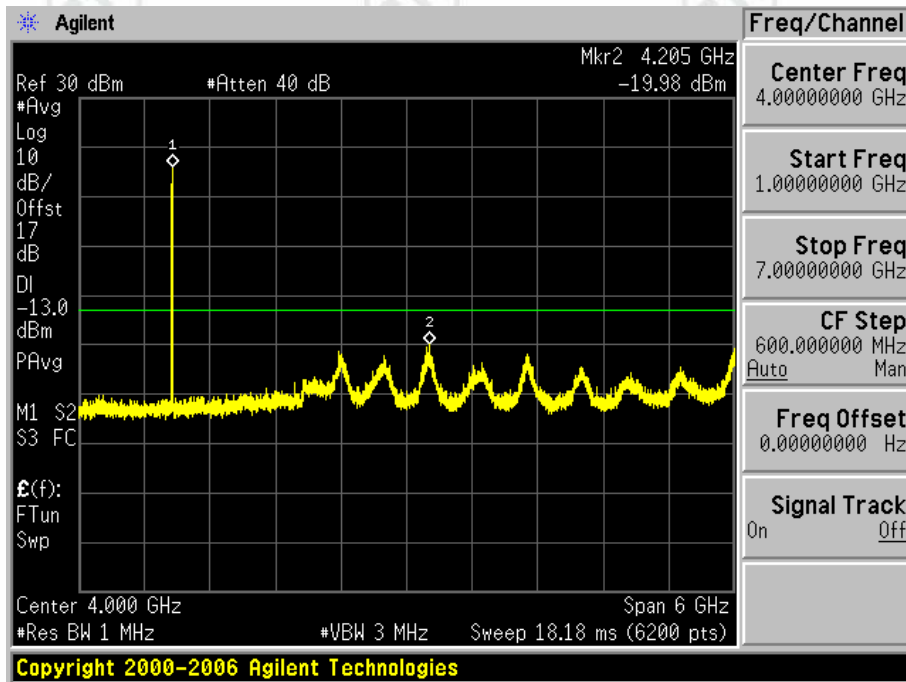
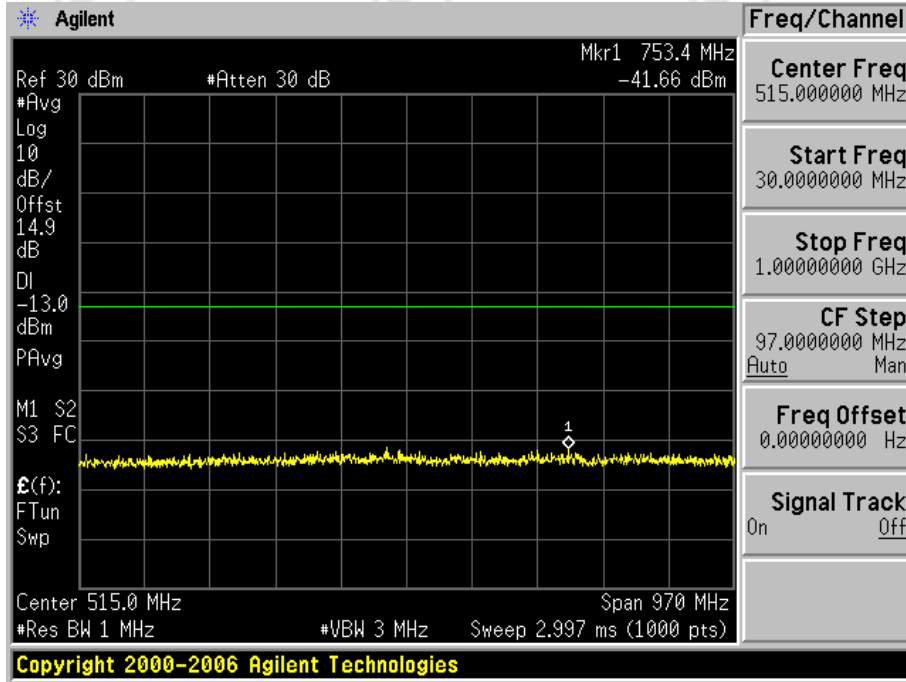

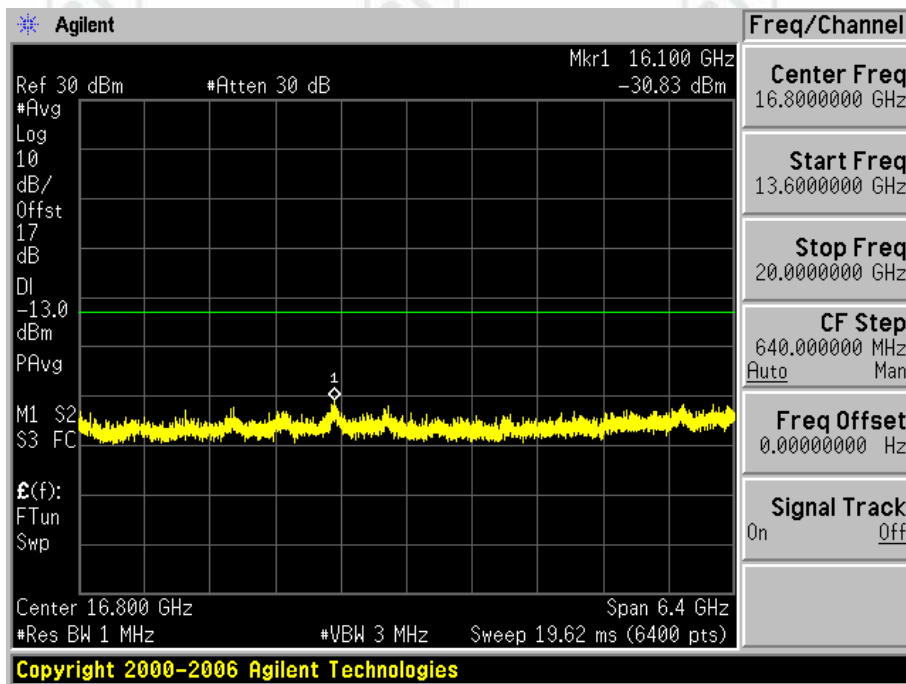
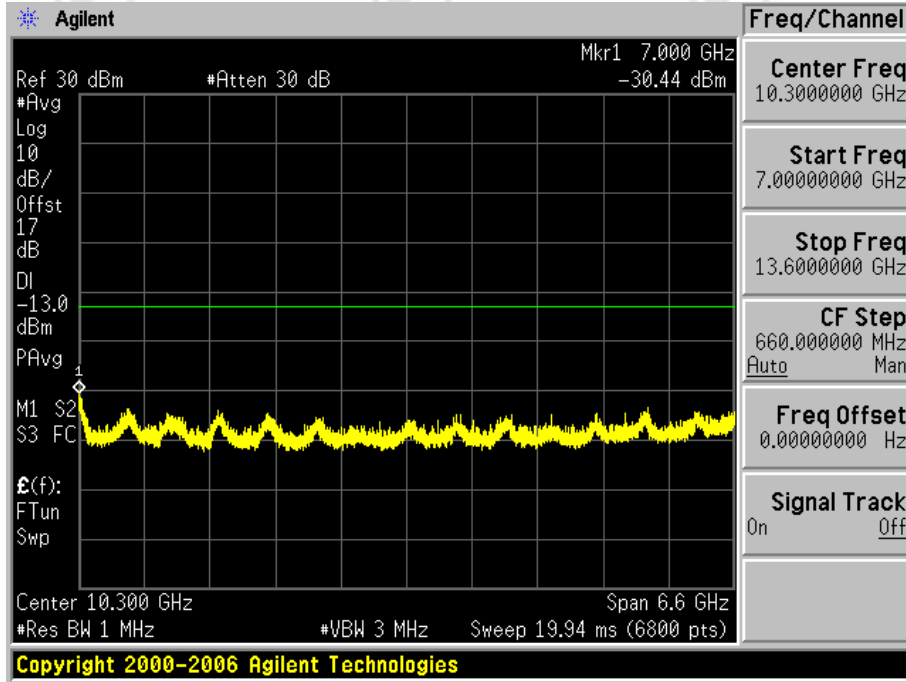

2.2.1.2 Test Channel=MCH

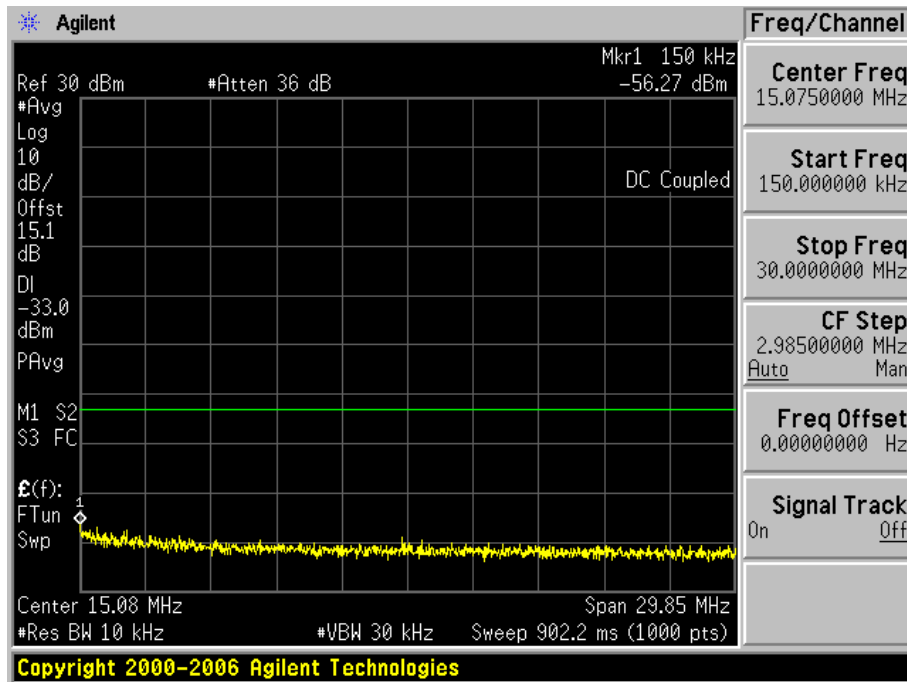
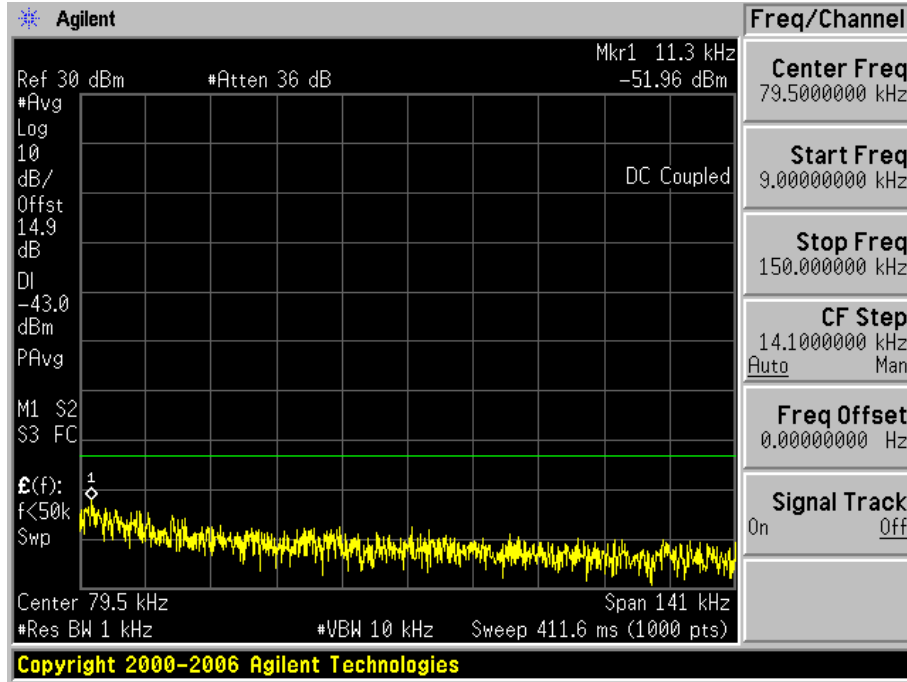

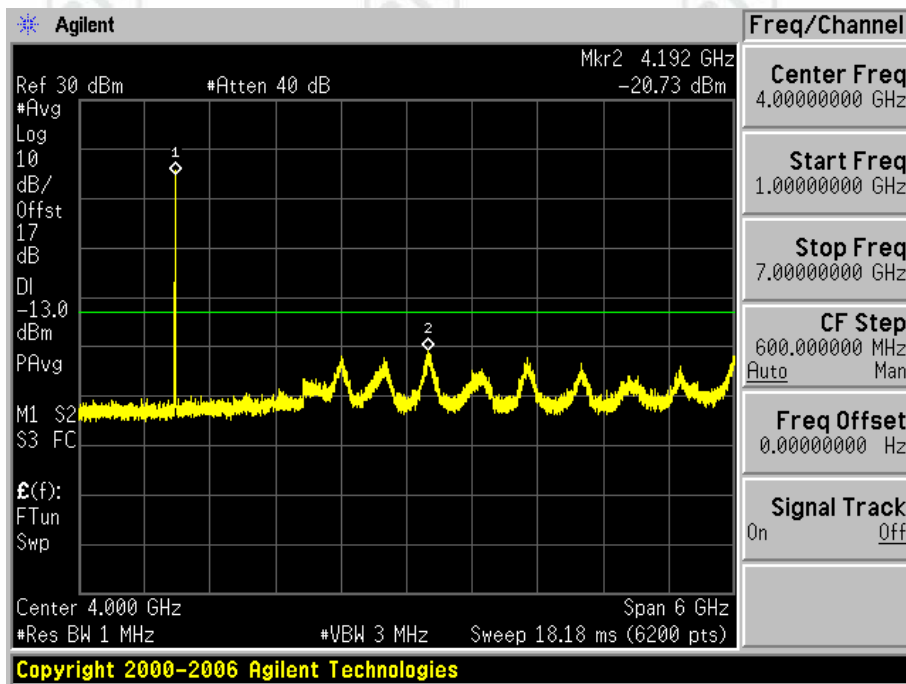
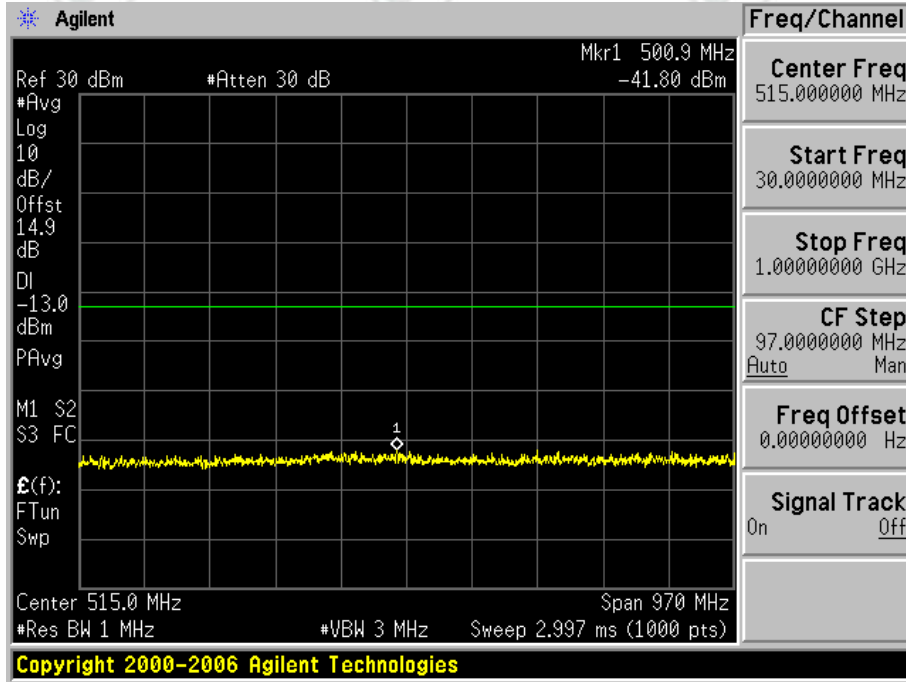

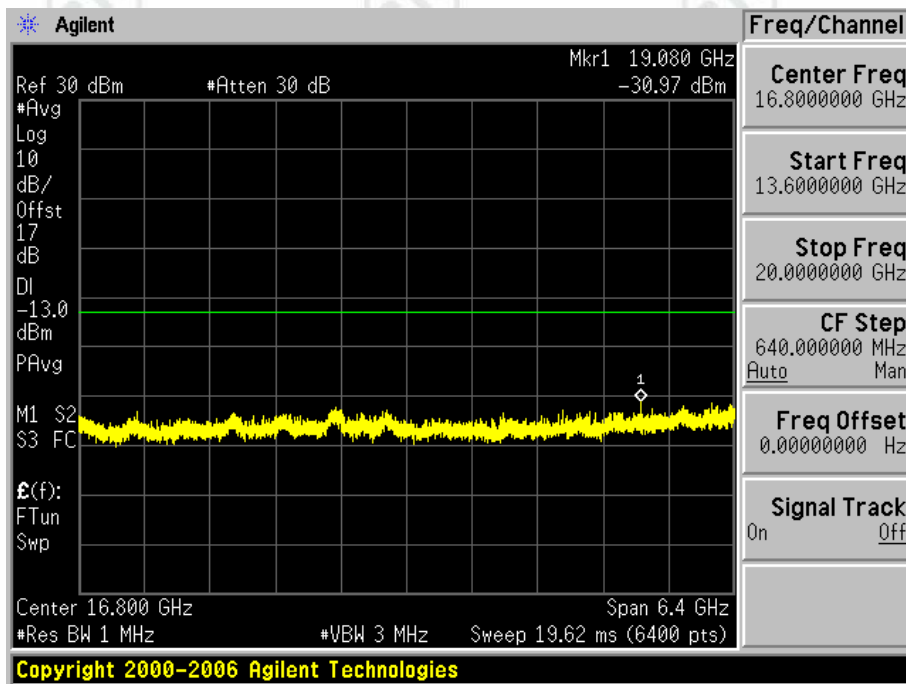
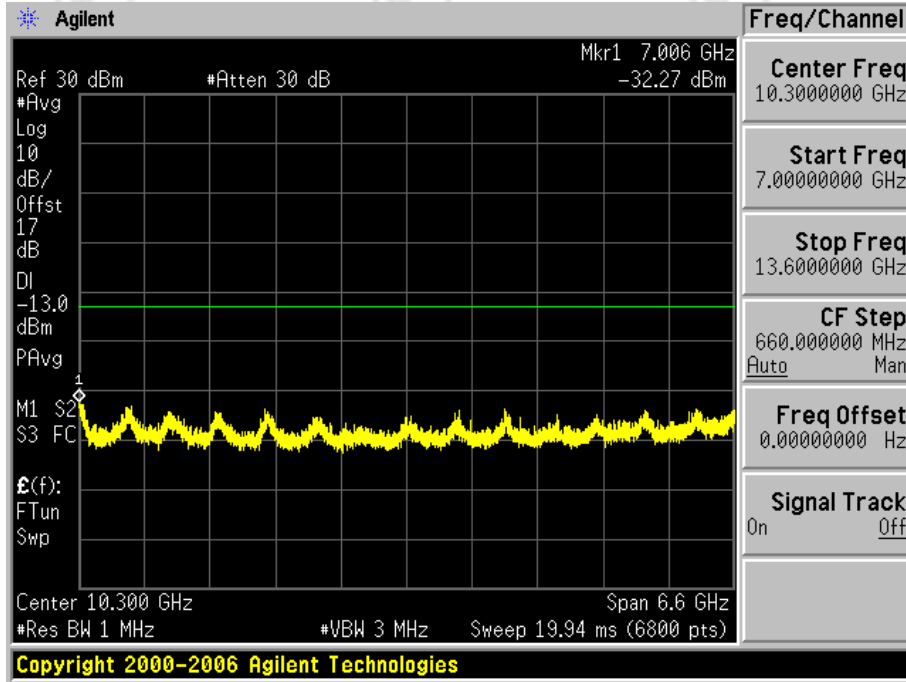

2.2.1.3 Test Channel=HCH

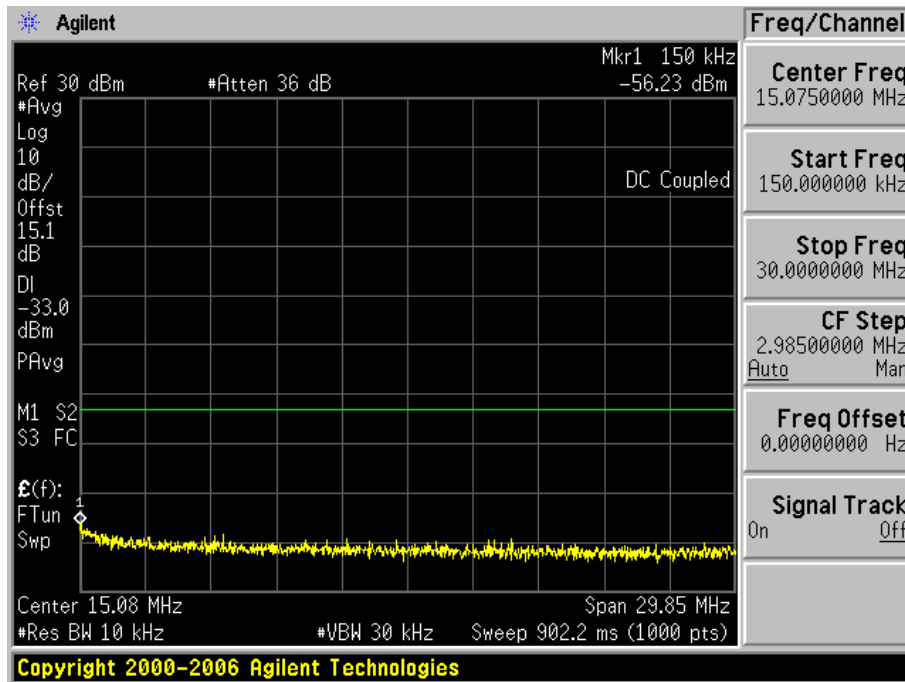
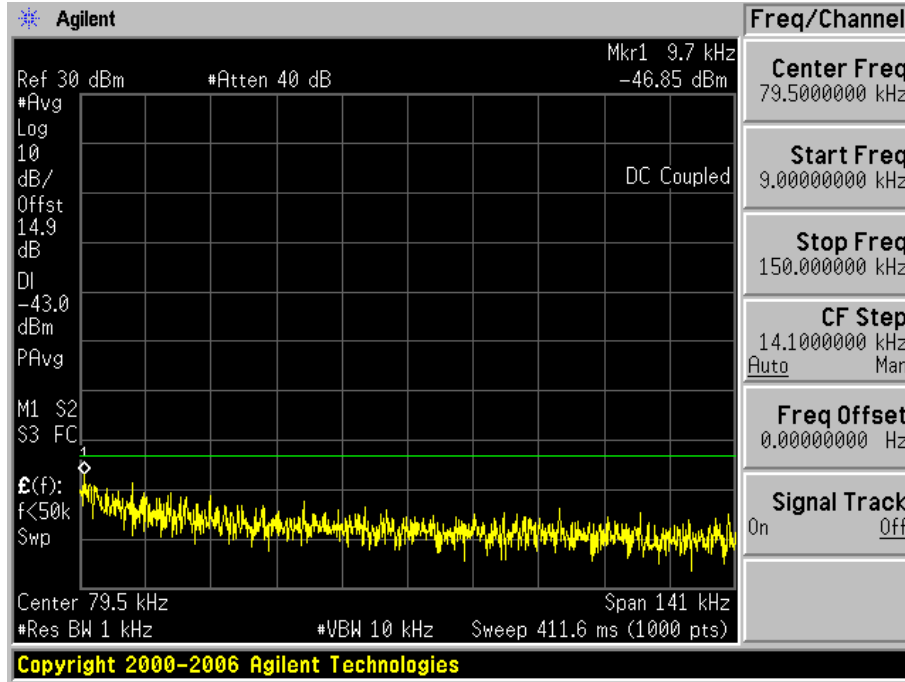

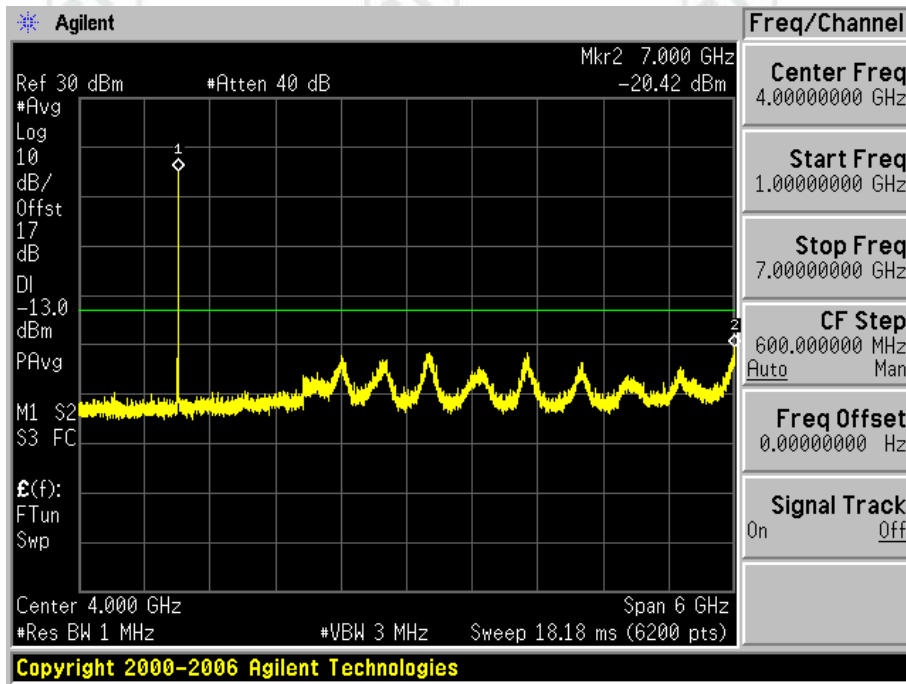
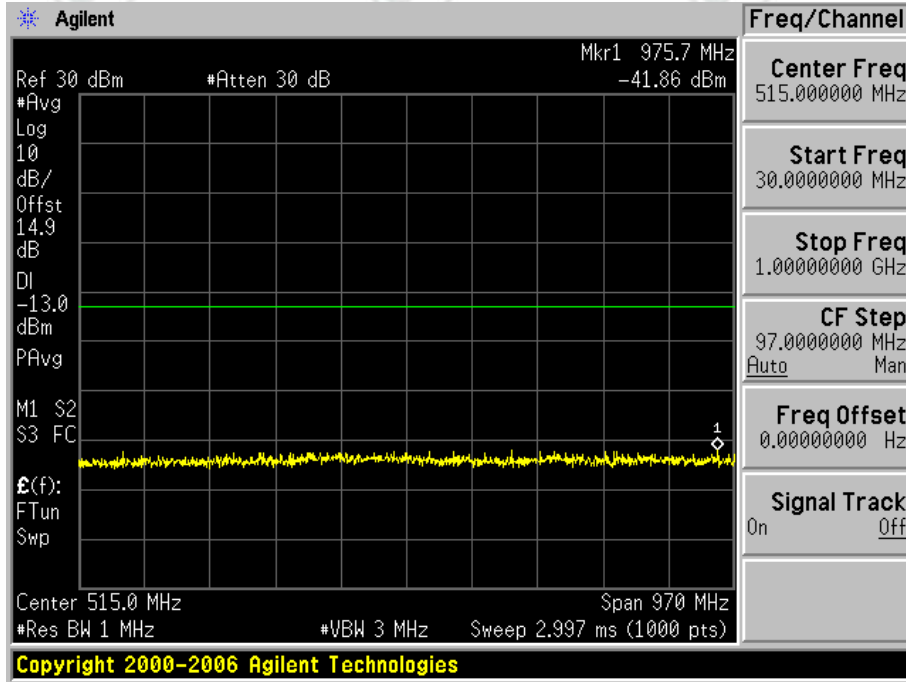

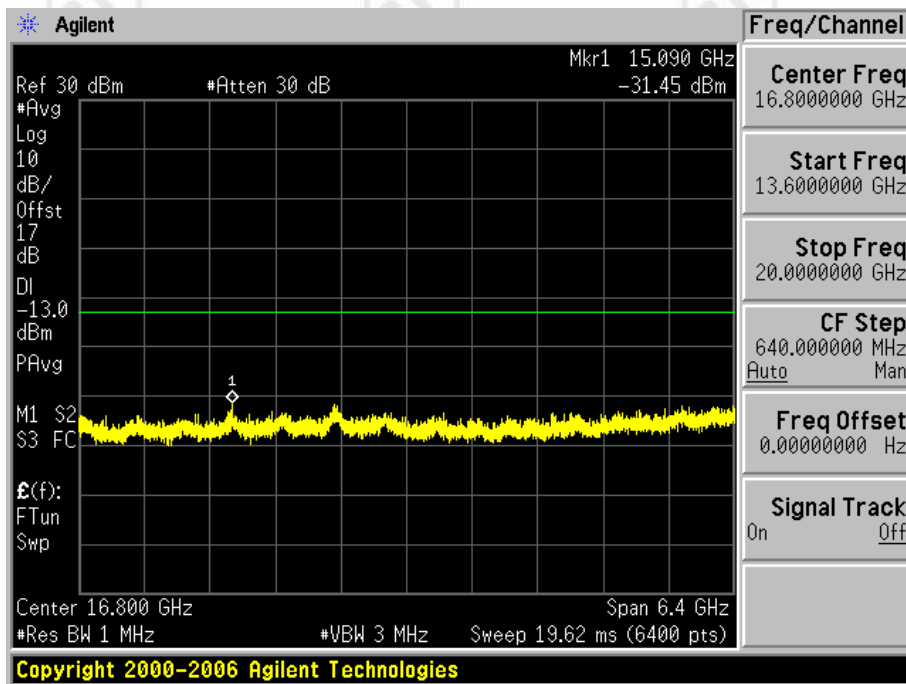
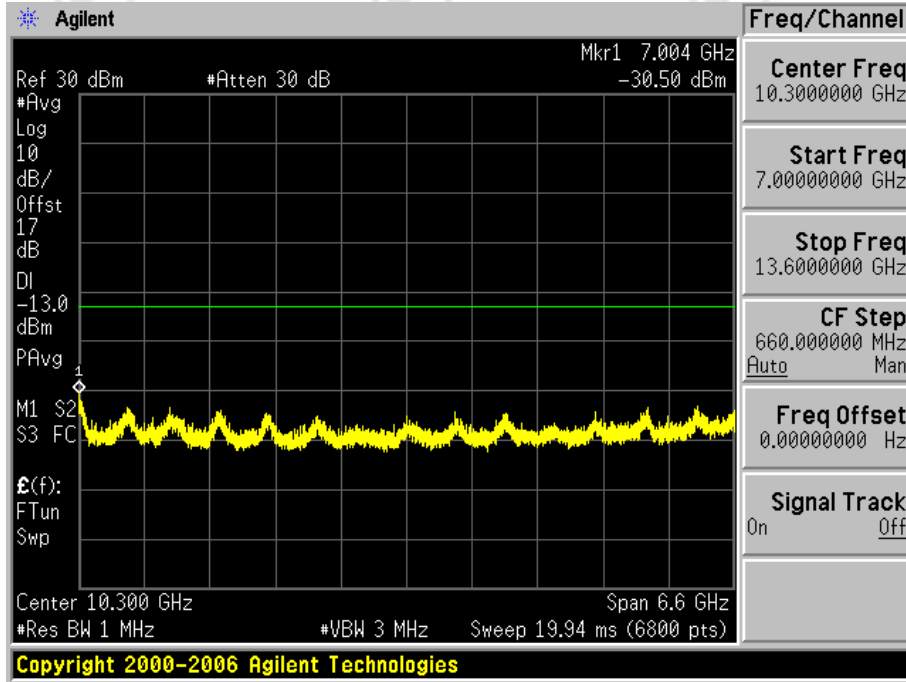

2.2.2 Test Mode=UMTS/TM2

2.2.2.1 Test Channel=LCH

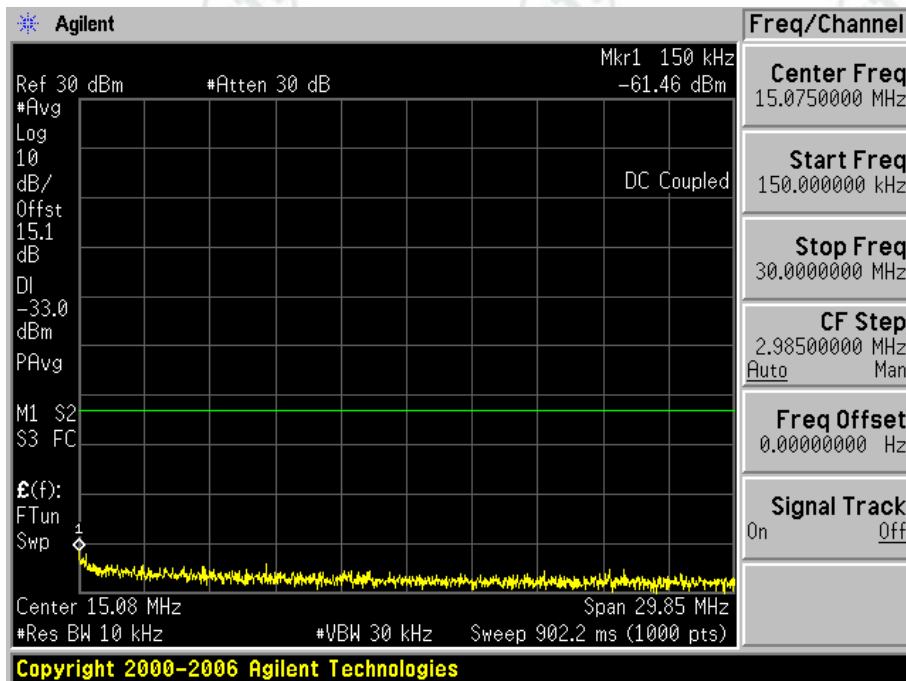
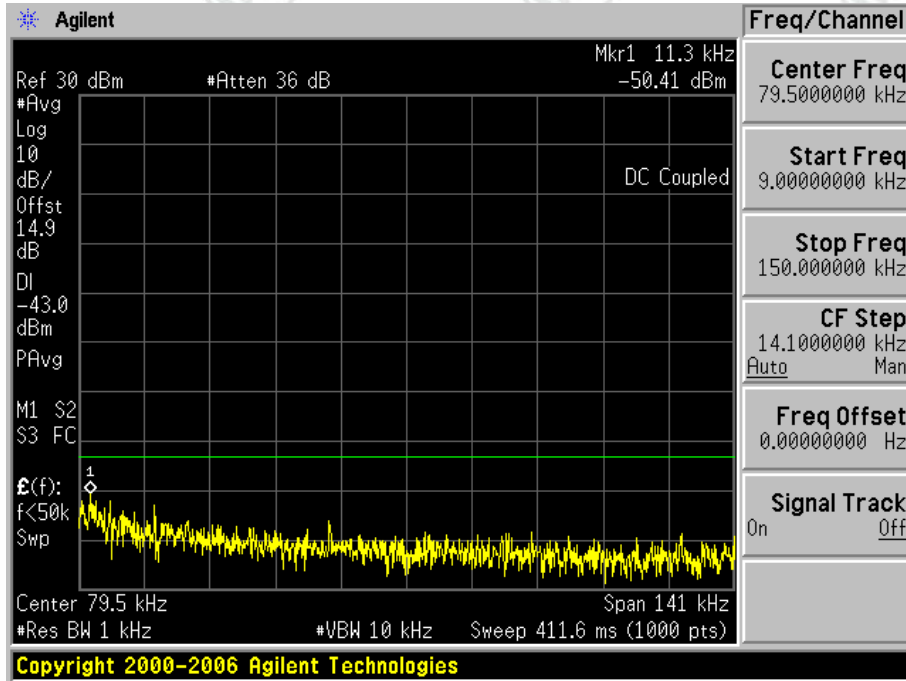

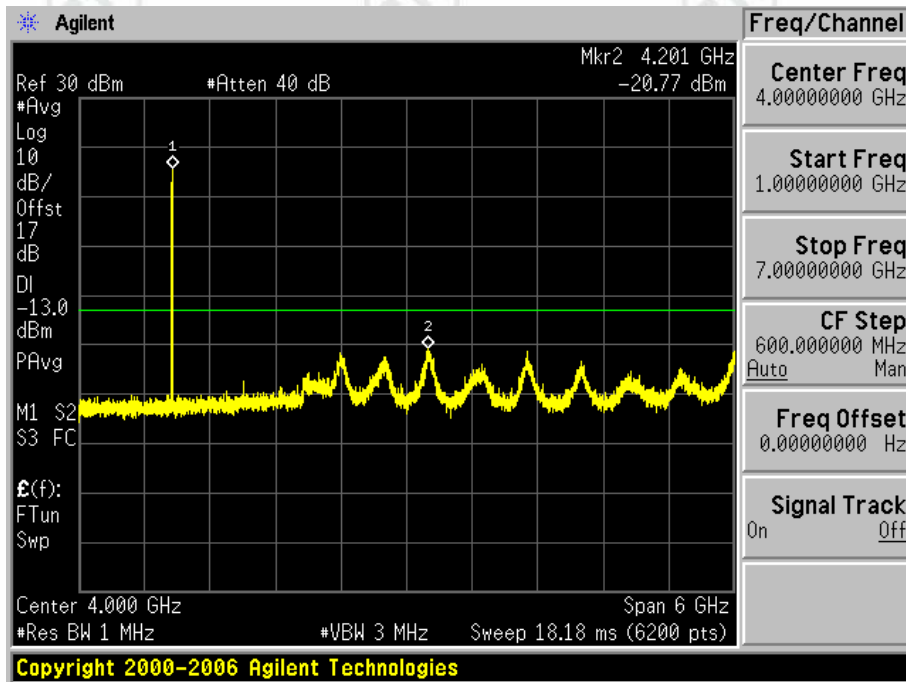
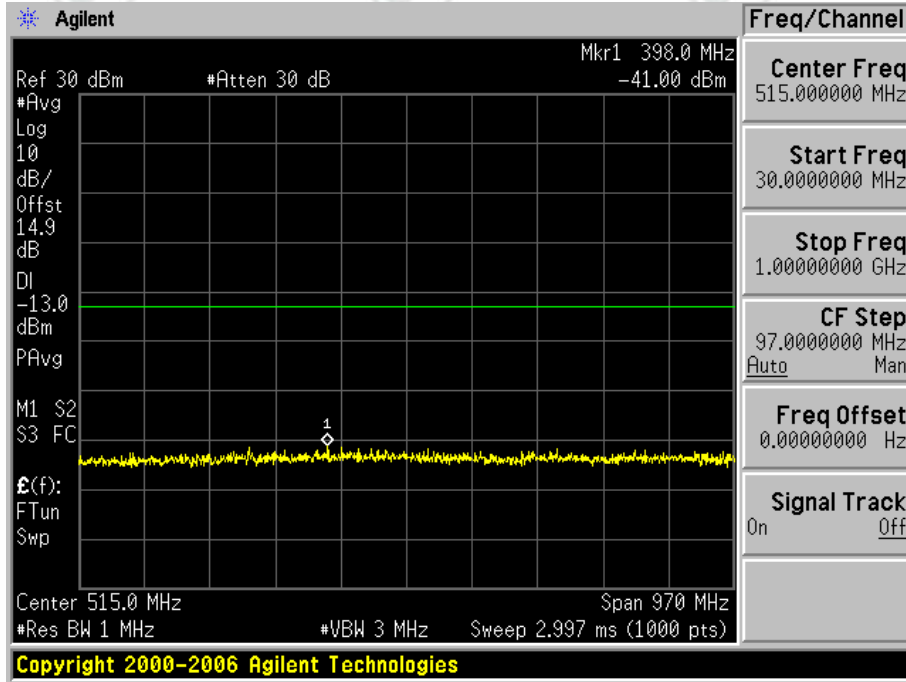

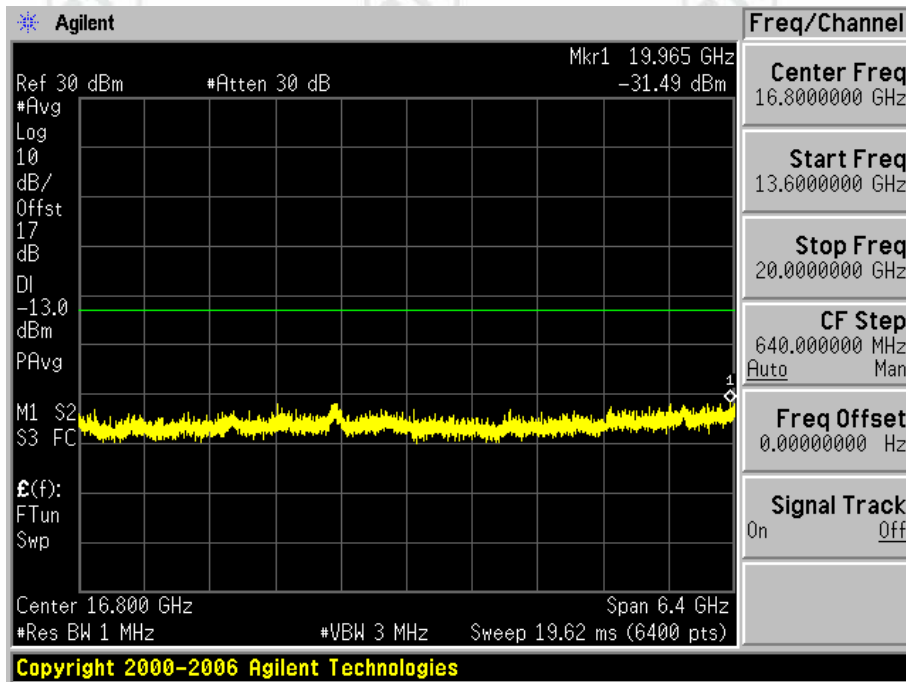
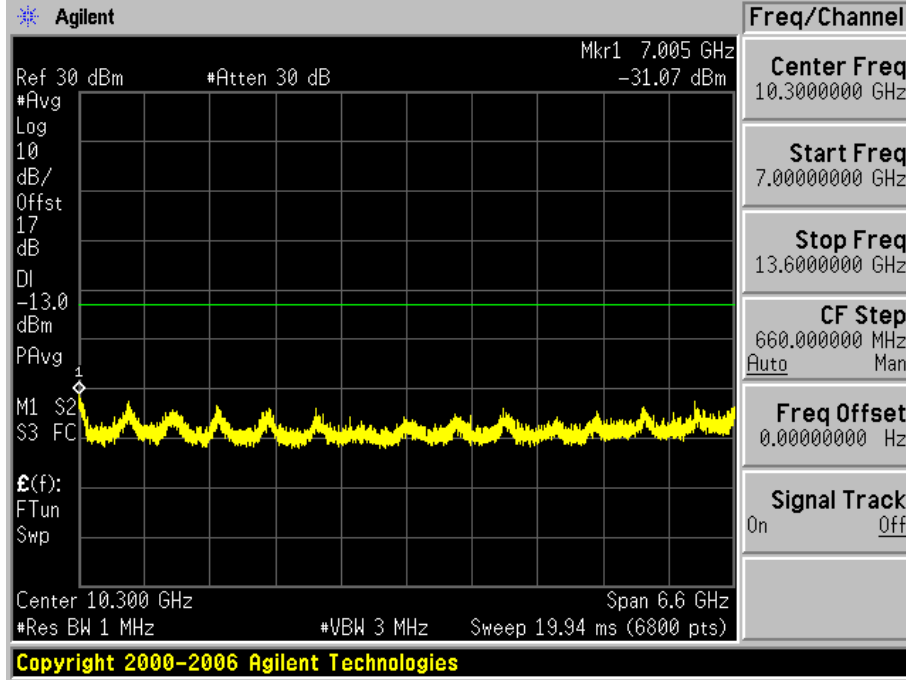

2.2.2.2 Test Channel=MCH

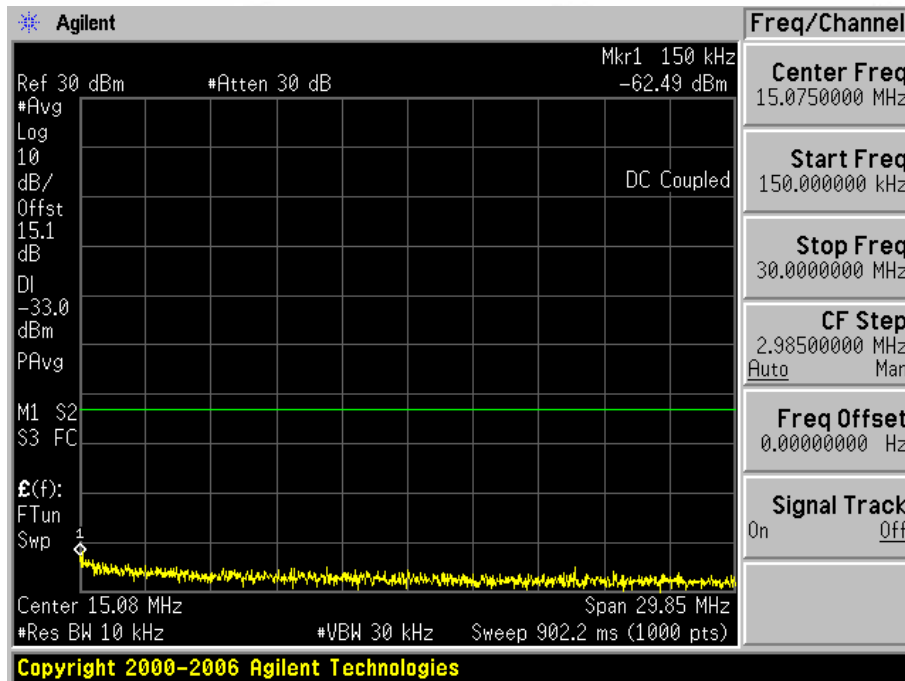
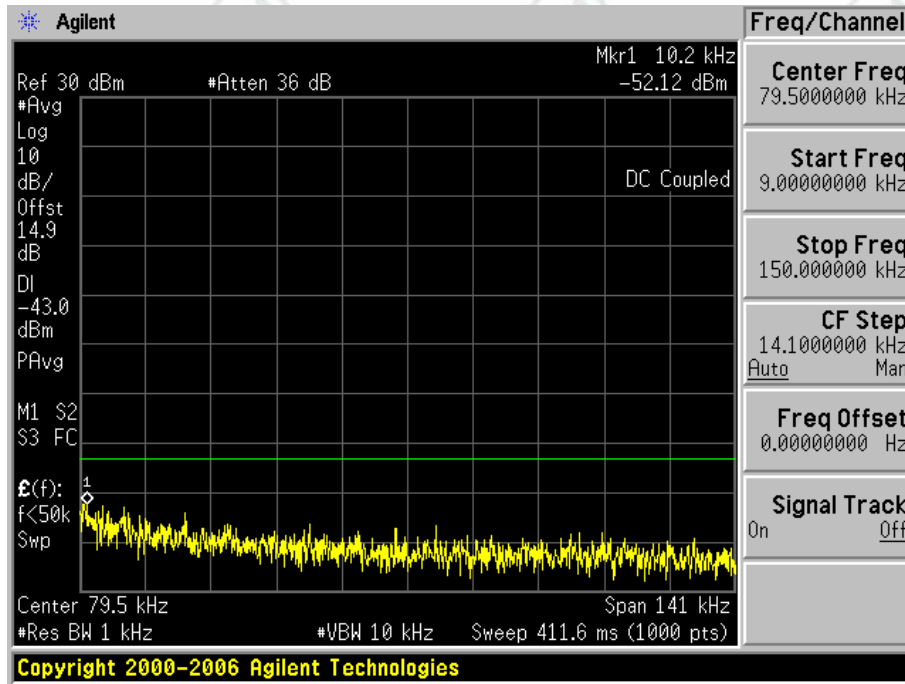

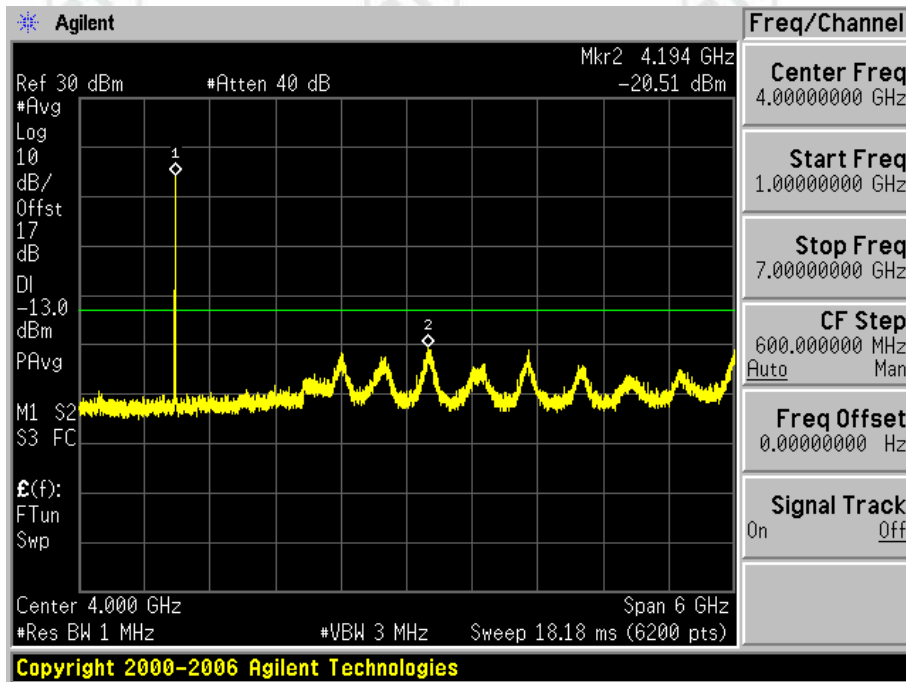
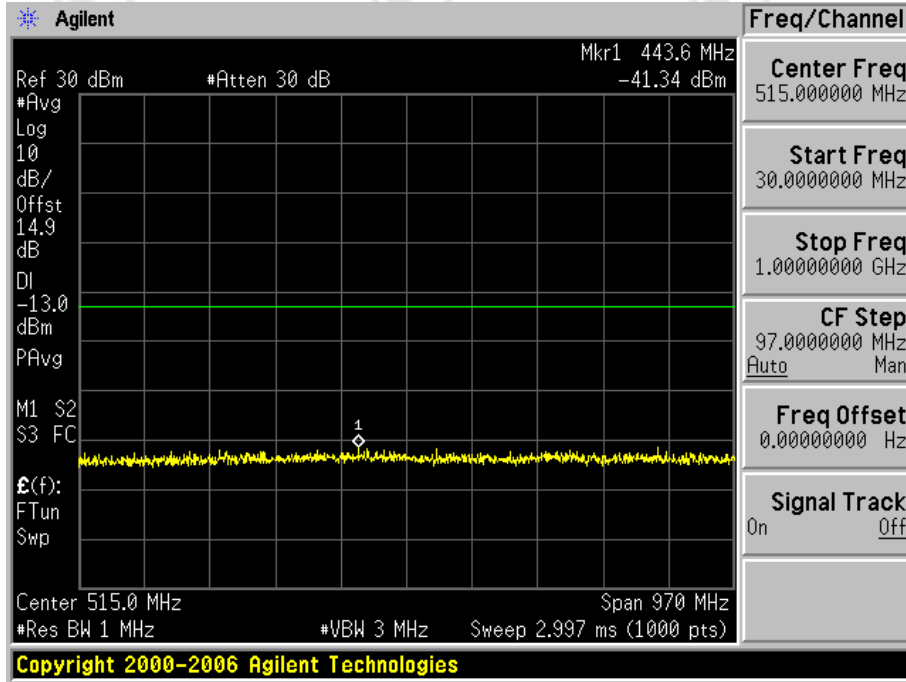

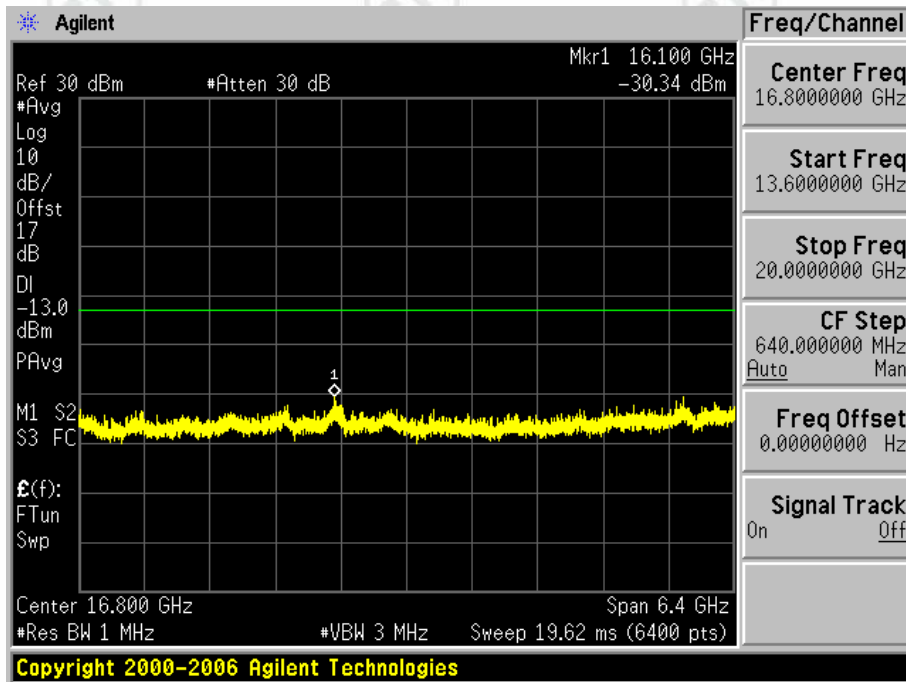
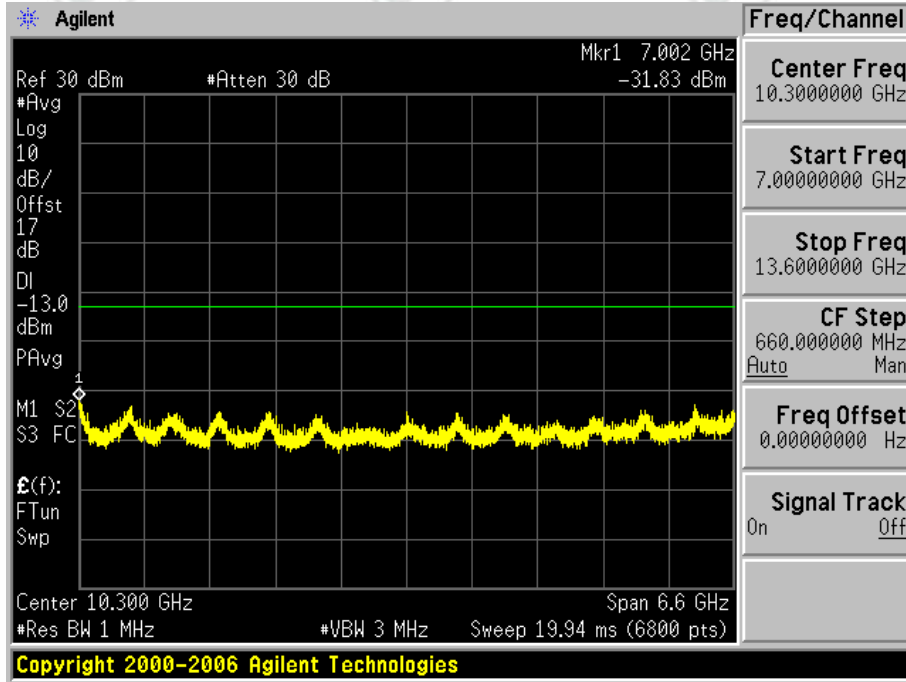

2.2.2.3 Test Channel=HCH

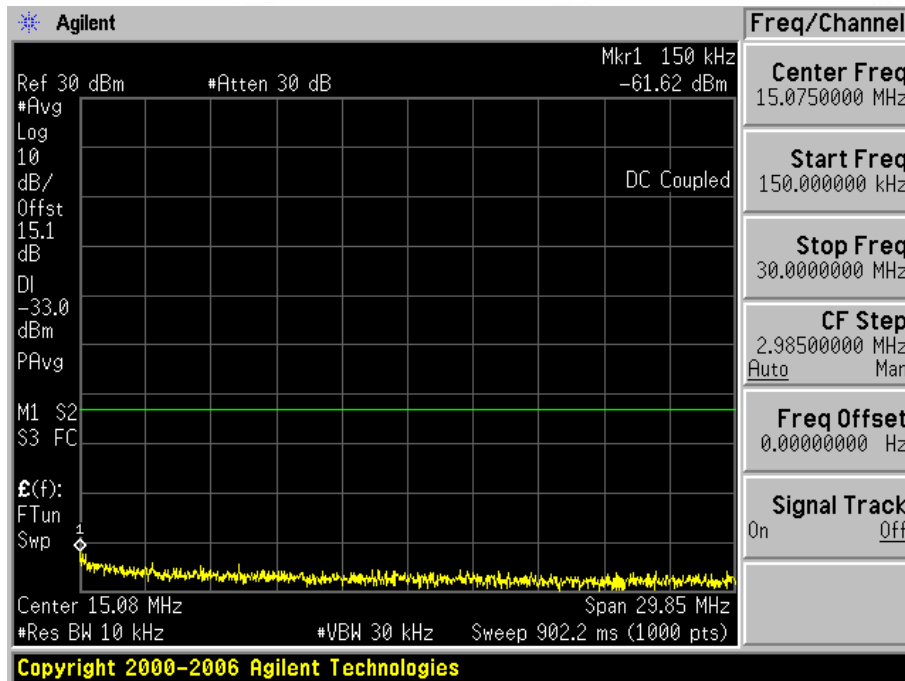
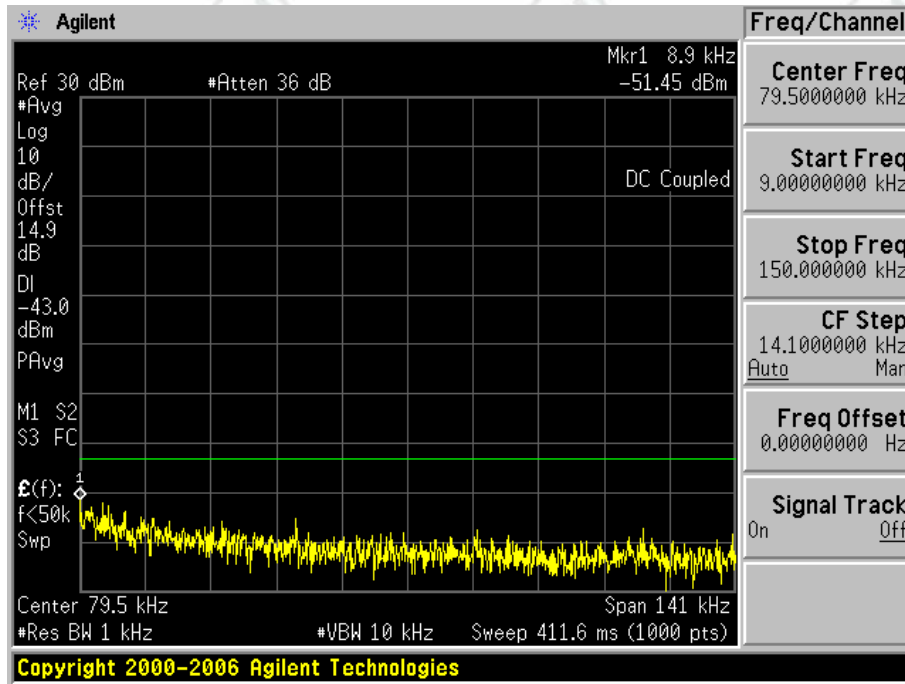

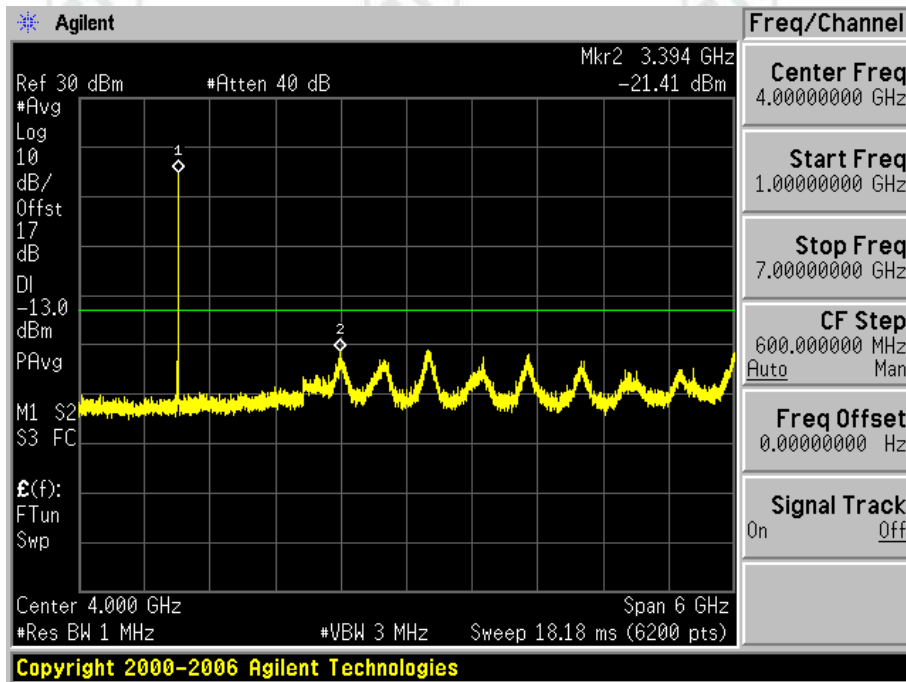
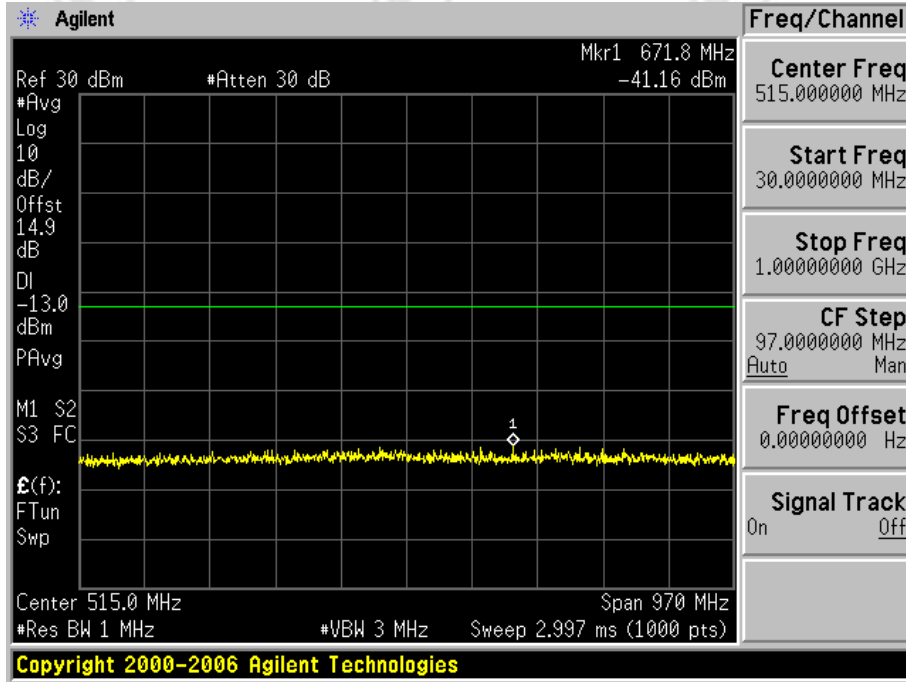

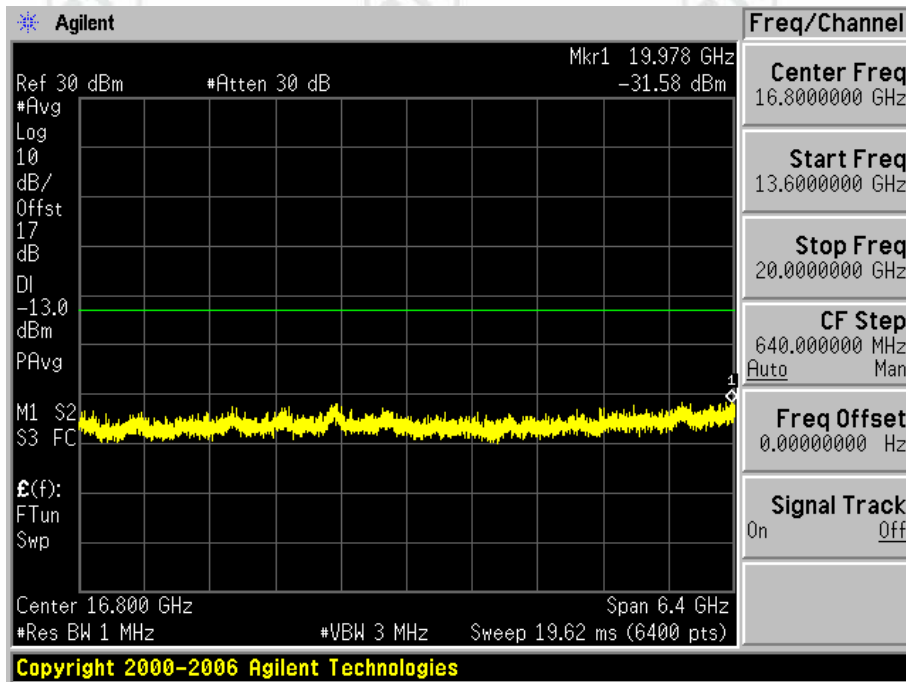
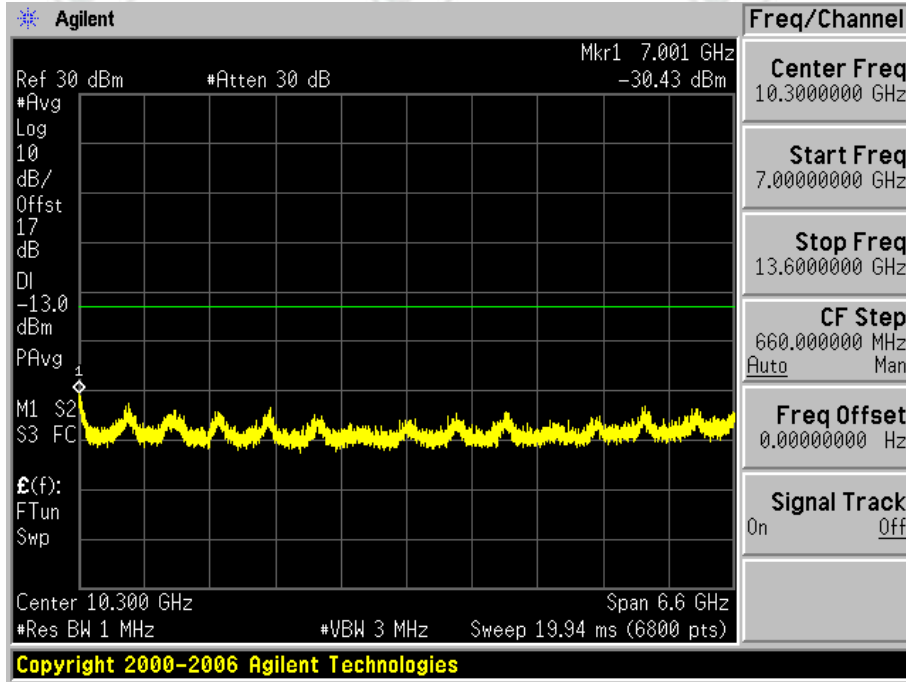

2.2.3 Test Mode=UMTS/TM3

2.2.3.1 Test Channel=LCH

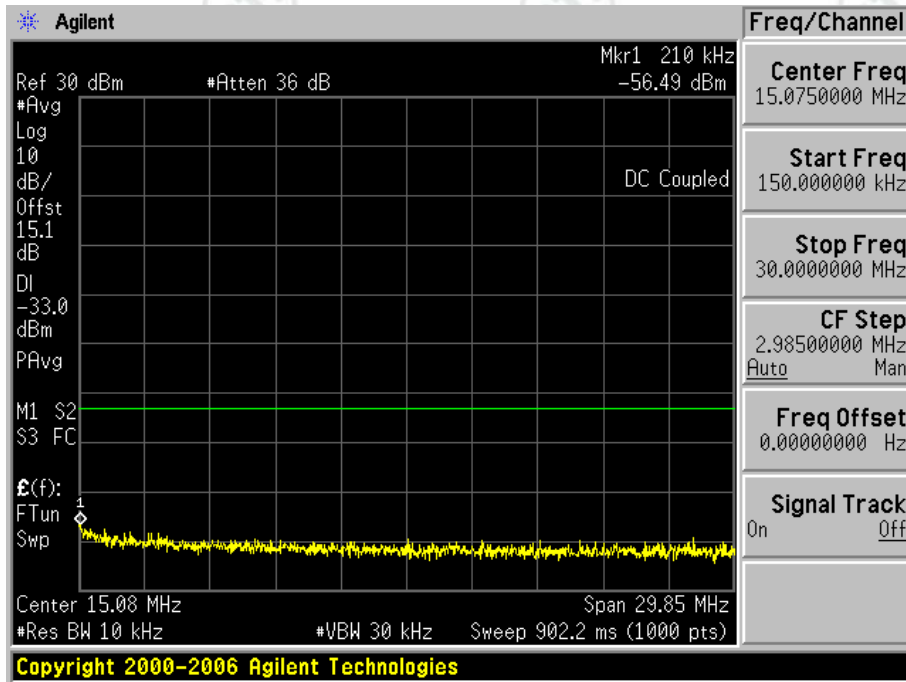
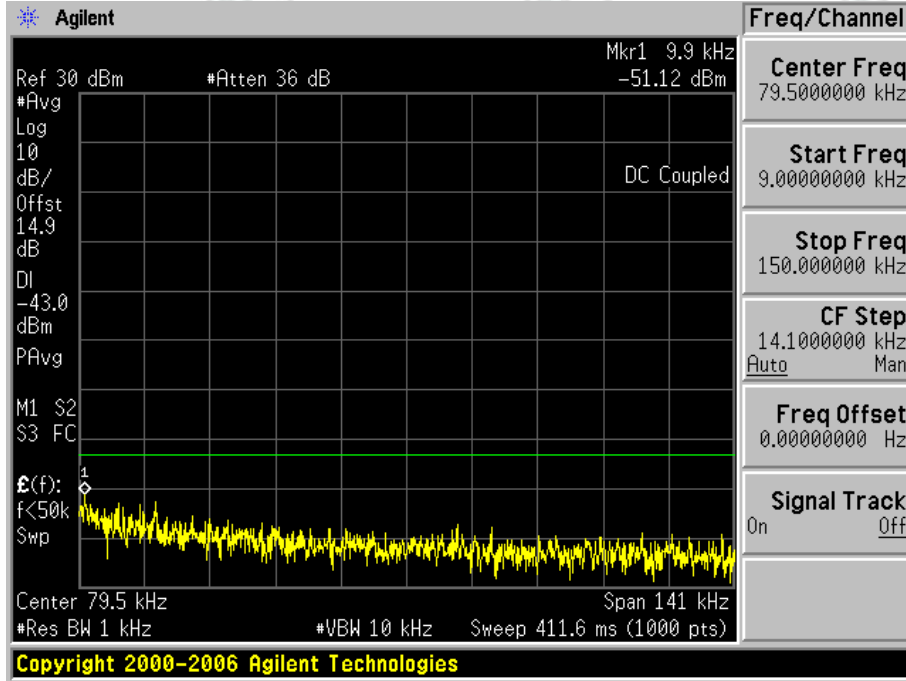

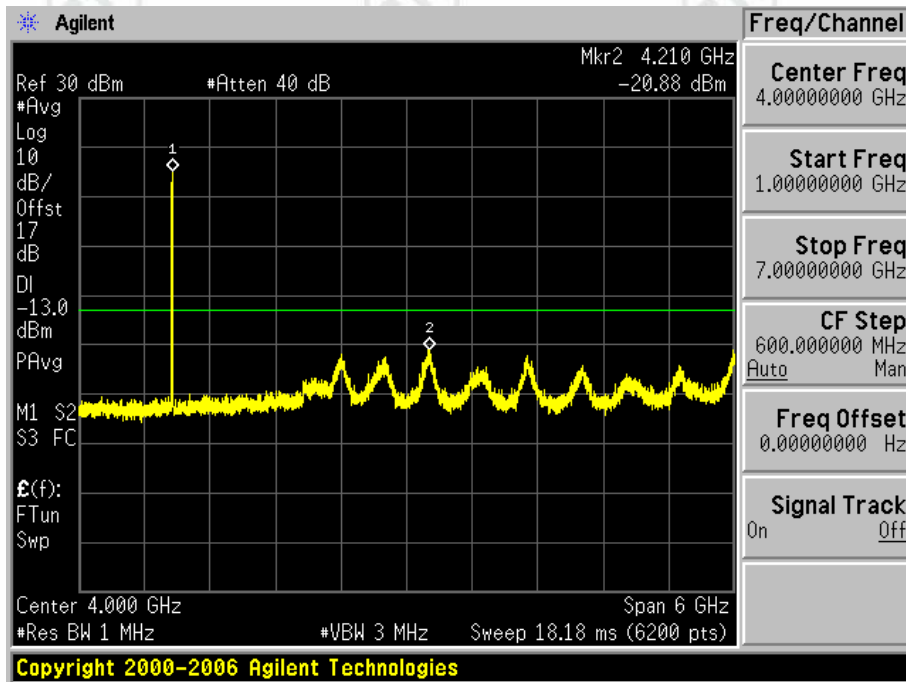
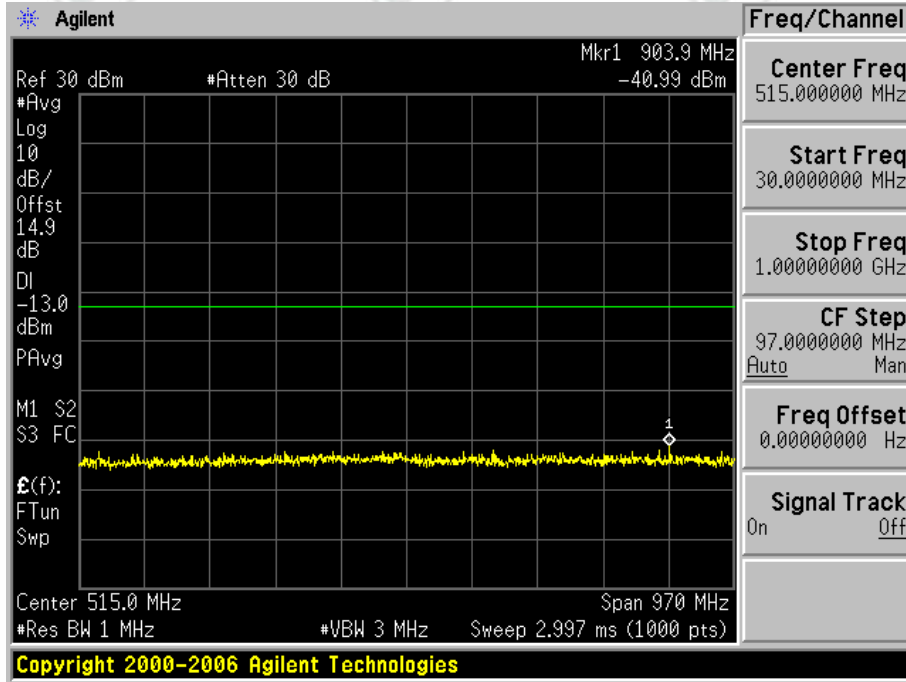

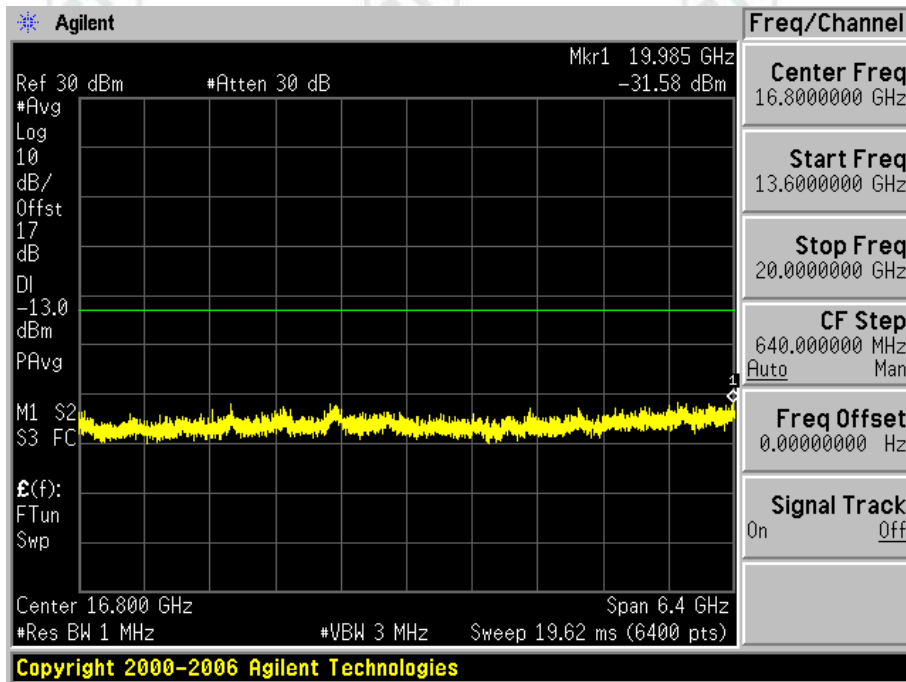
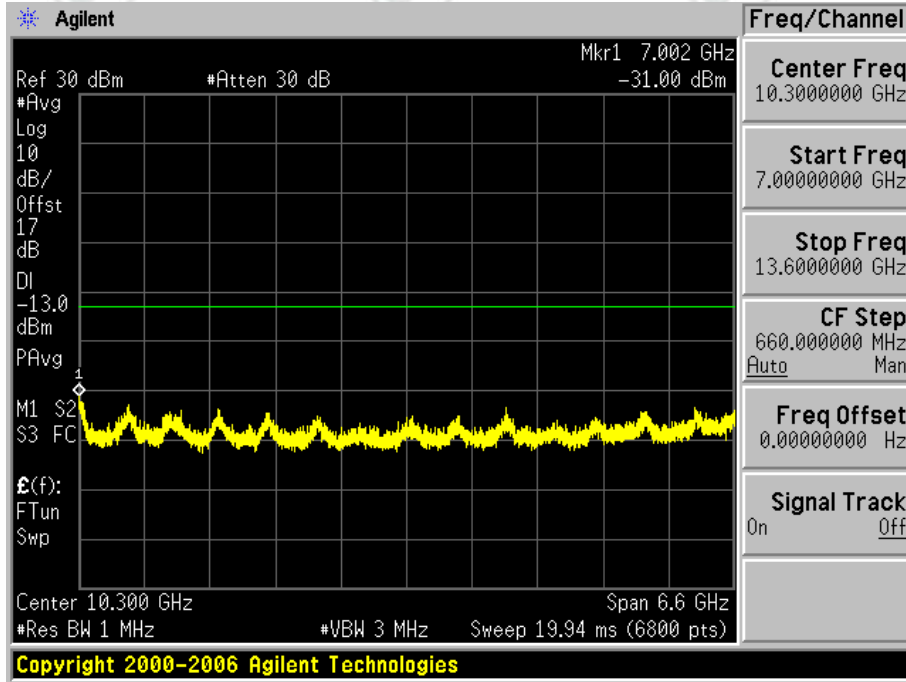

2.2.3.2 Test Channel=MCH

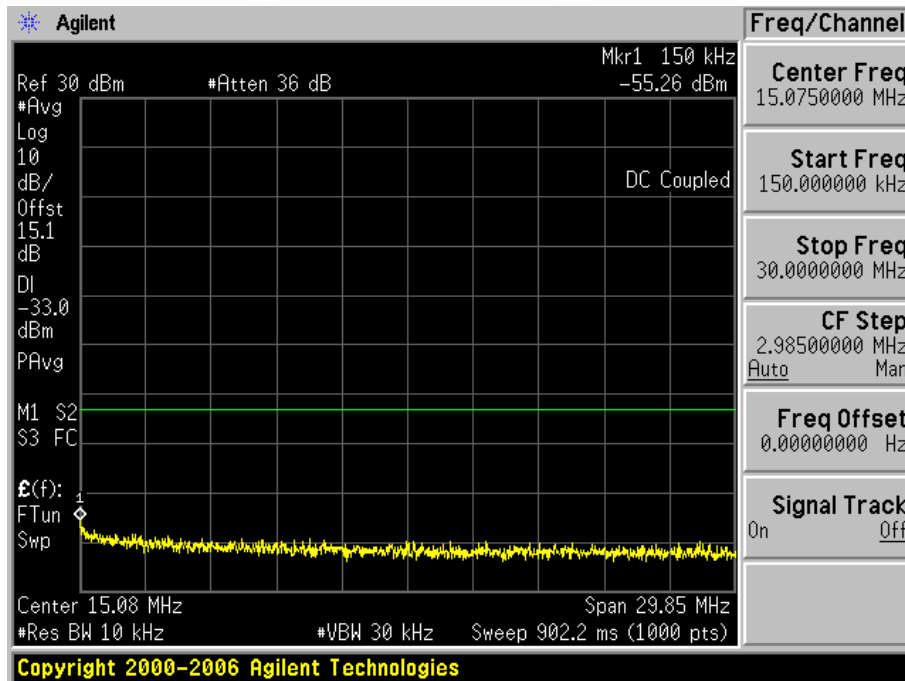
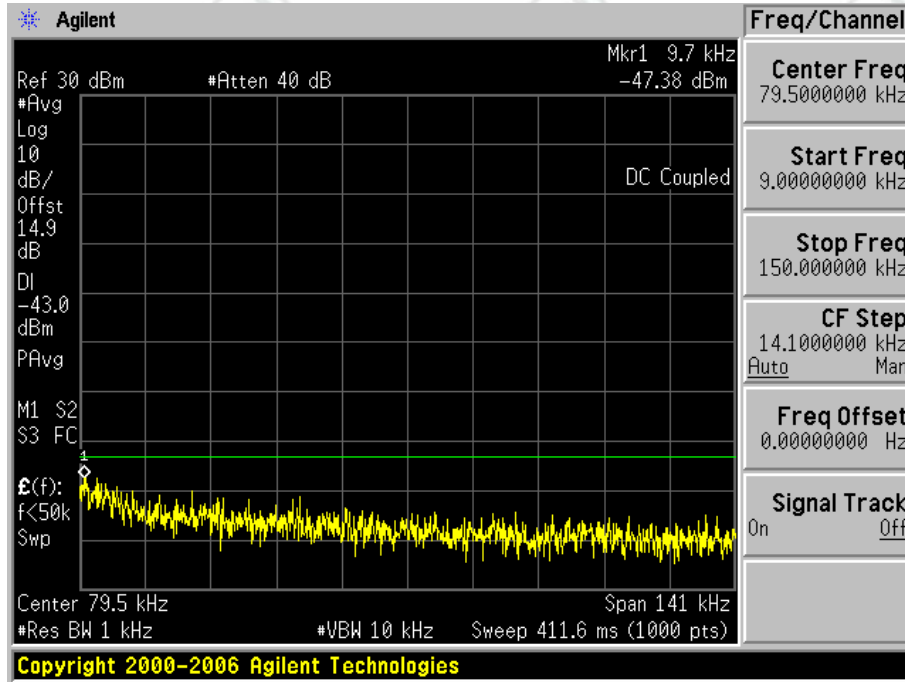

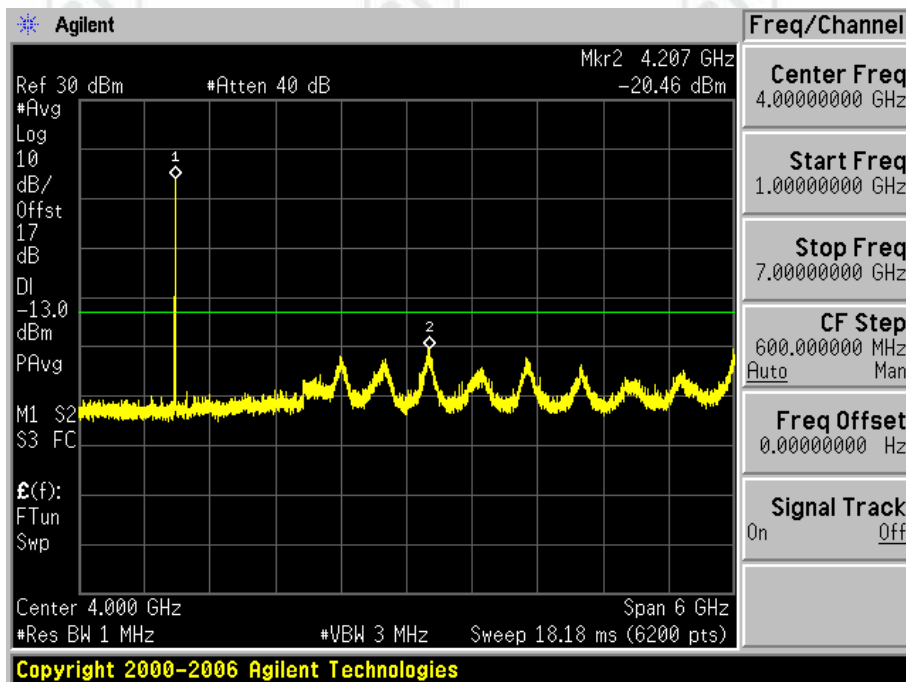
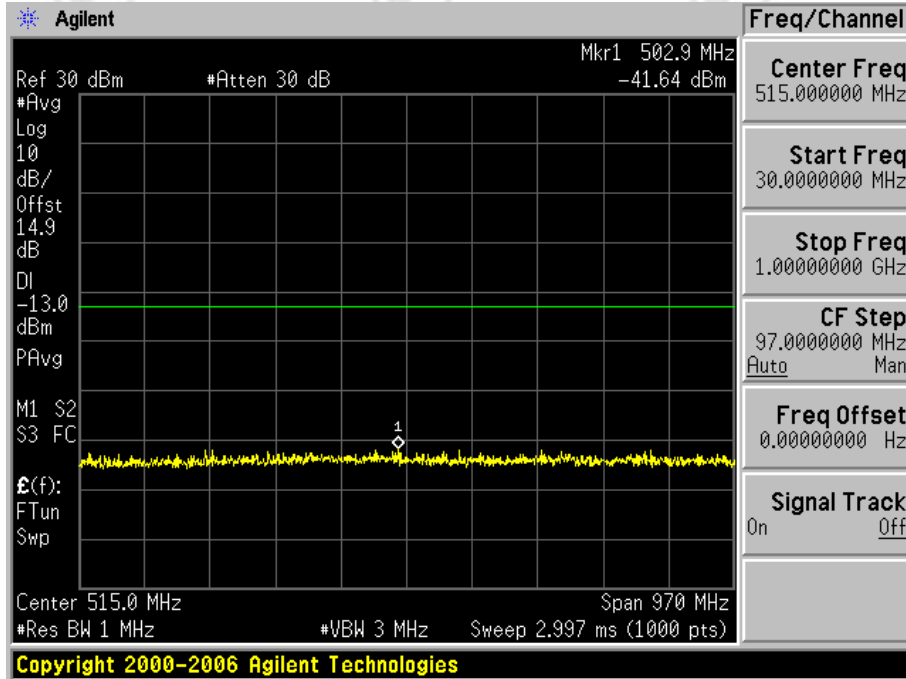

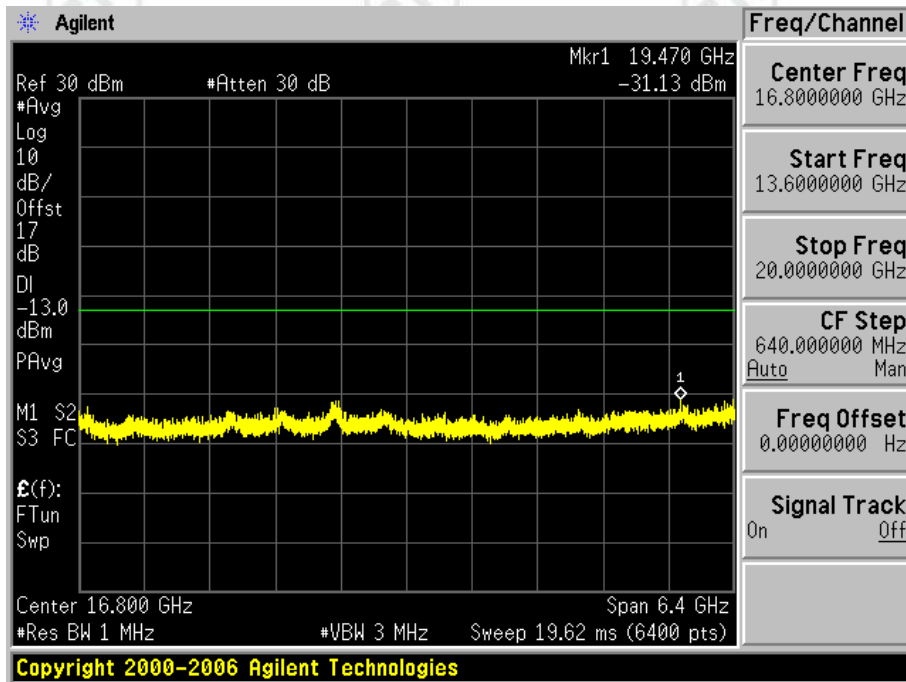
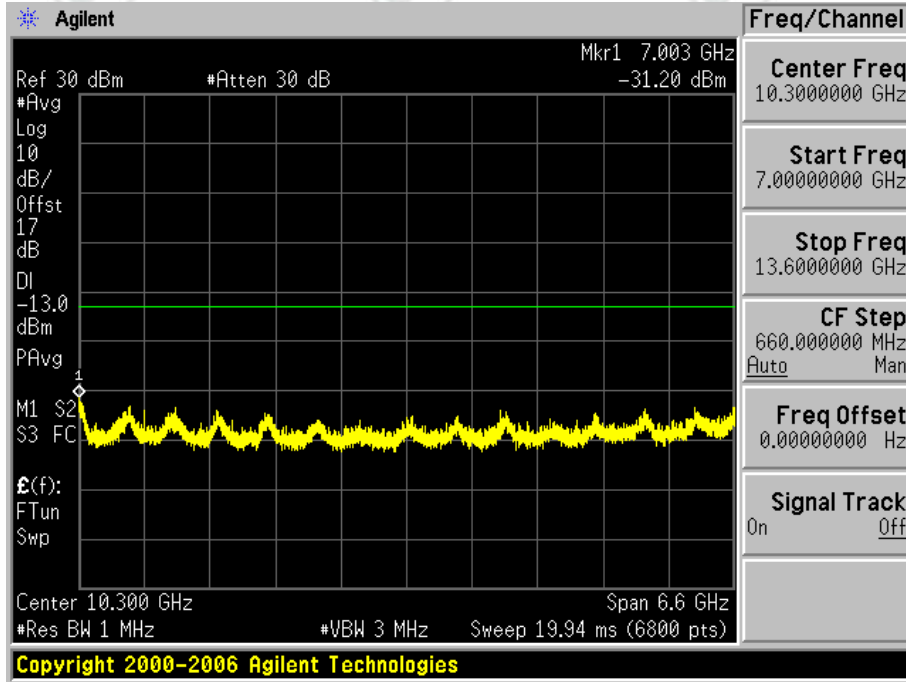

2.2.3.3 Test Channel=HCH

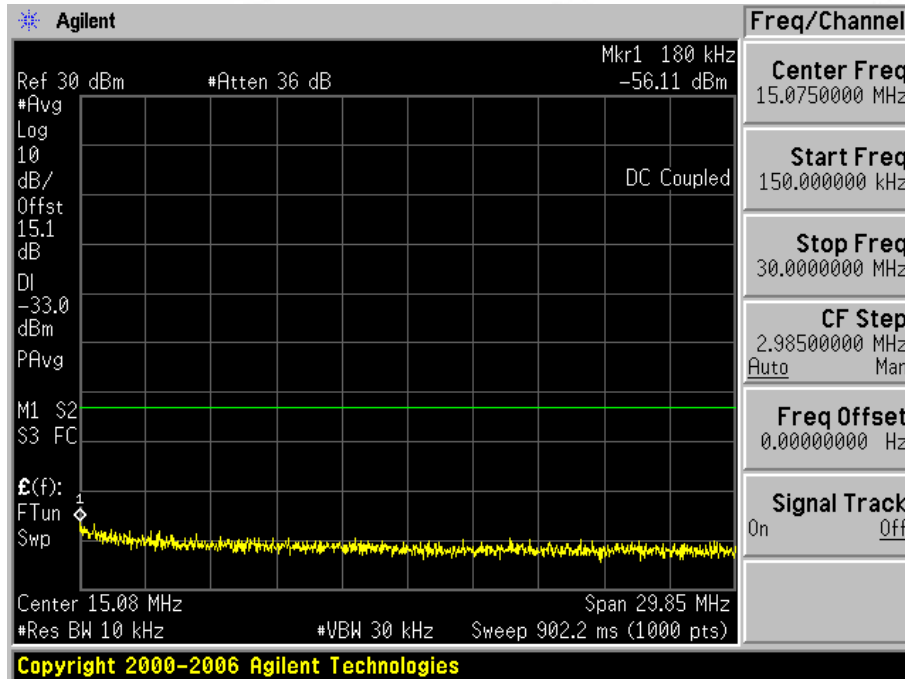
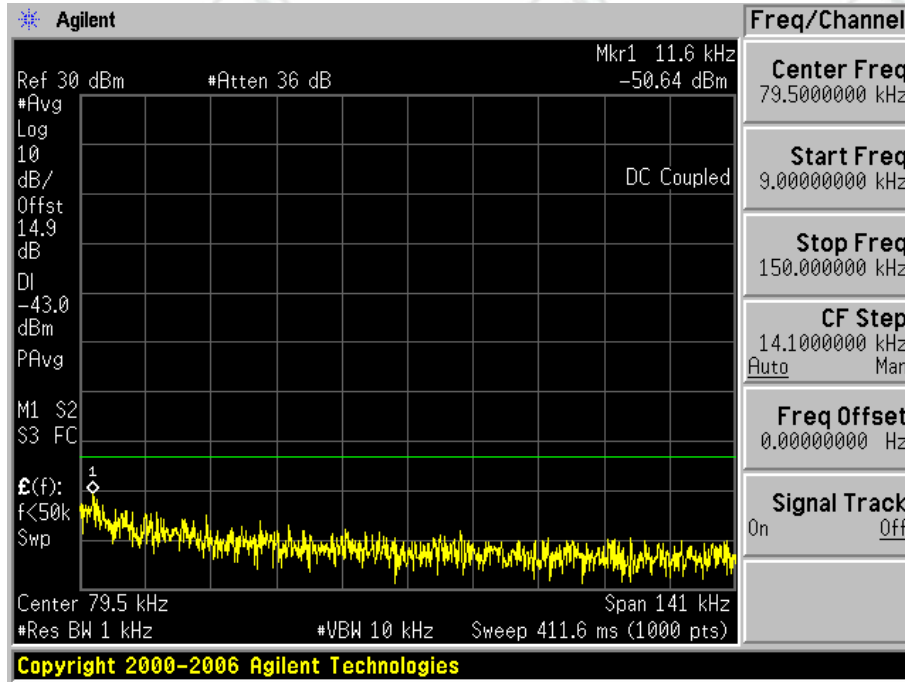

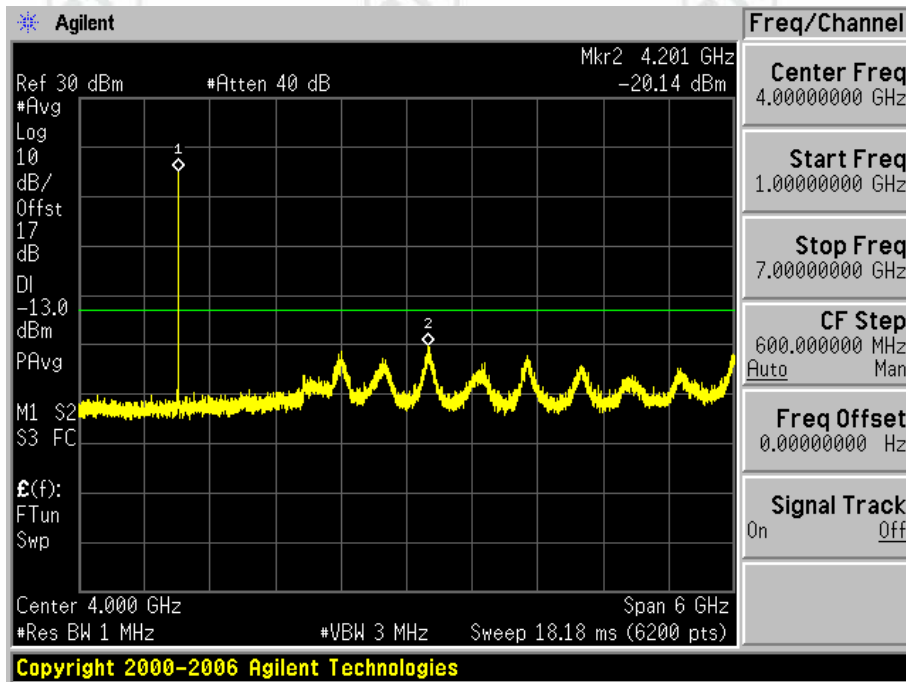
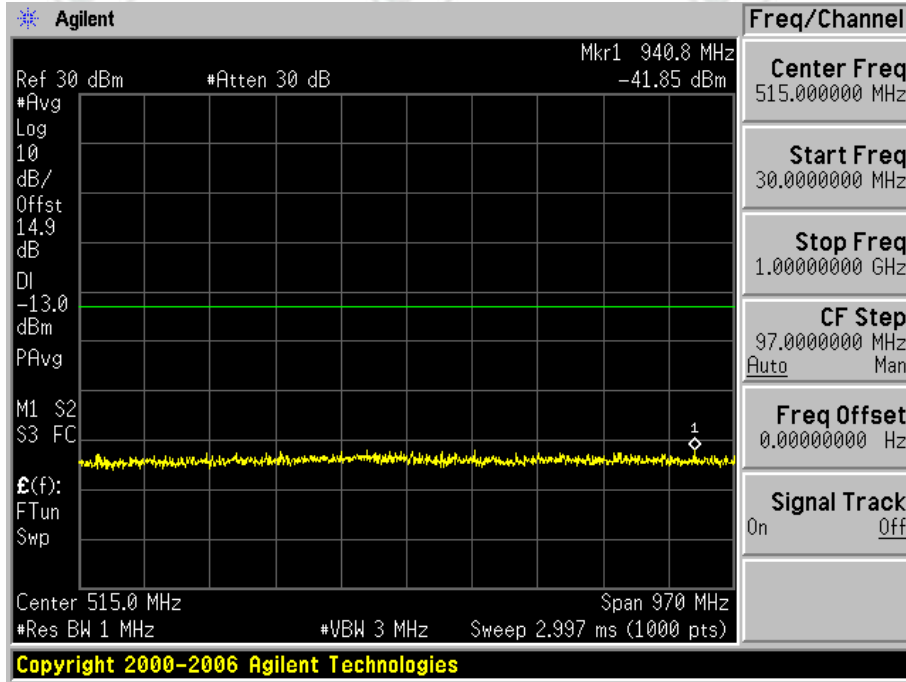

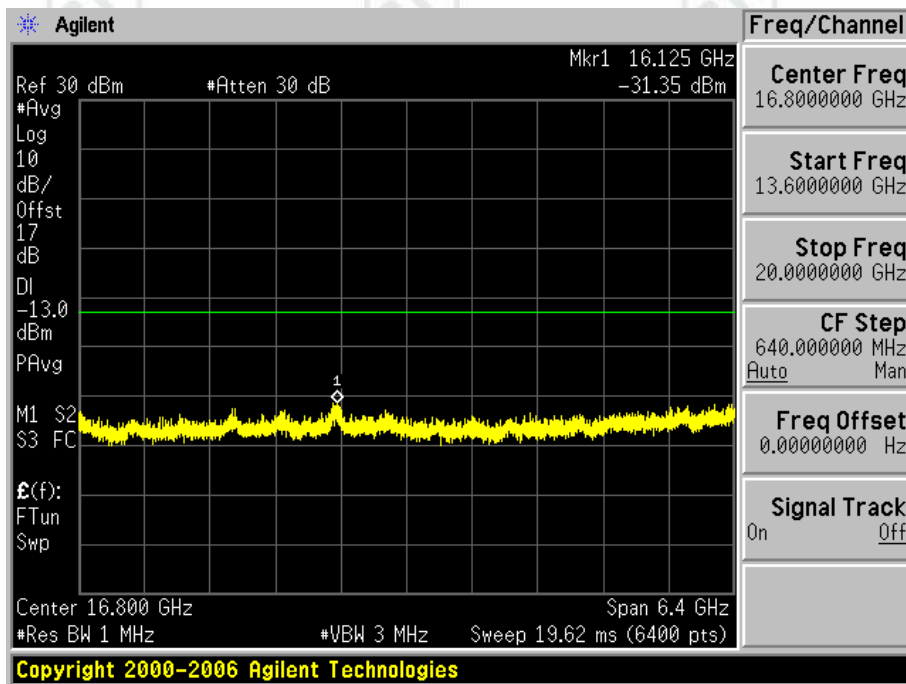
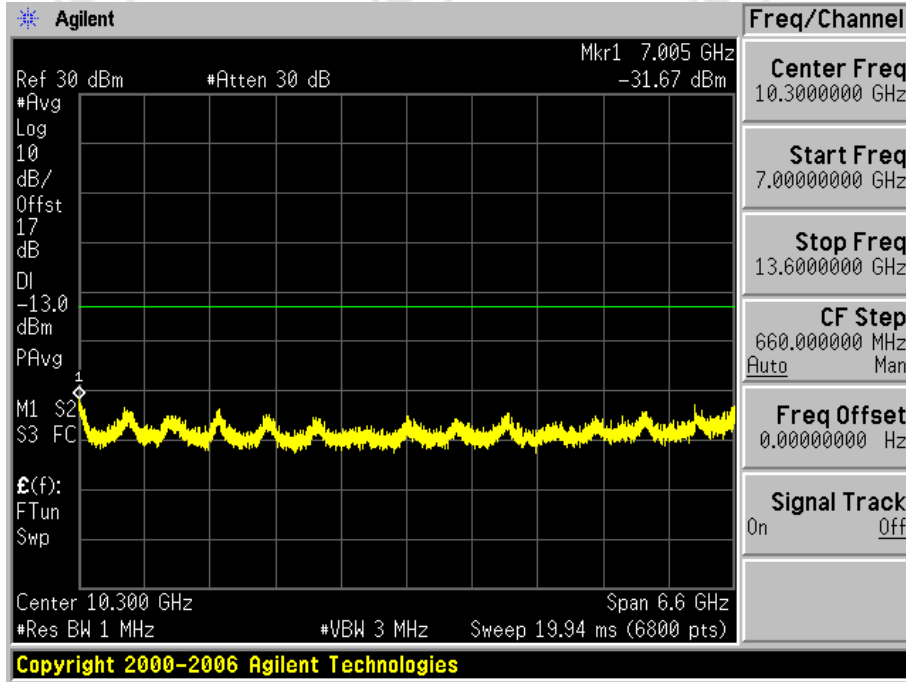

Appendix F) Frequency Stability

Test Requirement:	Part 2.1055	
Test Method:	TIA-603-E-2016 Clause 2.2.2	
Test Setup:	Refer to section 5 for details	
Measurement Procedure:	The transmitter output was connected to a calibrated coaxial cable and a Base Station Simulator. The Base Station Simulator was set to force the EUT to its maximum power setting. The tests were performed at three frequencies (low channel and high channel).The EUT was place in the temperature chamber, the DC leads and RF output cable exited the chamber though an opening made for that purpose. After Operate the equipment in standby conditions for 15 minutes before proceeding. The temperature was varied from -30°C to +55°C at intervals of not more than 10°C The frequency stability was read from the base station.Since the EUT is hand carried,battery powered equipment,at 25°C the input voltage was reduced from 3.7V(primary supply voltage) to 3.1V(end point voltage), the frequency stability and input voltage was record.	
Instruments Used:	Refer to section 7 for details	
Limit:	Operation Band	Frequency stability Limit(ppm)
	GPRS/EDGE/WCDMA 850	±2.5ppm
	GPRS/EDGE/WCDMA 1900	---
Test Results:	Pass	

Test Data:

Frequency Error vs. Voltage:

(VL is 3.1V, VN is 3.4V, VH is 3.7V)

Test Band	Test Mode	Test Channel	Test Temp.	Test Volt.	Freq.Error (Hz)	Freq.vs.rated (ppm)	Limit (ppm)	Verdict
GSM850	TM2	LCH	TN	VL	4.84	0.005872	±2.5	PASS
			TN	VN	5.55	0.006734	±2.5	PASS
			TN	VH	5.94	0.007207	±2.5	PASS
		MCH	TN	VL	6.59	0.007877	±2.5	PASS
			TN	VN	9.43	0.011272	±2.5	PASS
			TN	VH	3.49	0.004172	±2.5	PASS
		HCH	TN	VL	2.97	0.003499	±2.5	PASS
			TN	VN	6.39	0.007528	±2.5	PASS
			TN	VH	6.72	0.007917	±2.5	PASS

Test Band	Test Mode	Test Channel	Test Temp.	Test Volt.	Freq.Error (Hz)	Freq.vs.rated (ppm)	Limit (ppm)	Verdict
GSM850	TM3	LCH	TN	VL	-2.26	-0.002742	±2.5	PASS
			TN	VN	-1.65	-0.002002	±2.5	PASS
			TN	VH	0.48	0.000582	±2.5	PASS
		MCH	TN	VL	-1.39	-0.001661	±2.5	PASS
			TN	VN	-2.07	-0.002474	±2.5	PASS
			TN	VH	-6.17	-0.007375	±2.5	PASS
		HCH	TN	VL	0.61	0.000719	±2.5	PASS
			TN	VN	-1.49	-0.001755	±2.5	PASS
			TN	VH	-6.94	-0.008176	±2.5	PASS

Test Band	Test Mode	Test Channel	Test Temp.	Test Volt.	Freq.Error (Hz)	Freq.vs.rated (ppm)	Limit (ppm)	Verdict
GSM1900	TM2	LCH	TN	VL	7.43	0.004016	±2.5	PASS
			TN	VN	-3.10	-0.001675	±2.5	PASS
			TN	VH	-3.94	-0.002129	±2.5	PASS
		MCH	TN	VL	1.81	0.000963	±2.5	PASS
			TN	VN	2.32	0.001234	±2.5	PASS
			TN	VH	2.52	0.001340	±2.5	PASS
		HCH	TN	VL	-6.46	-0.003383	±2.5	PASS
			TN	VN	-7.88	-0.004126	±2.5	PASS
			TN	VH	-3.42	-0.001791	±2.5	PASS

Test Band	Test Mode	Test Channel	Test Temp.	Test Volt.	Freq.Error (Hz)	Freq.vs.rated (ppm)	Limit (ppm)	Verdict
GSM1900	TM3	LCH	TN	VL	-6.94	-0.003751	±2.5	PASS
			TN	VN	-11.04	-0.005967	±2.5	PASS
			TN	VH	-13.66	-0.007383	±2.5	PASS
		MCH	TN	VL	-11.75	-0.006250	±2.5	PASS
			TN	VN	-3.10	-0.001649	±2.5	PASS
			TN	VH	0.29	0.000154	±2.5	PASS
		HCH	TN	VL	-6.91	-0.003618	±2.5	PASS
			TN	VN	-4.58	-0.002398	±2.5	PASS
			TN	VH	-0.81	-0.000424	±2.5	PASS

Frequency Error vs. Temperature

Test Band	Test Mode	Test Channel	Test Volt.	Test Temp	Freq.Error (Hz)	Freq.vs.rated (ppm)	Limit (ppm)	Verdict
GSM850	TM2	LCH	VN	-30	5.62	0.006819	±2.5	PASS
			VN	-20	11.43	0.013868	±2.5	PASS
			VN	-10	4.91	0.005957	±2.5	PASS
			VN	0	4.26	0.005169	±2.5	PASS
			VN	10	5.81	0.007049	±2.5	PASS
			VN	20	6.65	0.008068	±2.5	PASS
			VN	30	6.33	0.007680	±2.5	PASS
			VN	40	4.78	0.005800	±2.5	PASS
			VN	50	8.46	0.010264	±2.5	PASS
GSM850	TM2	MCH	VN	-30	8.07	0.009646	±2.5	PASS
			VN	-20	0.26	0.000311	±2.5	PASS
			VN	-10	1.87	0.002235	±2.5	PASS
			VN	0	3.42	0.004088	±2.5	PASS
			VN	10	5.55	0.006634	±2.5	PASS
			VN	20	3.23	0.003861	±2.5	PASS
			VN	30	0.65	0.000777	±2.5	PASS
			VN	40	2.45	0.002929	±2.5	PASS
			VN	50	4.84	0.005785	±2.5	PASS
GSM850	TM2	HCH	VN	-30	8.01	0.009437	±2.5	PASS
			VN	-20	1.68	0.001979	±2.5	PASS
			VN	-10	5.36	0.006315	±2.5	PASS
			VN	0	8.78	0.010344	±2.5	PASS
			VN	10	3.29	0.003876	±2.5	PASS
			VN	20	5.62	0.006621	±2.5	PASS
			VN	30	8.59	0.010120	±2.5	PASS
			VN	40	2.71	0.003193	±2.5	PASS
			VN	50	5.68	0.006692	±2.5	PASS

Test Band	Test Mode	Test Channel	Test Volt.	Test Temp	Freq.Error (Hz)	Freq.vs.rated (ppm)	Limit (ppm)	Verdict
GSM850	TM3	LCH	VN	-30	-9.40	-0.011405	±2.5	PASS
			VN	-20	-8.91	-0.010810	±2.5	PASS
			VN	-10	-1.52	-0.001844	±2.5	PASS
			VN	0	-0.68	-0.000825	±2.5	PASS
			VN	10	-4.04	-0.004902	±2.5	PASS
			VN	20	-4.33	-0.005254	±2.5	PASS
			VN	30	-6.49	-0.007874	±2.5	PASS
			VN	40	-5.94	-0.007207	±2.5	PASS
			VN	50	-3.75	-0.004550	±2.5	PASS
GSM850	TM3	MCH	VN	-30	-5.78	-0.006909	±2.5	PASS
			VN	-20	-8.72	-0.010423	±2.5	PASS
			VN	-10	-2.71	-0.003239	±2.5	PASS
			VN	0	-6.20	-0.007411	±2.5	PASS
			VN	10	-5.36	-0.006407	±2.5	PASS
			VN	20	-4.62	-0.005522	±2.5	PASS
			VN	30	-2.10	-0.002510	±2.5	PASS
			VN	40	-6.23	-0.007447	±2.5	PASS
			VN	50	-5.20	-0.006216	±2.5	PASS
GSM850	TM3	HCH	VN	-30	-7.59	-0.008942	±2.5	PASS
			VN	-20	-6.75	-0.007952	±2.5	PASS
			VN	-10	-1.84	-0.002168	±2.5	PASS
			VN	0	-5.55	-0.006539	±2.5	PASS
			VN	10	-4.58	-0.005396	±2.5	PASS
			VN	20	-4.36	-0.005137	±2.5	PASS
			VN	30	3.23	0.003805	±2.5	PASS
			VN	40	-6.75	-0.007952	±2.5	PASS
			VN	50	-2.13	-0.002509	±2.5	PASS

Test Band	Test Mode	Test Channel	Test Volt.	Test Temp	Freq.Error (Hz)	Freq.vs.rated (ppm)	Limit (ppm)	Verdict
GSM1900	TM2	LCH	VN	-30	3.62	0.001957	±2.5	PASS
			VN	-20	2.39	0.001292	±2.5	PASS
			VN	-10	0.45	0.000243	±2.5	PASS
			VN	0	-1.68	-0.000908	±2.5	PASS
			VN	10	-4.46	-0.002411	±2.5	PASS
			VN	20	-6.07	-0.003281	±2.5	PASS
			VN	30	-8.14	-0.004400	±2.5	PASS
			VN	40	0.58	0.000313	±2.5	PASS
			VN	50	-5.68	-0.003070	±2.5	PASS
GSM1900	TM2	MCH	VN	-30	-5.29	-0.002814	±2.5	PASS
			VN	-20	-6.46	-0.003436	±2.5	PASS
			VN	-10	-9.04	-0.004809	±2.5	PASS
			VN	0	-10.07	-0.005356	±2.5	PASS
			VN	10	-11.75	-0.006250	±2.5	PASS
			VN	20	-1.94	-0.001032	±2.5	PASS
			VN	30	-6.20	-0.003298	±2.5	PASS
			VN	40	1.94	0.001032	±2.5	PASS
			VN	50	2.58	0.001372	±2.5	PASS
GSM1900	TM2	HCH	VN	-30	-11.88	-0.006221	±2.5	PASS
			VN	-20	-4.84	-0.002534	±2.5	PASS
			VN	-10	-4.84	-0.002534	±2.5	PASS
			VN	0	-2.71	-0.001419	±2.5	PASS
			VN	10	1.23	0.000644	±2.5	PASS
			VN	20	0.32	0.000168	±2.5	PASS
			VN	30	-2.52	-0.001320	±2.5	PASS
			VN	40	-3.94	-0.002063	±2.5	PASS
			VN	50	-6.33	-0.003314	±2.5	PASS

Test Band	Test Mode	Test Channel	Test Volt.	Test Temp	Freq.Error (Hz)	Freq.vs.rated (ppm)	Limit (ppm)	Verdict
GSM1900	TM3	LCH	VN	-30	6.04	0.003265	±2.5	PASS
			VN	-20	-10.30	-0.005567	±2.5	PASS
			VN	-10	-10.36	-0.005599	±2.5	PASS
			VN	0	-9.65	-0.005216	±2.5	PASS

			VN	10	-9.75	-0.005270	±2.5	PASS
			VN	20	-9.01	-0.004870	±2.5	PASS
			VN	30	-9.56	-0.005167	±2.5	PASS
			VN	40	-10.04	-0.005426	±2.5	PASS
			VN	50	-10.23	-0.005529	±2.5	PASS
GSM1900	TM3	MCH	VN	-30	-14.82	-0.007883	±2.5	PASS
			VN	-20	3.91	0.002080	±2.5	PASS
			VN	-10	-5.26	-0.002798	±2.5	PASS
			VN	0	0.94	0.000500	±2.5	PASS
			VN	10	-9.40	-0.005000	±2.5	PASS
			VN	20	-7.04	-0.003745	±2.5	PASS
			VN	30	-13.43	-0.007144	±2.5	PASS
			VN	40	-13.50	-0.007181	±2.5	PASS
			VN	50	-13.04	-0.006936	±2.5	PASS
GSM1900	TM3	HCH	VN	-30	-0.03	-0.000016	±2.5	PASS
			VN	-20	1.78	0.000932	±2.5	PASS
			VN	-10	-6.26	-0.003278	±2.5	PASS
			VN	0	2.45	0.001283	±2.5	PASS
			VN	10	1.29	0.000675	±2.5	PASS
			VN	20	4.62	0.002419	±2.5	PASS
			VN	30	-5.07	-0.002655	±2.5	PASS
			VN	40	2.42	0.001267	±2.5	PASS
			VN	50	-6.30	-0.003299	±2.5	PASS

Test Band	Test Mode	Test Channel	Test Temp.	Test Volt.	Freq.Error (Hz)	Freq.vs.rated (ppm)	Limit (ppm)	Verdict
WCDMA8 50	TM1	LCH	TN	VL	10.56	0.012777	±2.5	PASS
			TN	VN	145.63	0.176222	±2.5	PASS
			TN	VH	-8.19	-0.009915	±2.5	PASS
		MCH	TN	VL	284.10	0.339674	±2.5	PASS
			TN	VN	145.63	1.214975	±2.5	PASS
			TN	VH	737.66	0.881941	±2.5	PASS
		HCH	TN	VL	-0.92	-0.001081	±2.5	PASS
			TN	VN	145.63	0.002613	±2.5	PASS
			TN	VH	7.16	0.008453	±2.5	PASS

Test Band	Test Mode	Test Channel	Test Temp.	Test Volt.	Freq.Error (Hz)	Freq.vs.rated (ppm)	Limit (ppm)	Verdict
WCDMA8 50	TM2	LCH	TN	VL	42.22	0.051090	±2.5	PASS
			TN	VN	-22.46	-0.027179	±2.5	PASS
			TN	VH	50.08	0.060599	±2.5	PASS
		MCH	TN	VL	-142.44	-0.170302	±2.5	PASS
			TN	VN	-22.46	0.012916	±2.5	PASS
			TN	VH	26.92	0.032181	±2.5	PASS
		HCH	TN	VL	-26.41	-0.031199	±2.5	PASS
			TN	VN	-22.46	0.029703	±2.5	PASS
			TN	VH	-29.11	-0.034389	±2.5	PASS
Test Band	Test Mode	Test Channel	Test Temp.	Test Volt.	Freq.Error (Hz)	Freq.vs.rated (ppm)	Limit (ppm)	Verdict
WCDMA8 50	TM3	LCH	TN	VL	-0.93	-0.001126	±2.5	PASS
			TN	VN	-88.73	-0.107369	±2.5	PASS
			TN	VH	1.98	0.002400	±2.5	PASS
		MCH	TN	VL	-5.05	-0.006039	±2.5	PASS
			TN	VN	-88.73	-0.133341	±2.5	PASS
			TN	VH	-96.62	-0.115517	±2.5	PASS
		HCH	TN	VL	118.44	0.139899	±2.5	PASS
			TN	VN	-88.73	0.032352	±2.5	PASS
			TN	VH	-96.12	-0.113531	±2.5	PASS

Test Band	Test Mode	Test Channel	Test Temp.	Test Volt.	Freq.Error (Hz)	Freq.vs.rated (ppm)	Limit (ppm)	Verdict
WCDMA1 900	TM1	LCH	TN	VL	19.61	0.010585	±2.5	PASS
			TN	VN	13.60	0.007339	±2.5	PASS
			TN	VH	3.27	0.001763	±2.5	PASS
		MCH	TN	VL	149.19	0.079354	±2.5	PASS
			TN	VN	13.60	-0.001510	±2.5	PASS
			TN	VH	-17.62	-0.009374	±2.5	PASS
		HCH	TN	VL	85.85	0.045002	±2.5	PASS
			TN	VN	13.60	0.078886	±2.5	PASS
			TN	VH	445.62	0.233601	±2.5	PASS
Test Band	Test Mode	Test Channel	Test Temp.	Test Volt.	Freq.Error (Hz)	Freq.vs.rated (ppm)	Limit (ppm)	Verdict
WCDMA1 900	TM2	LCH	TN	VL	-78.70	-0.042488	±2.5	PASS
			TN	VN	-195.66	-0.105627	±2.5	PASS
			TN	VH	125.08	0.067521	±2.5	PASS
		MCH	TN	VL	-85.51	-0.045484	±2.5	PASS
			TN	VN	-195.66	-0.111008	±2.5	PASS
			TN	VH	8.18	0.004350	±2.5	PASS
		HCH	TN	VL	105.36	0.055233	±2.5	PASS
			TN	VN	-195.66	0.000024	±2.5	PASS
			TN	VH	-54.61	-0.028628	±2.5	PASS
Test Band	Test Mode	Test Channel	Test Temp.	Test Volt.	Freq.Error (Hz)	Freq.vs.rated (ppm)	Limit (ppm)	Verdict
WCDMA1 900	TM3	LCH	TN	VL	47.06	0.025404	±2.5	PASS
			TN	VN	98.82	0.053345	±2.5	PASS
			TN	VH	-7.51	-0.004053	±2.5	PASS
		MCH	TN	VL	-121.72	-0.064744	±2.5	PASS
			TN	VN	98.82	-0.051896	±2.5	PASS
			TN	VH	63.55	0.033805	±2.5	PASS
		HCH	TN	VL	91.22	0.047818	±2.5	PASS
			TN	VN	98.82	0.040123	±2.5	PASS
			TN	VH	-53.27	-0.027924	±2.5	PASS

Frequency Error vs. Temperature:

Test Band	Test Mode	Test Channel	Test Volt.	Test Temp	Freq.Error (Hz)	Freq.vs.rated (ppm)	Limit (ppm)	Verdict
WCDMA8 50	TM1	LCH	VN	-30	18.16	0.021972	±2.5	PASS
			VN	-20	-0.32	-0.000388	±2.5	PASS
			VN	-10	448.93	0.543234	±2.5	PASS
			VN	0	140.95	0.170553	±2.5	PASS
			VN	10	6.32	0.007644	±2.5	PASS
			VN	20	-10.27	-0.012426	±2.5	PASS
			VN	30	2.49	0.003010	±2.5	PASS
			VN	40	301.28	0.364575	±2.5	PASS
			VN	50	138.67	0.167802	±2.5	PASS
WCDMA8 50	TM1	MCH	VN	-30	594.10	0.710307	±2.5	PASS
			VN	-20	735.72	0.879624	±2.5	PASS
			VN	-10	879.93	1.052043	±2.5	PASS
			VN	0	713.24	0.852752	±2.5	PASS
			VN	10	725.10	0.866927	±2.5	PASS
			VN	20	286.71	0.342794	±2.5	PASS
			VN	30	1242.98	1.486108	±2.5	PASS
			VN	40	5.48	0.006549	±2.5	PASS
			VN	50	727.54	0.869846	±2.5	PASS
WCDMA8 50	TM1	HCH	VN	-30	-11.06	-0.013067	±2.5	PASS
			VN	-20	-3.68	-0.004344	±2.5	PASS
			VN	-10	6.01	0.007101	±2.5	PASS
			VN	0	3.17	0.003749	±2.5	PASS
			VN	10	8.71	0.010291	±2.5	PASS
			VN	20	13.43	0.015861	±2.5	PASS
			VN	30	-10.22	-0.012076	±2.5	PASS
			VN	40	-2.88	-0.003406	±2.5	PASS
			VN	50	-2.56	-0.003028	±2.5	PASS

Test Band	Test Mode	Test Channel	Test Volt.	Test Temp	Freq.Error (Hz)	Freq.vs.rated (ppm)	Limit (ppm)	Verdict
WCDMA8 50	TM1	LCH	VN	-30	18.16	0.021972	±2.5	PASS
			VN	-20	-0.32	-0.000388	±2.5	PASS
			VN	-10	448.93	0.543234	±2.5	PASS
			VN	0	140.95	0.170553	±2.5	PASS
			VN	10	6.32	0.007644	±2.5	PASS
			VN	20	-10.27	-0.012426	±2.5	PASS
			VN	30	2.49	0.003010	±2.5	PASS
			VN	40	301.28	0.364575	±2.5	PASS
			VN	50	138.67	0.167802	±2.5	PASS
WCDMA8 50	TM1	MCH	VN	-30	594.10	0.710307	±2.5	PASS
			VN	-20	735.72	0.879624	±2.5	PASS
			VN	-10	879.93	1.052043	±2.5	PASS
			VN	0	713.24	0.852752	±2.5	PASS
			VN	10	725.10	0.866927	±2.5	PASS
			VN	20	286.71	0.342794	±2.5	PASS
			VN	30	1242.98	1.486108	±2.5	PASS
			VN	40	5.48	0.006549	±2.5	PASS
			VN	50	727.54	0.869846	±2.5	PASS
WCDMA8 50	TM1	HCH	VN	-30	-11.06	-0.013067	±2.5	PASS
			VN	-20	-3.68	-0.004344	±2.5	PASS
			VN	-10	6.01	0.007101	±2.5	PASS
			VN	0	3.17	0.003749	±2.5	PASS
			VN	10	8.71	0.010291	±2.5	PASS
			VN	20	13.43	0.015861	±2.5	PASS
			VN	30	-10.22	-0.012076	±2.5	PASS
			VN	40	-2.88	-0.003406	±2.5	PASS
			VN	50	-2.56	-0.003028	±2.5	PASS
Test Band	Test Mode	Test Channel	Test Volt.	Test Temp	Freq.Error (Hz)	Freq.vs.rated (ppm)	Limit (ppm)	Verdict
WCDMA8 50	TM2	LCH	VN	-30	110.78	0.134050	±2.5	PASS
			VN	-20	47.93	0.057996	±2.5	PASS
			VN	-10	23.33	0.028232	±2.5	PASS
			VN	0	-53.56	-0.064809	±2.5	PASS
			VN	10	-64.22	-0.077716	±2.5	PASS

			VN	20	-21.59	-0.026127	±2.5	PASS
			VN	30	12.27	0.014845	±2.5	PASS
			VN	40	-138.29	-0.167341	±2.5	PASS
			VN	50	-22.22	-0.026884	±2.5	PASS
WCDMA8 50	TM2	MCH	VN	-30	-29.11	-0.034808	±2.5	PASS
			VN	-20	32.23	0.038530	±2.5	PASS
			VN	-10	-0.81	-0.000967	±2.5	PASS
			VN	0	6.84	0.008173	±2.5	PASS
			VN	10	-13.69	-0.016364	±2.5	PASS
			VN	20	51.96	0.062119	±2.5	PASS
			VN	30	-60.27	-0.072061	±2.5	PASS
			VN	40	76.71	0.091710	±2.5	PASS
			VN	50	99.93	0.119476	±2.5	PASS
WCDMA8 50	TM2	HCH	VN	-30	57.39	0.067787	±2.5	PASS
			VN	-20	-25.67	-0.030316	±2.5	PASS
			VN	-10	24.44	0.028874	±2.5	PASS
			VN	0	37.70	0.044536	±2.5	PASS
			VN	10	33.97	0.040121	±2.5	PASS
			VN	20	-4.71	-0.005569	±2.5	PASS
			VN	30	-44.28	-0.052305	±2.5	PASS
			VN	40	-1.33	-0.001568	±2.5	PASS
			VN	50	57.24	0.067607	±2.5	PASS
Test Band	Test Mode	Test Channel	Test Volt.	Test Temp	Freq.Error (Hz)	Freq.vs.rated (ppm)	Limit (ppm)	Verdict
WCDMA8 50	TM3	LCH	VN	-30	42.92	0.051940	±2.5	PASS
			VN	-20	77.39	0.093650	±2.5	PASS
			VN	-10	-64.99	-0.078639	±2.5	PASS
			VN	0	27.92	0.033789	±2.5	PASS
			VN	10	12.02	0.014550	±2.5	PASS
			VN	20	30.00	0.036301	±2.5	PASS
			VN	30	45.78	0.055393	±2.5	PASS
			VN	40	35.84	0.043372	±2.5	PASS
			VN	50	192.05	0.232390	±2.5	PASS
WCDMA8 50	TM3	MCH	VN	-30	22.61	0.027037	±2.5	PASS
			VN	-20	31.49	0.037654	±2.5	PASS
			VN	-10	32.29	0.038603	±2.5	PASS
			VN	0	72.78	0.087021	±2.5	PASS
			VN	10	-1.69	-0.002025	±2.5	PASS

WCDMA8 50	TM3	HCH	VN	20	21.97	0.026271	±2.5	PASS
			VN	30	92.97	0.111157	±2.5	PASS
			VN	40	92.29	0.110336	±2.5	PASS
			VN	50	87.43	0.104535	±2.5	PASS
			VN	-30	-48.00	-0.056702	±2.5	PASS
			VN	-20	18.91	0.022331	±2.5	PASS
			VN	-10	-43.33	-0.051187	±2.5	PASS
			VN	0	-71.09	-0.083972	±2.5	PASS
			VN	10	-28.29	-0.033416	±2.5	PASS
			VN	20	-31.88	-0.037651	±2.5	PASS
			VN	30	46.07	0.054413	±2.5	PASS
			VN	40	14.59	0.017231	±2.5	PASS
			VN	50	7.05	0.008327	±2.5	PASS

Test Band	Test Mode	Test Channel	Test Volt.	Test Temp	Freq.Error (Hz)	Freq.vs.rated (ppm)	Limit (ppm)	Verdict
WCDMA1 900	TM1	LCH	VN	-30	3.94	0.002125	±2.5	PASS
			VN	-20	19.56	0.010560	±2.5	PASS
			VN	-10	176.47	0.095264	±2.5	PASS
			VN	0	10.09	0.005445	±2.5	PASS
			VN	10	35.23	0.019020	±2.5	PASS
			VN	20	-0.08	-0.000041	±2.5	PASS
			VN	30	160.45	0.086615	±2.5	PASS
			VN	40	30.90	0.016681	±2.5	PASS
			VN	50	-2.59	-0.001400	±2.5	PASS
WCDMA1 900	TM1	MCH	VN	-30	-3.39	-0.001802	±2.5	PASS
			VN	-20	-8.44	-0.004488	±2.5	PASS
			VN	-10	-3.02	-0.001607	±2.5	PASS
			VN	0	-0.64	-0.000341	±2.5	PASS
			VN	10	-5.49	-0.002922	±2.5	PASS
			VN	20	-0.92	-0.000487	±2.5	PASS
			VN	30	1.57	0.000836	±2.5	PASS
			VN	40	-4.23	-0.002248	±2.5	PASS
			VN	50	-3.34	-0.001777	±2.5	PASS
WCDMA1 900	TM1	HCH	VN	-30	161.58	0.084701	±2.5	PASS
			VN	-20	463.03	0.242728	±2.5	PASS
			VN	-10	322.66	0.169146	±2.5	PASS
			VN	0	163.24	0.085573	±2.5	PASS

Test Band	Test Mode	Test Channel	Test Volt.	Test Temp	Freq.Error (Hz)	Freq.vs.rated (ppm)	Limit (ppm)	Verdict
			VN	10	-53.09	-0.027828	±2.5	PASS
			VN	20	293.40	0.153804	±2.5	PASS
			VN	30	511.58	0.268181	±2.5	PASS
			VN	40	-57.14	-0.029956	±2.5	PASS
			VN	50	304.06	0.159395	±2.5	PASS
WCDMA1 900	TM2	LCH	VN	-30	125.64	0.067826	±2.5	PASS
			VN	-20	-51.82	-0.027974	±2.5	PASS
			VN	-10	5.16	0.002784	±2.5	PASS
			VN	0	-33.04	-0.017834	±2.5	PASS
			VN	10	93.51	0.050478	±2.5	PASS
			VN	20	8.38	0.004522	±2.5	PASS
			VN	30	-55.65	-0.030041	±2.5	PASS
			VN	40	1.40	0.000758	±2.5	PASS
			VN	50	57.53	0.031055	±2.5	PASS
WCDMA1 900	TM2	MCH	VN	-30	36.25	0.019285	±2.5	PASS
			VN	-20	124.34	0.066140	±2.5	PASS
			VN	-10	-17.75	-0.009439	±2.5	PASS
			VN	0	6.88	0.003660	±2.5	PASS
			VN	10	-28.52	-0.015170	±2.5	PASS
			VN	20	85.60	0.045533	±2.5	PASS
			VN	30	-39.28	-0.020892	±2.5	PASS
			VN	40	40.42	0.021500	±2.5	PASS
			VN	50	113.91	0.060589	±2.5	PASS
WCDMA1 900	TM2	HCH	VN	-30	-42.74	-0.022405	±2.5	PASS
			VN	-20	86.23	0.045202	±2.5	PASS
			VN	-10	152.07	0.079717	±2.5	PASS
			VN	0	43.53	0.022821	±2.5	PASS
			VN	10	57.21	0.029988	±2.5	PASS
			VN	20	14.24	0.007463	±2.5	PASS
			VN	30	4.62	0.002424	±2.5	PASS
			VN	40	42.21	0.022125	±2.5	PASS
			VN	50	19.84	0.010399	±2.5	PASS

Test Band	Test Mode	Test Channel	Test Volt.	Test Temp	Freq.Error (Hz)	Freq.vs.rated (ppm)	Limit (ppm)	Verdict
WCDMA1 900	TM3	LCH	VN	-30	-17.96	-0.009695	±2.5	PASS
			VN	-20	40.22	0.021714	±2.5	PASS
			VN	-10	20.13	0.010865	±2.5	PASS
			VN	0	53.34	0.028798	±2.5	PASS
			VN	10	-19.00	-0.010255	±2.5	PASS
			VN	20	136.43	0.073650	±2.5	PASS
			VN	30	-13.49	-0.007282	±2.5	PASS
			VN	40	-143.78	-0.077620	±2.5	PASS
			VN	50	-78.05	-0.042134	±2.5	PASS
WCDMA1 900	TM3	MCH	VN	-30	-56.81	-0.030217	±2.5	PASS
			VN	-20	52.92	0.028148	±2.5	PASS
			VN	-10	13.72	0.007297	±2.5	PASS
			VN	0	72.46	0.038545	±2.5	PASS
			VN	10	2.59	0.001380	±2.5	PASS
			VN	20	23.25	0.012369	±2.5	PASS
			VN	30	91.28	0.048552	±2.5	PASS
			VN	40	-46.69	-0.024836	±2.5	PASS
			VN	50	135.54	0.072098	±2.5	PASS
WCDMA1 900	TM3	HCH	VN	-30	-53.21	-0.027892	±2.5	PASS
			VN	-20	7.74	0.004055	±2.5	PASS
			VN	-10	25.67	0.013454	±2.5	PASS
			VN	0	-23.96	-0.012558	±2.5	PASS
			VN	10	-26.50	-0.013894	±2.5	PASS
			VN	20	27.42	0.014374	±2.5	PASS
			VN	30	56.05	0.029380	±2.5	PASS
			VN	40	-29.07	-0.015238	±2.5	PASS
			VN	50	-5.98	-0.003136	±2.5	PASS

Appendix G): Effective Radiated Power of Transmitter (ERP/EIRP)

Receiver Setup:	<table border="1"> <thead> <tr> <th>Frequency</th> <th>Detector</th> <th>RBW</th> <th>VBW</th> <th>Remark</th> </tr> </thead> <tbody> <tr> <td>30MHz-1GHz</td> <td>peak</td> <td>120kHz</td> <td>300kHz</td> <td>Peak</td> </tr> <tr> <td>Above 1GHz</td> <td>Peak</td> <td>1MHz</td> <td>3MHz</td> <td>Peak</td> </tr> </tbody> </table>			Frequency	Detector	RBW	VBW	Remark	30MHz-1GHz	peak	120kHz	300kHz	Peak	Above 1GHz	Peak	1MHz	3MHz	Peak
Frequency	Detector	RBW	VBW	Remark														
30MHz-1GHz	peak	120kHz	300kHz	Peak														
Above 1GHz	Peak	1MHz	3MHz	Peak														
Measurement Procedure:	<p>Test procedure as below:</p> <ol style="list-style-type: none"> 1) The EUT was powered ON and placed on a 1.5m high table at a 3 meter fully Anechoic Chamber. The antenna of the transmitter was extended to its maximum length. modulation mode and the measuring receiver shall be tuned to the frequency of the transmitter under test. 2) The EUT was set 3 meters(above 18GHz the distance is 1 meter) away from the interference-receiving antenna, which was mounted on the top of a variable-height antenna tower. 3) The disturbance of the transmitter was maximized on the test receiver display by raising and lowering from 1m to 4m the receive antenna and by rotating through 360° the turntable. After the fundamental emission was maximized, a field strength measurement was made. 4) Steps 1) to 3) were performed with the EUT and the receive antenna in both vertical and horizontal polarization. 5) The transmitter was then removed and replaced with another antenna. The center of the antenna was approximately at the same location as the center of the transmitter. 6) A signal at the disturbance was fed to the substitution antenna by means of a non-radiating cable. With both the substitution and the receive antennas horizontally polarized, the receive antenna was raised and lowered to obtain a maximum reading at the test receiver. The level of the signal generator was adjusted until the measured field strength level in step 3) is obtained for this set of conditions. 7) The output power into the substitution antenna was then measured. 8) Steps 6) and 7) were repeated with both antennas polarized. 9) Calculate power in dBm by the following formula: $\text{ERP(dBm)} = \text{Pg(dBm)} - \text{cable loss (dB)} + \text{antenna gain (dBd)}$ $\text{EIRP(dBm)} = \text{Pg(dBm)} - \text{cable loss (dB)} + \text{antenna gain (dBi)}$ $\text{EIRP} = \text{ERP} + 2.15\text{dB}$ where: Pg is the generator output power into the substitution antenna. 10) Test the EUT in the lowest channel, the middle channel the Highest channel 11) The radiation measurements are performed in X, Y, Z axis positioning for EUT operation mode, And found the X axis positioning which it is worse case. 12) Repeat above procedures until all frequencies measured was complete. 																	
Limit:	<table border="1"> <thead> <tr> <th>Mode</th> <th>GSM 850/WCDMA/HSDPA /HSUPA Band V</th> <th>GSM 1900/WCDMA/HSDPA /HSUPA Band II</th> </tr> </thead> <tbody> <tr> <td>Frequency</td> <td>824 – 849MHz</td> <td>1850 – 1910MHz</td> </tr> <tr> <td>Limit</td> <td>38.45dBm (7W)</td> <td>33.01dBm (2W)</td> </tr> </tbody> </table>			Mode	GSM 850/WCDMA/HSDPA /HSUPA Band V	GSM 1900/WCDMA/HSDPA /HSUPA Band II	Frequency	824 – 849MHz	1850 – 1910MHz	Limit	38.45dBm (7W)	33.01dBm (2W)						
Mode	GSM 850/WCDMA/HSDPA /HSUPA Band V	GSM 1900/WCDMA/HSDPA /HSUPA Band II																
Frequency	824 – 849MHz	1850 – 1910MHz																
Limit	38.45dBm (7W)	33.01dBm (2W)																

GPRS 850							
Channel/fc (MHz)	Height (cm)	Azimuth (deg)	ERP (dBm)	Limit (dBm)	Over Limit (dB)	Result	Antenna Polaxis.
128/824.2	150	154	20.16	38.45	-18.29	Pass	H
	150	206	23.15	38.45	-15.30	Pass	V
190/836.6	150	223	20.64	38.45	-17.81	Pass	H
	150	127	23.47	38.45	-14.98	Pass	V
251/848.8	150	175	21.41	38.45	-17.04	Pass	H
	150	132	23.03	38.45	-15.42	Pass	V

EDGE 850							
Channel/fc (MHz)	Height (cm)	Azimuth (deg)	ERP (dBm)	Limit (dBm)	Over Limit (dB)	Result	Antenna Polaxis.
128/824.2	150	127	18.53	38.45	-19.92	Pass	H
	150	321	20.75	38.45	-17.70	Pass	V
190/836.6	150	185	20.24	38.45	-18.21	Pass	H
	150	175	22.33	38.45	-16.12	Pass	V
251/848.8	150	215	18.35	38.45	-20.10	Pass	H
	150	174	22.12	38.45	-16.33	Pass	V

WCDMA band V							
Channel/fc (MHz)	Height (cm)	Azimuth (deg)	ERP (dBm)	Limit (dBm)	Over Limit (dB)	Result	Antenna Polaxis.
4132/ 826.4	150	198	15.67	38.45	-22.78	Pass	H
	150	125	18.52	38.45	-19.93	Pass	V
4182/ 836.6	150	115	14.55	38.45	-23.90	Pass	H
	150	219	16.76	38.45	-21.69	Pass	V
4233/ 846.6	150	154	16.24	38.45	-22.21	Pass	H
	150	211	18.58	38.45	-19.87	Pass	V

HSDPA band V							
Channel/fc (MHz)	Height (cm)	Azimuth (deg)	ERP (dBm)	Limit (dBm)	Over Limit (dB)	Result	Antenna Polaxis.
4132/826.4	150	137	16.16	38.45	-22.29	Pass	H
	150	158	17.34	38.45	-21.11	Pass	V
4182/836.6	150	158	14.57	38.45	-23.88	Pass	H
	150	145	16.53	38.45	-21.92	Pass	V
4233/846.6	150	245	16.18	38.45	-22.27	Pass	H
	150	167	17.56	38.45	-20.89	Pass	V

HSUPA band V							
Channel/fc (MHz)	Height (cm)	Azimuth (deg)	ERP (dBm)	Limit (dBm)	Over Limit (dB)	Result	Antenna Polaxis.
4132/826.4	150	184	15.08	38.45	-23.37	Pass	H
	150	197	16.76	38.45	-21.69	Pass	V
4182/836.6	150	125	15.33	38.45	-23.12	Pass	H
	150	113	17.57	38.45	-20.88	Pass	V
4233/846.6	150	251	16.02	38.45	-22.43	Pass	H
	150	174	17.85	38.45	-20.60	Pass	V

GPRS 1900							
Channel/fc (MHz)	Height (cm)	Azimuth (deg)	EIRP (dBm)	Limit (dBm)	Over Limit (dB)	Result	Antenna Polaxis.
512/1850.2	150	211	22.27	33.01	-10.74	Pass	H
	150	130	24.39	33.01	-8.62	Pass	V
661/1880.0	150	150	22.17	33.01	-10.84	Pass	H
	150	163	23.52	33.01	-9.49	Pass	V
810/1909.8	150	174	20.62	33.01	-12.39	Pass	H
	150	179	23.41	33.01	-9.60	Pass	V

EDGE1900							
Channel/fc (MHz)	Height (cm)	Azimuth (deg)	EIRP (dBm)	Limit (dBm)	Over Limit (dB)	Result	Antenna Polaxis.
512/1850.2	150	315	19.78	33.01	-13.23	Pass	H
	150	237	21.16	33.01	-11.85	Pass	V
661/1880.0	150	252	19.77	33.01	-13.24	Pass	H
	150	219	22.19	33.01	-10.82	Pass	V
810/1909.8	150	251	18.27	33.01	-14.74	Pass	H
	150	320	20.57	33.01	-12.44	Pass	V

WCDMA band II							
Channel/fc (MHz)	Height (cm)	Azimuth (deg)	EIRP (dBm)	Limit (dBm)	Over Limit (dB)	Result	Antenna Polaxis.
9262/1852.4	150	153	16.74	33.01	-16.27	Pass	H
	150	133	18.96	33.01	-14.05	Pass	V
9400/1880.0	150	135	14.51	33.01	-18.50	Pass	H
	150	126	17.27	33.01	-15.74	Pass	V
9538/1907.6	150	352	15.12	33.01	-17.89	Pass	H
	150	173	16.33	33.01	-16.68	Pass	V

HSDPA band II							
Channel/fc (MHz)	Height (cm)	Azimuth (deg)	ERP (dBm)	Limit (dBm)	Over Limit (dB)	Result	Antenna Polaxis.
9262/1852.4	150	285	15.34	33.01	-17.67	Pass	H
	150	158	16.52	33.01	-16.49	Pass	V
9400/1880.0	150	135	16.21	33.01	-16.80	Pass	H
	150	127	17.53	33.01	-15.48	Pass	V
9538/1907.6	150	114	15.75	33.01	-17.26	Pass	H
	150	127	17.38	33.01	-15.63	Pass	V

HSUPA band II							
Channel/fc (MHz)	Height (cm)	Azimuth (deg)	ERP (dBm)	Limit (dBm)	Over Limit (dB)	Result	Antenna Polaxis.
9262/1852.4	150	242	14.41	33.01	-18.60	Pass	H
	150	255	15.73	33.01	-17.28	Pass	V
9400/1880.0	150	114	15.47	33.01	-17.54	Pass	H
	150	341	17.33	33.01	-15.68	Pass	V
9538/1907.6	150	233	15.44	33.01	-17.57	Pass	H
	150	254	16.46	33.01	-16.55	Pass	V

Appendix H): Field strength of spurious radiation

Receiver Setup:	Frequency	Detector	RBW	VBW	Remark
	0.009MHz-30MHz	Peak	10kHz	30kHz	Peak
	30MHz-1GHz	Peak	120kHz	300kHz	Peak
	Above 1GHz	Peak	1MHz	3MHz	Peak
Measurement Procedure:	<p>1. Scan up to 10th harmonic, find the maximum radiation frequency to measure.</p> <p>2. The technique used to find the Spurious Emissions of the transmitter was the antenna substitution method. Substitution method was performed to determine the actual ERP/EIRP emission levels of the EUT.</p> <p>Test procedure as below:</p> <ol style="list-style-type: none"> The EUT was powered ON and placed on a 1.5m high table at a 3 meter fully Anechoic Chamber. The antenna of the transmitter was extended to its maximum length. modulation mode and the measuring receiver shall be tuned to the frequency of the transmitter under test. The EUT was set 3 meters(above 18GHz the distance is 1 meter) away from the interference-receiving antenna, which was mounted on the top of a variable-height antenna tower. The disturbance of the transmitter was maximized on the test receiver display by raising and lowering from 1m to 4m the receive antenna and by rotating through 360° the turntable. After the fundamental emission was maximized, a field strength measurement was made. Steps 1) to 3) were performed with the EUT and the receive antenna in both vertical and horizontal polarization. The transmitter was then removed and replaced with another antenna. The center of the antenna was approximately at the same location as the center of the transmitter. A signal at the disturbance was fed to the substitution antenna by means of a non-radiating cable. With both the substitution and the receive antennas horizontally polarized, the receive antenna was raised and lowered to obtain a maximum reading at the test receiver. The level of the signal generator was adjusted until the measured field strength level in step 3) is obtained for this set of conditions. The output power into the substitution antenna was then measured. Steps 6) and 7) were repeated with both antennas polarized. Calculate power in dBm by the following formula: $\text{ERP(dBm)} = \text{Pg(dBm)} - \text{cable loss (dB)} + \text{antenna gain (dB)}$ $\text{EIRP(dBm)} = \text{Pg(dBm)} - \text{cable loss (dB)} + \text{antenna gain (dBi)}$ $\text{EIRP} = \text{ERP} + 2.15\text{dB}$ where: Pg is the generator output power into the substitution antenna. Test the EUT in the lowest channel, the middle channel the Highest channel The radiation measurements are performed in X, Y, Z axis positioning for EUT operation mode, And found the X axis positioning which it is worse case. Repeat above procedures until all frequencies measured was complete. 				
Limit:	Attenuated at least 43+10log(P)				

GPRS 850 128channel/824.2MHz(lowest channel)							
Frequency (MHz)	Height (cm)	Azimuth (deg)	Spurious Emission Level (dBm)	Limit (dBm)	Over Limit (dB)	Result	Antenna Polaxis.
1668.044	149	14	-53.93	-13.00	-40.93	Pass	H
2065.715	150	124	-56.61	-13.00	-43.61	Pass	H
2610.823	150	360	-57.83	-13.00	-44.83	Pass	H
3644.175	150	359	-57.92	-13.00	-44.92	Pass	H
4712.547	151	147	-56.89	-13.00	-43.89	Pass	H
6187.929	150	124	-51.78	-13.00	-38.78	Pass	H
1668.044	152	78	-52.81	-13.00	-39.81	Pass	V
2065.715	150	99	-55.75	-13.00	-42.75	Pass	V
2468.631	150	147	-56.95	-13.00	-43.95	Pass	V
3738.129	149	154	-57.46	-13.00	-44.46	Pass	V
6203.700	150	167	-51.98	-13.00	-38.98	Pass	V
7282.792	150	347	-46.27	-13.00	-33.27	Pass	V

GPRS 850 190channel/836.6MHz(middle channel)							
Frequency (MHz)	Height (cm)	Azimuth (deg)	Spurious Emission Level (dBm)	Limit (dBm)	Over Limit (dB)	Result	Antenna Polaxis.
1668.044	151	226	-52.66	-13.00	-39.66	Pass	H
2018.928	150	21	-55.54	-13.00	-42.54	Pass	H
2590.961	150	360	-56.81	-13.00	-43.81	Pass	H
3561.636	152	70	-56.97	-13.00	-43.97	Pass	H
5836.044	150	148	-51.56	-13.00	-38.56	Pass	H
6730.187	149	97	-51.88	-13.00	-38.88	Pass	H
1668.044	149	27	-52.14	-13.00	-39.14	Pass	V
2050.000	150	100	-55.67	-13.00	-42.67	Pass	V
2691.804	151	359	-57.23	-13.00	-44.23	Pass	V
3738.129	150	20	-57.51	-13.00	-44.51	Pass	V
5940.967	150	147	-51.32	-13.00	-38.32	Pass	V
9611.663	150	100	-47.23	-13.00	-34.23	Pass	V

GPRS 850 251channel/848.8MHz(highest channel)							
Frequency (MHz)	Height (cm)	Azimuth (deg)	Spurious Emission Level (dBm)	Limit (dBm)	Over Limit (dB)	Result	Antenna Polaxis.
1668.044	151	351	-52.25	-13.00	-39.25	Pass	H
1973.201	150	200	-55.11	-13.00	-42.11	Pass	H
2584.374	149	316	-57.27	-13.00	-44.27	Pass	H
3672.110	149	100	-58.41	-13.00	-45.41	Pass	H
5865.832	150	79	-52.49	-13.00	-39.49	Pass	H
7081.697	151	10	-54.00	-13.00	-41.00	Pass	H
1668.044	150	47	-52.54	-13.00	-39.54	Pass	V
2024.074	150	100	-55.80	-13.00	-42.80	Pass	V
2957.654	149	360	-57.23	-13.00	-44.23	Pass	V
3216.838	149	70	-57.34	-13.00	-44.34	Pass	V
5880.782	150	27	-51.39	-13.00	-38.39	Pass	V
6764.538	152	210	-52.12	-13.00	-39.12	Pass	V

EGPRS 850 128channel/824.2MHz(lowest channel)							
Frequency (MHz)	Height (cm)	Azimuth (deg)	Spurious Emission Level (dBm)	Limit (dBm)	Over Limit (dB)	Result	Antenna Polaxis.
1668.044	149	356	-53.58	-13.00	-40.58	Pass	H
1889.633	150	147	-55.81	-13.00	-42.81	Pass	H
2506.624	151	97	-57.02	-13.00	-44.02	Pass	H
3757.208	150	100	-57.46	-13.00	-44.46	Pass	H
5850.919	151	110	-51.78	-13.00	-38.78	Pass	H
7009.956	149	57	-52.23	-13.00	-39.23	Pass	H
1663.803	150	248	-53.11	-13.00	-40.11	Pass	V
2394.363	150	220	-57.36	-13.00	-44.36	Pass	V
2726.283	149	10	-58.27	-13.00	-45.27	Pass	V
4170.530	151	100	-57.74	-13.00	-44.74	Pass	V
5325.007	150	38	-54.83	-13.00	-41.83	Pass	V
6172.197	150	360	-51.52	-13.00	-38.52	Pass	V

EGPRS 850 190channel/836.6MHz(middle channel)							
Frequency (MHz)	Height (cm)	Azimuth (deg)	Spurious Emission Level (dBm)	Limit (dBm)	Over Limit (dB)	Result	Antenna Polaxis.
1668.044	151	352	-52.36	-13.00	-39.36	Pass	H
2044.788	150	167	-56.69	-13.00	-43.69	Pass	H
2513.013	149	91	-57.24	-13.00	-44.24	Pass	H
3283.018	150	211	-57.61	-13.00	-44.61	Pass	H
4712.547	151	100	-57.76	-13.00	-44.76	Pass	H
7009.956	151	360	-51.99	-13.00	-38.99	Pass	H
1668.044	150	79	-53.58	-13.00	-40.58	Pass	V
1938.352	150	70	-56.57	-13.00	-43.57	Pass	V
2352.076	149	254	-57.19	-13.00	-44.19	Pass	V
3738.129	149	100	-58.56	-13.00	-45.56	Pass	V
5732.974	150	10	-53.13	-13.00	-40.13	Pass	V
6235.364	150	78	-52.53	-13.00	-39.53	Pass	V

EGPRS 850 251channel/848.8MHz(highest channel)							
Frequency (MHz)	Height (cm)	Azimuth (deg)	Spurious Emission Level (dBm)	Limit (dBm)	Over Limit (dB)	Result	Antenna Polaxis.
1668.044	151	331	-53.94	-13.00	-40.94	Pass	H
2400.466	150	100	-56.38	-13.00	-43.38	Pass	H
3672.110	150	261	-57.17	-13.00	-44.17	Pass	H
5311.469	149	20	-54.40	-13.00	-41.40	Pass	H
5956.109	150	31	-52.15	-13.00	-39.15	Pass	H
6851.185	150	200	-53.82	-13.00	-40.82	Pass	H
1668.044	150	37	-52.75	-13.00	-39.75	Pass	V
2097.507	151	100	-55.76	-13.00	-42.76	Pass	V
2584.374	150	69	-57.28	-13.00	-44.28	Pass	V
3728.625	152	147	-57.05	-13.00	-44.05	Pass	V
5689.360	150	100	-51.46	-13.00	-38.46	Pass	V
7154.172	150	359	-53.20	-13.00	-40.20	Pass	V

GPRS1900 512channel/1850.2MHz(lowest channel)							
Frequency (MHz)	Height (cm)	Azimuth (deg)	Spurious Emission Level (dBm)	Limit (dBm)	Over Limit (dB)	Result	Antenna Polaxis.
1506.563	151	360	-58.51	-13.00	-45.51	Pass	H
2118.973	150	121	-55.98	-13.00	-42.98	Pass	H
2854.107	150	110	-58.08	-13.00	-45.08	Pass	H
3653.463	150	11	-57.51	-13.00	-44.51	Pass	H
4712.547	150	169	-56.30	-13.00	-43.30	Pass	H
5956.109	149	64	-51.22	-13.00	-38.22	Pass	H
1479.955	150	278	-58.28	-13.00	-45.28	Pass	V
2097.507	151	200	-55.65	-13.00	-42.65	Pass	V
2664.535	150	220	-56.43	-13.00	-43.43	Pass	V
3672.110	152	360	-57.03	-13.00	-44.03	Pass	V
5257.662	149	359	-54.62	-13.00	-41.62	Pass	V
6267.190	150	341	-51.42	-13.00	-38.42	Pass	V

GPRS1900 661channel/1880MHz(middle channel)							
Frequency (MHz)	Height (cm)	Azimuth (deg)	Spurious Emission Level (dBm)	Limit (dBm)	Over Limit (dB)	Result	Antenna Polaxis.
1533.648	151	39	-58.65	-13.00	-45.65	Pass	H
2229.645	150	360	-57.34	-13.00	-44.34	Pass	H
2980.327	150	70	-58.67	-13.00	-45.67	Pass	H
3662.775	149	61	-58.56	-13.00	-45.56	Pass	H
5204.399	150	359	-55.60	-13.00	-42.60	Pass	H
6299.178	151	241	-52.62	-13.00	-39.62	Pass	H
1533.648	150	289	-58.23	-13.00	-45.23	Pass	V
2092.175	150	10	-56.66	-13.00	-43.66	Pass	V
3104.217	151	100	-57.91	-13.00	-44.91	Pass	V
3672.110	150	110	-57.55	-13.00	-44.55	Pass	V
5311.469	149	79	-54.15	-13.00	-41.15	Pass	V
7135.984	152	64	-52.08	-13.00	-39.08	Pass	V

GPRS1900 810channel/1909.8MHz(highest channel)							
Frequency (MHz)	Height (cm)	Azimuth (deg)	Spurious Emission Level (dBm)	Limit (dBm)	Over Limit (dB)	Result	Antenna Polaxis.
1597.401	151	79	-57.84	-13.00	-44.84	Pass	H
2151.585	149	146	-57.00	-13.00	-44.00	Pass	H
2832.394	150	100	-59.01	-13.00	-46.01	Pass	H
3644.175	150	255	-58.67	-13.00	-45.67	Pass	H
5151.676	151	10	-56.95	-13.00	-43.95	Pass	H
6267.190	150	360	-51.72	-13.00	-38.72	Pass	H
1498.912	150	79	-58.34	-13.00	-45.34	Pass	V
1993.395	150	51	-55.73	-13.00	-42.73	Pass	V
2854.107	152	200	-58.11	-13.00	-45.11	Pass	V
3690.853	150	249	-56.49	-13.00	-43.49	Pass	V
5518.199	149	78	-54.57	-13.00	-41.57	Pass	V
6851.185	150	100	-53.24	-13.00	-40.24	Pass	V

EGPRS 1900 512channel/1850.2MHz(lowest channel)							
Frequency (MHz)	Height (cm)	Azimuth (deg)	Spurious Emission Level (dBm)	Limit (dBm)	Over Limit (dB)	Result	Antenna Polaxis.
1549.344	151	10	-58.30	-13.00	-45.30	Pass	H
2275.515	150	179	-55.33	-13.00	-42.33	Pass	H
2905.419	150	141	-57.76	-13.00	-44.76	Pass	H
3672.110	152	200	-57.58	-13.00	-44.58	Pass	H
5776.922	150	201	-51.20	-13.00	-38.20	Pass	H
7099.747	150	360	-52.53	-13.00	-39.53	Pass	H
1518.111	150	70	-57.43	-13.00	-44.43	Pass	V
2092.175	149	89	-55.37	-13.00	-42.37	Pass	V
3208.660	149	100	-57.00	-13.00	-44.00	Pass	V
4676.696	151	211	-56.34	-13.00	-43.34	Pass	V
5791.646	150	64	-50.01	-13.00	-37.01	Pass	V
7209.015	150	278	-47.19	-13.00	-34.19	Pass	V

EGPRS 1900 661channel/1880MHz(middle channel)							
Frequency (MHz)	Height (cm)	Azimuth (deg)	Spurious Emission Level (dBm)	Limit (dBm)	Over Limit (dB)	Result	Antenna Polaxis.
1597.401	151	81	-56.57	-13.00	-43.57	Pass	H
2140.659	150	64	-56.55	-13.00	-43.55	Pass	H
3135.986	150	79	-57.10	-13.00	-44.10	Pass	H
4107.316	150	100	-57.69	-13.00	-44.69	Pass	H
6315.233	152	360	-50.91	-13.00	-37.91	Pass	H
7981.717	150	70	-54.24	-13.00	-41.24	Pass	H
1498.912	150	10	-57.40	-13.00	-44.40	Pass	V
2140.659	150	61	-55.78	-13.00	-42.78	Pass	V
2796.573	149	104	-57.89	-13.00	-44.89	Pass	V
3786.010	149	110	-57.39	-13.00	-44.39	Pass	V
5986.509	150	101	-51.34	-13.00	-38.34	Pass	V
7081.697	150	360	-53.42	-13.00	-40.42	Pass	V

EGPRS 1900 810channel/1909.8MHz(highest channel)							
Frequency (MHz)	Height (cm)	Azimuth (deg)	Spurious Emission Level (dBm)	Limit (dBm)	Over Limit (dB)	Result	Antenna Polaxis.
1597.401	151	316	-56.41	-13.00	-43.41	Pass	H
2018.928	150	70	-55.47	-13.00	-42.47	Pass	H
2532.277	152	81	-56.95	-13.00	-43.95	Pass	H
3176.155	150	226	-58.05	-13.00	-45.05	Pass	H
4245.509	149	210	-57.78	-13.00	-44.78	Pass	H
5895.771	150	101	-51.63	-13.00	-38.63	Pass	H
1439.090	150	79	-58.34	-13.00	-45.34	Pass	V
2102.853	151	100	-55.88	-13.00	-42.88	Pass	V
3080.601	151	360	-58.15	-13.00	-45.15	Pass	V
4676.696	150	70	-56.69	-13.00	-43.69	Pass	V
6017.064	149	89	-51.68	-13.00	-38.68	Pass	V
7961.425	150	100	-53.81	-13.00	-40.81	Pass	V

WCDMA band V 4132 channel/826.4MHz(lowest channel)							
Frequency (MHz)	Height (cm)	Azimuth (deg)	Spurious Emission Level (dBm)	Limit (dBm)	Over Limit (dB)	Result	Antenna Polaxis.
1651.146	151	38	-50.50	-13.00	-37.50	Pass	H
2008.676	150	161	-56.31	-13.00	-43.31	Pass	H
2610.823	150	79	-58.58	-13.00	-45.58	Pass	H
3786.010	149	271	-57.96	-13.00	-44.96	Pass	H
5910.798	149	345	-52.45	-13.00	-39.45	Pass	H
7489.599	150	161	-55.06	-13.00	-42.06	Pass	H
1651.146	150	332	-49.31	-13.00	-36.31	Pass	V
2223.977	151	100	-56.68	-13.00	-43.68	Pass	V
3104.217	152	147	-59.11	-13.00	-46.11	Pass	V
4191.816	150	10	-57.60	-13.00	-44.60	Pass	V
5865.832	151	360	-52.47	-13.00	-39.47	Pass	V
7663.165	150	14	-53.86	-13.00	-40.86	Pass	V

WCDMA band V 4182 channel/836.4MHz(middle channel)							
Frequency (MHz)	Height (cm)	Azimuth (deg)	Spurious Emission Level (dBm)	Limit (dBm)	Over Limit (dB)	Result	Antenna Polaxis.
1655.354	151	352	-45.34	-13.00	-32.34	Pass	H
2065.715	150	164	-55.17	-13.00	-42.17	Pass	H
2597.564	150	79	-56.97	-13.00	-43.97	Pass	H
3552.582	152	100	-57.60	-13.00	-44.60	Pass	H
4688.616	150	258	-56.33	-13.00	-43.33	Pass	H
6235.364	150	76	-50.73	-13.00	-37.73	Pass	H
1668.044	149	360	-51.64	-13.00	-38.64	Pass	V
2263.960	150	124	-56.13	-13.00	-43.13	Pass	V
2839.613	149	10	-57.13	-13.00	-44.13	Pass	V
3552.582	150	360	-57.22	-13.00	-44.22	Pass	V
5895.771	150	70	-51.99	-13.00	-38.99	Pass	V
7099.747	150	281	-53.19	-13.00	-40.19	Pass	V

WCDMA band V 4233 channel/846.6MHz(highest channel)							
Frequency (MHz)	Height (cm)	Azimuth (deg)	Spurious Emission Level (dBm)	Limit (dBm)	Over Limit (dB)	Result	Antenna Polaxis.
1689.410	151	332	-49.99	-13.00	-36.99	Pass	H
2179.145	150	161	-55.83	-13.00	-42.83	Pass	H
2861.381	151	316	-58.36	-13.00	-45.36	Pass	H
3786.010	150	100	-57.18	-13.00	-44.18	Pass	H
5762.235	150	24	-53.03	-13.00	-40.03	Pass	H
7820.819	150	144	-53.11	-13.00	-40.11	Pass	H
1689.410	149	179	-49.94	-13.00	-36.94	Pass	V
2092.175	150	10	-55.10	-13.00	-42.10	Pass	V
2775.298	152	46	-57.12	-13.00	-44.12	Pass	V
3653.463	151	147	-57.78	-13.00	-44.78	Pass	V
5865.832	150	100	-51.76	-13.00	-38.76	Pass	V
7820.819	150	50	-53.80	-13.00	-40.80	Pass	V

HSDPA band V 4132 channel/826.4MHz(lowest channel)							
Frequency (MHz)	Height (cm)	Azimuth (deg)	Spurious Emission Level (dBm)	Limit (dBm)	Over Limit (dB)	Result	Antenna Polaxis.
1651.146	151	159	-49.90	-13.00	-36.90	Pass	H
2168.079	152	170	-56.46	-13.00	-43.46	Pass	H
3192.366	150	160	-58.82	-13.00	-45.82	Pass	H
4107.316	150	100	-57.92	-13.00	-44.92	Pass	H
5674.896	149	360	-53.17	-13.00	-40.17	Pass	H
7135.984	150	79	-52.71	-13.00	-39.71	Pass	H
1651.146	150	247	-49.39	-13.00	-36.39	Pass	V
2195.850	149	220	-57.72	-13.00	-44.72	Pass	V
3088.453	150	200	-56.99	-13.00	-43.99	Pass	V
4688.616	151	21	-57.49	-13.00	-44.49	Pass	V
6251.257	149	156	-52.53	-13.00	-39.53	Pass	V
7961.425	150	100	-55.10	-13.00	-42.10	Pass	V

HSDPA band V 4182 channel/836.4MHz(middle channel)							
Frequency (MHz)	Height (cm)	Azimuth (deg)	Spurious Emission Level (dBm)	Limit (dBm)	Over Limit (dB)	Result	Antenna Polaxis.
1668.044	151	39	-49.02	-13.00	-36.02	Pass	H
2124.374	152	161	-56.46	-13.00	-43.46	Pass	H
2854.107	150	78	-57.32	-13.00	-44.32	Pass	H
3700.260	150	351	-58.43	-13.00	-45.43	Pass	H
5060.693	150	349	-56.06	-13.00	-43.06	Pass	H
6816.394	151	217	-52.83	-13.00	-39.83	Pass	H
1668.044	150	100	-47.65	-13.00	-34.65	Pass	V
2513.013	150	145	-53.69	-13.00	-40.69	Pass	V
3719.146	149	360	-57.40	-13.00	-44.40	Pass	V
5230.963	149	54	-53.42	-13.00	-40.42	Pass	V
6299.178	150	100	-51.76	-13.00	-38.76	Pass	V
7585.533	150	246	-53.67	-13.00	-40.67	Pass	V

HSDPA band V 4233channel/846.6MHz(highest channel)							
Frequency (MHz)	Height (cm)	Azimuth (deg)	Spurious Emission Level (dBm)	Limit (dBm)	Over Limit (dB)	Result	Antenna Polaxis.
1689.410	151	326	-46.38	-13.00	-33.38	Pass	H
2102.853	150	100	-56.06	-13.00	-43.06	Pass	H
2754.185	150	172	-58.37	-13.00	-45.37	Pass	H
3662.775	149	98	-58.25	-13.00	-45.25	Pass	H
5244.295	150	47	-54.54	-13.00	-41.54	Pass	H
6747.341	150	100	-53.33	-13.00	-40.33	Pass	H
1689.410	150	284	-49.63	-13.00	-36.63	Pass	V
2113.586	151	100	-55.30	-13.00	-42.30	Pass	V
2839.613	150	61	-57.77	-13.00	-44.77	Pass	V
4202.500	149	360	-57.49	-13.00	-44.49	Pass	V
5910.798	150	79	-51.34	-13.00	-38.34	Pass	V
7663.165	150	56	-52.96	-13.00	-39.96	Pass	V

HSUPA band V 4132 channel/826.4MHz(lowest channel)							
Frequency (MHz)	Height (cm)	Azimuth (deg)	Spurious Emission Level (dBm)	Limit (dBm)	Over Limit (dB)	Result	Antenna Polaxis.
1651.146	152	229	-50.84	-13.00	-37.84	Pass	H
2481.231	152	170	-56.32	-13.00	-43.32	Pass	H
3672.110	150	80	-55.99	-13.00	-42.99	Pass	H
4785.075	150	100	-56.14	-13.00	-43.14	Pass	H
5836.044	149	36	-52.13	-13.00	-39.13	Pass	H
7663.165	150	79	-53.90	-13.00	-40.90	Pass	H
1651.146	150	332	-48.36	-13.00	-35.36	Pass	V
2481.231	152	220	-56.51	-13.00	-43.51	Pass	V
3463.291	150	88	-59.17	-13.00	-46.17	Pass	V
4712.547	152	21	-56.77	-13.00	-43.77	Pass	V
6331.329	149	156	-52.74	-13.00	-39.74	Pass	V
7820.819	150	109	-54.93	-13.00	-41.93	Pass	V

HSUPA band V 4182 channel/836.4MHz(middle channel)							
Frequency (MHz)	Height (cm)	Azimuth (deg)	Spurious Emission Level (dBm)	Limit (dBm)	Over Limit (dB)	Result	Antenna Polaxis.
1668.044	150	55	-49.50	-13.00	-36.50	Pass	H
2118.973	152	192	-56.80	-13.00	-43.80	Pass	H
2617.477	150	78	-57.60	-13.00	-44.60	Pass	H
3672.110	150	351	-58.47	-13.00	-45.47	Pass	H
4724.558	150	169	-55.95	-13.00	-42.95	Pass	H
5880.782	151	217	-50.70	-13.00	-37.70	Pass	H
1668.044	150	158	-49.79	-13.00	-36.79	Pass	V
2102.853	152	145	-55.70	-13.00	-42.70	Pass	V
2712.439	149	226	-57.31	-13.00	-44.31	Pass	V
3662.775	149	54	-57.73	-13.00	-44.73	Pass	V
5047.827	150	100	-56.19	-13.00	-43.19	Pass	V
5956.109	150	33	-51.67	-13.00	-38.67	Pass	V

HSUPA band V 4233channel/846.6MHz(highest channel)							
Frequency (MHz)	Height (cm)	Azimuth (deg)	Spurious Emission Level (dBm)	Limit (dBm)	Over Limit (dB)	Result	Antenna Polaxis.
1689.410	152	86	-46.70	-13.00	-33.70	Pass	H
2538.731	149	226	-55.85	-13.00	-42.85	Pass	H
3653.463	150	172	-58.13	-13.00	-45.13	Pass	H
5257.662	149	98	-55.46	-13.00	-42.46	Pass	H
6544.350	150	99	-53.34	-13.00	-40.34	Pass	H
7941.185	150	100	-55.62	-13.00	-42.62	Pass	H
1693.716	150	332	-49.81	-13.00	-36.81	Pass	V
2538.731	151	100	-54.08	-13.00	-41.08	Pass	V
3672.110	151	89	-57.10	-13.00	-44.10	Pass	V
4676.696	149	360	-56.59	-13.00	-43.59	Pass	V
5674.896	150	79	-52.51	-13.00	-39.51	Pass	V
6799.064	150	10	-52.04	-13.00	-39.04	Pass	V

WCDMA band II 9262 channel/1852.4MHz(lowest channel)							
Frequency (MHz)	Height (cm)	Azimuth (deg)	Spurious Emission Level (dBm)	Limit (dBm)	Over Limit (dB)	Result	Antenna Polaxis.
1668.044	151	351	-53.86	-13.00	-40.86	Pass	H
2263.960	150	200	-56.64	-13.00	-43.64	Pass	H
3088.453	150	217	-56.45	-13.00	-43.45	Pass	H
4594.102	151	96	-56.84	-13.00	-43.84	Pass	H
5986.509	150	100	-51.40	-13.00	-38.40	Pass	H
7961.425	149	351	-53.55	-13.00	-40.55	Pass	H
1565.200	150	70	-58.09	-13.00	-45.09	Pass	V
2201.447	150	151	-57.18	-13.00	-44.18	Pass	V
3128.013	150	100	-57.74	-13.00	-44.74	Pass	V
4128.280	149	21	-58.68	-13.00	-45.68	Pass	V
5940.967	149	10	-52.63	-13.00	-39.63	Pass	V
7961.425	150	360	-54.53	-13.00	-41.53	Pass	V

WCDMA band II 9400 channel/1880MHz(middle channel)							
Frequency (MHz)	Height (cm)	Azimuth (deg)	Spurious Emission Level (dBm)	Limit (dBm)	Over Limit (dB)	Result	Antenna Polaxis.
1533.648	151	91	-57.69	-13.00	-44.69	Pass	H
2449.851	150	100	-55.76	-13.00	-42.76	Pass	H
3128.013	150	360	-57.76	-13.00	-44.76	Pass	H
4107.316	149	351	-57.90	-13.00	-44.90	Pass	H
5762.235	150	359	-51.08	-13.00	-38.08	Pass	H
7941.185	150	240	-54.05	-13.00	-41.05	Pass	H
1668.044	150	100	-52.24	-13.00	-39.24	Pass	V
2425.032	151	248	-57.08	-13.00	-44.08	Pass	V
3653.463	150	358	-57.87	-13.00	-44.87	Pass	V
5546.364	151	70	-52.84	-13.00	-39.84	Pass	V
6851.185	150	154	-52.50	-13.00	-39.50	Pass	V
9834.406	150	100	-51.79	-13.00	-38.79	Pass	V

WCDMA band II 9538 channel/1907.6MHz(highest channel)							
Frequency (MHz)	Height (cm)	Azimuth (deg)	Spurious Emission Level (dBm)	Limit (dBm)	Over Limit (dB)	Result	Antenna Polaxis.
1597.401	151	331	-58.15	-13.00	-45.15	Pass	H
2346.097	150	100	-56.51	-13.00	-43.51	Pass	H
3249.760	150	147	-58.84	-13.00	-45.84	Pass	H
4664.807	149	154	-57.72	-13.00	-44.72	Pass	H
5971.290	150	121	-52.04	-13.00	-39.04	Pass	H
7981.717	150	76	-54.71	-13.00	-41.71	Pass	H
1668.044	149	49	-54.39	-13.00	-41.39	Pass	V
2456.095	150	100	-56.75	-13.00	-43.75	Pass	V
3258.042	151	67	-58.07	-13.00	-45.07	Pass	V
4676.696	150	100	-56.09	-13.00	-43.09	Pass	V
5762.235	151	360	-51.79	-13.00	-38.79	Pass	V
7099.747	150	40	-53.57	-13.00	-40.57	Pass	V

HSDPA band II 9262 channel/1852.4MHz(lowest channel)							
Frequency (MHz)	Height (cm)	Azimuth (deg)	Spurious Emission Level (dBm)	Limit (dBm)	Over Limit (dB)	Result	Antenna Polaxis.
1668.044	151	61	-54.93	-13.00	-41.93	Pass	H
2328.249	150	200	-57.83	-13.00	-44.83	Pass	H
3672.110	150	157	-58.53	-13.00	-45.53	Pass	H
5125.515	150	241	-55.49	-13.00	-42.49	Pass	H
5956.109	152	100	-52.31	-13.00	-39.31	Pass	H
8229.291	150	169	-54.59	-13.00	-41.59	Pass	H
1483.727	149	254	-58.55	-13.00	-45.55	Pass	V
2050.000	150	26	-56.91	-13.00	-43.91	Pass	V
2678.135	151	100	-58.51	-13.00	-45.51	Pass	V
3662.775	150	332	-58.26	-13.00	-45.26	Pass	V
5352.186	150	159	-54.83	-13.00	-41.83	Pass	V
6868.647	150	100	-53.64	-13.00	-40.64	Pass	V

HSDPA band II 9400 channel/1880MHz(middle channel)							
Frequency (MHz)	Height (cm)	Azimuth (deg)	Spurious Emission Level (dBm)	Limit (dBm)	Over Limit (dB)	Result	Antenna Polaxis.
1479.955	151	151	-58.80	-13.00	-45.80	Pass	H
2102.853	150	79	-55.65	-13.00	-42.65	Pass	H
2506.624	150	360	-58.11	-13.00	-45.11	Pass	H
3233.257	152	200	-58.97	-13.00	-45.97	Pass	H
4223.950	152	157	-58.27	-13.00	-45.27	Pass	H
5448.410	150	149	-54.95	-13.00	-41.95	Pass	H
1498.912	150	217	-59.42	-13.00	-46.42	Pass	V
2218.323	151	360	-57.33	-13.00	-44.33	Pass	V
2796.573	151	100	-58.24	-13.00	-45.24	Pass	V
3681.469	150	243	-58.49	-13.00	-45.49	Pass	V
6299.178	149	100	-51.52	-13.00	-38.52	Pass	V
7941.185	150	100	-54.59	-13.00	-41.59	Pass	V

HSDPA band II 9538 channel/1907.6MHz(highest channel)							
Frequency (MHz)	Height (cm)	Azimuth (deg)	Spurious Emission Level (dBm)	Limit (dBm)	Over Limit (dB)	Result	Antenna Polaxis.
1514.252	151	37	-58.51	-13.00	-45.51	Pass	H
2287.130	150	60	-57.23	-13.00	-44.23	Pass	H
2905.419	149	360	-57.96	-13.00	-44.96	Pass	H
3963.520	150	79	-59.47	-13.00	-46.47	Pass	H
5518.199	150	151	-54.39	-13.00	-41.39	Pass	H
6903.705	149	247	-54.10	-13.00	-41.10	Pass	H
1597.401	150	291	-58.06	-13.00	-45.06	Pass	V
2151.585	150	200	-57.00	-13.00	-44.00	Pass	V
2678.135	151	147	-56.61	-13.00	-43.61	Pass	V
3672.110	150	10	-57.73	-13.00	-44.73	Pass	V
4772.910	151	36	-57.34	-13.00	-44.34	Pass	V
5971.290	150	111	-52.76	-13.00	-39.76	Pass	V

HSUPA band II 9262 channel/1852.4MHz(lowest channel)							
Frequency (MHz)	Height (cm)	Azimuth (deg)	Spurious Emission Level (dBm)	Limit (dBm)	Over Limit (dB)	Result	Antenna Polaxis.
1597.401	152	59	-57.50	-13.00	-44.50	Pass	H
2146.115	150	20	-57.02	-13.00	-44.02	Pass	H
2684.961	150	332	-57.63	-13.00	-44.63	Pass	H
3241.498	151	97	-58.12	-13.00	-45.12	Pass	H
4712.547	149	132	-56.38	-13.00	-43.38	Pass	H
6315.233	149	351	-52.66	-13.00	-39.66	Pass	H
1498.912	150	70	-58.36	-13.00	-45.36	Pass	V
2108.213	150	151	-56.27	-13.00	-43.27	Pass	V
2927.691	150	109	-58.97	-13.00	-45.97	Pass	V
3672.110	150	21	-58.56	-13.00	-45.56	Pass	V
4760.776	149	109	-57.46	-13.00	-44.46	Pass	V
6017.064	150	360	-52.48	-13.00	-39.48	Pass	V

HSUPA band II 9400 channel/1880MHz(middle channel)							
Frequency (MHz)	Height (cm)	Azimuth (deg)	Spurious Emission Level (dBm)	Limit (dBm)	Over Limit (dB)	Result	Antenna Polaxis.
1597.401	151	229	-57.39	-13.00	-44.39	Pass	H
2086.856	152	100	-55.84	-13.00	-42.84	Pass	H
2810.846	150	26	-58.03	-13.00	-45.03	Pass	H
3681.469	149	351	-57.93	-13.00	-44.93	Pass	H
4688.616	150	359	-57.95	-13.00	-44.95	Pass	H
6299.178	150	240	-52.51	-13.00	-39.51	Pass	H
1597.401	150	19	-56.38	-13.00	-43.38	Pass	V
2173.605	151	248	-56.17	-13.00	-43.17	Pass	V
2868.674	151	358	-58.05	-13.00	-45.05	Pass	V
3776.385	151	70	-58.62	-13.00	-45.62	Pass	V
5532.263	150	154	-54.11	-13.00	-41.11	Pass	V
6886.154	150	100	-53.58	-13.00	-40.58	Pass	V

HSUPA band II 9538 channel/1907.6MHz(highest channel)							
Frequency (MHz)	Height (cm)	Azimuth (deg)	Spurious Emission Level (dBm)	Limit (dBm)	Over Limit (dB)	Result	Antenna Polaxis.
1557.252	152	87	-57.44	-13.00	-44.44	Pass	H
2258.204	150	100	-56.18	-13.00	-43.18	Pass	H
3266.346	149	89	-57.55	-13.00	-44.55	Pass	H
4159.927	149	154	-57.58	-13.00	-44.58	Pass	H
6001.768	150	121	-51.96	-13.00	-38.96	Pass	H
7413.726	150	76	-53.82	-13.00	-40.82	Pass	H
1668.044	149	99	-54.67	-13.00	-41.67	Pass	V
2513.013	150	100	-57.25	-13.00	-44.25	Pass	V
3241.498	151	67	-58.68	-13.00	-45.68	Pass	V
4181.159	150	100	-58.28	-13.00	-45.28	Pass	V
5352.186	151	229	-54.12	-13.00	-41.12	Pass	V
6331.329	150	40	-53.71	-13.00	-40.71	Pass	V

Note:

1) Scan from 9kHz to 25GHz, the disturbance above 13GHz and below 30MHz was very low, and the above harmonics were the highest point could be found when testing, so only the above harmonics had been displayed. The amplitude of spurious emissions from the radiator which are attenuated more than 20dB below the limit need not be reported.

PHOTOGRAPHS OF TEST SETUP

Test model No.: WPP23

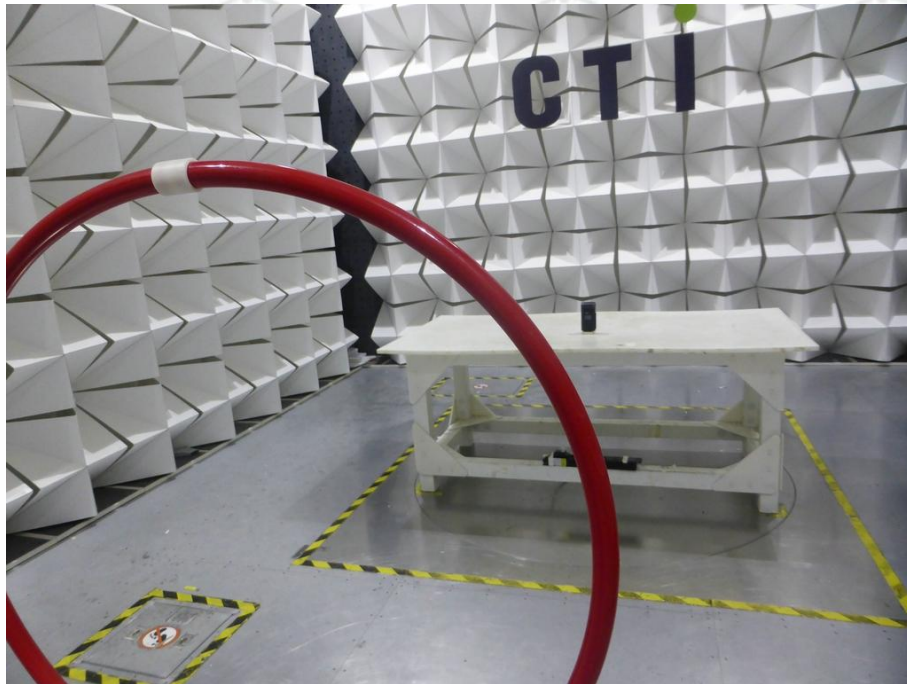

Radiated spurious emission Test Setup-1(9kHz-30MHz)



Radiated spurious emission Test Setup-1(30MHz-1GHz)



Radiated spurious emission Test Setup-2(Above 1GHz)

PHOTOGRAPHS OF EUT Constructional Details

Refer to Report No. EED32J00113702 for EUT external and internal photos.

*** End of Report ***

The test report is effective only with both signature and specialized stamp, The result(s) shown in this report refer only to the sample(s) tested. Without written approval of CTI, this report can't be reproduced except in full.