



TESTING LABORATORY
CERTIFICATE#4323.01



SAR EVALUATION REPORT

For

BBPOS International Limited

Suite 1903-04, 19/F, Tower 2, Nina Tower, No.8 Yeung UK Road, Tsuen Wan, N.T. HK

FCC ID: 2AB7X-WISEPOSE

Report Type: Original Report	Product Type: WisePOS E	
Test Engineer:	Sam Ye	<i>Sam Ye</i>
Report Number:	RKSA200310001-20C	
Report Date:	2020-05-30	
Reviewed By:	Oscar Ye EMC Manager	<i>Oscar Ye</i>
Test Laboratory:	Bay Area Compliance Laboratories Corp. (Kunshan) No.248 Chenghu Road, Kunshan, Jiangsu province, China Tel: +86-0512-86175000 Fax: +86-0512-88934268 www.baclcorp.com.cn	

Note: This test report is prepared for the customer shown above and for the device described herein. It may not be duplicated or used in part without prior written consent from Bay Area Compliance Laboratories Corp. This report is valid only with a valid digital signature. The digital signature may be available only under the Adobe software above version 7.0.

Attestation of Test Results				
EUT Information	EUT Description	WisePOS E		
	Tested Model	WisePOS E		
	FCC ID	2AB7X-WISEPOSE		
	Serial Number	RKSA200310001		
	Test Date	2020-05-18~ 2020-05-22		
MODE		Max. SAR Level(s) Reported(W/kg)		Limit (W/kg)
Body supported Mode	GSM 850	1g Body SAR	0.91	1.6
	PCS 1900	1g Body SAR	0.34	
	WCDMA Band 2	1g Body SAR	0.58	
	WCDMA Band 5	1g Body SAR	0.21	
	LTE Band 5	1g Body SAR	0.20	
	LTE Band 7	1g Body SAR	0.36	
	LTE Band 38	1g Body SAR	0.24	
	LTE Band 41	1g Body SAR	0.32	
	WLAN 2.4G	1g Body SAR	0.06	
	WLAN 5.2G	1g Body SAR	0.12	
	WLAN 5.8G	1g Body SAR	0.13	
Simultaneous	1g Body SAR	1.06		
Handheld Mode	GSM 850	10g Extremity SAR	1.13	4.0
	PCS 1900	10g Extremity SAR	2.65	
	WCDMA Band 2	10g Extremity SAR	2.54	
	WCDMA Band 5	10g Extremity SAR	0.24	
	LTE Band 5	10g Extremity SAR	0.29	
	LTE Band 7	10g Extremity SAR	2.45	
	LTE Band 38	10g Extremity SAR	1.40	
	LTE Band 41	10g Extremity SAR	2.22	
	WLAN 2.4G	10g Extremity SAR	0.29	
	WLAN 5.2G	10g Extremity SAR	0.38	
	WLAN 5.8G	10g Extremity SAR	0.25	
Simultaneous	10g Extremity SAR	2.71		
Applicable Standards	FCC 47 CFR part 2.1093 Radiofrequency radiation exposure evaluation: portable devices			
	RF Exposure Procedures: TCB Workshop April 2019			
	IEEE1528:2013 IEEE Recommended Practice for Determining the Peak Spatial-Average Specific Absorption Rate (SAR) in the Human Head from Wireless Communications Devices: Measurement Techniques			
	IEC 62209-2:2010 Human exposure to radio frequency fields from hand-held and body-mounted wireless communication devices-Human models, instrumentation, and procedures-Part 2: Procedure to determine the specific absorption rate (SAR) for wireless communication devices used in close proximity to the human body (frequency range of 30 MHz to 6 GHz)			

Applicable Standards	<p>KDB procedures KDB 447498 D01 General RF Exposure Guidance v06 KDB 648474 D04 Handset SAR v01r03 KDB 865664 D01 SAR Measurement 100 MHz to 6 GHz v01r04 KDB 865664 D02 RF Exposure Reporting v01r02 KDB 941225 D01 3G SAR Procedures v03r01 KDB 941225 D05 SAR for LTE Devices v02r05 KDB 248227 D01 802.11 Wi-Fi SAR v02r02</p>
<p>Note: This wireless device has been shown to be capable of compliance for localized specific absorption rate (SAR) for General Population/Uncontrolled Exposure limits specified in FCC 47 CFR part 2.1093 and has been tested in accordance with the measurement procedures specified in IEEE 1528-2013 and RF exposure KDB procedures.</p> <p>The results and statements contained in this report pertain only to the device(s) evaluated.</p>	

TABLE OF CONTENTS

DOCUMENT REVISION HISTORY	5
EUT DESCRIPTION	6
TECHNICAL SPECIFICATION	6
REFERENCE, STANDARDS, AND GUIDELINES.....	7
SAR LIMITS	7
FACILITIES.....	8
DESCRIPTION OF TEST SYSTEM	9
EQUIPMENT LIST AND CALIBRATION	16
EQUIPMENTS LIST & CALIBRATION INFORMATION	16
SAR MEASUREMENT SYSTEM VERIFICATION	17
LIQUID VERIFICATION	17
SYSTEM ACCURACY VERIFICATION	19
SAR SYSTEM VALIDATION DATA.....	20
EUT TEST STRATEGY AND METHODOLOGY	26
TEST POSITIONS FOR DEVICE OPERATING NEXT TO A PERSON’S EAR.....	26
CHEEK/TOUCH POSITION	27
EAR/TILT POSITION	27
TEST POSITIONS FOR BODY-WORN AND OTHER CONFIGURATIONS.....	28
TEST DISTANCE FOR SAR EVALUATION	28
SAR EVALUATION PROCEDURE.....	29
CONDUCTED OUTPUT POWER MEASUREMENT	30
PROVISION APPLICABLE	30
TEST PROCEDURE	30
RADIO CONFIGURATION	30
MAXIMUM TARGET OUTPUT POWER	35
TEST RESULTS:	36
STANDALONE SAR TEST EXCLUSION CONSIDERATIONS	48
ANTENNA DISTANCE TO EDGE	49
STANDALONE SAR TEST EXCLUSION CONSIDERATIONS.....	49
STANDALONE SAR ESTIMATION:	50
STANDALONE SAR TEST EXCLUSION CONSIDERATIONS:.....	50
SAR TEST EXCLUSION FOR THE EUT EDGE CONSIDERATIONS RESULT	51
SAR TEST EXCLUSION FOR THE EUT EDGE CONSIDERATIONS DETIAL:	51
SAR MEASUREMENT RESULTS.....	52
SAR TEST DATA.....	52
SAR MEASUREMENT VARIABILITY	61
SAR SIMULTANEOUS TRANSMISSION DESCRIPTION	62
SAR PLOTS.....	68
APPENDIX A MEASUREMENT UNCERTAINTY	69
APPENDIX B EUT TEST POSITION PHOTOS	71
APPENDIX C CALIBRATION CERTIFICATES	72

DOCUMENT REVISION HISTORY

Revision Number	Report Number	Description of Revision	Date of Revision
1.0	RKSA200310001-20C	Original Report	2020-05-30

EUT DESCRIPTION

This report has been prepared on behalf of **BBPOS International Limited** and their product **WisePOS E**, Model: **WisePOS E**, FCC ID: **2AB7X-WISEPOSE** or the EUT (Equipment under Test) as referred to in the rest of this report.

**All measurement and test data in this report was gathered from production sample serial number: RKSA200310001(Assigned by BACL).The EUT supplied by the applicant was received on 2020-03-10.*

Technical Specification

Device Type:	Portable
Exposure Category:	Population / Uncontrolled
Antenna Type(s):	Internal Antenna
DTM Type:	Class B(Only GPRS Data activated)
Multi-slot Class:	GPRS(Class 12); EGPRS(Class 12)
Body-Worn Accessories:	None
Operation Mode :	GPRS/EDGE Data, WCDMA(R99, HSDPA/HSUPA), FDD-LTE, TDD-LTE, WLAN, Bluetooth, NFC
Frequency Band:	GPRS/EGPRS 850: 824-849 MHz(TX), 869-894 MHz(RX) PCS1900: 1850MHz-1910MHz(TX), 1930MHz-1990MHz(RX) WCDMA Band II: 1850-1910 MHz MHz(TX), 1930-1990 MHz(RX) WCDMA Band V: 824-849 MHz(TX), 869-894 MHz(RX) LTE Band 5: 824-849 MHz(TX), 869-894 MHz(RX) LTE Band 7: 2500-2570 MHz(TX), 2620-2690 MHz(RX) LTE Band 38: 2570-2620 MHz(TX), 2570-2620 MHz(RX) LTE Band 41: 2555-2655 MHz(TX), 2555-2655MHz(RX) WLAN 2.4G: 2412 -2462 MHz WLAN 5G B1: 5180-5240 MHz, B4: 5745-5825 MHz Bluetooth: 2402 MHz-2480 MHz NFC: 13.56 MHz
Conducted RF Power:	GSM 850: 33.43 dBm PCS 1900: 31.56 dBm WCDMA Band 2: 22.85 dBm WCDMA Band 5: 22.94 dBm LTE Band 5: 21.97 dBm LTE Band 7: 21.98 dBm LTE Band 38: 21.98 dBm LTE Band 41: 21.99 dBm WLAN 2.4G: 17.68 dBm WLAN 5.2G: 11.68 dBm WLAN 5.8G: 11.37 dBm Bluetooth(BDR/EDR); 5.25 dBm
Power Source:	DC 3.7V from battery
Normal Operation:	Handheld and Body Supported

Duty cycle Form

Band	Mode	Duty cycle(100%)
2.4G Wi-Fi	802.11b	100
	802.11g	100
	802.11n-HT20MHz	100
5G Wi-Fi	802.11a	100
	802.11n-HT20MHz	100

REFERENCE, STANDARDS, AND GUIDELINES

FCC:

The Report and Order requires routine SAR evaluation prior to equipment authorization of portable transmitter devices, including portable telephones. For consumer products, the applicable limit is 1.6 mW/g as recommended by the ANSI/IEEE standard C95.1-1992 [6] for an uncontrolled environment (Paragraph 65). According to the Supplement C of OET Bulletin 65 "Evaluating Compliance with FCC Guide-lines for Human Exposure to Radio frequency Electromagnetic Fields", released on Jun 29, 2001 by the FCC, the device should be evaluated at maximum output power (radiated from the antenna) under "worst-case" conditions for normal or intended use, incorporating normal antenna operating positions, device peak performance frequencies and positions for maximum RF energy coupling.

This report describes the methodology and results of experiments performed on wireless data terminal. The objective was to determine if there is RF radiation and if radiation is found, what is the extent of radiation with respect to safety limits. SAR (Specific Absorption Rate) is the measure of RF exposure determined by the amount of RF energy absorbed by human body (or its parts) – to determine how the RF energy couples to the body or head which is a primary health concern for body worn devices. The limit below which the exposure to RF is considered safe by regulatory bodies in North America is 1.6 mW/g average over 1 gram of tissue mass.

SAR Limits

FCC Limit

EXPOSURE LIMITS	SAR (W/kg)	
	(General Population / Uncontrolled Exposure Environment)	(Occupational / Controlled Exposure Environment)
Spatial Average (averaged over the whole body)	0.08	0.4
Spatial Peak (averaged over any 1 g of tissue)	1.60	8.0
Spatial Peak (hands/wrists/feet/ankles averaged over 10 g)	4.0	20.0

Population/Uncontrolled Environments are defined as locations where there is the exposure of individual who have no knowledge or control of their exposure.

Occupational/Controlled Environments are defined as locations where there is exposure that may be incurred by people who are aware of the potential for exposure (i.e. as a result of employment or occupation).

General Population/Uncontrolled environments Spatial Peak limit 1.6W/kg for 1g Body SAR and 4.0 W/kg for 10g Extremity SAR applied to the EUT.

FACILITIES

The test site used by Bay Area Compliance Laboratories Corp. (Kunshan) to collect test data is located on the No.248 Chenghu Road, Kunshan, Jiangsu province, China.

Bay Area Compliance Laboratories Corp. (Kunshan) Lab is accredited to ISO/IEC 17025 by A2LA (Lab code: 4323.01) and the FCC designation No. CN1185 under the FCC KDB 974614 D01 and CAB identifier CN0004 under the ISED requirement. The facility also complies with the radiated and AC line conducted test site criteria set forth in ANSI C63.4-2014.

DESCRIPTION OF TEST SYSTEM

These measurements were performed with the automated near-field scanning system DASY6 from Schmid & Partner Engineering AG (SPEAG) which is the Fifth generation of the system shown in the figure hereinafter:

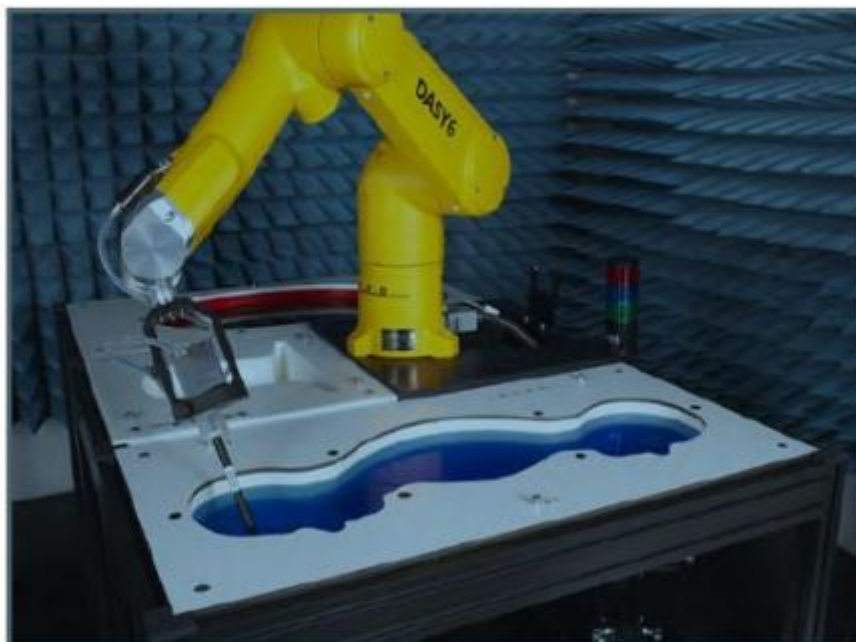

DASY6 System Description

The DASY6 system for performing compliance tests consists of the following items:

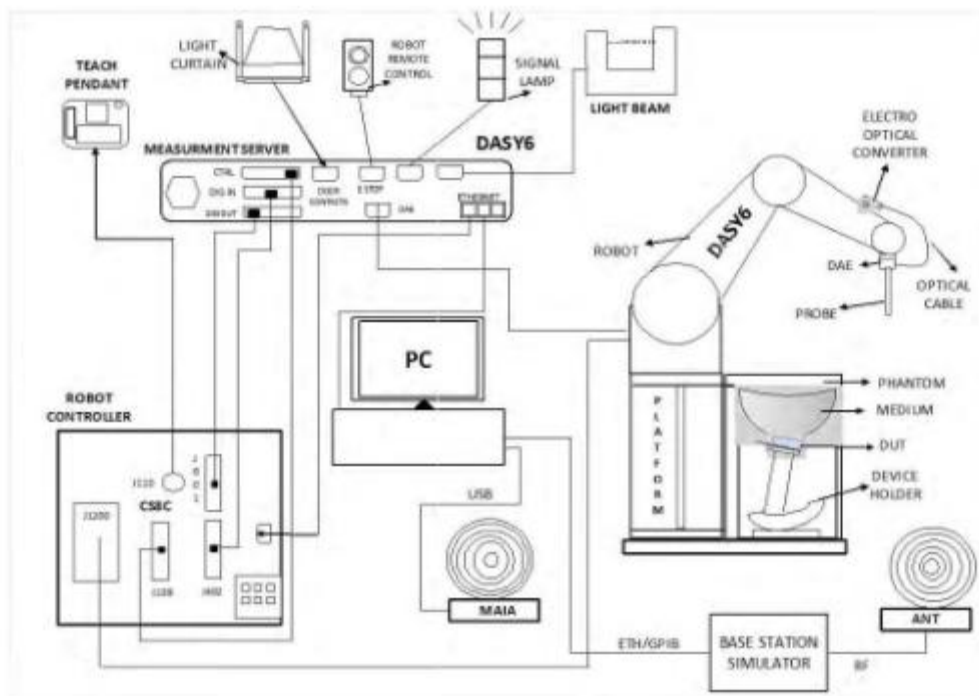

- A standard high precision 6-axis robot (Staubli TX=RX family) with controller, teach pendant and software. An arm extension for accommodating the data acquisition electronics (DAE).
- An isotropic field probe optimized and calibrated for the targeted measurement.
- A data acquisition electronics (DAE) which performs the signal application, signal multiplexing, AD-conversion, offset measurements, mechanical surface detection, collision detection, etc. The unit is battery powered with standard or rechargeable batteries. The signal is optically transmitted to the EOC.
- The Electro-optical converter (EOC) performs the conversion from optical to electrical signals for the digital communication to the DAE. To use optical surface detection, a special version of the EOC is required. The EOC signal is transmitted to the measurement server.
- The function of the measurement server is to perform the time critical tasks such as signal filtering, control of the robot operation and fast movement interrupts.
- The Light Beam used is for probe alignment. This improves the (absolute) accuracy of the probe positioning.
- A computer running Win7 professional operating system and the DASY52 software.
- Remote control and teach pendant as well as additional circuitry for robot safety such as warning lamps, etc.
- The phantom, the device holder and other accessories according to the targeted measurement.

DASY6 Measurement Server

The DASY6 measurement server is based on a PC/104 CPU board with a 400 MHz Intel ULV Celeron, 128 MB chip-disk and 128 MB RAM. The necessary circuits for communication with the DAE4 (or DAE3) electronics box, as well as the 16-bit AD converter system for optical detection and digital I/O interface are contained on the DASY6 I/O board, which is directly connected to the PC/104 bus of the CPU board.



The measurement server performs all real-time data evaluations of field measurements and surface detection, controls robot movements, and handles safety operations. The PC operating system cannot interfere with these time-critical processes. All connections are supervised by a watchdog, and disconnection of any of the cables to the measurement server will automatically disarm the robot and disable all program- controlled robot movements. Furthermore, the measurement server is equipped with an expansion port, which is reserved for future applications. Please note that this expansion port does not have a standardized pinout, and therefore only devices provided by SPEAG can be connected. Connection of devices from any other supplier could seriously damage the measurement server.

Data Acquisition Electronics

The data acquisition electronics (DAE4) consist of a highly sensitive electrometer-grade preamplifier with auto-zeroing, a channel and gain-switching multiplexer, a fast 16 bit AD-converter and a command decoder with a control logic unit. Transmission to the measurement server is accomplished through an optical downlink for data and status information, as well as an optical uplink for commands and the clock.

The mechanical probe mounting device includes two different sensor systems for frontal and sideways probe contacts. They are used for mechanical surface detection and probe collision detection.

The input impedance of both the DAE4 as well as of the DAE3 box is 200M Ω ; the inputs are symmetrical and floating. Common mode rejection is above 80 dB.

EX3DV4 E-Field Probes

Frequency	10 MHz to > 6 GHz Linearity: ± 0.2 dB (30 MHz to 6 GHz)
Directivity	± 0.3 dB in TSL (rotation around probe axis) ± 0.5 dB in TSL (rotation normal to probe axis)
Dynamic Range	10 µW/g to > 100 mW/g Linearity: ± 0.2 dB (noise: typically < 1 µW/g)
Dimensions	Overall length: 337 mm (Tip: 20 mm) Tip diameter: 2.5 mm (Body: 12 mm) Typical distance from probe tip to dipole centers: 1 mm
Application	High precision dosimetric measurements in any exposure scenario (e.g., very strong gradient fields); the only probe that enables compliance testing for frequencies up to 6 GHz with precision of better 30%.
Compatibility	DASY3, DASY4, DASY52 SAR and higher, EASY4/MRI

SAM Twin Phantom

The SAM Twin Phantom (shown in front of DASY6) is a fiberglass shell phantom with shell thickness 2 mm, except in the ear region where the thickness is increased to 6 mm. The phantom has three measurement areas: 1) Left Head, 2) Right Head, and 3) Flat Section. For larger devices, the use of the ELI-Phantom (shown behind DASY6) is required. For devices such as glasses with a wireless link, the Face Down Phantom is the most suitable (between the SAM Twin and ELI phantoms).

When the phantom is mounted inside allocated slot of the DASY6 platform, phantom reference points can be taught directly in the DASY5 V5.2 software. When the DASY6 platform is used to mount the Phantom, some of the phantom teaching points cannot be reached by the robot in DASY5 V5.2. A special tool called P1a-P2aX-Former is provided to transform two of the three points, P1 and P2, to reachable locations. To use these new teaching points, a revised phantom configuration file is required.

In addition to our standard broadband liquids, the phantom can be used with the following tissue simulating liquids:

Sugar-water-based liquids can be left permanently in the phantom. Always cover the liquid when the system is not in use to prevent changes in liquid parameters due to water evaporation.

DGBE-based liquids should be used with care. As DGBE is a softener for most plastics, the liquid should be taken out of the phantom, and the phantom should be dried when the system is not in use (desirable at least once a week).

Do not use other organic solvents without previously testing the solvent resistivity of the phantom.

Approximately 25 liters of liquid is required to fill the SAM Twin phantom.

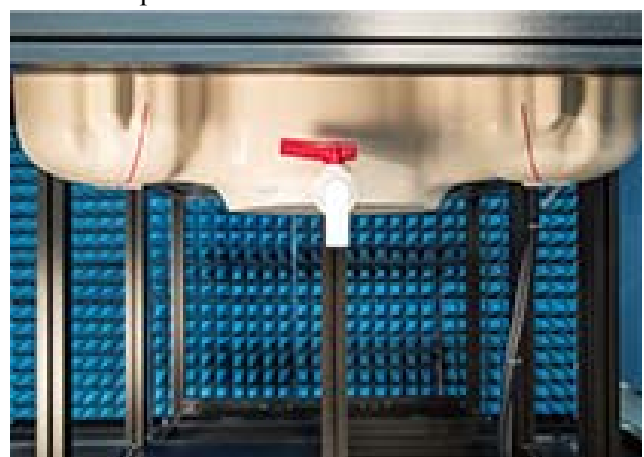

ELI Phantom

The ELI phantom is intended for compliance testing of handheld and body-mounted wireless devices in the frequency range of 30MHz to 6 GHz. ELI is fully compatible with the latest draft of the standard IEC 62209-2 and the use of all known tissue simulating liquids. ELI has been optimized for performance and can be integrated into a SPEAG standard phantom table. A cover is provided to prevent evaporation of water and changes in liquid parameters. Reference markings on the phantom allow installation of the complete setup, including all predefined phantom positions and measurement grids, by teaching three points.

The phantom can be used with the following tissue simulating liquids:

- Sugar-water-based liquids can be left permanently in the phantom. Always cover the liquid when the system is not in use to prevent changes in liquid parameters due to water evaporation.
- DGBE-based liquids should be used with care. As DGBE is a softener for most plastics, the liquid should be taken out of the phantom, and the phantom should be dried when the system is not in use (desirable at least once a week).
- Do not use other organic solvents without previously testing the solvent resistivity of the phantom.

Approximately 25 liters of liquid is required to fill the ELI phantom.

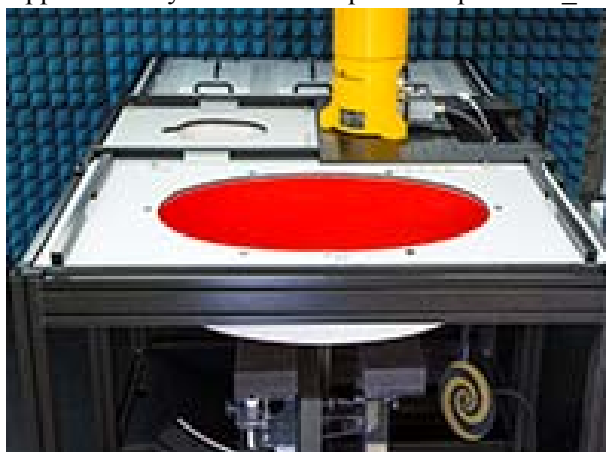

Robots

The DASY6 system uses the high-precision industrial robots TX60L, TX90XL, and RX160L from Staubli SA (France). The TX robot family - the successor of the well-known RX robot family - continues to offer the features important for DASY6 applications:

- High precision (repeatability 0.02mm)
- High reliability (industrial design)
- Low maintenance costs (virtually maintenance free due to direct drive gears; no belt drives)
- Jerk-free straight movements (brushless synchrony motors; no stepper motors)
- Low ELF interference (motor control fields shielded via the closed metallic construction shields)

The robots are controlled by the Staubli CS8c robot controllers. All information regarding the use and maintenance of the robot arm and the robot controller is provided

Area Scans

Area scans are defined prior to the measurement process being executed with a user defined variable spacing between each measurement point (integral) allowing low uncertainty measurements to be conducted. Scans defined for FCC applications utilize a 15mm 2 step integral, with 1.5mm interpolation used to locate the peak SAR area used for zoom scan assessments.

Where the system identifies multiple SAR peaks (which are within 25% of peak value) the system will provide the user with the option of assessing each peak location individually for zoom scan averaging.

Zoom Scan (Cube Scan Averaging)

The averaging zoom scan volume utilized in the DASY5 software is in the shape of a cube and the side dimension of a 1 g or 10 g mass is dependent on the density of the liquid representing the simulated tissue. A density of 1000 kg/m³ is used to represent the head and body tissue density and not the phantom liquid density, in order to be consistent with the definition of the liquid dielectric properties, i.e. the side length of the 1g cube is 10mm, with the side length of the 10g cube is 21.5mm.

When the cube intersects with the surface of the phantom, it is oriented so that 3 vertices touch the surface of the shell or the center of a face is tangent to the surface. The face of the cube closest to the surface is modified in order to conform to the tangent surface.

The zoom scan integer steps can be user defined so as to reduce uncertainty, but normal practice for typical test applications (including FCC) utilize a physical step of 7 x7 x 7 (5mmx5mmx5mm) providing a volume of 30 mm in the X & Y & Z axis.

Calibration Frequency Points for EX3DV4 E-Field Probes SN: 7557 Calibrated: 2019/10/04

Calibration Frequency Point(MHz)	Frequency Range(MHz)		Conversion Factor		
	From	To	X	Y	Z
750 Head	650	810	10.41	10.41	10.41
835 Head	810	935	10.10	10.10	10.10
1750 Head	1650	1810	8.67	8.67	8.67
1900 Head	1810	2000	8.36	8.36	8.36
2300 Head	2200	2399	7.79	7.79	7.79
2450 Head	2399	2500	7.41	7.41	7.41
2600 Head	2500	2700	7.21	7.21	7.21
5250 Head	5140	5360	5.38	5.38	5.38
5600 Head	5490	5700	4.75	4.75	4.75
5800 Head	5700	5910	4.70	4.70	4.70

Tissue Dielectric Parameters for Head and Body Phantoms

The head tissue dielectric parameters recommended by the IEC 62209-1:2016

Recommended Tissue Dielectric Parameters for Head liquid

Table A.3 – Dielectric properties of the head tissue-equivalent liquid

Frequency MHz	Relative permittivity ϵ_r	Conductivity (σ) S/m
300	45,3	0,87
450	43,5	0,87
<i>750</i>	<i>41,9</i>	<i>0,89</i>
835	41,5	0,90
900	41,5	0,97
1 450	40,5	1,20
<i>1 500</i>	<i>40,4</i>	<i>1,23</i>
<i>1 640</i>	<i>40,2</i>	<i>1,31</i>
<i>1 750</i>	<i>40,1</i>	<i>1,37</i>
1 800	40,0	1,40
1 900	40,0	1,40
2 000	40,0	1,40
<i>2 100</i>	<i>39,8</i>	<i>1,49</i>
<i>2 300</i>	<i>39,5</i>	<i>1,67</i>
2 450	39,2	1,80
<i>2 600</i>	<i>39,0</i>	<i>1,96</i>
3 000	38,5	2,40
<i>3 500</i>	<i>37,9</i>	<i>2,91</i>
<i>4 000</i>	<i>37,4</i>	<i>3,43</i>
<i>4 500</i>	<i>36,8</i>	<i>3,94</i>
<i>5 000</i>	<i>36,2</i>	<i>4,45</i>
<i>5 200</i>	<i>36,0</i>	<i>4,66</i>
<i>5 400</i>	<i>35,8</i>	<i>4,86</i>
<i>5 600</i>	<i>35,5</i>	<i>5,07</i>
<i>5 800</i>	<i>35,3</i>	<i>5,27</i>
<i>6 000</i>	<i>35,1</i>	<i>5,48</i>

NOTE For convenience, permittivity and conductivity values at those frequencies which are not part of the original data provided by Drossos et al. [33] or the extension to 5 800 MHz are provided (i.e. the values shown *in italics*). These values were linearly interpolated between the values in this table that are immediately above and below these values, except the values at 6 000 MHz that were linearly extrapolated from the values at 3 000 MHz and 5 800 MHz.

Note:

- 1, Effective February 19, 2019, FCC has permitted the use of single head-tissue simulating liquid specified in IEC 62209-1 for all SAR tests.
- 2, Mix and Match of traditional FCC SAR TSLs and IEC 62209-1 TSL in a single application is not permitted TSL can be changed in a Permissive Change.
- 3, If SAR increases and original SAR > 1.2 W/kg, additional SAR measurements will be required IEC 62209-1 TSL is an alternative, not mandatory at this time.
- 4, If FCC parameters are used, $\pm 5\%$ tolerance. If IEC parameters, $\pm 10\%$.
- 5, In this case, IEC parameters applied.

EQUIPMENT LIST AND CALIBRATION

Equipments List & Calibration Information

Equipment	Model	S/N	Calibration Date	Calibration Due Date
DASY5 Test Software	DASY52 52.10.2	N/A	NCR	NCR
DASY6 Measurement Server	DASY6 6.0.31	N/A	NCR	NCR
Data Acquisition Electronics	DAE4	527	2019/06/13	2020/06/13
E-Field Probe	EX3DV4	7557	2019/10/04	2020/10/04
Mounting Device	MD4HHTV5	SD 000 H01 KA	NCR	NCR
Twin-SAM Phantom	QD 000 P41 AX	1963	NCR	NCR
Dipole, 835MHz	D835V2	445	2019/12/17	2022/12/17
Dipole, 1900MHz	D1900V2	5d206	2018/09/11	2021/09/11
Dipole, 2450MHz	D2450V2	970	2018/06/26	2021/06/26
Dipole, 2600MHz	D2600V2	1162	2019/10/02	2022/10/02
Dipole, 5GHz	D5GHzV2	1296	2019/10/03	2022/10/03
Simulated Tissue Liquid Head	HBBL600-6000V6	180611-3	Each Time	
Network Analyzer	8753B	3625A00809	2019/12/14	2020/12/14
Dielectric Assessment Kit	DAK-3.5	SM DAK 300AB	NCR	NCR
Signal Generator	N5182B	MY53051592	2019/12/14	2020/12/14
Power Meter	E4419B	GB43312421	2019/08/05	2020/08/05
Power Amplifier	5S1G4	71377	NCR	NCR
Directional Coupler	4242-10	3307	NCR	NCR
Attenuator	3dB	5402	NCR	NCR
Attenuator	10dB	AU 3842	NCR	NCR
UNIVERSAL RADIO COMMUNICATION TESTER	CMU200	100184	2020/02/14	2021/02/14
Wideband Radio Communication Tester	CMW500	104478	2019/08/05	2020/08/05
Signal Analyzer	FSV40	101116	2019-07-23	2020-07-22

SAR MEASUREMENT SYSTEM VERIFICATION

Liquid Verification

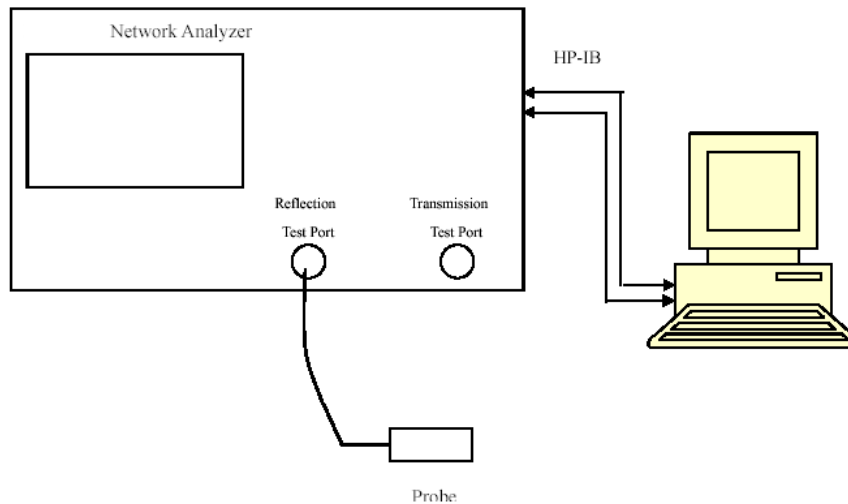

Liquid Verification Setup Block Diagram

Liquid Verification Results

Frequency (MHz)	Liquid Type	Liquid Parameter		Target Value		Delta (%)		Tolerance (%)
		ϵ_r	σ (S/m)	ϵ_r	σ (S/m)	$\Delta \epsilon_r$	$\Delta \sigma$	
835.0	Head	41.903	0.899	41.500	0.900	0.97	-0.11	±5
824.2	Head	41.991	0.899	41.512	0.898	1.15	0.11	±5
826.4	Head	41.973	0.899	41.507	0.898	1.12	0.11	±5
829.0	Head	41.952	0.899	41.504	0.899	1.08	0.00	±5
836.4	Head	41.892	0.899	41.500	0.901	0.94	-0.22	±5
836.5	Head	41.891	0.899	41.500	0.901	0.94	-0.22	±5
836.6	Head	41.887	0.899	41.500	0.901	0.93	-0.22	±5
844.0	Head	41.830	0.898	41.500	0.904	0.80	-0.66	±5
846.6	Head	41.806	0.898	41.500	0.906	0.74	-0.88	±5
848.8	Head	41.790	0.898	41.500	0.907	0.70	-0.99	±5

*Liquid Verification above was performed on 2020/05/18.

Frequency (MHz)	Liquid Type	Liquid Parameter		Target Value		Delta (%)		Tolerance (%)
		ϵ_r	σ (S/m)	ϵ_r	σ (S/m)	$\Delta \epsilon_r$	$\Delta \sigma$	
1900.0	Head	40.495	1.388	40.000	1.400	1.24	-0.86	±5
1850.2	Head	40.574	1.386	40.000	1.400	1.44	-1.00	±5
1852.4	Head	40.571	1.386	40.000	1.400	1.43	-1.00	±5
1880.0	Head	40.527	1.388	40.000	1.400	1.32	-0.86	±5
1907.6	Head	40.482	1.389	40.000	1.400	1.21	-0.79	±5
1909.8	Head	40.479	1.389	40.000	1.400	1.20	-0.79	±5

*Liquid Verification above was performed on 2020/05/19.

Frequency (MHz)	Liquid Type	Liquid Parameter		Target Value		Delta (%)		Tolerance (%)
		ϵ_r	σ (S/m)	ϵ_r	σ (S/m)	$\Delta \epsilon_r$	$\Delta \sigma$	
2450	Head	39.381	1.827	39.200	1.800	0.46	1.50	±5
2412	Head	39.461	1.794	39.256	1.765	0.52	1.64	±5
2437	Head	39.408	1.816	39.219	1.788	0.48	1.57	±5
2462	Head	39.536	1.837	39.183	1.811	0.90	1.44	±5

*Liquid Verification above was performed on 2020/05/21.

Frequency (MHz)	Liquid Type	Liquid Parameter		Target Value		Delta (%)		Tolerance (%)
		ϵ_r	σ (S/m)	ϵ_r	σ (S/m)	$\Delta \epsilon_r$	$\Delta \sigma$	
2600	Head	39.186	1.984	39.000	1.960	0.48	1.22	±5
2510	Head	39.780	1.887	39.117	1.861	1.69	1.40	±5
2535	Head	39.615	1.914	39.084	1.888	1.36	1.38	±5
2560	Head	39.450	1.941	39.051	1.916	1.02	1.30	±5
2565	Head	39.417	1.946	39.045	1.921	0.95	1.30	±5
2580	Head	39.318	1.962	39.025	1.938	0.75	1.24	±5
2595	Head	39.219	1.978	39.006	1.955	0.55	1.18	±5
2605	Head	39.153	1.989	38.994	1.965	0.41	1.22	±5
2610	Head	39.120	1.995	38.987	1.971	0.34	1.22	±5
2645	Head	38.889	2.033	38.943	2.009	-0.14	1.19	±5

*Liquid Verification above was performed on 2020/05/20.

Frequency (MHz)	Liquid Type	Liquid Parameter		Target Value		Delta (%)		Tolerance (%)
		ϵ_r	σ (S/m)	ϵ_r	σ (S/m)	$\Delta \epsilon_r$	$\Delta \sigma$	
5250	Head	36.083	4.676	35.950	4.711	0.37	-0.74	±5
5180	Head	36.179	4.598	36.020	4.639	0.44	-0.88	±5
5200	Head	36.152	4.620	36.000	4.660	0.42	-0.86	±5
5240	Head	36.097	4.665	35.960	4.701	0.38	-0.77	±5
5800	Head	35.324	5.308	35.300	5.270	0.07	0.72	±5
5745	Head	35.400	5.244	35.355	5.215	0.13	0.56	±5
5785	Head	35.344	5.291	35.315	5.255	0.08	0.69	±5
5825	Head	35.289	5.338	35.275	5.296	0.04	0.79	±5

*Liquid Verification above was performed on 2020/05/22.

System Accuracy Verification

Prior to the assessment, the system validation kit was used to test whether the system was operating within its specifications of $\pm 10\%$. The validation results are tabulated below. And also the corresponding SAR plot is attached as well in the SAR plots files.

The spacing distances in the **System Verification Setup Block Diagram** is given by the following:

- a) $s = 15 \text{ mm} \pm 0,2 \text{ mm}$ for $300 \text{ MHz} \leq f \leq 1 \text{ 000 MHz}$;
- b) $s = 10 \text{ mm} \pm 0,2 \text{ mm}$ for $1 \text{ 000 MHz} < f \leq 3 \text{ 000 MHz}$;
- c) $s = 10 \text{ mm} \pm 0,2 \text{ mm}$ for $3 \text{ 000 MHz} < f \leq 6 \text{ 000 MHz}$.

System Verification Setup Block Diagram

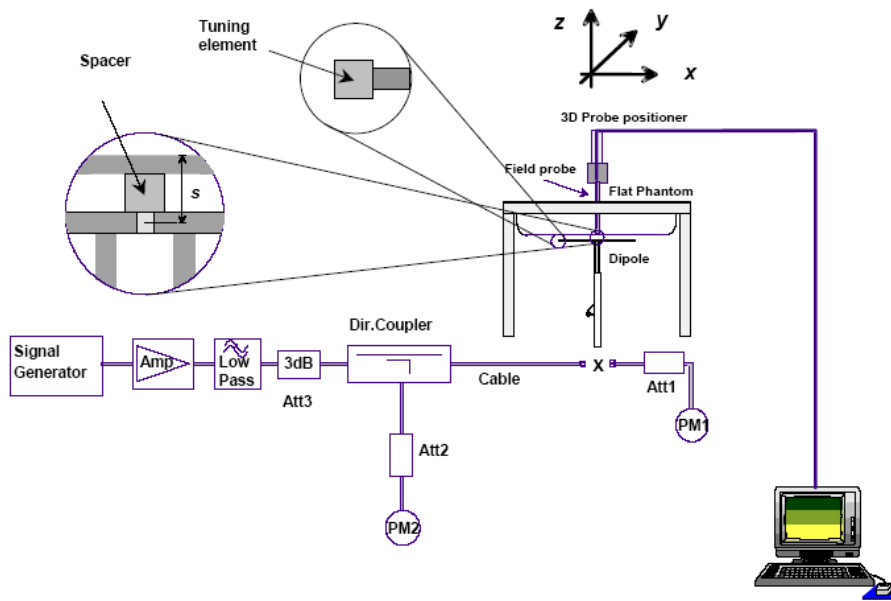

System Accuracy Check Results

Date	Frequency Band	Liquid Type	Input Power (mW)	Measured SAR (W/kg)		Normalized to 1W (W/kg)	Target Value (W/kg)	Delta (%)	Tolerance (%)
				1g	10g				
2020/05/18	835 MHz	Head	250	1g	2.36	9.44	9.52	-0.84	± 10
				10g	1.52				
2020/05/19	1900 MHz	Head	250	1g	9.97	39.88	39.2	1.73	± 10
				10g	5.25				
2020/05/21	2450 MHz	Head	250	1g	13.20	52.80	53.3	-0.94	± 10
				10g	6.15				
2020/05/20	2600 MHz	Head	250	1g	13.80	55.20	55.4	-0.36	± 10
				10g	6.32				
2020/05/22	5250 MHz	Head	100	1g	7.92	79.20	79.2	0.00	± 10
				10g	2.31				
2020/05/22	5800 MHz	Head	100	1g	8.07	80.70	79.9	1.00	± 10
				10g	2.35				

*The SAR values above are normalized to 1 Watt forward power.

SAR SYSTEM VALIDATION DATA

System Performance Check 835MHz

DUT: Dipole 835 MHz; Type:D835V2; Serial:445 (2020-05-18)

Communication System: UID 0; Frequency: 835 MHz;Duty Cycle: 1:1
 Medium parameters used: f = 835 MHz; $\sigma = 0.899$ S/m; $\epsilon_r = 41.903$; $\rho = 1000$ kg/m³

DASY5 Configuration:

- Probe: EX3DV4 - SN7557;ConvF(10.1, 10.1, 10.1); Calibrated: 10/4/2019
- Sensor-Surface: 4mm (Mechanical Surface Detection)
- Electronics: DAE4 Sn527; Calibrated: 6/13/2019
- Phantom: Twin-SAM; Type: QD 000 P41 Ax; Serial: 1963
- Measurement SW: DASY52, Version 52.10 (1); SEMCAD X Version 14.6.11 (7437)

System Performance Check/835MHz/Area Scan (11x21x1): Measurement grid: dx=10mm, dy=10mm
 Maximum value of SAR (measured) = 2.57 W/kg

System Performance Check/835MHz/Zoom Scan (7x7x7)/Cube 0: Measurement grid: dx=5mm, dy=5mm, dz=5mm
 Reference Value = 54.67 V/m; Power Drift = -0.04 dB
 Peak SAR (extrapolated) = 3.56 W/kg
SAR(1 g) = 2.36 W/kg; SAR(10 g) = 1.52 W/kg
 Maximum value of SAR (measured) = 2.65 W/kg

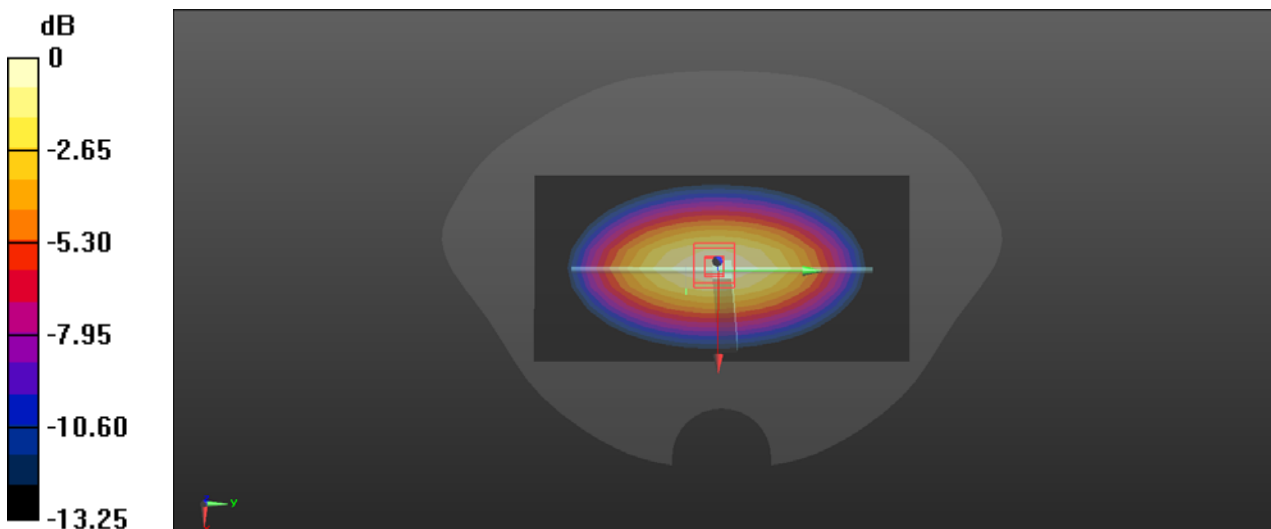

0 dB = 2.65 W/kg = 4.23 dBW/kg

System Performance Check 1900MHz

DUT: Dipole 1900 MHz; Type:D1900V2; Serial:5d206(2020-05-19)

Communication System: UID 0; Frequency: 1900 MHz;Duty Cycle: 1:1

Medium parameters used: $f = 1900 \text{ MHz}$; $\sigma = 1.388 \text{ S/m}$; $\epsilon_r = 40.495$; $\rho = 1000 \text{ kg/m}^3$

DASY5 Configuration:

- Probe: EX3DV4 - SN7557;ConvF(8.36, 8.36, 8.36); Calibrated: 10/4/2019
- Sensor-Surface: 4mm (Mechanical Surface Detection)
- Electronics: DAE4 Sn527; Calibrated: 6/13/2019
- Phantom: Twin-SAM; Type: QD 000 P41 Ax; Serial: 1963
- Measurement SW: DASY52, Version 52.10 (1); SEMCAD X Version 14.6.11 (7437)

System Performance Check 1900MHz/Area Scan (11x15x1): Measurement grid: $dx=10\text{mm}$, $dy=10\text{mm}$

Maximum value of SAR (measured) = 11.9 W/kg

System Performance Check 1900MHz/Zoom Scan (7x7x7)/Cube 0: Measurement grid: $dx=5\text{mm}$, $dy=5\text{mm}$, $dz=5\text{mm}$

Reference Value = 96.75 V/m; Power Drift = -0.16 dB

Peak SAR (extrapolated) = 18.9 W/kg

SAR(1 g) = 9.97 W/kg; SAR(10 g) = 5.25 W/kg

Maximum value of SAR (measured) = 11.4 W/kg

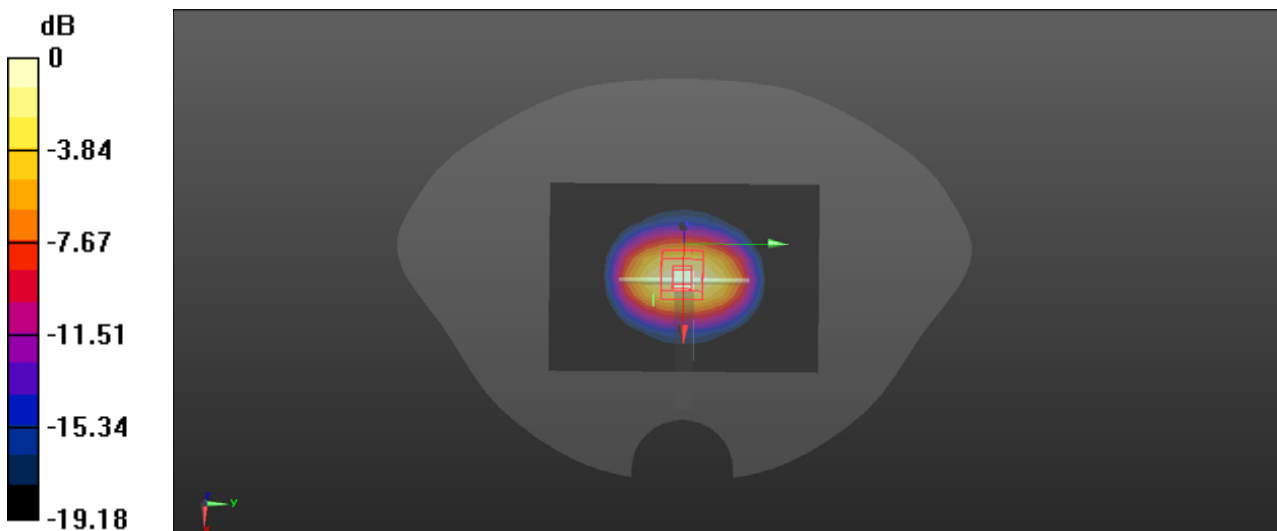

0 dB = 11.4 W/kg = 10.57 dBW/kg

System Performance Check 2450MHz

DUT: Dipole 2450 MHz; Type:D2450V2; Serial:970 (2020-05-21)

Communication System: UID 0; Frequency: 2450 MHz;Duty Cycle: 1:1

Medium parameters used: $f = 2450 \text{ MHz}$; $\sigma = 1.827 \text{ S/m}$; $\epsilon_r = 39.381$; $\rho = 1000 \text{ kg/m}^3$

DASY5 Configuration:

- Probe: EX3DV4 - SN7557;ConvF(7.41, 7.41, 7.41); Calibrated: 10/4/2019
- Sensor-Surface: 4mm (Mechanical Surface Detection)
- Electronics: DAE4 Sn527; Calibrated: 6/13/2019
- Phantom: Twin-SAM; Type: QD 000 P41 Ax; Serial: 1963
- Measurement SW: DASY52, Version 52.10 (1); SEMCAD X Version 14.6.11 (7437)

System Performance Check/2450MHz/Area Scan (11x13x1): Measurement grid: $dx=10\text{mm}$, $dy=10\text{mm}$
 Maximum value of SAR (measured) = 14.7 W/kg

System Performance Check/2450MHz/Zoom Scan (7x7x7)/Cube 0: Measurement grid: $dx=5\text{mm}$, $dy=5\text{mm}$, $dz=5\text{mm}$

Reference Value = 89.74 V/m; Power Drift = 0.01 dB

Peak SAR (extrapolated) = 28.0 W/kg

SAR(1 g) = 13.2 W/kg; SAR(10 g) = 6.15 W/kg

Maximum value of SAR (measured) = 15.1 W/kg

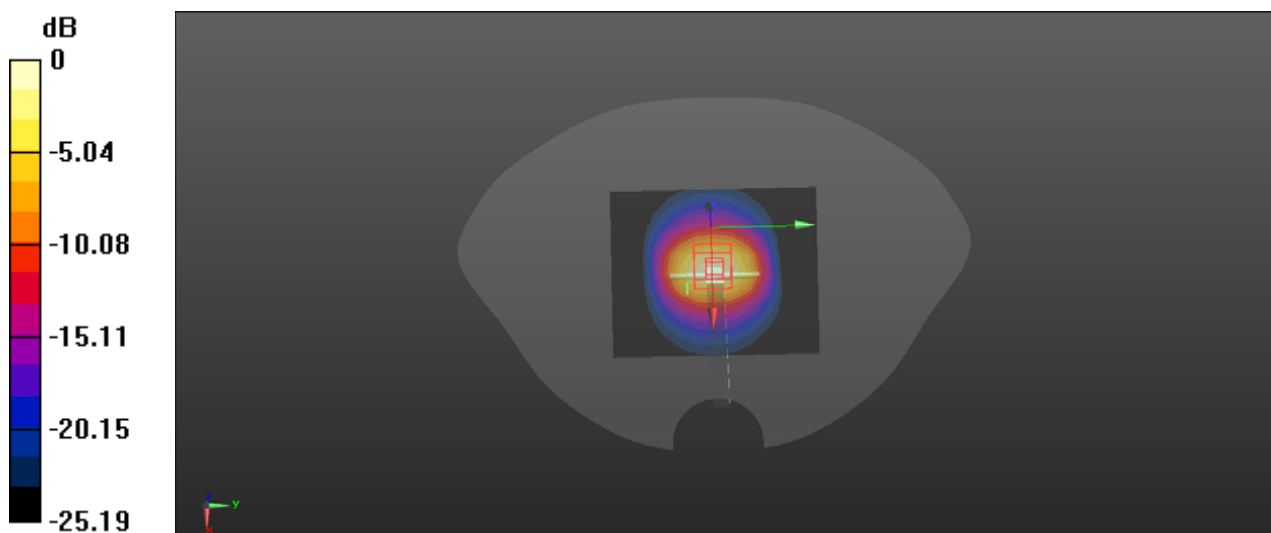

0 dB = 15.1 W/kg = 11.79 dBW/kg

System Performance Check 2600MHz

DUT: Dipole 2600 MHz; Type:D2600V2; Serial:1162 (2020-05-20)

Communication System: UID 0; Frequency: 2600 MHz;Duty Cycle: 1:1

Medium parameters used: f = 2600 MHz; $\sigma = 1.984 \text{ S/m}$; $\epsilon_r = 39.186$; $\rho = 1000 \text{ kg/m}^3$

DASY5 Configuration:

- Probe: EX3DV4 - SN7557;ConvF(7.21, 7.21, 7.21); Calibrated: 10/4/2019
- Sensor-Surface: 4mm (Mechanical Surface Detection)
- Electronics: DAE4 Sn527; Calibrated: 6/13/2019
- Phantom: Twin-SAM; Type: QD 000 P41 Ax; Serial: 1963
- Measurement SW: DASY52, Version 52.10 (1); SEMCAD X Version 14.6.11 (7437)

System Performance Check 2600MHz/Area Scan (9x13x1): Measurement grid: dx=10mm, dy=10mm
 Maximum value of SAR (measured) = 15.1 W/kg

System Performance Check 2600MHz/Zoom Scan (7x7x7)/Cube 0: Measurement grid: dx=5mm, dy=5mm, dz=5mm

Reference Value = 93.07 V/m; Power Drift = 0.02 dB

Peak SAR (extrapolated) = 26.3 W/kg

SAR(1 g) = 13.8 W/kg; SAR(10 g) = 6.32 W/kg

Maximum value of SAR (measured) = 14.8 W/kg

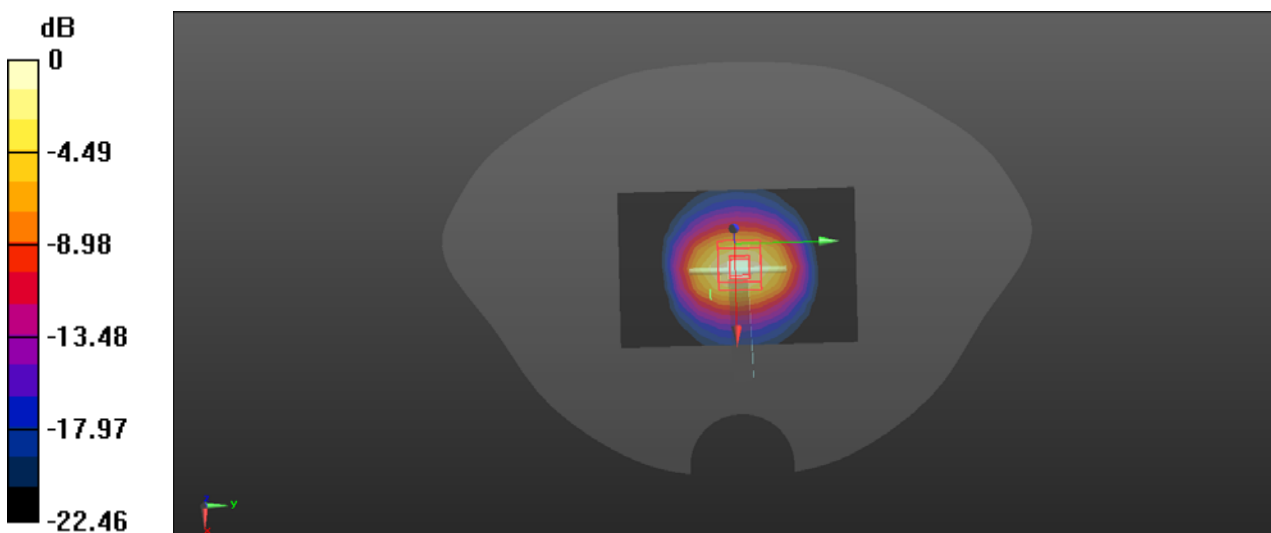

0 dB = 14.8 W/kg = 11.70 dBW/kg

System Performance Check 5.25GHz

DUT: Dipole 5GHzV2; Type:D5GHzV2; Serial:1296 (2020-05-22)

Communication System: UID 0; Frequency: 5250 MHz;Duty Cycle: 1:1
 Medium parameters used: f = 5250 MHz; $\sigma = 4.676$ S/m; $\epsilon_r = 36.083$; $\rho = 1000$ kg/m³

DASY5 Configuration:

- Probe: EX3DV4 - SN7557;ConvF(5.38, 5.38, 5.38); Calibrated: 10/4/2019
- Sensor-Surface: 4mm (Mechanical Surface Detection)
- Electronics: DAE4 Sn527; Calibrated: 6/13/2019
- Phantom: Twin-SAM; Type: QD 000 P41 Ax; Serial: 1963
- Measurement SW: DASY52, Version 52.10 (1); SEMCAD X Version 14.6.11 (7437)

System Performance Check 5GHz/Area Scan (9x9x1): Measurement grid: dx=10mm, dy=10mm
 Maximum value of SAR (measured) = 8.28 W/kg

System Performance Check 5GHz/Zoom Scan (8x8x7)/Cube 0: Measurement grid: dx=4mm, dy=4mm, dz=1.4mm

Reference Value = 44.62 V/m; Power Drift = 0.11 dB

Peak SAR (extrapolated) = 33.8 W/kg

SAR(1 g) = 7.92 W/kg; SAR(10 g) = 2.31 W/kg

Maximum value of SAR (measured) = 8.42 W/kg

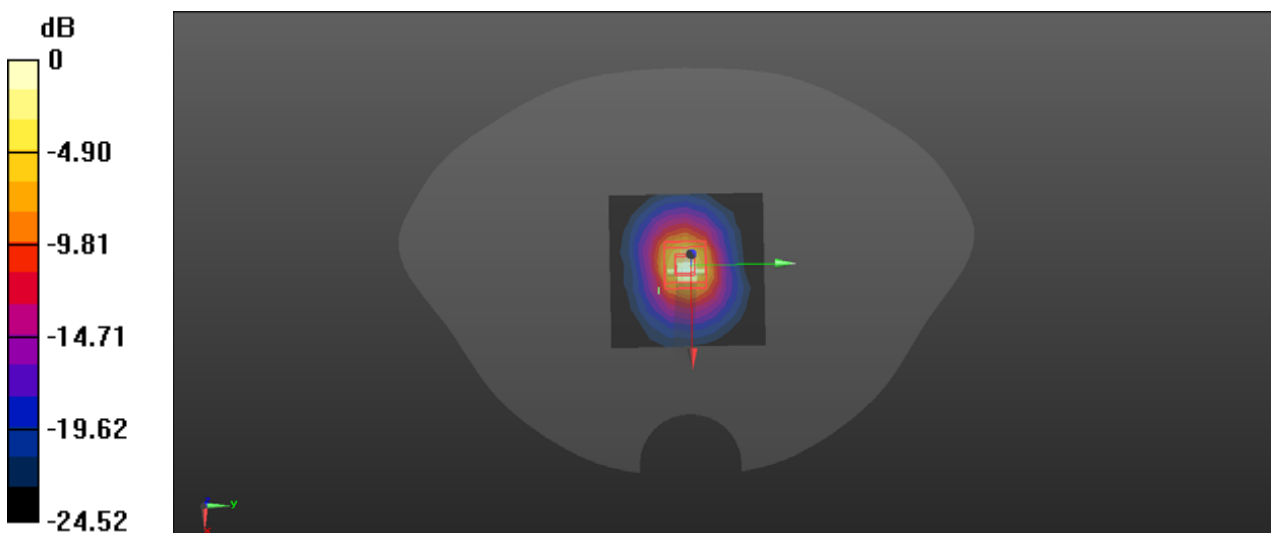

0 dB = 8.42 W/kg = 9.25 dBW/kg

System Performance Check 5.8GHz

DUT: Dipole 5GHzV2; Type:D5GHzV2; Serial:1296 (2020-05-22)

Communication System: UID 0; Frequency: 5800 MHz;Duty Cycle: 1:1

Medium parameters used: $f = 5800 \text{ MHz}$; $\sigma = 5.308 \text{ S/m}$; $\epsilon_r = 35.324$; $\rho = 1000 \text{ kg/m}^3$

DASY5 Configuration:

- Probe: EX3DV4 - SN7557;ConvF(4.7, 4.7, 4.7); Calibrated: 10/4/2019
- Sensor-Surface: 4mm (Mechanical Surface Detection)
- Electronics: DAE4 Sn527; Calibrated: 6/13/2019
- Phantom: Twin-SAM; Type: QD 000 P41 Ax; Serial: 1963
- Measurement SW: DASY52, Version 52.10 (1); SEMCAD X Version 14.6.11 (7437)

System Performance Check 5GHz/Area Scan (9x9x1): Measurement grid: $dx=10\text{mm}$, $dy=10\text{mm}$

Maximum value of SAR (measured) = 8.64 W/kg

System Performance Check 5GHz/Zoom Scan (8x8x7)/Cube 0: Measurement grid: $dx=4\text{mm}$, $dy=4\text{mm}$, $dz=1.4\text{mm}$

Reference Value = 45.85 V/m; Power Drift = -0.15 dB

Peak SAR (extrapolated) = 35.47 W/kg

SAR(1 g) = 8.07 W/kg; SAR(10 g) = 2.35 W/kg

Maximum value of SAR (measured) = 9.01 W/kg

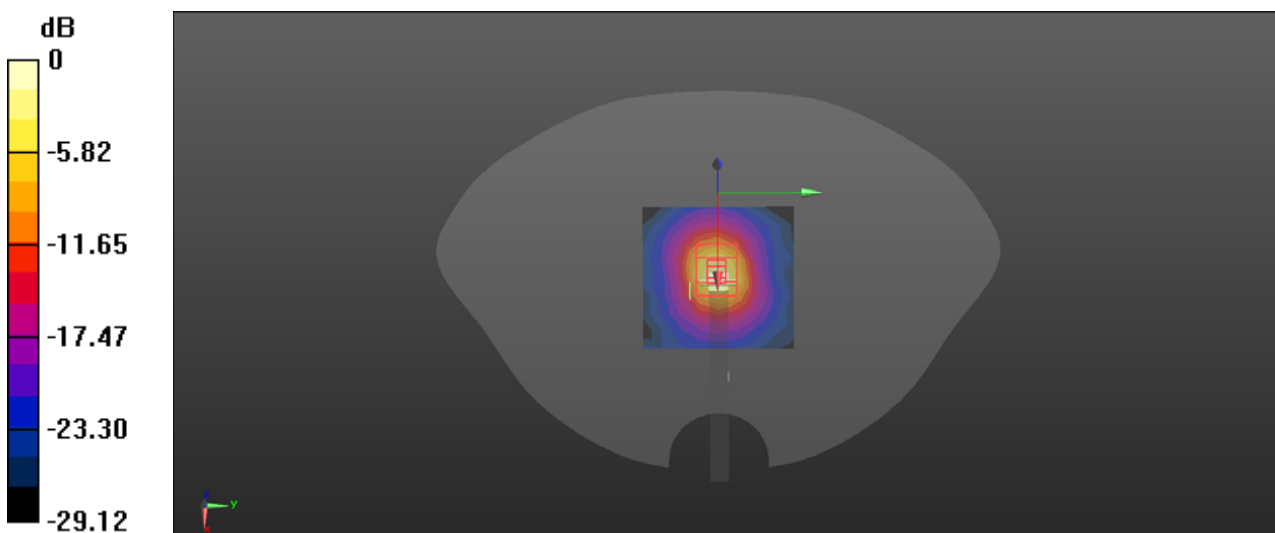

0 dB = 9.01 W/kg = 9.55 dBW/kg

EUT TEST STRATEGY AND METHODOLOGY

Test Positions for Device Operating Next to a Person’s Ear

This category includes most wireless handsets with fixed, retractable or internal antennas located toward the top half of the device, with or without a foldout, sliding or similar keypad cover. The handset should have its earpiece located within the upper ¼ of the device, either along the centerline or off-centered, as perceived by its users. This type of handset should be positioned in a normal operating position with the “test device reference point” located along the “vertical centerline” on the front of the device aligned to the “ear reference point”. The “test device reference point” should be located at the same level as the center of the earpiece region. The “vertical centerline” should bisect the front surface of the handset at its top and bottom edges. A “ear reference point” is located on the outer surface of the head phantom on each ear spacer. It is located 1.5 cm above the center of the ear canal entrance in the “phantom reference plane” defined by the three lines joining the center of each “ear reference point” (left and right) and the tip of the mouth.

A handset should be initially positioned with the earpiece region pressed against the ear spacer of a head phantom. For the SCC-34/SC-2 head phantom, the device should be positioned parallel to the “N-F” line defined along the base of the ear spacer that contains the “ear reference point”. For interim head phantoms, the device should be positioned parallel to the cheek for maximum RF energy coupling. The “test device reference point” is aligned to the “ear reference point” on the head phantom and the “vertical centerline” is aligned to the “phantom reference plane”. This is called the “initial ear position”. While maintaining these three alignments, the body of the handset is gradually adjusted to each of the following positions for evaluating SAR:

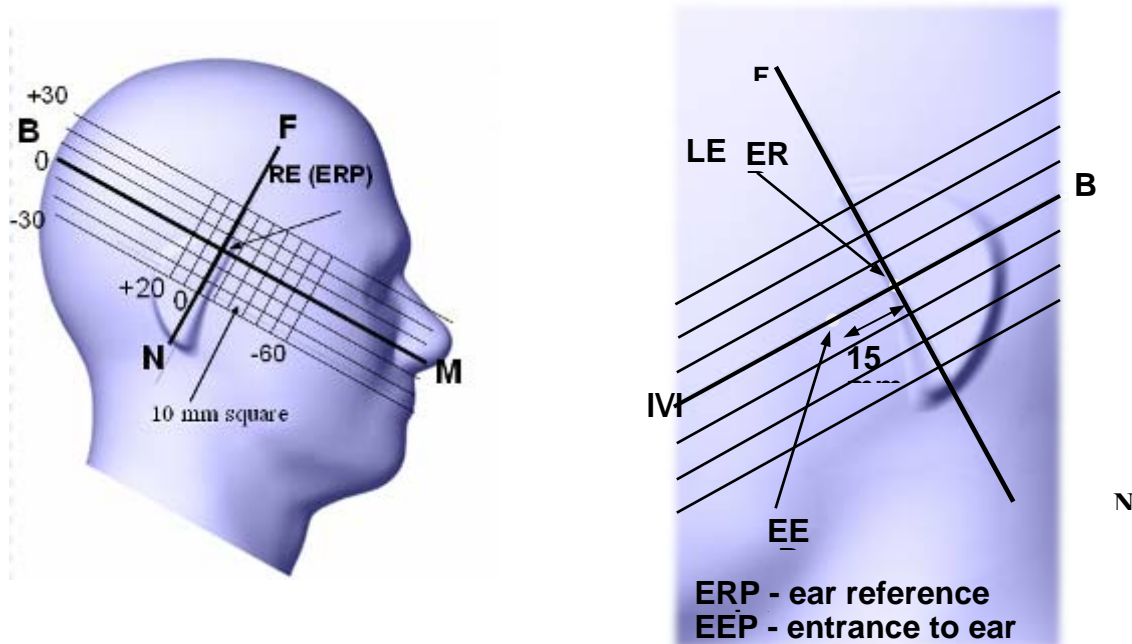

Cheek/Touch Position

The device is brought toward the mouth of the head phantom by pivoting against the “ear reference point” or along the “N-F” line for the SCC-34/SC-2 head phantom.

This test position is established:

When any point on the display, keypad or mouthpiece portions of the handset is in contact with the phantom.

(or) When any portion of a foldout, sliding or similar keypad cover opened to its intended self-adjusting normal use position is in contact with the cheek or mouth of the phantom.

For existing head phantoms – when the handset loses contact with the phantom at the pivoting point, rotation should continue until the device touches the cheek of the phantom or breaks its last contact from the ear spacer.

Cheek /Touch Position

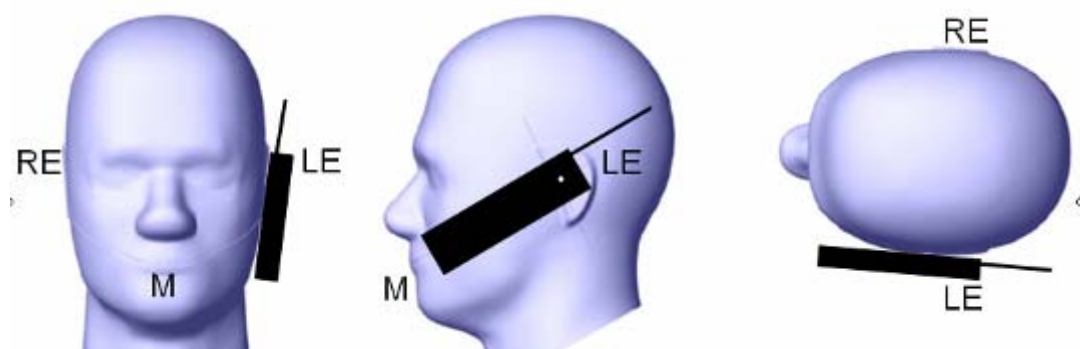

Ear/Tilt Position

With the handset aligned in the “Cheek/Touch Position”:

1) If the earpiece of the handset is not in full contact with the phantom’s ear spacer (in the “Cheek/Touch position”) and the peak SAR location for the “Cheek/Touch” position is located at the ear spacer region or corresponds to the earpiece region of the handset, the device should be returned to the “initial ear position” by rotating it away from the mouth until the earpiece is in full contact with the ear spacer.

2) (otherwise) The handset should be moved (translated) away from the cheek perpendicular to the line passes through both “ear reference points” (note: one of these ear reference points may not physically exist on a split head model) for approximate 2-3 cm. While it is in this position, the device handset is tilted away from the mouth with respect to the “test device reference point” until the inside angle between the vertical centerline on the front surface of the phone and the horizontal line passing through the ear reference point is by 15 80°. After the tilt, it is then moved (translated) back toward the head perpendicular to the line passes through both “ear reference points” until the device touches the phantom or the ear spacer. If the antenna touches the head first, the positioning process should be repeated with a tilt angle less than 15° so that the device and its antenna would touch the phantom simultaneously. This test position may require a device holder or positioner to achieve the translation and tilting with acceptable positioning repeatability.

If a device is also designed to transmit with its keypad cover closed for operating in the head position, such positions should also be considered in the SAR evaluation. The device should be tested on the left and right side of the head phantom in the “Cheek/Touch” and “Ear/Tilt” positions. When applicable, each configuration should be tested with the antenna in its fully extended and fully retracted positions. These test configurations should be tested at the high, middle and low frequency channels of each operating mode; for example, AMPS, CDMA, and TDMA. If the SAR measured at the middle channel for each test configuration (left, right, Cheek/Touch, Tilt/Ear, extended and retracted) is at least 2.0 dB lower than the SAR limit, testing at the high and low channels is optional for such test configuration(s). If the transmission band of the test device is less than 10 MHz, testing at the high and low frequency channels is optional.

Ear /Tilt 15° Position

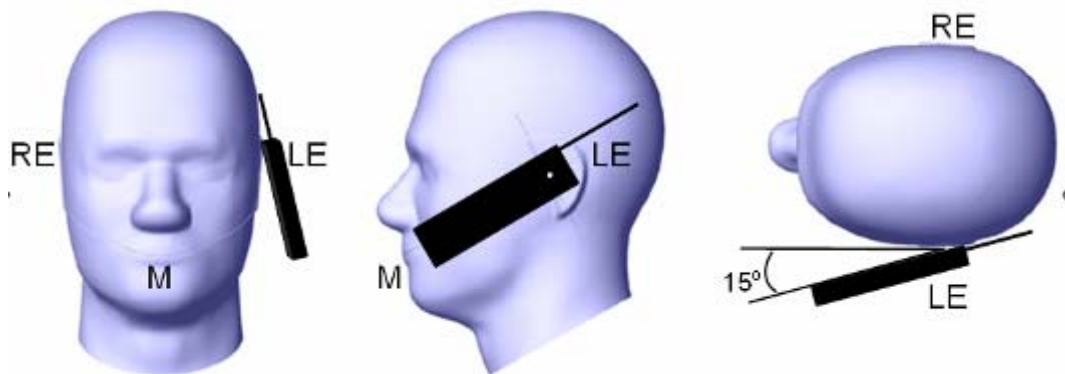

Test positions for body-worn and other configurations

Body-worn operating configurations should be tested with the belt-clips and holsters attached to the device and positioned against a flat phantom in normal use configurations. Devices with a headset output should be tested with a headset connected to the device. When multiple accessories that do not contain metallic components are supplied with the device, the device may be tested with only the accessory that dictates the closest spacing to the body. When multiple accessories that contain metallic components are supplied with the device, the device must be tested with each accessory that contains a unique metallic component. If multiple accessories share an identical metallic component (e.g., the same metallic belt-clip used with different holsters with no other metallic components), only the accessory that dictates the closest spacing to the body must be tested.

Body-worn accessories may not always be supplied or available as options for some devices that are intended to be authorized for body-worn use. A separation distance of 1.5 cm between the back of the device and a flat phantom is recommended for testing body-worn SAR compliance under such circumstances. Other separation distances may be used, but they should not exceed 2.5 cm. In these cases, the device may use body-worn accessories that provide a separation distance greater than that tested for the device provided however that the accessory contains no metallic components.

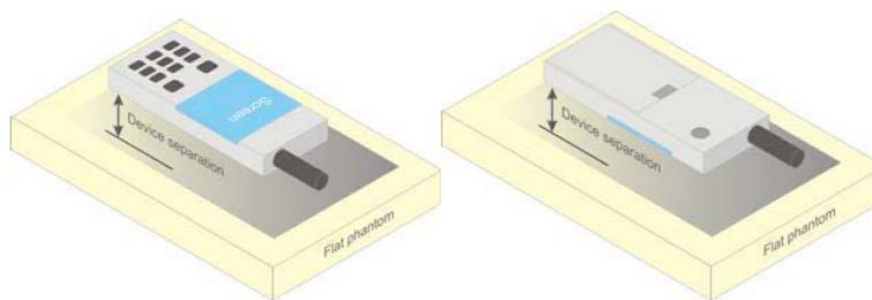

Figure 5 – Test positions for body-worn devices

Test Distance for SAR Evaluation

In this case the EUT(Equipment Under Test) is set against from the phantom, the test distance is 0mm.

SAR Evaluation Procedure

The evaluation was performed with the following procedure:

Step 1: Measurement of the SAR value at a fixed location above the ear point or central position was used as a reference value for assessing the power drop. The SAR at this point is measured at the start of the test and then again at the end of the testing.

Step 2: The SAR distribution at the exposed side of the head was measured at a distance of 4 mm from the inner surface of the shell. The area covered the entire dimension of the head or radiating structures of the EUT, the horizontal grid spacing was 15 mm x 15 mm, and the SAR distribution was determined by integrated grid of 1.5mm x 1.5mm. Based on these data, the area of the maximum absorption was determined by spline interpolation. The first Area Scan covers the entire dimension of the EUT to ensure that the hotspot was correctly identified.

Step 3: Around this point, a volume of 30 mm x 30 mm x 30 mm was assessed by measuring 7x 7 x 7 points. On the basis of this data set, the spatial peak SAR value was evaluated under the following procedure:

1) The data at the surface were extrapolated, since the center of the dipoles is 1.2 mm away from the tip of the probe and the distance between the surface and the lowest measuring point is 1.3 mm. The extrapolation was based on a least square algorithm. A polynomial of the fourth order was calculated through the points in z-axes. This polynomial was then used to evaluate the points between the surface and the probe tip.

2) The maximum interpolated value was searched with a straightforward algorithm. Around this maximum the SAR values averaged over the spatial volumes (1 g or 10 g) were computed by the 3D-Spline interpolation algorithm. The 3D-Spline is composed of three one dimensional splines with the "Not a knot"-condition (in x, y and z-directions). The volume was integrated with the trapezoidal-algorithm. One thousand points (10 x 10 x 10) were interpolated to calculate the averages.

All neighboring volumes were evaluated until no neighboring volume with a higher average value was found.

Step 4: Re-measurement of the SAR value at the same location as in Step 1. If the value changed by more than 5%, the evaluation was repeated.

CONDUCTED OUTPUT POWER MEASUREMENT

Provision Applicable

The measured peak output power should be greater and within 5% than EMI measurement.

Test Procedure

The RF output of the transmitter was connected to the input of the EMI Test Receiver through Connector.

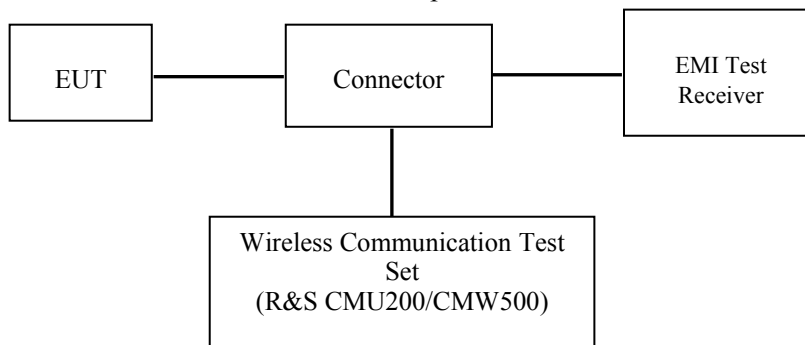

GSM/WCDMA/LTE

Radio Configuration

The power measurement was configured by the Wireless Communication Test Set.

GSM/GPRS/EGPRS

Function: Menu select > GSM Mobile Station > GSM 850/1900

Press Connection control to choose the different menus

Press RESET > choose all the reset all settings

Connection Press Signal Off to turn off the signal and change settings

Network Support > GSM + GPRS or GSM + EGSM

Main Service > Packet Data

Service selection > Test Mode A – Auto Slot Config. off

MS Signal Press Slot Config Bottom on the right twice to select and change the number of time slots and power setting

> Slot configuration > Uplink/Gamma

> 33 dBm for GPRS 850

> 30 dBm for GPRS 1900

> 27 dBm for EGPRS 850

> 26 dBm for EGPRS 1900

BS Signal Enter the same channel number for TCH channel (test channel) and BCCH channel

Frequency Offset > + 0 Hz

Mode > BCCH and TCH

BCCH Level > -85 dBm (May need to adjust if link is not stable)

BCCH Channel > choose desired test channel [Enter the same channel number for TCH channel (test channel) and BCCH channel]

Channel Type > Off

P0 > 4 dB

Slot Config > Unchanged (if already set under MS signal)

TCH > choose desired test channel

Hopping > Off

Main Timeslot > 3

Network Coding Scheme > CS4 (GPRS) and MCS5 (EGPRS)

Bit Stream > 2E9-1 PSR Bit Stream

AF/RF Enter appropriate offsets for Ext. Att. Output and Ext. Att. Input

Connection Press Signal on to turn on the signal and change settings

WCDMA Release 99

The following tests were conducted according to the test requirements outlines in section 5.2 of the 3GPP TS34.121-1 specification. The EUT has a nominal maximum output power of 24dBm (+1.7/-3.7).

WCDMA General Settings	Loopback Mode	Test Mode 1
	Rel99 RMC	12.2kbps RMC
	Power Control Algorithm	Algorithm2
	β_c/β_d	8/15

HSDPA

The following tests were conducted according to the test requirements outlines in section 5.2 of the 3GPP TS34.121-1 specification.

	Mode	HSDPA	HSDPA	HSDPA	HSDPA
	Subset	1	2	3	4
WCDMA General Settings	Loopback Mode	Test Mode 1			
	Rel99 RMC	12.2kbps RMC			
	HSDPA FRC	H-Set1			
	Power Control Algorithm	Algorithm2			
	β_c	2/15	12/15	15/15	15/15
	β_d	15/15	15/15	8/15	4/15
	$\beta_d(SF)$	64			
	β_c/β_d	2/15	12/15	15/8	15/4
	β_{hs}	4/15	24/15	30/15	30/15
MPR(dB)	0	0	0.5	0.5	
HSDPA Specific Settings	DACK	8			
	DNAK	8			
	DCQI	8			
	Ack-Nack repetition factor	3			
	CQI Feedback	4ms			
	CQI Repetition Factor	2			
	$A_{hs}=\beta_{hs}/\beta_c$	30/15			

HSUPA

The following tests were conducted according to the test requirements outlines in section 5.2 of the 3GPP TS34.121-1 specification.

	Mode	HSUPA	HSUPA	HSUPA	HSUPA	HSUPA
	Subset	1	2	3	4	5
WCDMA General Settings	Loopback Mode	Test Mode 1				
	Rel99 RMC	12.2kbps RMC				
	HSDPA FRC	H-Set1				
	HSUPA Test	HSUPA Loopback				
	Power Control Algorithm	Algorithm2				
	β_c	11/15	6/15	15/15	2/15	15/15
	β_d	15/15	15/15	9/15	15/15	0
	β_{cc}	209/225	12/15	30/15	2/15	5/15
	β_c / β_d	11/15	6/15	15/9	2/15	-
	β_{hs}	22/15	12/15	30/15	4/15	5/15
	CM(dB)	1.0	3.0	2.0	3.0	1.0
MPR(dB)	0	2	1	2	0	
HSDPA Specific Settings	DACK	8				
	DNAK	8				
	DCQI	8				
	Ack-Nack repetition factor	3				
	CQI Feedback	4ms				
	CQI Repetition Factor	2				
	$A_{hs} = \beta_{hs} / \beta_c$	30/15				
HSUPA Specific Settings	DE-DPCCH	6	8	8	5	7
	DHARQ	0	0	0	0	0
	AG Index	20	12	15	17	21
	ETFCI	75	67	92	71	81
	Associated Max UL Data Rate kbps	242.1	174.9	482.8	205.8	308.9
	Reference E_FCIs	E-TFCI 11 E E-TFCI PO 4 E-TFCI 67 E-TFCI PO 18 E-TFCI 71 E-TFCI PO23 E-TFCI 75 E-TFCI PO26 E-TFCI 81 E-TFCI PO 27	E-TFCI 11 E-TFCI PO4 E-TFCI 92 E-TFCI PO 18	E-TFCI 11 E-TFCI PO4 E-TFCI 71 E-TFCI PO23 E-TFCI 75 E-TFCI PO 18	E-TFCI 11 E E-TFCI PO 4 E-TFCI 67 E-TFCI PO 18 E-TFCI 71 E-TFCI PO23 E-TFCI 75 E-TFCI PO26 E-TFCI 81 E-TFCI PO 27	

DC-HSDPA

The following tests were conducted according to the test requirements in Table C.8.1.12 of 3GPP TS 34.121-1

Table C.8.1.12: Fixed Reference Channel H-Set 12

Parameter	Unit	Value
Nominal Avg. Inf. Bit Rate	kbps	60
Inter-TTI Distance	TTI's	1
Number of HARQ Processes	Processes	6
Information Bit Payload (N_{INF})	Bits	120
Number Code Blocks	Blocks	1
Binary Channel Bits Per TTI	Bits	960
Total Available SML's in UE	SML's	19200
Number of SML's per HARQ Proc.	SML's	3200
Coding Rate		0.15
Number of Physical Channel Codes	Codes	1
Modulation		QPSK
Note 1: The RMC is intended to be used for DC-HSDPA mode and both cells shall transmit with identical parameters as listed in the table. Note 2: Maximum number of transmission is limited to 1, i.e., retransmission is not allowed. The redundancy and constellation version 0 shall be used.		

HSPA+

Sub-test	β_c (Note3)	β_d	β_{HS} (Note1)	β_{ec}	β_{ed} (2xSF2) (Note 4)	β_{ed} (2xSF4) (Note 4)	CM (dB) (Note 2)	MPR (dB) (Note 2)	AG Index (Note 4)	E-TFCI (Note 5)	E-TFCI (boost)
1	1	0	30/15	30/15	β_{ed1} : 30/15 β_{ed2} : 30/15	β_{ed3} : 24/15 β_{ed4} : 24/15	3.5	2.5	14	105	105
Note 1: $\Delta_{ACK}, \Delta_{NACK}$ and $\Delta_{CQI} = 30/15$ with $\beta_{hs} = 30/15 * \beta_c$. Note 2: CM = 3.5 and the MPR is based on the relative CM difference, MPR = MAX(CM-1,0). Note 3: DPDCH is not configured, therefore the β_c is set to 1 and $\beta_d = 0$ by default. Note 4: β_{ed} can not be set directly; it is set by Absolute Grant Value. Note 5: All the sub-tests require the UE to transmit 2SF2+2SF4 16QAM EDCH and they apply for UE using E-DPDCH category 7. E-DCH TTI is set to 2ms TTI and E-DCH table index = 2. To support these E-DCH configurations DPDCH is not allocated. The UE is signalled to use the extrapolation algorithm.											

The following tests were conducted according to the test requirements in Table C.11.1.4 of 3GPP TS 34.121-1

FDD-LTE

For UE Power Class 1 and 3, the allowed Maximum Power Reduction (MPR) for the maximum output power in Table 6.2.2-1 due to higher order modulation and transmit bandwidth configuration (resource blocks) is specified in Table 6.2.3-1.

Table 6.2.3-1: Maximum Power Reduction (MPR) for Power Class 1 and 3

Modulation	Channel bandwidth / Transmission bandwidth (N_{RB})						MPR (dB)
	1.4 MHz	3.0 MHz	5 MHz	10 MHz	15 MHz	20 MHz	
QPSK	> 5	> 4	> 8	> 12	> 16	> 18	≤ 1
16 QAM	≤ 5	≤ 4	≤ 8	≤ 12	≤ 16	≤ 18	≤ 1
16 QAM	> 5	> 4	> 8	> 12	> 16	> 18	≤ 2

For UE Power Class 1 and 3 the specific requirements and identified sub clauses are specified in Table 6.2.4-1 along with the allowed A-MPR values that may be used to meet these requirements. The allowed A-MPR values specified below in Table 6.2.4-1 to 6.2.4-15 are in addition to the allowed MPR requirements specified in sub clause 6.2.3.

Table 6.2.4-1: Additional Maximum Power Reduction (A-MPR)

Network Signalling value	Requirements (subclause)	E-UTRA Band	Channel bandwidth (MHz)	Resources Blocks (N_{RB})	A-MPR (dB)
NS_01	6.6.2.1.1	Table 5.5-1	1.4, 3, 5, 10, 15, 20	Table 5.6-1	N/A
NS_03	6.6.2.2.1	2, 4, 10, 23, 25, 35, 36	3	>5	≤ 1
			5	>6	≤ 1
			10	>6	≤ 1
			15	>8	≤ 1
			20	>10	≤ 1
NS_04	6.6.2.2.2	41	5	>6	≤ 1
NS_05	6.6.3.3.1	1	10, 15, 20	Table 6.2.4-4	≤ 1
NS_06	6.6.2.2.3	12, 13, 14, 17	1.4, 3, 5, 10	Table 5.6-1	N/A
NS_07	6.6.2.2.3	13	10	Table 6.2.4-2	
6.6.3.3.2					
NS_08	6.6.3.3.3	19	10, 15	> 44	≤ 3
NS_09	6.6.3.3.4	21	10, 15	> 40	≤ 1
				> 55	≤ 2
NS_10		20	15, 20	Table 6.2.4-3	
NS_11	6.6.2.2.1	23	1.4, 3, 5, 10, 15, 20	Table 6.2.4-5	
NS_12	6.6.3.3.5	26	1.4, 3, 5	Table 6.2.4-6	
NS_13	6.6.3.3.6	26	5	Table 6.2.4-7	
NS_14	6.6.3.3.7	26	10, 15	Table 6.2.4-8	
NS_15	6.6.3.3.8	26	1.4, 3, 5, 10, 15	Table 6.2.4-9 Table 6.2.4-10	
NS_16	6.6.3.3.9	27	3, 5, 10	Table 6.2.4-11, Table 6.2.4-12, Table 6.2.4-13	
NS_17	6.6.3.3.10	28	5, 10	Table 5.6-1	N/A
NS_18	6.6.3.3.11	28	5	≥ 2	≤ 1
			10, 15, 20	≥ 1	≤ 4
NS_19	6.6.3.3.12	44	10, 15, 20	Table 6.2.4-14	
NS_20	6.2.2 6.6.2.2.1 6.6.3.2	23	5, 10, 15, 20	Table 6.2.4-15	
...					
NS_32	-	-	-	-	-

Maximum Target Output Power

Max Target Power(dBm)			
Mode/Band	Channel		
	Low	Middle	High
GPRS 850 1 TX Slot	33.5	33.5	33.5
GPRS 850 2 TX Slot	33.5	33.5	33.5
GPRS 850 3 TX Slot	33.5	33.5	33.5
GPRS 850 4 TX Slot	33.0	33.0	33.0
EDGE 850 1 TX Slot	27.0	27.0	27.0
EDGE 850 2 TX Slot	27.0	27.0	27.0
EDGE 850 3 TX Slot	26.0	26.0	26.0
EDGE 850 4 TX Slot	26.0	26.0	26.0
GPRS 1900 1 TX Slot	32.0	32.0	32.0
GPRS 1900 2 TX Slot	30.0	30.0	30.0
GPRS 1900 3 TX Slot	30.0	30.0	30.0
GPRS 1900 4 TX Slot	29.0	29.0	29.0
EDGE 1900 1 TX Slot	26.0	26.0	26.0
EDGE 1900 2 TX Slot	26.0	26.0	26.0
EDGE 1900 3 TX Slot	25.0	25.0	25.0
EDGE 1900 4 TX Slot	25.0	25.0	25.0
WCDMA Band 2	23.0	23.0	23.0
HSDPA	23.0	23.0	23.0
HSUPA	23.0	23.0	23.0
HSPA+	23.0	23.0	23.0
WCDMA Band 5	23.0	23.0	23.0
HSDPA	23.0	23.0	23.0
HSUPA	23.0	23.0	23.0
HSPA+	23.0	23.0	23.0
LTE Band 5	22.0	22.0	22.0
LTE Band 7	22.0	22.0	22.0
LTE Band 38	22.0	22.0	22.0
LTE Band 41	22.0	22.0	22.0
WLAN 2.4G(802.11b)	18.0	18.0	18.0
WLAN 2.4G(802.11g)	14.0	14.0	14.0
WLAN 2.4G(802.11n HT20)	13.0	13.0	13.0
WLAN 5.2G(802.11a)	12.0	12.0	12.0
WLAN 5.2G(802.11 n HT20)	12.0	12.0	12.0
WLAN 5.8G(802.11a)	12.0	12.0	12.0
WLAN 5.8G(802.11 n HT20)	12.0	12.0	12.0
Bluetooth BDR/EDR	5.0	5.4	5.0

Test Results:

GPRS:

Band	Channel No.	Frequency (MHz)	RF Output Power (dBm)			
			1 slot	2 slots	3 slots	4 slots
GSM 850	128	824.2	33.43	33.19	32.72	32.12
	190	836.6	33.21	32.56	32.26	31.95
	251	848.8	33.41	33.28	33.02	32.25
PCS 1900	512	1850.2	31.56	29.81	29.05	28.52
	661	1880.0	30.92	29.21	28.51	28.11
	810	1909.8	31.24	29.56	28.90	28.49

EDGE:

Band	Channel No.	Frequency (MHz)	RF Output Power (dBm)			
			1 slot	2 slots	3 slots	4 slots
GSM 850	128	824.2	26.41	26.12	25.81	25.66
	190	836.6	26.23	26.03	25.72	25.35
	251	848.8	26.35	26.01	25.71	25.45
PCS 1900	512	1850.2	24.65	23.97	23.46	22.86
	661	1880.0	25.06	24.63	23.73	23.24
	810	1909.8	25.72	25.22	24.52	24.17

For SAR, the time based average power is relevant, the difference in between depends on the duty cycle of the TDMA signal.

Number of Time slot	1	2	3	4
Duty Cycle	1:8	1:4	1:2.66	1:2
Time based Ave. power compared to slotted Ave. power	-9 dB	-6 dB	-4.25 dB	-3 dB
Crest Factor	8	4	2.66	2

The time based average power for GPRS

Band	Channel No.	Frequency (MHz)	Time based average Power (dBm)			
			1 slot	2 slot	3 slots	4 slots
GSM 850	128	824.2	24.43	27.19	28.47	29.12
	190	836.6	24.21	26.56	28.01	28.95
	251	848.8	24.41	27.28	28.77	29.25
PCS 1900	512	1850.2	22.56	23.81	24.80	25.52
	661	1880	21.92	23.21	24.26	25.11
	810	1909.8	22.24	23.56	24.65	25.49

The time based average power for EDGE

Band	Channel No.	Frequency (MHz)	Time based average Power (dBm)			
			1 slot	2 slot	3 slots	4 slots
GSM 850	128	824.2	17.41	20.12	21.56	22.66
	190	836.6	17.23	20.03	21.47	22.35
	251	848.8	17.35	20.01	21.46	22.45
PCS 1900	512	1850.2	15.65	17.97	19.21	19.86
	661	1880	16.06	18.63	19.48	20.24
	810	1909.8	16.72	19.22	20.27	21.17

Note:

1. Rohde & Schwarz Radio Communication Tester (CMU200) was used for the measurement of GSM peak and average output power for active timeslots.
2. For GSM voice, 1 timeslot has been activated with power level 5 (850 MHz band) and 0 (1900 MHz band).
3. For GPRS, 1, 2, 3 and 4 timeslots has been activated separately with power level 3(850 MHz band) and 3(1900 MHz band).
4. According to KDB941225D01-SAR for EGPRS mode are not required when the source-based time-averaged output power for data mode is lower than that in the normal GPRS mode.

WCDMA:

WCDMA Band II

Mode	Test Condition	Test Mode	3GPP Sub Test	Average Output Power (dBm)		
				Low Frequency	Middle Frequency	High Frequency
WCDMA (Band II)	Normal	Rel 99	1	22.85	22.73	22.82
		HSDPA	1	22.32	22.16	22.10
			2	22.17	22.09	22.17
			3	22.29	22.09	22.19
			4	22.31	22.12	22.20
		HSUPA	1	22.28	22.04	22.22
			2	22.30	22.14	22.24
			3	22.25	22.11	22.23
			4	22.27	22.09	22.13
			5	22.23	22.00	22.10
		HSPA+	1	22.33	22.01	22.18

WCDMA Band V

Mode	Test Condition	Test Mode	3GPP Sub Test	Average Output Power (dBm)		
				Low Frequency	Middle Frequency	High Frequency
WCDMA (Band V)	Normal	Rel 99	1	22.78	22.83	22.94
		HSDPA	1	22.10	21.99	22.09
			2	21.99	22.11	22.11
			3	22.09	22.10	22.20
			4	22.18	21.98	22.20
		HSUPA	1	22.07	22.07	22.08
			2	21.95	22.02	22.15
			3	22.07	22.10	22.16
			4	22.05	21.96	22.22
			5	21.95	22.07	22.10
		HSPA+	1	22.03	22.11	22.18

Note:

1. The default test configuration is to measure SAR with an established radio link between the EUT and a communication test set using a 12.2 kbps RMC (reference measurement Channel) Configured in Test Loop Model 1.
2. KDB 941225 D01-Body SAR is not required for HSDPA/HSUPA/HSPA+ when the maximum average output of each RF channel is less than ¼ dB higher than measured 12.2kbps RMC or the maximum SAR for 12.2kbps RMC is < 75% of SAR limit.

LTE Band 5:

Test Bandwidth	Test Modulation	Resource Block & RB offset	Target MPR	Meas MPR	Low Channel (dBm)	Middle Channel (dBm)	High Channel (dBm)
1.4M	QPSK	1#0	0	0	21.62	21.93	21.79
		1#2	0	0	21.54	21.46	21.67
		1#5	0	0	21.64	21.85	21.57
		3#0	1	1	21.63	21.47	21.53
		3#1	1	1	21.59	21.85	21.54
		3#2	1	1	21.60	21.62	21.51
		6#0	1	1	21.11	21.04	21.19
	16-QAM	1#0	1	1	21.57	21.92	21.46
		1#2	1	1	21.54	21.97	21.44
		1#5	1	1	21.54	21.95	21.45
		3#0	2	2	21.58	21.93	21.40
		3#1	2	2	21.58	21.83	21.53
		3#2	2	2	21.63	21.86	21.50
		6#0	2	2	21.16	21.29	21.40
3M	QPSK	1#0	0	0	21.62	21.75	21.42
		1#7	0	0	21.60	21.63	21.38
		1#14	0	0	21.54	21.66	21.31
		8#0	1	1	21.59	21.73	21.34
		8#4	1	1	21.58	21.67	21.40
		8#7	1	1	21.48	21.60	21.39
		15#0	1	1	21.43	21.26	21.43
	16-QAM	1#0	1	1	21.33	21.72	21.53
		1#7	1	1	21.45	21.67	21.54
		1#14	1	1	21.47	21.63	21.52
		8#0	2	2	21.40	21.59	21.46
		8#4	2	2	21.43	21.52	21.38
		8#7	2	2	21.51	21.58	21.38
		15#0	2	2	21.48	21.50	21.47

Test Bandwidth	Test Modulation	Resource Block & RB offset	Target MPR	Meas MPR	Low Channel (dBm)	Middle Channel (dBm)	High Channel (dBm)
5M	QPSK	1#0	0	0	21.51	21.57	21.52
		1#12	0	0	21.40	21.63	21.58
		1#24	0	0	21.31	21.64	21.65
		12#0	1	1	21.39	21.64	21.58
		12#6	1	1	21.41	21.72	21.55
		12#11	1	1	21.42	21.74	21.50
		25#0	1	1	21.46	21.68	21.38
	16-QAM	1#0	1	1	21.40	21.68	21.49
		1#12	1	1	21.40	21.68	21.53
		1#24	1	1	21.43	21.76	21.54
		12#0	2	2	21.43	21.74	21.57
		12#6	2	2	21.49	21.74	21.60
		12#11	2	2	21.56	21.81	21.56
		25#0	2	2	21.63	21.78	21.59
10M	QPSK	1#0	0	0	21.63	21.83	21.55
		1#24	0	0	21.73	21.95	21.50
		1#49	0	0	21.75	21.63	21.50
		25#0	1	1	21.39	21.14	21.24
		25#12	1	1	21.75	21.27	21.60
		25#24	1	1	21.67	21.07	21.49
		50#0	1	1	20.89	21.01	21.08
	16-QAM	1#0	1	1	21.65	21.97	21.41
		1#24	1	1	21.65	21.96	21.49
		1#49	1	1	21.68	21.94	21.48
		25#0	2	2	21.73	21.80	21.47
		25#12	2	2	21.66	21.83	21.47
		25#24	2	2	21.65	21.84	21.39
		50#0	2	2	21.50	21.66	21.41

LTE Band 7:

Test Bandwidth	Test Modulation	Resource Block & RB offset	Target MPR	Meas MPR	Low Channel (dBm)	Middle Channel (dBm)	High Channel (dBm)
5M	QPSK	1#0	0	0	21.79	21.34	21.10
		1#12	0	0	21.86	21.32	21.80
		1#24	0	0	21.38	21.67	21.97
		12#0	1	1	21.47	21.34	21.37
		12#6	1	1	21.39	21.48	21.83
		12#11	1	1	21.93	21.56	21.98
		25#0	1	1	21.60	21.24	21.18
	16-QAM	1#0	1	1	21.67	21.67	21.81
		1#12	1	1	21.85	21.46	21.40
		1#24	1	1	21.55	21.68	21.56
		12#0	2	2	21.43	21.60	21.57
		12#6	2	2	21.78	21.24	21.97
		12#11	2	2	21.31	21.84	21.84
		25#0	2	2	21.54	21.53	21.42
10M	QPSK	1#0	0	0	21.33	21.40	21.95
		1#24	0	0	21.82	21.57	21.59
		1#49	0	0	21.53	21.65	21.58
		25#0	1	1	21.61	21.57	21.96
		25#12	1	1	21.10	21.85	21.87
		25#24	1	1	21.38	21.23	21.56
		50#0	1	1	21.67	21.21	21.33
	16-QAM	1#0	1	1	21.86	21.42	21.74
		1#24	1	1	21.21	21.65	21.55
		1#49	1	1	21.39	21.85	21.40
		25#0	2	2	21.70	21.56	21.90
		25#12	2	2	21.13	21.37	21.51
		25#24	2	2	21.68	21.54	21.81
		50#0	2	2	21.05	21.87	21.81

Test Bandwidth	Test Modulation	Resource Block & RB offset	Target MPR	Meas MPR	Low Channel (dBm)	Middle Channel (dBm)	High Channel (dBm)
15M	QPSK	1#0	0	0	21.39	21.31	21.70
		1#37	0	0	21.58	21.55	21.25
		1#74	0	0	21.64	21.12	21.22
		36#0	1	1	21.02	21.32	21.44
		36#17	1	1	21.55	21.37	21.59
		36#35	1	1	20.89	21.44	21.42
		75#0	1	1	21.50	21.28	21.80
	16-QAM	1#0	1	1	21.00	21.62	21.87
		1#37	1	1	20.98	21.73	21.95
		1#74	1	1	21.18	21.82	21.12
		36#0	2	2	20.91	21.49	21.81
		36#17	2	2	21.31	21.93	21.83
		36#35	2	2	21.06	21.14	21.92
		75#0	2	2	20.98	21.20	21.33
20M	QPSK	1#0	0	0	21.75	21.82	21.90
		1#49	0	0	20.94	21.58	21.76
		1#99	0	0	21.62	21.48	20.88
		50#0	1	1	21.49	21.29	21.30
		50#24	1	1	21.37	21.44	21.34
		50#49	1	1	21.49	21.39	20.93
		100#0	1	1	21.14	21.15	20.86
	16-QAM	1#0	1	1	21.34	21.45	21.57
		1#49	1	1	20.97	21.26	21.54
		1#99	1	1	21.63	21.07	21.59
		50#0	2	2	21.26	21.07	21.50
		50#24	2	2	21.12	21.71	21.44
		50#49	2	2	21.16	21.64	21.23
		100#0	2	2	21.07	21.19	21.09

LTE Band 38:

Test Bandwidth	Test Modulation	Resource Block & RB offset	Target MPR	Meas MPR	Low Channel (dBm)	Middle Channel (dBm)	High Channel (dBm)
5M	QPSK	1#0	0	0	21.85	21.29	21.42
		1#12	0	0	21.69	21.46	21.25
		1#24	0	0	21.38	21.68	21.48
		12#0	1	1	21.32	21.78	21.03
		12#6	1	1	21.54	21.78	21.41
		12#11	1	1	21.58	21.67	21.15
		25#0	1	1	21.96	21.33	21.86
	16-QAM	1#0	1	1	21.40	21.33	21.68
		1#12	1	1	21.78	21.11	21.29
		1#24	1	1	21.36	21.28	21.32
		12#0	2	2	21.77	21.56	21.98
		12#6	2	2	21.75	21.69	21.24
		12#11	2	2	21.86	21.32	21.07
		25#0	2	2	21.84	21.48	21.52
10M	QPSK	1#0	0	0	21.40	21.49	21.87
		1#24	0	0	21.64	21.23	21.95
		1#49	0	0	21.38	21.88	21.69
		25#0	1	1	21.65	21.69	21.74
		25#12	1	1	21.90	21.15	21.50
		25#24	1	1	21.17	21.95	21.79
		50#0	1	1	21.73	21.67	21.52
	16-QAM	1#0	1	1	21.47	21.95	21.35
		1#24	1	1	21.34	21.89	21.87
		1#49	1	1	21.05	21.35	21.50
		25#0	2	2	21.15	21.89	21.66
		25#12	2	2	21.81	21.55	21.08
		25#24	2	2	21.98	21.88	21.44
		50#0	2	2	21.21	21.41	21.32

Test Bandwidth	Test Modulation	Resource Block & RB offset	Target MPR	Meas MPR	Low Channel (dBm)	Middle Channel (dBm)	High Channel (dBm)
15M	QPSK	1#0	0	0	21.64	21.32	21.75
		1#37	0	0	21.05	21.28	21.47
		1#74	0	0	20.78	21.44	21.34
		36#0	1	1	20.99	21.69	21.92
		36#17	1	1	21.18	21.56	21.95
		36#35	1	1	21.08	21.20	21.68
		75#0	1	1	20.84	21.87	21.87
	16-QAM	1#0	1	1	21.58	21.19	21.34
		1#37	1	1	20.96	21.55	21.21
		1#74	1	1	20.97	21.53	21.64
		36#0	2	2	21.20	21.29	21.56
		36#17	2	2	21.61	21.45	21.54
		36#35	2	2	21.16	21.85	21.55
		75#0	2	2	21.39	21.75	21.94
20M	QPSK	1#0	0	0	21.66	21.86	21.70
		1#49	0	0	21.30	21.29	21.56
		1#99	0	0	21.53	21.48	21.06
		50#0	1	1	21.30	21.08	21.49
		50#24	1	1	21.01	21.56	20.86
		50#49	1	1	21.16	21.02	21.36
		100#0	1	1	21.09	21.07	20.89
	16-QAM	1#0	1	1	21.43	21.76	21.74
		1#49	1	1	21.75	21.85	21.51
		1#99	1	1	21.36	21.80	21.41
		50#0	2	2	21.54	21.03	21.46
		50#24	2	2	21.35	21.50	21.44
		50#49	2	2	21.39	21.06	21.75
		100#0	2	2	21.11	21.19	21.36

LTE Band 41:

Test Bandwidth	Test Modulation	Resource Block & RB offset	Target MPR	Meas MPR	Low Channel (dBm)	Middle Channel (dBm)	High Channel (dBm)
5M	QPSK	1#0	0	0	21.93	21.89	21.94
		1#12	0	0	21.34	21.41	21.54
		1#24	0	0	21.85	21.26	21.15
		12#0	1	1	21.68	21.45	21.69
		12#6	1	1	21.32	21.74	21.84
		12#11	1	1	21.82	21.86	21.87
		25#0	1	1	21.58	21.86	21.08
	16-QAM	1#0	1	1	21.96	21.40	21.82
		1#12	1	1	21.97	21.52	21.41
		1#24	1	1	21.45	21.49	21.75
		12#0	2	2	21.92	21.59	21.76
		12#6	2	2	21.63	21.70	21.13
		12#11	2	2	21.56	21.64	21.53
		25#0	2	2	21.54	21.21	21.93
10M	QPSK	1#0	0	0	21.31	21.94	21.77
		1#24	0	0	21.93	21.45	21.61
		1#49	0	0	21.71	21.53	21.22
		25#0	1	1	21.85	21.74	21.43
		25#12	1	1	21.99	21.19	21.54
		25#24	1	1	21.98	21.45	21.42
		50#0	1	1	21.47	21.73	21.35
	16-QAM	1#0	1	1	21.27	21.82	21.85
		1#24	1	1	21.65	21.77	21.84
		1#49	1	1	21.55	21.70	21.61
		25#0	2	2	21.51	21.18	21.25
		25#12	2	2	21.23	21.61	21.85
		25#24	2	2	21.83	21.77	21.62
		50#0	2	2	21.81	21.24	21.23

Test Bandwidth	Test Modulation	Resource Block & RB offset	Target MPR	Meas MPR	Low Channel (dBm)	Middle Channel (dBm)	High Channel (dBm)
15M	QPSK	1#0	0	0	21.54	21.75	21.70
		1#37	0	0	20.88	21.65	21.82
		1#74	0	0	21.50	21.75	21.79
		36#0	1	1	21.51	21.78	21.35
		36#17	1	1	21.69	21.74	21.78
		36#35	1	1	21.46	21.57	21.16
		75#0	1	1	21.28	21.25	21.98
	16-QAM	1#0	1	1	21.56	21.65	21.45
		1#37	1	1	21.17	21.24	21.57
		1#74	1	1	21.04	21.64	21.55
		36#0	2	2	21.25	21.96	21.77
		36#17	2	2	21.17	21.07	21.73
		36#35	2	2	21.03	21.76	21.53
		75#0	2	2	21.23	21.17	21.89
20M	QPSK	1#0	0	0	21.64	21.78	21.78
		1#49	0	0	21.44	21.22	21.07
		1#99	0	0	21.72	20.95	21.69
		50#0	1	1	21.22	21.32	21.43
		50#24	1	1	21.39	21.25	21.39
		50#49	1	1	21.57	21.74	21.67
		100#0	1	1	20.79	21.06	21.13
	16-QAM	1#0	1	1	21.60	21.39	21.32
		1#49	1	1	20.93	21.73	20.93
		1#99	1	1	21.39	21.54	21.55
		50#0	2	2	21.05	21.04	21.17
		50#24	2	2	20.95	21.80	21.19
		50#49	2	2	21.10	21.45	21.67
		100#0	2	2	21.15	20.83	21.02

WLAN 2.4G:

Mode	Channel frequency (MHz)	Data Rate	Conducted Average Output Power(dBm)
802.11b	2412	1Mbps	17.24
	2437		17.68
	2462		17.52
802.11g	2412	6Mbps	12.23
	2437		12.71
	2462		13.71
802.11n HT20	2412	MCS0	11.42
	2437		12.52
	2462		12.59

WLAN 5.2G:

Mode	Channel frequency (MHz)	Data Rate	Conducted Average Output Power(dBm)
802.11a	5180	6Mbps	11.47
	5200		11.68
	5240		11.35
802.11 n HT20	5180	MCS0	11.45
	5200		11.51
	5240		11.32

WLAN 5.8G:

Mode	Channel frequency (MHz)	Data Rate	Conducted Average Output Power(dBm)
802.11a	5745	6Mbps	11.03
	5785		11.37
	5825		11.21
802.11 n HT20	5745	MCS0	10.98
	5785		11.19
	5825		11.05

Bluetooth:

Mode	Channel frequency (MHz)	RF Output Power (dBm)
BDR(GFSK)	2402	4.12
	2441	5.25
	2480	4.08
EDR($\pi/4$ -DQPSK)	2402	4.06
	2441	5.21
	2480	3.98
EDR(8DPSK)	2402	4.37
	2441	5.03
	2480	3.86

Standalone SAR test exclusion considerations

Antennas Location:

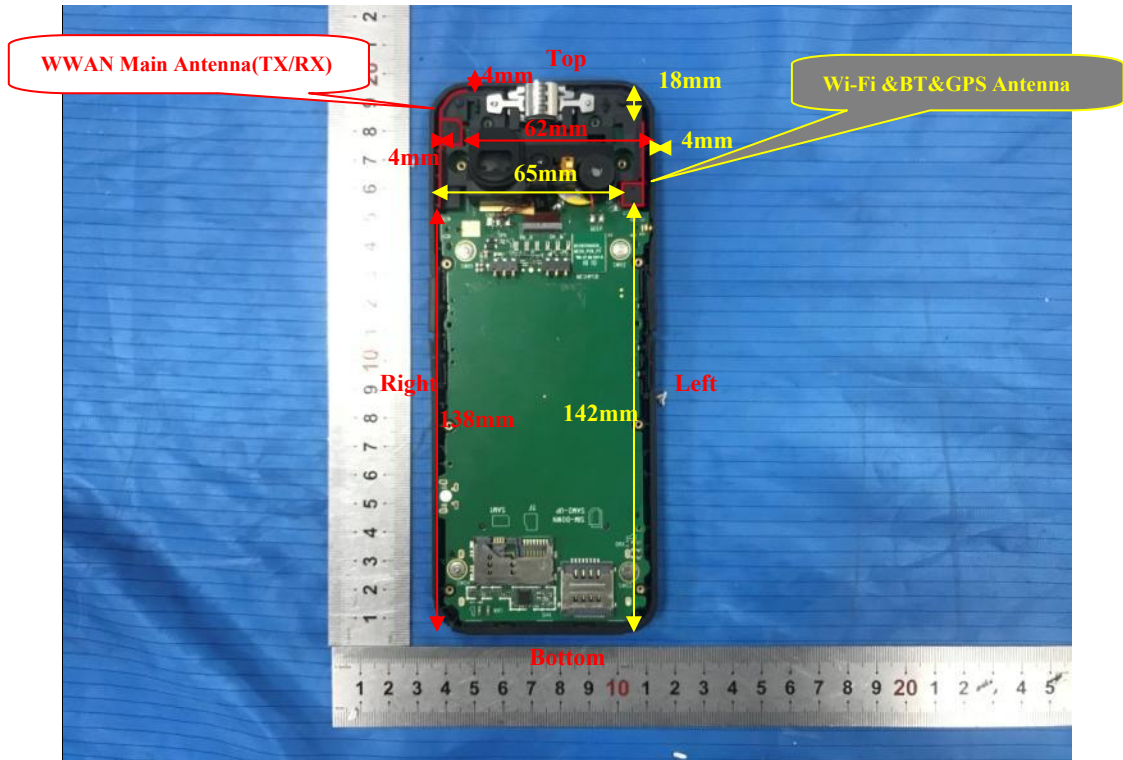



Antenna Distance To Edge

Antenna	Antenna Distance To Edge(mm)				
	Back Edge	Right Edge	Left Edge	Top Edge	Bottom Edge
WWAN Antenna	10	<5	62	<5	138
Wi-Fi & Bluetooth	10	65	<5	18	142

Standalone SAR test exclusion considerations

Mode	Frequency (MHz)	Pavg (dBm)	Pavg (mW)	Distance (mm)	Calculated value	Threshold (1-g)	SAR Test Exclusion
WLAN 2.4G	2462	18.0	63.10	0	19.80	3	NO
WLAN 5.2G	5240	12.0	15.85	0	7.26	3	NO
WLAN 5.8G	5825	12.0	15.85	0	7.63	3	NO
Bluetooth	2480	5.4	3.47	0	1.1	3	YES

Note: The WLAN based average power for calculation. and Bluetooth based peak output power for calculation.

NOTE:

The 1-g and 10-g SAR test exclusion thresholds for 100 MHz to 6 GHz at test separation distances ≤ 50 mm are determined by:

$$[(\text{max. power of channel, including tune-up tolerance, mW}) / (\text{min. test separation distance, mm})] \cdot \sqrt{f(\text{GHz})} \leq 3.0 \text{ for 1-g SAR and } \leq 7.5 \text{ for 10-g extremity SAR, where}$$

1. f(GHz) is the RF channel transmit frequency in GHz.
2. Power and distance are rounded to the nearest mW and mm before calculation.
3. The result is rounded to one decimal place for comparison.
4. When the minimum test separation distance is < 5 mm, a distance of 5 mm is applied to determine SAR test Exclusion.

Standalone SAR estimation:

Mode	Frequency (MHz)	Pavg (dBm)	Pavg (mW)	Distance (mm)	Estimated 1-g (W/kg)
BT Body	2480	5.4	3.47	0	0.15

Mode	Frequency (MHz)	Pavg (dBm)	Pavg (mW)	Distance (mm)	Estimated 10-g (W/kg)
BT Handheld	2480	5.4	3.47	0	0.06

Note: The bluetooth based Peak power for calculation.

When standalone SAR test exclusion applies to an antenna that transmits simultaneously with other antennas, the standalone SAR must be estimated according to following to determine simultaneous transmission SAR test exclusion:

$$[(\text{max. power of channel, including tune-up tolerance, mW}) / (\text{min. test separation distance, mm})] \cdot [\sqrt{f(\text{GHz})} / x]$$

W/kg for test separation distances ≤ 50 mm;

where $x = 7.5$ for 1-g SAR. and $x = 18.75$ for 10-g SAR.

When the minimum test separation distance is < 5 mm, a distance of 5 mm is applied to determine SAR test Exclusion

Standalone SAR test exclusion considerations:

Mode	Frequency (MHz)	Pavg (dBm)	Pavg (mW)	Test exclusion Distance(mm)
GPRS 850	848.8	29.5	891.25	179
GPRS 1900	1909.8	25.6	363.08	75
WCDMA Band2	1907.6	23.0	199.53	59
WCDMA Band5	846.6	23.0	199.53	56
LTE Band5	844.0	22.0	158.49	49
LTE Band7	2560	22.0	158.49	56
LTE Band38	2610	22.0	158.49	57
LTE Band41	2645	22.0	158.49	57
Wi-Fi 2.4G	2462	18.0	891.25	33
Wi-Fi 5.2G	5240	12.0	363.08	13
Wi-Fi 5.8G	5825	12.0	199.53	13

Note: For GSM Mode(s), the maximum time based average power(4Slots) were used for calculation.

SAR test exclusion for the EUT edge considerations Result

Antenna Distance To Edge(mm)					
Mode	Back	Left	Right	Top	Bottom
GSM850	Required	Required	Required	Required	Required
GSM1900	Required	Required	Required	Required	Exclusion
WCDMA Band2	Required	Exclusion	Required	Required	Exclusion
WCDMA Band5	Required	Exclusion	Required	Required	Exclusion
LTE Band5	Required	Exclusion	Required	Required	Exclusion
LTE Band7	Required	Exclusion	Required	Required	Exclusion
LTE Band38	Required	Exclusion	Required	Required	Exclusion
LTE Band41	Required	Exclusion	Required	Required	Exclusion
WLAN 2.4G	Required	Required	Exclusion	Required	Exclusion
WLAN 5.2G	Required	Required	Exclusion	Exclusion	Exclusion
WLAN 5.8G	Required	Required	Exclusion	Exclusion	Exclusion
BT	Exclusion*	Exclusion*	Exclusion*	Exclusion*	Exclusion*

Note:

Required: The distance is less than **Test Exclusion Distance**, testing is required.

Exclusion*: SAR test exclusion evaluation has been done above.

Exclusion: The distance is larger than **Test Exclusion Distance**, testing is not required.

SAR test exclusion for the EUT edge considerations detail:

Distance<50mm(To Edges)

The 1-g and 10-g SAR test exclusion thresholds for 100 MHz to 6 GHz at test separation distance ≤ 50mm are determined by:

$$[(\text{max. power of channel, including tune-up tolerance, mW})/(\text{min. test separation distance, mm})]$$

$$[\sqrt{f(\text{GHz})}] \leq 3.0 \text{ for 1-g SAR and } \leq 7.5 \text{ for 10-g extremity SAR, where}$$

1. f(GHz) is the RF channel transmit frequency in GHz.
2. Power and distance are rounded to the nearest mW and mm before calculation.
3. The result is rounded to one decimal place for comparison.
4. When the minimum test separation distance is < 5 mm, a distance of 5 mm is applied to determine SAR test Exclusion.
5. The Time based average Power is used for calculation.

Distance>50mm(To Edges)

At 100 MHz to 6 GHz and for *test separation distance* > 50mm, the SAR test exclusion threshold is determined according to the following:

- a) [(Power allowed at numeric threshold for 50mm in step 1) + (test separation distance - 50mm) · (f(MHz)/150)]mW, at 100 MHz to 1500 MHz
- a) [(Power allowed at numeric threshold for 50mm in step 1) + (test separation distance - 50mm) · 10]mW, at > 1500 MHz and ≤ 6GHz.

SAR MEASUREMENT RESULTS

This page summarizes the results of the performed dosimetric evaluation.

SAR Test Data

Environmental Conditions

Temperature:	21.5-22.9 °C	21.1-22.4 °C	20.9-22.2 °C	20.8-21.9 °C	21.2-22.3 °C
Relative Humidity:	51 %	49 %	50 %	48 %	51 %
ATM Pressure:	101.8 kPa	101.5 kPa	101.7 kPa	101.8 kPa	101.8 kPa
Test Date:	2020/05/18	2020/05/19	2020/05/20	2020/05/21	2020/05/22

Testing was performed by Sam Ye.

GSM 850 :

Operation Mode: Body Supported

EUT Position	Frequency (MHz)	Test Mode	Max Power (dBm)		Scaled Factor	1g SAR (W/kg)		Plot
			Meas.	Rated		Meas.	Rated	
Body Back (0mm)	824.2	GPRS	/	/	/	/	/	/
	836.6	GPRS	31.95	33.0	1.274	0.716	0.91	#1
	848.8	GPRS	/	/	/	/	/	/

Operation Mode: Handheld

EUT Position	Frequency (MHz)	Test Mode	Max Power (dBm)		Scaled Factor	10g SAR (W/kg)		Plot
			Meas.	Rated		Meas.	Rated	
Handheld Right (0mm)	824.2	GPRS	/	/	/	/	/	/
	836.6	GPRS	31.95	33.0	1.274	0.891	1.13	#16
	848.8	GPRS	/	/	/	/	/	/
Handheld Left (0mm)	824.2	GPRS	/	/	/	/	/	/
	836.6	GPRS	31.95	33.0	1.274	0.318	0.41	#17
	848.8	GPRS	/	/	/	/	/	/
Handheld Top (0mm)	824.2	GPRS	/	/	/	/	/	/
	836.6	GPRS	31.95	33.0	1.274	0.821	1.05	#18
	848.8	GPRS	/	/	/	/	/	/
Handheld Bottom (0mm)	824.2	GPRS	/	/	/	/	/	/
	836.6	GPRS	31.95	33.0	1.274	0.021	0.03	#19
	848.8	GPRS	/	/	/	/	/	/

Note:

1. When the SAR Value is less than half of the limit, testing for other channels are optional.
2. When SAR or MPE is not measured at the maximum power level allowed for production units, the results must be scaled to the maximum tune-up tolerance limit according to the power applied to the individual channels tested to determine compliance.
3. When the maximum output power variation across the required test channels is > 0.5 dB, instead of the middle channel, the highest output power channel must be used.
4. The Multi-slot Classes of EUT is Class 12 which has maximum 4 Downlink slots and 4 Uplink slots, the maximum active slots is 5, when perform the multiple slots scan, 1DL+4UL is the worst case.

PCS 1900 :

Operation Mode: Body Supported

EUT Position	Frequency (MHz)	Test Mode	Max Power (dBm)		Scaled Factor	1g SAR (W/kg)		Plot
			Meas.	Rated		Meas.	Rated	
Body Back (0mm)	1850.2	GPRS	/	/	/	/	/	/
	1880	GPRS	28.11	29.0	1.227	0.274	0.34	#2
	1909.8	GPRS	/	/	/	/	/	/

Operation Mode: Handheld

EUT Position	Frequency (MHz)	Test Mode	Max Power (dBm)		Scaled Factor	10g SAR (W/kg)		Plot
			Meas.	Rated		Meas.	Rated	
Handheld Right (0mm)	1850.2	GPRS	28.52	29.0	1.117	2.37	2.65	#20
	1880	GPRS	28.11	29.0	1.227	2.16	2.65	#21
	1909.8	GPRS	28.49	29.0	1.125	1.96	2.20	#22
Handheld Left (0mm)	1850.2	GPRS	/	/	/	/	/	/
	1880	GPRS	28.11	29.0	1.227	0.021	0.03	#23
	1909.8	GPRS	/	/	/	/	/	/
Handheld Top (0mm)	1850.2	GPRS	/	/	/	/	/	/
	1880	GPRS	28.11	29.0	1.227	0.181	0.22	#24
	1909.8	GPRS	/	/	/	/	/	/

Note:

1. When the SAR Value is less than half of the limit, testing for other channels are optional.
2. When SAR or MPE is not measured at the maximum power level allowed for production units, the results must be scaled to the maximum tune-up tolerance limit according to the power applied to the individual channels tested to determine compliance.
3. When the maximum output power variation across the required test channels is > 0.5 dB, instead of the middle channel, the highest output power channel must be used.
4. The Multi-slot Classes of EUT is Class 12 which has maximum 4 Downlink slots and 4 Uplink slots, the maximum active slots is 5, when perform the multiple slots scan, 1DL+4UL is the worst case.

WCDMA Band 2 :**Operation Mode: Body Supported**

EUT Position	Frequency (MHz)	Test Mode	Max Power (dBm)		Scaled Factor	1g SAR (W/kg)		Plot
			Meas.	Rated		Meas.	Rated	
Body Back (0mm)	1852.4	RMC	/	/	/	/	/	/
	1880	RMC	22.73	23.0	1.064	0.542	0.58	#3
	1907.6	RMC	/	/	/	/	/	/

Operation Mode: Handheld

EUT Position	Frequency (MHz)	Test Mode	Max Power (dBm)		Scaled Factor	10g SAR (W/kg)		Plot
			Meas.	Rated		Meas.	Rated	
Handheld Right (0mm)	1852.4	RMC	22.85	23.0	1.035	2.32	2.40	#25
	1880	RMC	22.73	23.0	1.064	2.39	2.54	#26
	1907.6	RMC	22.82	23.0	1.042	2.25	2.35	#27
Handheld Top (0mm)	1852.4	RMC	/	/	/	/	/	/
	1880	RMC	22.73	23.0	1.064	0.329	0.35	#28
	1907.6	RMC	/	/	/	/	/	/

Note:

1. When the SAR Value is less than half of the limit, testing for other channels are optional.
2. The EUT transmit and receive through the same antenna while testing SAR.
3. The default test configuration is to measure SAR with an established radio link between the EUT and a communication test set using a 12.2 kbps RMC (reference measurement Channel) Configured in Test Loop Model.
4. KDB 941225 D01-Body SAR is not required for HSDPA/HSUPA /HSPA+ when the maximum average output of each RF channel is less than ? dB higher than measured 12.2kbps RMC or the maximum SAR for 12.2kbps RMC is < 75% of SAR limit.
5. When SAR or MPE is not measured at the maximum power level allowed for production units, the results must be scaled to the maximum tune-up tolerance limit according to the power applied to the individual channels tested to determine compliance.

WCDMA Band 5 :**Operation Mode: Body Supported**

EUT Position	Frequency (MHz)	Test Mode	Max Power (dBm)		Scaled Factor	1g SAR (W/kg)		Plot
			Meas.	Rated		Meas.	Rated	
Body Back (0mm)	826.4	RMC	/	/	/	/	/	/
	836.4	RMC	22.83	23.0	1.040	0.206	0.21	#4
	846.6	RMC	/	/	/	/	/	/

Operation Mode: Handheld

EUT Position	Frequency (MHz)	Test Mode	Max Power (dBm)		Scaled Factor	10g SAR (W/kg)		Plot
			Meas.	Rated		Meas.	Rated	
Handheld Right (0mm)	826.4	RMC	/	/	/	/	/	/
	836.4	RMC	22.83	23.0	1.040	0.228	0.24	#29
	846.6	RMC	/	/	/	/	/	/
Handheld Top (0mm)	826.4	RMC	/	/	/	/	/	/
	836.4	RMC	22.83	23.0	1.040	0.219	0.23	#30
	846.6	RMC	/	/	/	/	/	/

Note:

1. When the SAR Value is less than half of the limit, testing for other channels are optional.
2. The EUT transmit and receive through the same antenna while testing SAR.
3. The default test configuration is to measure SAR with an established radio link between the EUT and a communication test set using a 12.2 kbps RMC (reference measurement Channel) Configured in Test Loop Model.
4. KDB 941225 D01-Body SAR is not required for HSDPA/HSUPA /HSPA+ when the maximum average output of each RF channel is less than ? dB higher than measured 12.2kbps RMC or the maximum SAR for 12.2kbps RMC is < 75% of SAR limit.
5. When SAR or MPE is not measured at the maximum power level allowed for production units, the results must be scaled to the maximum tune-up tolerance limit according to the power applied to the individual channels tested to determine compliance.

LTE Band 5 :

Operation Mode: Body Supported

EUT Position	Frequency (MHz)	Bandwidth (MHz)	Test Mode	Max Power (dBm)		Scaled Factor	1g SAR (W/kg)		Plot
				Meas.	Rated		Meas.	Rated	
Body Back (0mm)	829	10	1RB	/	/	/	/	/	/
	836.5	10	1RB	21.83	22.0	1.040	0.196	0.20	#5
	844	10	1RB	/	/	/	/	/	/
	836.5	10	50%RB	21.14	22.0	1.219	0.152	0.19	#6

Operation Mode: Handheld

EUT Position	Frequency (MHz)	Bandwidth (MHz)	Test Mode	Max Power (dBm)		Scaled Factor	10g SAR (W/kg)		Plot
				Meas.	Rated		Meas.	Rated	
Handheld Right (0mm)	829	10	1RB	/	/	/	/	/	/
	836.5	10	1RB	21.83	22.0	1.040	0.241	0.25	#31
	844	10	1RB	/	/	/	/	/	/
	836.5	10	50%RB	21.14	22.0	1.219	0.208	0.25	#32
Handheld Top (0mm)	829	10	1RB	/	/	/	/	/	/
	836.5	10	1RB	21.83	22.0	1.040	0.276	0.29	#33
	844	10	1RB	/	/	/	/	/	/
	836.5	10	50%RB	21.14	22.0	1.219	0.213	0.26	#34

LTE Band 7 :

Operation Mode: Body Supported

EUT Position	Frequency (MHz)	Bandwidth (MHz)	Test Mode	Max Power (dBm)		Scaled Factor	1g SAR (W/kg)		Plot
				Meas.	Rated		Meas.	Rated	
Body Back (0mm)	2510	20	1RB	/	/	/	/	/	/
	2535	20	1RB	21.82	22.0	1.042	0.346	0.36	#7
	2560	20	1RB	/	/	/	/	/	/
	2535	20	50%RB	21.29	22.0	1.178	0.278	0.33	#8

Operation Mode: Handheld

EUT Position	Frequency (MHz)	Bandwidth (MHz)	Test Mode	Max Power (dBm)		Scaled Factor	10g SAR (W/kg)		Plot
				Meas.	Rated		Meas.	Rated	
Handheld Right (0mm)	2510	20	1RB	21.75	22.0	1.059	2.31	2.45	#35
	2535	20	1RB	21.82	22.0	1.042	2.32	2.42	#36
	2560	20	1RB	21.90	22.0	1.023	1.90	1.94	#37
	2535	20	50%RB	21.29	22.0	1.178	1.93	2.27	#38
	2535	20	100%RB	21.15	22.0	1.216	1.77	2.15	#39
Handheld Top (0mm)	2510	20	1RB	/	/	/	/	/	/
	2535	20	1RB	21.82	22.0	1.042	0.175	0.18	#40
	2560	20	1RB	/	/	/	/	/	/
	2535	20	50%RB	21.29	22.0	1.178	0.132	0.16	#41

LTE Band 38 :

Operation Mode: Body Supported

EUT Position	Frequency (MHz)	Bandwidth (MHz)	Test Mode	Max Power (dBm)		Scaled Factor	1g SAR (W/kg)		Plot
				Meas.	Rated		Meas.	Rated	
Body Back (0mm)	2580	20	1RB	/	/	/	/	/	/
	2595	20	1RB	21.86	22.0	1.033	0.236	0.24	#9
	2610	20	1RB	/	/	/	/	/	/
	2595	20	50%RB	21.08	22.0	1.236	0.173	0.21	#10

Operation Mode: Handheld

EUT Position	Frequency (MHz)	Bandwidth (MHz)	Test Mode	Max Power (dBm)		Scaled Factor	10g SAR (W/kg)		Plot
				Meas.	Rated		Meas.	Rated	
Handheld Right (0mm)	2580	20	1RB	/	/	/	/	/	/
	2595	20	1RB	21.86	22.0	1.033	1.36	1.40	#42
	2610	20	1RB	/	/	/	/	/	/
	2595	20	50%RB	21.08	22.0	1.236	1.11	1.37	#43
Handheld Top (0mm)	2580	20	1RB	/	/	/	/	/	/
	2595	20	1RB	21.86	22.0	1.033	0.114	0.12	#44
	2610	20	1RB	/	/	/	/	/	/
	2595	20	50%RB	21.08	22.0	1.236	0.096	0.12	#45

LTE Band 41 :

Operation Mode: Body Supported

EUT Position	Frequency (MHz)	Bandwidth (MHz)	Test Mode	Max Power (dBm)		Scaled Factor	1g SAR (W/kg)		Plot
				Meas.	Rated		Meas.	Rated	
Body Back (0mm)	2565	20	1RB	/	/	/	/	/	/
	2605	20	1RB	21.78	22.0	1.052	0.301	0.32	#11
	2645	20	1RB	/	/	/	/	/	/
	2605	20	50%RB	21.32	22.0	1.169	0.246	0.29	#12

Operation Mode: Handheld

EUT Position	Frequency (MHz)	Bandwidth (MHz)	Test Mode	Max Power (dBm)		Scaled Factor	10g SAR (W/kg)		Plot
				Meas.	Rated		Meas.	Rated	
Handheld Right (0mm)	2565	20	1RB	21.64	22.0	1.086	1.60	1.74	#46
	2605	20	1RB	21.78	22.0	1.052	2.11	2.22	#47
	2645	20	1RB	21.78	22.0	1.052	1.91	2.01	#48
	2605	20	50%RB	21.32	22.0	1.169	1.85	2.16	#49
	2605	20	100%RB	21.06	22.0	1.242	1.52	1.89	#50
Handheld Top (0mm)	2565	20	1RB	/	/	/	/	/	/
	2605	20	1RB	21.78	22.0	1.052	0.172	0.18	#51
	2645	20	1RB	/	/	/	/	/	/
	2605	20	50%RB	21.32	22.0	1.169	0.147	0.17	#52

Note:

1. When the SAR Value is less than half of the limit, testing for other channels are optional.
2. SAR for LTE band exposure configurations is measured according to the procedures of KDB 941225 D05 SAR for LTE Devices v02.
3. KDB941225D05-SAR for higher order modulation is required only when the highest maximum output power for the configuration in the higher order modulation is > 0.5 dB higher than the same configuration in QPSK or when the reported SAR for the QPSK configuration is > 1.45 W/kg
4. KDB941225D05-For QPSK with 100% RB allocation, when the reported SAR measured for the Highest output power channel is <1.45 W/kg, tests for the remaining required test channels are optional.
5. KDB941225D05- For QPSK with 100% RB allocation, SAR is not required when the highest maximum output power for 100 % RB allocation is less than the highest maximum output power in 50% and 1 RB allocations and the highest reported SAR for 1 RB and 50% RB allocation are ≤ 0.8 W/kg.
6. KDB941225D05- Start with the largest channel bandwidth and measure SAR for QPSK with 1 RB allocation, using the RB offset and required test channel combination with the highest maximum output power among RB offset the upper edge, middle and lower edge of each required test channel.
7. KDB941225D05- other channel bandwidths SAR test is required when the highest maximum output power of a configuration requiring testing in the smaller channel bandwidth is > 0.5 dB higher than the equivalent channel configurations in the largest channel bandwidth configuration or the reported SAR of a configuration for the largest channel bandwidth is > 1.45 W/kg.
8. Worst case SAR for 50% RB allocation is selected to be tested.

WLAN 2.4G:

Operation Mode: Body Supported

EUT Position	Frequency (MHz)	Test Mode	Max. Meas. Power (dBm)	Max. Rated Power (dBm)	1g SAR (W/kg)			
					Scaled Factor	Meas. SAR	Scaled SAR	Plot
Body Back (0mm)	2412	802.11b	/	/	/	/	/	/
	2437	802.11b	17.68	18.0	1.076	0.054	0.06	#13
	2462	802.11b	/	/	/	/	/	/

Operation Mode: Handheld

EUT Position	Frequency (MHz)	Test Mode	Max. Meas. Power (dBm)	Max. Rated Power (dBm)	10g SAR (W/kg)			
					Scaled Factor	Meas. SAR	Scaled SAR	Plot
Handheld Left (0mm)	2412	802.11b	/	/	/	/	/	/
	2437	802.11b	17.68	18.0	1.076	0.270	0.29	#53
	2462	802.11b	/	/	/	/	/	/
Handheld Top (0mm)	2412	802.11b	/	/	/	/	/	/
	2437	802.11b	17.68	18.0	1.076	0.067	0.07	#54
	2462	802.11b	/	/	/	/	/	/

Note:

1. When the SAR Value is less than half of the limit, testing for other channels are optional.
2. When SAR or MPE is not measured at the maximum power level allowed for production units, the results must be scaled to the maximum tune-up tolerance limit according to the power applied to the individual channels tested to determine compliance.
3. KDB 248227 D01-SAR measurement is not required for 2.4 GHz OFDM(801.11g/n) when the highest reported SAR for DSSS(802.11b) is ≤ 1.2 W/kg, and the output power for DSSS is not less than that for OFDM.

WLAN U-NII-1:

Operation Mode: Body Supported

EUT Position	Frequency (MHz)	Test Mode	Max. Meas. Power (dBm)	Max. Rated Power (dBm)	1g SAR (W/kg)			
					Scaled Factor	Meas. SAR	Scaled SAR	Plot
Body Back (0mm)	5180	802.11a	/	/	/	/	/	/
	5200	802.11a	11.68	12.0	1.076	0.115	0.12	#14
	5240	802.11a	/	/	/	/	/	/

Operation Mode: Handheld

EUT Position	Frequency (MHz)	Test Mode	Max. Meas. Power (dBm)	Max. Rated Power (dBm)	10g SAR (W/kg)			
					Scaled Factor	Meas. SAR	Scaled SAR	Plot
Handheld Left (0mm)	5180	802.11a	/	/	/	/	/	/
	5200	802.11a	11.68	12.0	1.076	0.357	0.38	#55
	5240	802.11a	/	/	/	/	/	/

WLAN U-NII-3:

Operation Mode: Body Supported

EUT Position	Frequency (MHz)	Test Mode	Max. Meas. Power (dBm)	Max. Rated Power (dBm)	1g SAR (W/kg)			
					Scaled Factor	Meas. SAR	Scaled SAR	Plot
Body Back (0mm)	5745	802.11a	/	/	/	/	/	/
	5785	802.11a	11.37	12.0	1.156	0.109	0.13	#15
	5825	802.11a	/	/	/	/	/	/

Operation Mode: Handheld

EUT Position	Frequency (MHz)	Test Mode	Max. Meas. Power (dBm)	Max. Rated Power (dBm)	10g SAR (W/kg)			
					Scaled Factor	Meas. SAR	Scaled SAR	Plot
Handheld Left (0mm)	5745	802.11a	/	/	/	/	/	/
	5785	802.11a	11.37	12.0	1.156	0.217	0.25	#56
	5825	802.11a	/	/	/	/	/	/

SAR Measurement Variability

In accordance with published RF Exposure KDB procedure 865664 D01 SAR measurement 100 MHz to 6 GHz v01. These additional measurements are repeated after the completion of all measurements requiring the same head or body tissue-equivalent medium in a frequency band. The test device should be returned to ambient conditions (normal room temperature) with the battery fully charged before it is re-mounted on the device holder for the repeated measurement(s) to minimize any unexpected variations in the repeated results

- 1) Repeated measurement is not required when the original highest measured SAR is < 0.80 W/kg; steps 2) through 4) do not apply.
- 2) When the original highest measured SAR is ≥ 0.80 W/kg, repeat that measurement once.
- 3) Perform a second repeated measurement only if the ratio of largest to smallest SAR for the original and first repeated measurements is > 1.20 or when the original or repeated measurement is ≥ 1.45 W/kg (~ 10% from the 1-g SAR limit).
- 4) Perform a third repeated measurement only if the original, first or second repeated measurement is ≥ 1.5 W/kg and the ratio of largest to smallest SAR for the original, first and second repeated measurements is > 1.20 .

Note: The same procedures should be adapted for measurements according to extremity and occupational exposure limits by applying a factor of 2.5 for extremity exposure and a factor of 5 for occupational exposure to the corresponding SAR thresholds.

The Highest Measured SAR Configuration in Each Frequency Band

Body

SAR probe calibration point	Frequency Band	Freq.(MHz)	EUT Position	Meas. SAR (W/kg)		Largest to Smallest SAR Ratio
				Original	Repeated	
/	/	/	/	/	/	/

Note:

1. Repeated measurement is not required since the original highest measured Body support SAR is < 0.80 W/kg and Extremity SAR is < 2.50 W/kg.
2. The measured SAR results **do not** have to be scaled to the maximum tune-up tolerance to determine if repeated measurements are required.
3. SAR measurement variability must be assessed for each frequency band, which is determined by the **SAR probe calibration point and tissue-equivalent medium** used for the device measurements..

SAR SIMULTANEOUS TRANSMISSION DESCRIPTION

Simultaneous Transmission:

Description of Simultaneous Transmit Capabilities	
Transmitter Combination	Simultaneous?
WWAN(GSM/WCDMA/LTE) + Bluetooth	√
WWAN(GSM/WCDMA/LTE) + WLAN 2.4G	√
WWAN(GSM/WCDMA/LTE) + WLAN 5.2G	√
WWAN(GSM/WCDMA/LTE) + WLAN 5.8G	√
WLAN + Bluetooth	×
WLAN 2.4G + WLAN 5.2G	×
WLAN 2.4G + WLAN 5.8G	×

Simultaneous SAR test exclusion considerations:

Body Supported:

Mode(SAR1+SAR2)	Position	Reported SAR(W/kg)		ΣSAR < 1.6W/kg
		SAR1	SAR2	
GSM 850 + Bluetooth	Body Back	0.91	0.15	1.06
PCS 1900 + Bluetooth	Body Back	0.34	0.15	0.49
WCDMA Band 2 + Bluetooth	Body Back	0.58	0.15	0.73
WCDMA Band 5 + Bluetooth	Body Back	0.21	0.15	0.36
LTE Band 5 + Bluetooth	Body Back	0.20	0.15	0.35
LTE Band 7 + Bluetooth	Body Back	0.36	0.15	0.51
LTE Band 38 + Bluetooth	Body Back	0.24	0.15	0.39
LTE Band 41 + Bluetooth	Body Back	0.32	0.15	0.47

Mode(SAR1+SAR2)	Position	Reported SAR(W/kg)		ΣSAR < 1.6W/kg
		SAR1	SAR2	
GSM 850 + WLAN 2.4G	Body Back	0.91	0.06	0.97
PCS 1900 + WLAN 2.4G	Body Back	0.34	0.06	0.40
WCDMA Band 2 + WLAN 2.4G	Body Back	0.58	0.06	0.64
WCDMA Band 5 + WLAN 2.4G	Body Back	0.21	0.06	0.27
LTE Band 5 + WLAN 2.4G	Body Back	0.20	0.06	0.26
LTE Band 7 + WLAN 2.4G	Body Back	0.36	0.06	0.42
LTE Band 38 + WLAN 2.4G	Body Back	0.24	0.06	0.30
LTE Band 41 + WLAN 2.4G	Body Back	0.32	0.06	0.38

Mode(SAR1+SAR2)	Position	Reported SAR(W/kg)		ΣSAR < 1.6W/kg
		SAR1	SAR2	
GSM 850 + WLAN 5.2G	Body Back	0.91	0.12	1.03
PCS 1900 + WLAN 5.2G	Body Back	0.34	0.12	0.46
WCDMA Band 2 + WLAN 5.2G	Body Back	0.58	0.12	0.70
WCDMA Band 5 + WLAN 5.2G	Body Back	0.21	0.12	0.33
LTE Band 5 + WLAN 5.2G	Body Back	0.20	0.12	0.32
LTE Band 7 + WLAN 5.2G	Body Back	0.36	0.12	0.48
LTE Band 38 + WLAN 5.2G	Body Back	0.24	0.12	0.36
LTE Band 41 + WLAN 5.2G	Body Back	0.32	0.12	0.44

Mode(SAR1+SAR2)	Position	Reported SAR(W/kg)		ΣSAR < 1.6W/kg
		SAR1	SAR2	
GSM 850 + WLAN 5.8G	Body Back	0.91	0.13	1.04
PCS 1900 + WLAN 5.8G	Body Back	0.34	0.13	0.47
WCDMA Band 2 + WLAN 5.8G	Body Back	0.58	0.13	0.71
WCDMA Band 5 + WLAN 5.8G	Body Back	0.21	0.13	0.34
LTE Band 5 + WLAN 5.8G	Body Back	0.20	0.13	0.33
LTE Band 7 + WLAN 5.8G	Body Back	0.36	0.13	0.49
LTE Band 38 + WLAN 5.8G	Body Back	0.24	0.13	0.37
LTE Band 41 + WLAN 5.8G	Body Back	0.32	0.13	0.45

Handheld:

Mode(SAR1+SAR2)	Position	Reported SAR(W/kg)		ΣSAR < 4.0W/kg
		SAR1	SAR2	
GSM 850 + Bluetooth	Handheld Right	1.13	0.06	1.19
	Handheld Left	0.41	0.06	0.47
	Handheld Top	1.05	0.06	1.11
	Handheld Bottom	0.03	0.06	0.09
PCS 1900 + Bluetooth	Handheld Right	2.65	0.06	2.71
	Handheld Left	0.03	0.06	0.09
	Handheld Top	0.22	0.06	0.28
	Handheld Bottom	N/A	0.06	N/A
WCDMA Band 2 + Bluetooth	Handheld Right	2.54	0.06	2.60
	Handheld Left	N/A	0.06	N/A
	Handheld Top	0.35	0.06	0.41
	Handheld Bottom	N/A	0.06	N/A
WCDMA Band 5 + Bluetooth	Handheld Right	0.24	0.06	0.30
	Handheld Left	N/A	0.06	N/A
	Handheld Top	0.23	0.06	0.29
	Handheld Bottom	N/A	0.06	N/A
LTE Band 5 + Bluetooth	Handheld Right	0.25	0.06	0.31
	Handheld Left	N/A	0.06	N/A
	Handheld Top	0.29	0.06	0.35
	Handheld Bottom	N/A	0.06	N/A
LTE Band 7 + Bluetooth	Handheld Right	2.45	0.06	2.51
	Handheld Left	N/A	0.06	N/A
	Handheld Top	0.18	0.06	0.24
	Handheld Bottom	N/A	0.06	N/A
LTE Band 38 + Bluetooth	Handheld Right	1.40	0.06	1.46
	Handheld Left	N/A	0.06	N/A
	Handheld Top	0.12	0.06	0.18
	Handheld Bottom	N/A	0.06	N/A
LTE Band 41 + Bluetooth	Handheld Right	2.22	0.06	2.28
	Handheld Left	N/A	0.06	N/A
	Handheld Top	0.18	0.06	0.24
	Handheld Bottom	N/A	0.06	N/A

Mode(SAR1+SAR2)	Position	Reported SAR(W/kg)		ΣSAR < 4.0W/kg
		SAR1	SAR2	
GSM 850 + WLAN 2.4G	Handheld Right	1.13	N/A	N/A
	Handheld Left	0.41	0.29	0.70
	Handheld Top	1.05	0.07	1.12
	Handheld Bottom	0.03	N/A	N/A
PCS 1900 + WLAN 2.4G	Handheld Right	2.65	N/A	N/A
	Handheld Left	0.03	0.29	0.32
	Handheld Top	0.22	0.07	0.29
	Handheld Bottom	N/A	N/A	N/A
WCDMA Band 2 + WLAN 2.4G	Handheld Right	2.54	N/A	N/A
	Handheld Left	N/A	0.29	N/A
	Handheld Top	0.35	0.07	0.42
	Handheld Bottom	N/A	N/A	N/A
WCDMA Band 5 + WLAN 2.4G	Handheld Right	0.24	N/A	N/A
	Handheld Left	N/A	0.29	N/A
	Handheld Top	0.23	0.07	0.30
	Handheld Bottom	N/A	N/A	N/A
LTE Band 5 + WLAN 2.4G	Handheld Right	0.25	N/A	N/A
	Handheld Left	N/A	0.29	N/A
	Handheld Top	0.29	0.07	0.36
	Handheld Bottom	N/A	N/A	N/A
LTE Band 7 + WLAN 2.4G	Handheld Right	2.45	N/A	N/A
	Handheld Left	N/A	0.29	N/A
	Handheld Top	0.18	0.07	0.25
	Handheld Bottom	N/A	N/A	N/A
LTE Band 38 + WLAN 2.4G	Handheld Right	1.40	N/A	N/A
	Handheld Left	N/A	0.29	N/A
	Handheld Top	0.12	0.07	0.19
	Handheld Bottom	N/A	N/A	N/A
LTE Band 41 + WLAN 2.4G	Handheld Right	2.22	N/A	N/A
	Handheld Left	N/A	0.29	N/A
	Handheld Top	0.18	0.07	0.25
	Handheld Bottom	N/A	N/A	N/A

Mode(SAR1+SAR2)	Position	Reported SAR(W/kg)		ΣSAR < 4.0W/kg
		SAR1	SAR2	
GSM 850 + WLAN 5.2G	Handheld Right	1.13	N/A	N/A
	Handheld Left	0.41	0.38	0.79
	Handheld Top	1.05	N/A	N/A
	Handheld Bottom	0.03	N/A	N/A
PCS 1900 + WLAN 5.2G	Handheld Right	2.65	N/A	N/A
	Handheld Left	0.03	0.38	0.41
	Handheld Top	0.22	N/A	N/A
	Handheld Bottom	N/A	N/A	N/A
WCDMA Band 2 + WLAN 5.2G	Handheld Right	2.54	N/A	N/A
	Handheld Left	N/A	0.38	N/A
	Handheld Top	0.35	N/A	N/A
	Handheld Bottom	N/A	N/A	N/A
WCDMA Band 5 + WLAN 5.2G	Handheld Right	0.24	N/A	N/A
	Handheld Left	N/A	0.38	N/A
	Handheld Top	0.23	N/A	N/A
	Handheld Bottom	N/A	N/A	N/A
LTE Band 5 + WLAN 5.2G	Handheld Right	0.25	N/A	N/A
	Handheld Left	N/A	0.38	N/A
	Handheld Top	0.29	N/A	N/A
	Handheld Bottom	N/A	N/A	N/A
LTE Band 7 + WLAN 5.2G	Handheld Right	2.45	N/A	N/A
	Handheld Left	N/A	0.38	N/A
	Handheld Top	0.18	N/A	N/A
	Handheld Bottom	N/A	N/A	N/A
LTE Band 38 + WLAN 5.2G	Handheld Right	1.40	N/A	N/A
	Handheld Left	N/A	0.38	N/A
	Handheld Top	0.12	N/A	N/A
	Handheld Bottom	N/A	N/A	N/A
LTE Band 41 + WLAN 5.2G	Handheld Right	2.22	N/A	N/A
	Handheld Left	N/A	0.38	N/A
	Handheld Top	0.18	N/A	N/A
	Handheld Bottom	N/A	N/A	N/A

Mode(SAR1+SAR2)	Position	Reported SAR(W/kg)		ΣSAR < 4.0W/kg
		SAR1	SAR2	
GSM 850 + WLAN 5.8G	Handheld Right	1.13	N/A	N/A
	Handheld Left	0.41	0.25	0.66
	Handheld Top	1.05	N/A	N/A
	Handheld Bottom	0.03	N/A	N/A
PCS 1900 + WLAN 5.8G	Handheld Right	2.65	N/A	N/A
	Handheld Left	0.03	0.25	0.28
	Handheld Top	0.22	N/A	N/A
	Handheld Bottom	N/A	N/A	N/A
WCDMA Band 2 + WLAN 5.8G	Handheld Right	2.54	N/A	N/A
	Handheld Left	N/A	0.25	N/A
	Handheld Top	0.35	N/A	N/A
	Handheld Bottom	N/A	N/A	N/A
WCDMA Band 5 + WLAN 5.8G	Handheld Right	0.24	N/A	N/A
	Handheld Left	N/A	0.25	N/A
	Handheld Top	0.23	N/A	N/A
	Handheld Bottom	N/A	N/A	N/A
LTE Band 5 + WLAN 5.8G	Handheld Right	0.25	N/A	N/A
	Handheld Left	N/A	0.25	N/A
	Handheld Top	0.29	N/A	N/A
	Handheld Bottom	N/A	N/A	N/A
LTE Band 7 + WLAN 5.8G	Handheld Right	2.45	N/A	N/A
	Handheld Left	N/A	0.25	N/A
	Handheld Top	0.18	N/A	N/A
	Handheld Bottom	N/A	N/A	N/A
LTE Band 38 + WLAN 5.8G	Handheld Right	1.40	N/A	N/A
	Handheld Left	N/A	0.25	N/A
	Handheld Top	0.12	N/A	N/A
	Handheld Bottom	N/A	N/A	N/A
LTE Band 41 + WLAN 5.8G	Handheld Right	2.22	N/A	N/A
	Handheld Left	N/A	0.25	N/A
	Handheld Top	0.18	N/A	N/A
	Handheld Bottom	N/A	N/A	N/A

Conclusion:

Sum of SAR: **ΣSAR ≤ 1.6 W/kg** for 1g Body SAR, **ΣSAR ≤ 4.0 W/kg** for 10g Extremity SAR, therefore simultaneous transmission SAR with Volume Scans is **not required**.

SAR Plots

Please Refer to the Attachment.

APPENDIX A MEASUREMENT UNCERTAINTY

The uncertainty budget has been determined for the measurement system and is given in the following Table.

Measurement uncertainty evaluation for IEEE1528-2013 SAR test

Source of uncertainty	Tolerance/uncertainty ± %	Probability distribution	Divisor	ci (1 g)	ci (10 g)	Standard uncertainty ± %, (1 g)	Standard uncertainty ± %, (10 g)
Measurement system							
Probe calibration	6.55	N	1	1	1	6.6	6.6
Axial Isotropy	4.7	R	√3	1	1	2.7	2.7
Hemispherical Isotropy	9.6	R	√3	0	0	0.0	0.0
Boundary effect	1.0	R	√3	1	1	0.6	0.6
Linearity	4.7	R	√3	1	1	2.7	2.7
Detection limits	1.0	R	√3	1	1	0.6	0.6
Readout electronics	0.3	N	1	1	1	0.3	0.3
Response time	0.0	R	√3	1	1	0.0	0.0
Integration time	0.0	R	√3	1	1	0.0	0.0
RF ambient conditions – noise	1.0	R	√3	1	1	0.6	0.6
RF ambient conditions–reflections	1.0	R	√3	1	1	0.6	0.6
Probe positioner mech. Restrictions	0.8	R	√3	1	1	0.5	0.5
Probe positioning with respect to phantom shell	6.7	R	√3	1	1	3.9	3.9
Post-processing	2.0	R	√3	1	1	1.2	1.2
Test sample related							
Test sample positioning	2.8	N	1	1	1	2.8	2.8
Device holder uncertainty	6.3	N	1	1	1	6.3	6.3
Drift of output power	5.0	R	√3	1	1	2.9	2.9
Phantom and set-up							
Phantom uncertainty (shape and thickness tolerances)	4.0	R	√3	1	1	2.3	2.3
Liquid conductivity target)	5.0	R	√3	0.64	0.43	1.8	1.2
Liquid conductivity meas.)	2.5	N	1	0.64	0.43	1.6	1.1
Liquid permittivity target)	5.0	R	√3	0.6	0.49	1.7	1.4
Liquid permittivity meas.)	2.5	N	1	0.6	0.49	1.5	1.2
Combined standard uncertainty		RSS				12.2	12.0
Expanded uncertainty 95 % confidence interval)						24.3	23.9

Measurement uncertainty evaluation for IEC62209-2 SAR test

Source of uncertainty	Tolerance/uncertainty ± %	Probability distribution	Divisor	ci (1 g)	ci (10 g)	Standard uncertainty ± %, (1 g)	Standard uncertainty ± %, (10 g)
Measurement system							
Probe calibration	6.55	N	1	1	1	6.6	6.6
Axial Isotropy	4.7	R	√3	1	1	2.7	2.7
Hemispherical Isotropy	9.6	R	√3	0	0	0.0	0.0
Linearity	4.7	R	√3	1	1	2.7	2.7
Modulation Response	0.0	R	√3	1	1	0.0	0.0
Detection limits	1.0	R	√3	1	1	0.6	0.6
Boundary effect	1.0	R	√3	1	1	0.6	0.6
Readout electronics	0.3	N	1	1	1	0.3	0.3
Response time	0.0	R	√3	1	1	0.0	0.0
Integration time	0.0	R	√3	1	1	0.0	0.0
RF ambient conditions – noise	1.0	R	√3	1	1	0.6	0.6
RF ambient conditions–reflections	1.0	R	√3	1	1	0.6	0.6
Probe positioner mech. Restrictions	0.8	R	√3	1	1	0.5	0.5
Probe positioning with respect to phantom shell	6.7	R	√3	1	1	3.9	3.9
Post-processing	2.0	R	√3	1	1	1.2	1.2
Test sample related							
Device holder Uncertainty	6.3	N	1	1	1	6.3	6.3
Test sample positioning	2.8	N	1	1	1	2.8	2.8
Power scaling	4.5	R	√3	1	1	2.6	2.6
Drift of output power	5.0	R	√3	1	1	2.9	2.9
Phantom and set-up							
Phantom uncertainty (shape and thickness tolerances)	4.0	R	√3	1	1	2.3	2.3
Algorithm for correcting SAR for deviations in permittivity and conductivity	1.9	N	1	1	0.84	1.1	0.9
Liquid conductivity (meas.)	2.5	N	1	0.64	0.43	1.6	1.1
Liquid permittivity (meas.)	2.5	N	1	0.6	0.49	1.5	1.2
Temp. unc. - Conductivity	1.7	R	√3	0.78	0.71	0.8	0.7
Temp. unc. - Permittivity	0.3	R	√3	0.23	0.26	0.0	0.0
Combined standard uncertainty		RSS				12.2	12.1
Expanded uncertainty 95 % confidence interval)						24.5	24.2

APPENDIX B EUT TEST POSITION PHOTOS

Please Refer to the Attachment.

APPENDIX C CALIBRATION CERTIFICATES

Please Refer to the Attachment.

******* END OF REPORT *******