

TEST REPORT

Product : WisePad 2
Trade mark : BBPOS
Model/Type reference : WisePad 2
Serial Number : N/A
Report Number : EED32I00208216
FCC ID : 2AB7X-WISEPAD2PLUS
Date of Issue : Mar. 17, 2017
Test Standards : 47 CFR Part 2(2015)
47 CFR Part 22 subpart H(2015)
47 CFR Part 24 subpart E(2015)
Test result : PASS

Prepared for:

BBPOS International Limited
Suite 1602, 16/F, Tower 2, Nina Tower, No. 8 Yeung Uk Road,
Tsuen Wan, N.T. HK, Hong Kong

Prepared by:

Centre Testing International Group Co., Ltd.
Hongwei Industrial Zone, Bao'an 70 District,
Shenzhen, Guangdong, China
TEL: +86-755-3368 3668
FAX: +86-755-3368 3385

Tested By:

Tom chen

Tom chen (Test Project)

Compiled by:

Kevin Yang

Kevin yang (Project Engineer)

Reviewed by:

Sheek Luo

Sheek Luo (Reviewer)

Approved by:

Sheek Luo

Sheek Luo (Lab supervisor)

Date:
Report Seal

Mar. 17, 2017

Check No.: 2384397829



2 Version

Version No.	Date	Description
00	Mar. 17, 2017	Original

3 Test Summary

GPRS 850			
Test Item	Test Requirement	Test method	Result
Conducted output power	Part 2.1046(a)/Part 22.913(a)	TIA-603-D-2010 &KDB 971168 D01v02r02	PASS
Effective Radiated Power of Transmitter(ERP)	Part 2.1046(a)/Part 22.913(a)	TIA-603-D-2010 &KDB 971168 D01v02r02	PASS
99% &26dBOccupied Bandwidth	Part 2.1049(h)	Part 22.917(b) &KDB 971168 D01v02r02	PASS
Band Edge at antenna terminals	Part 2.1051/Part 22.917(a)	Part 22.917(b) &KDB 971168 D01v02r02	PASS
Spurious emissions at antenna terminals	Part 2.1051/ Part 2.1057/ Part 22.917(a)(b)	TIA-603-D-2010 &KDB 971168 D01v02r02	PASS
Field strength of spurious radiation	Part 2.1053/ Part 2.1057/ Part 22.917(a)(b)	TIA-603-D-2010 &KDB 971168 D01v02r02	PASS
Frequency stability	Part 2.1055/ Part 22.355	TIA-603-D-2010 &KDB 971168 D01v02r02	PASS
GPRS 1900			
Test Item	Test Requirement	Test method	Result
Conducted output power	Part 2.1046(a) /Part 24.232(c)	TIA-603-D-2010&KDB 971168 D01v02r02	PASS
Effective Radiated Power of Transmitter(EIRP)	Part 2.1046(a) / Part 24.232(c)	TIA-603-D-2010 &KDB 971168 D01v02r02	PASS
peak-to-average ratio	Part 24.232(d)	KDB 971168 D01v02r02	PASS
99% &26dBOccupied Bandwidth	Part 2.1049(h)	Part 24.238(b) &KDB 971168 D01v02r02	PASS
Band Edge at antenna terminals	Part 2.1051/ Part 24.238(a)	Part 24.238(b) &KDB 971168 D01v02r02	PASS
Spurious emissions at antenna terminals	Part 2.1051/ Part 2.1057/ Part 24.238(a)(b)	TIA-603-D-2010 &KDB 971168 D01v02r02	PASS
Field strength of spurious radiation	Part 2.1053 /Part 2.1057 / Part 24.238(a)(b)	TIA-603-D-2010 &KDB 971168 D01v02r02	PASS
Frequency stability	Part 2.1055/Part 24.235	TIA-603-D-2010 &KDB 971168 D01v02r02	PASS

Remark:

The tested sample and the sample information are provided by the client.

This test report (Ref. No.: EED32I00208216) different with the original report (Ref. No.: EED32I00208206) is FCC ID.

4 Content

1 COVER PAGE	1
2 VERSION	2
3 TEST SUMMARY	3
4 CONTENT	4
5 TEST REQUIREMENT	5
5.1 TEST SETUP.....	5
5.1.1 For Conducted test setup.....	5
5.1.2 For Radiated Emissions test setup.....	5
5.2 TEST ENVIRONMENT.....	6
5.3 TEST CONDITION.....	6
6 GENERAL INFORMATION	7
6.1 CLIENT INFORMATION.....	7
6.2 GENERAL DESCRIPTION OF EUT.....	7
6.3 PRODUCT SPECIFICATION SUBJECTIVE TO THIS STANDARD.....	7
6.4 DESCRIPTION OF SUPPORT UNITS.....	7
6.5 TEST LOCATION.....	7
6.6 TEST FACILITY.....	7
6.7 DEVIATION FROM STANDARDS.....	8
6.8 ABNORMALITIES FROM STANDARD CONDITIONS.....	9
6.9 OTHER INFORMATION REQUESTED BY THE CUSTOMER.....	9
6.10 MEASUREMENT UNCERTAINTY (95% CONFIDENCE LEVELS, K=2).....	9
7 EQUIPMENT LIST	10
8 RADIO TECHNICAL REQUIREMENTS SPECIFICATION	12
Appendix A) RF Power Output.....	13
Appendix B) Peak-to-Average Ratio.....	14
Appendix C) BandWidth.....	18
Appendix D) Band Edges Compliance.....	22
Appendix E) Spurious Emission at Antenna Terminal.....	25
Appendix F) Frequency Stability.....	41
Appendix G) Effective Radiated Power of Transmitter (ERP/EIRP).....	44
Appendix H) Field strength of spurious radiation.....	46
PHOTOGRAPHS OF TEST SETUP	50
PHOTOGRAPHS OF EUT CONSTRUCTIONAL DETAILS	51

5 Test Requirement

5.1 Test setup

5.1.1 For Conducted test setup

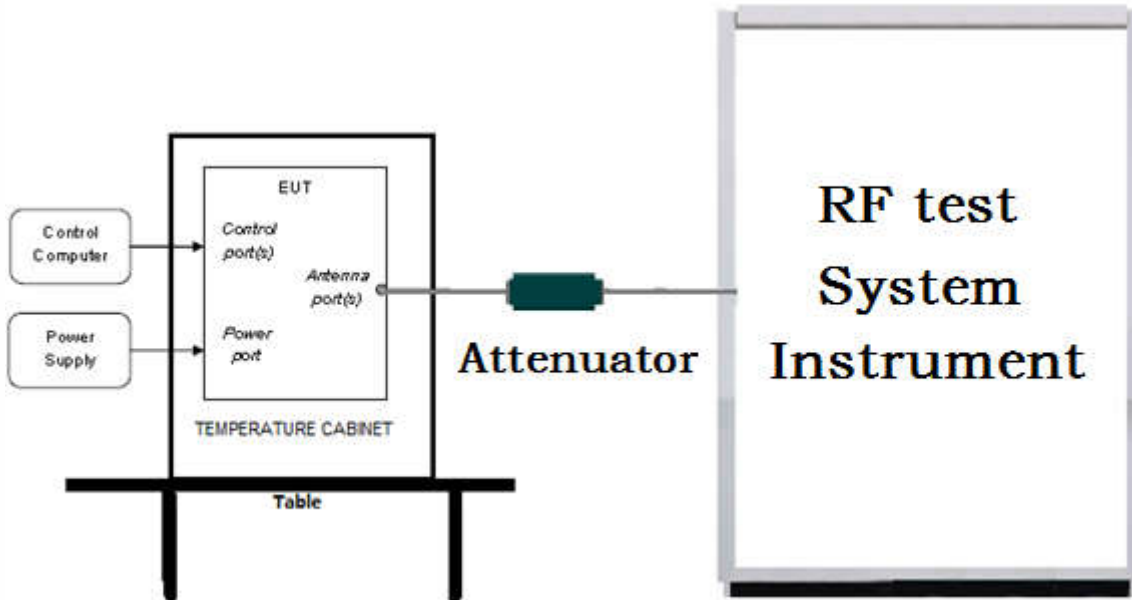

5.1.2 For Radiated Emissions test setup

Radiated Emissions setup:

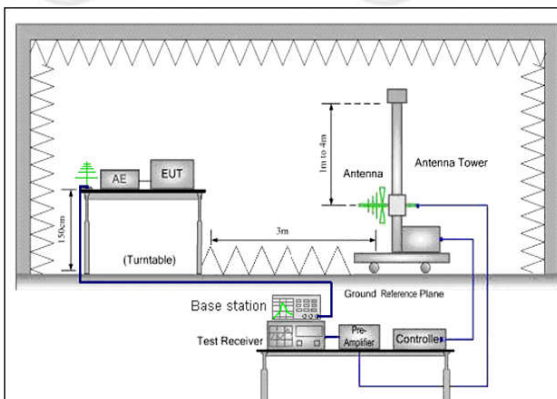

Figure 1.30MHz to 1GHz

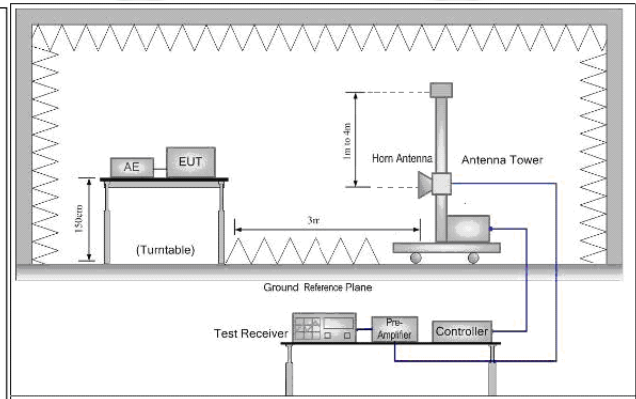

Figure 2. above 1GHz

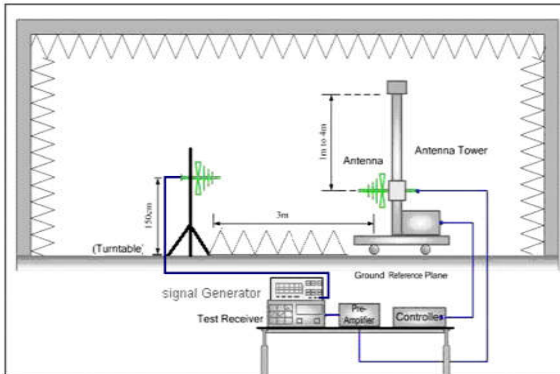

Figure 1. 30MHz to 1GHz

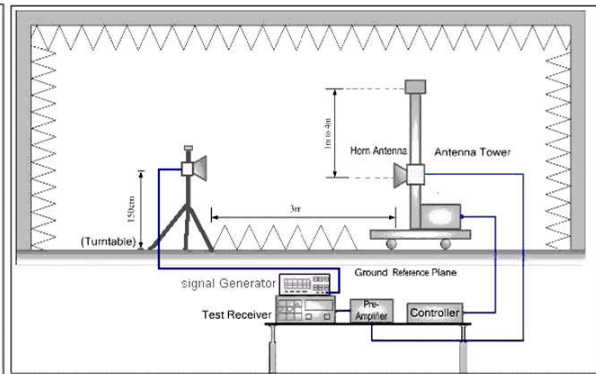

Figure 2. above 1GHz

5.2 Test Environment

Operating Environment:	
Temperature:	21 °C
Humidity:	54 % RH
Atmospheric Pressure:	1010 mbar

5.3 Test Condition

Test channel:

Test Mode	Tx	RF Channel		
		Low(L)	Middle(cm)	High(H)
GPRS850	Tx (824 MHz ~849 MHz)	Channel 128	Channel 190	Channel 251
		824.2MHz	836.6 MHz	848.8 MHz
	Rx (869 MHz ~894 MHz)	Channel 128	Channel 190	Channel 251
		869.2 MHz	881.6 MHz	893.8 MHz
GPRS1900	Tx (1850 MHz ~1910 MHz)	Channel 512	Channel 661	Channel 810
		1850.2MHz	1880.0 MHz	1909.8 MHz
	Rx (1930 MHz ~1990 MHz)	Channel 512	Channel 661	Channel 810
		1930.2 MHz	1960.0 MHz	1989.8 MHz

Test mode:

Pre-scan under all rate at lowest middle and highest channel ,find the transmitter power as below:
 Conducted transmitter power measurement result.

band	GPRS850			GPRS1900		
Channel	128	190	251	512	661	810
Frequency(MHz)	824.2MHz	836.6MHz	848.8MHz	1850.2MHz	1880MHz	1909.8MHz
GPRS Class 8	33.00dBm	33.06dBm	33.34dBm	29.99dBm	30.15dBm	30.85dBm

Pre-scan all mode and data rates and positions,find worse case mode are chosen to the report ,the worse case mode as below:

band	Radiated	Conducted
GPRS 850	1) GPRS 8 Link	1) GPRS 8 Link
GPRS 1900	1) GPRS 8 Link	1) GPRS 8 Link

6 General Information

6.1 Client Information

Applicant:	BBPOS International Limited
Address of Applicant:	Suite 1602, 16/F, Tower 2, Nina Tower, No. 8 Yeung Uk Road, Tsuen Wan, N.T. HK, Hong Kong
Manufacturer:	BBPOS International Limited
Address of Manufacturer:	Suite 1602, 16/F, Tower 2, Nina Tower, No. 8 Yeung Uk Road, Tsuen Wan, N.T. HK, Hong Kong

6.2 General Description of EUT

Product Name:	WisePad 2
Mode No.(EUT):	WisePad 2
Trade Mark:	BBPOS
EUT Supports Radios application:	BT 2.1(2402MHz-2480MHz), BT 4.0(2402MHz-2480MHz), NFC(13.56MHz), WIFIb/g/n(HT20)(2412MHz-2462MHz), 2G(850MHz/1900MHz)
Power Supply:	DC 3.7V by Battery DC 5V by USB port
Battery:	Li-polymer 3.7V, 750mAh
Sample Received Date:	Jul. 26. 2016
Sample tested Date:	Jul. 26. 2016 to Aug. 25, 2016

6.3 Product Specification subjective to this standard

Frequency Band:	GPRS 850: Tx:824.20 -848.80MHz; Rx: 869.20 – 893.80MHz GPRS 1900: Tx:1850.20 – 1909.80MHz; Rx:1930.20 – 1989.80MHz
Modulation Type:	GPRS Mode with GMSK Modulation
Sample Type:	Portable production
Antenna gain:	GPRS850: -3dBi; GPRS1900: 0.5dBi
Antenna Type:	Integral
Test voltage:	DC 3.7V

6.4 Description of Support Units

The EUT has been tested independently.

6.5 Test Location

All tests were performed at:

Centre Testing International Group Co., Ltd.

Hongwei Industrial Zone, Bao'an 70 District, Shenzhen, Guangdong, China 518101

Telephone: +86 (0) 755 33683668 Fax:+86 (0) 755 33683385

No tests were sub-contracted.

6.6 Test Facility

The test facility is recognized, certified, or accredited by the following organizations:

CNAS-Lab Code: L1910

Centre Testing International Group Co., Ltd. has been assessed and proved to be in compliance with CNAS-CL01 Accreditation Criteria for Testing and Calibration Laboratories (identical to ISO/IEC 17025: 2005 General Requirements) for the Competence of Testing and Calibration Laboratories..

A2LA-Lab Cert. No. 3061.01

Centre Testing International Group Co., Ltd. EMC Laboratory has been accredited by A2LA for technical competence in the field of electrical testing, and proved to be in compliance with ISO/IEC 17025: 2005 General Requirements for the Competence of Testing and Calibration Laboratories and any additional program requirements in the identified field of testing.

FCC-Registration No.: 886427

Centre Testing International Group Co., Ltd. EMC Laboratory has been registered and fully described in a report filed with the FCC (Federal Communications Commission). The acceptance letter from the FCC is maintained in our files. Registration 886427.

IC-Registration No.: 7408A-2

The 3m Alternate Test Site of Centre Testing International Group Co., Ltd. has been registered by Certification and Engineering Bureau of Industry Canada for the performance of radiated measurements with Registration No. 7408A-2 .

IC-Registration No.: 7408B-1

The 10m Alternate Test Site of Centre Testing International Group Co., Ltd. has been registered by Certification and Engineering Bureau of Industry Canada for the performance of radiated measurements with Registration No. 7408B-1.

NEMKO-Aut. No.: ELA503

Centre Testing International Group Co., Ltd. has been assessed the quality assurance system, the testing facilities, qualifications and testing practices of the relevant parts of the organization. The quality assurance system of the Laboratory has been validated against ISO/IEC 17025 or equivalent. The laboratory also fulfils the conditions described in Nemko Document NLA-10.

VCCI

The Radiation 3 &10 meters site of Centre Testing International Group Co., Ltd. has been registered in accordance with the Regulations for Voluntary Control Measures with Registration No.: R-4096.

Main Ports Conducted Interference Measurement of Centre Testing International Group Co., Ltd. has been registered in accordance with the Regulations for Voluntary Control Measures with Registration No.: C-4563.

Telecommunication Ports Conducted Disturbance Measurement of Centre Testing International Group Co., Ltd. has been registered in accordance with the Regulations for Voluntary Control Measures with Registration No.: T-2146.

The Radiation 3 meters site of Centre Testing International Group Co., Ltd. has been registered in accordance with the Regulations for Voluntary Control Measures with Registration No.: G-758

6.7 Deviation from Standards

None.

6.8 Abnormalities from Standard Conditions

None.

6.9 Other Information Requested by the Customer

None.

6.10 Measurement Uncertainty (95% confidence levels, k=2)

No.	Item	Measurement Uncertainty
1	Radio Frequency	7.9 x 10 ⁻⁸
2	RF power, conducted	0.31dB (30MHz-1GHz)
		0.57dB (1GHz-18GHz)
3	Radiated Spurious emission test	4.5dB (30MHz-1GHz)
		4.8dB (1GHz-12.75GHz)
4	Conduction emission	3.6dB (9kHz to 150kHz)
		3.2dB (150kHz to 30MHz)
5	Temperature test	0.64°C
6	Humidity test	2.8%
7	DC power voltages	0.025%

7 Equipment List

Communication RF test system					
Equipment	Manufacturer	Mode No.	Serial Number	Cal. Date (mm-dd-yyyy)	Cal. Due date (mm-dd-yyyy)
Spectrum Analyzer	Agilent	E4440A	MY46185649	12-31-2015	12-29-2016
Signal Generator	Agilent	E4438C	MY45095744	04-01-2016	03-31-2017
Communication test set	Agilent	E5515C	GB47050534	04-01-2016	03-31-2017
Signal Generator	Keysight	E8257D	MY53401106	04-01-2016	03-31-2017
Communication test set	R&S	CMW500	152394	04-01-2016	03-31-2017
High-pass filter	Sinoscite	FL3CX03WG18 NM12-0398-002	---	01-12-2016	01-11-2017
High-pass filter	MICRO-TRONICS	SPA-F-63029-4	---	01-12-2016	01-11-2017
band rejection filter	Sinoscite	FL5CX01CA09C L12-0395-001	---	01-12-2016	01-11-2017
band rejection filter	Sinoscite	FL5CX01CA08C L12-0393-001	---	01-12-2016	01-11-2017
band rejection filter	Sinoscite	FL5CX02CA04C L12-0396-002	---	01-12-2016	01-11-2017
band rejection filter	Sinoscite	FL5CX02CA03C L12-0394-001	---	01-12-2016	01-11-2017
DC Power	Keysight	E3642A	MY54426112	04-08-2016	04-07-2017
DC Power	Keysight	E3642A	MY54426115	04-01-2016	03-31-2017
PC-2	Lenovo	R4960d	---	04-01-2016	03-31-2017
PC-3	Lenovo	R4960d	---	04-01-2016	03-31-2017
RF control unit	JS Tonscend	JS0806-1	158060004	04-01-2016	03-31-2017
DC power Box	JS Tonscend	JS0806-4	158060007	04-01-2016	03-31-2017
LTE Automatic test software	JS Tonscend	JS1120-1	---	04-01-2016	03-31-2017
WCDMA Automatic test software	JS Tonscend	JS1120-3	---	04-01-2016	03-31-2017
GSM Automatic test software	JS Tonscend	JS1120-3	---	04-01-2016	03-31-2017

Radiated Spurious Emission & Radiated Emission					
Equipment	Manufacturer	Mode No.	Serial Number	Cal. date (mm-dd-yyyy)	Cal. Due date (mm-dd-yyyy)
3M Chamber & Accessory Equipment	TDK	SAC-3	---	06-05-2016	06-05-2019
TRILOG Broadband Antenna	SCHWARZBECK	VULB9163	9163-484	05-23-2016	05-22-2017
Microwave Preamplifier	Agilent	8449B	3008A02425	02-04-2016	02-03-2017
Horn Antenna	ETS-LINDGREN	3117	00057407	07-20-2015	07-18-2018
Loop Antenna	ETS	6502	00071730	07-30-2015	07-28-2017
Spectrum Analyzer	R&S	FSP40	100416	06-16-2016	06-15-2017
Receiver	R&S	ESCI	100435	06-16-2016	06-15-2017
Multi device Controller	matur	NCD/070/10711 112	---	01-12-2016	01-11-2017
LISN	schwarzbeck	NNBM8125	81251547	06-16-2016	06-15-2017
LISN	schwarzbeck	NNBM8125	81251548	06-16-2016	06-15-2017
Signal Generator	Agilent	E4438C	MY45095744	04-01-2016	03-31-2017
Signal Generator	Keysight	E8257D	MY53401106	04-01-2016	03-31-2017
Temperature/ Humidity Indicator	TAYLOR	1451	1905	04-27-2016	04-26-2017
Communication test set	Agilent	E5515C	GB47050534	04-01-2016	03-31-2017
Cable line	Fulai(7M)	SF106	5219/6A	01-12-2016	01-11-2017
Cable line	Fulai(6M)	SF106	5220/6A	01-12-2016	01-11-2017
Cable line	Fulai(3M)	SF106	5216/6A	01-12-2016	01-11-2017
Cable line	Fulai(3M)	SF106	5217/6A	01-12-2016	01-11-2017
Communication test set	R&S	CMW500	152394	04-01-2016	03-31-2017
High-pass filter(3-18GHz)	Sinoscite	FL3CX03WG18 NM12-0398-002	---	01-12-2016	01-11-2017
High-pass filter(6-18GHz)	MICRO-TRONICS	SPA-F-63029-4	---	01-12-2016	01-11-2017
band rejection filter	Sinoscite	FL5CX01CA09C L12-0395-001	---	01-12-2016	01-11-2017
band rejection filter	Sinoscite	FL5CX01CA08C L12-0393-001	---	01-12-2016	01-11-2017
band rejection filter	Sinoscite	FL5CX02CA04C L12-0396-002	---	01-12-2016	01-11-2017
band rejection filter	Sinoscite	FL5CX02CA03C L12-0394-001	---	01-12-2016	01-11-2017

8 Radio Technical Requirements Specification

Reference documents for testing:

No.	Identity	Document Title
1	PART 22 (2015)	PART 22 – PUBLIC MOBILE SERVICES Subpart H – Cellular Radiotelephone Service
2	PART 24 (2015)	PART 24 – PERSONAL COMMUNICATIONS SERVICES Subpart E – Broadband PCS
3	PART 2 (2015)	Frequency allocations and radio treaty matters; general rules and regulations
4	TIA-603-C-2004	Land Mobile FM or PM -Communications Equipment -Measurement and Performance Standards
5	KDB971168 D01	KDB971168 D01 Power Meas License Digital Systems v02r02

Test Results List:

Test Requirement	Test method	Test item	Verdict	Note
Part 2.1046(a)/Part 22.913(a)/ part 24.232(c)	TIA-603-D&KDB 971168 D01v02r02	Conducted output power	PASS	Appendix A)
Part 24.232(d)	KDB 971168 D01v02r02	peak-to-average ratio	PASS	Appendix B)
Part 2.1049(h)	Part 22.917(b)/ Part 24.238(b) &KDB 971168 D01v02r02	99% &26dB Occupied Bandwidth	PASS	Appendix C)
Part 2.1051/Part 22.917(a)/ Part 24.238(a)	Part 22.917(b)/ Part 24.238(b) &KDB 971168 D01v02r02	Band Edge at antenna terminals	PASS	Appendix D)
Part 2.1051/ Part 2.1057/ Part 22.917(a)(b)/ Part 24.238(a)(b)	TIA-603-D &KDB 971168 D01v02r02	Spurious emissions at antenna terminals	PASS	Appendix E)
Part 2.1055/ Part 22.355/ Part 24.235	TIA-603-D &KDB 971168 D01v02r02	Frequency stability	PASS	Appendix F)
Part 2.1053/ Part 2.1057/ Part 22.917(a)(b)/ Part 24.238(a)(b)	TIA-603-D &KDB 971168 D01v02r02	Field strength of spurious radiation	PASS	Appendix G)
Part 2.1046(a)/Part 22.913(a)/ Part 24.232(c)	TIA-603-D &KDB 971168 D01v02r02	Effective Radiated Power of Transmitter(ERP)	PASS	Appendix H)

Test Mode	Test Modes description
GPRS/TM2	GPRS,GMSK modulation

Appendix A) RF Power Output

Test Requirement:	Part 2.1046(a)		
Test Method:	TIA-603-D-2010 Clause 2.2.1		
Test Setup:	Refer to section 5 for details		
Limit:	Mode	GSM 850/WCDMA/HSDPA /HSUPA 850 Band V	GSM 1900/WCDMA/HSDPA /HSUPA 1900 Band II
	Frequency	824 – 849MHz	1850 – 1910MHz
	Limit	38.45dBm (ERP)	33.01dBm (EIRP)
Measurement Procedure:	The transmitter output was connected to a calibrated coaxial cable, attenuator and power meter, the other end of which was connected to a Base Station Simulator. The Base Station Simulator was set to force the EUT to its maximum power setting. The power output at the transmitter antenna port was determined by adding the value of the cable insertion loss to the power reading. The tests were performed at three frequencies (low channel, middle channel and high channel) and on the highest power levels, which can be setup on the transmitters.		
Instruments Used:	Refer to section 7 for details		
Test Results:	Pass		

Test Data:

Test Band	Test Mode	Test Channel	Measured(dbm)	Limit(dbm)	Verdict
GPRS850	GPRS/TM2	LCH	33.00	38.45	PASS
		MCH	33.06	38.45	PASS
		HCH	33.34	38.45	PASS
Test Band	Test Mode	Test Channel	Measured(dbm)	Limit(dbm)	Verdict
GPRS1900	GPRS/TM2	LCH	29.99	33.01	PASS
		MCH	30.15	33.01	PASS
		HCH	30.85	33.01	PASS

Appendix B) Peak-to-Average Ratio

Test Requirement:	Part 24.232(d)
Test Method:	KDB 971168 D01
Test Setup:	Refer to section 5 for details
Limit:	13dBm
Measurement Procedure:	Use one of the procedures to measure the total peak power and record as PPK. Use one of the applicable procedures to measure the total average power and record as PAvg. Both the peak and average power levels must be expressed in the same logarithmic units (e.g., dBm). Determine the PAPR from: $PAPR (dB) = PPK (dBm) - PAvg (dBm)$.
Instruments Used:	Refer to section 7 for details
Test Results:	Pass

Test Data:

Test Band	Test Mode	Test Channel	Measured(dbm)	Limit(dbm)	Verdict
GPRS850	GPRS/TM2	LCH	2.68	13	PASS
		MCH	2.68	13	PASS
		HCH	2.68	13	PASS

Test Band	Test Mode	Test Channel	Measured(dbm)	Limit(dbm)	Verdict
GPRS1900	GPRS/TM2	LCH	2.72	13	PASS
		MCH	2.70	13	PASS
		HCH	2.67	13	PASS

For GPRS

Test Band=GPRS850

Test Mode=GPRS/TM2

Test Channel=LCH

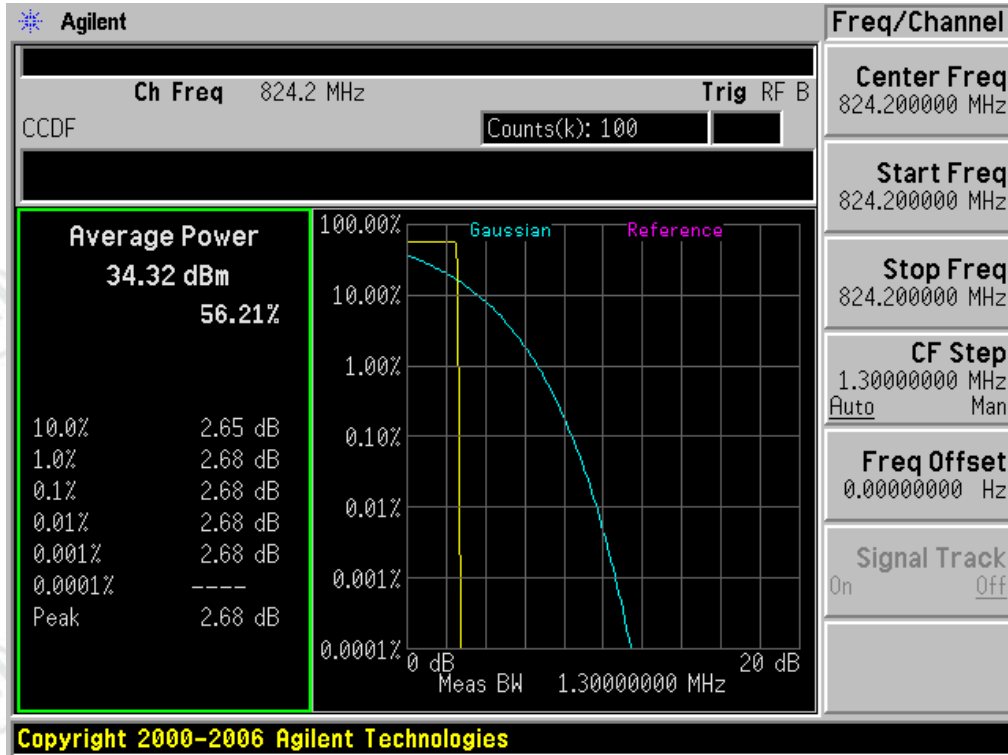

Test Channel=MCH

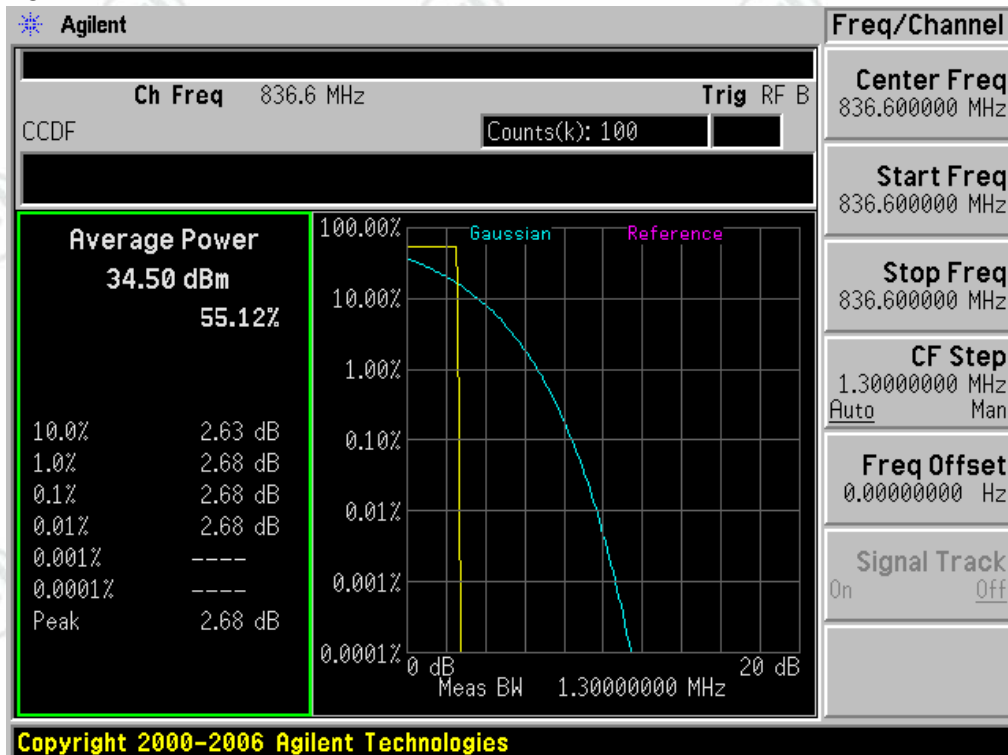

Test Channel=HCH

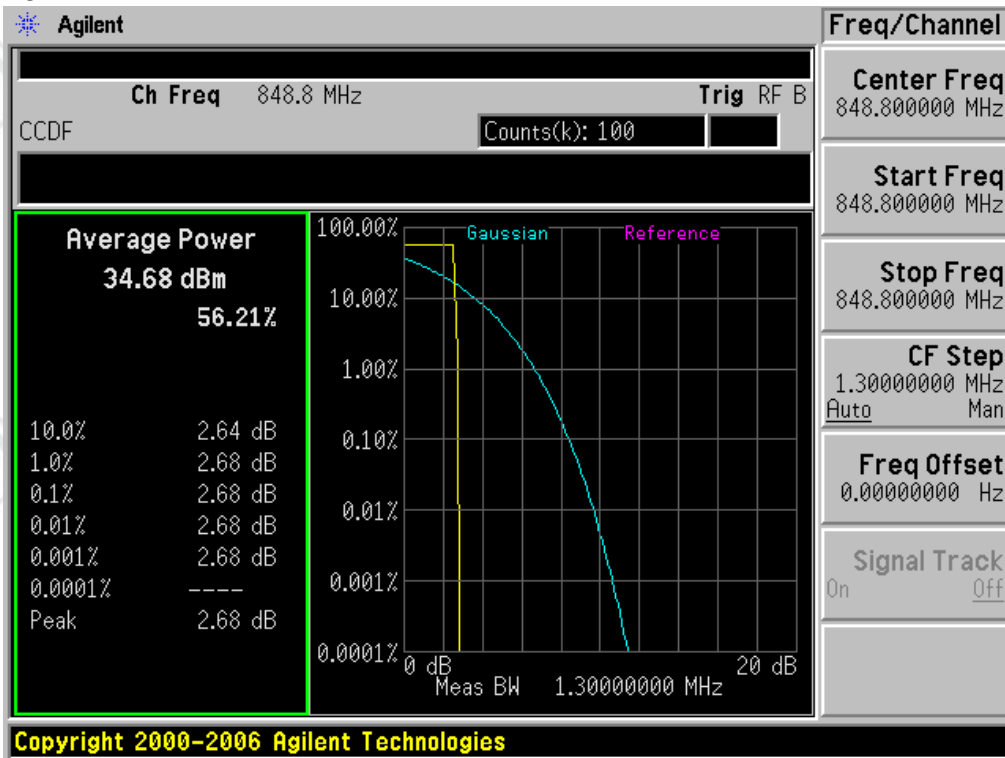

Test Band=GPRS1900

Test Mode=GPRS/TM2

Test Channel=LCH

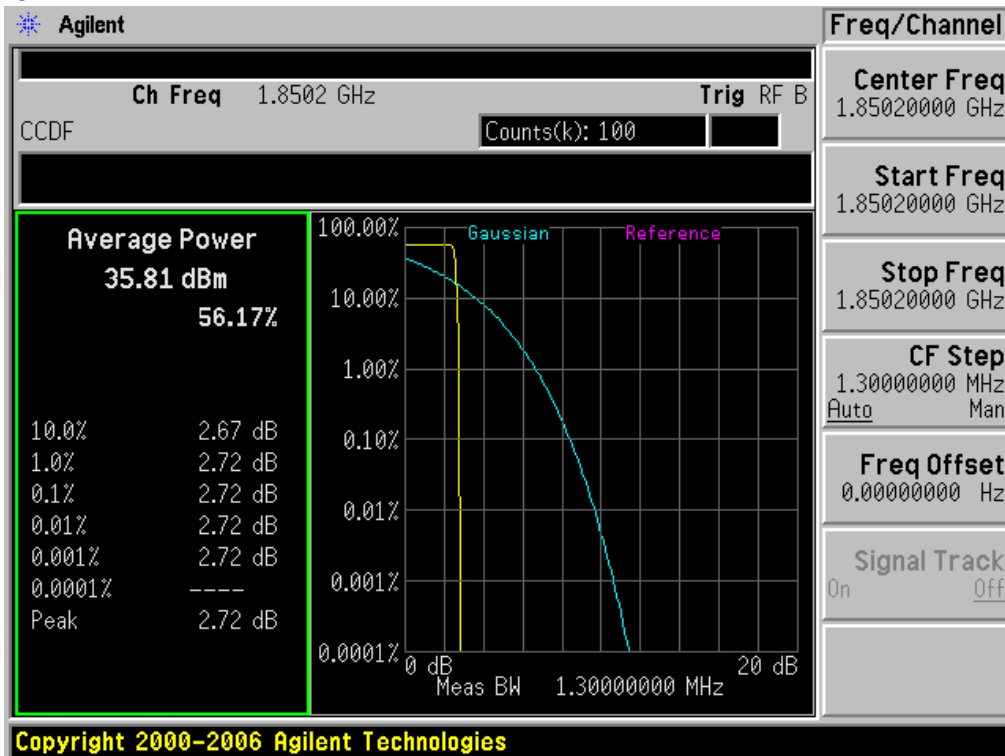

Test Channel=MCH

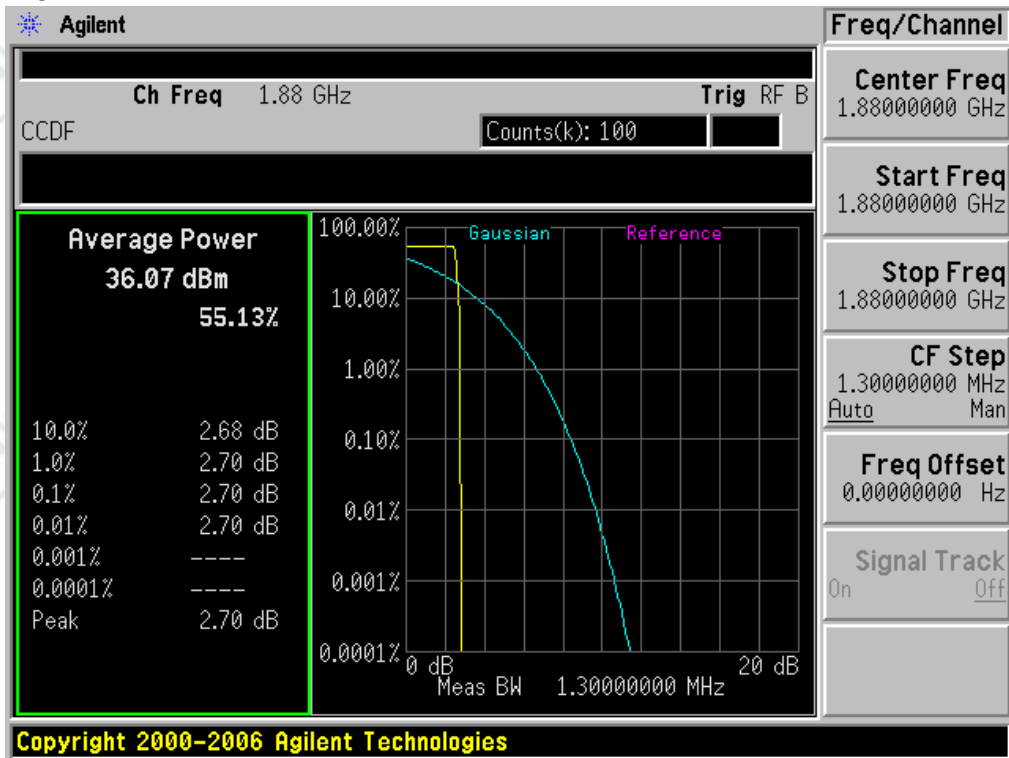

Test Channel=HCH

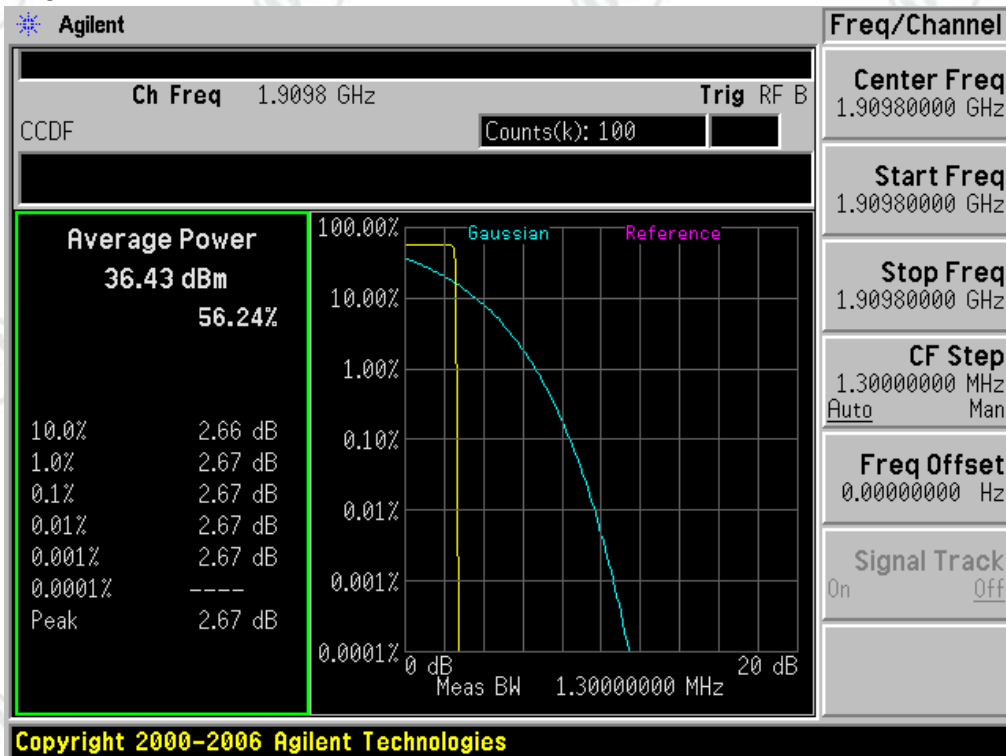

Appendix C) BandWidth

Test Requirement:	Part 2.1049(h)
Test Method:	Part 22.917(b)/Part 24.238(b)
Test Setup:	Refer to section 5 for details
Limit:	N/A
Measurement Procedure:	The transmitter output was connected to a calibrated coaxial cable, attenuator and Spectrum analyser, the other end of which was connected to a Base Station Simulator. The Base Station Simulator was set to force the EUT to its maximum power setting. The tests were performed at three frequencies (low channel, middle channel and high channel).the resolution bandwidth of the analyser is set to 100kHz or 1% of the emission bandwidth, the EUT emission bandwidth is measured as the width of the signal between two points, outside of which all emission are attenuated at least 26dB below the transmitter power. The video bandwidth of the spectrum analyzer was set at thrice the resolution bandwidth. Detector Mode was set to peak or peak hold power.
Instruments Used:	Refer to section 7 for details
Test Results:	Pass

Test Data:

Test Band	Test Mode	Test Channel	Occupied Bandwidth (KHZ)	Emission Bandwidth (KHZ)	Verdict
GPRS850	GPRS/TM2	LCH	244.55	311.48	PASS
		MCH	244.87	310.82	PASS
		HCH	245.98	318.55	PASS

Test Band	Test Mode	Test Channel	Occupied Bandwidth (KHZ)	Emission Bandwidth (KHZ)	Verdict
GPRS1900	GPRS/TM2	LCH	245.51	313.42	PASS
		MCH	244.82	312.04	PASS
		HCH	244.94	314.05	PASS

Test Band=GPRS850

Test Mode=GPRS/TM2

Test Channel=LCH

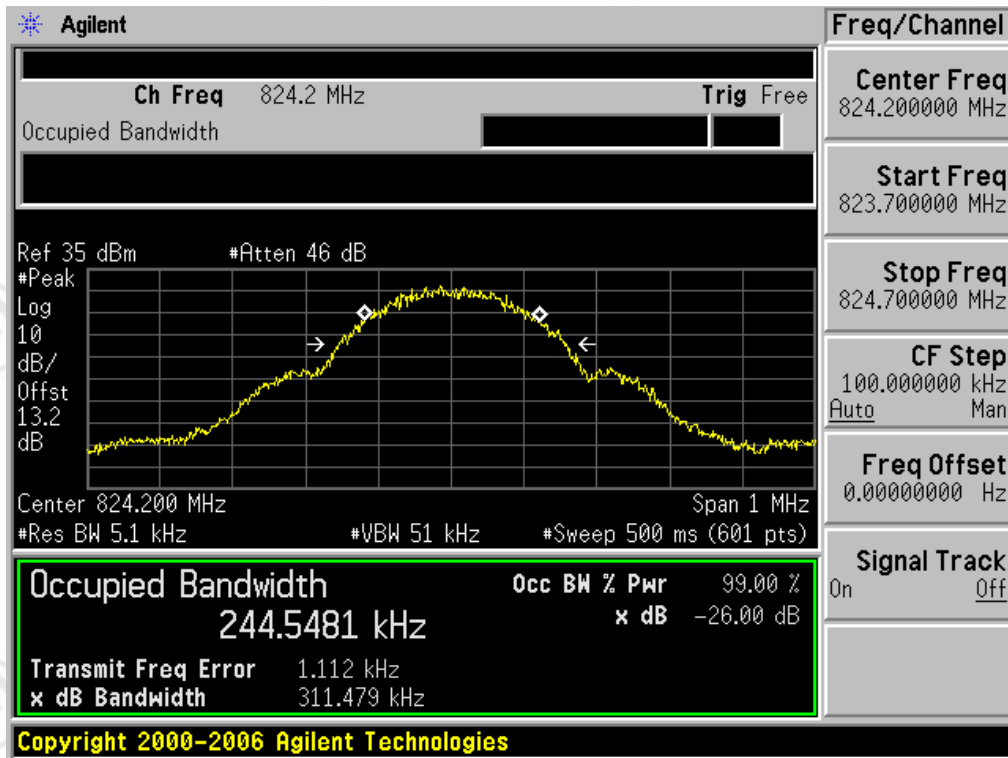

Test Channel=MCH

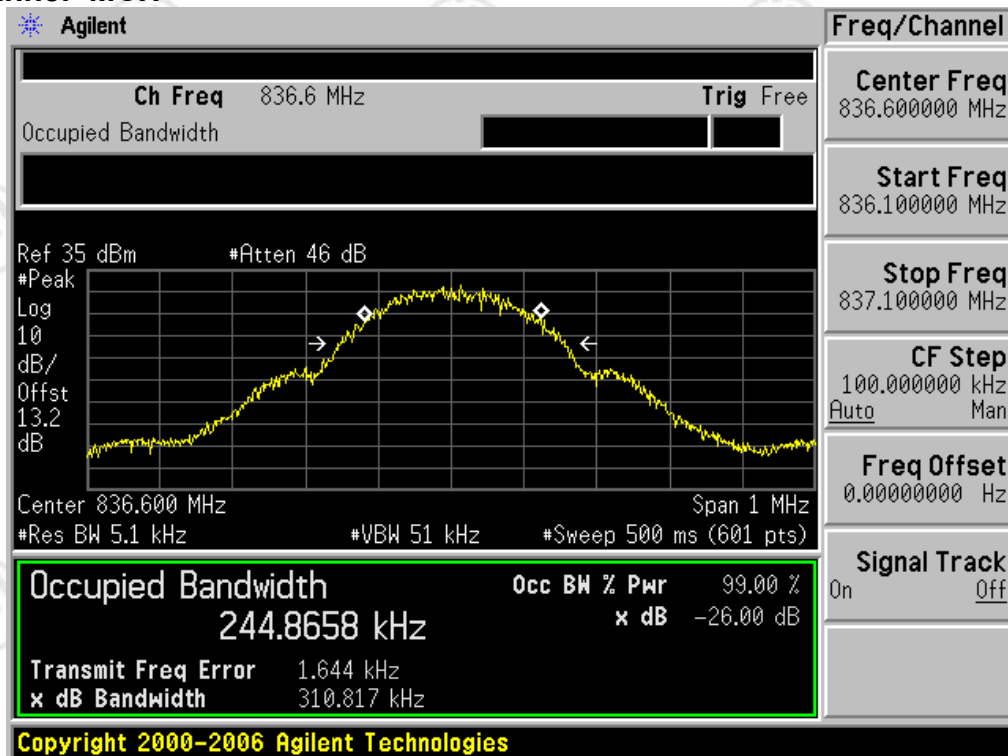

Test Channel=HCH

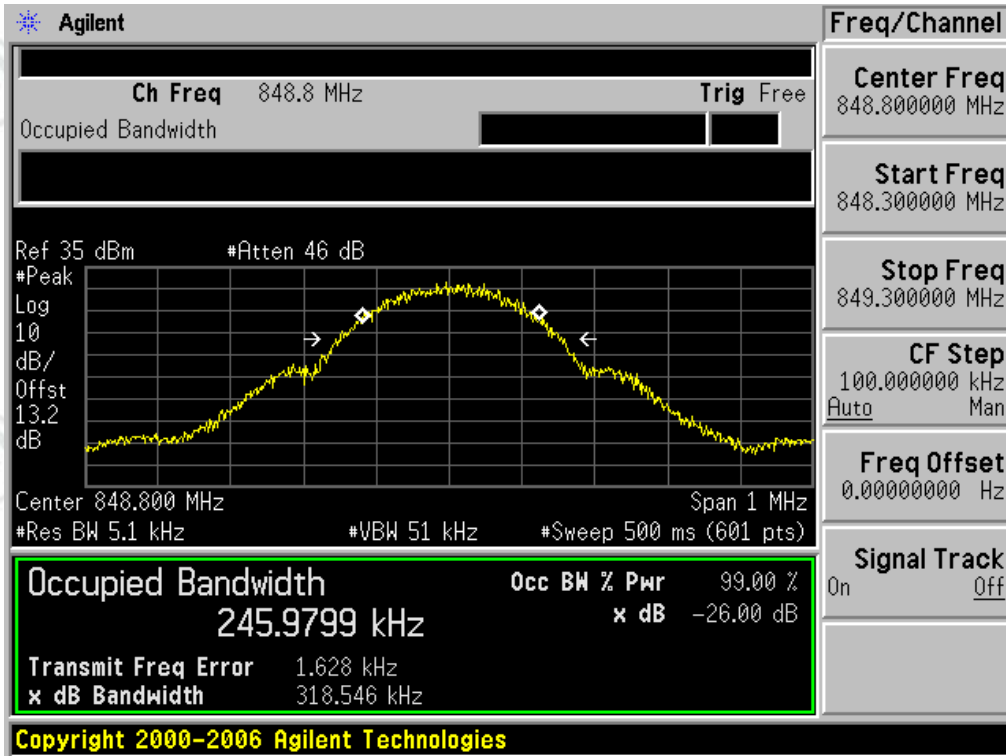

Test Band=GPRS1900

Test Mode=GPRS/TM2

Test Channel=LCH



Test Channel=MCH

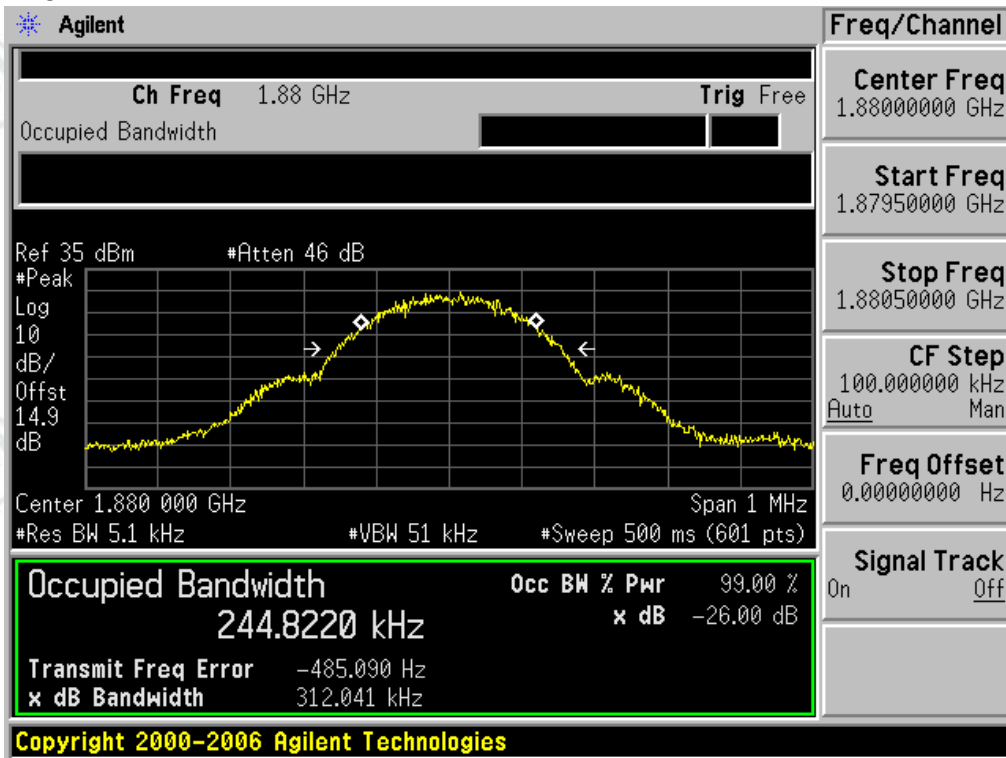

Test Channel=HCH

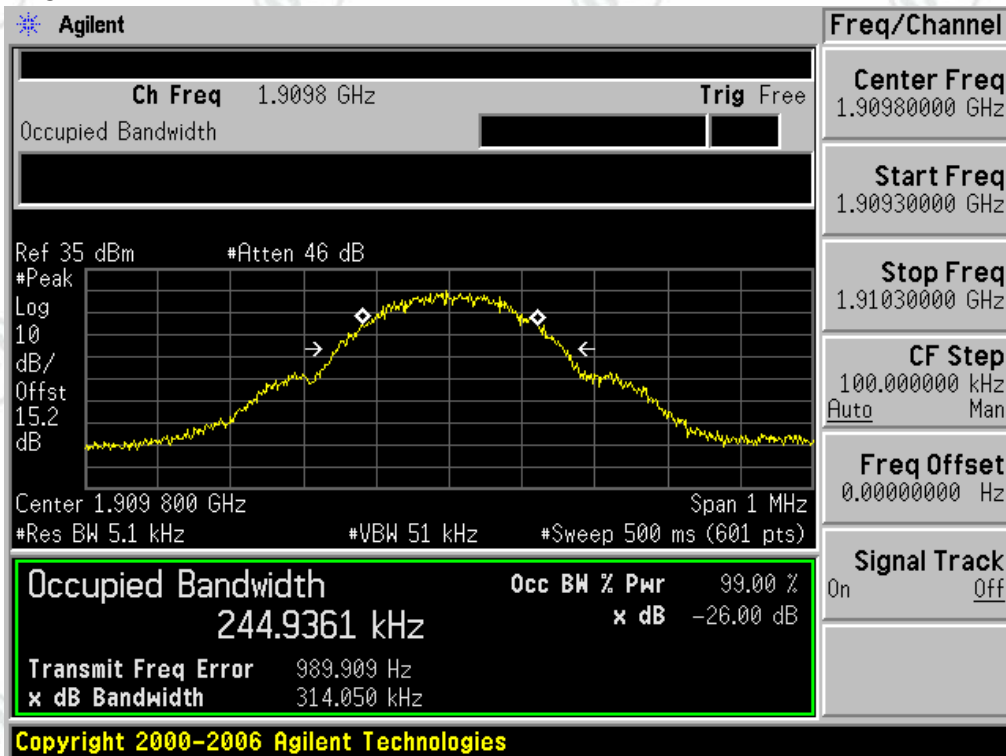

Appendix D) Band Edges Compliance

Test Requirement:	Part 2.1051		
Test Method:	Part 22.917(b)/Part 24.238(b)		
Test Setup:	Refer to section 5 for details		
Measurement Procedure:	The transmitter output was connected to a calibrated coaxial cable, attenuator and Spectrum analyser, the other end of which was connected to a Base Station Simulator. The Base Station Simulator was set to force the EUT to its maximum power setting. The tests were performed at three frequencies (low channel and high channel).in the 1MHz bands immediately outside and adjacent to the frequency block a resolution bandwidth of 100kHz or 1% of the emission bandwidth of the fundamental emission of the transmitter may be employed. The EUT emission bandwidth is measured as the width of the signal between two points, outside of which all emission are attenuated at least 26dB below the transmitter power. The video bandwidth of the spectrum analyzer was set at thrice the resolution bandwidth. Detector Mode was set to peak or peak hold power.		
Limit:	Operation Band	Frequency Range (MHz)	Limit
	GSM/GPRS/EDGE/WCDMA 850	Below 824 and above 849	Attenuated at least 43+10log(P)
	GSM/GPRS/EDGE/WCDMA 1900	Below 1850 and above 1910	Attenuated at least 43+10log(P)
Instruments Used:	Refer to section 7 for details		
Test Results:	Pass		

Test Graphs:

For GPRS

Test Band=GPRS850

Test Mode=GPRS/TM2

Test Channel=LCH

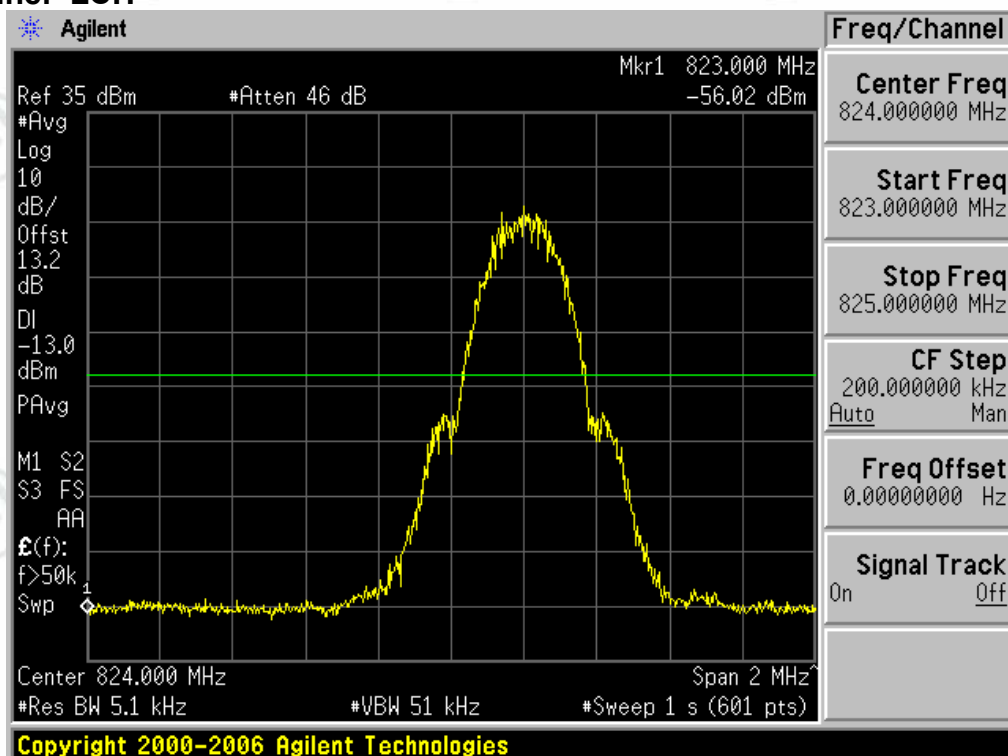

Test Channel=HCH

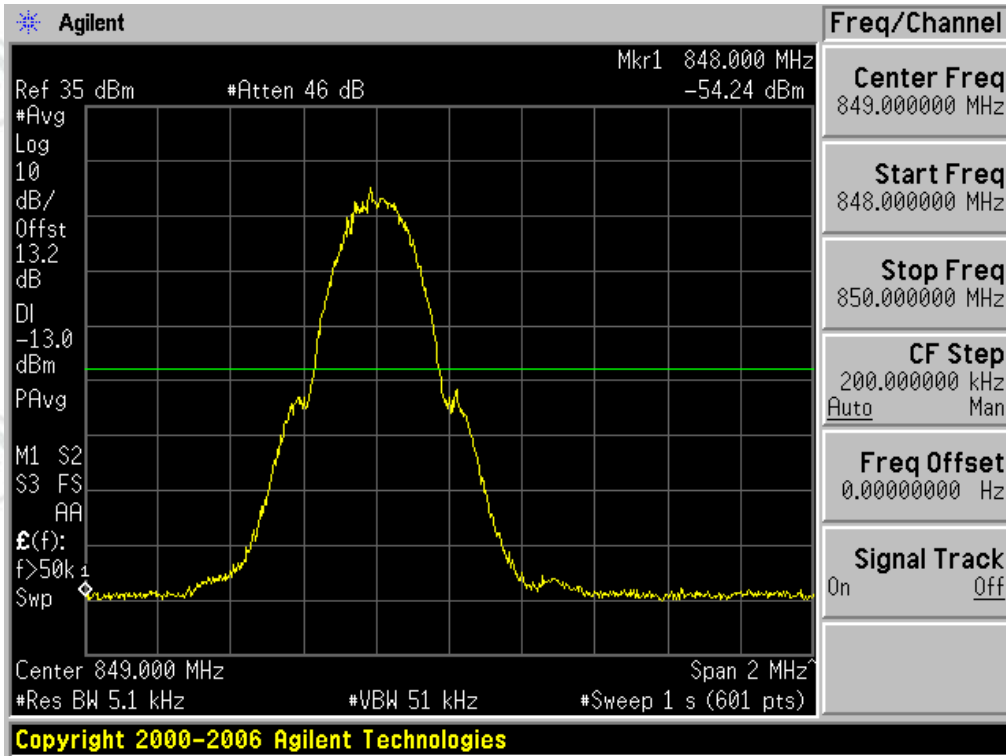

Test Band=GPRS1900
Test Mode=GPRS/TM2
Test Channel=LCH

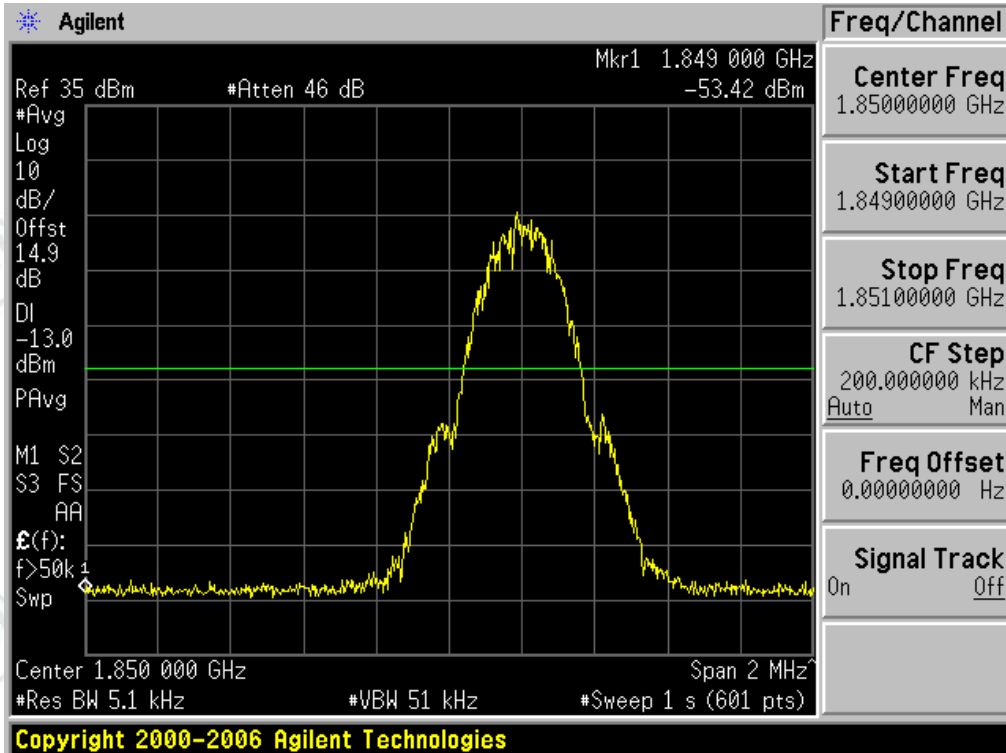

Test Channel=HCH

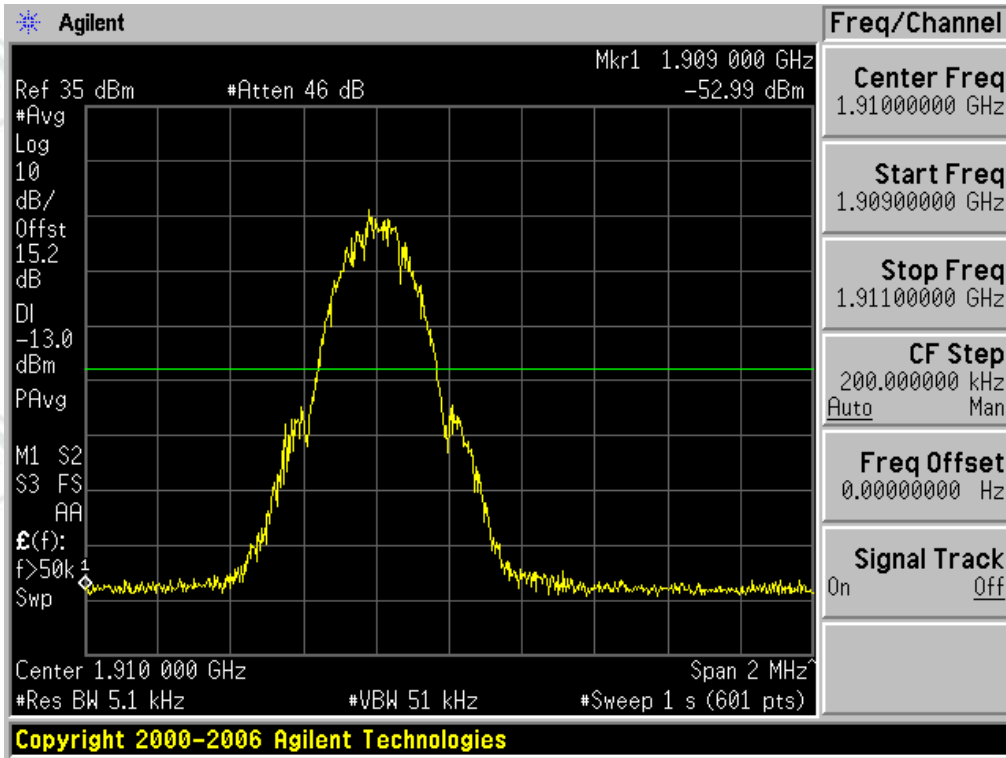

Appendix E) Spurious Emission at Antenna Terminal

Test Requirement:	Part 2.1051/Part 2.1057
Test Method:	TIA-603-D-2010 Clause 2.2.13
Test Setup:	Refer to section 5 for details
Measurement Procedure:	The transmitter output was connected to a calibrated coaxial cable, attenuator and Spectrum analyzer, the other end of which was connected to a Base Station Simulator. The Base Station Simulator was set to force the EUT to its maximum power setting. The tests were performed at three frequencies (low channel and high channel).the equipment operates below 10GHz: to the tenth harmonic of the highest fundamental frequency or to 40GHz.whichever is lower, the resolution bandwidth of the spectrum analyzer was set at 100kHz for spurious emissions below 1 GHz, and 1 MHz for spurious emissions above 1GHz.the video bandwidth of the spectrum analyzer was set at thrice the resolution bandwidth. Detector Mode was set to mean or average power.
Instruments Used:	Refer to section 7 for details
Limit:	Attenuated at least $43+10\log(P)$
Test Results:	Pass

Test Graphs:

For GPRS

Test Band=GPRS850

Test Mode=GPRS/TM2

Test Channel=LCH

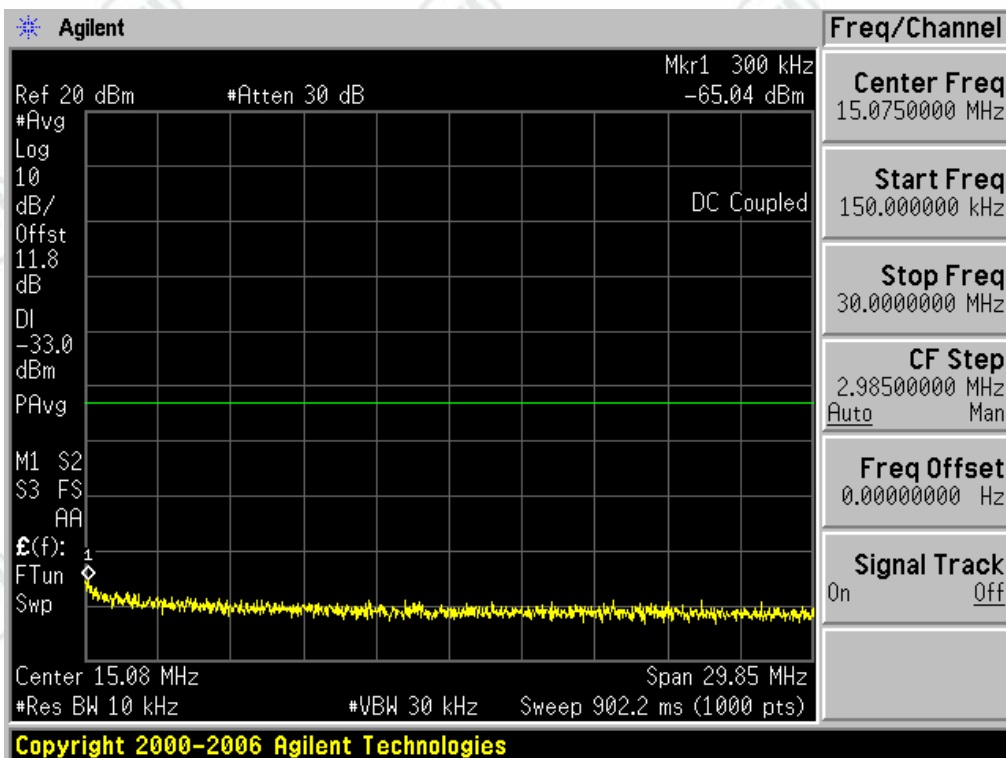
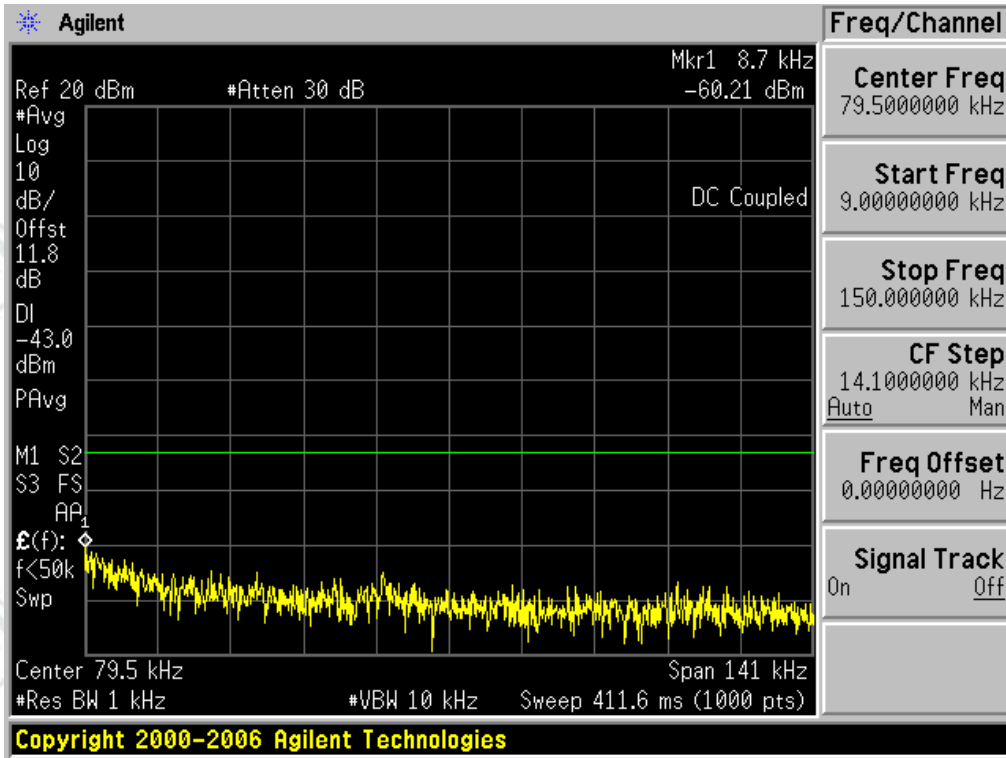

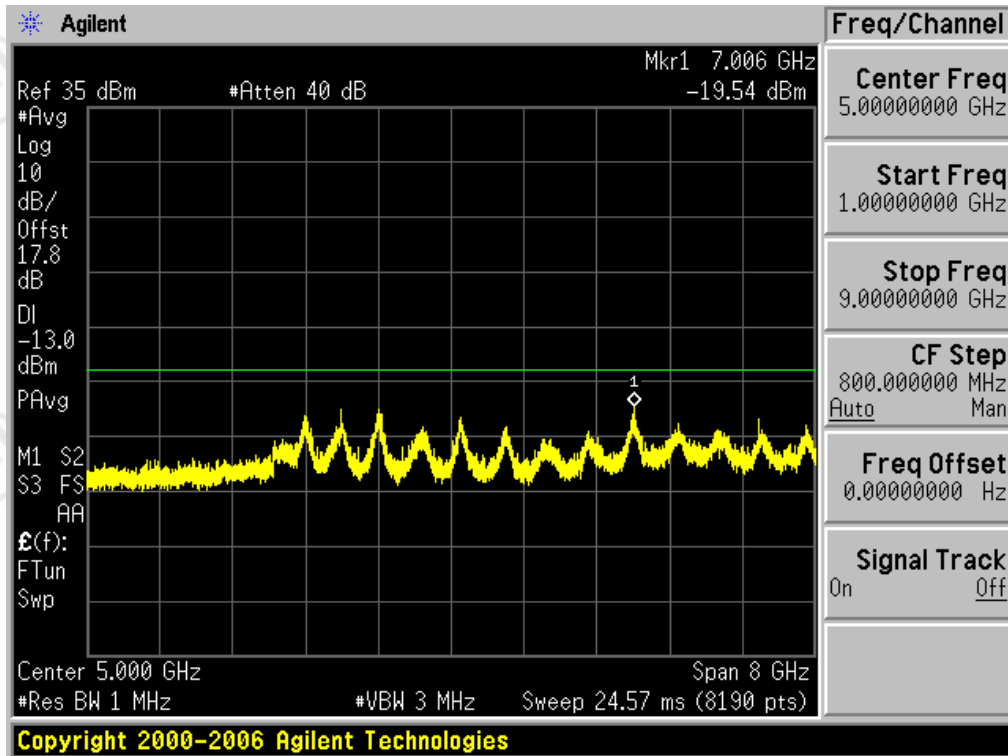
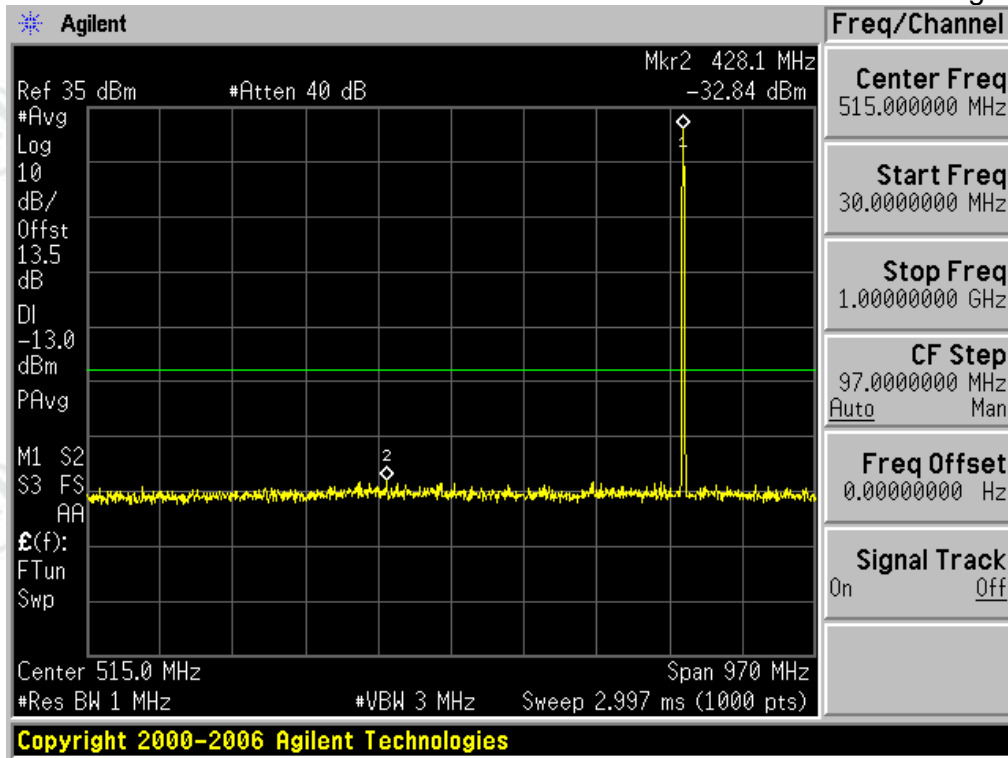

Test Channel=MCH

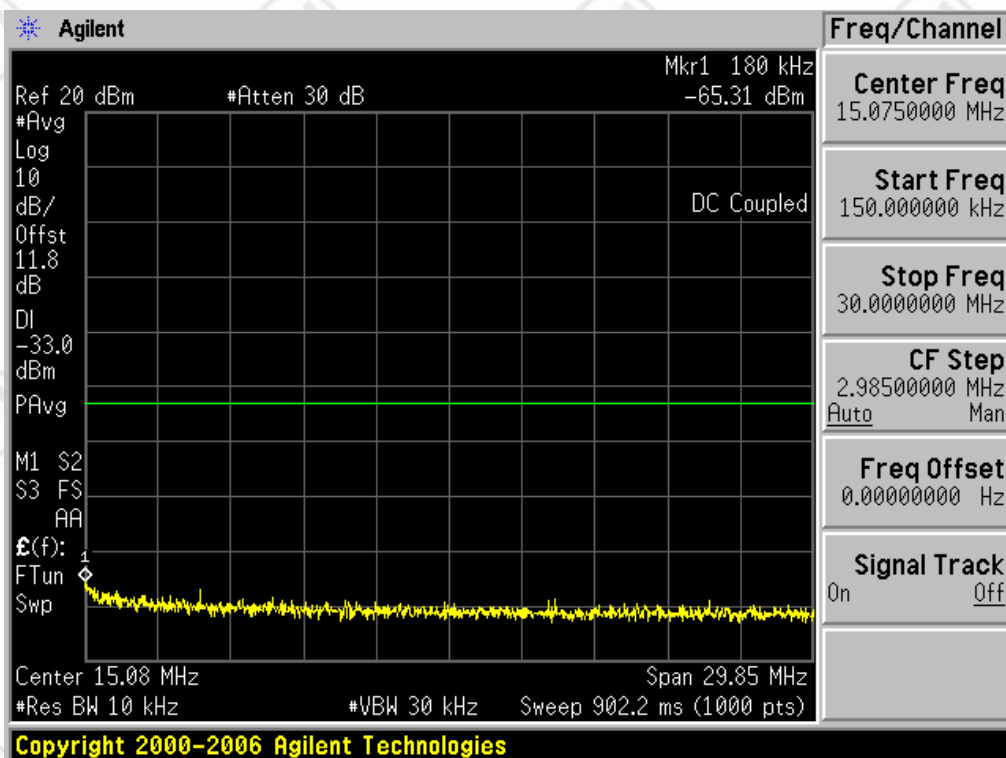
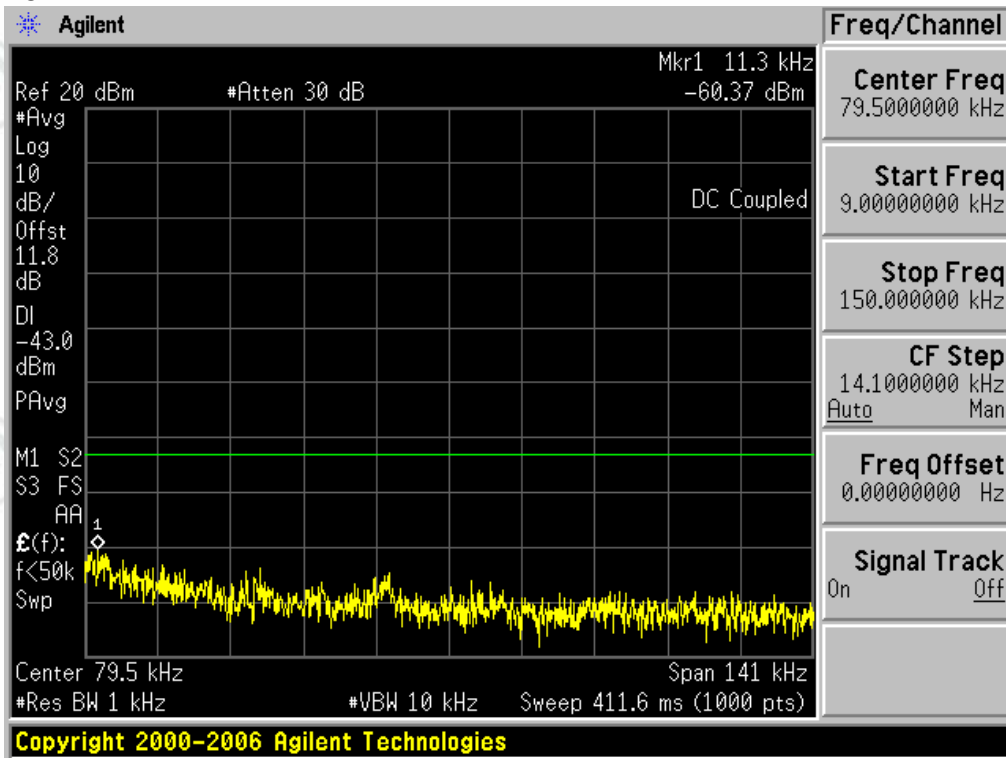

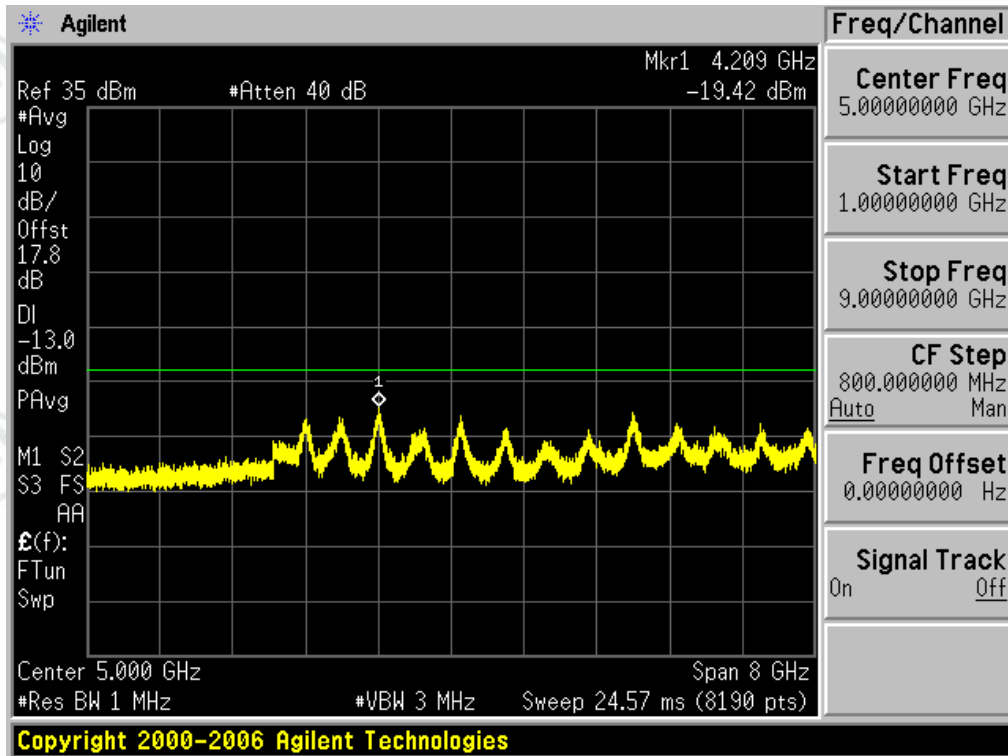
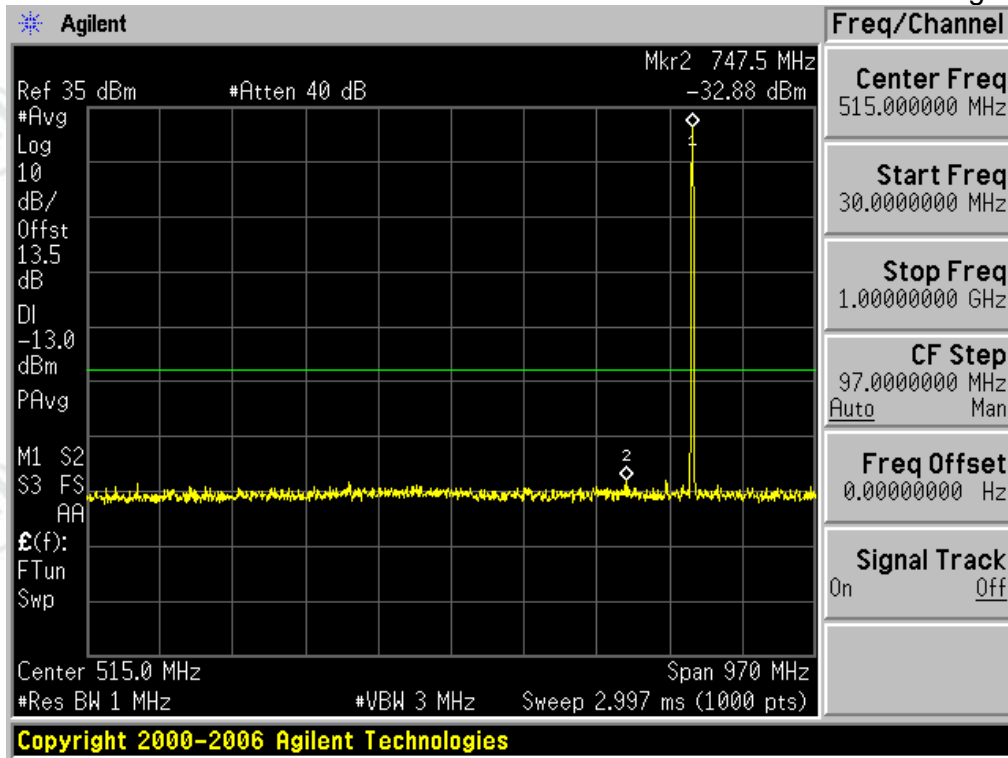

Test Channel=HCH

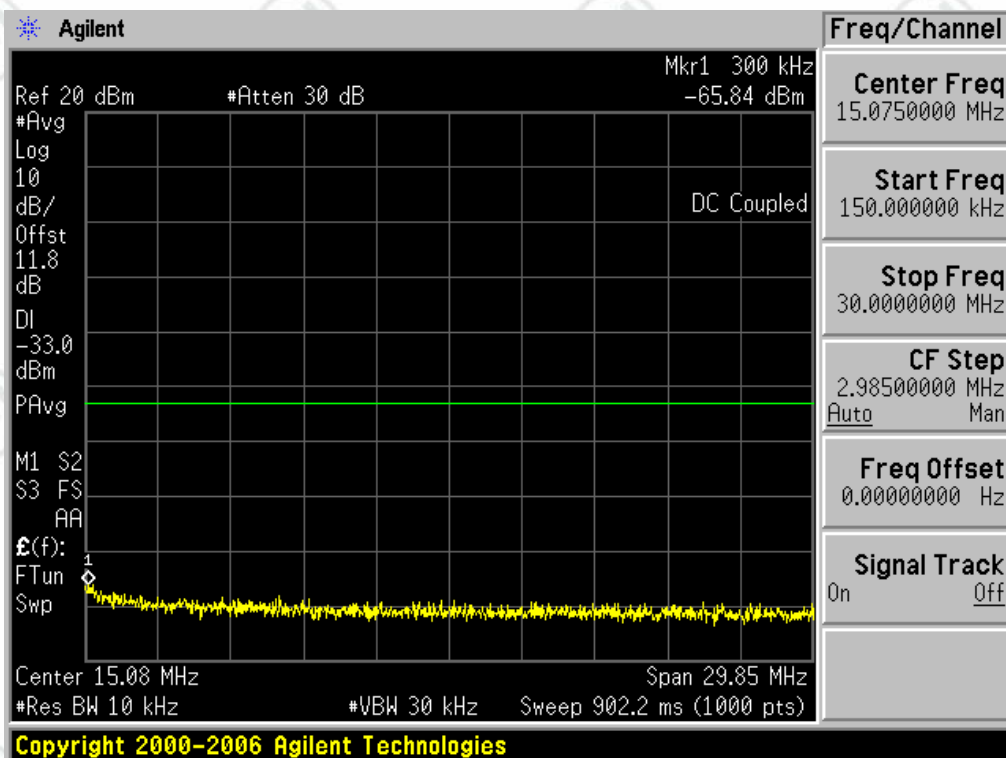
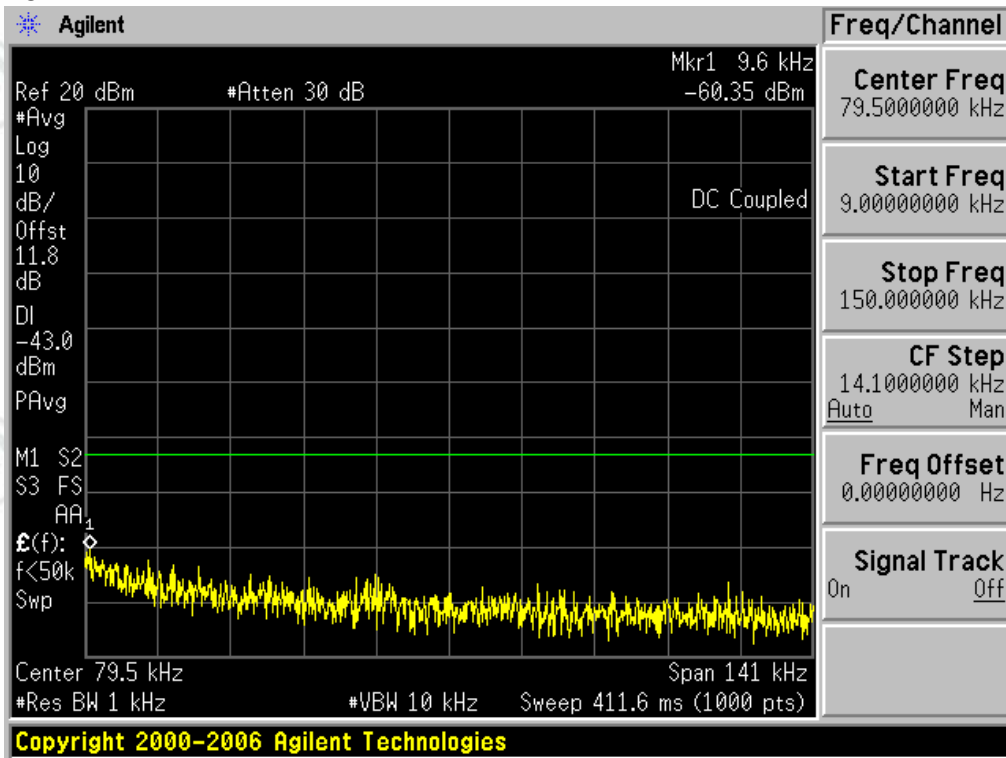

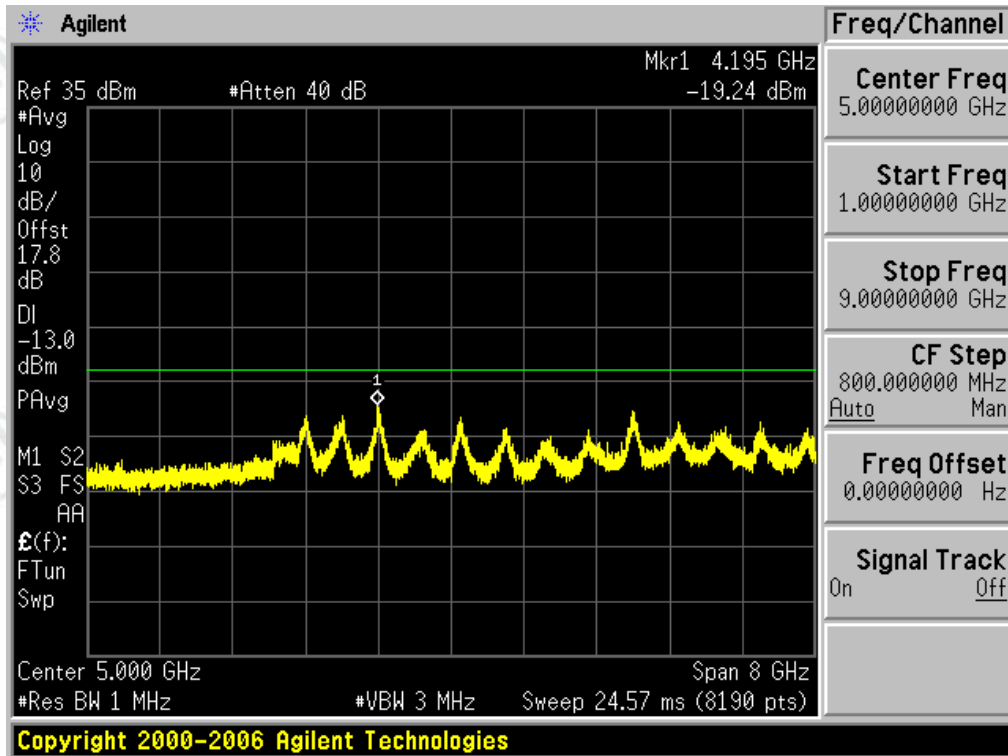
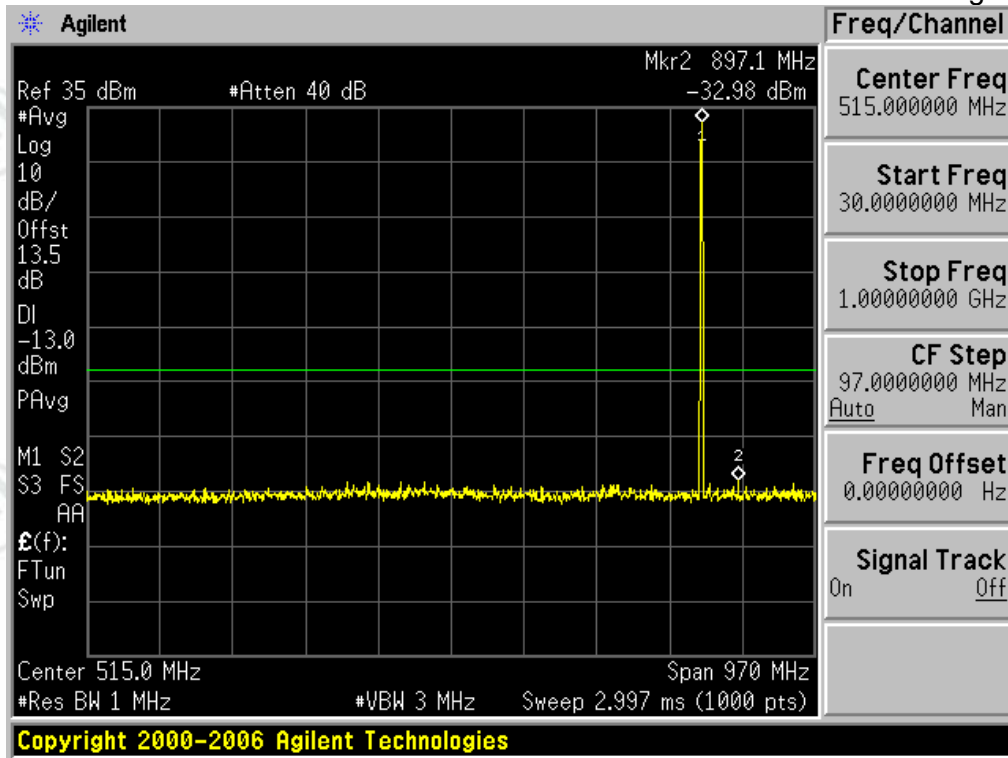

Test Band=GPRS1900

Test Mode=GPRS/TM2

Test Channel=LCH

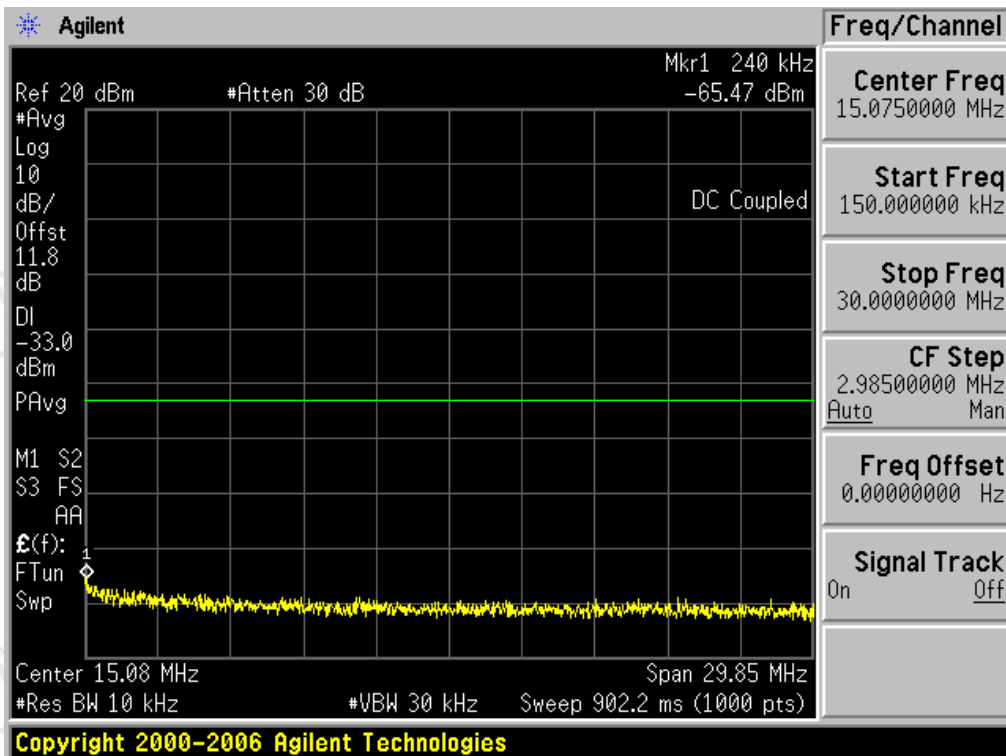
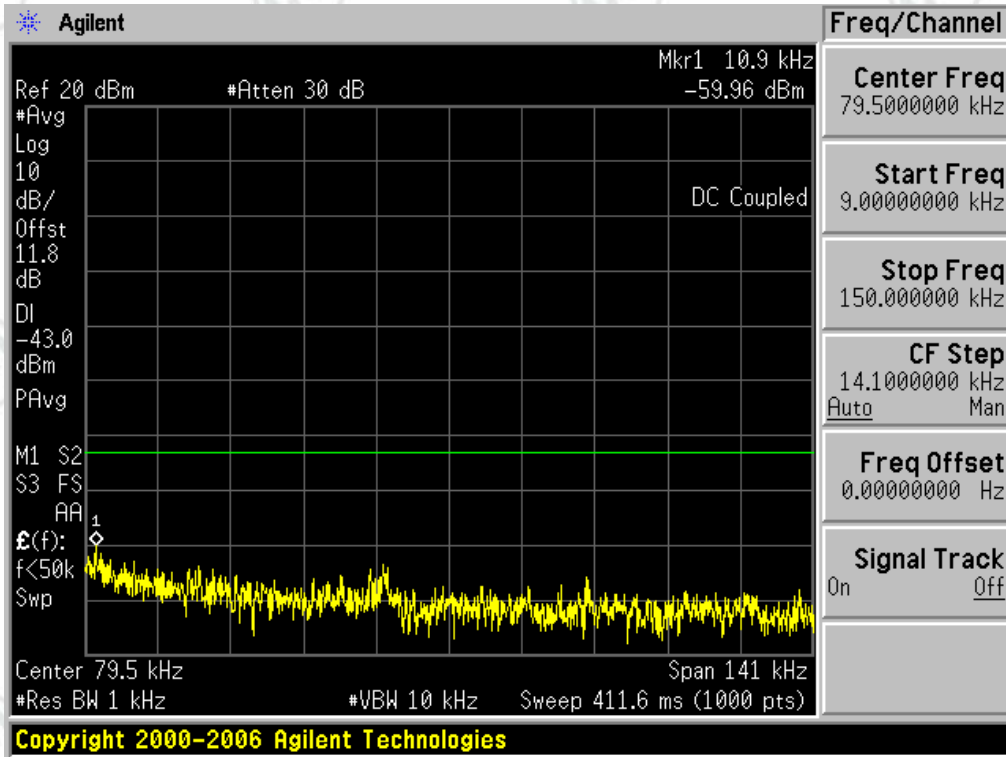

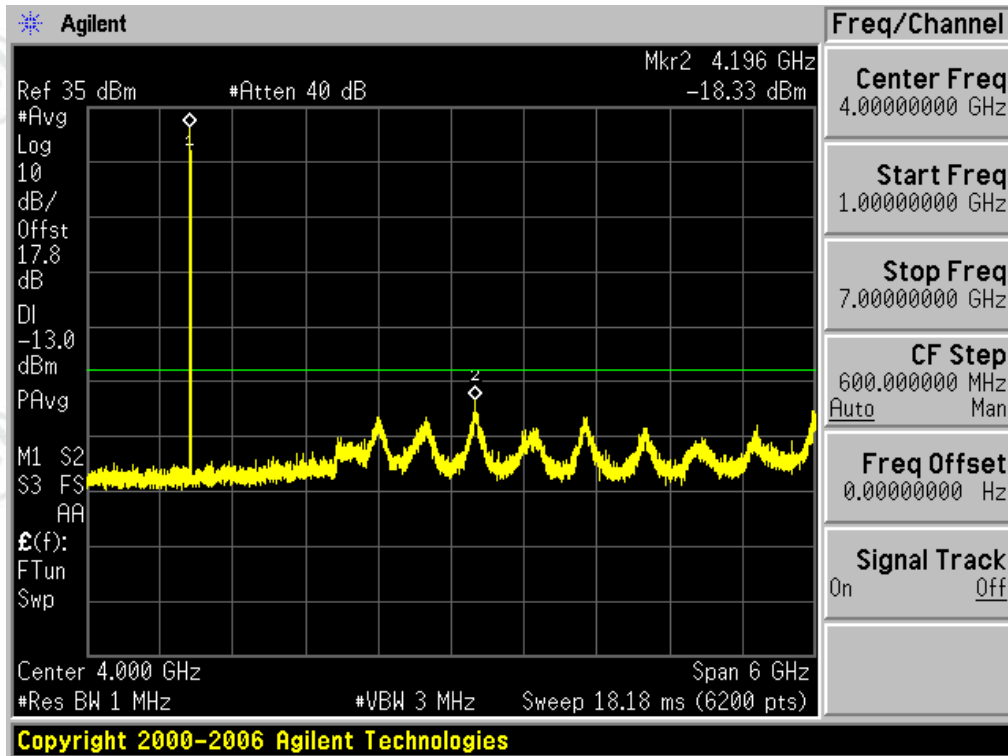
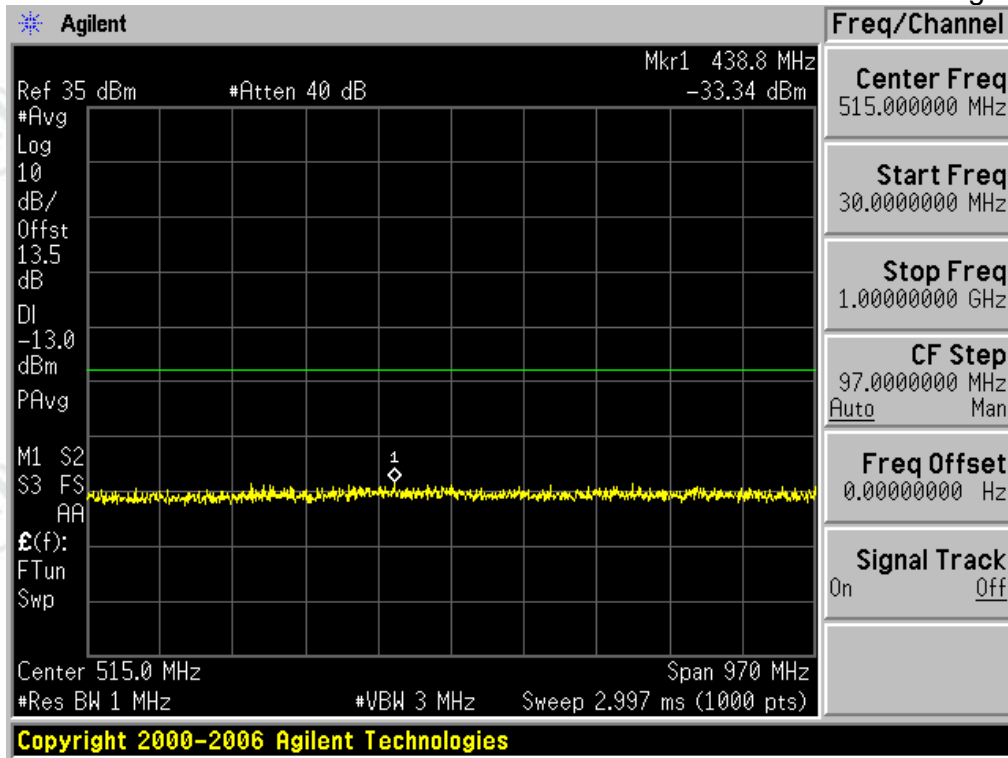

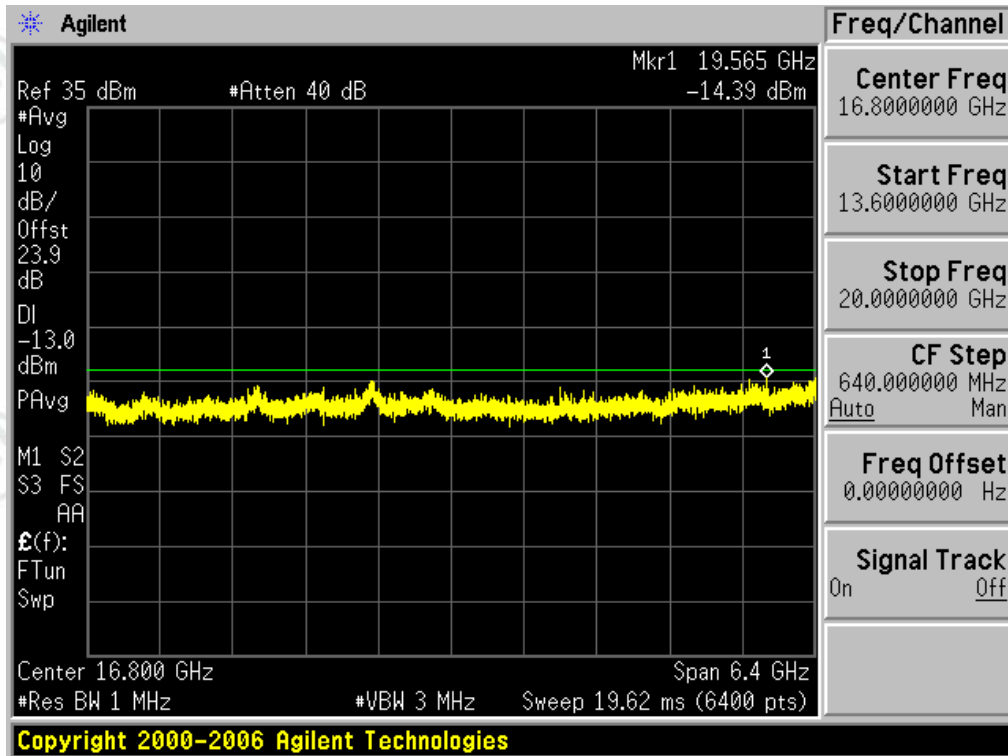
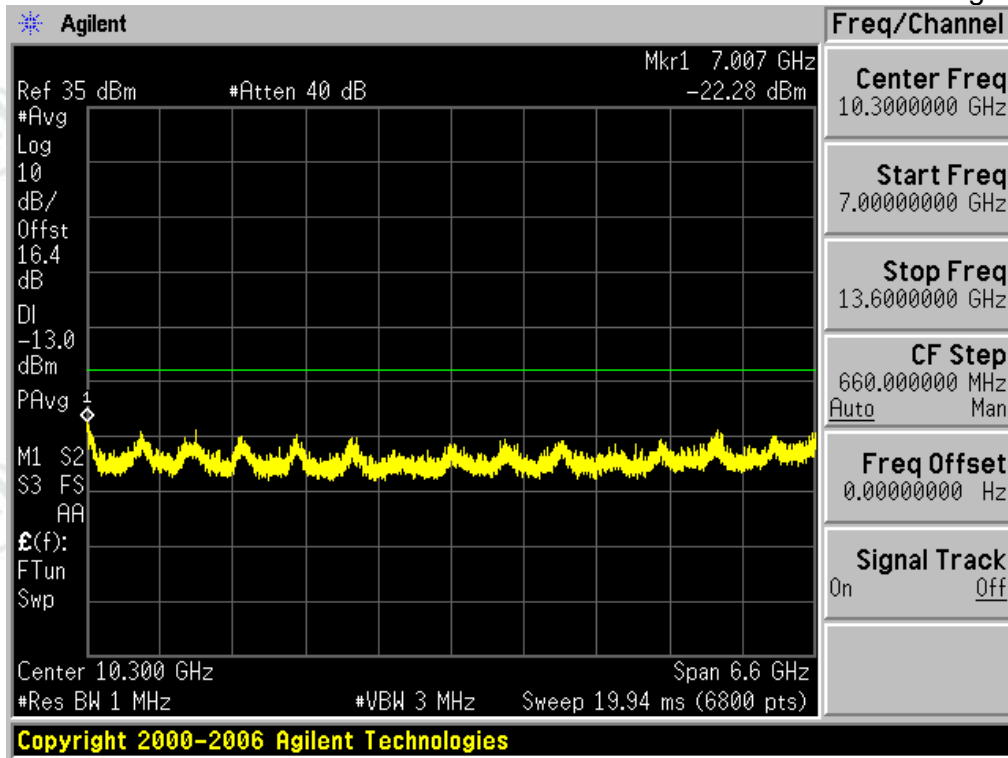

Test Channel=MCH

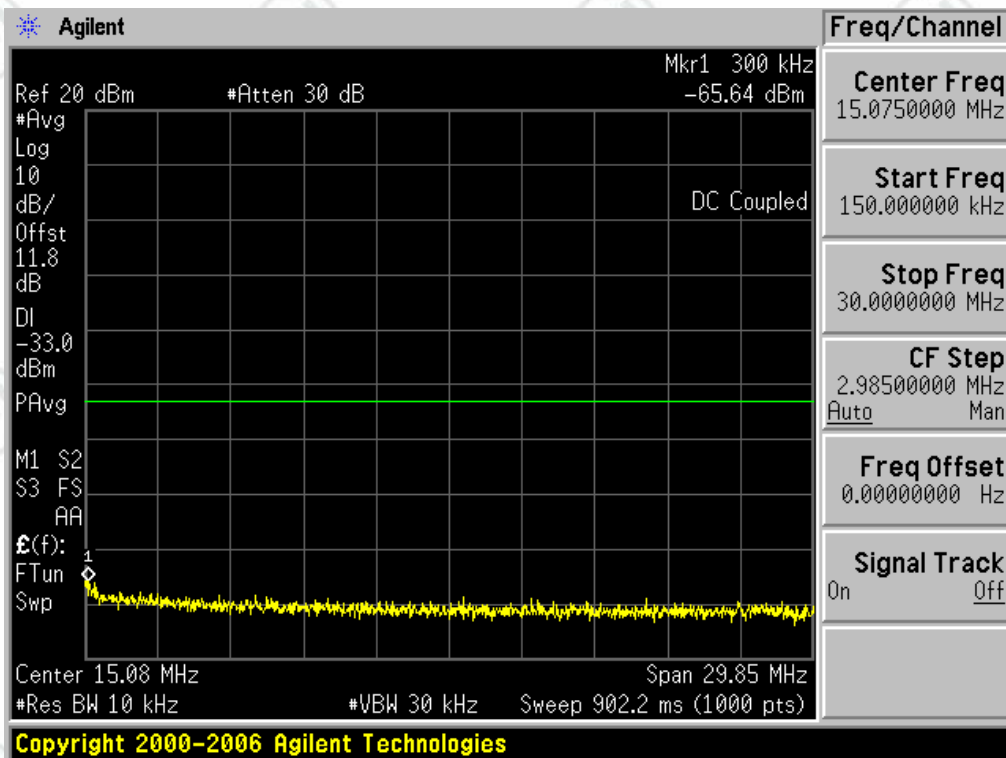
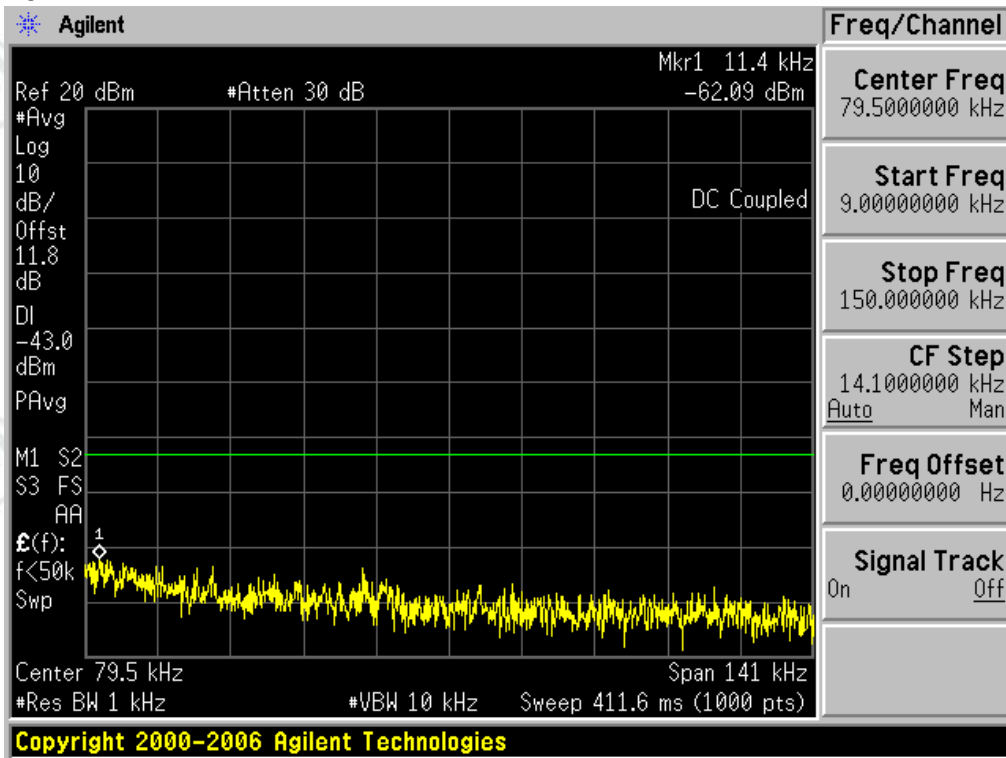

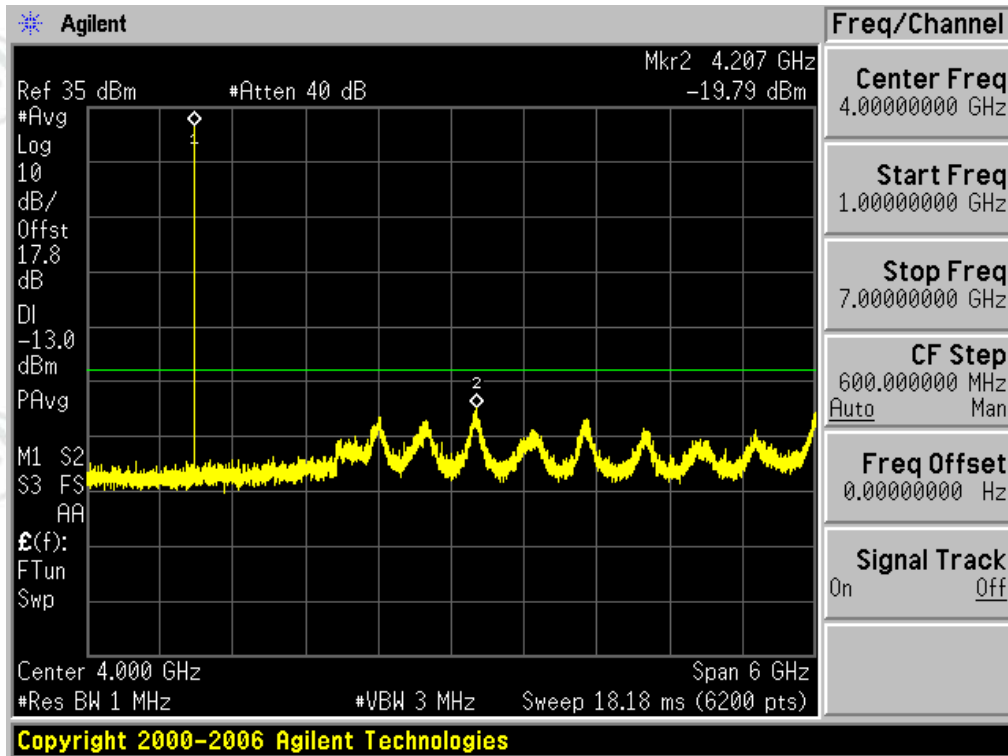
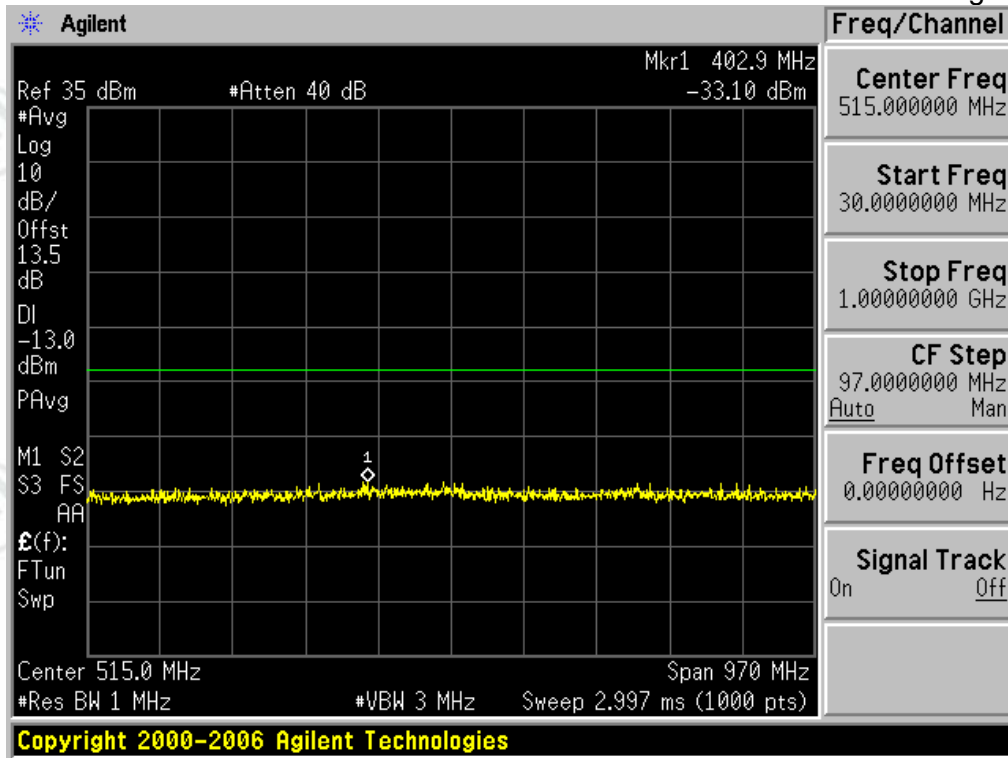

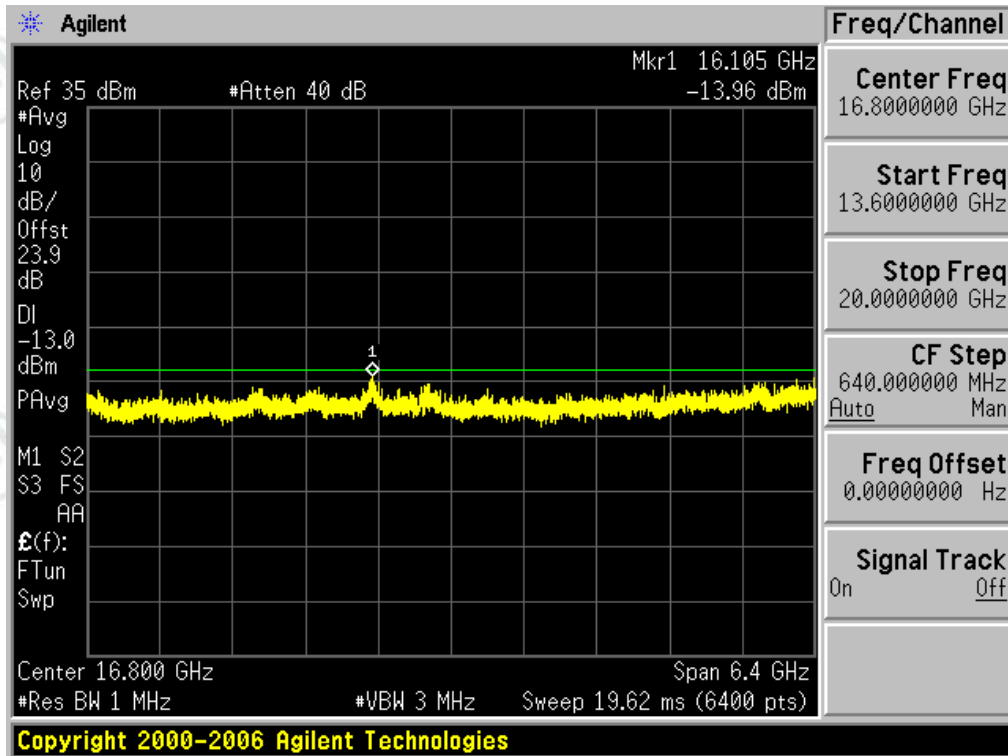
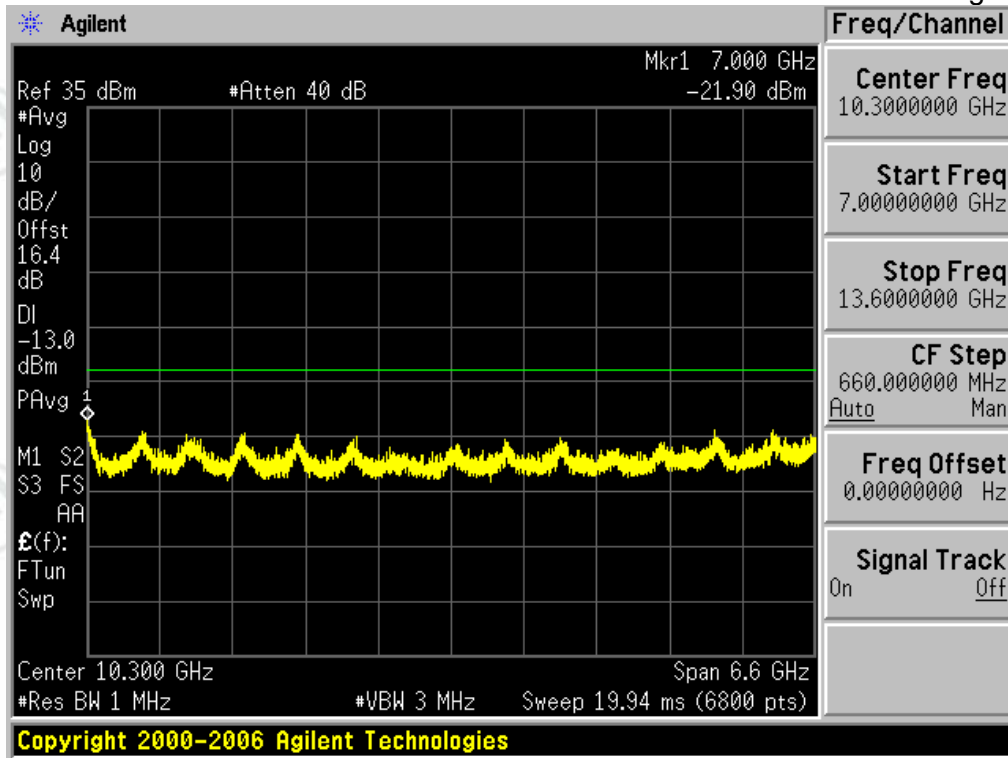

Test Channel=HCH

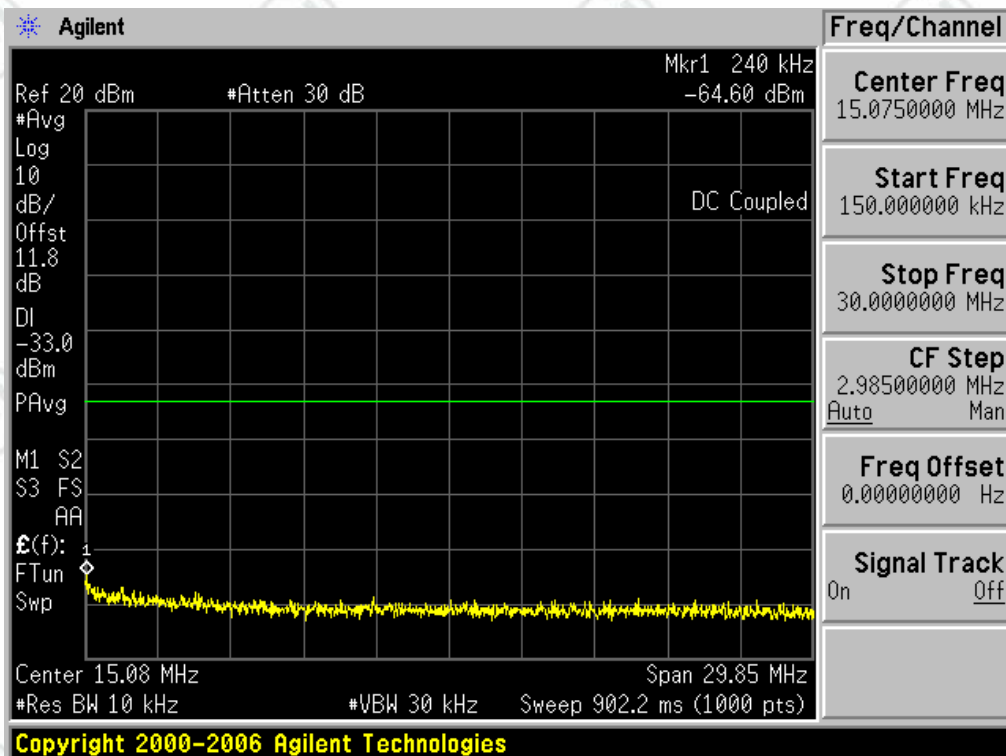
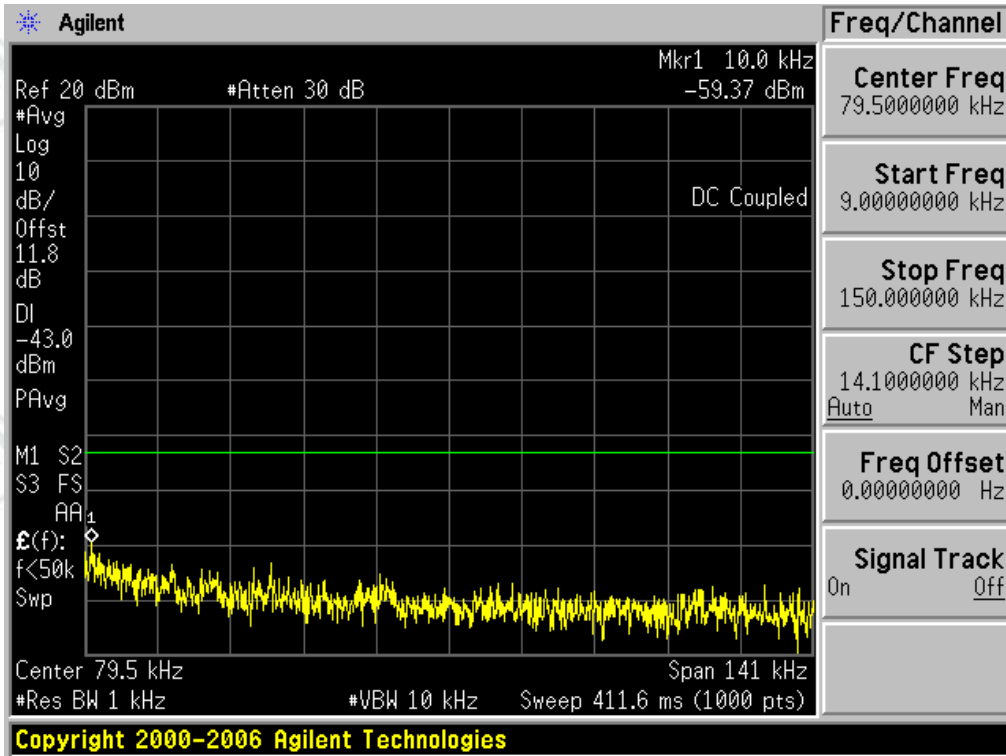

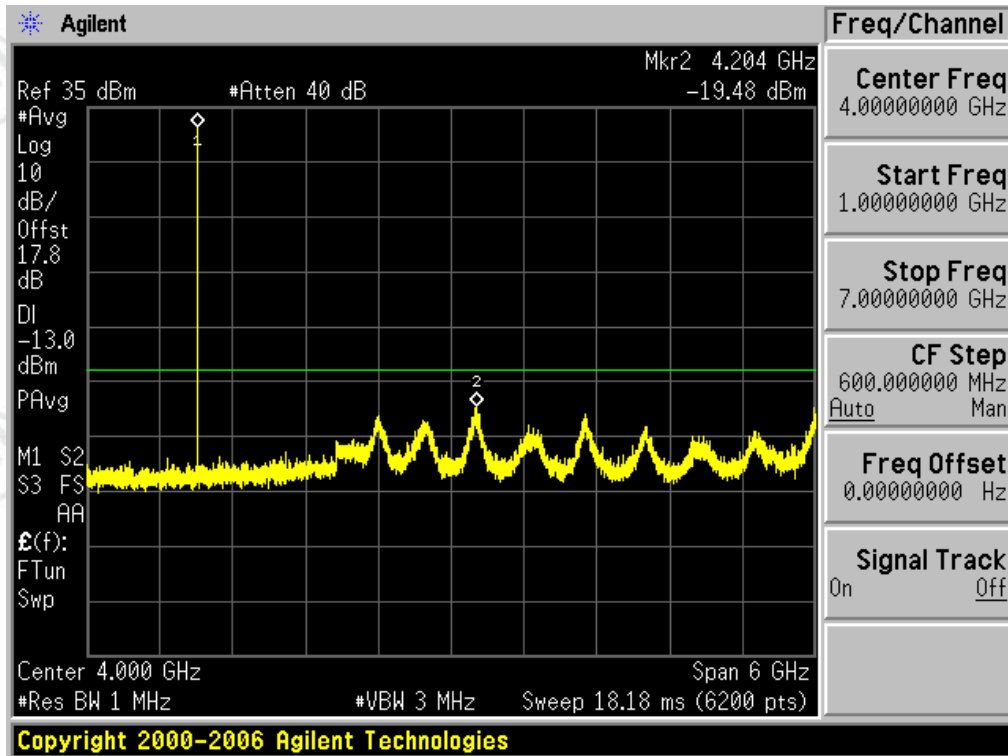
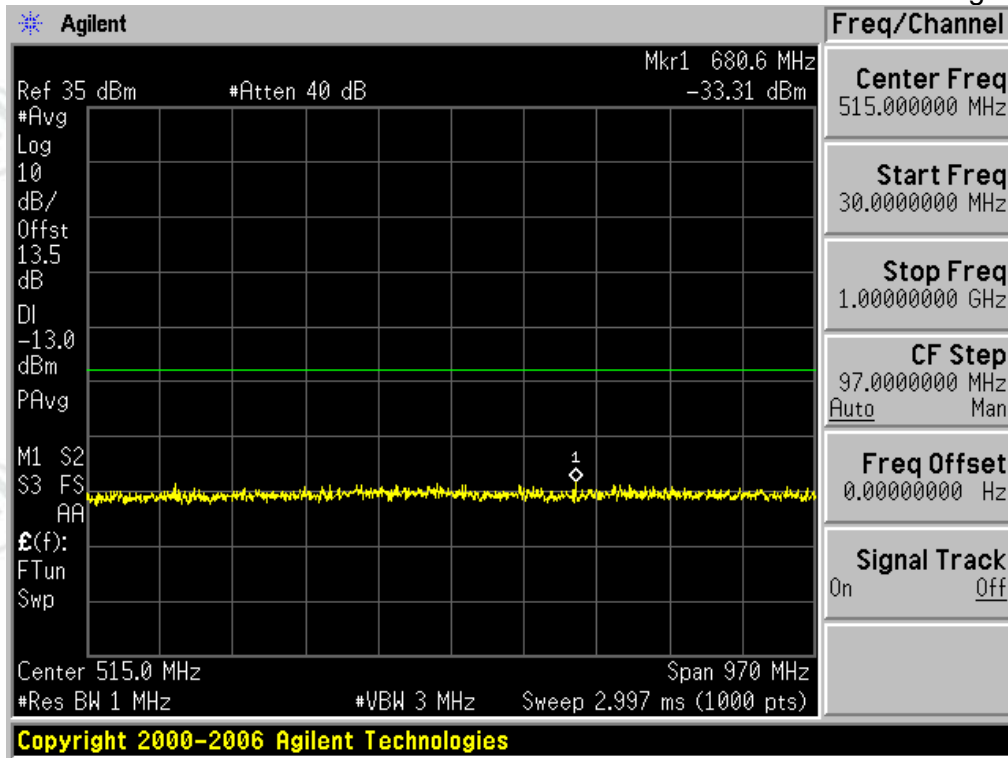

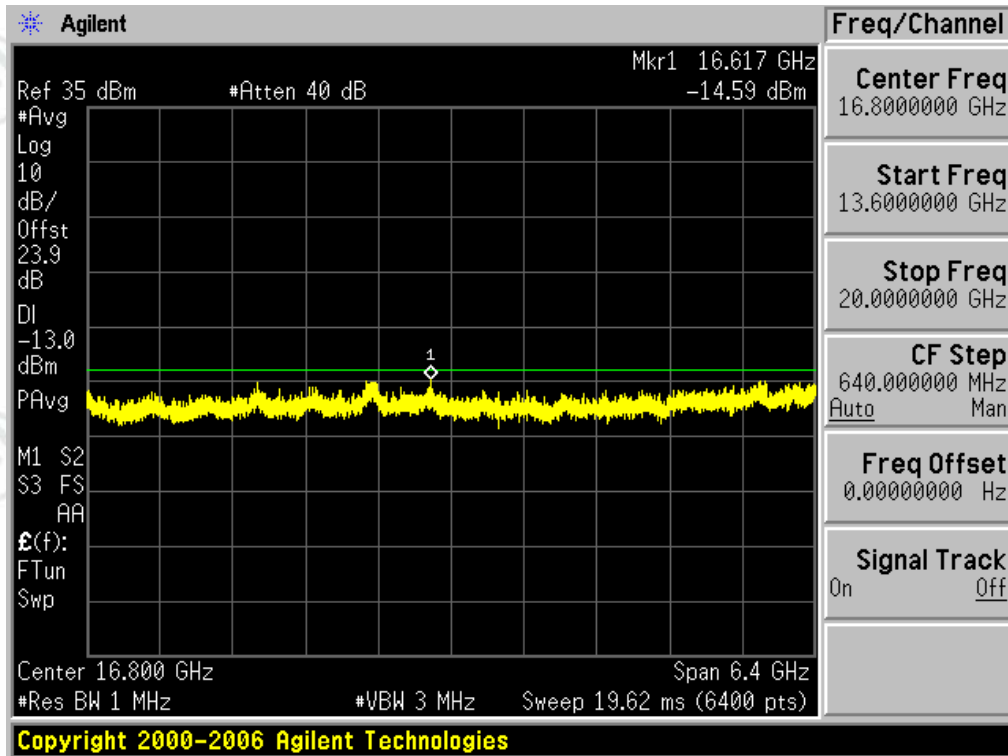
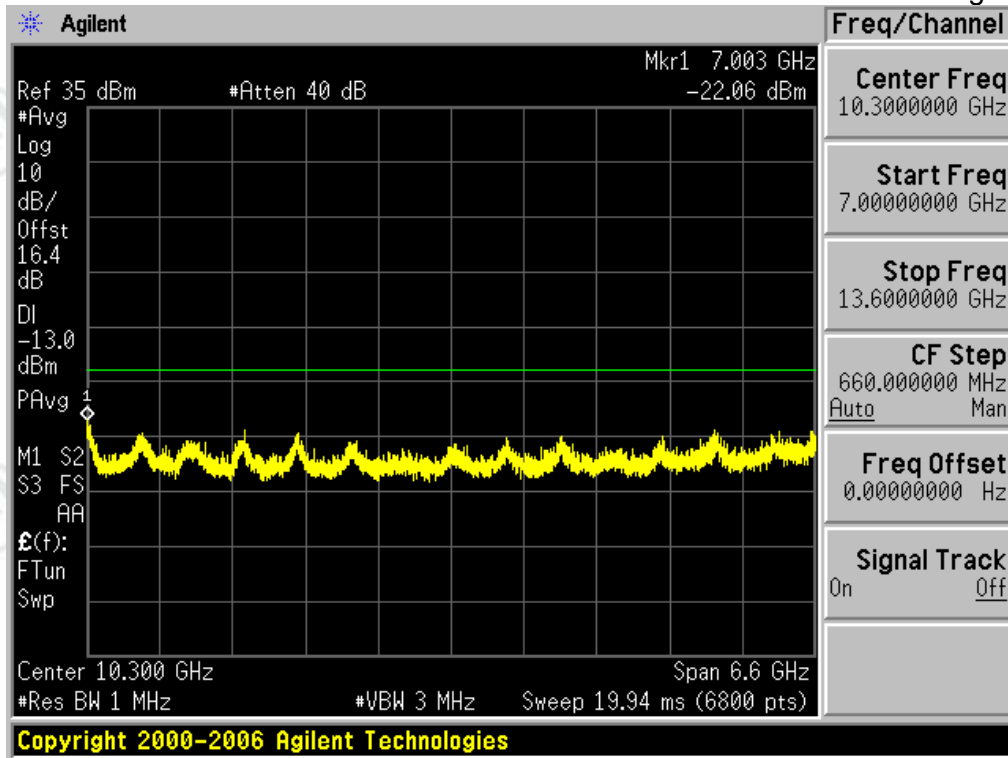

Appendix F) Frequency Stability

Test Requirement:	Part 2.1055	
Test Method:	TIA-603-D-2010 Clause 2.2.2	
Test Setup:	Refer to section 5 for details	
Measurement Procedure:	The transmitter output was connected to a calibrated coaxial cable and a Base Station Simulator. The Base Station Simulator was set to force the EUT to its maximum power setting. The tests were performed at three frequencies (low channel and high channel). The EUT was placed in the temperature chamber, the DC leads and RF output cable exited the chamber through an opening made for that purpose. After Operate the equipment in standby conditions for 15 minutes before proceeding. The temperature was varied from -30°C to +50°C at intervals of not more than 10°C The frequency stability was read from the base station at 25°C the input voltage was varied +/-15%, the frequency stability and input voltage was record.	
Instruments Used:	Refer to section 7 for details	
Limit:	Operation Band	Frequency stability Limit(ppm)
	GSM/GPRS/EDGE/WCDMA 850	±2.5ppm
	GSM/GPRS/EDGE/WCDMA 1900	±2.5ppm
Test Results:	Pass	

Test Data:

Frequency Error vs. Voltage:

Test Band	Test Mode	Test Channel	Test Temp.	Test Volt.	Freq.Error (Hz)	Freq.vs.rated (ppm)	Limit (ppm)	Verdict
GPRS850	TM2	LCH	TN	VL	-4.46	-0.01	±2.5	PASS
			TN	VN	-6.59	-0.01	±2.5	PASS
			TN	VH	-6.20	-0.01	±2.5	PASS
		MCH	TN	VL	-11.43	-0.01	±2.5	PASS
			TN	VN	-9.75	-0.01	±2.5	PASS
			TN	VH	-10.07	-0.01	±2.5	PASS
		HCH	TN	VL	-9.88	-0.01	±2.5	PASS
			TN	VN	-11.30	-0.01	±2.5	PASS
			TN	VH	-13.50	-0.02	±2.5	PASS

Test Band	Test Mode	Test Channel	Test Temp.	Test Volt.	Freq.Error (Hz)	Freq.vs.rated (ppm)	Limit (ppm)	Verdict
GPRS190 0	TM2	LCH	TN	VL	-51.01	-0.03	±2.5	PASS
			TN	VN	-49.01	-0.03	±2.5	PASS
			TN	VH	-48.49	-0.03	±2.5	PASS
		MCH	TN	VL	-50.37	-0.03	±2.5	PASS
			TN	VN	-48.56	-0.03	±2.5	PASS
			TN	VH	-51.92	-0.03	±2.5	PASS
		HCH	TN	VL	-49.07	-0.03	±2.5	PASS
			TN	VN	-50.69	-0.03	±2.5	PASS
			TN	VH	-51.01	-0.03	±2.5	PASS

Frequency Error vs. Temperature:

Test Band	Test Mode	Test Channel	Test Volt.	Test Temp.	Freq.Error (Hz)	Freq.vs.rated (ppm)	Limit (ppm)	Verdict
GPRS850	TM2	LCH	VN	-30	-10.59	-0.01	±2.5	PASS
			VN	-20	-3.81	0.00	±2.5	PASS
			VN	-10	-3.42	0.00	±2.5	PASS
			VN	0	-4.26	-0.01	±2.5	PASS
			VN	10	-7.88	-0.01	±2.5	PASS
			VN	20	-7.30	-0.01	±2.5	PASS
			VN	30	-12.66	-0.02	±2.5	PASS
			VN	40	-9.88	-0.01	±2.5	PASS
			VN	50	-13.88	-0.02	±2.5	PASS
GPRS850	TM2	MCH	VN	-30	-8.14	-0.01	±2.5	PASS
			VN	-20	-10.53	-0.01	±2.5	PASS
			VN	-10	-16.47	-0.02	±2.5	PASS
			VN	0	-11.88	-0.01	±2.5	PASS
			VN	10	-17.89	-0.02	±2.5	PASS
			VN	20	-13.88	-0.02	±2.5	PASS
			VN	30	-20.47	-0.02	±2.5	PASS
			VN	40	-17.37	-0.02	±2.5	PASS
			VN	50	-13.50	-0.02	±2.5	PASS
GPRS850	TM2	HCH	VN	-30	-12.40	-0.01	±2.5	PASS
			VN	-20	-16.72	-0.02	±2.5	PASS
			VN	-10	-18.53	-0.02	±2.5	PASS
			VN	0	-15.24	-0.02	±2.5	PASS
			VN	10	-17.63	-0.02	±2.5	PASS
			VN	20	-13.69	-0.02	±2.5	PASS
			VN	30	-15.63	-0.02	±2.5	PASS
			VN	40	-18.27	-0.02	±2.5	PASS
			VN	50	-15.50	-0.02	±2.5	PASS

Test Band	Test Mode	Test Channel	Test Volt.	Test Temp.	Freq.Error (Hz)	Freq.vs.rated (ppm)	Limit (ppm)	Verdict
GPRS190 0	TM2	LCH	VN	-30	-46.49	-0.03	±2.5	PASS
			VN	-20	-71.80	-0.04	±2.5	PASS
			VN	-10	-73.61	-0.04	±2.5	PASS
			VN	0	-66.64	-0.04	±2.5	PASS
			VN	10	-69.22	-0.04	±2.5	PASS
			VN	20	-68.83	-0.04	±2.5	PASS
			VN	30	-73.61	-0.04	±2.5	PASS
			VN	40	-65.54	-0.04	±2.5	PASS
			VN	50	-70.06	-0.04	±2.5	PASS
GPRS190 0	TM2	MCH	VN	-30	-54.50	-0.03	±2.5	PASS
			VN	-20	-75.68	-0.04	±2.5	PASS
			VN	-10	-77.10	-0.04	±2.5	PASS
			VN	0	-75.87	-0.04	±2.5	PASS
			VN	10	-71.48	-0.04	±2.5	PASS
			VN	20	-66.06	-0.04	±2.5	PASS
			VN	30	-71.16	-0.04	±2.5	PASS
			VN	40	-69.29	-0.04	±2.5	PASS
			VN	50	-64.64	-0.03	±2.5	PASS
GPRS190 0	TM2	HCH	VN	-30	-49.33	-0.03	±2.5	PASS
			VN	-20	-67.93	-0.04	±2.5	PASS
			VN	-10	-65.99	-0.03	±2.5	PASS
			VN	0	-62.31	-0.03	±2.5	PASS
			VN	10	-70.71	-0.04	±2.5	PASS
			VN	20	-64.31	-0.03	±2.5	PASS
			VN	30	-68.96	-0.04	±2.5	PASS
			VN	40	-60.25	-0.03	±2.5	PASS
			VN	50	-63.80	-0.03	±2.5	PASS

Appendix G) Effective Radiated Power of Transmitter (ERP/EIRP)

Receiver Setup:	<table border="1"> <thead> <tr> <th>Frequency</th> <th>Detector</th> <th>RBW</th> <th>VBW</th> <th>Remark</th> </tr> </thead> <tbody> <tr> <td>30MHz-1GHz</td> <td>peak</td> <td>120kHz</td> <td>300kHz</td> <td>Peak</td> </tr> <tr> <td>Above 1GHz</td> <td>Peak</td> <td>1MHz</td> <td>3MHz</td> <td>Peak</td> </tr> </tbody> </table>	Frequency	Detector	RBW	VBW	Remark	30MHz-1GHz	peak	120kHz	300kHz	Peak	Above 1GHz	Peak	1MHz	3MHz	Peak
Frequency	Detector	RBW	VBW	Remark												
30MHz-1GHz	peak	120kHz	300kHz	Peak												
Above 1GHz	Peak	1MHz	3MHz	Peak												
Measurement Procedure:	<p>Below 1GHz test procedure as below:</p> <ol style="list-style-type: none"> The EUT was powered ON and placed on a 1.5m high table in the chamber.,mount the equipment with the manufacturer specified antenna in a vertical orientation on a manufacturer.The antenna of the transmitter was extended to its maximum length. The disturbance of the transmitter was maximized on the test receiver display by raising and lowering from 1m to 4m the receive antenna and by rotating through 360° the turntable. After the fundamental emission was maximized, a field strength measurement was made. Steps 1) and 2) were performed with the EUT and the receive antenna in both vertical and horizontal polarization. The transmitter was then removed and replaced with another antenna. The center of the antenna was approximately at the same location as the center of the transmitter. A signal at the disturbance was fed to the substitution antenna by means of a non-radiating cable. With both the substitution and the receive antennas horizontally polarized, the receive antenna was raised and lowered to obtain a maximum reading at the test receiver. The level of the signal generator was adjusted until the measured field strength level in step 2) is obtained for this set of conditions. The output power into the substitution antenna was then measured. Steps 5) and 6) were repeated with both antennas polarization. Calculate power in dBm by the following formula: $ERP(dBm) = Pg(dBm) - \text{cable loss (dB)} + \text{antenna gain (dBd)}$ where: Pg is the generator output power into the substitution antenna. <p>Above 1GHz test procedure as below:</p> <ol style="list-style-type: none"> Different between above is the test site, change from Semi- Anechoic Chamber to fully Anechoic Chamber ; up to 18GHz a measurement distance of 3 meters is used, Above 18GHz the distance is 1 meter. Calculate power in dBm by the following formula: $EIRP(dBm) = Pg(dBm) - \text{cable loss (dB)} + \text{antenna gain (dBi)}$ $EIRP=ERP+2.15dB$ where: Pg is the generator output power into the substitution antenna. Test the EUT in the lowest channel, the middle channel the Highest channel The radiation measurements are performed in X, Y, Z axis positioning for EUT operation mode,And found the X axis positioning which it is worse case. Repeat above procedures until all frequencies measured was complete. 															
Limit:	<table border="1"> <thead> <tr> <th>Mode</th> <th>GSM 850</th> <th>GSM 1900</th> </tr> </thead> <tbody> <tr> <td>Frequency</td> <td>824 – 849MHz</td> <td>1850 – 1910MHz</td> </tr> <tr> <td>Limit</td> <td>38.45dBm (7W)</td> <td>33.01dBm (2W)</td> </tr> </tbody> </table>	Mode	GSM 850	GSM 1900	Frequency	824 – 849MHz	1850 – 1910MHz	Limit	38.45dBm (7W)	33.01dBm (2W)						
Mode	GSM 850	GSM 1900														
Frequency	824 – 849MHz	1850 – 1910MHz														
Limit	38.45dBm (7W)	33.01dBm (2W)														

Measurement Data

GPRS 850							
Channel/fc (MHz)	Height (cm)	Azimuth (deg)	ERP (dBm)	Limit (dBm)	Over Limit (dB)	Result	Antenna Polaxis.
128/824.2	150	35	21.50	38.45	-16.95	Pass	H
	200	126	23.51	38.45	-14.94	Pass	V
190/836.6	150	78	20.02	38.45	-18.43	Pass	H
	150	63	23.73	38.45	-14.72	Pass	V
251/848.8	150	174	19.67	38.45	-18.78	Pass	H
	250	132	23.95	38.45	-14.50	Pass	V

GPRS 1900							
Channel/fc (MHz)	Height (cm)	Azimuth (deg)	EIRP (dBm)	Limit (dBm)	Over Limit (dB)	Result	Antenna Polaxis.
512/1850.2	150	127	18.40	33.01	-14.61	Pass	H
	150	118	22.47	33.01	-10.54	Pass	V
661/1880.0	200	36	20.50	33.01	-12.51	Pass	H
	150	82	22.90	33.01	-10.11	Pass	V
810/1909.8	150	129	19.96	33.01	-13.05	Pass	H
	150	102	22.06	33.01	-10.95	Pass	V

Appendix H) Field strength of spurious radiation

Receiver Setup:	<table border="1"> <thead> <tr> <th>Frequency</th> <th>Detector</th> <th>RBW</th> <th>VBW</th> <th>Remark</th> </tr> </thead> <tbody> <tr> <td>0.009MHz-30MHz</td> <td>Peak</td> <td>10kHz</td> <td>30kHz</td> <td>Peak</td> </tr> <tr> <td>30MHz-1GHz</td> <td>Peak</td> <td>120kHz</td> <td>300kHz</td> <td>Peak</td> </tr> <tr> <td>Above 1GHz</td> <td>Peak</td> <td>1MHz</td> <td>3MHz</td> <td>Peak</td> </tr> </tbody> </table>	Frequency	Detector	RBW	VBW	Remark	0.009MHz-30MHz	Peak	10kHz	30kHz	Peak	30MHz-1GHz	Peak	120kHz	300kHz	Peak	Above 1GHz	Peak	1MHz	3MHz	Peak
Frequency	Detector	RBW	VBW	Remark																	
0.009MHz-30MHz	Peak	10kHz	30kHz	Peak																	
30MHz-1GHz	Peak	120kHz	300kHz	Peak																	
Above 1GHz	Peak	1MHz	3MHz	Peak																	
Measurement Procedure:	<p>Below 1GHz test procedure as below:</p> <ol style="list-style-type: none"> The EUT was powered ON and placed on a 1.5m high table in the chamber. ,mount the equipment with the manufacturer specified antenna in a vertical orientation on a manufacturer.The antenna of the transmitter was extended to its maximum length. The disturbance of the transmitter was maximized on the test receiver display by raising and lowering from 1m to 4m (for the test frequency of below 30MHz, the antenna was tuned to heights 1 meter) the receive antenna and by rotating through 360° the turntable. After the fundamental emission was maximized, a field strength measurement was made(the radiation measurements are performed in X, Y, Z axis positioning be lower 30 MHz.) Steps 1) and 2) were performed with the EUT and the receive antenna in both vertical and horizontal polarization. The transmitter was then removed and replaced with another antenna. The center of the antenna was approximately at the same location as the center of the transmitter. A signal at the disturbance was fed to the substitution antenna by means of a non-radiating cable. With both the substitution and the receive antennas horizontally polarized, the receive antenna was raised and lowered to obtain a maximum reading at the test receiver. The level of the signal generator was adjusted until the measured field strength level in step 2) is obtained for this set of conditions. The output power into the substitution antenna was then measured. Steps 5) and 6) were repeated with both antennas polarized and EUT . Calculate power in dBm by the following formula: $ERP(dBm) = Pg(dBm) - \text{cable loss (dB)} + \text{antenna gain (dBd)}$ where: Pg is the generator output power into the substitution antenna. <p>Above 1GHz test procedure as below:</p> <ol style="list-style-type: none"> Different between above is the test site, change from Semi- Anechoic Chamber to fully Anechoic Chamber ; up to 18GHz a measurement distance of 3 meters is used, Above 18GHz the distance is 1 meter. Calculate power in dBm by the following formula: $EIRP(dBm) = Pg(dBm) - \text{cable loss (dB)} + \text{antenna gain (dBi)}$ $EIRP=ERP+2.15dB$ where: Pg is the generator output power into the substitution antenna. Test the EUT in the lowest channel, the middle channel the Highest channel The radiation measurements are performed in X, Y, Z axis positioning for EUT operation mode,And found the X axis positioning which it is worse case. Repeat above procedures until all frequencies measured was complete. 																				
Limit:	Attenuated at least $43+10\log(P)$																				

Test data:
Above 1GHz

GPRS 850 128channel/824.2MHz(lowest channel)							
Frequency (MHz)	Height (cm)	Azimuth (deg)	Spurious Emission Level (dBm)	Limit (dBm)	Over Limit (dB)	Result	Antenna Polaxis.
1646.948	150	15	-40.60	-13	-27.60	Pass	H
2468.631	150	200	-40.65	-13	-27.65	Pass	H
4117.785	200	360	-45.46	-13	-32.46	Pass	H
6412.427	150	100	-45.49	-13	-32.49	Pass	H
9465.979	150	214	-44.92	-13	-31.92	Pass	H
11457.210	250	100	-44.28	-13	-31.28	Pass	H
1646.948	150	251	-34.20	-13	-21.20	Pass	V
1899.278	150	200	-38.00	-13	-25.00	Pass	V
2474.923	150	316	-44.07	-13	-31.07	Pass	V
3299.775	100	271	-40.41	-13	-27.41	Pass	V
4117.785	150	100	-47.27	-13	-34.27	Pass	V
6363.645	150	210	-45.25	-13	-32.25	Pass	V

GPRS 850 190channel/836.6MHz(middle channel)							
Frequency (MHz)	Height (cm)	Azimuth (deg)	Spurious Emission Level (dBm)	Limit (dBm)	Over Limit (dB)	Result	Antenna Polaxis.
1672.296	150	355	-37.95	-13	-24.95	Pass	H
2506.624	150	21	-42.94	-13	-29.94	Pass	H
3342.042	250	147	-41.38	-13	-28.38	Pass	H
4181.159	150	200	-42.98	-13	-29.98	Pass	H
6511.117	150	360	-46.05	-13	-33.05	Pass	H
9538.543	200	157	-45.31	-13	-32.31	Pass	H
1672.296	150	100	-32.14	-13	-19.14	Pass	V
2506.624	150	214	-43.12	-13	-30.12	Pass	V
3350.560	200	100	-38.50	-13	-25.50	Pass	V
4181.159	150	251	-45.45	-13	-32.45	Pass	V
6445.156	250	100	-45.09	-13	-32.09	Pass	V
9859.472	150	21	-45.51	-13	-32.51	Pass	V

GPRS 850 251channel/848.8MHz(highest channel)							
Frequency (MHz)	Height (cm)	Azimuth (deg)	Spurious Emission Level (dBm)	Limit (dBm)	Over Limit (dB)	Result	Antenna Polaxis.
1698.033	150	351	-32.68	-13	-19.68	Pass	H
2545.202	150	100	-38.32	-13	-25.32	Pass	H
3393.477	150	24	-41.84	-13	-28.84	Pass	H
5352.186	150	100	-48.74	-13	-35.74	Pass	H
6347.466	250	360	-45.99	-13	-32.99	Pass	H
9298.801	150	78	-45.58	-13	-32.58	Pass	H
1698.033	150	98	-31.96	-13	-18.96	Pass	V
2545.202	150	88	-39.78	-13	-26.78	Pass	V
3393.477	250	100	-42.76	-13	-29.76	Pass	V
4245.509	150	251	-43.06	-13	-30.06	Pass	V
6494.564	100	100	-46.16	-13	-33.16	Pass	V
10087.960	150	21	-45.09	-13	-32.09	Pass	V

GPRS 1900 512channel/1850.2MHz(lowest channel)							
Frequency (MHz)	Height (cm)	Azimuth (deg)	Spurious Emission Level (dBm)	Limit (dBm)	Over Limit (dB)	Result	Antenna Polaxis.
1138.626	150	332	-55.57	-13	-42.57	Pass	H
2898.032	150	161	-52.47	-13	-39.47	Pass	H
3700.260	250	241	-29.28	-13	-16.28	Pass	H
6494.564	150	226	-45.94	-13	-32.94	Pass	H
9275.160	150	100	-45.65	-13	-32.65	Pass	H
12461.220	200	360	-44.20	-13	-31.20	Pass	H
1138.626	150	74	-53.77	-13	-40.77	Pass	V
3700.260	150	89	-30.64	-13	-17.64	Pass	V
5560.500	150	51	-44.41	-13	-31.41	Pass	V
6494.564	200	100	-44.80	-13	-31.80	Pass	V
9538.543	150	245	-45.18	-13	-32.18	Pass	V
11341.140	150	10	-44.77	-13	-31.77	Pass	V

GPRS 1900 661channel/1880MHz(middle channel)							
Frequency (MHz)	Height (cm)	Azimuth (deg)	Spurious Emission Level (dBm)	Limit (dBm)	Over Limit (dB)	Result	Antenna Polaxis.
1138.626	150	55	-54.78	-13	-41.78	Pass	H
2768.242	150	100	-52.51	-13	-39.51	Pass	H
3757.208	250	360	-37.52	-13	-24.52	Pass	H
6299.178	150	100	-45.45	-13	-32.45	Pass	H
9322.501	200	251	-45.23	-13	-32.23	Pass	H
12272.340	150	100	-43.66	-13	-30.66	Pass	H
1257.465	150	246	-54.09	-13	-41.09	Pass	V
3757.208	200	100	-30.50	-13	-17.50	Pass	V
5646.079	150	214	-43.82	-13	-30.82	Pass	V
8571.377	150	79	-45.82	-13	-32.82	Pass	V
10400.860	150	360	-45.04	-13	-32.04	Pass	V
12303.620	150	210	-43.92	-13	-30.92	Pass	V

GPRS 1900 810channel/1909.8MHz(highest channel)							
Frequency (MHz)	Height (cm)	Azimuth (deg)	Spurious Emission Level (dBm)	Limit (dBm)	Over Limit (dB)	Result	Antenna Polaxis.
1138.626	150	100	-53.28	-13	-40.28	Pass	H
1378.143	150	47	-55.66	-13	-42.66	Pass	H
3824.757	150	214	-35.81	-13	-22.81	Pass	H
5732.974	150	360	-45.14	-13	-32.14	Pass	H
8002.061	200	255	-46.27	-13	-33.27	Pass	H
11370.050	150	179	-44.41	-13	-31.41	Pass	H
1257.465	150	98	-54.73	-13	-41.73	Pass	V
2935.153	200	125	-52.43	-13	-39.43	Pass	V
3824.757	150	100	-32.37	-13	-19.37	Pass	V
6047.776	150	254	-46.62	-13	-33.62	Pass	V
9204.600	250	100	-45.31	-13	-32.31	Pass	V
11197.710	150	25	-44.60	-13	-31.60	Pass	V

Note:

1) Scan from 9kHz to 25GHz, the disturbance above 13GHz and below 1GHz was very low, and the above harmonics were the highest point could be found when testing, so only the above harmonics had been displayed. The amplitude of spurious emissions from the radiator which are attenuated more than 20dB below the limit need not be reported.

PHOTOGRAPHS OF TEST SETUP

Test mode No.: WisePad 2

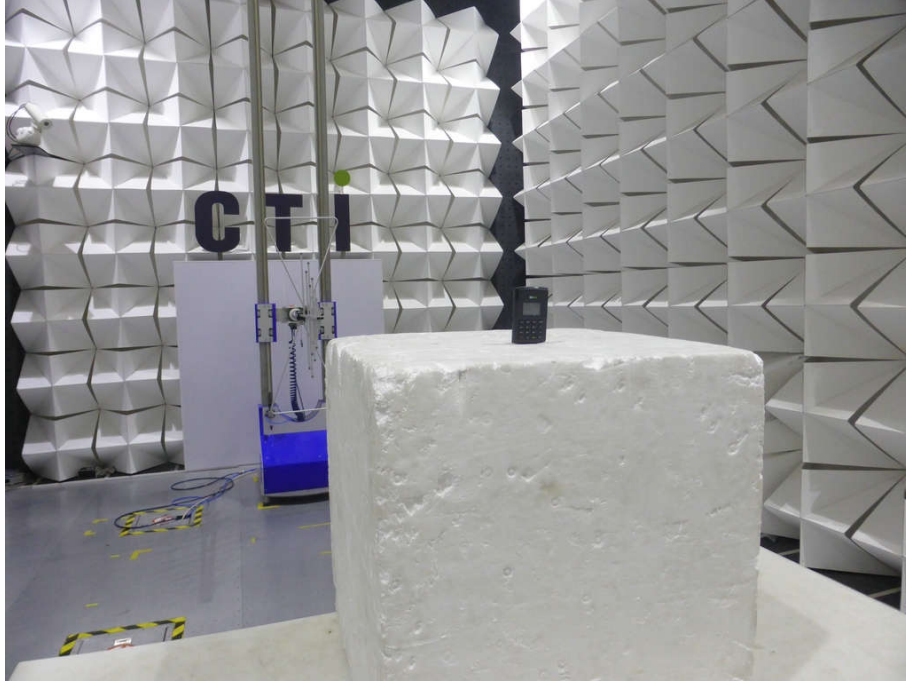

Radiated spurious emission Test Setup-1(Below 1GHz)

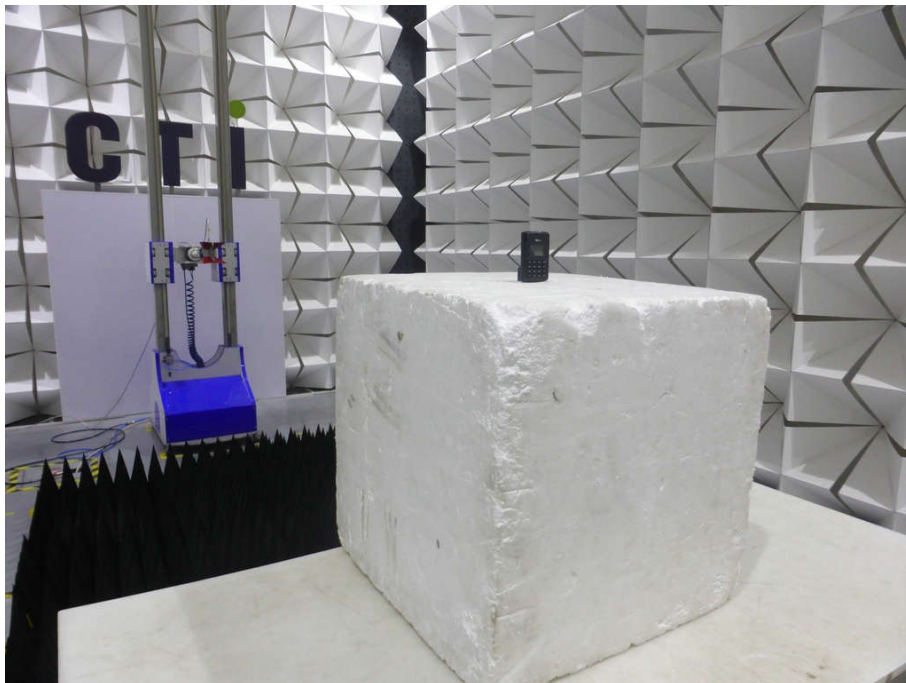

Radiated spurious emission Test Setup-2(Above 1GHz)

PHOTOGRAPHS OF EUT Constructional Details

Test mode No.: WisePad 2



View of Product-1



View of Product-2

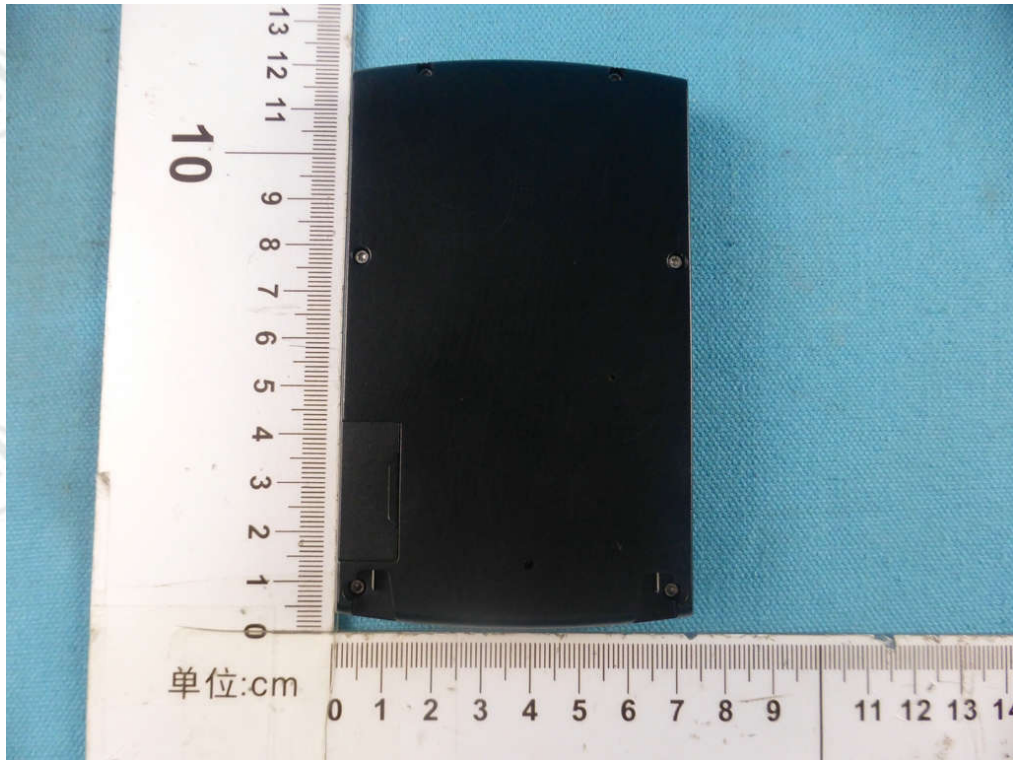

View of Product-3



View of Product-4



View of Product-5



View of Product-6



View of Product-7



View of Product-8



View of Product-9

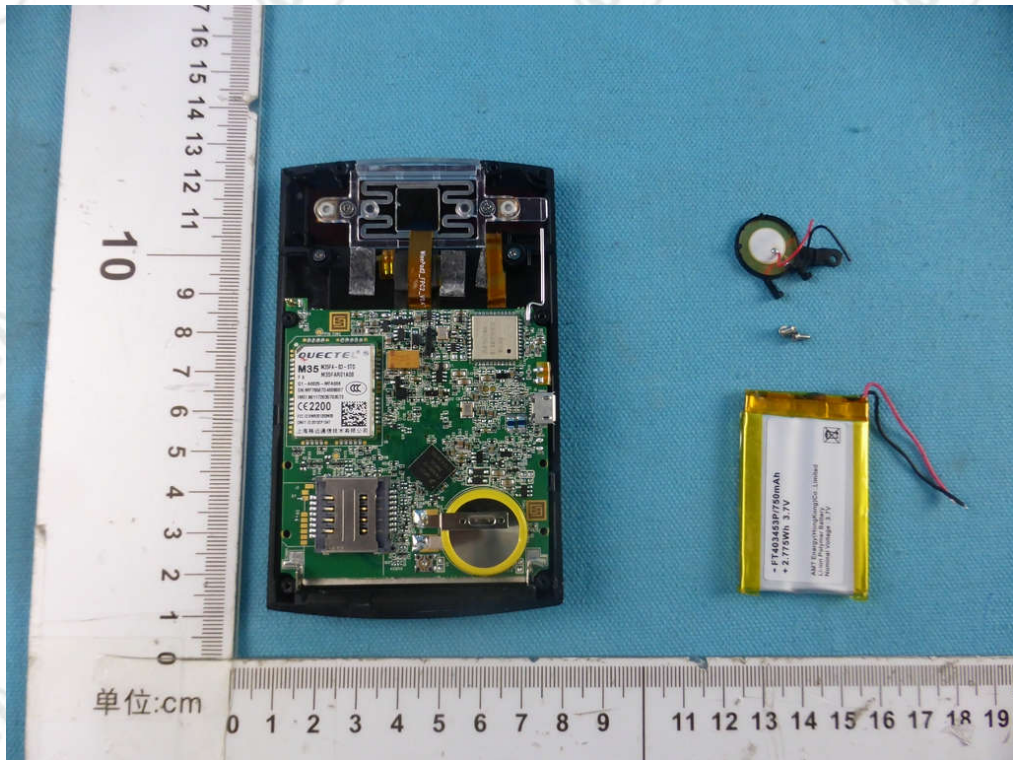

View of Product-10

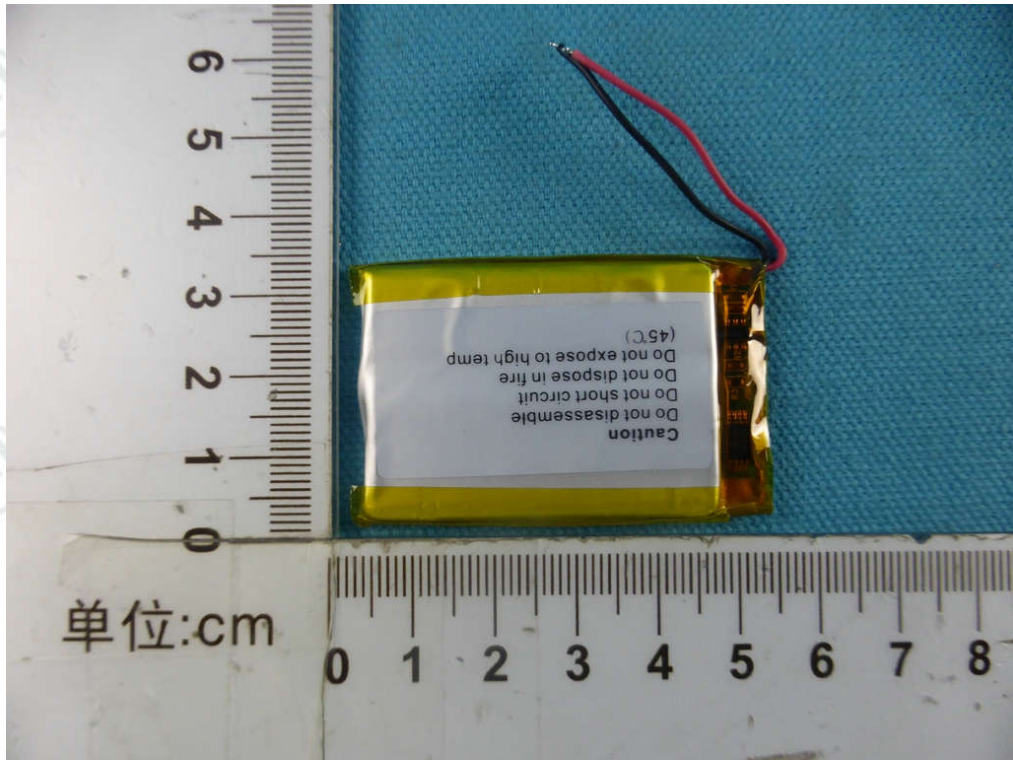

View of Product-11

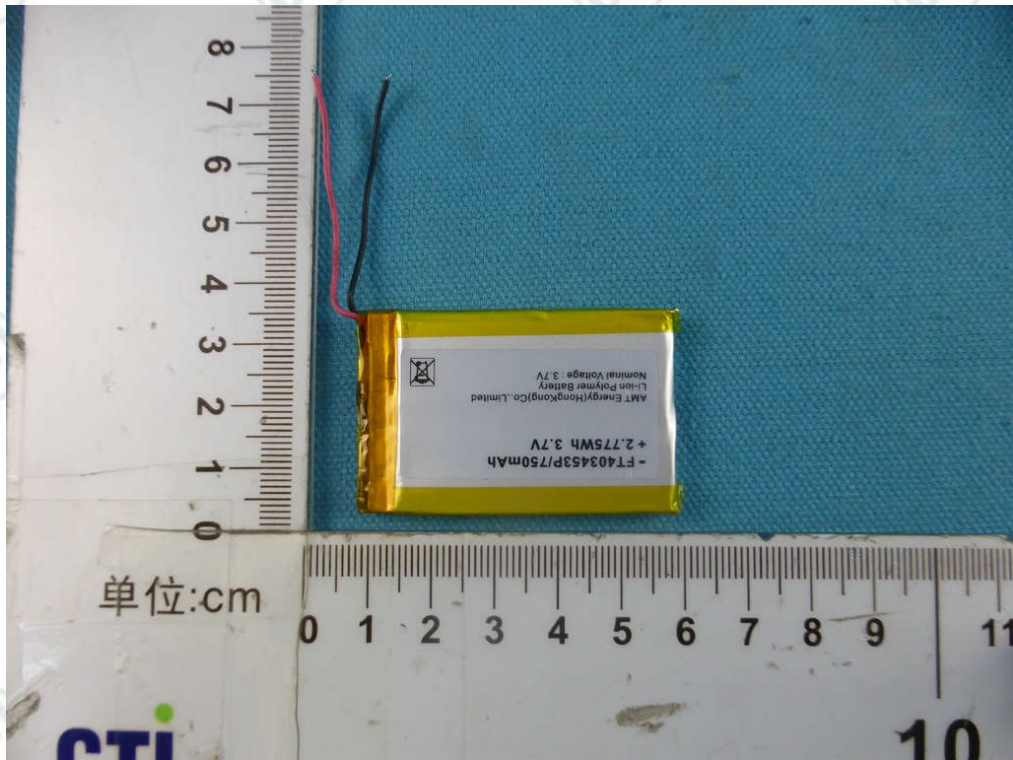

View of Product-12

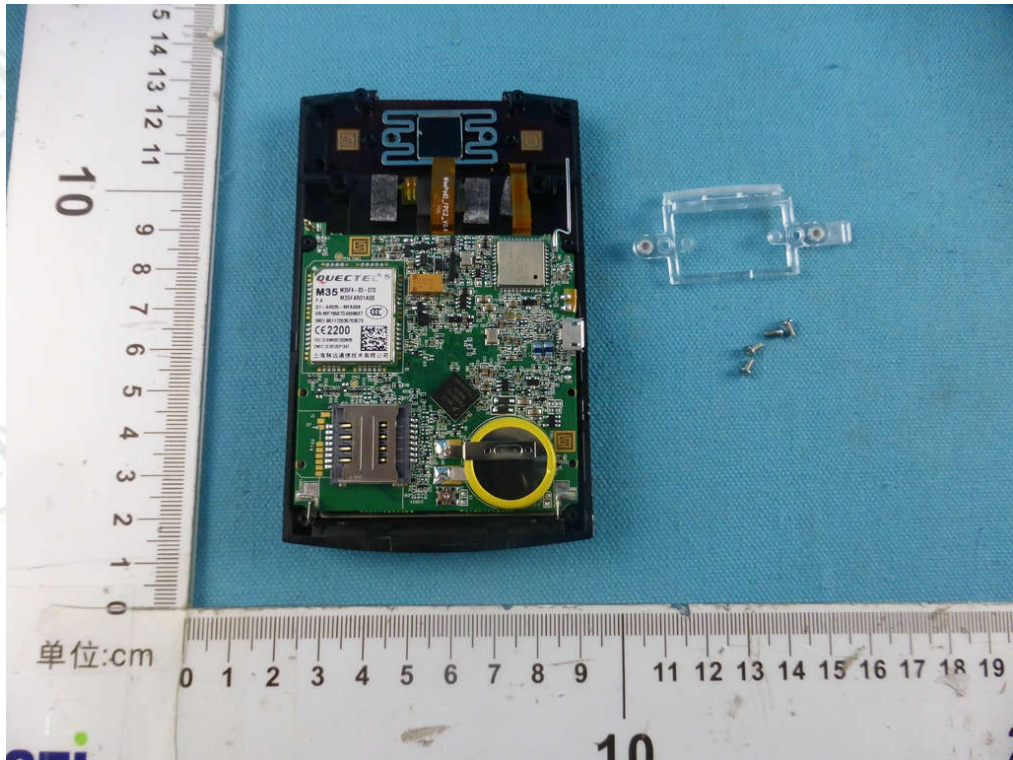

View of Product-13

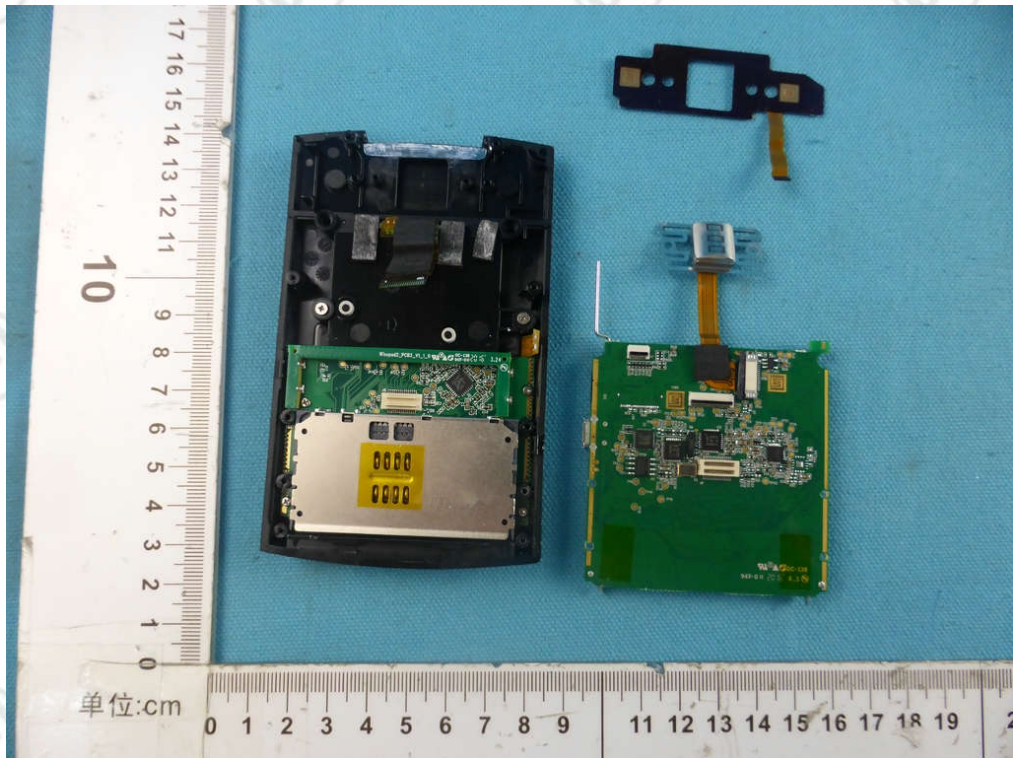

View of Product-14

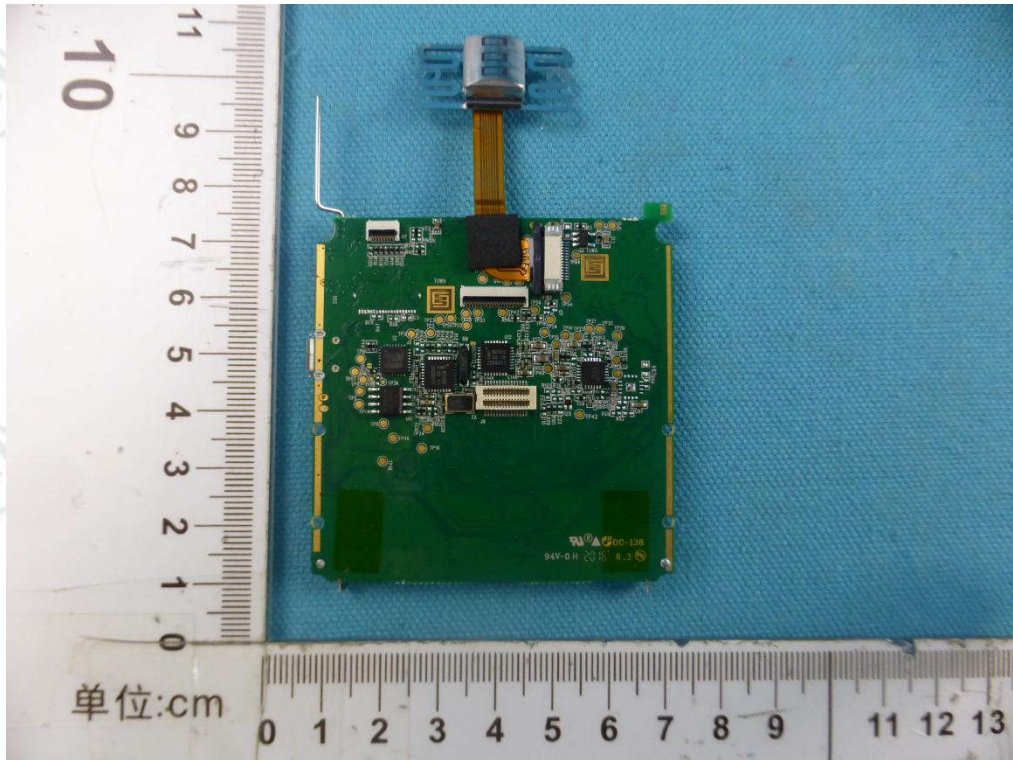

View of Product-15

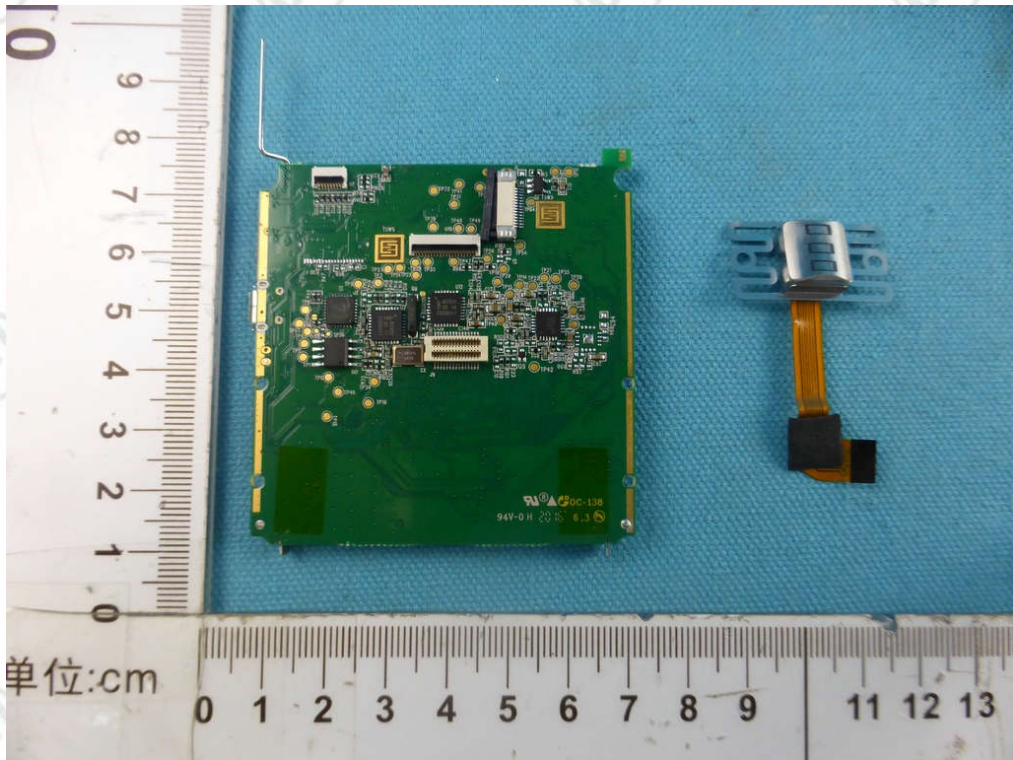

View of Product-16

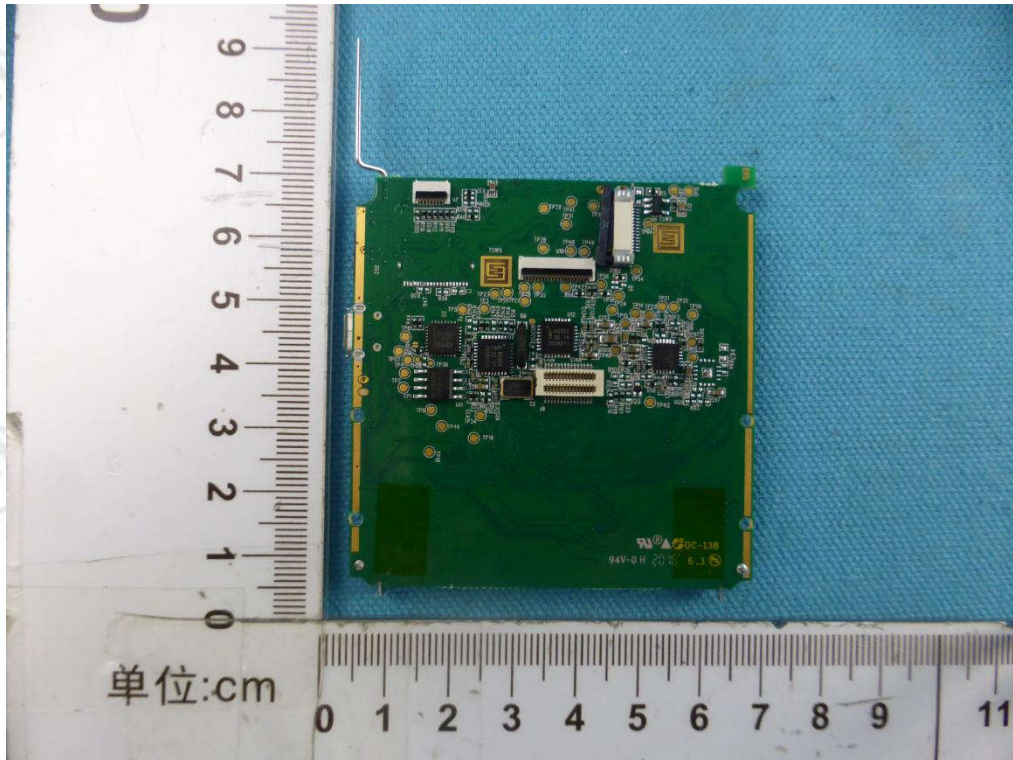

View of Product-17

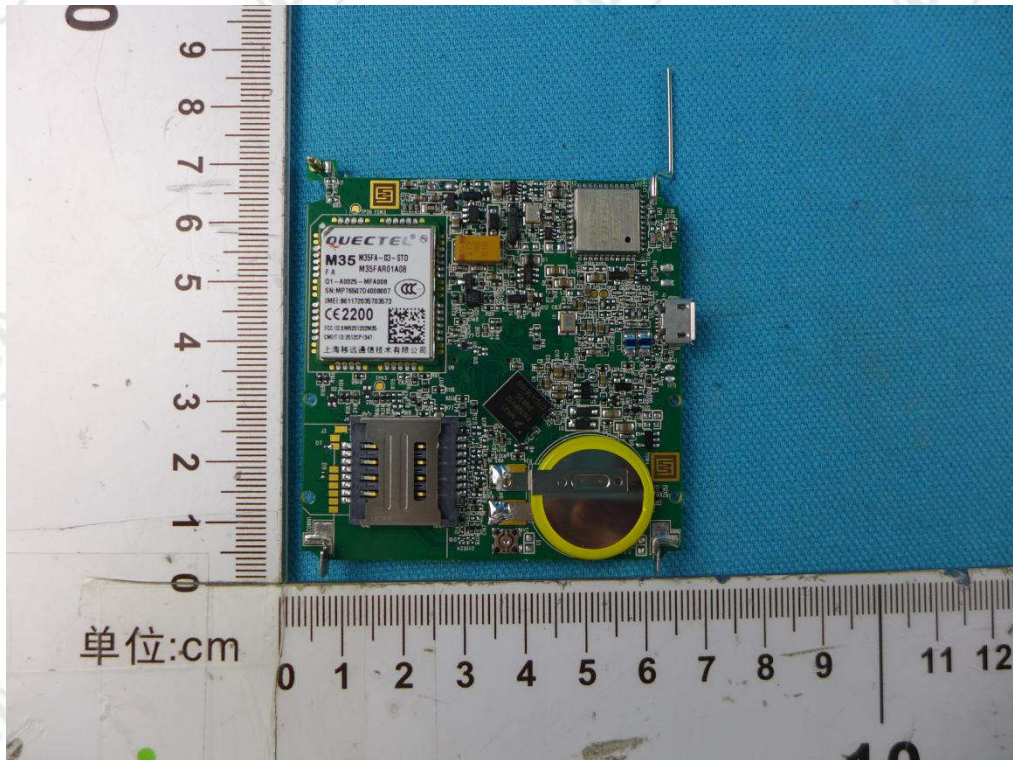

View of Product-18

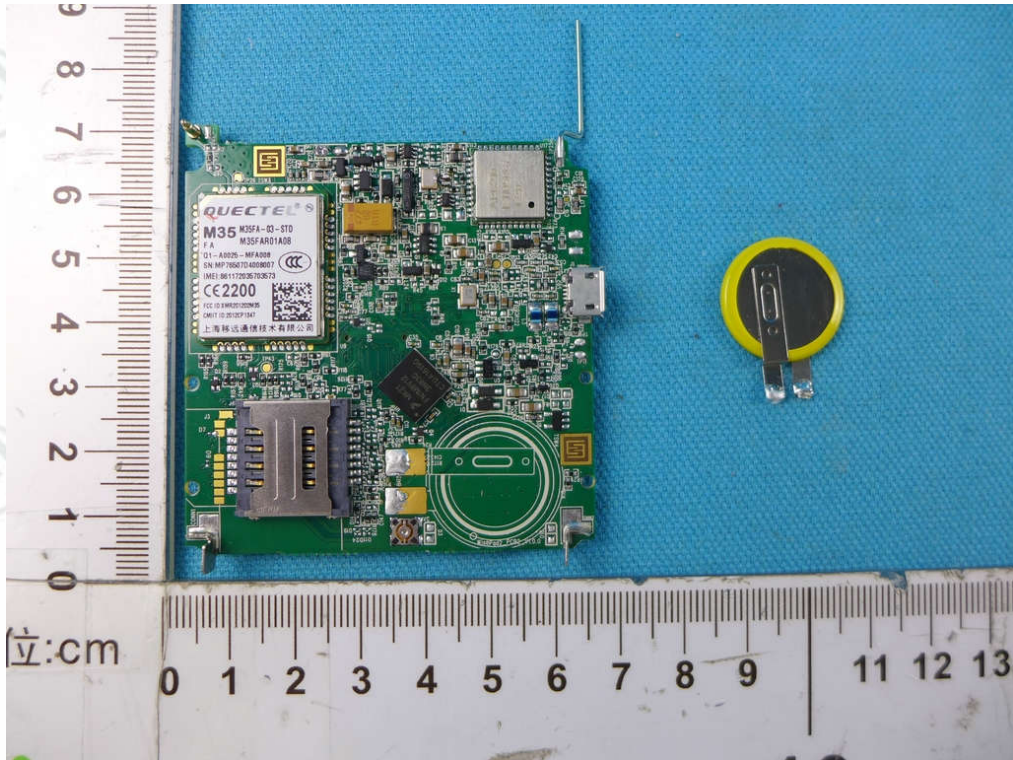

View of Product-19

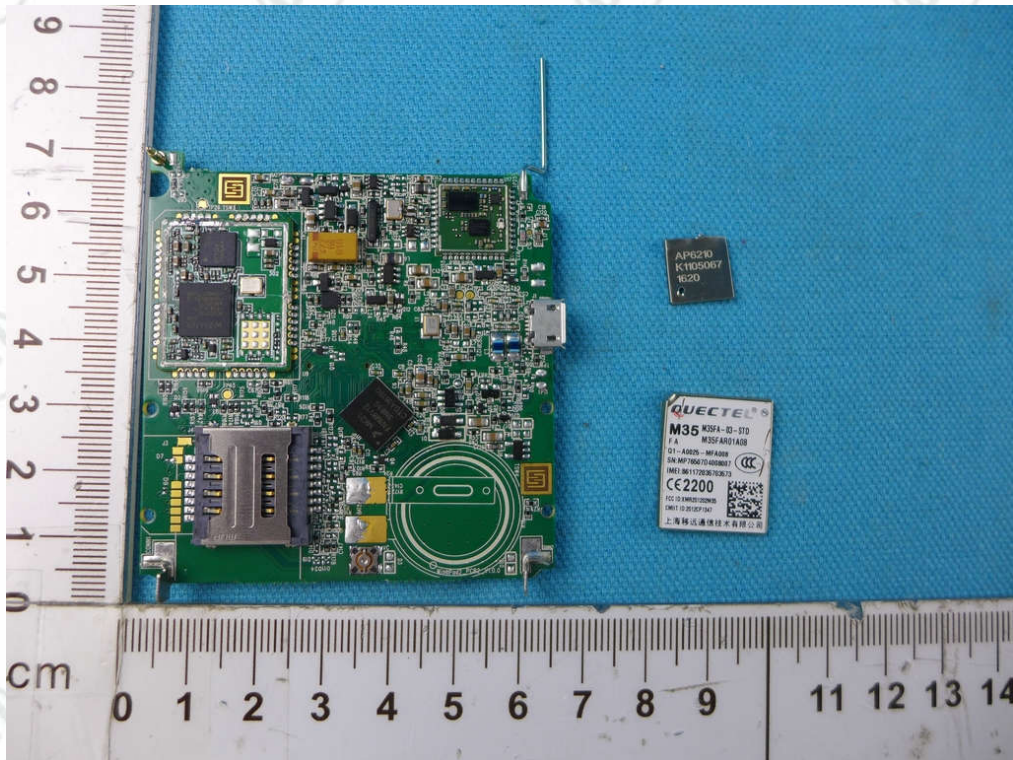

View of Product-20

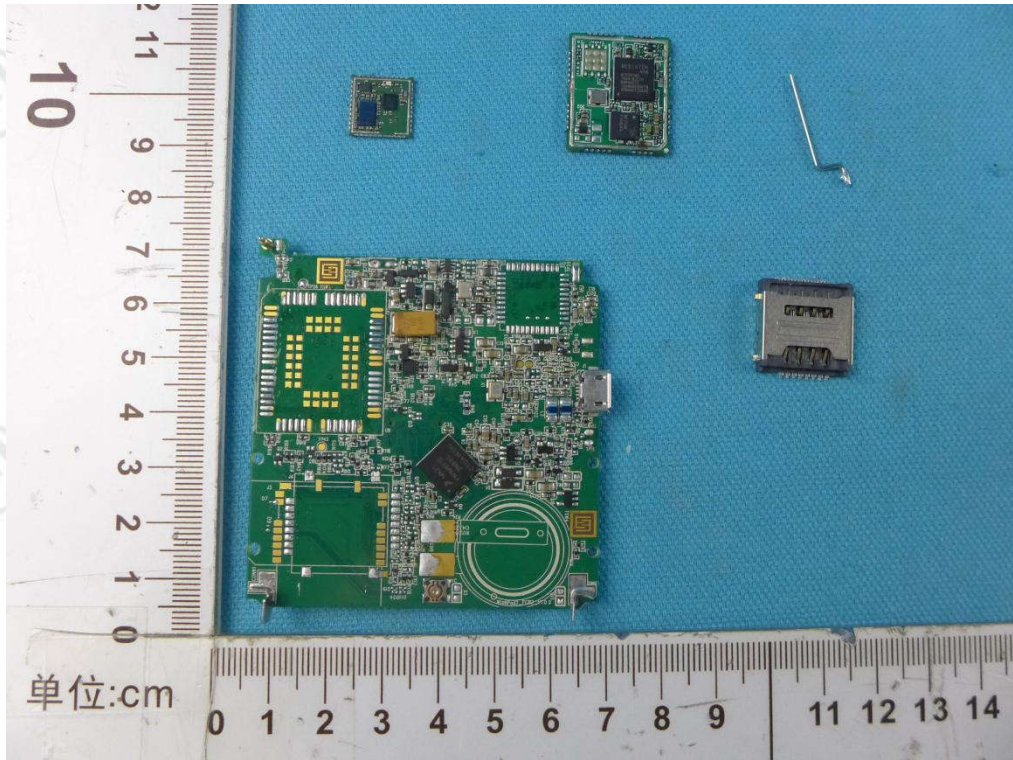

View of Product-21

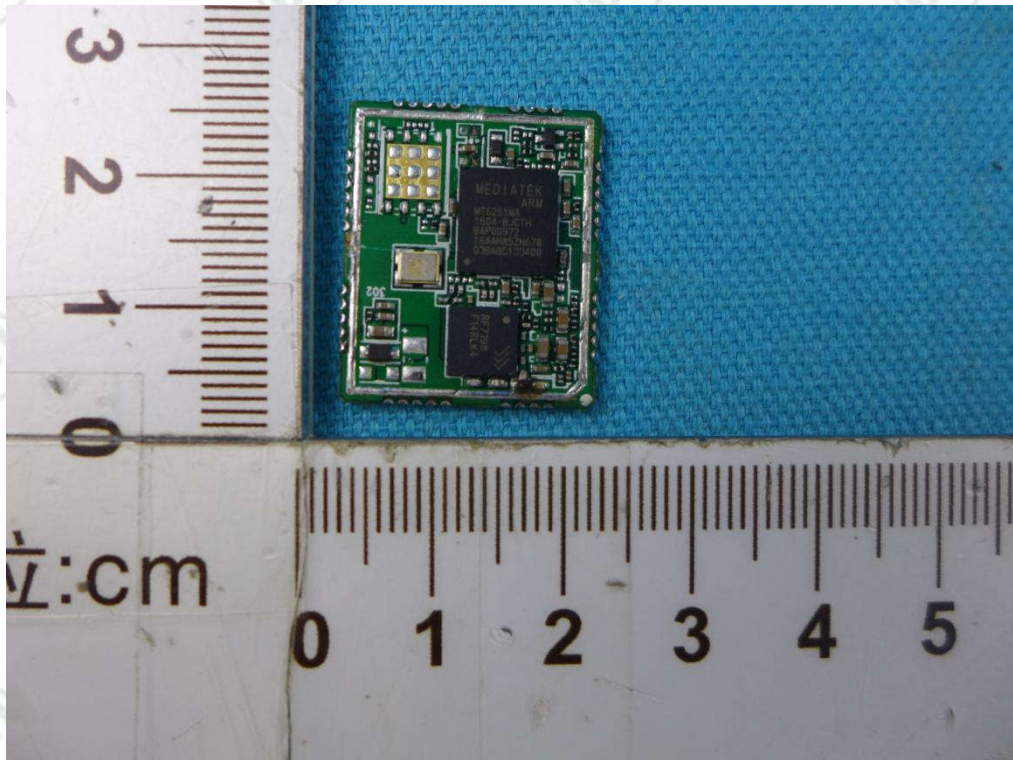

View of Product-22

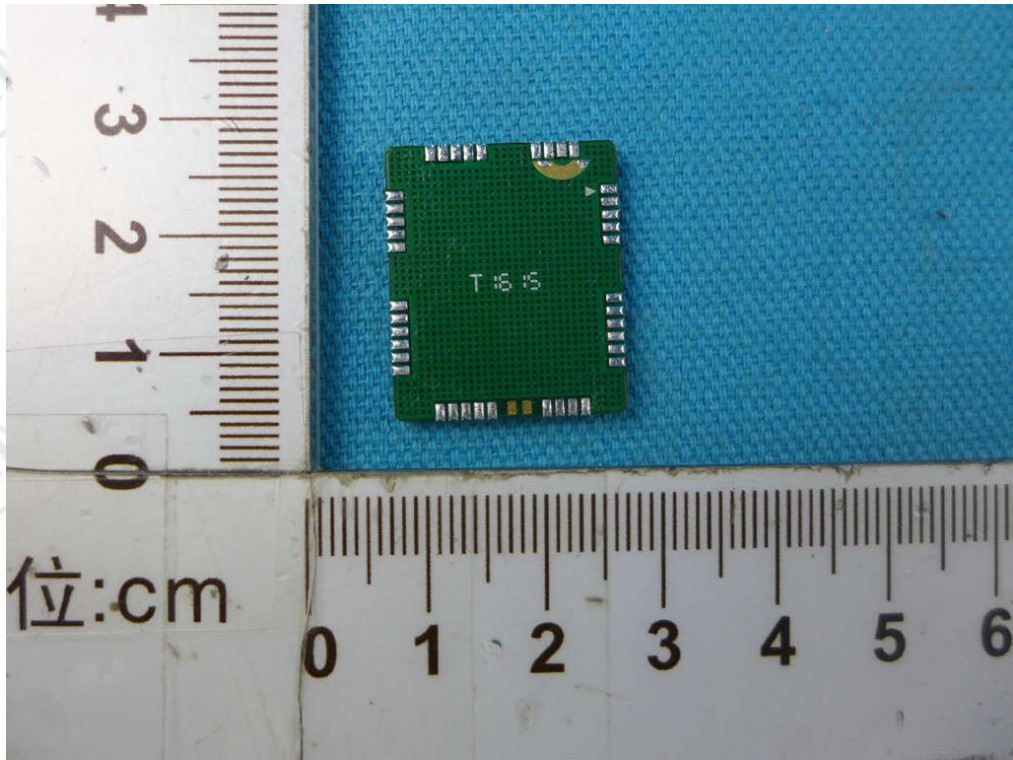

View of Product-23

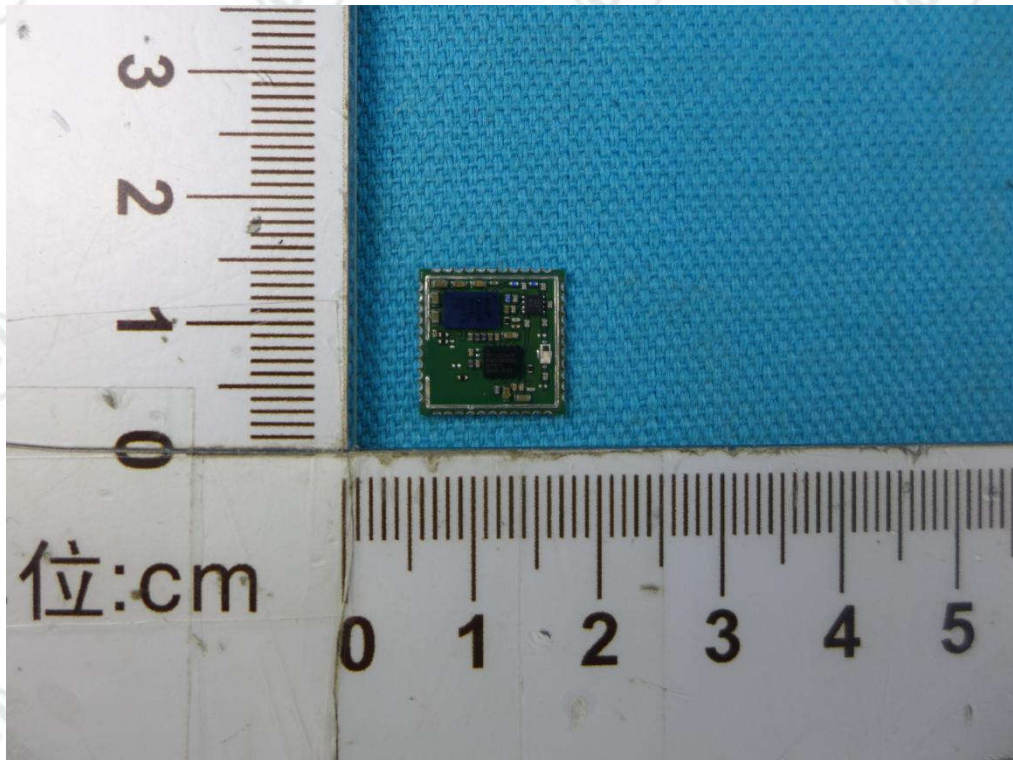

View of Product-24

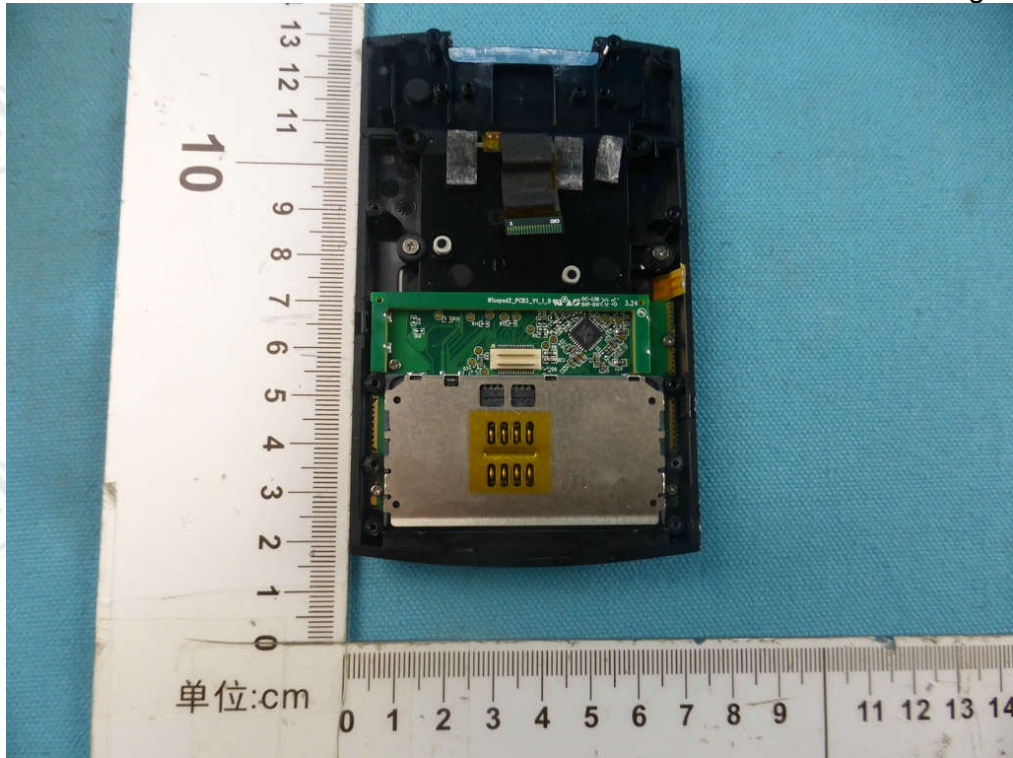

View of Product-25

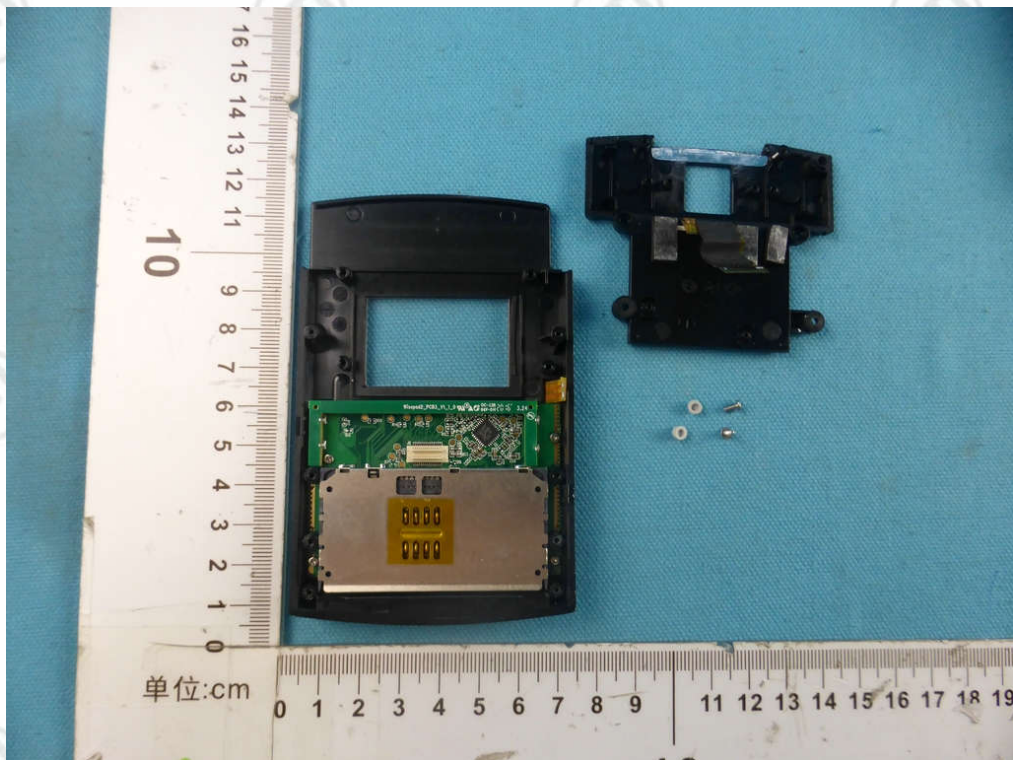

View of Product-26

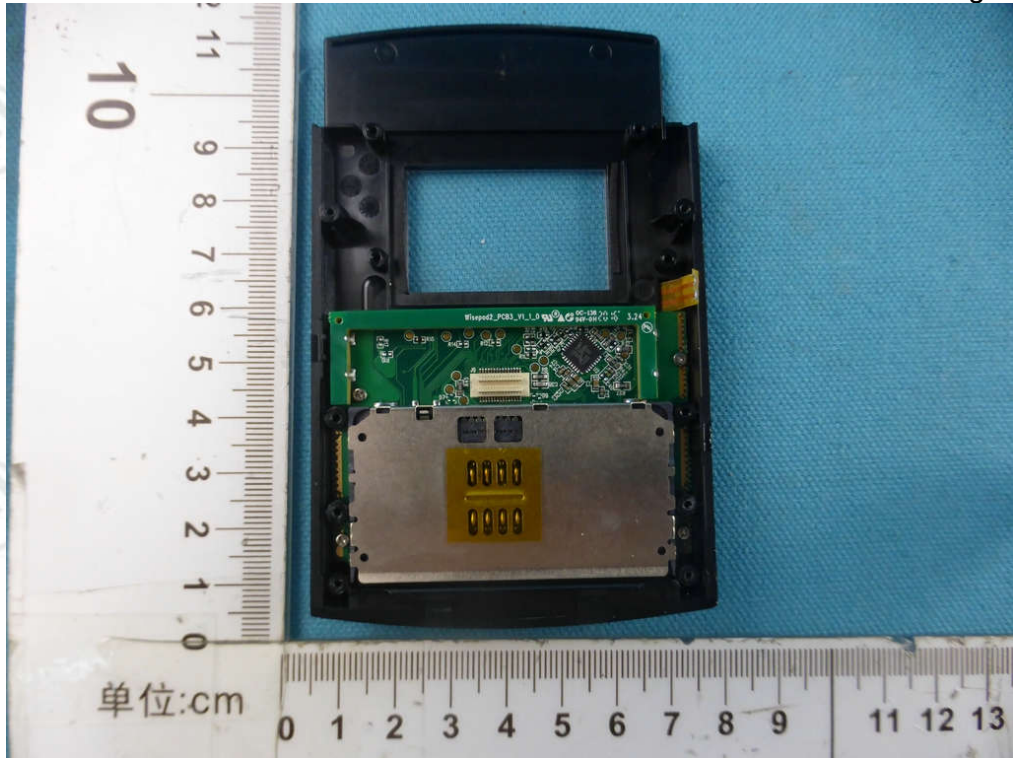

View of Product-27



View of Product-28

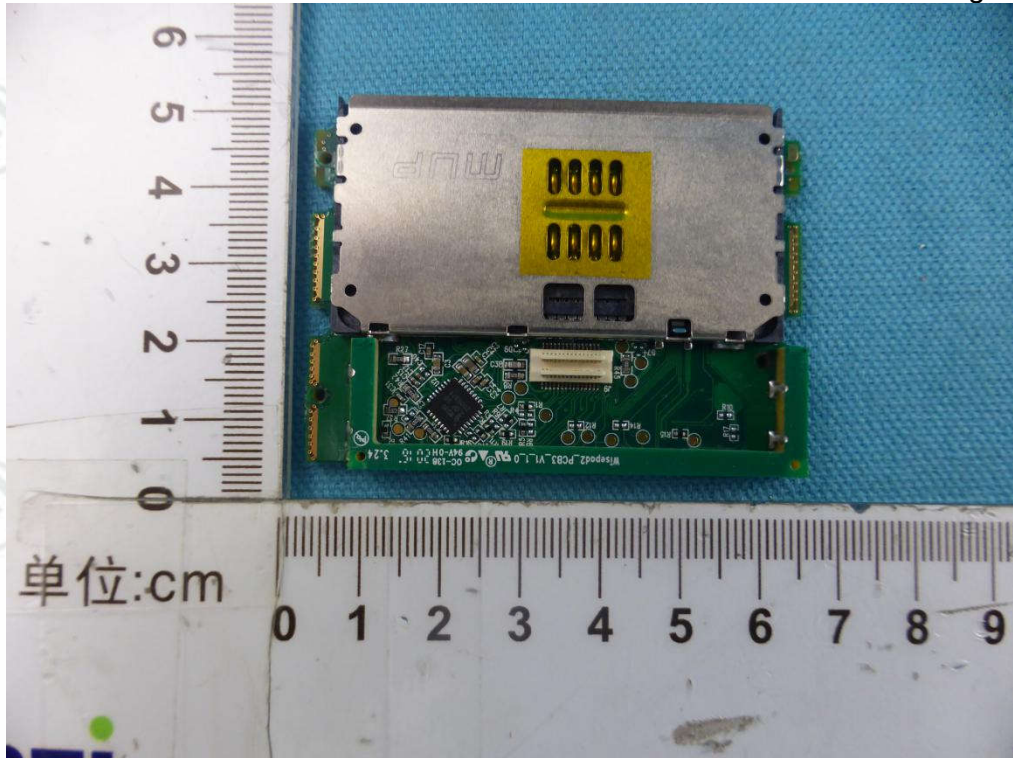

View of Product-29

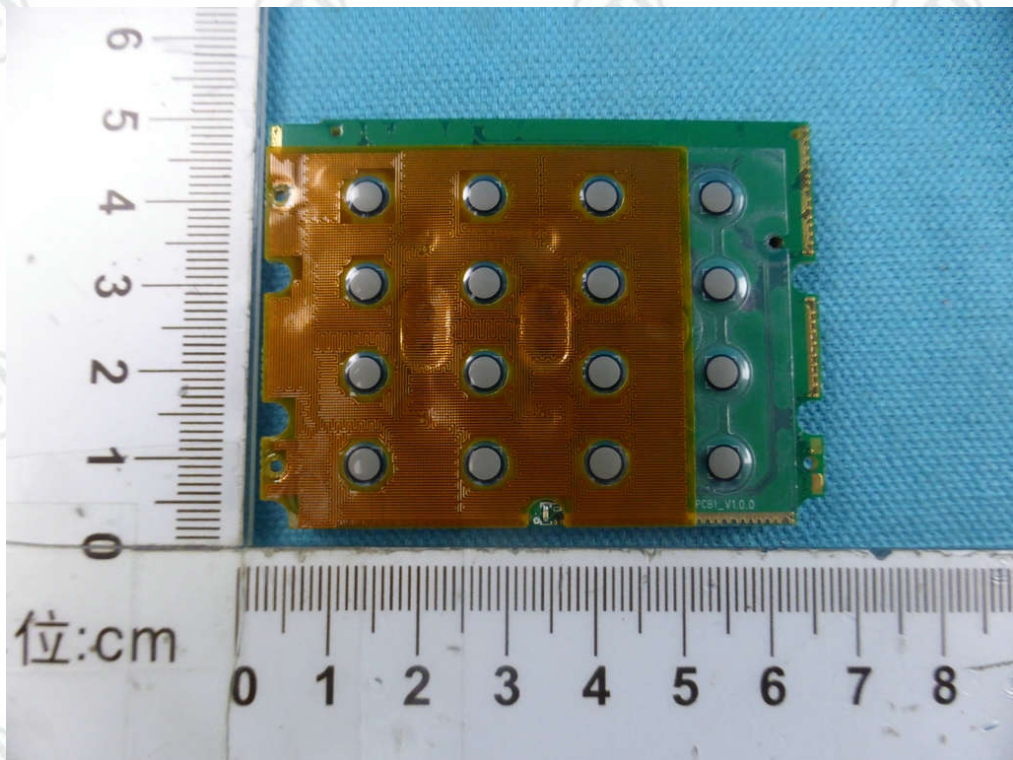

View of Product-30

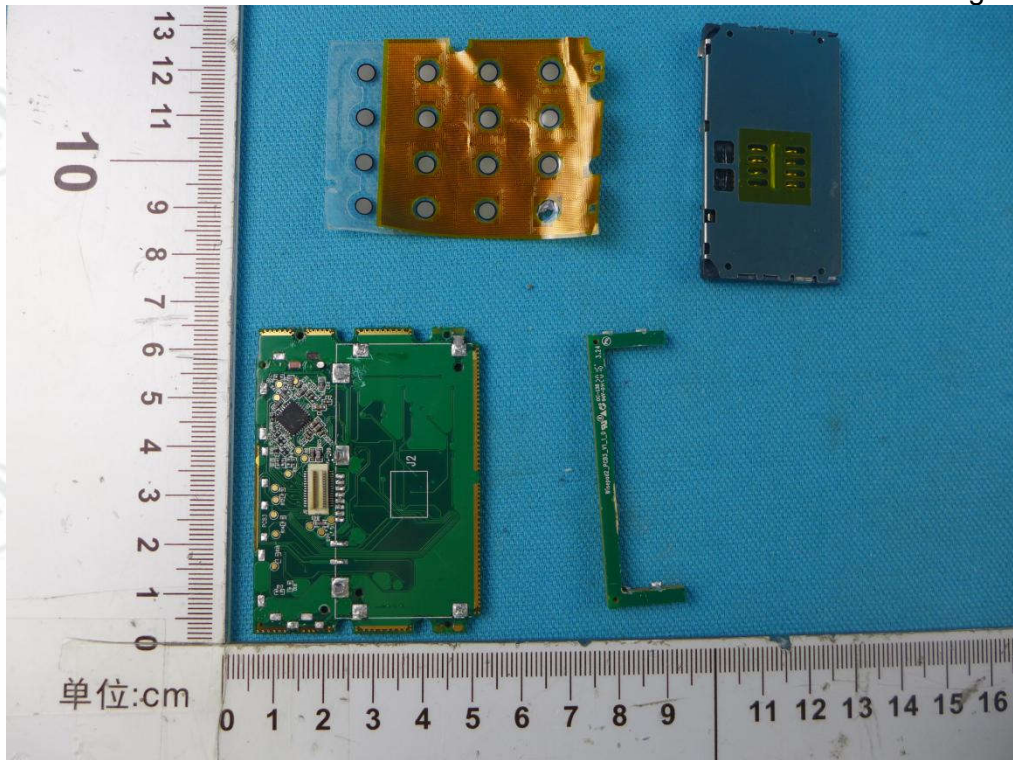

View of Product-31

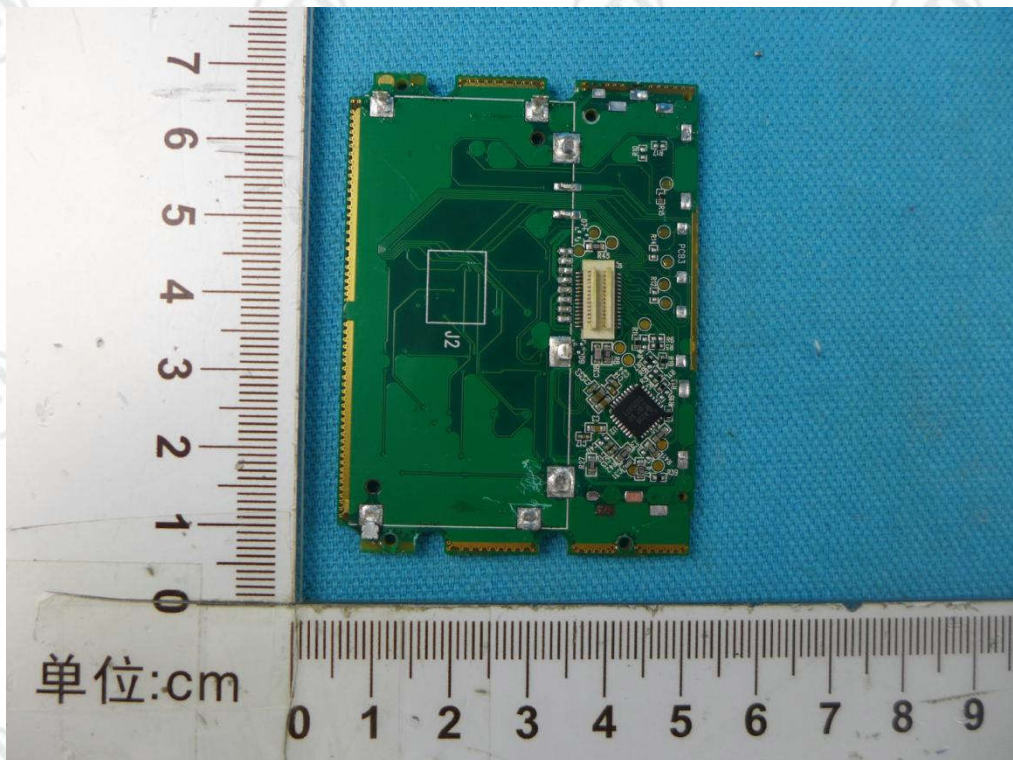

View of Product-32

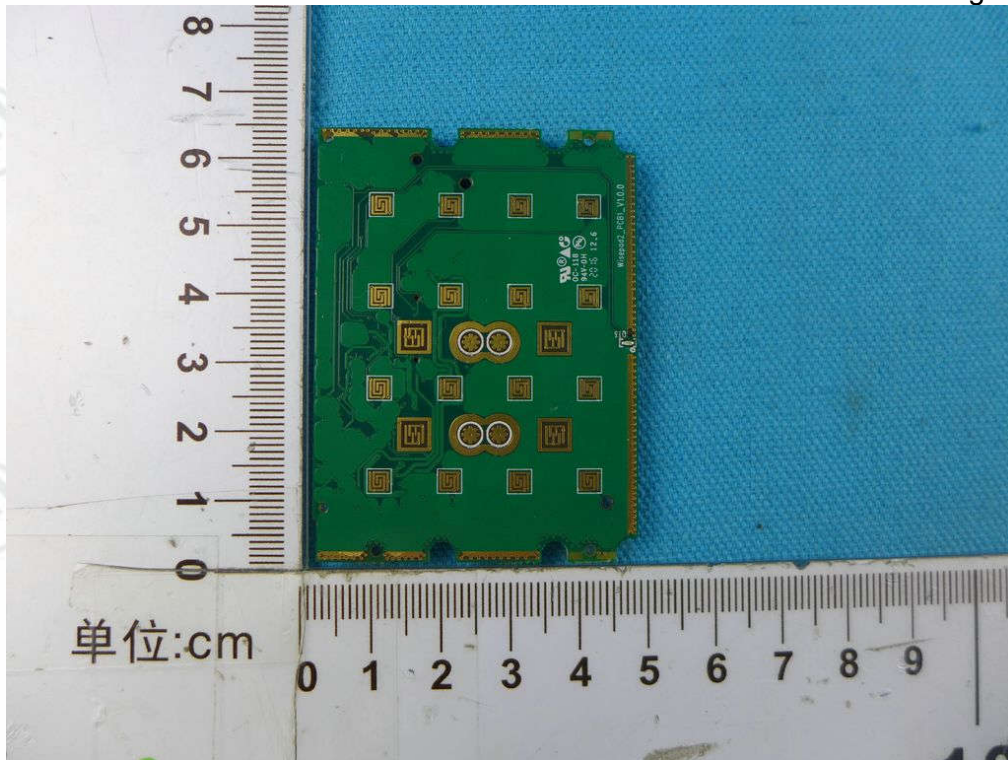

View of Product-33

*** End of Report ***

The test report is effective only with both signature and specialized stamp, The result(s) shown in this report refer only to the sample(s) tested. Without written approval of CTI, this report can't be reproduced except in full.