



**FCC 47 CFR PART 15 SUBPART C  
ISED RSS-210 ISSUE 10**

**CERTIFICATION TEST REPORT**

*For*

**WiseCube**

**MODEL NUMBER: CHB63**

**FCC ID: 2AB7X-WISECUBE2**

**IC: 24228-WISECUBE2**

**REPORT NUMBER: 4789585111.1-1**

**ISSUE DATE: September 11, 2020**

*Prepared for*

**BBPOS International Limited  
Suite 1903-04, Tower 2, Nina Tower, 8 Yeung Uk Road, Tsuen Wan, NT, Hong  
Kong**

*Prepared by*

**UL Verification Services (Guangzhou) Co., Ltd, Song Shan Lake Branch  
Building 10, Innovation Technology Park, No. 1, Li Bin Road, Song Shan Lake Hi-  
Tech Development Zone Dongguan, 523808, People's Republic of China**

**Tel: +86 769 22038881**

**Fax: +86 769 33244054**

**Website: [www.ul.com](http://www.ul.com)**



Revision History

<u>Rev.</u>	<u>Issue Date</u>	<u>Revisions</u>	<u>Revised By</u>
V0	09/11/2020	Initial Issue	



Summary of Test Results			
Clause	Test Items	FCC Rules	Test Results
1	Transmitter 99% Emission Bandwidth / 20dB Bandwidth	RSS-Gen 6.7/ Part 15.215 (c)	PASS
2	Transmitter Frequency Stability (Temperature & Voltage Variation)	CFR 47 FCC §15.225(e) ISED RSS-Gen Clause 6.11 ISED RSS-210 Annex B.6	PASS
3	Fundamental Field Strength	CFR 47 FCC §5.225(a)(b)(c)(d) ISED RSS-Gen Clause 6.12 ISED RSS-210 Annex B.6	PASS
4	Radiated Emissions	CFR 47 FCC§15.209(a) CFR 47 FCC§15.225(d) ISED RSS-Gen Clause 6.13 ISED RSS-210 Annex B.6	PASS
5	Band Edge Radiated Emissions	CFR 47 FCC §15.209(a) CFR 47 FCC §15.225(c)(d) ISED RSS-Gen Clause 6.13 ISED RSS-210 Annex B.6	PASS
6	Conducted Emission Test for AC Power Port	CFR 47 FCC §15.207 ISED RSS-Gen Clause 8.8	PASS
7	Antenna Requirement	CFR 47 FCC §15.203 ISED RSS-Gen Clause 6.3	Pass
<p style="text-align: center;">Note:</p> <p>1. This test report is only published to and used by the applicant, and it is not for evidence purpose in China.</p> <p>2. The measurement result for the sample received is &lt;Pass&gt; according to &lt; CFR 47 FCC PART 15 SUBPART C &gt;&lt; ISED RSS-210 &gt; when &lt;Accuracy Method&gt; decision rule is applied.</p>			



## TABLE OF CONTENTS

<b>1. ATTESTATION OF TEST RESULTS .....</b>	<b>5</b>
<b>2. TEST METHODOLOGY .....</b>	<b>6</b>
<b>3. FACILITIES AND ACCREDITATION .....</b>	<b>6</b>
<b>4. CALIBRATION AND UNCERTAINTY .....</b>	<b>7</b>
4.1. <i>MEASURING INSTRUMENT CALIBRATION .....</i>	<i>7</i>
4.2. <i>MEASUREMENT UNCERTAINTY.....</i>	<i>7</i>
<b>5. EQUIPMENT UNDER TEST .....</b>	<b>8</b>
5.1. <i>DESCRIPTION OF EUT .....</i>	<i>8</i>
5.2. <i>MAXIMUM FIELD STRENGTH.....</i>	<i>8</i>
5.3. <i>DESCRIPTION OF AVAILABLE ANTENNAS .....</i>	<i>8</i>
5.4. <i>TEST ENVIRONMENT .....</i>	<i>9</i>
5.5. <i>DESCRIPTION OF TEST SETUP.....</i>	<i>10</i>
5.6. <i>MEASURING INSTRUMENT AND SOFTWARE USED.....</i>	<i>11</i>
<b>6. ANTENNA PORT TEST RESULTS .....</b>	<b>12</b>
6.1. <i>99% &amp; 20dB BANDWIDTH .....</i>	<i>12</i>
6.2. <i>TRANSMITTER FREQUENCY STABILITY.....</i>	<i>14</i>
<b>7. RADIATED EMISSION TEST RESULTS.....</b>	<b>16</b>
7.1. <i>FIELD STRENGTH OF INTENTIONAL EMISSIONS .....</i>	<i>23</i>
7.2. <i>SPURIOUS EMISSIONS BELOW 1GHz AND ABOVE 30MHz.....</i>	<i>24</i>
7.3. <i>SPURIOUS EMISSIONS BELOW 30MHz .....</i>	<i>26</i>
<b>8. AC POWER LINE CONDUCTED EMISSIONS .....</b>	<b>29</b>
<b>9. ANTENNA REQUIREMENTS.....</b>	<b>35</b>



# 1. ATTESTATION OF TEST RESULTS

## Applicant Information

Company Name: BBPOS International Limited  
Address: Suite 1903-04, Tower 2, Nina Tower, 8 Yeung Uk Road, Tsuen Wan, NT, Hong Kong

## Manufacturer Information

Company Name: BBPOS International Limited  
Address: Suite 1903-04, Tower 2, Nina Tower, 8 Yeung Uk Road, Tsuen Wan, NT, Hong Kong

## EUT Description

Product Name: WiseCube  
Model Name: CHB63  
Brand: BBPOS  
Sample Status: Normal  
Sample ID: 3241806  
Sample Received date: August 10, 2020  
Date Tested: August 10 ~ September 11, 2020

APPLICABLE STANDARDS	
STANDARD	TEST RESULTS
CFR 47 FCC PART 15 SUBPART C	PASS
ISED RSS-210 Issue 10	PASS
ISED RSS-GEN Issue 5	PASS

Prepared By:

Checked By:

Kebo Zhang  
Project Engineer

Shawn Wen  
Laboratory Leader

Approved By:

Stephen Guo  
Laboratory Manager



## 2. TEST METHODOLOGY

The tests documented in this report were performed in accordance with KDB 414788 D01 Radiated Test Site v01r01, FCC CFR 47 Part 2, FCC CFR 47 Part 15, ANSI C63.10-2013, ISED RSS-210 Issue 10 and RSS-GEN Issue 5.

## 3. FACILITIES AND ACCREDITATION

Accreditation Certificate	<p><b>A2LA (Certificate No.: 4102.01)</b> UL Verification Services (Guangzhou) Co., Ltd. Song Shan Lake Branch. has been assessed and proved to be in compliance with A2LA.</p> <p><b>FCC (FCC Designation No.: CN1187)</b> UL Verification Services (Guangzhou) Co., Ltd. Song Shan Lake Branch. Has been recognized to perform compliance testing on equipment subject to the Commission's Declaration of Conformity (DoC) and Certification rules.</p> <p><b>ISED (Company No.: 21320)</b> UL Verification Services (Guangzhou) Co., Ltd. Song Shan Lake Branch. has been registered and fully described in a report filed with ISED. The Company Number is 21320.</p> <p><b>VCCI (Registration No.: G-20019, R-20004, C-20012 and T-20011)</b> UL Verification Services (Guangzhou) Co., Ltd. Song Shan Lake Branch. has been assessed and proved to be in compliance with VCCI, the Membership No. is 3793. Facility Name: Chamber D, the VCCI registration No. is G-20019 and R-20004 Shielding Room B , the VCCI registration No. is C-20012 and T-20011</p>
---------------------------	---

Note:

1. All tests measurement facilities use to collect the measurement data are located at Building 10, Innovation Technology Park, Song Shan Lake Hi tech Development Zone, Dongguan, 523808, China
2. The test anechoic chamber in UL Verification Services (Guangzhou) Co., Ltd. Song Shan Lake Branch had been calibrated and compared to the open field sites and the test anechoic chamber is shown to be equivalent to or worst case from the open field site.
3. For below 30MHz, lab had performed measurements at test anechoic chamber and comparing to measurements obtained on an open field site. And these measurements below 30MHz had been correlated to measurements performed on an OFS.



## 4. CALIBRATION AND UNCERTAINTY

### 4.1. MEASURING INSTRUMENT CALIBRATION

The measuring equipment utilized to perform the tests documented in this report has been calibrated in accordance with the manufacturer's recommendations and is traceable to recognize national standards.

### 4.2. MEASUREMENT UNCERTAINTY

Where relevant, the following measurement uncertainty levels have been estimated for tests performed on the apparatus:

Test Item	Uncertainty
Conduction emission	3.62 dB
Radiation Emission test (include Fundamental emission) (9 kHz -30 MHz)	2.2 dB
Radiation Emission test (include Fundamental emission) (30 MHz - 1 GHz)	4.00 dB
Radiation Emission test (1 GHz to 26 GHz) (include Fundamental emission)	5.78 dB (1 GHz - 18 GHz)
	5.23 dB (18 GHz - 26 GHz)
Note: This uncertainty represents an expanded uncertainty expressed at approximately the 95 % confidence level using a coverage factor of k=2.	



## 5. EQUIPMENT UNDER TEST

### 5.1. DESCRIPTION OF EUT

Product Name	WiseCube	
Model	CHB63	
Product Description	Operation Frequency	13.56 MHz
Modulation	ASK	
Power Supply	DC 3.7 V	

### 5.2. MAXIMUM FIELD STRENGTH

Frequency (MHz)	Max Peak field strength (dB $\mu$ V/m)
13.56	47.23

### 5.3. DESCRIPTION OF AVAILABLE ANTENNAS

Frequency (MHz)	Antenna Type	Antenna Gain (dBi)
13.56	PCB Trace Antenna	0





#### 5.4. TEST ENVIRONMENT

Environment Parameter	Selected Values During Tests	
Relative Humidity	55 ~ 65%	
Atmospheric Pressure:	1025Pa	
Temperature	TN	23 ~ 28°C
Voltage:	VL	DC 3.33V
	VN	DC 3.7V
	VH	DC 4.07

Note: VL= Lower Extreme Test Voltage  
VN= Nominal Voltage  
VH= Upper Extreme Test Voltage  
TN= Normal Temperature

## 5.5. DESCRIPTION OF TEST SETUP

### SUPPORT EQUIPMENT

Item	Equipment	Brand Name	Model Name	P/N
1	Laptop	ThinkPad	T460S	SL10K24796 JS

### I/O PORT

Cable No	Port	Connector Type	Cable Type	Cable Length(m)	Remarks
1	USB	Type C	/	1.2 m	/

### ACCESSORY

Item	Accessory	Brand Name	Model Name	Description
1	/	/	/	/

### TEST SETUP

The EUT can work in an engineering mode.  
New battery has been used during measurement

### SETUP DIAGRAM FOR TESTS

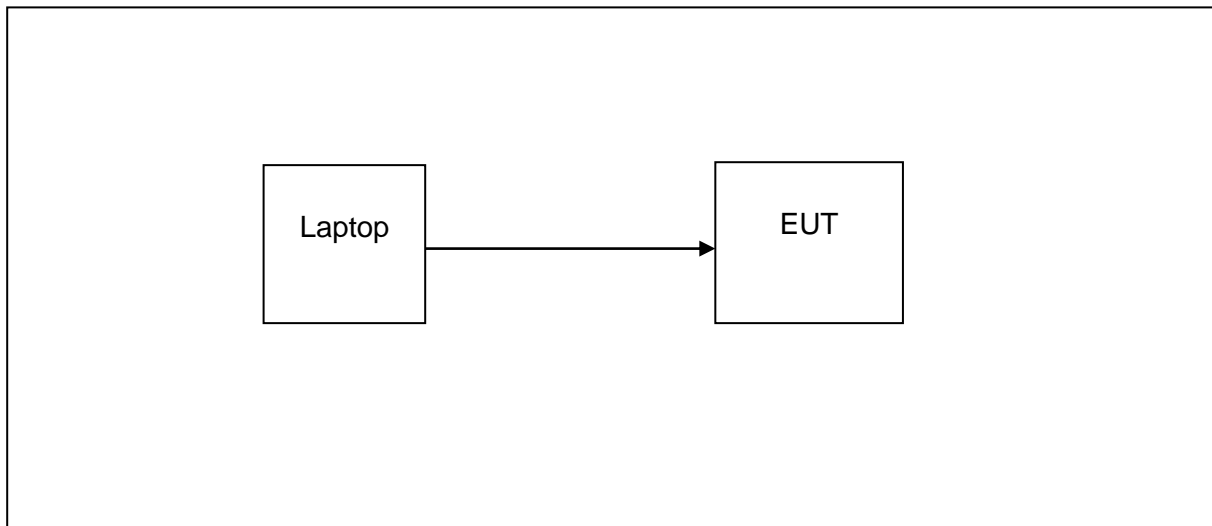

**5.6. MEASURING INSTRUMENT AND SOFTWARE USED**

<b>Conducted Emissions</b>						
Instrument						
Used	Equipment	Manufacturer	Model No.	Serial No.	Last Cal.	Next Cal.
<input checked="" type="checkbox"/>	EMI Test Receiver	R&S	ESR3	101961	Dec. 5, 2019	Dec. 5, 2020
<input checked="" type="checkbox"/>	Two-Line V- Network	R&S	ENV216	101983	Dec. 5, 2019	Dec. 5, 2020
Software						
Used	Description	Manufacturer	Name	Version		
<input checked="" type="checkbox"/>	Test Software for Conducted disturbance	Farad	EZ-EMC	Ver. UL-3A1		
<b>Radiated Emissions</b>						
Instrument						
Used	Equipment	Manufacturer	Model No.	Serial No.	Last Cal.	Next Cal.
<input checked="" type="checkbox"/>	MXE EMI Receiver	KESIGHT	N9038A	MY56400036	Dec. 5, 2019	Dec. 5, 2020
<input checked="" type="checkbox"/>	Hybrid Log Periodic Antenna	TDK	HLP-3003C	130960	Sep.17,2018	Sep.17,2021
<input checked="" type="checkbox"/>	Preamplifier	HP	8447D	2944A09099	Dec. 5, 2019	Dec. 5, 2020
<input checked="" type="checkbox"/>	EMI Measurement Receiver	R&S	ESR26	101377	Dec. 5, 2019	Dec. 5, 2020
<input checked="" type="checkbox"/>	Loop antenna	Schwarzbeck	1519B	00008	Jan.07,2019	Jan.07, 2022
<input checked="" type="checkbox"/>	Preamplifier	TDK	PA-02-001- 3000	TRS-302- 00050	Dec. 5, 2019	Dec. 5, 2020
Software						
Used	Description	Manufacturer	Name	Version		
<input checked="" type="checkbox"/>	Test Software for Radiated disturbance	Farad	EZ-EMC	Ver. UL-3A1		
<b>Other instruments</b>						
Used	Equipment	Manufacturer	Model No.	Serial No.	Last Cal.	Next Cal.
<input checked="" type="checkbox"/>	Spectrum Analyzer	R&S	FSV40	101117	Dec. 6, 2019	Dec. 6, 2020
<input checked="" type="checkbox"/>	DC power supply	Keysight	E3642A	MY55159130	Dec. 6, 2019	Dec. 6, 2020
<input checked="" type="checkbox"/>	Temperature & Humidity Chamber	SANMOOD	SG-80-CC-2	2088	Dec. 6, 2019	Dec. 6, 2020

## 6. ANTENNA PORT TEST RESULTS

### 6.1. 99% & 20dB BANDWIDTH

#### LIMITS

FCC Part15 (15.247) Subpart C RSS-247 ISSUE 2		
Section	Test Item	Limit
ANSI C63.10 Section 6.9.2	20dB % Bandwidth	For reporting purposes only.
RSS-Gen Clause 6.7	99 % Bandwidth	For reporting purposes only.

#### TEST PROCEDURE

Connect the UUT to the spectrum analyser and use the following settings:

Center Frequency	The center frequency of the channel under test
Detector	Peak
RBW	For 20dB Occupied Bandwidth: 1% to 5% of the 20 dB bandwidth For 99% Occupied Bandwidth: 1% to 5% of the occupied bandwidth
VBW	For 20dB Occupied Bandwidth: approximately 3xRBW For 99% Occupied Bandwidth: $\geq 3 \times \text{RBW}$
Span	Between 2 times and 5 times the 20dB OBW. Between 1.5 times and 5.0 times the 99% OBW.
Trace	Max hold
Sweep	Auto couple

Allow the trace to stabilize and measure the maximum width of the emission that is constrained by the frequencies associated with the two outermost amplitude points (upper and lower frequencies) that are attenuated by 99%/20dB relative to the maximum level measured in the fundamental emission.

#### TEST SETUP

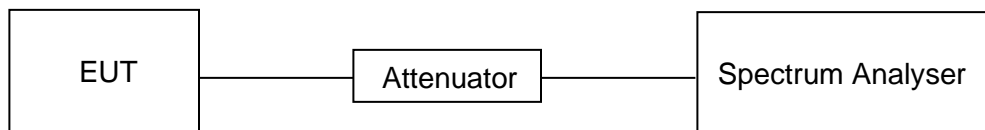



**TEST ENVIRONMENT**

Temperature	24.4 °C	Relative Humidity	64 %
Atmosphere Pressure	101 kPa	Test Voltage	DC 3.7 V

**RESULTS**

Frequency (MHz)	99 % bandwidth (kHz)	20 dB bandwidth (kHz)
13.56	1.243	1.454

**Occupied Bandwidth**

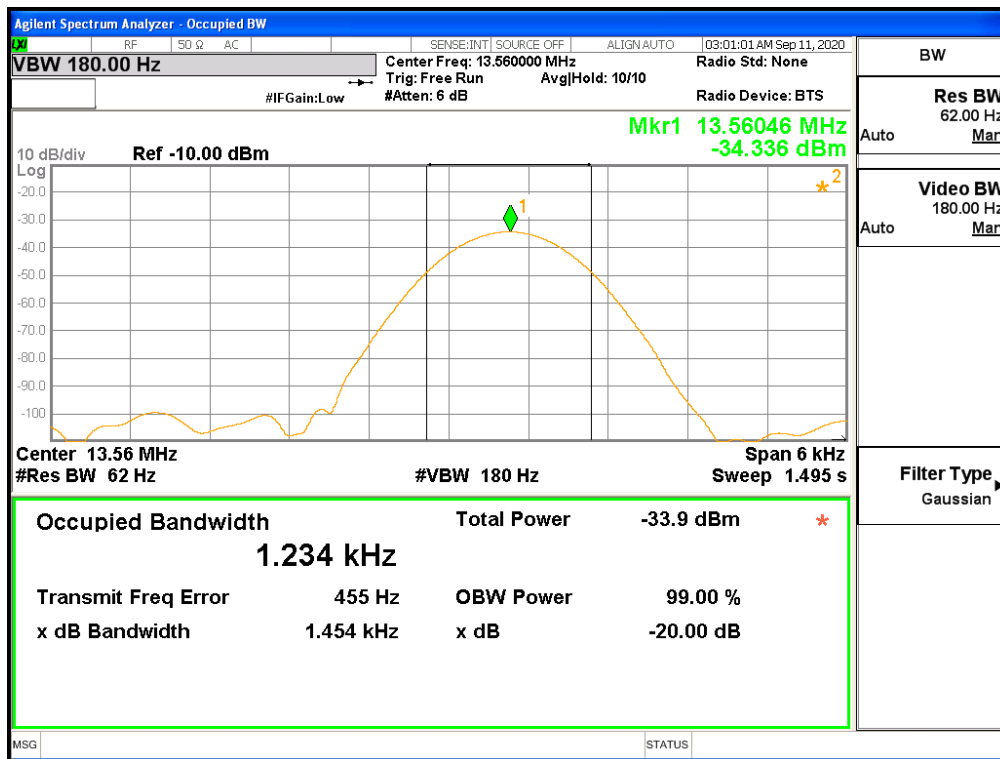

## 6.2. TRANSMITTER FREQUENCY STABILITY

### LIMITS

CFR 47 FCC §15.225(e)

ISED RSS-210 Annex B B.5

The frequency tolerance of the carrier signal shall be maintained within  $\pm 0.01\%$  of the operating frequency over a temperature variation of  $-20$  degrees to  $+ 50$  degrees C at normal supply voltage, and for a variation in the primary supply voltage from 85% to 115% of the rated supply voltage at a temperature of 20 degrees C.

### TEST SETUP AND PROCEDURE

Connect the UUT to the spectrum analyser and use the following settings:

Center Frequency	The center frequency of the channel under test
Detector	PEAK
RBW	10 kHz
VBW	$\geq 3 \times$ RBW
Span	Encompass the entire emissions bandwidth (EBW) of the signal
Trace	Max hold
Sweep time	Auto

Allow the trace to stabilize, find the peak value of the power envelope and record the frequency, then calculated the frequency drift.

### TEST SETUP

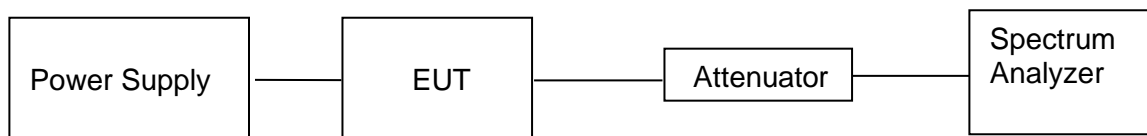



**TEST ENVIRONMENT**

Temperature	24.4°C	Relative Humidity	64%
Atmosphere Pressure	101kPa	Test Voltage	/

**TEST RESULTS**

Maximum frequency error of the EUT with variations in ambient temperature

Temperature (°C)	Time after			
	0 minutes	2 minutes	5 minutes	10 minutes
-20	13.5607	13.5604	13.5602	13.5601
-10	13.5604	13.5604	13.5611	13.5606
0	13.5608	13.5601	13.5606	13.5603
10	13.5604	13.5603	13.5602	13.5607
20	13.5604	13.5604	13.5609	13.5605
30	13.5609	13.5609	13.5602	13.5609
40	13.5603	13.5602	13.5607	13.5605
50	13.5607	13.5605	13.5600	13.5608

Maximum frequency error of the EUT with variations in nominal operating voltage at an ambient normal temperature

Supply Voltage (V)	Nominal Frequency (MHz)	Measured Frequency (MHz)	Frequency Error (Hz)	Frequency Error (%)	Limit (%)	Result
3.33	13.56	13.5605	500	0.004	0.01	Pass
3.7	13.56	13.5604	400	0.003	0.01	Pass
4.07	13.56	13.5604	400	0.003	0.01	Pass



## 7. RADIATED EMISSION TEST RESULTS

### LIMITS

Fundamental field strength

FCC Reference:	Part 15.225(a)(b)(c)(d) & 15.209(a)
ISED Canada Reference:	RSS-Gen 6.13 & RSS-210 B.6 & RSS-GEN Clause 8.9
Test Method Used:	ANSI C63.10 Sections 6.3, 6.4 and 6.5

Frequency (MHz)	Field Strength (uV/m)	Field Strength (dBuV/m)	Measured Distance (Meters)
13.553-13.567	15848	84	30
13.410-13.553/13.567-13.710	334	50.47	30
13.110-13.410/13.710-14.010	106	40.51	30

Note(s):

1. The field strength of any emissions appearing outside of the 13.110-14.010 MHz band shall not exceed the general radiated emission limits in §15.209.

2. The limit is specified at a test distance of 30 meters. However, as specified by FCC Section 15.31 (f)(2) / RSS-Gen Section 6.4, measurements may be performed at a closer distance and the measured level corrected to the specified measurement distance by using the square of an inverse linear distance extrapolation factor (40dB/decade).





## Radiation Disturbance Test Limit for FCC (Class B) (9 kHz-1 GHz)

Frequency (MHz)	Field Strength (microvolts/meter)	Measurement Distance (meters)
0.009~0.490	2400/F(kHz)	300
0.490~1.705	24000/F(kHz)	30
1.705~30.0	30	30
30~88	100	3
88~216	150	3
216~960	200	3
960~1000	500	3

Note: 1) At frequencies at or above 30 MHz, measurements may be performed at a distance other than what is specified provided: measurements are not made in the near field except where it can be shown that near field measurements are appropriate due to the characteristics of the device; and it can be demonstrated that the signal levels needed to be measured at the distance employed can be detected by the measurement equipment. Measurements shall not be performed at a distance greater than 30 meters unless it can be further demonstrated that measurements at a distance of 30 meters or less are impractical. When performing measurements at a distance other than that specified, the results shall be extrapolated to the specified distance using an extrapolation factor of 20 dB/decade (inverse linear-distance for field strength measurements; inverse-linear-distance-squared for power density measurements).

(2) At frequencies below 30 MHz, measurements may be performed at a distance closer than that specified in the regulations; however, an attempt should be made to avoid making measurements in the near field. Pending the development of an appropriate measurement procedure for measurements performed below 30 MHz, when performing measurements at a closer distance than specified, the results shall be extrapolated to the specified distance by either making measurements at a minimum of two distances on at least one radial to determine the proper extrapolation factor or by using the square of an inverse linear distance extrapolation factor (40 dB/decade). This paragraph (f) shall not apply to Access BPL devices operating below 30MHz.

## Restricted bands of operation

MHz	MHz	MHz	GHz
0.090-0.110	16.42-16.423	399.9-410	4.5-5.15
<sup>1</sup> 0.495-0.505	16.69475-16.69525	608-614	5.35-5.46
2.1735-2.1905	16.80425-16.80475	960-1240	7.25-7.75
4.125-4.128	25.5-25.67	1300-1427	8.025-8.5
4.17725-4.17775	37.5-38.25	1435-1626.5	9.0-9.2
4.20725-4.20775	73-74.6	1645.5-1646.5	9.3-9.5
6.215-6.218	74.8-75.2	1660-1710	10.6-12.7
6.26775-6.26825	108-121.94	1718.8-1722.2	13.25-13.4
6.31175-6.31225	123-138	2200-2300	14.47-14.5
8.291-8.294	149.9-150.05	2310-2390	15.35-16.2
8.362-8.366	156.52475-156.52525	2483.5-2500	17.7-21.4
8.37625-8.38675	156.7-156.9	2690-2900	22.01-23.12
8.41425-8.41475	162.0125-167.17	3260-3267	23.6-24.0
12.29-12.293	167.72-173.2	3332-3339	31.2-31.8
12.51975-12.52025	240-285	3345.8-3358	36.43-36.5
12.57675-12.57725	322-335.4	3600-4400	( <sup>2</sup> )
13.36-13.41			

Note: <sup>1</sup>Until February 1, 1999, this restricted band shall be 0.490-0.510 MHz.

<sup>2</sup>Above 38.6c



IC Restricted bands please refer to ISED RSS-GEN Clause 8.10

Table 7 – Restricted frequency bands <sup>Note 1</sup>		
MHz	MHz	GHz
0.090 - 0.110	149.9 - 150.05	9.0 - 9.2
0.495 - 0.505	156.52475 - 156.52525	9.3 - 9.5
2.1735 - 2.1905	156.7 - 156.9	10.6 - 12.7
3.020 - 3.026	162.0125 - 167.17	13.25 - 13.4
4.125 - 4.128	167.72 - 173.2	14.47 - 14.5
4.17725 - 4.17775	240 - 285	15.35 - 16.2
4.20725 - 4.20775	322 - 335.4	17.7 - 21.4
5.677 - 5.683	399.9 - 410	22.01 - 23.12
6.215 - 6.218	608 - 614	23.6 - 24.0
6.26775 - 6.26825	960 - 1427	31.2 - 31.8
6.31175 - 6.31225	1435 - 1626.5	36.43 - 36.5
8.291 - 8.294	1645.5 - 1646.5	Above 38.6
8.362 - 8.366	1660 - 1710	
8.37625 - 8.38675	1718.8 - 1722.2	
8.41425 - 8.41475	2200 - 2300	
12.29 - 12.293	2310 - 2390	
12.51975 - 12.52025	2483.5 - 2500	
12.57675 - 12.57725	2655 - 2900	
13.36 - 13.41	3260 - 3267	
16.42 - 16.423	3332 - 3339	
16.69475 - 16.69525	3345.8 - 3358	
16.80425 - 16.80475	3500 - 4400	
25.5 - 25.67	4500 - 5150	
37.5 - 38.25	5350 - 5460	
73 - 74.6	7250 - 7750	
74.8 - 75.2	8025 - 8500	
108 - 138		

**Note 1:** Certain frequency bands listed in table 7 and in bands above 38.6 GHz are designated for licence-exempt applications. These frequency bands and the requirements that apply to related devices are set out in the 200 and 300 series of RSSs.

**TEST SETUP AND PROCEDURE**

Below 30 MHz

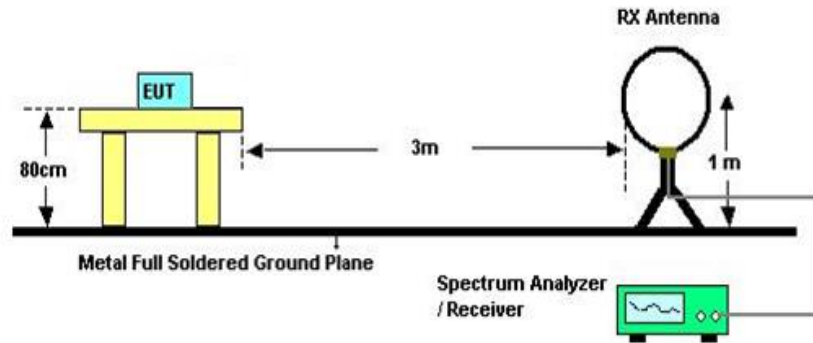

The setting of the spectrum analyser

RBW	200Hz (From 9 kHz to 0.15MHz)/ 9kHz (From 0.15 MHz to 30 MHz)
VBW	200Hz (From 9 kHz to 0.15MHz)/ 9kHz (From 0.15 MHz to 30 MHz)
Sweep	Auto
Detector	Peak/QP/ Average
Trace	Max hold

1. The testing follows the guidelines in ANSI C63.10-2013.
2. The EUT was arranged to its worst case and then turntable (from 0 degree to 360 degrees) to find the maximum reading. A pre-amp and a high pass filter are used for the test in order to get better signal level. Both Horizontal, Face-on and Face-off polarizations of the antenna are set to make the measurement.
3. The EUT was placed on a turntable with 80 cm meter above ground.
4. The EUT was set 3 meters from the interference receiving antenna, which was mounted on the top of a 1m height antenna tower.
5. Interconnecting cables that hang closer than 40 cm to the ground plane shall be folded back and forth in the center forming a bundle 30 to 40 cm long.
6. I/O cables that are not connected to a peripheral shall be bundled in the center. The end of the cable may be terminated, if required, using the correct terminating impedance. The overall length shall not exceed 1 m.
7. The radiated emission limits are based on measurements employing a CISPR quasi-peak detector except for the frequency bands 9-90 kHz, 110-490 kHz and above 1000MHz. Radiated emission limits in these three bands are based on measurements employing an average detector.
8. Although these tests were performed other than open area test site, adequate comparison measurements were confirmed against 30m open field site. Therefore, the sufficient tests were made to demonstrate that the alternative site produces results that correlate with the ones of tests made in an open field based on KDB 414788.

Below 1 GHz

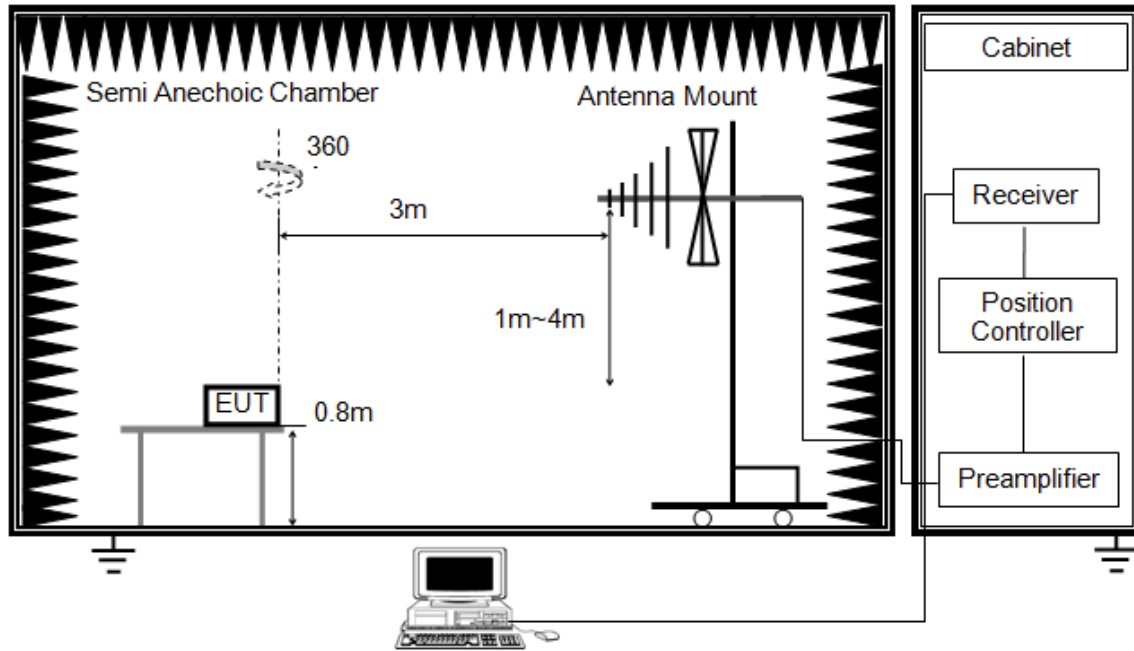

The setting of the spectrum analyser

RBW	120 kHz
VBW	300 kHz
Sweep	Auto
Detector	Peak/QP
Trace	Max hold

1. The testing follows the guidelines in ANSI C63.10-2013.
2. The EUT was arranged to its worst case and then tune the antenna tower (from 1 m to 4 m) and turntable (from 0 degree to 360 degrees) to find the maximum reading. A pre-amp and a high pass filter are used for the test in order to get better signal level. Both horizontal and vertical polarizations of the antenna are set to make the measurement.
3. The EUT was placed on a turntable with 80 cm above ground.
4. Interconnecting cables that hang closer than 40 cm to the ground plane shall be folded back and forth in the center forming a bundle 30 to 40 cm long.
5. I/O cables that are not connected to a peripheral shall be bundled in the center. The end of the cable may be terminated, if required, using the correct terminating impedance. The overall length shall not exceed 1 m.
6. The EUT was set 3 meters from the interference receiving antenna, which was mounted on the top of a variable height antenna tower.
7. The initial step in collecting conducted emission data is a spectrum analyzer peak detector mode pre-scanning the measurement frequency range. Significant peaks are then marked and then Quasi Peak detector mode re-measured.

Above 1 GHz

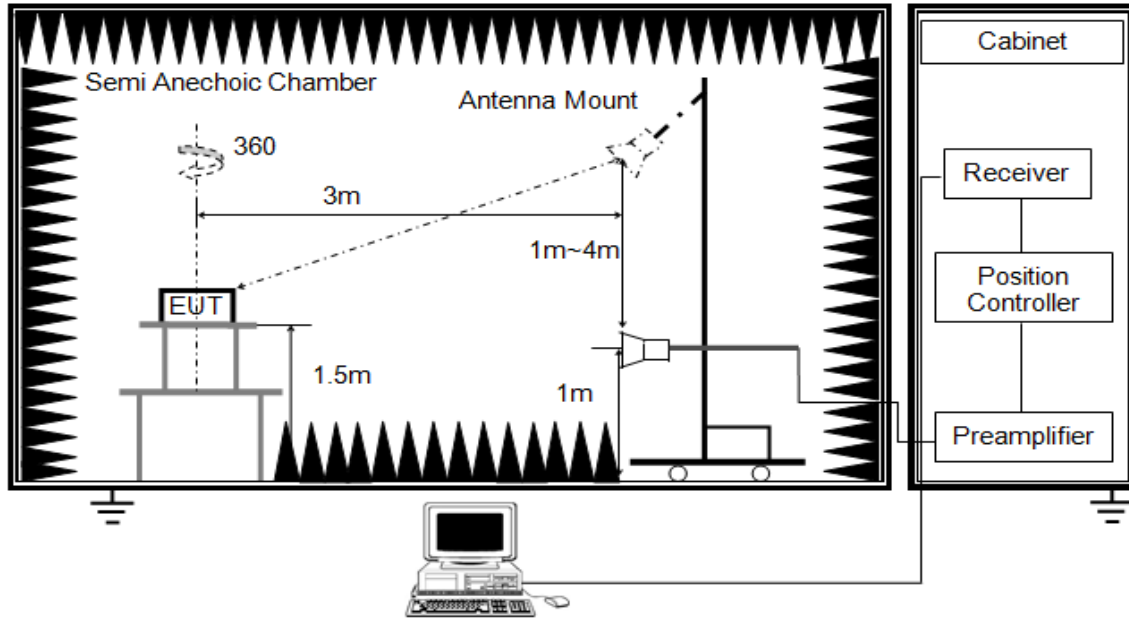

The setting of the spectrum analyser

RBW	1 MHz
VBW	PEAK: 3MHz AVG: see note 6
Sweep	Auto
Detector	Peak
Trace	Max hold

1. The testing follows the guidelines in ANSI C63.10-2013.
2. The EUT was arranged to its worst case and then tune the antenna tower (1.5 m) and turntable (from 0 degree to 360 degrees) to find the maximum reading. A pre-amp and a high pass filter or band reject filter are used for the test in order to get better signal level. Both horizontal and vertical polarizations of the antenna are set to make the measurement.
3. The EUT was placed on a turntable with 150 cm above ground.
4. Interconnecting cables that hang closer than 40 cm to the ground plane shall be folded back and forth in the center forming a bundle 30 to 40 cm long.
5. I/O cables that are not connected to a peripheral shall be bundled in the center. The end of the cable may be terminated, if required, using the correct terminating impedance. The overall length shall not exceed 1 m.
4. The EUT was set 3 meters from the interference receiving antenna, which was mounted on the top of a variable height antenna tower.
6. For measurements above 1 GHz the resolution bandwidth is set to 1 MHz, then the video bandwidth is set to 3 MHz for peak measurements. Where necessary, average emission are determined by applying the Duty Cycle Correction Factor to the peak measurements. For the Duty Cycle and Correction Factor please refer to clause 6.1. ON TIME AND DUTY CYCLE.

X axis, Y axis, Z axis positions:

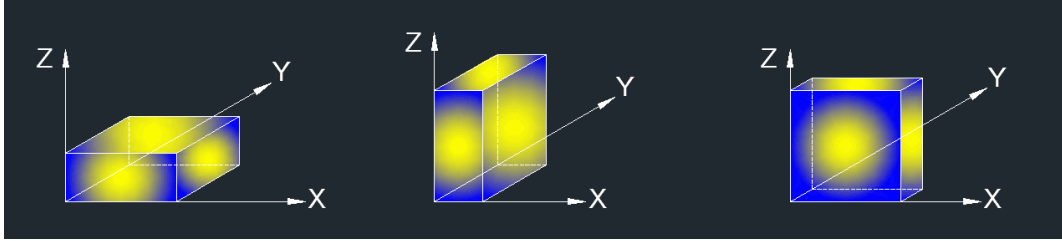

Note: For all radiated test, EUT in each of three orthogonal axis emissions had been tested, but only the worst case (X axis) data recorded in the report.

### **TEST ENVIRONMENT**

Temperature	20.0 °C	Relative Humidity	51 %
Atmosphere Pressure	101 kPa	Test Voltage	DC 3.7 V

### **RESULTS**

## 7.1. FIELD STRENGTH OF INTENTIONAL EMISSIONS

### FIELD STRENGTH OF INTENTIONAL EMISSIONS (LOOP ANTENNA FACE ON TO THE EUT)

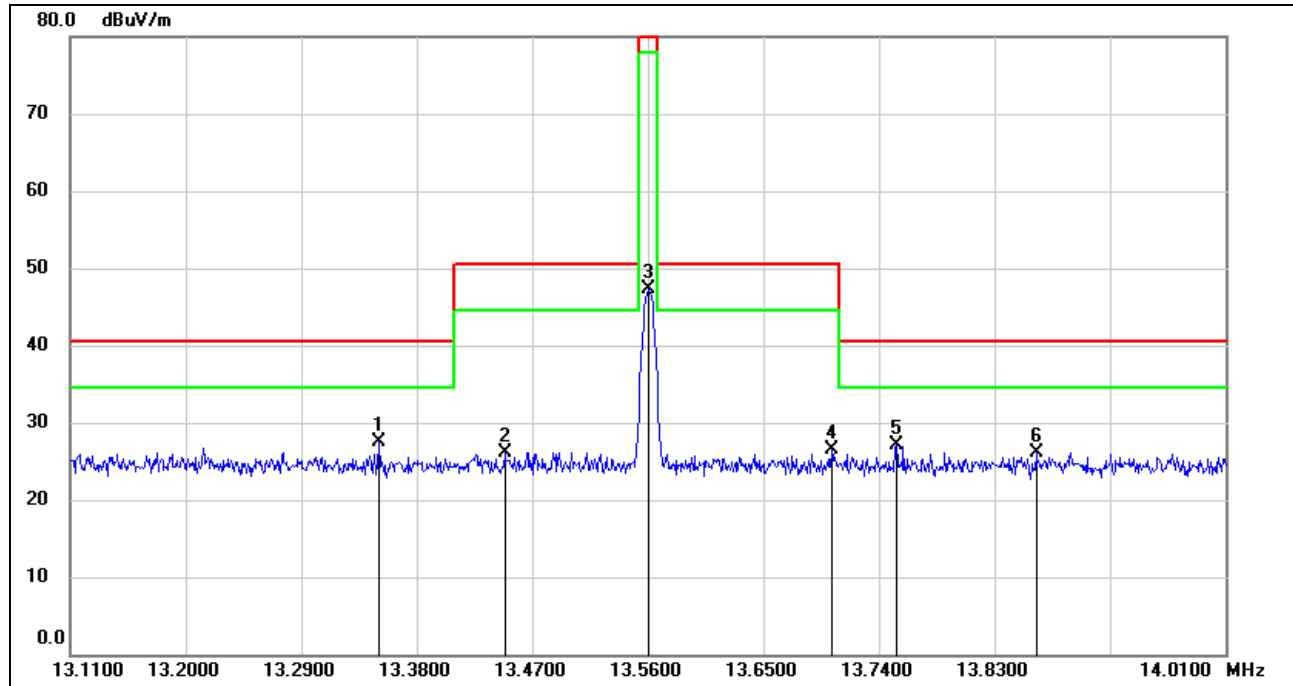

No.	Frequency (MHz)	Reading (dBuV)	Correct (dB/m)	Result (dBuV/m)	Limit (dBuV/m)	Margin (dB)	Remark
1	13.3503	49.37	-21.90	27.47	40.51	-13.04	peak
2	13.4484	48.07	-21.90	26.17	50.47	-24.30	peak
3	13.5600	69.14	-21.91	47.23	84.00	-36.77	peak
4	13.7031	48.42	-21.91	26.51	50.47	-23.96	peak
5	13.7535	49.04	-21.93	27.11	40.51	-13.40	peak
6	13.8624	47.97	-21.93	26.04	40.51	-14.47	peak

Note: 1. Result Level = Read Level + Correct Factor.

2. 3m Limit= 30m Limit + 40

3. All 3 polarizations (Horizontal, Face-on and Face-off) of the loop antenna had been tested, but only the worst data recorded in the report.

## 7.2. SPURIOUS EMISSIONS BELOW 1GHz AND ABOVE 30MHz

### SPURIOUS EMISSIONS (HORIZONTAL)

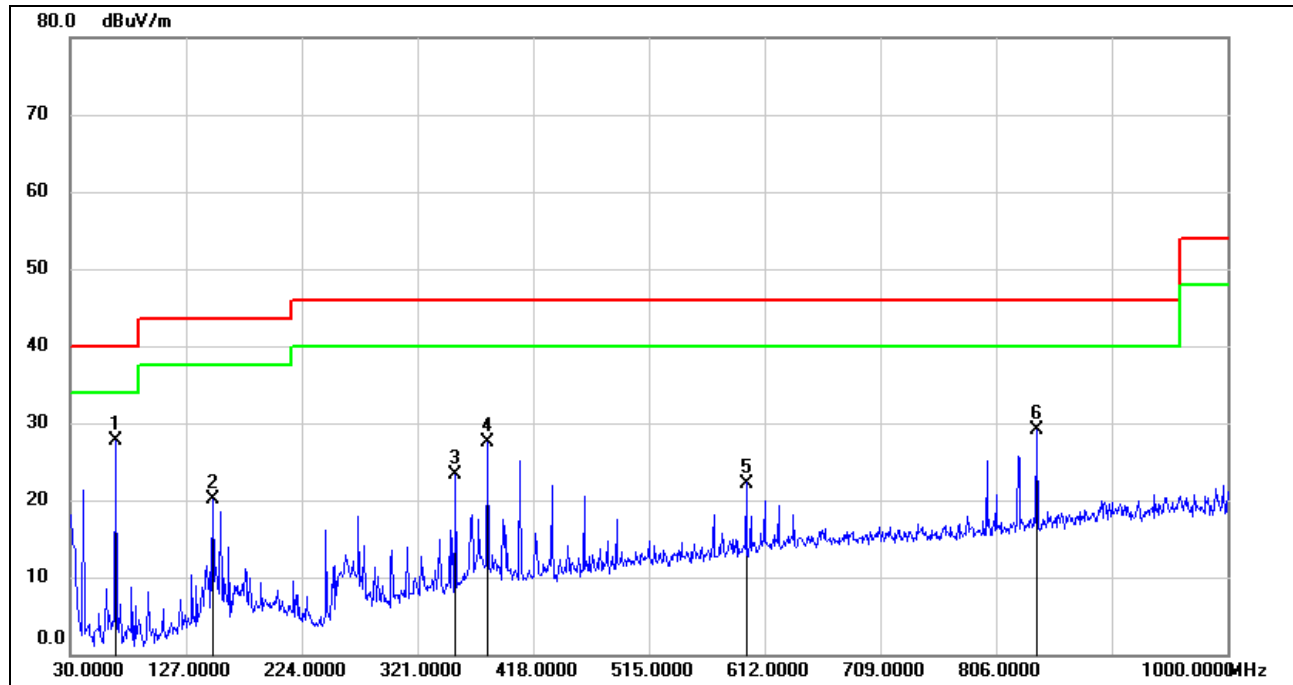

No.	Frequency (MHz)	Reading (dBuV)	Correct (dB/m)	Result (dBuV/m)	Limit (dBuV/m)	Margin (dB)	Remark
1	67.8300	48.38	-20.61	27.77	40.00	-12.23	QP
2	149.3100	38.58	-18.53	20.05	43.50	-23.45	QP
3	353.0100	37.85	-14.50	23.35	46.00	-22.65	QP
4	380.1700	41.36	-13.89	27.47	46.00	-18.53	QP
5	596.4800	32.18	-9.98	22.20	46.00	-23.80	QP
6	839.9500	36.09	-6.94	29.15	46.00	-16.85	QP

Note: 1. Result Level = Read Level + Correct Factor.





**HARMONICS AND SPURIOUS EMISSIONS (VERTICAL)**

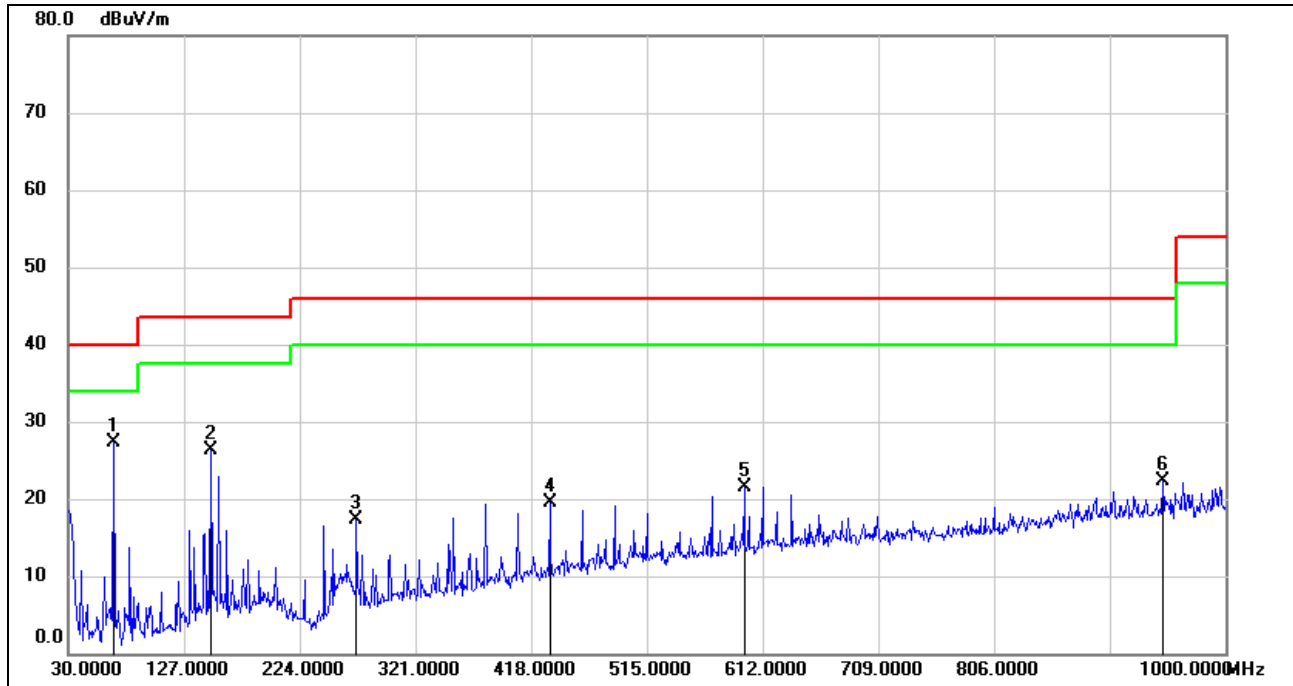

No.	Frequency (MHz)	Reading (dBuV)	Correct (dB/m)	Result (dBuV/m)	Limit (dBuV/m)	Margin (dB)	Remark
1	67.8300	47.83	-20.61	27.22	40.00	-12.78	QP
2	149.3100	44.82	-18.53	26.29	43.50	-17.21	QP
3	271.5300	35.19	-17.89	17.30	46.00	-28.70	QP
4	433.5200	32.23	-12.76	19.47	46.00	-26.53	QP
5	596.4800	31.52	-9.98	21.54	46.00	-24.46	QP
6	947.6200	27.41	-5.11	22.30	46.00	-23.70	QP

Note: 1. Result Level = Read Level + Correct Factor.

### 7.3. SPURIOUS EMISSIONS BELOW 30MHz

#### SPURIOUS EMISSIONS (LOOP ANTENNA FACE ON TO THE EUT)

0.09 kHz~ 150 kHz

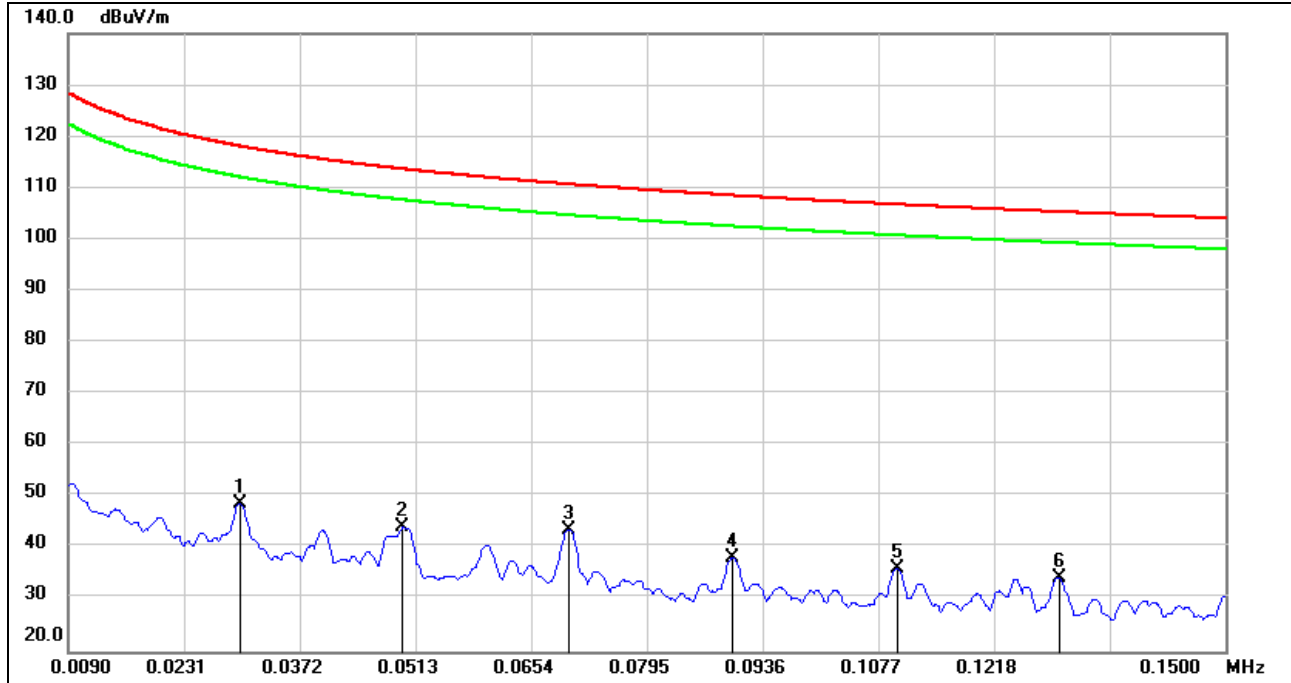

No.	Frequency (MHz)	Reading (dBuV)	Correct (dB/m)	Result (dBuV/m)	Limit (dBuV/m)	Margin (dB)	Remark
1	0.0299	69.70	-21.11	48.59	118.09	-69.50	peak
2	0.0497	65.40	-21.38	44.02	113.67	-69.65	peak
3	0.0699	64.67	-20.98	43.69	110.71	-67.02	peak
4	0.0899	59.18	-21.12	38.06	108.53	-70.47	peak
5	0.1100	57.36	-21.41	35.95	106.78	-70.83	peak
6	0.1296	56.00	-21.65	34.35	105.36	-71.01	peak

Note: 1. Measurement = Reading Level + Correct Factor.

2. If Peak Result complies with AV and QP limit, AV and QP Result are deemed to comply with AV limit.

3. All 3 polarizations (Horizontal, Face-on and Face-off) of the loop antenna had been tested, but only the worst data recorded in the report.



150 kHz ~ 490 kHz

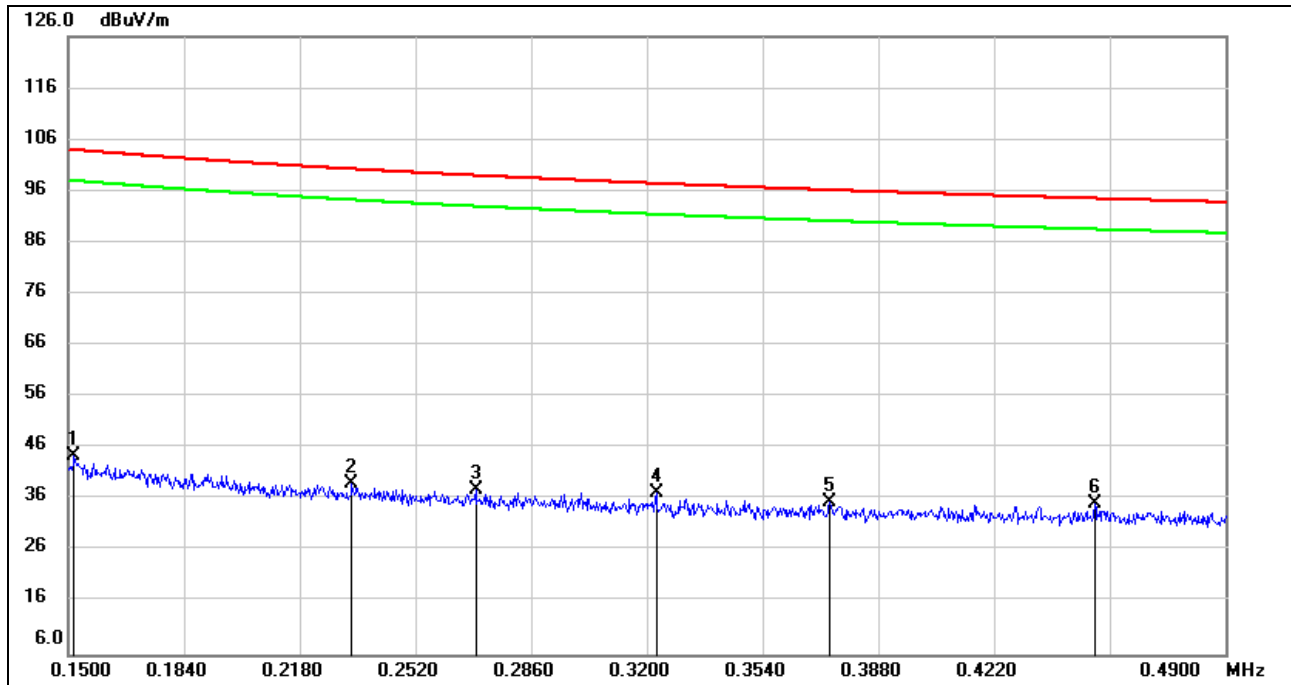

No.	Frequency (MHz)	Reading (dBuV)	Correct (dB/m)	Result (dBuV/m)	Limit (dBuV/m)	Margin (dB)	Remark
1	0.1517	66.32	-21.89	44.43	103.98	-59.55	peak
2	0.2333	60.87	-21.81	39.06	100.24	-61.18	peak
3	0.2697	59.70	-21.78	37.92	98.98	-61.06	peak
4	0.3227	59.23	-21.77	37.46	97.43	-59.97	peak
5	0.3737	57.20	-21.75	35.45	96.15	-60.70	peak
6	0.4516	56.86	-21.72	35.14	94.51	-59.37	peak

- Note: 1. Measurement = Reading Level + Correct Factor.  
 2. If Peak Result complies with AV and QP limit, AV and QP Result are deemed to comply with AV limit.  
 3. All 3 polarizations (Horizontal, Face-on and Face-off) of the loop antenna had been tested, but only the worst data recorded in the report.

**490 kHz ~ 30 MHz**

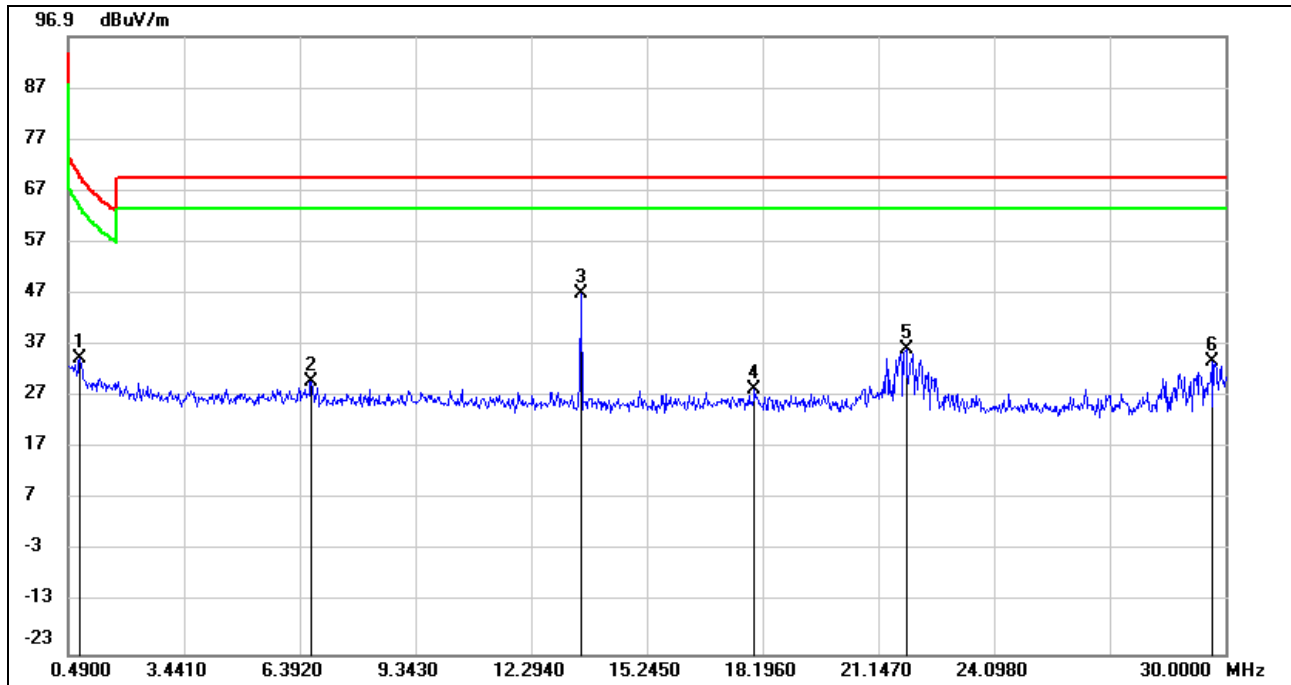

No.	Frequency (MHz)	Reading (dBuV)	Correct (dB/m)	Result (dBuV/m)	Limit (dBuV/m)	Margin (dB)	Remark
1	0.7851	56.58	-22.18	34.40	69.70	-35.30	peak
2	6.6871	51.90	-22.05	29.85	69.54	-39.69	peak
3	13.5629	68.79	-21.91	46.88	/	/	Fundamental
4	17.9894	50.10	-21.87	28.23	69.54	-41.31	peak
5	21.8552	57.83	-21.74	36.09	69.54	-33.45	peak
6	29.6459	55.23	-21.46	33.77	69.54	-35.77	peak

- Note: 1. Measurement = Reading Level + Correct Factor.  
 2. If Peak Result complies with AV and QP limit, AV and QP Result are deemed to comply with AV limit.  
 3. All 3 polarizations (Horizontal, Face-on and Face-off) of the loop antenna had been tested, but only the worst data recorded in the report.  
 4. About the Fundamental emission test result please refer to section 7.1.



## 8. AC POWER LINE CONDUCTED EMISSIONS

### LIMITS

Please refer to CFR 47 FCC §15.207 (a) and ISED RSS-Gen Clause 8.8

FREQUENCY (MHz)	Quasi-peak	Average
0.15 -0.5	66 - 56 *	56 - 46 *
0.50 -5.0	56.00	46.00
5.0 -30.0	60.00	50.00

Note:

- (1) The tighter limit applies at the band edges.
- (2) The limit of " \* " marked band means the limitation decreases linearly with the logarithm of the frequency in the range.

**TEST SETUP AND PROCEDURE**

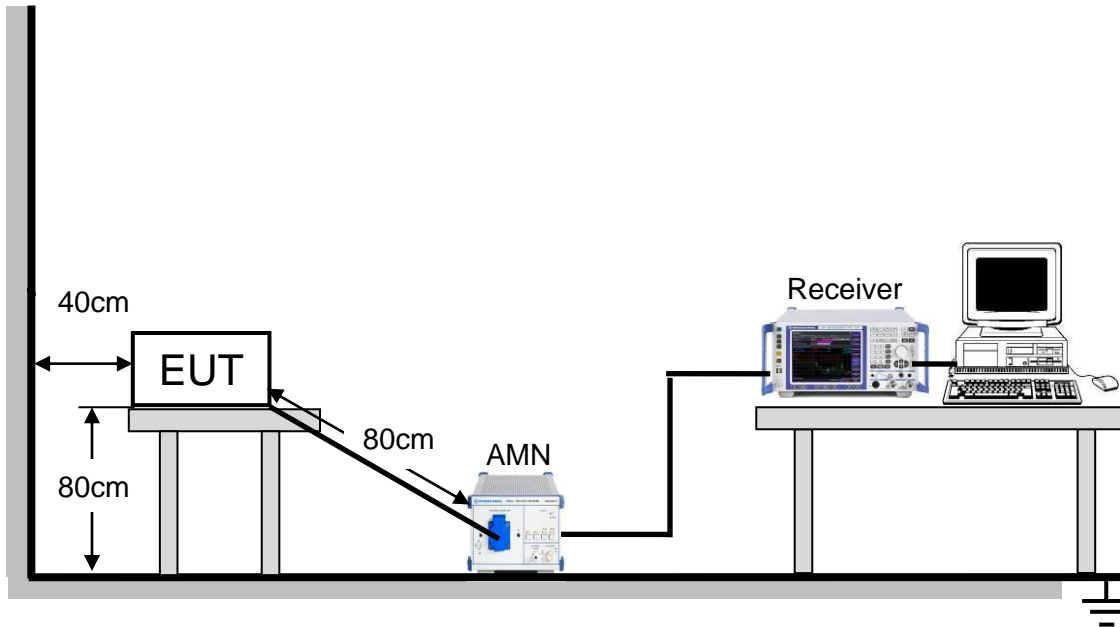

The following table is the setting of the receiver

Receiver Parameters	Setting
Attenuation	10 dB
Start Frequency	0.15 MHz
Stop Frequency	30 MHz
IF Bandwidth	9 kHz

1. The testing follows the guidelines in ANSI C63.10-2013.
2. The EUT was placed on the top of a rotating table 0.8 meters above the horizontal ground plane and being connected to the power mains through a line impedance stabilization network (LISN). All other support equipment powered from additional LISN(s). The LISN provide 50 ohm/ 50uH of coupling impedance for the measuring instrument.
3. Interconnecting cables that hang closer than 40 cm to the ground plane shall be folded back and forth in the center forming a bundle 30 to 40 cm long.
4. I/O cables that are not connected to a peripheral shall be bundled in the center. The end of the cable may be terminated, if required, using the correct terminating impedance. The overall length shall not exceed 1 m.
5. LISN at least 80 cm from nearest part of EUT chassis.
6. Conducted emissions from the EUT measured in the frequency range between 0.15 MHz and 30MHz using CISPR Quasi-Peak and average detector mode.
7. The arrangement of the equipment is installed to meet the standards and operating in a manner, which tends to maximize its emission characteristics in a normal application.



**TEST ENVIRONMENT**

Temperature	24.0°C	Relative Humidity	64%
Atmosphere Pressure	101kPa	Test Voltage	AC 120V,60Hz

**LINE N RESULTS with unmodified sample (antenna present)**

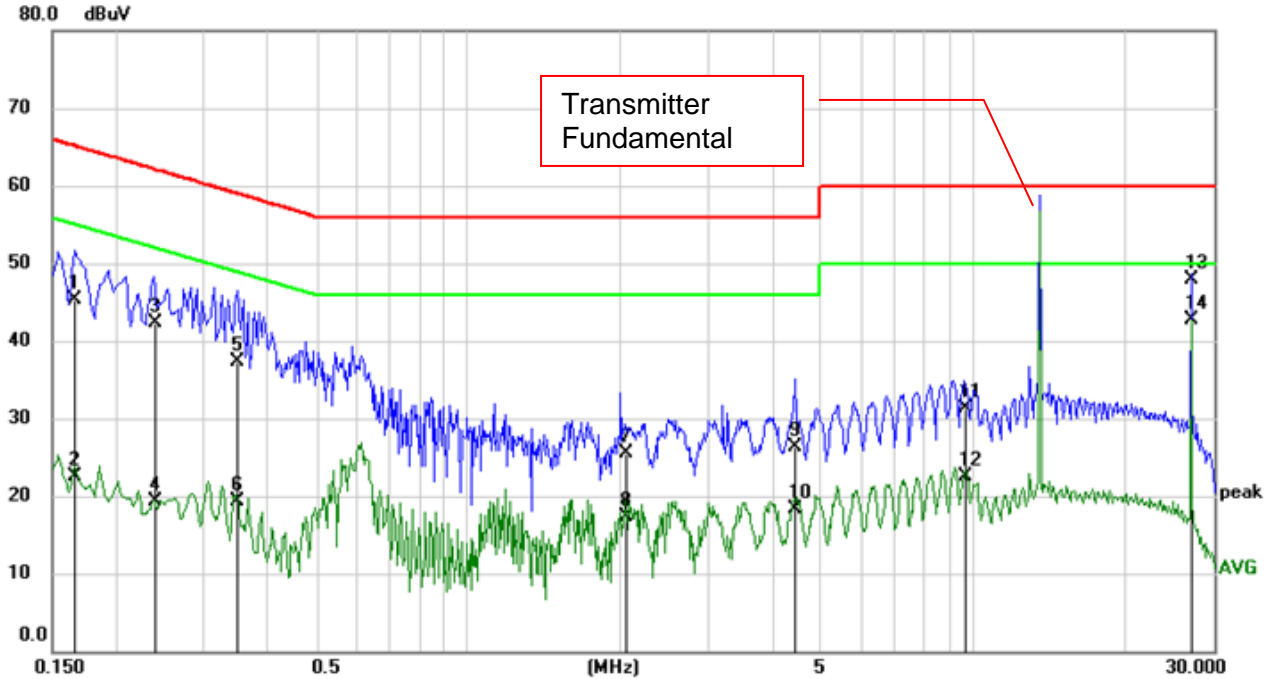

No.	Frequency (MHz)	Reading (dBuV)	Correct (dB)	Result (dBuV)	Limit (dBuV)	Margin (dB)	Remark
1	0.1655	35.80	9.60	45.40	65.18	-19.78	QP
2	0.1655	12.84	9.60	22.44	55.18	-32.74	AVG
3	0.2415	32.68	9.60	42.28	62.04	-19.76	QP
4	0.2415	9.68	9.60	19.28	52.04	-32.76	AVG
5	0.3484	27.63	9.60	37.23	59.00	-21.77	QP
6	0.3484	9.67	9.60	19.27	49.00	-29.73	AVG
7	2.0698	15.87	9.63	25.50	56.00	-30.50	QP
8	2.0698	7.75	9.63	17.38	46.00	-28.62	AVG
9	4.4537	16.59	9.66	26.25	56.00	-29.75	QP
10	4.4537	8.64	9.66	18.30	46.00	-27.70	AVG
11	9.6739	21.48	9.76	31.24	60.00	-28.76	QP
12	9.6739	12.65	9.76	22.41	50.00	-27.59	AVG
13	27.1209	37.87	9.99	47.86	60.00	-12.14	QP
14	27.1209	32.65	9.99	42.64	50.00	-7.36	AVG

Note: 1. Result = Reading +Correct Factor.  
2. If QP Result complies with AV limit, AV Result is deemed to comply with AV limit.

**LINE L RESULTS with unmodified sample (antenna present)**

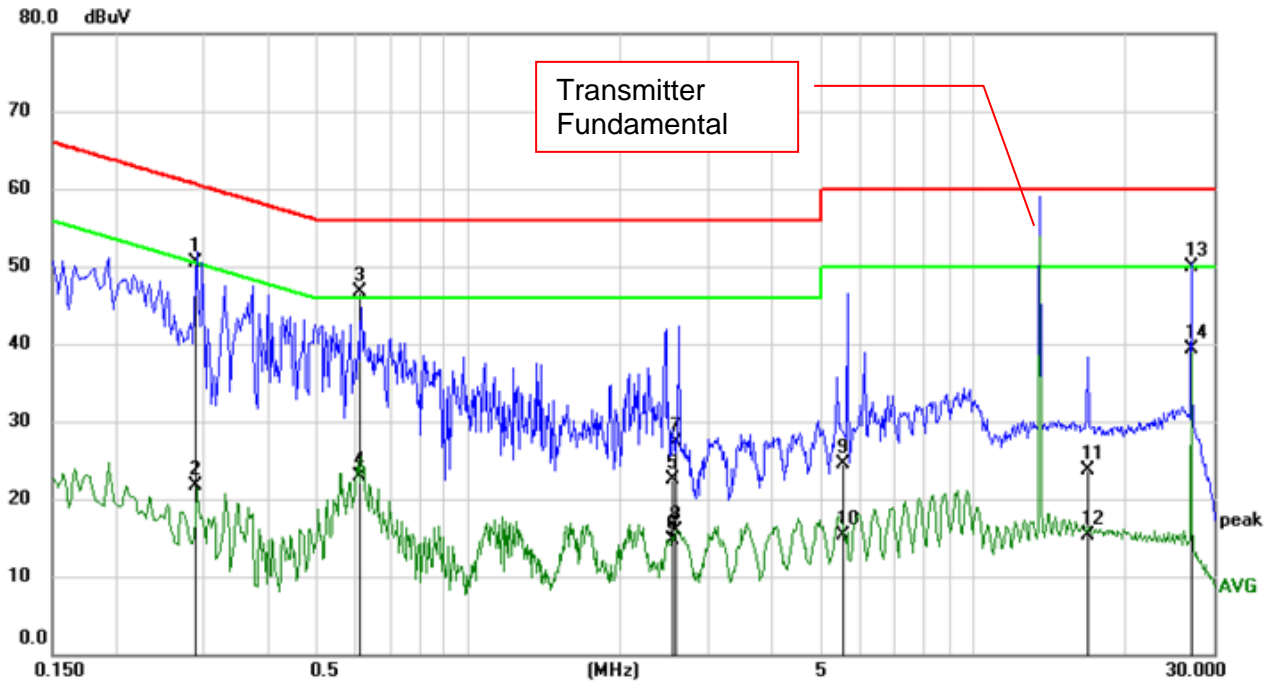

No.	Frequency (MHz)	Reading (dBuV)	Correct (dB)	Result (dBuV)	Limit (dBuV)	Margin (dB)	Remark
1	0.2872	40.81	9.60	50.41	60.60	-10.19	QP
2	0.2872	12.17	9.60	21.77	50.60	-28.83	AVG
3	0.6104	37.09	9.60	46.69	56.00	-9.31	QP
4	0.6104	13.36	9.60	22.96	46.00	-23.04	AVG
5	2.5495	12.96	9.64	22.60	56.00	-33.40	QP
6	2.5495	5.06	9.64	14.70	46.00	-31.30	AVG
7	2.6043	17.69	9.64	27.33	56.00	-28.67	QP
8	2.6043	6.22	9.64	15.86	46.00	-30.14	AVG
9	5.5675	14.82	9.69	24.51	60.00	-35.49	QP
10	5.5675	5.53	9.69	15.22	50.00	-34.78	AVG
11	16.9244	13.73	10.02	23.75	60.00	-36.25	QP
12	16.9244	5.23	10.02	15.25	50.00	-34.75	AVG
13	27.1209	39.85	9.99	49.84	60.00	-10.16	QP
14	27.1209	29.40	9.99	39.39	50.00	-10.61	AVG

Note: 1. Result = Reading +Correct Factor.

2. If QP Result complies with AV limit, AV Result is deemed to comply with AV limit.



**LINE N RESULTS with modified sample (transmitter terminated into a dummy load)**

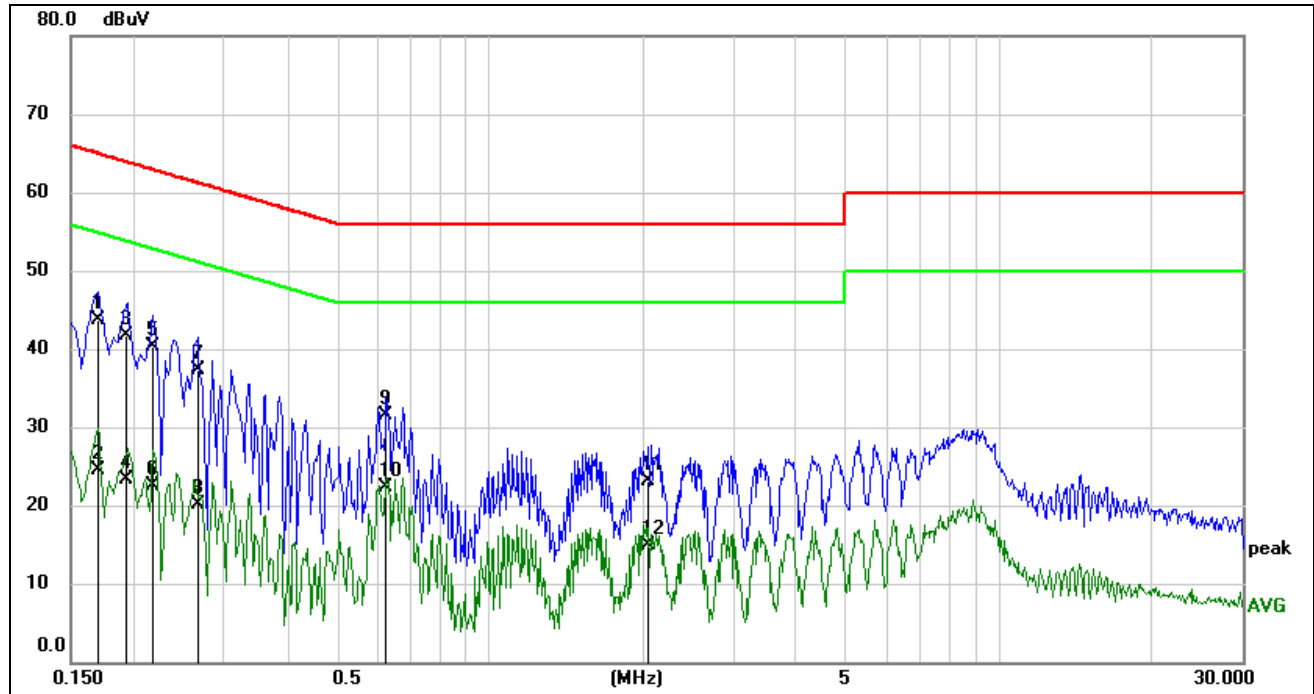

No.	Frequency (MHz)	Reading (dBuV)	Correct (dB)	Result (dBuV)	Limit (dBuV)	Margin (dB)	Remark
1	0.1689	34.18	9.60	43.78	65.01	-21.23	QP
2	0.1689	14.82	9.60	24.42	55.01	-30.59	AVG
3	0.1916	32.09	9.60	41.69	63.97	-22.28	QP
4	0.1916	13.78	9.60	23.38	53.97	-30.59	AVG
5	0.2163	30.65	9.60	40.25	62.96	-22.71	QP
6	0.2163	12.95	9.60	22.55	52.96	-30.41	AVG
7	0.2649	27.74	9.60	37.34	61.28	-23.94	QP
8	0.2649	10.59	9.60	20.19	51.28	-31.09	AVG
9	0.6274	21.88	9.60	31.48	56.00	-24.52	QP
10	0.6274	12.73	9.60	22.33	46.00	-23.67	AVG
11	2.0484	13.56	9.63	23.19	56.00	-32.81	QP
12	2.0484	5.30	9.63	14.93	46.00	-31.07	AVG

Note: 1. Result = Reading +Correct Factor.  
2. If QP Result complies with AV limit, AV Result is deemed to comply with AV limit.

**LINE L RESULTS with modified sample (transmitter terminated into a dummy load)**

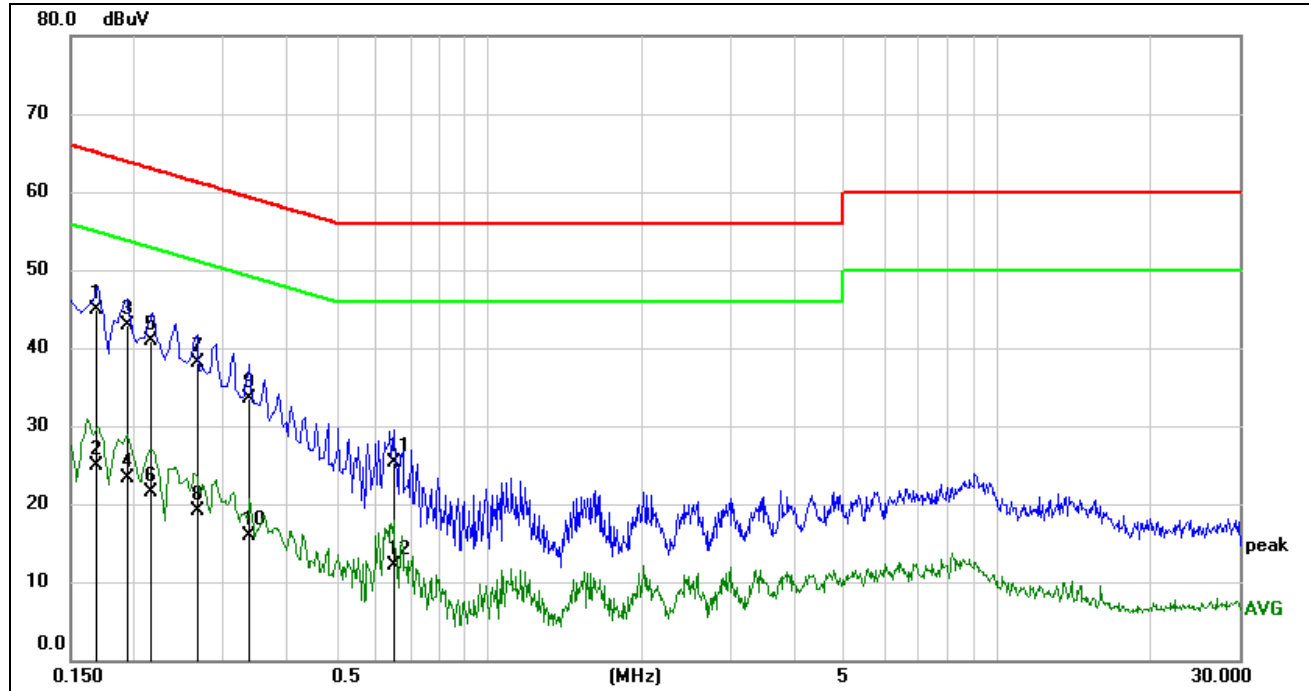

No.	Frequency (MHz)	Reading (dBuV)	Correct (dB)	Result (dBuV)	Limit (dBuV)	Margin (dB)	Remark
1	0.1679	35.24	9.61	44.85	65.06	-20.21	QP
2	0.1679	15.37	9.61	24.98	55.06	-30.08	AVG
3	0.1939	33.27	9.60	42.87	63.87	-21.00	QP
4	0.1939	13.78	9.60	23.38	53.87	-30.49	AVG
5	0.2153	31.33	9.60	40.93	63.00	-22.07	QP
6	0.2153	11.96	9.60	21.56	53.00	-31.44	AVG
7	0.2648	28.47	9.60	38.07	61.28	-23.21	QP
8	0.2648	9.56	9.60	19.16	51.28	-32.12	AVG
9	0.3372	24.00	9.60	33.60	59.27	-25.67	QP
10	0.3372	6.32	9.60	15.92	49.27	-33.35	AVG
11	0.6489	15.66	9.60	25.26	56.00	-30.74	QP
12	0.6489	2.60	9.60	12.20	46.00	-33.80	AVG

Note: 1. Result = Reading +Correct Factor.  
2. If QP Result complies with AV limit, AV Result is deemed to comply with AV limit.



## 9. ANTENNA REQUIREMENTS

### APPLICABLE REQUIREMENTS

Please refer to FCC §15.203

An intentional radiator shall be designed to ensure that no antenna other than that furnished by the responsible party shall be used with the device. The use of a permanently attached antenna or of an antenna that uses a unique coupling to the intentional radiator shall be considered sufficient to comply with the provisions of this section. The manufacturer may design the unit so that a broken antenna can be replaced by the user, but the use of a standard antenna jack or electrical connector is prohibited.

Please refer to FCC §15.247(b)(4)

The conducted output power limit specified in paragraph (b) of this section is based on the use of antennas with directional gains that do not exceed 6 dBi. Except as shown in paragraph (c) of this section, if transmitting antennas of directional gain greater than 6 dBi are used, the conducted output power from the intentional radiator shall be reduced below the stated values in paragraphs (b)(1), (b)(2), and (b)(3) of this section, as appropriate, by the amount in dB that the directional gain of the antenna exceeds 6 dBi.

### RESULTS

Complies

---

**END OF REPORT**